

**ENCYCLOPÆDIA BRITANNICA.**

**VOLUME the SECOND.**



# Encyclopædia Britannica;

OR, A

## DICTIONARY

OF

ARTS and SCIENCES,

COMPILED UPON A NEW PLAN.

IN WHICH

The different SCIENCES and ARTS are digested into  
distinct Treatises or Systems;

AND

The various TECHNICAL TERMS, &c. are explained as they occur  
in the order of the Alphabet.

---

ILLUSTRATED WITH ONE HUNDRED AND SIXTY COPPERPLATES.

---

*By a SOCIETY of GENTLEMEN in SCOTLAND.*

---

IN THREE VOLUMES.

---

VOL. II.

---

---

EDINBURGH:

Printed for A. BELL and C. MACFARQUHAR;

And sold by COLIN MACFARQUHAR, at his Printing-office, Nicolson-street.

M. DCC. LXXI.





# Encyclopædia Britannica;

O R, A N E W

## D I C T I O N A R Y

O F

### A R T S and S C I E N C E S.

C A B

**C**AABA, or CAABA, properly signifies a square building; but is particularly applied by the Mahometans to the temple of Mecca, built, as they pretend, by Abraham and Ismaël his son. It is towards this temple they always turn their faces when they pray, in whatever part of the world they happen to be.

This temple enjoys the privilege of an asylum for all sorts of criminals; but it is most remarkable for the pilgrimages made to it by the devout musſulmans, who pay so great a veneration to it, that they believe a single sight of its sacred walls, without any particular act of devotion, is as meritorious, in the sight of God, as the most careful discharge of one's duty, for the space of a whole year, in any other temple.

**CAB**, an Hebrew dry measure, being the sixth part of a seah or satum, and the eighteenth part of an ephah: A cab contained  $2\frac{1}{2}$  pints of our corn measure: A quarter-cab was the measure of dove's dung, or more properly a sort of chick-pease, called by this name, which was sold at Samaria, during the siege of that city, for five shekels.

**CABALIST**, in French commerce, a factor, or person, who is concerned in managing the trade of another.

**CABALLARIA**, in middle-age writers, lands held by the tenure of furnishing a horseman, with suitable equipage, in time of war, or when the lord had occasion for him.

**CABALLEROS**, or CAVALEROS, are Spanish wools, of which there is a pretty considerable trade at Bayonne, in France.

**CABALLINE** denotes something belonging to horses: Thus caballine aloes is so called, from its being chiefly

Vol. II. No. 30.

3

C A B

used for purging horses; and common brimstone is called sulphur caballinum, for a like reason.

**CABBAGE**, in botany. See BRASSICA.

**CABBAGE-tree**, a name sometimes given to the palm-tree, called by Linnæus, phœnix. See PHOENIX.

**CABBAGING**, among gardeners, a term used for the knitting of cabbages into round heads.

**CABBALA**, according to the Hebrew style, has a very distinct signification from that wherein we understand it in our language. The Hebrew cabbala signifies tradition; and the rabbins, who are called cabbalists, study principally the combination of particular words, letters, and numbers, and by this means pretend to discover what is to come, and to see clearly into the sense of many difficult passages in scripture: There are no sure principles of this knowledge, but it depends upon some particular traditions of the ancients; for which reason it is termed cabbala.

The cabbalists have abundance of names, which they call sacred: These they make use of in invoking of spirits, and imagine that they receive great light from them: They tell us, that the secrets of the cabbala were discovered to Moses on mount Sinai; and that these have been delivered down to them from father to son, without interruption, and without any use of letters; for to write them down, is what they are by no means permitted to do. This is likewise termed the oral law, because it passed from father to son, in order to distinguish it from the written laws.

There is another cabbala, called artificial, which consists in searching for abstruse and mysterious significations of a word in scripture, from whence they borrow certain explanations, by combining the letters

†

A

which

which compose it: this cabbala is divided into three kinds, the gematrick, the notaricon, and the temura or themurah. The first whereof consists in taking the letters of a Hebrew word for ciphers or arithmetical numbers, and explaining every word by the arithmetical value of the letters whereof it is composed. The second sort of cabbala, called notaricon, consists in taking every particular letter of a word for an entire diction; and the third, called themurah, *i. e.* change, consists in making different transpositions or changes of letters, placing one for the other, or one before the other.

Among the Christians likewise, a certain sort of magic is, by mistake, called cabbala, which consists in using improperly certain passages of scripture for magic operations, or in forming magic characters or figures with stars and talismans.

Some visionaries, among the Jews, believe, that Jesus Christ wrought his miracles by virtue of the mysteries of the cabbala.

**CABBALISTS**, the Jewish doctors who profess the study of the cabbala.

In the opinion of these men, there is not a word, letter, or accent in the law, without some mystery in it. The Jews are divided into two general sects; the karaites, who refuse to receive either tradition or the talmud, or any thing but the pure text of scripture; and the rabbinites, or talmudists; who, besides this, receive the traditions of the ancients, and follow the talmud.

The latter are again divided into two other sects; pure rabbinites, who explain the scripture, in its natural sense, by grammar, history, and tradition; and cabbalists, who, to discover hidden mystical senses, which they suppose God to have couched therein, make use of the cabbala, and the mystical methods above mentioned.

**CABECA**, or **CABESSE**, a name given to the finest silks in the East Indies, as those from 15 to 20 *per cent.* inferior to them are called barina. The Indian workmen endeavour to pass them off one with the other; for which reason, the more experienced European merchants take care to open the bales, and to examine all the skins one after another. The Dutch distinguish two sorts of cabecas; namely, the moor cabeca, and the common cabeca. The former is sold at Amsterdam for about 21  $\frac{1}{2}$  schellinghen Flemish, and the other for about 18  $\frac{1}{4}$ .

**CABENDA**, a port-town of Congo, in Africa, and subject to the Portuguese: E. long. 12°, and S. lat. 4°.

**CABIDOS**, or **CAVIDOS**, a long measure used at Goa, and in other places of the East Indies belonging to the Portuguese, to measure stuffs, linens, &c. and equal to  $\frac{1}{4}$  of the Paris ell.

**CABIN**, in the sea-language, a small room, or apartment, whereof there are a great many in several parts of a ship; particularly on the quarter-deck, and on each side of the steerage, for the officers of the ship to lie in.

The great cabin is the chief of all, and that which properly belongs to the captain or chief commander.

**CABINET**, or **CABBINET**, the most retired place in the finest part of a building, set apart for writing, studying, or preserving any thing that is precious.

A complete apartment consists of a hall, anti-chamber, chamber, and cabinet, with a gallery on one side. Hence we say, a cabinet of paintings, curiosities, &c. **CABINET** also denotes a piece of joiner's workmanship, being a kind of press or chest, with several doors and drawers.

There are common cabinets of oak or of chestnut, varnished cabinets of China and Japan, cabinets of inlaid work, and some of ebony, or the like scarce and precious woods.

Formerly the Dutch and German cabinets were much esteemed in France, but are now quite out of date, as well as the cabinets of ebony, which came from Venice.

**CABIRI**, a term in the theology of the ancient Pagans, signifying great and powerful gods; being a name given to the gods of Samothracia. They were also worshipped in other parts of Greece, as Lemnos and Thebus, where the cabiria were celebrated in honour of them: these gods are said to be, in number, four, *viz.* Axieros, Axiocersa, Axiocersus, and Casmilus.

**CABIRIA**, festivals in honour of the cabiri, celebrated in Thebes and Lemnos, but especially in Samothracia, an island consecrated to the cabiri. All who were initiated into the mysteries of these gods, were thought to be secured thereby from storms at sea, and all other dangers. The ceremony of initiation was performed by placing the candidate, crowned with olive-branches, and girded about the loins with a purple ribband, on a kind of throne, about which the priests, and persons before initiated, danced.

**CABLAN**, the name of a kingdom and city of India, beyond the Ganges.

**CABLE**, a thick, large, strong rope, commonly of hemp, which serves to keep a ship at anchor.

There is no merchant-ship, however weak, but has at least three cables; namely, the chief cable, or cable of the sheet-anchor, a common cable, and a smaller one.

Cable is also said of ropes, which serve to raise heavy loads, by the help of cranes, pullies, and other engines. The name of cable is usually given to such as have, at least, three inches in diameter; those that are less are only called ropes of different names, according to their use.

Every cable, of what thickness soever it be, is composed of three strands; every strand of three ropes; and every rope of three twists: the twist is made of more or less threads, according as the cable is to be thicker or thinner.

In the manufacture of cables, after the ropes are made, they use sticks, which they pass first between the ropes of which they make the strands, and afterwards between the strands of which they make the cable, to the end that they may all twist the better, and be more regularly wound together; and also, to prevent them from twining or intangling, they hang,

at

at the end of each strand and of each rope, a weight of lead or of stone.

The number of threads each cable is composed of is always proportioned to its length and thickness: and it is by this number of threads that its weight and value are ascertained: thus a cable of three inches circumference, or one inch diameter, ought to consist of 48 ordinary threads, and weigh 192 pounds; and on this foundation is calculated the following table, very useful for all people engaged in marine commerce, who fit out merchant-men for their own account, or freight them for the account of others.

*A table of the number of threads and weight of cables of different circumferences.*

Circumf.	Threads.	Weight.
3 inches.	48	192 pounds
4	77	308
5	121	484
6	174	696
7	238	952
8	314	1244
9	393	1572
10	485	1940
11	598	2392
12	699	2796
13	821	3284
14	952	3808
15	1093	4372
16	1244	4976
17	1404	5616
18	1574	6296
19	1754	7016
20	1943	7772

**Sheet-anchor CABLE**, is the greatest cable belonging to a ship.

**Serve or plate the CABLE**, is to bind it about with ropes, clouts, &c. to keep it from galling in the hawser.

**To splice a CABLE**, is to make two pieces fast together, by working the several threads of the rope, the one into the other.

**Pay more CABLE**, is to let more out of the ship. **Pay cheap the cable**, is to hand it out apace. **Veer more cable**, is to let more out, &c.

**CABLED**, in heraldry, a term applied to a cross, formed of the two ends of a ship's cable; sometimes also to a cross covered over with rounds of rope, more properly called a cross-corded.

**CABLED-flute**, in architecture, such flutes as are filled up with pieces, in the form of a cable.

**CABO DE ISTRIA**, the capital of the province of Istria, in the dominion of Venice, situated on the gulph of Venice, about twelve miles south of Trieste: E. long. 14° 20', and N. lat. 45° 50'.

**CABOCHED**, in heraldry, is when the heads of beasts are borne without any part of the neck, full-faced.

**CABOLETTO**, in commerce, a coin of the republic of Genoa, worth about 3 d. of our money.

**CABUL**, the capital of a province of the same name, on the north-west of India. Both the town and pro-

vince of Cabul were ceded to the Persians in 1739: E. long. 69°, and N. lat. 35° 30'.

**CABURNS**, on ship-board, are small lines, made of spun yarn, to bind cables, seize tackles, or the like.

**CACACA**, a city of Africa, in the kingdom of Fez.

**CACAGOGA**, among ancient physicians, ointments, which, applied to the fundament, procure stools. Iulus Aegineta directs to boil alum, mixed with honey, for that purpose.

**CACALIA**, in botany, a genus of the syngenesia polygamia æqualis class. The receptacle is naked; the pappus is hairy; and the calix is cylindrical, oblong, and has a kind of small cup at the base. There are 12 species, none of which are natives of Britain.

**CACALIANthemum**, in botany, a synonyme of the cacalia. See **CACALIA**.

**CACAO**, in botany. See **THEOBROMA**.

**CACERES**, a town of Estremadura, in Spain, about seventeen miles south-east of Alcantara: W. long. 6° 45', and N. lat. 39° 12'.

**CACHAN**, a city of Persia, situated in a large plain, about 20 leagues from Ispahan.

It is remarkable for its manufactures of gold and silver stuffs, and of fine earthen ware.

**CACHAO**, or **KECHIO**, the capital of the kingdom of Torquin, situated on the western shore of the river Domea: E. long. 105°, and N. lat. 22° 30'.

**CACHECTIC**, something partaking of the nature of, or belonging to a cachexy. See **CACHEXY**.

**CACHEMIRE**, or **KACHEMIRE**, a province of Asia, in the country of the Mogul. The inhabitants are thought to have been originally Jews, because they speak much of Moses and Solomon, whom they believe to have travelled into their country.

**CACHEMIRE** is also the capital of that province, situated in 76° E. long. and 34° 30' N. lat.

**CACHEXY**, in medicine, a vitious state of the humours and whole habit. See **MEDICINE**.

**CACHRYIS**, in botany, a genus of the pentandria digynia class. The fruit is oval and a little angled. There are but two species, viz: the libanotis, a native of Sicily; and the ficula, a native of Sicily and Spain.

**CACOETHES**, in medicine, an epithet applied, by Hippocrates, to malignant and difficult distempers: when applied to signs or symptoms, it imports what is very bad and threatening; and if given to tumours, ulcers, &c. it denotes a great malignancy.

**CACTUS**, in botany, a genus of the icosandria monogynia class. The calix consists of one leaf, imbricated, and above the fruit. The berry has but one cell, containing many seeds. The species are twenty-three, one of which is the cochineal-plant. See **COCHINEAL**.

**CAD**, or **CADE**. See **CADE**.

**CADARI**, or **KADARI**, a sect of Mahometans, which attributes the actions of men to men alone, and not to the divine decree determining his will; and denies all absolute decrees, and predestination. Ben Aun calls the cadari, the magi or manichæes of the mussulmans.

**CADE**,

**CADE**, a cag, cask, or barrel. A cade of herrings is a vessel containing the quantity of 500 red herrings, or of sprats 1000.

**CADE-LAMB**, a young lamb, weaned and brought up by hand in a house.

**CADE-OIL**, an oil much used in France and Germany: it is prepared from the fruit of a species of cedar, called *oxycedrus*.

**CADE-WORM**, in zoology, the maggot or worm of a fly, called phryganea. See **PHRYGANEAE**.

**CADENCE**, in reading, is a falling of the voice below the key-note at the close of every period. In reading, whether prose or verse, a certain tone is assumed which is called the key-note; and in this tone the bulk of the words are sounded; but this note is generally lowered towards the close of every sentence.

**CADENCE**, in music, according to the ancients, is a series of a certain number of notes, in a certain interval, which strike the ear agreeably, and especially at the end of the song, stanza &c. It consists ordinarily of three notes.

Cadence, in the modern music, may be defined a certain conclusion of a song, or of the parts of a song, which divide it, as it were, into so many numbers or periods. It is when the parts terminate in a chord or note, the ear seeming naturally to expect it; and is much the same in a song, as the period that closes the sense in a paragraph of a discourse.

A cadence is either perfect, consisting of two notes sung after each other, or by degrees conjoined in each of the two parts, and by these means satisfying the ear; or imperfect, when its last measure is not in the octave or unison, but a sixth or third. It is called imperfect, because the ear doth not acquiesce in the conclusion, but expects a continuation of the song. The cadence is said to be broken, when the bass, instead of falling a fifth, as the ear expects, rises a second, either major or minor. Every cadence is in two measures; sometimes it is suspended, in which case it is called a repose, and only consists of one measure, as when the two parts stop at the fifth, without finishing the cadence. With regard to the bass-viol, Mr Rousseau distinguishes two cadences, one with a rest, when the singer, that should shake the cadence, stops a little, before it shakes, on the note immediately above that which requires the cadence; and one without a rest, when the stop is omitted.

**CADENCE**, in the menage, an equal measure or proportion, observed by a horse in all his motions; so that his times have an equal regard to one another, the one does not embrace or take in more ground than the other, and the horse observes his ground regularly.

**CADENE**, one of the sorts of carpets which the Europeans import from the Levant. They are the worst sort of all, and are sold by the piece from one to two paces per carpet.

**CADET**, the younger son of a family, is a term naturalized in our language from the French. At Paris, among the citizens, the cadets have an equal patrimony with the rest. At Caux, in Normandy, the cu-

stom, as with us, is to leave all to the eldest, except a small portion to the cadets. In Spain, it is usual for one of the cadets in great families to take the mother's name.

**CADET** is also a military term denoting a young gentleman who chuses to carry arms in a marching regiment as a private man. His views are, to acquire some knowledge in the art of war, and to obtain a commission in the army. Cadet differs from volunteer, as the former takes pay, whereas the latter serves without any pay.

**CADI**, or **CADHI**, a judge of the civil affairs in the Turkish empire.

It is generally taken for the judge of a town; judges of provinces being distinguished by the appellation of molla's.

In Biledulgerid in Africa, the cadhi decides in spiritual affairs.

**CADILESCHER**, a capital officer of justice among the Turks, answering to a chief justice among us.

It is said, that this authority was originally confined to the soldiery; but that, at present, it extends itself to the determination of all kinds of law-suits; yet nevertheless subject to appeals.

There are but three cadileschers in all the grand signior's territories; the first is that of Europe; the second, of Natolia; and the third resides at Grand Cairo. This last is the most considerable: they have their seats in the divan next to the grand vizir.

**CADIZ**, a city and port-town of Andalusia in Spain, situated on the north-west end of the island of Leon, or Lyon, opposite to Port St Mary on the continent, about sixty miles south-west of Seville, and forty north-west of Gibraltar: W. long. 6° 40', N. lat. 36° 30'.

The island it stands on is in length about eighteen miles; the south-west end is about nine broad, but the other end, where the city stands, not above two. It has a communication with the continent by means of a bridge; and, with the opposite shore, forms a bay of twelve miles long and six broad. About the middle of this bay, there are two head-lands, or promontories, one on the continent, and the other on the island, which advance so near together, that the forts upon them, called the Puntal and Matagorda, command the passage; and within these forts is the harbour, which it is impossible for an enemy to enter till he has first taken the forts.

**CADIZADELITES**, a sect of Mahometans very like the ancient stoics. They shun feasts and diversions, and affect an extraordinary gravity in all their actions; they are continually talking of God, and some of them make a jumble of Christianity and Mahometanism; they drink wine, even in the fast of the ramazan; they love and protect the Christians; they believe that Mahomet is the Holy Ghost, practise circumcision, and justify it by the example of Jesus Christ.

**CADMIÄ**, a metallic substance separated from the ore of zinc by fusion. See **CHEMISTRY**, *Of zinc*.

**CADORIN**, a province of Italy, in the territories of Venice, bounded by the bishopric of Brixen on the north;



north; by Friuli, on the east; by the Bellunese, on the south; and by the Trentin, on the west.

**CADRITES**, a sort of Mahometan friars, who once a-week spend great part of the night in turning round, holding each other's hand, and repeating incessantly the word *hzi*, which signifies living, and is one of the attributes of God; during which one of them plays on a flute. They never cut their hair, nor cover their heads, and always go bare footed; they have liberty to quit their convent when they please, and to marry.

**CADSAND**, an island on the coast of Dutch Flanders, situated at the mouth of the Scheld, whereby the Dutch command the navigation of that river.

**CADUCEUS**, in antiquity, Mercury's rod, or sceptre, being a wand entwisted by two serpents, borne by that deity, as the ensign of his quality and office, given him, according to the fable, by Apollo, for his seven-stringed harp.

Wonderful properties are ascribed to this rod by the poets, as laying men asleep, raising the dead, &c. It is used also as a symbol of peace. The caduceus, as found on some medals, is a common symbol, signifying good conduct, peace, and prosperity.

**CADUS**, in antiquity, a wine-vessel of a certain capacity, containing eighty amphoræ, or firkins, each of which, according to the best accounts, held nine gallons.

**CÆCILIA**, in zoology, a genus of serpents belonging to the amphibia class. The cæcilia has no scales; it is smooth, and moves by means of lateral rugæ or prickles. The upper lip is prominent, and furnished with two tentacula. It has no tail. There are but two species of this serpent, viz. 1. The tentaculata, has 135 rugæ. It is about a foot long and an inch in circumference, preserving an uniform cylindrical shape from the one end to the other. The teeth are very small. It has such a resemblance to an eel, that it may easily be mistaken for one; but as it has neither fins nor gills, it cannot be classed with the fishes. It is a native of America, and its bite is not poisonous. 2. The glutinosa has 340 rugæ or prickles above and ten below the anus. It is of a brownish colour, with a white line on the side, and is a native of the Indies.

**CÆCUM**, or **COECUM**, in anatomy, the blind-gut. See p. 260. col. 2.

**CÆMENT**, in a general sense, any glutinous substance, capable of uniting and keeping things together in close cohesion: in this sense, under cæment, are comprehended mortar, solder, glue, &c. but, strictly speaking, the term cæment only denotes a glutinous composition, used in cæmenting broken glasses, china-ware, or earthen-ware.

One of the finest, and at the same time strongest cæment for this purpose, is the juice of garlic stamped in a stone mortar: this, if the operation is done with care, leaves little or no mark. Another cæment is made by beating the white of an egg very clear, and mixing with it fine powdered quick-lime: or using glass, powdered chalk, and a little lime may be mixed toge-

VOL. II. Numb. 30.

3

ther, and dissolved in fair water. With these, the glasses, &c. are to be cæmented, and then set in the shade to dry; a caution which should always be observed, whichever of the above cæments is used.

A cæment for cracked chemical glasses, that will stand the fire, may be thus prepared: take wheat-flour, fine powdered Venice glass, and pulverized chalk, of each an equal quantity; of fine brick-dust, one half of the said quantity; and a little scraped lint: mix them all together with the whites of eggs; then, spreading this mixture upon a linen cloth, apply it to the cracks of the glasses, which must be well dried before they are used. Old varnish is another cæment that will answer the same purpose.

**CÆMENT**, among builders, a strong sort of mortar, used to bind bricks or stones together for some kind of mouldings; or in cæmenting a block of bricks for the carving of capitals, scrolls, or the like. There are two sorts, 1. Hot cæment, which is the most common, made of resin, bees-wax, brick-dust, and chalk, boiled together. The bricks to be cæmented with this kind, must be made hot with the fire, and rubbed to and fro after the cæment is spread, in the same manner as joiners do when they glue two boards together. 2. Cold cæment, made of Cheshire-cheese, milk, quick-lime, and whites of eggs. This cæment is less used than the former, and is accounted a secret known but to few bricklayers.

**CÆMENT**, among engravers, jewellers, &c. a composition of fine brick-dust well sifted, resin, and bees-wax, in use among these artificers to keep the metals to be engraven or wrought on firm to the block; and also to fill up what is to be chiselled.

**CÆMENT**, in chemistry, a kind of menstruum composed of salts, sulphurs, and brick, reduced to dry powders, and strewed betwixt plates of metal, in order to raise their colour, or separate one metal from another. See **CHEMISTRY**.

**CÆMENT-POTS**, or those used in the cæmentation of metals, are made of fine potter's clay, and that either pure, or mixed with sand in different proportions.

**CÆMENTATION**, in a general sense, the corroding of metals in a dry form, by means of the fumes of acid salts. See **CHEMISTRY**, Part II.

**CAEN**, the capital of a county of the same name in Normandy, situated on the river Orne, about seventy-five miles west of Rouen, and thirty south-west of Havre de Grace: W. long. 25', N. lat. 49° 20'.

It has an university, first founded by king Henry VI. of England, in 1431.

**CAERFILLY**, a town of Glamorganshire, about five miles north of Llandaff: W. long. 3° 15', and N. lat. 51° 35'.

**CÆRITES**, or **CÆRITUM TABULÆ**, in Roman antiquity, tables or registers in which the names of the Cærites were registered. The people of Cære were accounted citizens of Rome, but had no privilege of voting; hence when a Roman citizen was degraded, if a senator, he was expelled the senate; if a knight, he lost the public horse; and if a plebeian, his name was inserted in the register of the Cærites; that is, he

†

B

was

was subject to all taxes, but incapable of voting or enjoying any public office.

**CAERLEON**, a market-town of Monmouthshire, situated on the river Uske, about sixteen miles south-west of Monmouth: W. long. 3°, N. lat. 51° 40'.

**CAERMARTHEN**, the capital of Caermarthenshire in Wales, situated upon the river Tivy, about five miles from the sea.

**CAERNARVAN**, the chief town of Caernarvanshire in Wales, situated upon the river Menay.

**CAERWIS**, a market-town in Flintshire, in north Wales, about five miles east of St Asaph, and four west of Flint: W. long. 3° 25', N. lat. 53° 20'.

**CÆSALPINIA**, in botany, a genus of the decandria monogynia class. The calix has five segments, the lowest of which is largest; the corolla consists of five petals; the capsule is of the pod kind. There are four species, all natives of the Indies.

**CÆSALPINOIDES**, in botany, a synonyme of the *gleditsia*. See *GLEDITSIA*.

**CÆSAR**, in Roman antiquity, a title borne by all the emperors, from Julius Cæsar, to the destruction of the empire. It was also used as a title of distinction, for the intended or presumptive heir of the empire, as King of the Romans is now used for that of the German empire.

This title took its rise from the surname of the first emperor, C. Julius Cæsar, which, by a decree of the senate, all the succeeding emperors were to bear. Under his successor, the appellation of Augustus being appropriated to the emperors, in compliment to that prince, the title Cæsar was given to the second person in the empire, though still it continued to be given to the first; and hence the difference betwixt Cæsar used simply, and Cæsar with the addition of Emperor Augustus.

The dignity of Cæsar remained the second of the empire, till Alexius Comnenus having elected Nicephorus Melissenus Cæsar, by contract; and it being necessary to confer some higher dignity on his own brother Isaacus, he created him Sebastocrator, with the precedency over Melissenus; ordering, that in all acclamations, &c. Isaacus Sebastocrator should be named the second, and Melissenus Cæsar, the third.

**CÆSARIAN operation**, in midwifery. See *MIDWIFERY*.

**CÆSARIANS**, *caesarienses*, in Roman antiquity, were officers or ministers of the Roman emperors: They kept the account of the revenues of the emperors, and took possession, in their name, of such things as devolved, or were confiscated to them.

**CÆSTUS**, in antiquity, a large gantlet made of raw hide, which the wrestlers made use of when they fought at the public games.

This was a kind of leathern strap, strengthened with lead, or plates of iron, which encompassed the hand, the wrist, and a part of the arm, as well to defend these parts, as to enforce their blows.

**CÆSTUS**, or *CÆSTUM*; was also a kind of girdle, made of wool, which the husband untied for his spouse the first day of marriage, before they went to bed.

This relates to Venus's girdle, which Juno borrowed of her, to entice Jupiter to love her. See *CÆSTUS*.

**CÆSURA**, in the ancient poetry, is, when, in the scanning of a verse, a word is divided so, as one part seems cut off, and goes to a different foot from the rest; as,

*Mentis|ri nolli, num|quam| mendacia| profunt.*

where the syllables *ri*, *li*, *quam*, and *men*, are cæsuras.

**CÆSURE**, in the modern poetry, denotes a rest, or pause, towards the middle of an Alexandrian verse, by which the voice and pronunciation are aided, and the verse, as it were, divided into two hemistichs. See *PAUSE*.

**CAFFA**, in commerce, painted cotton-cloths manufactured in the E. Indies, and sold at Bengal.

**CAFFA**, or *KAFFA*, a city and port-town of Crim Tartary, situated on the south-east part of that peninsula: E. long. 37°, N. lat. 44° 55'.

It is the most considerable town in the country, and gives name to the straits of Caffa, which run from the Euxine or Black sea, to the Palus Meotis, or sea of Azoph.

**CAFFILA**, a company of merchants or travellers, who join together in order to go with more security thro' the dominions of the Grand Mogul, and through other countries on the continent of the E. Indies.

The Caffila differs from a caravan, at least in Persia; for the caffila belongs properly to some sovereign, or to some powerful company in Europe; whereas a caravan is a company of particular merchants, each trading upon his own account. The English and Dutch have each of them their caffila at Gambon.

**CAFFILA** on the coast of Guzerat or Cambaya, signifies a small fleet of merchant-ships.

**CAFFRARIA**, the country of the Caffers, or Hottentots, in the most southerly part of Africa, lying in the form of a crescent about the inland country of Monomotapa, between 35° S. lat. and the tropic of Capricorn; and bounded on the east, south, and west, by the Indian and Atlantic oceans.

Most of the sea-coasts of this country are subject to the Dutch, who have built a fort near the most southern promontory, called the Cape of Good-Hope.

**CAG**, or *KEG*, a barrel or vessel, that contains from four to five gallons.

**CAGE**, an inclosure made of wire, wicker, or the like, interwoven lattice-work, for the confinement of birds, or wild beasts.

The cage, in the Roman amphitheatres, was a place wherein savage animals were confined. It was inclosed with iron rails, and open at top, so as to be seen to the bottom by the spectators.

**CAGLI**, a town of the province of Urbino, in the pope's territories, about twenty-five miles south of the city of Urbino: E. long. 14°, N. lat. 43° 15'.

**CAGLIARI**, the capital of the island of Sardinia, situated on a bay of the sea in the southern part of that island: E. long. 9° 12', N. lat. 39°.

**CAGUI**, in zoology, a synonyme of two species of monkey, *viz.* the jaccchus and œdipus. See *SIMIA*.

**CAHERAH**,

**CAHERAH**, or **AL-CAHERAH**, the capital of Egypt, which we call Grand Cairo. See **CAIRO**.

**CAHLO**, the name by which some call the lupus pifcis or wolf-fish.

**CAHORS**, the capital of the territory of Querci, in the province of Guienne in France, situated about forty-five miles north of Tholouse: E. long. 1°, N. lat. 44° 25'.

It is the see of a bishop, and has an university.

**CAHYS**, a dry measure for corn, used in some parts of Spain, particularly at Seville and at Cadiz. It is near a bushel of our measure.

**CAJANABURG**, the capital of the province of Cajania, or east Bothnia in Sweden, situated on the north-east part of the lake Cajania, about three hundred miles north-east of Abo: E. long. 27°, N. lat. 63° 50'.

**CAJAZZO**, a town of the province of Lavoro in the kingdom of Naples. situated about sixteen miles north-east of the city of Naples: E. long. 15°, N. lat. 41° 15'.

**CAJEPUT**, an oil brought from the E. Indies, which resembles that of cardamoms.

**CAIFUM**, a city of China, situated in the province of Honan, on the river Croceus, three hundred and fifty miles north-west of Nanking: E. long. 113° 30', and N. lat. 35°.

**CAIMACAN**, or **CAIMACAN**, in the Turkish affairs, a dignity in the Ottoman empire, answering to lieutenant, or rather deputy, among us.

There are usually two caimacans, one residing at Constantinople, as governor thereof; the other attending the grand vizir, in quality of his lieutenant, secretary of state, and first minister of his council; and gives audience to ambassadors. Sometimes there is a third caimacan, who attends the sultan; whom he acquaints with any public disturbances, and receives his orders concerning them.

**CAIMAN**, or **CAIMAN-ISLANDS**, certain American islands lying south of Cuba, and north-west of Jamaica, between 81° and 86° of W. long. and in 21° of N. lat.

They are most remarkable on account of the fishery of tortoise, which the people of Jamaica catch here; and carry home alive, keeping them in pens for food, and killing them as they want them.

**CAINIANS**, or **CAINITES**, in church-history, Christian heretics, that sprung up about the year 150, and took their name from Cain, whom they looked upon as their head and father: They said that he was formed by a celestial and almighty power, and that Abel was made but by a weak one.

This sect adopted all that was impure in the heresy of the gnostics, and other heretics of those times: They acknowledged a power superior to that of the Creator; the former they called *Wisdom*, the latter, *Inferior Virtue*: They had a particular veneration for Korah, Abiram, Esau, Lot, the Sodomites, and especially Judas, because his treachery occasioned the death of Jesus Christ: They even made use of a gospel, which bore that false apostle's name.

**CAINITO**, in botany. See **CHRYSORHYLLUM**.

**CAIRO**, or **GRAND CAIRO**, the capital of Egypt, situated in a plain at the foot of a mountain, about two miles east of the Nile, and 100 miles south of the mouth of that river: E. long. 32°, N. lat. 30°.

The town is ten miles in circumference, and full of inhabitants. The castle stands on the summit of a hill, at the south end of the town, and is three miles round. The British and other European states have their consuls and factors here, for the protection of trade.

**CAIROAN**, a town of the kingdom of Tunis in Africa, situated on the river Magrida, about eighty miles south of Tunis: E. long. 9°, N. lat. 36°.

**CAINS**, a name given to the Greeks in the isle of Crete, who revolt from the Turks to the Venetians.

**CAISSON**, in the military art, a wooden chest, into which several bombs are put, and sometimes only filled with gun-powder: This is buried under some work whereof the enemy intends to possess themselves, and, when they are masters of it, is fired, in order to blow them up.

**CAISSON** is also used for a wooden frame or chest, used in laying the foundations of the piers of a bridge.

**CAITHNESS**. See **CATHNESS**.

**CAKILE**, in botany. See **BUNIAS**.

**CALABA**, in botany. See **CALOPHYLLUM**.

**CALABASH-tree**, in botany. See **CRESCENTIA**.

**CALABRIA**, the most southerly part of the kingdom of Naples, situated over against Sicily.

There are two provinces of Calabria called the *Hither* and *Farther Calabria*, with respect to the city of Naples; Cosenza being the capital of the former, and Rheggio of the latter.

**CALADE**, in the menage, the descent or sloping declivity of a rising menage ground, being a small eminence upon which we ride down a horse several times, putting him to a short gallop, with his fore-hams in the air, to make him learn to ply or bend his haunches, and form his stop upon the aids of the calves of the legs, the stay of the bridle, and the cavesson seasonably given.

**CALAHORRA**, a city of Old Castile in Spain, situated on the river Ebro, near the confines of Navarre, about sixty miles north-west of Saragossa: W. long. 2°, N. lat. 42° 20'.

**CALAIS**, a port-town of Picardy in France, situated on the English channel, about twenty-two miles south-east of Dover: E. long. 2°, N. lat. 51°.

**CALAMANCO**, a sort of woolen stuff manufactured in England and in Brabant. It has a fine gloss, and is chequered in the warp, whence the checks appear only on the right side. Some calamanços are quite plain, others have broad stripes adorned with flowers; some with plain broad stripes, some with narrow stripes, and others watered.

**CALAMINARIS**, or **LAPIS CALAMINARIS**, in natural history, a kind of fossil, the general ore of zinc, of a spongy substance and a lax and cavernous texture, yet considerably heavy.

It is of no determinate shape or size, but is found in masses of a very various and irregular figure. It is, when

when most pure and perfect, of a pale brownish grey. It is found in Germany, Saxony, Bohemia, and England. See CHEMISTRY, *Of zinc*.

After roasting the calamine, in order to purge it of sulphureous or arsenical matter, it is used by physicians in collyria against defluxions of thin acrid humours upon the eyes, for drying up moist running ulcers, and healing excoriations.

**CALAMINT**, in botany. See MELISSA, and MENTHA.

**CALAMITA**, in natural history, a name given to styrax. See STYRAX.

**CALAMITA** is sometimes also used for the magnet or load-stone.

**CALAMITES**. See OSTEOCOCCA.

**CALAMUS**, in botany, a genus of the hexandria monogynia class. The calix has six leaves; it has no corolla; the berry is imbricated, and contains but one seed. There is but one species, *viz.* the rotang, a native of India.

**CALAMUS aromaticus**, or sweet-scented flag, in the materia medica, a species of flag called acorus by Linnaeus. See ACORUS. The root is generally looked upon as a carminative and stomachic medicine, and as such is sometimes used in practice.

**CALAMUS scriptorius**, in antiquity, a reed or rush to write with.

The ancients made use of styles to write on tables covered with wax; and of reed, or rush, to write on parchment, or Egyptian paper.

**CALANGAY**, in ornithology. See PSITTACUS.

**CALASH**, or **CALESH**, a light and very low kind of chariot, used chiefly for taking the air in parks and gardens.

**CALASIRIS**, in antiquity, a linen tunic fringed at the bottom, and worn by the Egyptians under a white woollen garment; but this last they were obliged to pull off when they entered the temples, being only allowed to appear then in linen habits.

**CALATAJUD**, a city of Aragon, in Spain, situated on the river Xalo, about fifty miles west of Saragossa: W. long.  $2^{\circ} 5'$ , N. lat.  $41^{\circ} 15'$ .

**CALATHUS**, in antiquity, a basket, hamper, or panier of osiers, reeds, or twigs, for women to put their work in, or to gather flowers in.

**CALATHUS** was also a vessel, or pan, for cheese-curd and milk; also the name of a cup for wine, used in sacrifices.

**CALATOR**, in antiquity, was a public servant, and a freeman, such as a bailiff or crier, a sumner, to summon courts, synods, and other public assemblies.

**CALATRAVA**, a city of new Castile, in Spain, situated on the river Guadiana, forty-five miles south of Toledo: W. long.  $4^{\circ} 20'$ , N. lat.  $39^{\circ}$ .

*Knights of CALATRAVA*, a military order in Spain, instituted under Sancho III. king of Castile, upon the following occasion. When that prince took the strong fort of Calatrava from the moors of Andalusia, he gave it to the templars, who, wanting courage to defend it, returned it him again. Then Don Reynonard, of the order of the Cistercians, accompanied with several

persons of quality, made an offer to defend the place, which the king thereupon delivered up to them, and instituted that order. It increased so much under the reign of Alphonfus, that the knights desired they might have a grand master, which was granted. Ferdinand and Isabella afterwards, with the consent of pope Innocent VIII. reunited the grand mastership of Calatrava to the Spanish crown; so that the kings of Spain are now become perpetual administrators thereof.

The knights of Calatrava bear a cross gales, fluerdelised with green, &c. their rule and habit was originally that of the Cistercians.

**CALCADA**, or **St DOMINGO DE CALCADA**, a city of Old Castile, in Spain, forty-eight miles east of Burgos: W. long.  $3^{\circ}$ , N. lat.  $42^{\circ} 36'$ .

**CALCANEUM**, or **OS CALCIS**, in anatomy. See p. 186. col. 1.

**CALCAR**, in zoology, the trivial name of a species of nautilus. See NAUTILUS.

**CALCAR**, in glass-making, a sort of oven, or reverberatory furnace, in which, being well heated, the crystal frit, or bollito, is made.

**CALCAR**, in geography, a town of the duchy of Cleves, and circle of Westphalia, in Germany: E. long.  $5^{\circ} 50'$ , and N. lat.  $51^{\circ} 45'$ .

**CALCARIOUS**, in general, denotes something belonging to, or partaking of the nature of calx. See CALX.

**CALCARIUS lapis**, in natural history, the same with lime-stone. See LIME.

**CALCEARIUM**, in antiquity, a term used to denote the allowance made the soldiers to buy their shoes.

**CALCEOLUS**, in botany. See CYPRIPEDIUM.

**CALCINATION**, in chemistry, the reducing of substances to a calx by fire. See CHEMISTRY.

**CALCITRAPA**, and **CALCITRAPOIDES**, in botany. See CENTAUREA.

**CALCULUS**, in natural history, properly denotes a little stone or pebble. See PEBBLE.

**CALCULUS**, or **CALCULUS HUMANUS**, in medicine, the stone in the bladder or kidneys. See MEDICINE, and SURGERY.

**CALCULUS** also denotes a method of computation, so called from the calculi, or counters, anciently used for this purpose. Hence,

**CALCULUS SPECIALIS**, or **LITERALIS**, is the same with algebra. See ALGEBRA.

**CALCULUS differentialis** is a method of differencing quantities, that is, of finding an infinitely small quantity, which being taken an infinite number of times, shall be equal to a given quantity. See FLUXIONS.

**CALCULUS exponentialis**, among mathematicians, a method of differencing exponential quantities, and summing up the differentials of exponential quantities. See FLUXIONS.

**CALCULUS INTEGRALIS**, or **SUMMATORIUS**, is a method of summing up differential quantities; that is, from a differential quantity given, to find the quantity from whose differencing the given differential results. See FLUXIONS.

**CALDARIUM**, in the ancient baths, a certain vault,

or

or room, made so as to collect the vapours, and produce sweating: whence it signifies a hot-house, bagnio, stove, or sweating-room.

**CALEFACTION**, the production of heat in a body from the action of fire, or that impulse impressed by a hot body upon other bodies about it. This word is used in pharmacy, by way of distinction from coction, which implies boiling; whereas calefaction is only heating a thing.

**CALENBURG-CASTLE**, the capital of a duchy of the same name, in Lower Saxony, in Germany, situated upon the river Leine, about fifteen miles south of Hanover: E. long.  $9^{\circ} 40'$ , and N. lat.  $52^{\circ} 20'$ .

**CALENDAR**, a distribution of time, accommodated to the various uses of life, but more especially such as regard civil and ecclesiastical polity. See **ASTRONOMY**, *Of the division of time*.

**Julian Christian CALENDAR**. See **ASTRONOMY**, *Of the division of time*.

**Gregorian CALENDAR**. See **ASTRONOMY**, *Of the division of time*.

**CALENDER**, a machine used in manufactories, to press certain woollen and silken stuffs, and linens, to make them smooth, even, and glossy, or to give them waves, or water them, as may be seen in mohairs and tabbies. This instrument is composed of two thick cylinders, or rollers, of very hard and polished wood, round which the stuffs to be calendered are wound: these rollers are placed cross-ways between two very thick boards, the lower serving as a fixed base, and the upper moveable, by means of a thick screw, with a rope fastened to a spindle, which makes its axis: the uppermost board is loaded with large stones weighing 20000 lb. or more. It is this weight that gives the polish and makes the waves on the stuffs about the rollers, by means of a shallow indenture or engraving cut in it.

**CALENDS**, in Roman antiquity, the first day of each month, so called from the Greek [*kalein*], to proclaim: it being customary, on those days, to proclaim the number of holy-days in each month.

The Roman method of reckoning the days of their months has something extremely singular in it: instead of computing forwards, in the natural order of the numbers 1, 2, 3, &c. they reckoned backwards, in the manner expressed in the following verses:

*Prima dies mensis cujusque est dicta calendæ:  
Sex Maius, nonas, Julius, October, & Mars;  
Quatuor at reliqui: habet idus quilibet octo;  
Inde dies reliquos omnes dic esse calendæ;  
Quas retro numerans, dices a mense sequente.*

Hence to find the day of our month answering to that of the calends, to the number of days in the preceding month add two, and from this sum subtracting the number of calends given, the remainder will be the day of our month: thus the fourth of the calends of June is found to answer to the twenty-ninth of May; and so in other cases.

**CALENDULA**, or **MARYGOLD**, in botany, a genus of the Syngenesia polygamia necessaria class. The receptacle is naked; it has no pappus; the calix con-

sists of many equal leaves; the seeds of the disk are membranaceous. There are eight species, none of them natives of Europe. The flowers of the *calendula officinalis*, or garden marygold, are said to be aperient and attenuating, as also cordiac, alexipharmic, and sudorific. They are principally celebrated in uterine obstructions, and for throwing out the small pox.

**CALF**, in zoology, the young of the ox-kind. See **Bos**.

Among sportsmen, the term calf is used for a hart or hind of the first year: the same term is also used for the young of the whale.

*Sea CALF*. See **PHOCA**.

**CALF'S-Snout**, in botany. See **ANTIRRHINUM**.

**CALIACA**, a town of Bulgaria, situated upon the Black-sea, belonging to the Turks.

**CALIBER**, or **CALIFER**, properly denotes the diameter of any body: thus we say, two columns of the same caliber, the caliber of the bore of a gun, the caliber of a bullet, &c.

**CALIBER-compasses**, the name of an instrument, made either of wood, iron, steel, or brass: that used for measuring bullets consists of two branches, bending inwards, with a tongue fixed to one of them; and the other graduated in such a manner, that if the bullet be compressed by the ends of the two branches, and the tongue be applied to the graduated branch, it will shew the weight of the bullet.

**CALIBER** also signifies an instrument used by carpenters, joiners, and bricklayers, to see whether their work be well squared.

**CALICUT**, a town situated on the Malabar coast, in the hither peninsula of India, subject to its own prince: E. long.  $75^{\circ}$ , and N. lat.  $11^{\circ} 20'$ .

This was the first port the Portuguese made in India, after sailing round the Cape of Good Hope.

**CALIDUCT**, in antiquity, a kind of pipes, or canals, disposed along the walls of houses and apartments, used, by the ancients, for conveying heat to several remote parts of the house, from one common furnace.

**CALIFORNIA**. See **CALLIFORNIA**.

**CALIMUS**. See **CALLIMUS**.

**CALIN**, a compound metal, whereof the Chinese make tea-canisters, and the like. The ingredients seem to be lead and tin.

**CALIPH**, the supreme ecclesiastical dignity among the Saracens; or, as it is otherwise defined, a sovereign dignity among the Mahometans, vested with absolute authority in all matters relating both to religion and policy.

It signifies in the Arabic, successor or vicar: the Saracen princes assumed this title as descendants from Mahomet; the caliphs bearing the same relation to Mahomet, that the popes pretend they do to Jesus Christ or St Peter. It is at this day one of the grand signior's titles, as successor of Mahomet; and of the sphi of Persia, as successor of Ali.

**CALIPPIC PERIOD**, an improvement of the cycle of Meton, of nineteen years, which Calippus, a famous Grecian astronomer, finding in reality to contain nine-

- teen of Nabonassar's years, four days, and  $\frac{1}{17}$ , he, to avoid fractions, quadrupled the golden number, and by that means made a new cycle of seventy-six years; which time being expired, he supposed the lunation, or changes of the moon, would happen on the same day of the month, and hour of the day, that they were on seventy-six years before.
- CALIX.** See **CALYX.**
- CALIXTINS,** in church-history, a sect of Christians, in Bohemia and Moravia: the principal point in which they differed from the church, was the use of the chalice, or communicating in both kinds.
- CALIXTINS,** is also a name given to those, among the Lutherans, who follow the sentiments of George Calixtus, a celebrated divine, who opposed the opinion of St Augustine, on predestination, grace, and free-will.
- CALKA,** a kingdom of Tartary, in Asia, to the east of Siberia.
- CALKING.** See **CAULKING.**
- CALKINS,** the prominent parts at the extremities of a horse-shoe, bent downwards, and forged to a sort of point.
- Calkins are apt to make horses trip; they also occasion blymes, and ruin the back sinews. If fashioned in form of a hare's ear, and the horn of a horse's heel be pared a little low, they do little damage; whereas the great square calkins quite spoil the foot.
- Calkins are either single or double, that is, at one end of the shoe, or at both: these last are deemed less hurtful, as the horse can tread more even.
- CALL,** among hunters, a lesson blown upon the horn, to comfort the hounds.
- CALLS,** *natural and artificial,* among fowlers, a sport much practised during the wooing season of partridges, especially for taking cock-partridges; for which they put a hen into a cage, to call and bring them near. The hen-partridge should be set near a hedge, in a thin, open, wire-cage, so that she may be seen at a good distance: then the net, called hallier, should be placed quite round the cage, each part about the distance of twenty feet: the fowler should retire behind the hedge.
- Artificial CALLS* are best made of box, walnut-tree, or the like: they are formed of the bigness of an hen's egg, bored through from end to end; about the middle there must be a hole hollowed within, to the bottom; then have a pipe of a swan's quill, and the bone of a cat's foot, opened at one end, which must be conveyed into the hole at the end, and so thrust into the hole at the middle; take afterwards a goose-quill, opened at both ends, and put it in at the other end of the call; blow into the quill, and it will make the like noise as the partridge-cock does.
- CALLA,** in botany, a genus of the gynandria polyandria class. The spathe is plain; the spadix is covered with stercules; it has no corolla; the berry contains many seeds. There are three species, none of them natives of Britain.
- CALLABAS,** a town of Indostan in Asia, upon the road from Surat to Agra.
- CALLAO,** a port-town in a little island on the coast of Peru, in South America, opposite to Lima: W. long  $76^{\circ}$ , and S. lat.  $12^{\circ}$ .
- CALLEN,** a town of Ireland, in the county of Kilkenny, and province of Leinster, about ten miles south-west of Kilkenny: W. long.  $7^{\circ} 22'$ , and N. lat.  $52^{\circ} 25'$ .
- CALLICHTYS,** in ichthyology, the trivial name of a species of silurus. See **SILURUS.**
- CALLICO,** in commerce, a kind of linen manufacture, made of cotton, chiefly in the East Indies, some of which are painted with various flowers of different colours; and others that are never dyed, having a stripe of gold and silver quite through the piece; and at each end they fix a tulle of gold, silver, and silk, intermixed with flowers. This manufacture is brought hither by the East-India company, and is re-exported by merchants to other parts of Europe. The general wear of stained or printed India calicoes in this nation having become a general grievance, and occasioning unspeakable distress upon our own manufacturers, they were prohibited by stat. 7 Geo. I. cap. vii.
- CALLIDRYS,** in ornithology, the trivial name of a species of motacilla. See **MOTACILLA.**
- CALLIFORNIA,** a large country of the West Indies, lying between  $116^{\circ}$  and  $138^{\circ}$  W. long. and between  $23^{\circ}$  and  $26^{\circ}$  N. lat. It is uncertain whether it be a peninsula or an island.
- CALLIGONUM,** in botany, a genus of the polyandria digynia class. The calix has five leaves; the petals are four; it has two styli; and the capsule is divided into two partitions, each containing two seeds. There is but one species, *viz.* the polygonoides, a native of mount Ararat.
- CALLIGRAPHUS,** in antiquity, a copist or scrivener, who transcribed, in a fair hand, what the notaries had taken down in notes, or minutes, being generally in a kind of cypher or short-hand, which, as they were in that hand, being understood by few, were copied over fair and at length by persons who had a good hand, for sale, &c.
- CALLING the house,** in the British parliament, is the calling over the members names, every one answering to his own, and going out of the house, in the order in which he is called: this they do, in order to discover whether there be any persons there not returned by the clerk of the crown; or if any member be absent without leave of the house.
- CALLIONYMUS,** in ichthyology, a genus of fishes belonging to the order of jugulares. The upper lip is doubled up; the eyes are very near each other; the membrane of the gills has six radii; the operculum is shut; the body is naked; and the belly-fins are at a great distance from each other. There are three species of callionymus, *viz.* 1. The lyra, with the first bone of the back-fin as long as the body of the animal, and a cirrus at the anus. It is of the Atlantic. 2. The dracunculus, with the first bone of the back-fin shorter than its body; which is of a spotted yellow colour. It frequents the shores of Genoa and Rome. 3. The indicus, has a smooth head with longitudinal wrinkles; the lower jaw is a little longer than the upper

- per one; the tongue is obtuse and emarginated; the apertures of the gills are large: it is of a livid colour, and the anus is in the middle of the body. It is a native of Asia.
- CALLISTEA**, in Grecian antiquity, a Lesbian festival, wherein the women presented themselves in Juno's temple, and the prize was assigned to the fairest. There was another of these contentions at the festival of Ceres Eleusinia, among the Parrhasians, and another among the Eleans, where the most beautiful man was presented with a complete suit of armour, which he consecrated to Minerva, to whose temple he walked in procession, being accompanied with his friends, who adorned him with ribbands, and crowned him with a garland of myrtle.
- CALLOSUM corpus**, in anatomy. See p 285. c. 2.
- CALLUS**, or **CALLOSITY**, in a general sense, any cutaneous, corneous, or osseous hardness, whether natural or preternatural: but most frequently it means the callus generated about the edges of a fracture, provided by nature to preserve the fractured bones, or divided parts, in the situation in which they are replaced by the surgeon.
- CALM**, in the sea language, is when there is no wind stirring.
- That tract of sea, to the northward of the equator, between  $4^{\circ}$  and  $10^{\circ}$  of latitude, lying between the meridians of Cape Verde, and of the easternmost island of that name, seems to be a place condemned to perpetual calms: the little winds that are being only some sudden uncertain gusts of very small continuance, and less extent. The Atlantic ocean, near the equator, is very much subject, nay, always attended with these calms.
- CALMAR**, the capital of the province of Gothland, in Sweden, situated on the coast of the Baltic sea, about forty miles north of Carelskroon: E. long  $16^{\circ}$ , and N. lat.  $56^{\circ} 40'$ .
- CALMUCKS**, certain wandering tribes or hords of Tartars, inhabiting the country north of the Caspian sea, under the protection of Russia.
- CALNE**, a borough-town of Wiltshire, about twenty miles north of Salisbury, which sends two members to parliament: W. long  $2^{\circ}$ , and N. lat.  $51^{\circ} 30'$ .
- CALOGERI**, in church-history, monks of the Greek church, divided into three degrees, the novices, called archari; the ordinary professed, called michrochemi; and the more perfect, called megalochemi: they are likewise divided into cœnobites, anchorets, and recluses. The cœnobites are employed in reciting their office from midnight to sun-set; they are obliged to make three genuflexions at the door of the choir, and returning, to bow to the right and to the left, to their brethren. The anchorets retire from the conversation of the world, and live in hermitages, in the neighbourhood of the monasteries; they cultivate a little spot of ground, and never go out but on Sundays and holy-days, to perform their devotions at the next monastery. As for the recluse, they shut themselves up in grottos and caverns, on the tops of mountains, which they never go out of, abandoning themselves entirely to Providence: They live on the alms sent them by the neighbouring monasteries.
- CALOMEL**, or dulcified sublimate of mercury, is prepared in the following manner. Take of corrosive sublimate, one pound; purified quick silver, nine ounces. Having powdered the sublimate, add to it the quick-silver, and digest them together in a matraass, with a gentle sand heat, until they unite; then increasing the heat, let the mixture be sublimed. The sublimed matter, freed from the acrimonious part at top and such mercurial globules as happen to appear distinct in it, is to be reduced into powder, and sublimed again; and this sublimation must be repeated six times. This dulcified mercury, or calomel, is one of the best preparations for general use. The dose, for raising a salivation, is ten or fifteen grains, taken in the form of a bolus, or pills, every night or oftener, till the ptyalism begins. As an alterant and diaphoretic, it is given in doses of five or six grains, a purgative being occasionally interposed, to prevent its affecting the mouth. It answers however much better when given in smaller quantities, as one, two, or three grains every morning and evening, in conjunction with such substances as determine its action to the skin, as the extract or resin of guaicum; the patient at the same time keeping warm, and drinking freely of warm diluting liquors. By this method of managing it, obdurate, cutaneous, and venereal distempers have been successfully cured, without any remarkable increase of the sensible evacuations.
- CALOPHYLLUM**, in botany, a genus of the polyandria monogynia class. The corolla consists of five petals; the calix has five teeth; and the drupa is globular. There are but two species, viz. the inophyllum, and calaba, both natives of India.
- CALOITE**, a cap or coil of hair, satin, or other stuff: an ecclesiastical ornament in most popish countries. See **CAP**.
- CALOTTE**, in architecture, a round cavity or depression, in form of a cap or cup, lathed and plastered, used to diminish the rise or elevation of a moderate chapel, cabinet, alcove, &c. which, without such an expedient, would be too high for other pieces of the apartment.
- CALPE**, the mountain, at the foot of which, towards the sea, Gibraltar stands. It is half a league in height towards the land, and so steep, that there is no approaching it on that side.
- CALQUING**, or **CALKING**, a term used in painting, &c. where the backside of any design is covered with a black or red colour, and the strokes, or lines, traced through, on a waxed plate, wall, or other matter, by passing lightly over each stroke of the design with a point, which leaves an impression of the colour on the plate or wall.
- CALTHA**, in botany, a genus of the polyandria polygynia class. It has no calix; there are five petals; and the capsules are many, containing a great number of seeds. There is but one species, viz. the palustris, or marsh-marygold, a native of Britain.
- CALTROP**, in botany, the English name of the tribulus. See **TRIBULUS**.

CALVARIA,

**CALVARIA**, in anatomy, the hairy scalp. See p. 151.

**CALVARY**, in heraldry, a cross so called, because it resembles the cross on which our Saviour suffered. It is always set upon steps.

**CALVI**, a town of the province of Lavoro, in the kingdom of Naples, situated near the sea, about fifteen miles north of the city of Naples: E. long.  $14^{\circ} 45'$ , and N. lat.  $41^{\circ} 15'$ .

**CALVI** is also the name of a sea-port in the island of Corsica, situated on a bay, on the west side of the island, about forty miles south-west of Bastia: E. long.  $9^{\circ} 5'$ , and N. lat.  $42^{\circ} 16'$ .

**CALVINISTS**, in church-history, those who follow the opinions of John Calvin, one of the principal reformers of the church, in the XVIth century, a person of great parts and industry, and of considerable learning; whose doctrine still subsists in its greatest purity at Geneva, where it was first broached, and from whence it was propagated. This is the prevailing religion of the United Provinces. In England, it is confined among the dissenters; and, in Scotland, it is the only orthodox faith.

The Calvinists are great advocates for the absolute-ness of God's decrees, and hold that election and reprobation depend on the mere will of God, without any regard to the merit or demerit of mankind; that he affords to the elect an irresistible grace, a faith that they cannot lose, which takes away the freedom of will, and necessitates all their actions to virtue.

The Calvinists believe that God foreknew a determinate number, whom he pitched upon to be persons, in whom he would manifest his glory; and that having thus foreknown them, he predestinated them to be holy, in order to which he gives them an irresistible grace, which makes it impossible for them to be otherwise.

**CALVITIES**, or **CALVITIUM**, in medicine, baldness, or a want of hair, particularly on the inciput, occasioned by the moisture of the head, which should feed it, being dried up, by some disease, old age, or the immoderate use of powder, &c. See **ALOPECIA**.

**CALUMET**, a symbol of peace among the Indians, in the north of America; It is made of a red stone, like our marble; the head resembles our tobacco-pipes, but larger; and is fixed on a hollow reed, to hold it for smoking: They adorn it with fine wings of several colours, and is the calumet of the sun, to whom they present it, especially if they want fair weather, or rain. This pipe is a pass and safe conduct amongst all the allies of the nation who has it given: in all embassies the ambassador carries it as an emblem of peace, and it always meets with a profound regard; for the savages are generally persuaded, that a great misfortune would befall them, if they violated the public faith of the calumet.

**CALX**, properly signifies lime, but is also used by chemists and physicians for a fine powder remaining after the calcination or corrosion of metals and other mineral substances. See **CHEMISTRY**.

**CALX antimonii**. See **CHEMISTRY**, *Of antimony*.

**CALX nativa**, in natural history, a kind of marly

earth, of a dead whitish colour, which, if thrown into water, makes a considerable bubbling and hissing noise, and has, without previous burning, the quality of making a cæment like lime, or plaster of Paris.

**CALX viva**, or **QUICK-LIME**, that whereon no water has been cast, in contradistinction to lime which has been slaked by pouring water on it. See **CHEMISTRY**, *Of lime*.

**CALX**, in anatomy. See **CALCANEUM**.

**CALYCISTÆ**, an appellation given by Linnæus to those botanists who have classed plants according to the different structure of the calyx, or cup of the flower; such was Magnolius.

**CALYPTRA**, among botanists, a thin membranaceous involucre, usually of a conic figure, which covers the parts of fructification. The capsules of most of the mosses have calyptre. See **BOTANY**.

**CALYX**, among botanists, a general term expressing the cup of a flower, or that part of a plant which surrounds and supports the other parts of the flower.

The cups of flowers are very various in their structure, and on that account distinguished by several names, as perianthium, involucre, spathe, gluma, &c. See **BOTANY**.

**CAM**, a river, anciently called Grant, which, arising in Hertfordshire, runs north-east by Cambridge, and afterwards continues its course northwards, to the isle of Ely, where it falls into the river Ouse.

**CAMÆA**, in natural history, a genus of the semipellucid gems, approaching to the onyx structure, being composed of zones, and formed on a crystalline basis; but having their zones very broad and thick, and laid alternately on one another, with no common matter between; usually less transparent, and more debased with earth, than the onyxes.

1. One species of the camæa is the dull-looking onyx, with broad black and white zones; and is the camæa of the moderns, and the Arabian onyx: This species is found in Egypt, Arabia, Persia, and the East Indies. 2. Another species of the camæa is the dull, broad-zoned, green and white camæa, or the jaspî-cameo of the Italians: It is found in the East Indies, and in some parts of America. 3. The third is the hard camæa, with broad white and chestnut-coloured veins. 4. The hard camæa, with bluish, white, and flesh-coloured broad veins, being the fardonix of Pliny's time, only brought from the East Indies.

**CAMAIEU**, a term in painting, when there is only one colour, the lights and shades being of gold, or on a golden and azure ground. It is chiefly used to represent basso-relievos.

**CAMALDULIANS**, a religious order founded by St Romauld, in a little plain, on the mount Apennine, called Camaldalia, situated in the state of Florence.

The manner of life first enjoined this order was, that they dwelt in separate cells, and met together only at the time of prayer: Some of them, during the two lents of the year, observed an inviolable silence; and others, for the space of an hundred days. On Sundays and Thursdays they fed on herbs, and the rest of the

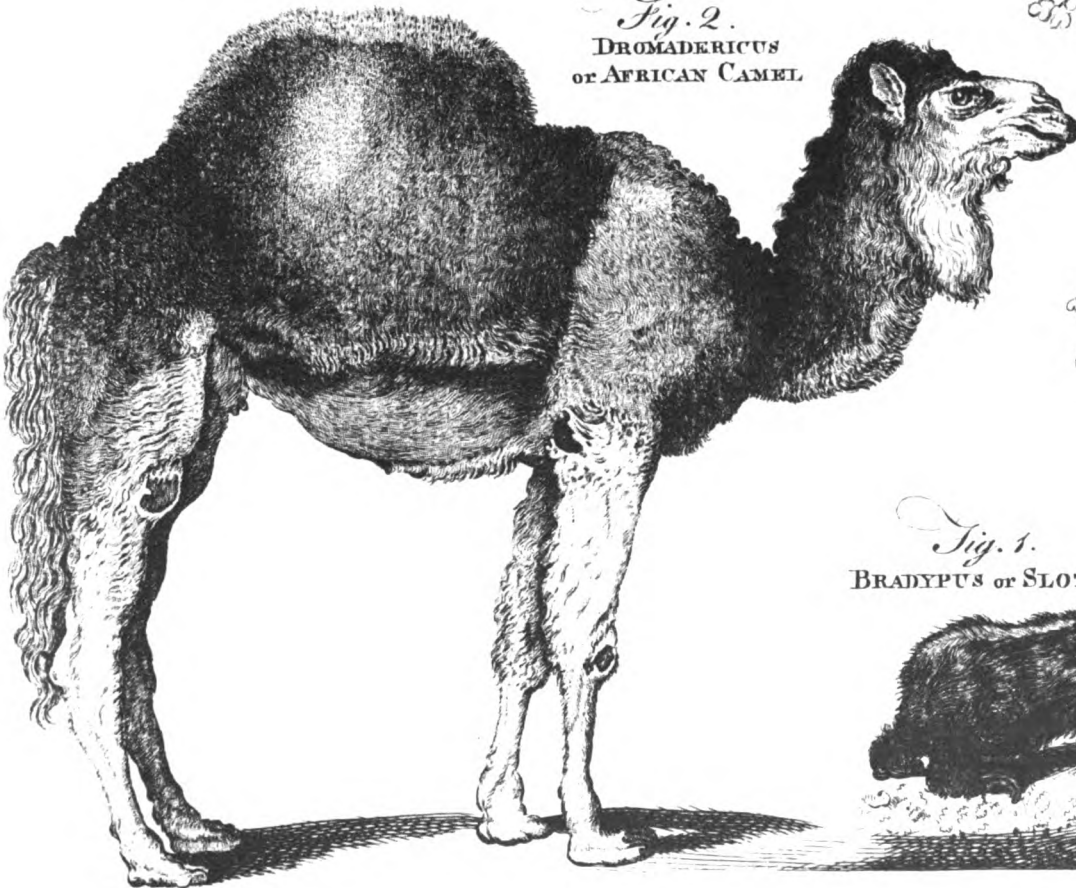




*Fig. 3.*  
BACTRIANUS or BACTRIAN CAMEL



*Fig. 2.*  
DROMADERICUS  
or AFRICAN CAMEL



*Fig. 1.*  
BRADYPUS or SLOTH



the week only on bread and water. These constitutions were, however, a little moderated some time afterwards. This hermitage is now accounted very rich.

**CAMARA**, in botany. See **LANTANA**.

**CAMARANA**, an island of Arabia in the Red sea, situated in 15° N. lat.

**CAMBAIA**, a city of the province of Cambaia, or Guzarat, in the higher peninsula of India; it is a very large city, and had once a great trade, now removed to Surat: E. long. 72°, and N. lat. 23° 30'.

**CAMAYES**, in commerce, cotton lincns made at Bengal, at Madras, and some other places on the coast of Coromandel.

**CAMBER-beam**, among builders, a piece of timber in an edifice, cut archwise, or with an obtuse angle in the middle, commonly used in platforms, as church-leads, and on other occasions where long and strong beams are required.

**CAMBLET**, or **CAMLET**, a plain stuff, composed of a warp and woof, which is manufactured on a loom, with two treddles, as linens and flannels are.

There are camblets of several sorts, some of goat's hair, both in the warp and woof; others, in which the warp is of hair, and the woof half hair and half silk; others again, in which both the warp and the woof are of wool; and lastly, some of which the warp is of wool and the woof of thread. Some are dyed in thread, others are dyed in the piece, others are marked or mixed; some are striped, some weaved or watered, and some figured.

Camblets are proper for several uses, according to their different kinds and qualities; some serve to make garments both for men and women; some for bed-curtains; others for household-furniture, &c.

**CAMBODIA**, the capital of a kingdom of the same name in India, beyond the Ganges: E. long. 104°, N. lat. 12° 30'.

The kingdom of Cambodia extends from 9° to 15° of N. lat. being bounded by the kingdom of Laos on the north, Cochin-china on the east, the Indian ocean on the south, and by the bay of Siam on the west.

**CAMBRAY**, a city in the French Netherlands, situated on the river Schelde, near its source: E. long. 3° 15', and N. lat. 50° 15'.

It is a large and well-built city, considerable for its linen manufacture, especially cambricks, which took their name from hence.

**CAMBRICKS**, a species of very fine white linen, made of flax at Cambray.

**CAMBRIDGE**, the capital of Cambridgeshire, situated upon the river Cam, about fifty-five miles north of London, and sixty north-east of Oxford.

Cambridge is most remarkable on account of its university, which consists of sixteen colleges, wherein are educated about fifteen hundred students. There are fourteen parishes in the town, which is said to contain about six thousand inhabitants.

*New* **CAMBRIDGE**, a town of New England, about three miles west of Boston; likewise remarkable for

an university, consisting of three colleges: W. long. 70° 4', and N. lat. 42°.

**CAMEL**, in zoology. See **CAMELUS**.

**CAMELFORD**, a borough-town of Cornwall, about twenty miles west of Launceston: W. long. 5°, and N. lat. 50° 40'.

It sends two members to parliament.

**CAMELIA**, in botany, a genus of the monadelphia polyandria class. The calix is imbricated, and consists of many leaves, the anterior of which are longest. There is but one species, viz. the japonica, a native of China and Japan.

**CAMELOPARDALIS**, in zoology, the trivial name of a species of cervus. See **CERVUS**.

**CAMELUS**, or **CAMEL**, in zoology, a genus of quadrupeds belonging to the order of pecora. The characters of the camel are these: It has no horns, it has six foreteeth in the under-jaw; the lastarii are wide set, three in the upper, and two in the lower jaw; and there is a fissure in the upper lip, resembling the cleft in the lip of a hare. The species are four, viz. 1. The dromedarius, or African camel, (Plate LIX. fig. 2.) with one bunch or protuberance on the back. It has four callous protuberances on the fore-legs, and two on the hind ones. The hoof, or rather callous skin of their feet, which is softer than the hoofs of other animals, enables the camel to walk along the sandy paths of warm climates with greater ease; by yielding to the pressure, it is not so subject to be injured by friction. The structure and constitution of the camel is admirably adapted to the climate which produces them. It is Africa and Arabia, where this animal is most frequent, and is employed in carrying all kinds of burdens; there is great scarcity of water. The camel has often been observed to travel longer than any other creature without drink. This it is enabled to do, from a singular construction in its stomachs. It is one of the ruminating animals, and has four stomachs. At the top of the second stomach, there are several square holes, which are the orifices of about twenty cavities or sacks, placed between the two membranes which compose the substance of this stomach. These sacks are so many reservoirs which they fill over and above what satisfies their present thirst, and serve for supplying them with water in long journeys through the dry and sandy deserts, where wells or rivers are seldom to be met with. Travellers, when much oppressed with drought, are sometimes obliged to kill their camels, in order to have a supply of drink from these reservoirs. The camel carries very heavy burdens, and travels long, but with a slow pace. They have sometimes been known to travel several days without a fresh supply of water. When fatigued, they lie on their breast. 2. The Bactrianus, or Bactrian camel (fig. 3.), has two bunches on the back, the hindmost of which is by much the largest. It is a native of Africa, and is more rarely to be met with than the dromedary. It is also much swifter in its motion. 3. The glama, or South-American camel-sheep, has a smooth skin, and very short hair; it has a bunch or protuberance on the breast, which se-

- cretes a liquor. They are very impatient of cold; are easily tamed, and carry burdens of about fifty or sixty pounds weight. When restive, they are pushed on by squeezing their testicles. When enraged by their driver, they throw out from their mouth a liquor which corrodes and makes the skin rise into blisters. 4. The pacos, or sheep of Chili, has no bunch on the back. It is covered with a fine valuable wool, which is of a blood-red colour on the back of the animal, and white on the belly. It is unfit for carrying burdens, and is kept principally for the sake of the wool, and the flesh, which is exceedingly well-tasted.
- CAMERA** *obscura*, in optics, a machine representing an artificial eye, wherein the images of external objects are exhibited distinctly, in their native colours, either inverted or erect. See **OPTICS**.
- CAMERARIA**, in botany, a genus of the pentandria monogynia class. The flower of which is a petal of a funnel-form, with a cylindrical long tube, ventricose both at the base and top, and a plane limb divided into five lanceolated segments: The fruit is composed of two oblong follicles, bent horizontally, obtuse at both ends, and sending out a lobe on each side, near the base; they have one cell, with one valve, containing numerous, oval, and imbricated seeds, inserted in a large oval membrane at the base. There are two species, *viz.* the *latifolia*, and *angustifolia*, both natives of America.
- CAMERATED**, among builders, the same with vaulted or arched.
- CAMERET-BAY**, in the province of Britany in France, forms the harbour of Brest. See **BREST**.
- CAMERINO**, a town of the ecclesiastical state in Italy.
- CAMERLINGO**, according to Ducange, signified formerly the pope's or emperor's treasurer: At present, *camerlingo* is nowhere used, but at Rome, where it notes the cardinal who governs the ecclesiastical state, and administers justice. It is the most eminent office at the court of Rome, because he is at the head of the treasury. During a vacation of the papal chair, the cardinal *camerlingo* publishes edicts, coins money, and exerts every other prerogative of a sovereign prince; he has under him a treasurer-general, auditor-general, and twelve prelates called clerks of the chamber.
- CAMERONIANS**, a party of presbyterians, which sprung up in Scotland in the reign of king Charles II. They asserted that the king had forfeited his right to the crown, by breaking the solemn league and covenant, which were the terms on which he received it. They pretended both to dethrone and excommunicate him; and broke out into an open rebellion. Upon the revolution, they were reconciled to the kirk, and their preachers submitted to the general assembly of the church of Scotland, in 1690. That sect is now greatly declined. They are few in number, and split into many parties.
- CAMÉRY**, or **FROUNCE**, in horses. See **FROUNCE**.
- CAMILLE**, and **CAMILLÆ**, in Roman antiquity, a certain number of boys and girls, who assisted in the sacrifices to the gods, but more especially attended the *flamen dialis*.
- CAMIS**, or **KAMIS**, in the Japonese affairs, denote the deified souls of illustrious personages, believed to interest themselves in the welfare of their countrymen: In which sense they answer to the deified heroes of antiquity. See **HERO**.
- CAMISARDS**, a name given by the French to the Calvinists of the Cevennes, who formed a league, and took up arms in their own defence, in 1688.
- CAMLETINE**, a slight stuff, made of hair and coarse silk, in the manner of camblet. It is now out of fashion.
- CAMMIN**, a port-town of Brandenburg-Pomerania in Germany, situated on the eastern mouth of the river Oder, about thirty miles north of Stetin: E. long. 15°, N. lat. 54°.
- CAMP**, the ground upon which an army pitch their tents. It is marked out by the quarter-master general, who appoints every regiment their ground.
- The chief advantages to be minded in chusing a camp for an army, are, to have it near the water, in a country of forage, where the soldiers may find wood for dressing their viuals; that it have a free communication with garrisons, and with a country from whence it may be supplied with provisions; and, if possible, that it be situated on a rising ground, in a dry gravelly soil. Besides, the advantages of the ground ought to be considered, as marshes, woods, rivers, and inclosures; and if the camp be near the enemy, with no river or marsh to cover it, the army ought to be intrenched. An army always encamps fronting the enemy; and generally in two lines, running parallel about five hundred yards distance; the horse and dragoons, on the wings, and the foot in the centre: Sometimes a body of two, three, or four brigades is encamped behind the two lines, and is called the body of reserve. The artillery and bread-wagons are generally encamped in the rear of the two lines. A battalion of foot is allowed eighty or an hundred paces for its camp; and thirty or forty for an interval betwixt one battalion and another. A squadron of horse is allowed thirty for its camp, and thirty for an interval, and more if the ground will allow it.
- The disposition of the Hebrew encampment was at first laid out by God himself. Their camp was of a quadrangular form, surrounded with an inclosure of the height of ten hands-breadth. It made a square of twelve miles in compass about the tabernacle; and within this was another, called the Levites camp. The Greeks had also their camps, fortified with gates and ditches. The Lacedemonians made their camp of a round figure, looking upon that as the most perfect and defensible of any form: We are not, however, to imagine, that they thought this form so essential to a camp, as never to be dispensed with when the circumstance of the place required it. Of the rest of the Grecian camps, it may be observed, that the most valiant of the soldiers were placed at the extremities, the rest in the middle. Thus we learn from Homer, that

that Achilles and Ajax were posted at the ends of the camp before Troy, as bulwarks on each side of the rest of the princes.

The camps of the Romans were generally of an exact square form, or else oblong; though this, without doubt, was often accommodated to the situation of the place. They were always fortified, and a very exact discipline maintained in them, in order to prevent surpises from the enemy.

**CAMP** is also used, by the Siamese, and some other nations in the E. Indies, as the name of the quarters which they assign to the foreigners who come to trade with them.

In these camps; every nation forms, as it were, a particular town, where they carry on all their trade, not only keeping all their ware-houses and shops there, but also live in these camps with their whole families. The Europeans, however, are so far indulged, that at Siam, and almost every where else, they may live either in the cities or suburbs, as they shall judge most convenient.

**CAMPAGNA**, in geography. See **CAMPANIA**.

**CAMPAIGN**, in the art of war, denotes the space of time that an army keeps the field, or is incamped, in opposition to quarters.

**CAMPANIA**, a city of the hither principate in the kingdom of Naples, situated about thirty-five miles south-east of the city of Naples: E. long.  $15^{\circ} 30'$ , N. lat.  $4^{\circ} 45'$ .

**CAMPANIA**, or **CAMPAGNA DI ROMA**, a province of the pope's territories in Italy, extending from the city of Rome south-east, as far as the frontiers of the kingdom of Naples.

**CANPANIFORM**, or **CAMPANULATED**, an appellation given to flowers resembling a bell.

**CAMPANINI**, a name given to a marble of Italy, dug out of the mountains of Carrara, because when it is worked it resounds like a bell.

**CAMPANULA**, or **BELL-FLOWER**, in botany, a genus of the pentandria monogynia class. The corolla is campaniform or bell-shaped, the bottom of which is closed with five valvular nectaria; the stigma is trifid; and the capsule is below the flower, and opens at the sides. There are forty-one species of campanula, only nine of which are natives of Britain, *viz* the rotundifolia, or lesser round-leaved bell flower; the patula, or field bell-flower; the uniloba, or mountain bell-flower; the rapunculus, or rampions; the latifolia, or giant throat-wort; the tracheluna, great throat-wort, or Canterbury bells; and the glomerata, lesser throat-wort, or Canterbury-bells.

**CAMPBELL-TOWN**, a parliament town of Argyleshire in Scotland, situated on the eastern shore of Kintire, about ten miles west of the island of Arran: W. long.  $5^{\circ} 10'$ , N. lat.  $55^{\circ} 35'$ .

**CAMPDEN**, a market-town in Gloucestershire, about eighteen miles north-east of Gloucester: W. long.  $1^{\circ} 50'$ , and N. lat.  $52^{\circ}$ .

**CAMPEACHY**, or **CAMPECHY**, a town of the province of Jucatan, on the bay or gulf of Mexico: W. long.  $93^{\circ}$ , N. lat.  $19^{\circ}$ .

**CAMPEACHY-WOOD**, in botany. See **HÆMATOXYLUM**.

**CAMPEN**, a port-town, in the province of Overijssel, in the united Netherlands, near the mouth of the river Issel, about forty-two miles north-east of Amsterdam: E. long.  $5^{\circ} 40'$ , and N. lat.  $52^{\circ} 35'$ .

**CAMPHOR**, or **CAMPHERE**, a solid concrete juice extracted from the wood and roots of the laurus camphora, which grows in Japan. The camphor is extracted in the same way by which we extract essential oils. As it first sublimes from the wood, it appears brownish, composed of semipellucid grains mixed with dirt. In this state it is exported by the Dutch, and purified by a second sublimation; after which it is reduced to loaves, probably by fusion in close vessels, and in this form it is sold to us. Pure camphor is very white, pellucid, somewhat unctuous to the touch; of a bitterish, aromatic, acrid taste, yet accompanied with a sense of coolness. It has a fragrant smell, somewhat like that of rosemary, but much stronger. It is totally volatile and inflammable; soluble in vinous spirits, oils, and mineral acids; but not in water, alkaline liquors, or the vegetable acids. Camphor is esteemed one of the most efficacious diaphoretics, and has long been celebrated in fevers, malignant and epidemical distempers. In deliria, where opiates fail of procuring sleep, this medicine frequently succeeds.

*Artificial* **CAMPHOR** is prepared with gum-sandarach and white vinegar distilled, kept twenty days in horse-dung, and afterwards exposed a month to the sun to dry, at the end of which the camphor is found in form of the crust of a white loaf. This is also called juniper-gum, and mastic.

**CAMPHOR-TREE**. See **LAURUS**.

**CAMPHORATA**, in botany. See **POLYCNEMUM**.

**CAMPION**, in botany. See **LYCHNIS**.

**CAMPOIDES**, in botany. See **SCORPIURUS**.

**CAMPREDON**, a town of Catalonia, in Spain, about fifty miles north of Barcelona: E. long.  $2^{\circ}$ , and N. lat.  $42^{\circ} 20'$ .

**CAMPUS MARI**, in ancient customs, an anniversary assembly of our ancestors held on May-day, when they confederated together for defence of the kingdom against all its enemies.

**CAMPUS MARTIUS**, among the Romans, a field, by the side of the Tiber, where the youth exercised themselves in warlike exercises. It was so called, on account of a temple that stood on it, consecrated to the god Mars. The consuls Brutus and Collatinus made it the place for holding the comitia or assemblies of the people, and in after-times it was adorned with a great quantity of fine statues.

**CAMUS**, a person with a low flat nose, hollowed in the middle.

The Tartars are great admirers of camus beauties. Rubruquis observes, that the wife of the great Jenghis Kan, a celebrated beauty, had only two holes for a nose.

**CAN**, in the sea-language, as can-pump, a vessel, where with seamen pour water into the pump to make it go.

**CAN-BUOY**, a larger size of buoy, used to discover dangerous

genous rocks and shelves, by being placed over them.  
CAN-HOOK. See HOOK.

CANADA, or NEW FRANCE, an extensive tract of North America, bounded by New Britain and the British colonies on Hulfon's bay, on the north; by the river of St Lawrence, the Iroquois, or five Indian nations, the Huron and Illinois lakes, on the east and south; and by unknown lands, on the west. Its chief town is Quebec.

CANAL of communication, an artificial cut in the ground, supplied with water from rivers, springs, &c. in order to make a navigable communication betwixt one place and another.

The particular operations necessary for making artificial navigations depend upon a number of circumstances. The situation of the ground; the vicinity or connection with rivers; the ease or difficulty with which a proper quantity of water can be obtained; these and many other circumstances necessarily produce great variety in the structure of artificial navigations, and augment or diminish the labour and expence of executing them. When the ground is naturally level, and unconnected with rivers, the execution is easy, and the navigation is not liable to be disturbed by floods; but, when the ground rises and falls, and cannot be reduced to a level, artificial methods of raising and lowering vessels must be employed; which likewise vary according to circumstances.

A kind of temporary sluices are sometimes employed for raising boats over falls or shoals in rivers by a very simple operation. Two posts or pillars of masonry, with grooves, are fixed, one on each bank of the river, at some distance below the shoal. The boat having passed these posts, planks are let down across the river by pulleys into the grooves, by which the water is dammed up to a proper height for allowing the boat to pass up the river over the shoal.

The Dutch and Flemings at this day, sometimes when obstructed by cascades, form an inclined plane or rolling-bridge upon dry land, alongst which their vessels are drawn from the river below the cascade into the river above it. This, it is said, was the only method employed by the ancients, and is still used by the Chinese, who are said to be entirely ignorant of the nature and utility of locks. These rolling-bridges consist of a number of cylindrical rollers which turn easily on pivots, and a mill is commonly built near by, so that the same machinery may serve the double purpose of working the mill and drawing up vessels.

A Lock is a basin placed lengthwise in a river or canal, lined with walls of masonry on each side, and terminated by two gates, placed where there is a cascade or natural fall of the country; and so constructed, that the basin being filled with water by an upper sluice to the level of the waters above, a vessel may ascend through the upper gate; or the water in the lock being reduced to the level of the water at the bottom of the cascade, the vessel may descend through the lower gate; for when the waters are brought to a level on either side, the gate on that side may be easily opened.

But as the lower gate is strained in proportion to the depth of water it supports, when the perpendicular height of the water exceeds 12 or 13 feet, more locks than one become necessary. Thus, if the fall be 17 feet, two locks are required, each having  $8\frac{1}{2}$  feet fall; and if the fall be 26 feet, three locks are necessary, each having 8 feet 8 inches fall. The side-walls of a lock ought to be very strong. Where the natural foundation is bad, they should be founded on piles and platforms of wood: They should likewise stop outwards, in order to resist the pressure of the earth from behind.

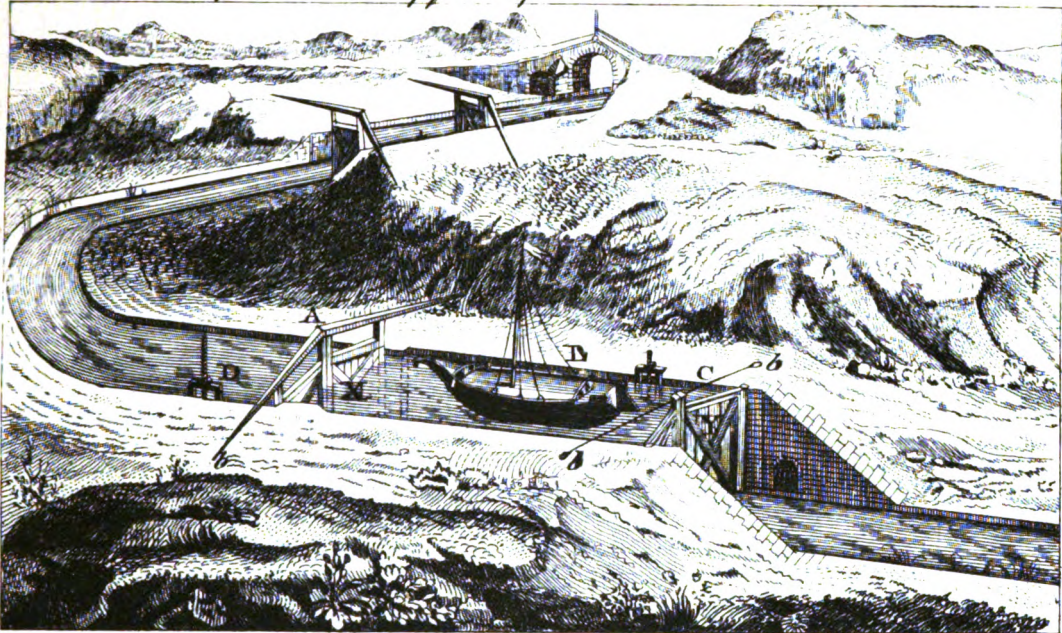
Plate LX. fig. 1. A perspective view of part of a canal: the vessel L, within the lock A C.—Fig. 2. Section of an open lock: the vessel L about to enter.—Fig. 3. Section of a lock full of water: the vessel L raised to a level with the water in the superior canal.—Fig. 4. Ground section of a lock. L, a vessel in the inferior canal. C, the under gate. A, the upper gate. G H, a subterraneous passage for letting water from the superior canal run into the lock. K F, a subterraneous passage for water from the lock, to the inferior canal.

X and Y (fig. 1.) are the two flood-gates, each of which consists of two leaves, resting upon one another, so as to form an obtuse angle, in order the better to resist the pressure of the water. The first (X) prevents the water of the superior canal from falling into the lock; and the second (Y) dams up and sustains the water in the lock. These flood-gates ought to be very strong, and to turn freely upon their hinges. In order to make them open and shut with ease, each leaf is furnished with a long lever A b, A b; C b, C b. They should be made very tight and close, that as little water as possible may be lost.

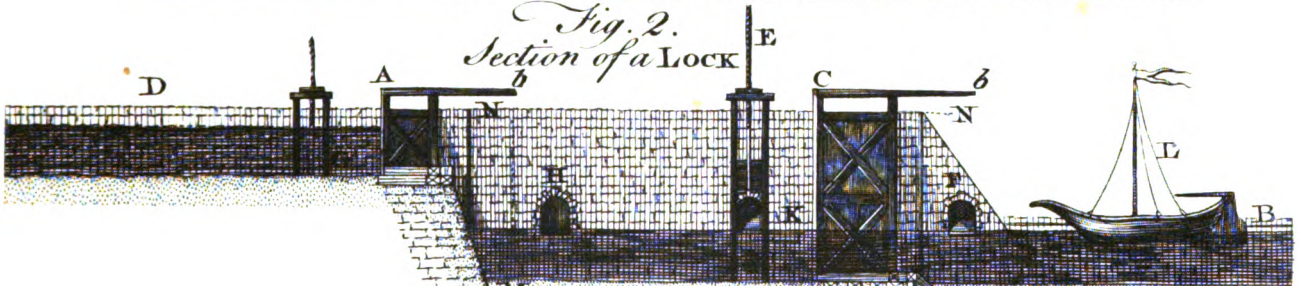
By the subterraneous passage G H (fig. 2, 3, & 4) which descends obliquely, by opening the sluice G, the water is let down from the superior canal D, into the lock, where it is stopt and retained by the gate C when shut, till the water in the lock comes to be on a level with the water in the superior canal D; as represented, fig. 3. When, on the other hand, the water contained by the lock is to be let out, the passage G H must be shut by letting down the sluice G, the gate A must be also shut, and the passage K F opened by raising the sluice K: A free passage being thus given to the water, it descends through K F, into the inferior canal, until the water in the lock is on a level with the water in the inferior canal B; as represented, fig. 2.

Now, let it be required to raise the vessel L (fig. 2.) from the inferior canal B, to the superior one D; if the lock happens to be full of water, the sluice G must be shut, and also the gate A, and the sluice K opened, so that the water in the lock may run out till it is on a level with the water in the inferior canal B. When the water in the lock comes to be on a level with the water at B, the leaves of the gate C are opened by the levers C b, which is easily performed, the water on each side of the gate being in equilibrio; the vessel then sails into the lock. After this the gate C, and the sluice

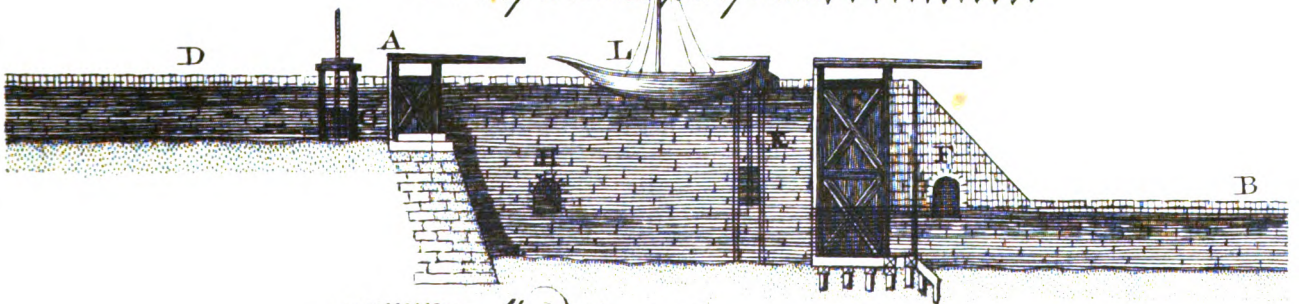
*Fig. 1.*  
*Perspective VIEW of part of a CANAL with Locks*



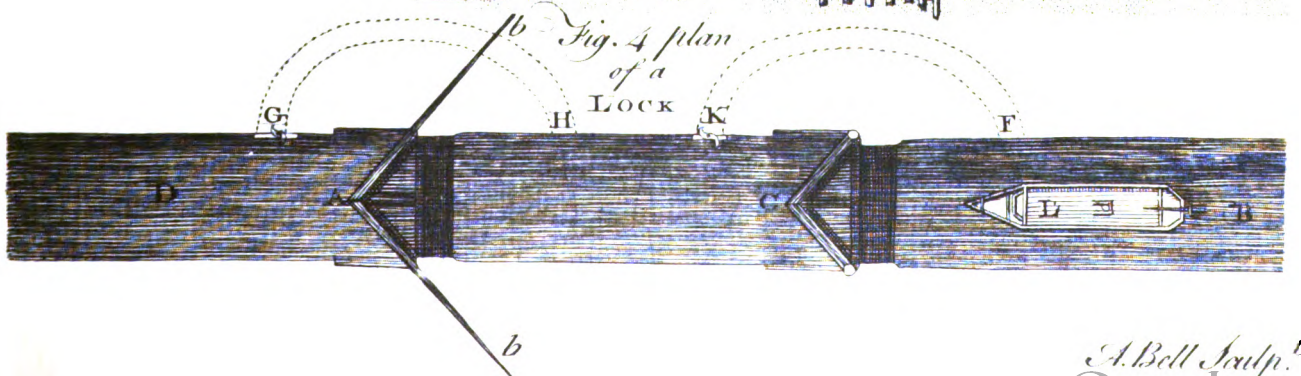
*Fig. 2.*  
*Section of a LOCK*



*Fig. 3.* *Section of a Lock full of Water*



*Fig. 4.* *Plan of a Lock*







sluice K are shut, and the sluice G opened, in order to fill the lock, till the water in the lock, and consequently the vessel, be upon a level with the water in the superior canal D; as is represented in fig. 3. The gate A is then opened, and the vessel passes into the canal D.

Again, let it be required to make a vessel descend from the canal D, into the inferior canal B. If the lock is empty, as in fig. 2. the gate C and sluice K must be shut, and the upper sluice G opened, so that the water in the lock may rise to a level with the water in the upper canal D. Then open the gate A, and let the vessel pass through into the lock. Shut the gate A and the sluice G: then open the sluice K, till the water in the lock be on a level with the water in the inferior canal; then the gate C is opened, and the vessel passes along into the canal B, as was required.

It is almost needless to spend time in enumerating the many advantages which necessarily result from artificial navigations. Their utility is now so apparent, that most nations in Europe give the highest encouragement to undertakings of this kind where-ever they are practicable. The advantages of navigable canals did not escape the observation of the ancients. From the most early accounts of society we read of attempts to cut through large isthmuses, in order to make a communication by water, either betwixt different nations, or distant parts of the same nation, where land-carriage was long and expensive. Herodotus relates, that the Cnidians, a people of Caria in Asia Minor, designed to cut the Isthmus which joins that Peninsula to the continent; but were superstitious enough to give up the undertaking, because they were interdicted by an oracle. Several Kings of Egypt attempted to join the Red-sea to the Mediterranean. Cleopatra was exceedingly fond of this project. Soliman II. emperor of the Turks, employed 50,000 men in this great work. This canal was completed under the caliphate of Omar, but was afterwards allowed to fall into disrepair; so that it is now difficult to discover any traces of it. Both the Greeks and Romans intended to make a canal across the Isthmus of Corinth, which joins the Morea and Achaia, in order to make a navigable passage by the Ionian sea into the Archipelago. Demetrius, Julius Cæsar, Caligula, and Nero, made several unsuccessful efforts to open this passage. But, as the ancients were intirely ignorant of the use of water-locks, their whole attention was employed in making level cuts, which is probably the principal reason why they so often failed in their attempts. Charlemagne formed a design of joining the Rhine and the Danube, in order to make a communication between the ocean and the Black-sea, by a canal from the river Almutz which discharges itself into the Danube, to the Reditz, which falls into the Maine, and this last falls into the Rhine near Mayence: For this purpose he employed a prodigious number of workmen; but he met with so many obstacles from different quarters, that he was obliged to give up the attempt.

The French at present have many fine canals: That of Briare was begun under Henry IV. and finished under the direction of cardinal Richelieu in the reign of Lewis

XIII. This canal makes a communication betwixt the Loire and the Seine by the river Loing. It extends eleven French great leagues from Briare to Montargis. It enters the Loire a little above Briare, and terminates in the Loing at Cepoi. There are forty-two locks on this canal.

The canal of Orleans, for making another communication between the Seine and the Loire, was begun in 1675, and finished by Philip of Orleans, regent of France, during the minority of Lewis XV. and is furnished with twenty locks. It goes by the name of the canal of Orleans; but it begins at the village of Combleux, which is a small French league from the town of Orleans.

But the greatest and most useful work of this kind is the junction of the ocean with the Mediterranean by the canal of Languedoc. It was proposed in the reigns of Francis I. Henry IV. and was undertaken and finished under Lewis XIV. It begins with a large reservoir 4000 paces in circumference, and 24 feet deep, which receives many springs from the mountain Noire. This canal is about 64 leagues in length, is supplied by a number of rivulets, and is furnished with 104 locks, of about eight feet rise each. In some places it passes over bridges of vast height; and in others it cuts through solid rocks for 1000 paces. At one end it joins the river Garonne near Thoulouse, and terminates at the other in the lake Tau, which extends to the port of Cette. It was planned by Francis Riquet in the 1666, and finished before his death, which happened in the 1680.

In the Dutch, Austrian, and French Netherlands, there is a very great number of canals; that from Bruges to Ostend carries vessels of 200 tons.

The Chinese have also a great number of canals; that which runs from Canton to Pekin, extends about 325 miles in length, and was executed about 800 years ago.

It would be an endless task to describe the numberless canals in Holland, Russia, Germany, &c. We shall therefore confine ourselves to those that are either already finished, or at present executing in our own country.

As the promoting of commerce is the principal intention of making canals, it is natural to expect that their frequency in any nation should bear some proportion to the trade carried on in it, providing the situation of the country will admit of them. The present state of England and Scotland confirms this observation. Though the Romans made a canal between the Nyne, a little below Peterborough, and the Witham, three miles below Lincoln, which is now almost entirely filled up, yet it is not long since canals were revived in England. They are now however become very numerous, particularly in the counties of York, Lincoln, and Cheshire. Most of the counties betwixt the mouth of the Thames and the Bristol channel are connected together either by natural or artificial navigations; those upon the Thames and Isis reaching within about twenty miles of those upon the Severn. The duke of Bridgewater's canal in Cheshire runs twenty-seven miles on a perfect level; but at Barton it is carried by a very high aqueduct bridge over the Irwell, a navigable river; so that it is common for vessels to be passing at the same time both under and above the bridge.

bridge. It is likewise cut some miles into the hills, where the Duke's coal mines are wrought.

Though a navigable communication between the rivers Forth and Clyde in Scotland had been long talked of, it was never considered with a view to execution till the year 1761, when the ground was surveyed by Mr Smeaton, at the desire of the trustees for fisheries and manufactures in Scotland. From Mr Smeaton's survey and report, the practicability of this canal was fully demonstrated. But, after the scheme became an object of general attention, it was found that a canal of larger dimensions than the one originally proposed would be productive of still greater advantages to the nation. Mr Smeaton was therefore directed to make a second survey, and to report to the intended proprietors an estimate of the expence of making a canal 24 feet broad at bottom, 54 at top, containing seven feet deep of water, and extending from the Forth to the Clyde, a distance of about 31 miles, with a collateral branch to the town of Glasgow, which is about six miles, and another from Bainsford to the river Carron below Carron-works, making in all about 37 miles. This report was approved of, an act of parliament was obtained, and the canal is now cutting upon this very plan. It begins at the Holemerrie in the mouth of the Carron, and terminates at Danmuir-burn-foot on the river Clyde, about seven miles below Glasgow. Above seven miles are already cut, from the Holemerrie westward; a number of hands are likewise employed at the point of partition in Dollater-bog, and the whole is expected to be finished in five years. At the point of partition, which is 168 feet above the level of the sea at low water, a very large reservoir is to be made for supplying the canal; and the vessels are to be raised and lowered by means of 41 locks. Where the course of the canal is intersected by burns or rivers, it is to be carried over them by aqueduct-bridges; three of these bridges will be large, and require considerable labour and expence, *viz.* one over the Grangeburn, one over Bony-mill-burn, and a third over the Kelvin in the Glasgow branch. The expence of executing the whole is computed to be about 150,000 l.

Sea-vessels, about 20 feet wide and 60 feet long, and carrying 70 or 80 tons, may pass along by this canal from the one frith to the other. But it will admit a free passage to vessels of 140 tons, provided they be built in the manner of the flat vessels used by the Dutch. The toll-duty, allowed by the act of parliament, is not to exceed 2 d. a ton *per* mile. Privileged goods, such as lime and lime-stone, are to pay only one third of the usual toll-duty; stones, gravel, and other materials for making or repairing roads, likewise dung, soil, marle, and all sorts of manure, are exempted from paying any toll-duty, provided they do not pass any lock but when the water shall flow over the place made for discharging the overplus-water in the canal.

We must not conclude this article without observing, that in Ireland also the utility of artificial navigations has not been unattended to. Several canals are there making; in particular, one from Loch-Neach to Newry, about 20 miles; and another from the river Shannon to Dublin, about 70 miles.

**CANAL**, in anatomy, a duct or passage through which any of the juices flow.

**CANARIES**, islands, to the number of seven, situated in the Atlantic ocean, between 12° 21' W. long. and between 27° and 29° N. lat. the most easterly of them lying about 150 miles from Cape Non, on the coast of Biledulgerid, in Africa.

**CANARY**, properly so called, is a considerable island, about 150 miles in circumference; the chief town of which is Palma, from whence comes the excellent palm-sack, and other rich wines.

It lies in 16° W. long. and between 27° and 29° N. lat.

**CANARY-bird**. See **FRINGILLA**.

**CANCALE**, a small town of France, near St Malo's, where ships may ride in eight fathoms water, with a sandy bottom.

**CANCELIER**, in falconry, is when a light-brown hawk, in her stooping, turns two or three times upon the wing, to recover herself, before she seizes.

**CANCELLI**, a term used to denote lattice-windows, or those made of cross-bars, disposed lattice-wise; it is also used for rails or ballusters, inclosing the communion-table, a court of justice, and the like, and for the net-work in the inside of hollow bones.

**CANCER**, or **CRAB**, in zoology, a genus of insects belonging to the order of insects aptera. The generic characters are these: They have eight legs, (seldom ten or six), besides the two large claws which answer the purpose of hands. They have two eyes at a considerable distance from each other, and for the most part supported by a kind of pedunculi or foot-stalks; the eyes are likewise elongated and moveable. They have two clawed palpi; and the tail is jointed. There are no less than 87 species of cancer, distinguished principally by the length of their tails and the margins of their breasts. This genus includes the lobster, shrimp, &c.

**CANCER**, in medicine, a roundish, unequal, hard, and livid tumour, generally seated in the glandulous parts of the body, supposed to be so called, because it appears at length, with turgid veins shooting out from it, so as to resemble, as it is thought, the figure of a crab-fish; or, as others say, because, like that fish, where it has once got, it is scarce possible to drive it away. See **MEDICINE**, and **SURGERY**.

**CANCER**, in astronomy, one of the twelve signs of the zodiac, represented on the globe in the form of a crab, and thus marked ( $\var�$ ) in books.

**Tropic of CANCER**, in astronomy, a lesser circle of the sphere parallel to the equator, and passing through the beginning of the sign cancer.

**CANCHERIZANTE**, or **CANCHERIZATO**, in the Italian music, a term signifying a piece of music that begins at the end, being the retrograde motion from the end of a song, &c. to the beginning.

**CANDAROR**, the capital of a territory of the same name, subject to Persia: E. long. 67°, and N. lat. 33°.

**CANDIA**, the modern name of Crete, an island situated in

in the Mediterranean sea, between  $22^{\circ}$  and  $27^{\circ}$  E. long. and between  $35^{\circ}$  and  $36^{\circ}$  N. lat.

There is no river of any consequence in the whole island, which is watered by a multitude of rivulets; whereof Lethe is one. Here too is mount Ida, so much celebrated in the writings of the ancients.

**CANDIA**, or **MUTIUM**, is the capital of the above island, situated on its northern coast, in  $25^{\circ}$  E. long. and  $35^{\circ} 30'$  N. lat.

**CANDIDATE**, a person who aspires to some public office.

In the Roman commonwealth, they were obliged to wear a white gown, during the two years of their soliciting for a place. This garment, according to Plutarch, they wore without any other cloaths, that the people might not suspect they concealed money for purchasing votes; and also, that they might the more easily show to the people, the scars of those wounds they had received in fighting for the defence of the commonwealth.

**CANDIDATI MILITES**, an order of soldiers, among the Romans, who served as the emperor's body-guards, to defend him in battle. They were the tallest and strongest of the whole troops, and most proper to inspire terror. They were called *candidati*, because clothed in white, either that they might be more conspicuous, or because they were considered in the way of preferment.

**CANDISH**, a province of the hither India, bounded by Chitor and Malva, on the north; by Orixa, on the east; by Decan, on the south; and by Guzurat, on the west: It is subject to the Mogul.

**CANDLE**, a small taper of tallow, wax, or spermaceti; the wick of which is commonly of several threads of cotton, spun and twisted together.

A tallow-candle, to be good, must be half sheeps, and half bullocks tallow; for hogs tallow makes the candle gutter, and always gives an offensive smell, with a thick black smoke. The wick ought to be pure, sufficiently dry, and properly twisted; otherwise the candle will emit an unconstant vibratory flame, which is both prejudicial to the eyes, and insufficient for the distinct illumination of objects.

There are two sorts of tallow-candles; the one dipped, the other moulded: The former are the common candles; the others are the invention of the sieur le Brege at Paris.

As to the method of making candles, in general; After the tallow has been weighed, and mixed in the due proportions, it is cut into very small pieces, that it may melt the sooner; for the tallow in lumps, as it comes from the butchers, would be in danger of burning or turning black, if it were left too long over the fire. Being perfectly melted and skimmed, they pour a certain quantity of water into it, proportionable to the quantity of tallow. This serves to precipitate, to the bottom of the vessel, the impurities of the tallow, which may have escaped the skimmer. No water, however, must be thrown into the tallow designed for the three first dips; because the wick, being still quite dry, would imbibe the water, which makes

the candles crackle in burning, and renders them of bad use. The tallow, thus melted, is poured into a tub, through a coarse sieve of horse-hair, to purify it still more, and may be used after having stood three hours. It will continue fit for use twenty-four hours in summer, and fifteen in winter.

The wicks are made of spun cotton, which the tallow-chandlers buy in skains, and which they wind up into bottoms or clues. Whence they are cut out, with an instrument contrived on purpose, into pieces of the length of the candle required; then put on the sticks or broaches, or else placed in the moulds, as the candles are intended to be either dipped or moulded. Wax-candles are made of a cotton or flaxen wick, slightly twisted, and covered with white or yellow wax. Of these, there are several kinds; some of a conical figure, used to illumine churches, and in processions, funeral ceremonies, &c. See **TAPER**.

Others of a cylindrical form, used on ordinary occasions.

The first are either made with a ladle or the hand.

To make wax candles with the ladle.

The wicks being prepared, a dozen of them are tied by the neck, at equal distances, round an iron circle, suspended directly over a large basin of copper tinned, and full of melted wax: A large ladle full of this wax is poured gently on the tops of the wicks one after another, and this operation continued till the candle arrive at its destined bigness; with this precaution, that the three first ladles be poured on at the top of the wick, the fourth at the height of  $\frac{1}{4}$ , the fifth at  $\frac{1}{2}$ , and the sixth at  $\frac{3}{4}$ , in order to give the candle its pyradimal form. Then the candles are taken down, kept warm, and rolled and smoothed upon a walnut-tree table, with a long square instrument of box, smooth at the bottom.

As to the manner of making wax-candles by the hand, they begin to soften the wax, by working it several times in hot water, contained in a narrow, but deep caldron. A piece of the wax is then taken out, and disposed by little and little, around the wick, which is hung on a hook in the wall, by the extremity opposite to the neck; so that they begin with the big end, diminishing still as they descend towards the neck. In other respects, the method is nearly the same as in the former case. However, it must be observed, that in the former case, water is always used to moisten the several instruments, to prevent the wax from sticking; and in the latter, oil of olives, or lard, for the hands, &c. The cylindrical wax-candles are either made, as the former, with a ladle, or drawn. Wax-candles drawn, are so called, because actually drawn in the manner of wire, by means of two large rollers of wood, turned by a handle, which turning backwards and forwards several times, pass the wick through melted wax contained in a brass basin, and at the same time through the holes of an instrument like that used for drawing wire fastened at one side of the basin.

Makers of candles are not to use melting-houses, without due entry thereof at the excise-office, on pain

of

of 1001; and to give notice of making candles to the excise-officer for the duties, and of the number, &c. or shall forfeit 50*l*. Removing the candles before weighed by the officer, or mixing them with others, is likewise liable to penalties.

**CANDLE** is also a term in medicine, and is reckoned among the instruments of surgery. Thus the *candela fumalis*, or the *candela pro fustitu odorata*, is a mass of an oblong form, consisting of odoriferous powders, mixed up with a third, or more, of the charcoal of willow or lime-trec, and reduced to a proper consistence with a mucilage of guai-tragacanth, ladanum, or turpentine. It is intended to excite a grateful smell without any flame, to correct the air, to fortify the brain, and to excite the spirits.

**Medicated CANDLE**, or **BOUGIE**, in surgery, a small stick of wax in form of a candle, which surgeons introduce into the urethra, either to dilate it and keep it open, or to consume carnosities. There are two sorts of these candles, the one simple, and the other compound. The simple are made of wax, of cat-gut, or even of lead; and the intention of them is to keep the canal of the urethra properly distended. Their thickness, therefore, should be proportioned to the diameter of that canal. The compound bougies are loaded with some medicine capable of producing a suppuration, or of destroying carnosities and excrescences in the urethra. See **SURGERY**.

**CANDLE**. Sale or auction by inch of candle, is when a small piece of candle being lighted, the bystanders are allowed to bid for the merchandise that is selling; but the moment the candle is out, the commodity is adjudged to the last bidder.

There is also an excommunication by inch of candle; when the sinner is allowed to come to repentance while a lighted candle continues burning; but after it is consumed, he remains excommunicated to all intents and purposes.

**CANDLE-BERRY-TREE**, in botany. See **MYRICA**.

**CANDLEMAS**, a feast of the church held on the second day of February, in honour of the purification of the Virgin Mary. It is borrowed from the practice of the ancient Christians, who on that day used abundance of lights both in their churches and processions, in memory, as is supposed, of our Saviour's being, on that day, declared by Simeon, "to be a light to lighten the Gentiles." In imitation of this custom, the Roman catholics, on this day, consecrate all the tapers and candles which they use in their churches during the whole year. At Rome, the pope performs that ceremony himself, and distributes wax-candles to the cardinals and others, who carry them in procession through the great hall of the pope's palace. This ceremony was prohibited in England, by an order of council in 1548.

**CANDLESTICK**, an instrument to hold a candle, made in different forms, and of all sorts of matter.

The golden candlestick was one of the sacred utensils made by Moses to be placed in the Jewish tabernacle. It was made of hammered gold, a talent in weight. It consisted of seven branches, supported by

a base or foot. These branches were adorned at equal distances with six flowers like lilies, and with as many bowls and knobs placed alternately. Upon the stock and six branches of the candlestick, were the golden lamps, which were immoveable, wherein were put oil and cotton.

These seven lamps were lighted every evening, and extinguished every morning. The lamps had their tongs or snuffers to draw the cotton in or out, and dishes underneath them to receive the sparks and droppings of the oil. This candlestick was placed in the antichamber of the sanctuary on the south-side, and served to illuminate the altar of perfume, and the table of the shew-bread. When Solomon had built the temple of the Lord, he placed in it ten golden candlesticks, of the same form as that described by Moses, five on the north, and five on the south-side of the holy. But after the Babylonish captivity, the golden candlestick was again placed in the temple, as it had been before in the tabernacle by Moses. This sacred utensil, upon the destruction of the temple by the Romans, was lodged in the temple of Peace, built by Vespasian; and the representation of it is still to be seen on the triumphal arch at the foot of mount Palatine, on which Vespasian's triumph is delineated.

**Water-CANDLESTICK**, a kind of fountain, the spout of which is raised upon a pedestal in form of a large balustrade, which carries a small basin like a table or stand, from which the water falls into a larger basin, level with the alleys in a garden.

**CANDY**, in geography, the capital of the island of Ceylon, situated in the middle of the island: E. long. 79°, N. lat. 8°.

**CANDY**, or **Sugar-CANDY**, a preparation of sugar, made by melting and crystalizing it six or seven times over, to render it hard and transparent. It is of three kinds, white, yellow, and red. The white comes from the loaf-sugar, the yellow from the cassonado, and the red from the muscovado.

**CANDYING**, in pharmacy, the act of preserving simples in substance, by boiling them in sugar.

The performance of this originally belonged to the apothecaries, but is now become a part of the business of a confectioner.

**CANE**, in botany. See **ARUNDO**.

**CANE** denotes also a walking-stick. It is customary to adorn it with a head of gold, silver, agate, &c. Some are without knots, and very smooth and even; others are full of knots, about two inches distant from each other. These last have very little elasticity, and will not bend so well as the others.

Canes of Bengal, are the most beautiful which the Europeans bring into Europe. Some of them are so fine, that people work them into vessels or bowls, which being varnished over in the inside with black or yellow lacca, will hold liquors as well as glass or china-ware does, and the Indians use them for that purpose.

**CANE** is also the name of a long measure, which differs according to the several countries where it is used.

At Naples, the cane is equal to 7 feet  $3\frac{1}{2}$  inches English

English measure: The cane of Tholouse and the upper Languedoc is equal to the varre of Arragon, and contains 5 feet 8 $\frac{1}{2}$  inches; at Montpellier, Provence, Dauphine, and the lower Languedoc, to 6 English feet 5 $\frac{1}{2}$  inches.

**CANEA**, a sea-port town on the north side of Candia, esteemed the second in the island. It is a pretty good harbour, but the fortifications are out of repair: E. long. 24°, N. lat. 35° 36'.

**CANEPHORÆ**, in Grecian antiquity, virgins who, when they became marriageable, presented certain baskets full of little curiosities to Diana, in order to get leave to depart out of her train, and change their state of life.

**CANEPHORIA**, in Grecian antiquity, a ceremony which made part of a feast celebrated by the Athenian virgins, on the eve of their marriage-day.

At Athens, the canephoria consisted in this; that the maid, conducted by her father and mother, went to the temple of Minerva, carrying with her a basket full of presents, to engage the goddess to make the marriage-state happy; or, as the scholiast of Theocritus has it, the basket was intended as a kind of honourable amends made to that goddess, the protectrix of virginity, for abandoning her party; or a ceremony to appease her wrath. Suidas calls it a festival in honour of Diana.

**CANEPHORIA** is also the name of a festival of Bacchus, celebrated particularly by the Athenians, on which the young maids carried golden baskets full of fruit, which baskets were covered, to conceal the mystery from the uninitiated.

**CANETO**, a fortified town of the duchy of Mantua, situated on the Oglio, about twelve miles south-west of Mantua: E. long. 10° 50', N. lat. 45°.

**CANG**, a gulf or sea, lying between China and Tartary, at the east end of the long wall.

**CANICULA**, in ichthyology, the trivial name of a species of *squalus*. See *SQUALUS*.

**CANICULA**, or **CANICULUS**, in astronomy. See *ASTRONOMY, Of fixed stars*.

It is also a name given to one of the stars of the constellation canis major, called the dog-star, and by the Greeks, *siurus*.

**CANICULAR days**, commonly called dog-days, a certain number of days preceding and ensuing the heliacal rising of canicula, or the dog-star, in the morning. The Ethiopians and Egyptians began their year at the rising of the dog-star, reckoning to its rise again the next year, which is called the *annus canarius*. The Romans supposed it to be the cause of the sultry weather usually felt in the dog-days; and therefore sacrificed a brown dog every year at its rising, to appease its wrath.

The dog-days begin towards the end of July, and end the beginning of September.

**CANINE**, whatever partakes of, or has any relation with the nature of a dog. Thus,

**CANINE teeth**, are two sharp-edged teeth in each jaw; one on each side, placed between the incisors and molars.

**CANIS**, or **DOG**, in zoology, a genus of quadrupeds,

belonging to the order of *feræ*. The characters of the dog are these: He has six fore-teeth in the upper jaw, those in the sides being longer than the intermediate ones, which are lobated; in the under jaw there are likewise six fore-teeth, those on the sides being lobated. He has six grinders in the upper, and seven in the lower jaw. The teeth called dog-teeth are four, one on each side, both in the lower and upper jaw; they are sharp-pointed, bent a little inward, and stand at a distance from any of the rest.

There are nine species of this genus, *viz.* 1. The familiar, or domestic dog, is distinguished from the other species, by having his tail bent to the left side; which mark is so singular, that perhaps the tail of no other quadruped is bent in this manner. Of this species there are a great number of varieties. Linnæus enumerates eleven, and Bouffon gives figures of no less than twenty-seven, *viz.* the molossus, or mastiff, which is about the size of a wolf, with the sides of the lips hanging down, and a full robust body. The large Danish dog, differs only from the former in being fuller in the body, and generally of a larger size. The grey-hound is likewise the same with the mastiff; but its make is more slender and delicate. Indeed the difference betwixt these three dogs, although perfectly distinguishable at first sight, is not greater than that betwixt a Dutchman, a Frenchman, and an Italian. The shepherd's dog, the wolf-dog, and what is commonly called the Siberian dog, to which may be joined the Lapland dog, the Canaja dog, and, in general, all those which have strait ears and a pointed snout, are all one kind, differing only in thickness, the roughness or smoothness of their skin, the length of their legs, and tails. The hound, or beagle, the terrier, the braque, or short-tailed setting-dog, and the spaniel, may be considered as the same kind: they have the same form and the same instincts; and differ only in the length of their legs, and size of their ears, which in each of them are long, soft, and pendulous. The bull-dog, the small Danish dog, the Turkish dog, and the Iceland dog, may likewise be considered as the same kind, all the varieties in their appearance taking their rise merely from climate. For instance, the Turkish dog, which has no hair, is nothing else but the small Danish dog transported to a warm climate, which makes the hair fall off. A dog of any kind loses its hair in very warm climates. But this is not the only change which arises from difference of climate. In some countries the voice is changed; in others, dogs become altogether silent. In some climates, they lose the faculty of barking, and howl like wolves, or yelp like foxes. Warm climates even change their form and instincts: They turn ill-shaped, and their ears become strait and pointed. It is only in temperate climates that dogs preserve their natural courage, ardour, and sagacity.

In order to give an idea of the different kinds of dogs, in different climates, and of the varieties produced by commixtures, we shall give an explanation of Bouffon's genealogical tree, See Plate LXI. fig. 1. This tree is constructed in the form of a geographical chart, in which the situation of the different climates to which the parti-

cular dogs belong, is observed as accurately as the nature of the thing will admit.

The shepherd's dog is the stump of the tree. This dog, when transported to Lapland, or any very cold climate, assumes an ugly appearance, and its legs become short. But, in Britain, Russia, Siberia, &c. where the cold is not so rigorous, and the people are more civilized, he arrives at greater perfection, both in form and sagacity. The same shepherd's dog, when brought up in a country fully civilized, as Britain or France, loses his savage air, his strait ears, his thick long hair, and becomes what is called a bull-dog, a mastiff, a beagle, or hound. These changes, Bouffon attributes to the influence of the climate, the manners of the people, &c. The mastiff and the bull-dog have their ears still partly strait, or half-pendent, and resemble in their manners and sanguine disposition the dog from which they derive their origin. The beagle or hound preserves less of the appearance of its origin than the other two; its ears are long and entirely pendent; the softness, the tractability, the timidity of this dog, Bouffon considers as so many proofs of its great degeneracy, or rather of that perfection which it acquires by culture, and living among a civilized people.

The hound, the small spotted setting-dog, and the terrier, are all of the same family; for all the three kinds are often produced at the same litter, although the female hound had been covered only by one of these kinds.

When the hound is transported to Spain, or Barbary, where almost every animal has fine, long, downy hair, it is changed into a water-hound, or spaniel. And the small and large spaniel, which differ only in the tail, when carried to Britain, are changed from a white to a black colour, and become what is called the large and small shagged dogs.

The mastiff, when carried to the north, is changed into the large Danish dog; and when transported to the south, it becomes a grey-hound. The large grey-hounds come from the Levant; those of a lesser size come from Italy; and the Italian grey-hounds, when brought to Britain, become what the French call *levrons*, that is, grey-hounds of the least size.

The great Danish dog, when carried to Ireland, the Ukraïn, Tartary, &c. is changed into the Irish dog, which is the largest of all dogs.

The bull-dog, when carried from Britain to Denmark, becomes the small Danish dog; and this small Danish dog, when transported into a warm climate, loses its hair, and is changed into the Turkish dog.

All these races or families, with their varieties, are produced by the influence of climate, food, and education: The other kinds marked in the tree are not pure or distinct families, but are produced by the commixture of the other families. These mungrel dogs, with the particular parents which produce them, are marked out in the tree by dotted lines. For example,

The grey-hound and mastiff produce the mungrel grey-hound, which is likewise called the grey-hound with wolf's hair. The large Danish dog and the large spaniel produce the Calabrian dog; which is a beautiful dog, with long bushy hair, and of a larger size than the ma-

stiff. The spaniel and the small Danish dog produce the lion-dog, which is a very rare kind. It is needless to give more examples, as they can easily be traced from the dotted lines in the tree.

Having thus traced the varieties of the dog, and the probable sources of these varieties, we shall now give an account of his nature and instincts.

From the structure of the teeth, it might be concluded *à priori* that the dog is a carnivorous animal. He does not however eat indiscriminately every kind of animal substance. There are some birds, as the colymbus arcticus, which the water-dog will lay hold off with keenness, but will not bring out of the water, because its smell is exceedingly offensive to him. He will not eat the bones of a goose, crow, or hawk: But he devours even the putrid flesh of most other animals. He is possessed of such strong digestive powers, as to draw nourishment from the hardest bones. When flesh cannot be procured, he will eat fish, fruits, succulent herbs, and bread of all kinds. When oppressed with sickness, to which he is very subject, especially in the beginning of summer, in order to procure a puke, he eats the leaves of the quicken grass, the bearded wheat-grass, or the rough cock's-foot-grass, which gives him immediate relief. When he steals a piece of flesh, as conscious of the immorality of the action, he runs off with his tail hanging and bent in betwixt his feet.

His drink is water, which he takes in small quantities at a time, by licking with his tongue. He is in some measure obliged to lick in this manner, otherwise his nose would be immersed in the water.

His excrements are generally hard scybals, which, especially after eating bones, are white, and go by the name of *album græcum* among physicians. This album græcum was for a long time in great repute as a septic; but it is now entirely disregarded. He does not throw out his excrements promiscuously upon every thing that happens to be in the way, but upon stones, trunks of trees, or barren places. This is a wise institution of nature; for the excrements of a dog destroy almost every vegetable or animal substance. They are of such a putrid nature, that if a man's shoe touches them when recently expelled, that particular part will rot in a few days. He observes the same method in making his urine, which he throws out at a side. It is remarkable, that a dog will not pass a stone or a wall against which any other dog has pissed, without following his example, although a hundred should occur in a few minutes, in so much, that it is astonishing how such a quantity can be secreted in so short a time.

The dog is an animal not only of quick motion, but remarkable for travelling very long journeys. He can easily keep up with his master, either on foot or horseback, for a whole day. When fatigued, he does not sweat, but lolls out his tongue. Every kind of dog can swim; but the water-dog excels in that article.

The dog runs round when about to lie down, in order to discover the most proper situation. He lies generally on his breast, with his head turned to one side, and sometimes with his head above his two fore-feet. He sleeps little, and even that does not seem to be very quiet; for he often

Fig. 1

A GENEALOGICAL TABLE of the different races of DOGS

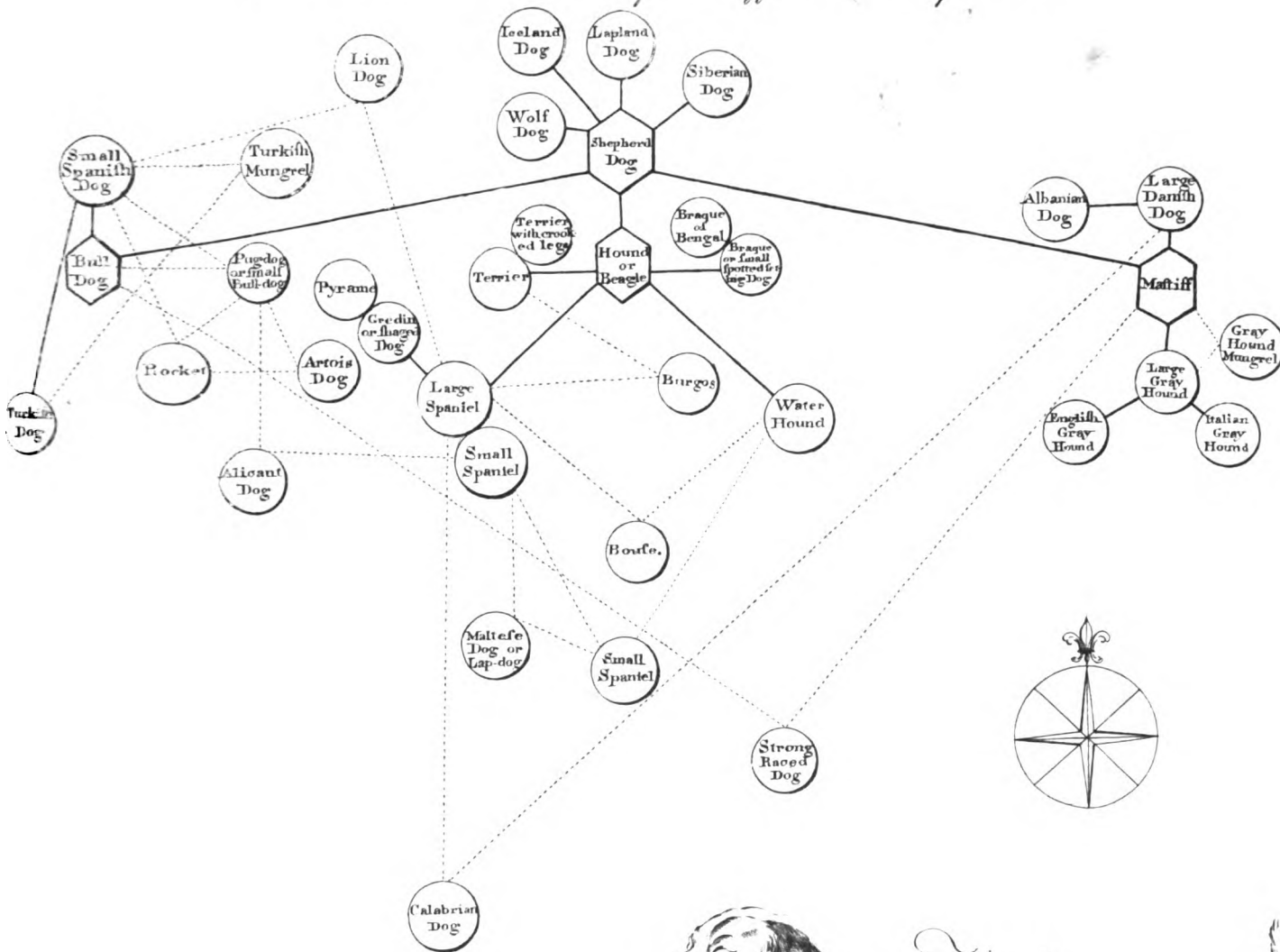


Fig. 2. SHEPHERD'S DOG

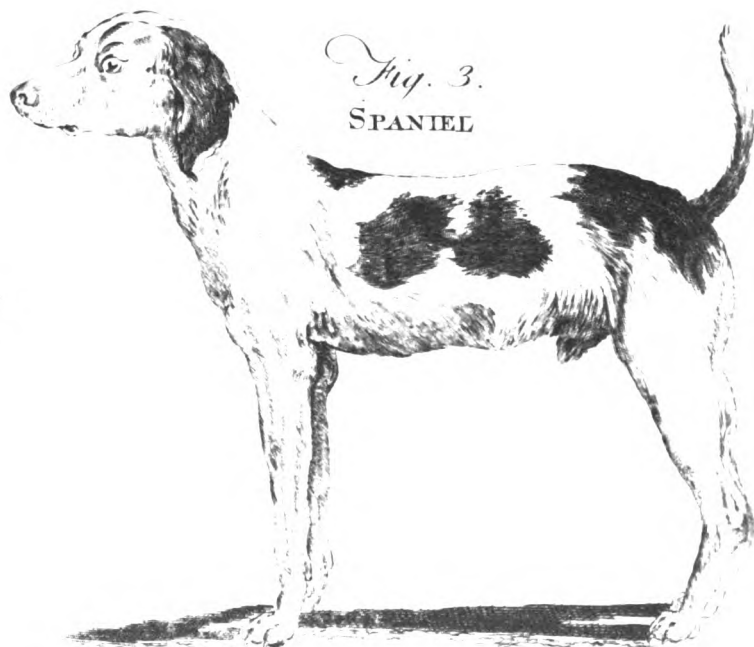


Fig. 3. SPANIEL





often starts, and seems to hear with more acuteness in sleep than when awake. They have a tremulous motion in sleep, frequently move their legs, and bark, which is an indication of dreaming.

Dogs are possessed of the sensation of smelling in a high degree. They can trace their master by the smell of his feet in a church, or in the streets of a populous city. This sensation is not equally strong in every kind. The hound can trace game, or his master's steps, twenty-four hours afterwards. He barks more furiously the nearer he approaches the fowls, unless he be beat and trained to silence.

With regard to the propagation of dogs; the females admit the males before they are twelve months old. They remain in season ten, twelve, or even fifteen days, during which time they will admit a variety of males. They come in season generally twice in the year, and more frequently in the cold than in the hot months. The male discovers the condition of the female by the smell; but she seldom admits him the first six or seven days. One coitus will make her conceive a great number of young; but, when not restrained, she will admit several dogs every day: she seems to have no choice or predilection, except in favour of large dogs: From this circumstance, it sometimes happens, that a small female, who has admitted a mastiff, perishes in bringing forth her young. During the time of copulation, these animals cannot separate themselves, but remain united so long as the erection subsists. This is owing to the structure of the parts. The dog has not only a bone in his penis, but in the middle of the corpus cavernosum there is a large hollow, which is blown up in the time of erection to a considerable bulk. The female, on the other hand, has a larger clitoris than perhaps any other animal; besides a large firm protuberance rises in the time of copulation, and remains perhaps longer than that of the male, and prevents him from retiring till it subsides: Accordingly after the act of copulation is over, the male turns about in order to rest himself on his legs, and remains in that position till these parts turn flaccid. The female goes with young about nine weeks. They generally bring forth from six to twelve puppies. Those of a small size bring forth five, four, and sometimes but two. They continue to copulate and bring forth during life, which lasts generally about fourteen or fifteen years. The whelps are commonly blind, and cannot open their eyes till the tenth or twelfth day. In the fourth month, they lose some of their teeth, which are soon succeeded by others.

The dog has such a strong resemblance to the wolf and the fox, that he is commonly supposed to be the production of one or other of these animals tamed and civilized. Bouffon informs us, that he kept a young dog and a young wolf together till they were three years of age, without their discovering the least inclination to copulate. He made the same experiment upon a dog and a fox; but their antipathy was rather increased when the female was in season. From these experiments he concludes, that dogs, wolfs, and foxes, are perfectly distinct species of animals.

With regard to the natural disposition of the dog: In a savage state, he is fierce, cruel, and voracious; but, when civilized and accustomed to live with men,

he is possessed of every amiable quality. He seems to have no other desire than to please and protect his master. He is gentle, obedient, submissive, and faithful. Those dispositions, joined to his almost unbounded sagacity, justly claim the esteem of mankind. Accordingly no animal is so much caressed or respected: He is so ductile, and so much formed to please, that he assumes the very air and temper of the family in which he resides.

An animal endowed with such uncommon qualities, must answer many useful purposes. His fidelity and vigilance are daily employed to protect our persons, our flocks, or our goods. The acuteness of his smell gains him employment in hunting; in some parts of Siberia, he is trained to draw carriages from one inn to another; and the negroes eat dogs flesh with great relish.

The dog is liable to many diseases, as the scab, madness, &c. and he seldom wants the tænia or tape-worm in his guts, especially if he drinks dirty water. See Plate LXI. and LXII.

2. The second species of this kind is the lupus or wolf, which is distinguished from the dog by having its tail turned inward. The wolf is larger and fiercer than a dog. His eyes sparkle, and there is a great degree of fury and wiliness in his looks. He draws up his claws when he walks, to prevent his tread from being heard. His neck is short, but admits of very quick motion to either side. His colour is generally blackish. Like most ferocious animals, he can bear hunger a very long time; but, at last, when the appetite for victuals becomes intolerable, he grows perfectly furious, and will attack men, horses, dogs, and cattle of all kinds; even the graves of the dead are not proof against his rapacity. This circumstance is finely described, in the following lines.

By wintry famine rous'd,———  
 Cruel as death, and hungry as the grave!  
 Burning for blood! bony, and ghast, and grim!  
 Assembling wolves in raging troops descend;  
 And, pouring o'er the country, bear along,  
 Keen as the north-wind sweeps the glossy snow.  
 All is their prize. They fasten on the bleed,  
 Press him to earth, and pierce his mighty heart.  
 Nor can the bull his awful front defend,  
 Or shake the murdering savages away.  
 Rapacious at the mother's throat they fly,  
 And tear the screaming infant from her breast.  
 The god-like face of Man avails him nought.  
 Even beauty, force divine! at whose bright glance  
 The generous lion stands in soften'd gaze,  
 Here bleeds, a hapless undistinguish'd prey.  
 But if, appris'd of the severe attack,  
 The country be shut up, lur'd by the scent,  
 On church-yards drear (inhuman to relate!)  
 The disappointed prowlers fall, and dig  
 The shrouded body from the grave; o'er which,  
 Mix'd with soul shades, and frighted ghosts, they howl.

THOMSON'S WINTER.

The wolf is extremely suspicious, and, unless pressed with hunger, seldom ventures out of the woods. They make a howling noise in the night, and assemble together in troops in order to devour their prey. The wolf is a native of Europe, and frequents the woods of many parts.

parts of the continent to this day. This country, a few centuries ago, was much infested with them. So late as the year 1477, there is an act of parliament obliging all the gentlemen and tenants in the different shires of Scotland, to rise, properly armed, four times in the year, in order to destroy the wolves. But they are now so effectually rooted out, that not one of them has been seen wild, even in the highlands, for a century past. See Plate LXII. fig. 5.

2. The hyæna, has a strait jointed tail, with the hair of its neck erect, small naked ears, and four toes on each foot. It is about the size of a fow, and its head resembles that of a boar. The hairs on the back are about a span long, erect, and black at the points, and the eyes are near each other. The hyæna is a native of India and Africa. He digs holes in the earth like a fox, where he retires from danger. He is very fond of human flesh, which he digs out of church-yards in the night. When irritated, he lays hold of a weapon, or any thing that offends, and keeps it fast in his teeth, which makes him an easy prey to hunters.

4. The vulpes, or fox, has a strait tail, white at the point. His body is yellowish, or rather straw-coloured; his ears are small and erect; his lips are whitish, and his fore-feet are black. From the base of the tail, a strong scent is emitted, which to some people is very fragrant, and to others extremely disagreeable. The fox is a native of almost every quarter of the globe: He digs holes or dens in the earth; and is of such a wild and savage disposition, that it is impossible fully to tame him. He is esteemed to be the most crafty and cunning of all beasts of prey. His cratunels is principally discovered by the schemes he falls upon in order to catch lambs, geese, hens, and all kinds of small birds. When the females are in season, they make a disagreeable yelping noise in the night. He flies when he hears the explosion of a gun, or smells gun-powder. He is exceedingly fond of grapes, and does much mischief in vineyards. Various methods are daily employed to destroy foxes; they are hunted with dogs; iron-traps are often set at their holes; and their holes are sometimes smoked to make them run out, that they may the more readily fall into the snares, or be killed by dogs or fire-arms. But all the arts that have been employed are insufficient for the purpose of rooting him out of any country. They have so many passages in their dens, and often at a great distance, that they often make their escape. When hunted, they never run directly forward, but make a great many doublings and turnings; and when in danger of being taken, they emit such a smell from their posteriors, that the hunters can hardly endure it. See Plate LXII. fig. 4.

5. The alopec, or field-fox, is every way the same with the common fox, except in the point of the tail, which is black.

6. The lagopus, or white fox, with a strait tail, and the apex of different colours. The legs are very hairy. It inhabits the mountains of Lapland and Siberia.

7. The aureus, or jackall, is a native of the East Indies. There is no genuine description of this animal. They assemble in large troops in the night, in several parts of Asia, and make a hideous howling noise. When one calls, he is answered by numbers even at great distances; so that in a short time the whole woods resound with their noise. This noise rouses all the other wild

animals, as lions, tygers, &c. who take advantage of the general consternation, and devour the weaker animals. This circumstance has probably given rise to the notion of the jackall's being the lion's provider. They hide themselves in holes during the day, and go in quest of their prey in the night: They sometimes fall upon children, and devour them when no assistance is near.

8. The Mexicanus, has a smooth crooked tail. The body is ash-coloured, variegated with yellow spots. It is a native of Mexico, and is called the mountain-cat by Seba.

9. The thous, has a smooth, crooked tail. The upper part of his body is grey, and the belly is white. He is about the size of a large cat, and is found at Surinam.

CANIS, the DOG-FISH, a name given to several species of *Squalus*. See *SQUALUS*.

CANIS *major*, in astronomy, a constellation of the southern hemisphere.

CANIS *minor*, CANICULUS, or CANICULA, in astronomy, a constellation of the northern hemisphere.

CANKER, a disease incident to trees, proceeding chiefly from the nature of the soil. It makes the bark rot and fall. If the canker be in a bough, cut it off; in a large bough, at some distance from the tree; and in a small one, close to it: But for over-hot strong ground, the mold is to be cooled about the roots with pond mud, and cow dung.

CANNA, in botany, a genus of the monandria monogynia class. There are four species of this plant, all natives of the Indies.

CANNABIS, hemp, in botany, a genus of the diœcia pentandria class. The calix of the male is divided into five segments, and it has no corolla. The calix of the female consists of one leaf, open at the side; it has two styli; and the nut or capisule consists of two valves. There is but one species, *viz.* the sativa, or common hemp, a native of India. For the method of cultivating and preparing hemp, see *FLAX*, and *HEMP*.

CANNACORUS, in botany. See *CANNA*.

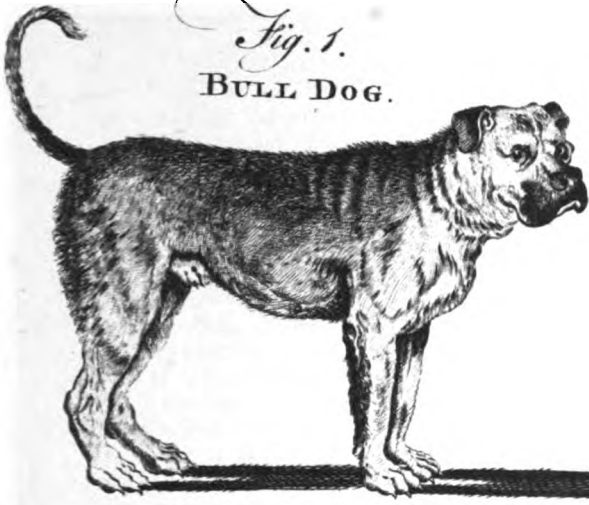
CANNEL-COAL, a substance which has a long time, though with very little reason, been confounded, both by authors and druggists, with jet. It is dug up in many parts of England in great abundance, particularly in Lancashire, where it is burnt as common fuel. It is worked into toys and utensils of various kinds, under the name of jet. In medicine, it is said to be good in the colic; but the present practice takes no notice of it.

CANNON, in the military art, an engine or fire-arm for throwing iron, lead, or stone bullets, by force of gun-powder.

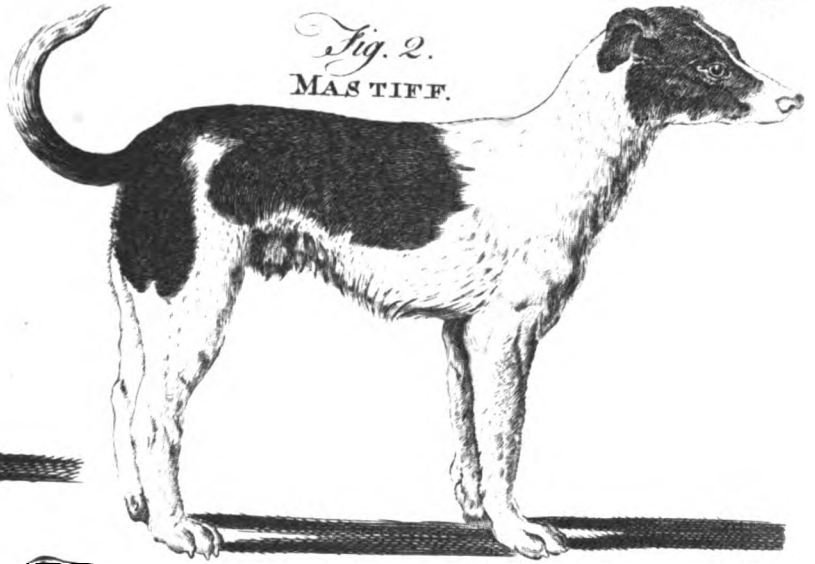
Cannons at first were called bombardæ, from the noise they made. They had likewise the name of culverin, basilisk, &c. from the beasts that were represented upon them; and the Spaniards, from devotion, gave them the name of saints; witness the twelve apostles which Charles V. ordered to be cast at Malaga, for his expedition to Tunis.

The metal of which cannons are composed, is either iron, or which is more usual, a mixture of copper, tin, and brass; the tin being added to the copper.

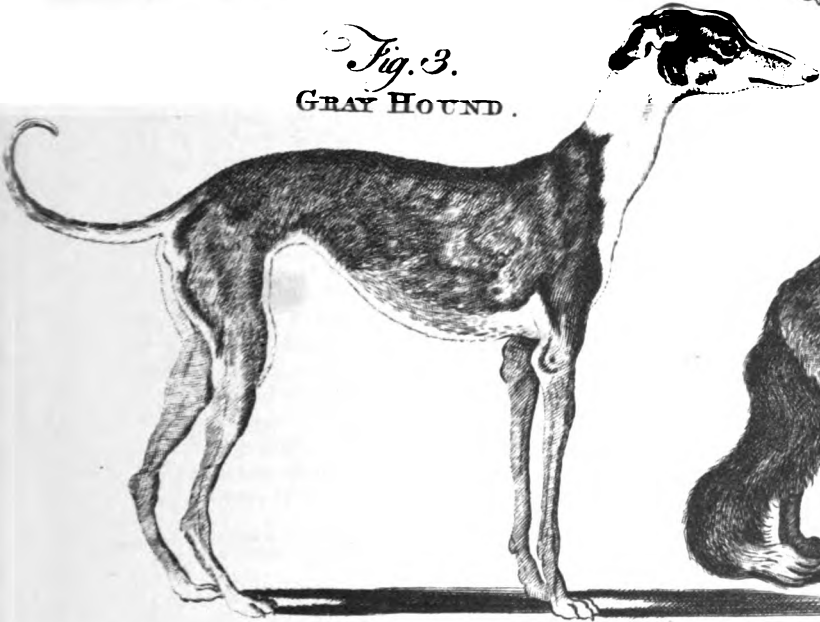
*Fig. 1.*  
BULL DOG.



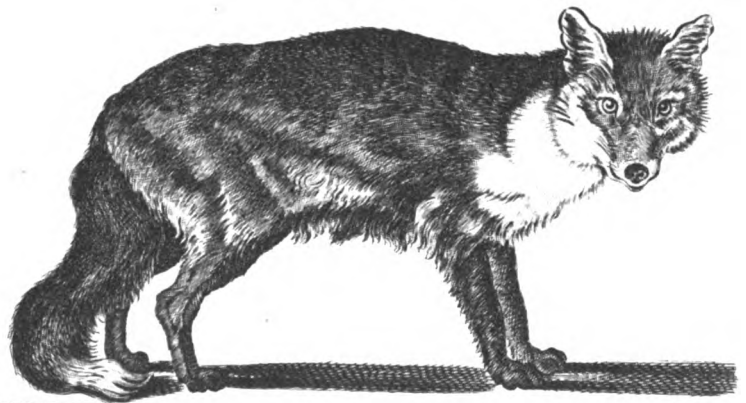
*Fig. 2.*  
MAS TIEFF.



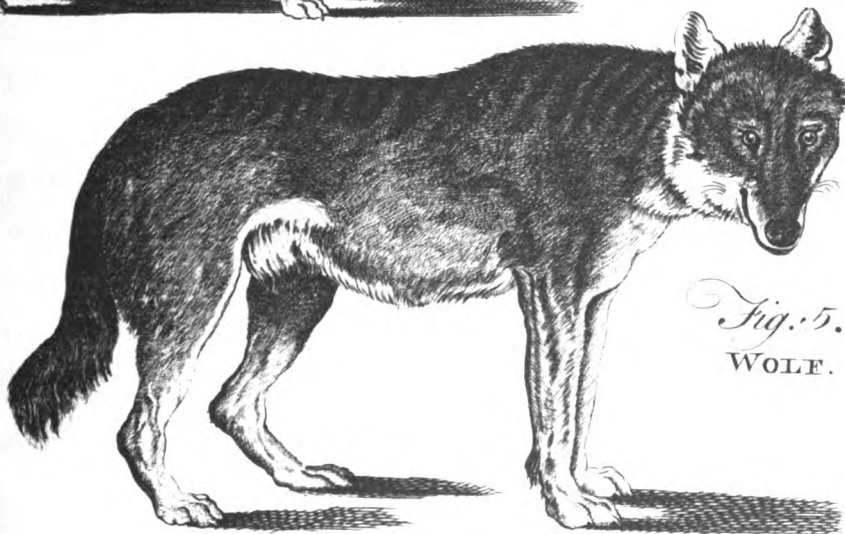
*Fig. 3.*  
GRAY HOUND.



*Fig. 4.*  
FOX.



*Fig. 5.*  
WOLF.



*A. Bell sculp.*



per, to make the metal more dense and compact; so that the better and heavier the copper is, the less tin is required. Some to an hundred pounds of copper, add ten of tin, and eight of brass; others ten of tin, five of brass, and ten of lead. The sieur Bereau pretends, that when one piece of metal are used, the founder ought to add to one hundred weight of that metal, twenty-five pounds of good copper, and five pounds of tin. Braudius describes a method of making cannon of leather; and it is certain the Swedes made use of such in the long war of the last century; but these burst too easily to have much effect. With regard to iron cannon, they are not capable of so much resistance as those of brass; but as they are less expensive, they are often used on board of ships, and also in several fortified places.

Cannons are distinguished by the diameters of the balls they carry. The rule for their length is, that it be such as that the whole charge of powder be on fire, before the ball quit the piece. If it be too long, the quantity of air to be drawn out before the ball, will give too much resistance to the impulse; and that impulse ceasing, the friction of the ball against the surface of the piece will take off from the motion.

In former days, cannon were made much longer than they are now; but experience has taught us, that a ball moves with a greater impetus through a less space than a greater: and accordingly it is found, that an iron ball of forty-eight pound weight goes farther from a short cannon, than another ball of ninety-six pound out of a longer piece; whereas, in other respects, it is certain, the larger the bore and ball, the greater the range.

It is found too, by experience, that of two cannons of equal bore, but different lengths, the longer requires a greater charge of powder than the shorter. The ordinary charge of a cannon is, for the weight of its gun-powder to be half that of its ball.

We shall here subjoin a table exhibiting the names of the several cannon, their length, their weight, and that of their ball.

Names of cannon.	weight of an iron ball.	weight of the cannon.	length of the cannon.
	lb. oz.	lb.	f. inch.
Cannon royal	48 0	8000	12 0
Demi cannon large	36 0	6000	12 0
Demi cannon ordinary	32 0	5600	12 0
Demi cannon least	30 0	5400	11 0
Culverin largest	20 0	4800	12 0
Culverin ordinary	17 5	4500	12 0
Culverin least	15 0	4000	11 0
Demi culverin ordinary	10 11	2700	11 0
Demi culverin least	9 0	2000	10 0
Saker ordinary	6 0	1500	10 0
Saker least	4 12	1400	8 0
Minion largest	3 12	1000	8 0
Minion ordinary	3 4	800	7 0
Falcon	2 8	750	6 0
Falconet	1 5	400	5 6
Rabinet	0 8	300	5 6
Base	0 5	200	4 6

Cannon are likewise distinguished according to the diameter of their mouth, or calibre. This calibre is divided, in consequence of an order from the king of France, into thirty-six parts, in order to determine by these parts the dimensions of the different moulds for cannon. We hope the reader, then, will not be dissatisfied to find an account of the dimensions of the several parts of cannon of five different calibres, as they are regulated by that order of the king of France, on Oct. 7, 1732, in the following table:

Pieces of cannon	of 24			of 16			of 12			of 8			of 4		
	feet.	inch.	lines.	feet.	inch.	lines.	feet.	inch.	lines.	feet.	inch.	lines.	feet.	inch.	lines.
Length of the bore	9	6		9	2		8	8		7	10		6	6	
Depth of the chamber	2	6			1	10									
Thickness of metal at breech		5	5		4	9		4	4		3	9		3	
Length of the cascabel		10	11		9	6		8	8		7	7		6	
Diameter of the trunions		5	5		4	9		4	4		3	10		3	
Projection of the trunions		5	5		4	9		4	4		3	10		3	
Calibre of the piece		5	8		4	11		4	6		3	11		3	2
Diameter of the ball		5	6		4	9		4	4		3	9		3	
Length of the whole piece	11			10	6		10			8	10		7	3	
Weight of the piece			5400			4200			3200			2100			1150 lb.

**CANNON**, with letter-founders and printers, the name of the largest size of the letters they use.

**CANNULA**, in surgery, a tube made of different metals, principally of silver and lead, but sometimes of iron.

They are introduced into hollow ulcers, in order to facilitate a discharge of pus or any other substance; or into wounds, either accidental or artificial, of the large cavities, as the thorax or abdomen: they are used in the operation of branchotomy, and by some, after cutting for the stone, as a drain for the urine.

Other cannulas are used for introducing cauterics, either actual or potential, in hollow parts, in order to guard the parts adjacent to that to be cauterised, from injury. They are of various figures; some being oval, some round, and others crooked.

**CANOE**, a small boat, made of the trunk of a tree, bored hollow; and sometimes also of pieces of bark sewed together.

It is used by the natives of America to go a-fishing in the sea, or upon some other expedition, either by sea, or upon the rivers and lakes.

**CANON**, commonly called prebendary, a person who possesses a prebend, or revenue allotted for the performance of divine service in a cathedral or collegiate church. Originally, canons were only priests, or inferior ecclesiastics, who lived in community, residing near the cathedral church to assist the bishop, depending entirely on his will, supported by the revenues of his bishopric, and living in the same house as his domestics or counsellors, &c. By degrees these communities of priests, shaking off their dependence, formed separate bodies; in time they freed themselves from their rules, and at length ceased to live in a community. It is maintained, that the colleges of canons, which have been introduced into each cathedral, were not in the ancient church, but are of modern appointment.

In the Romish church, when a person is promoted to the office of a canon, he must be presented in a very ceremonious manner to the chapter, who assemble in the cathedral, in order to receive him: he kisses the altar thrice, after which he goes and takes his place in the choir; he afterwards makes his confession of faith aloud, and swears to observe the ordinances of the church and his holiness the pope: being thus solemnly installed, he is empowered to assist at the chapter, to chaunt the office of the choir, &c.

Canons are of various kinds, as,

**Cardinal-CANONS**, those attached, or, as the Latins call it, *incardinati*, to a church, as a priest is to a parish.

**Domicalery-CANONS**, young canons, who, not being in orders, had no right in any particular chapters.

**Esprituelle-CANONS** were such as, without having any revenue or prebend, had the titles and dignities of canons, a voice in the chapter, and a place in the choir, till such time as a prebend should fall.

**Foreign CANONS**, such as did not officiate in the canonic to which they belonged. To these were opposed *maisonery* canons.

**Regular CANONS**, those who still live in community, and who, like religious, have, to the practice of their rules, added the solemn profession of vows.

**Tertiary CANON**, a person who had only the third part of the revenues of the canonicate.

**CANON**, in an ecclesiastical sense, a law, rule, or regulation of the policy and discipline of a church, made by councils either general, national, or provincial.

**CANONS of the apostles**, a collection of ecclesiastical laws, which, though very ancient, were not left us by the apostles. It is true, they were sometimes called apostolic canons; but this means no more than that they were made by bishops, who lived soon after the apostles, and were called apostolical men. They consist of regulations, which agree with the discipline of the second and third centuries: The Greeks generally count eighty-five, but the Latins receive only fifty, nor do they observe all these.

**CANON of mass**, in the Romish church, the name of a prayer which the priest reads low to himself, the people kneeling.

In this part of the mass, the priest particularly mentions some persons for whom he is going to offer the sacrifices, and prays to God for the redemption of their souls, the hopes of their salvation, &c.

**Paschal CANON**, a table of the moveable feasts, shewing the day of Easter, and the other feasts depending on it, for a cycle of nineteen years.

**CANON of scripture**, a catalogue or list of the inspired writings, or such books of the Bible as are called canonical; because they are in the number of those books which are looked upon as sacred, in opposition to those which are either not acknowledged as divine books, or are rejected as heretical and spurious, and are called apocryphal.

**CANON**, in monastic orders, a book wherein the religious of every convent have a fair transcript of the rules of their order, frequently read among them, as their local statutes.

**CANON** is also used for the catalogue of saints acknowledged and canonized in the Romish church.

**CANON**, in music, a short composition of two or more parts, in which one leads, and the other follows: Or it is a line of any length, shewing, by its divisions, how-musical intervals are distinguished, according to the ratios, or proportions, that the sounds terminating the intervals, bear one to another, when considered according to their degree of being acute or grave.

**CANON-LAW**, a collection of ecclesiastical laws, serving as the rule and measure of church-government.

The power of making laws was exercised by the church before the Roman empire became Christian. The canon-law that obtained throughout the West, till the twelfth century, was the collection of canons made by Dionysius Exiguus in 520, the capitularies of Charlemagne, and the decrees of the popes, from Siricius to Anastasius.

The canon-law, even when papal authority was at its height in England, was of no force when it was found to contradict the prerogative of the king, the laws,

laws, statutes, and customs of the realm, or the doctrine of the established church.

The ecclesiastical jurisdiction of the see of Rome in England, was founded on the canon-law; and this created quarrels between kings and several archbishops and prelates, who adhered to the papal usurpation.

Besides the foreign canons, there were several laws and constitutions made here for the government of the church; but all these received their force from the royal assent: And if, at any time, the ecclesiastical courts did, by their sentence, endeavour to enforce obedience to such canons, the courts at common law, upon complaints made, would grant prohibitions. The authority vested in the church of England of making canons, was ascertained by a statute of Henry VIII. commonly called the act of the clergy's submission; by which they acknowledged, that the convocation had been always assembled by the king's writ; so that though the power of making canons resided in the clergy met in convocation, their force was derived from the authority of the king's assenting to, and confirming them.

The old canons continued in force till the reign of James I. when the clergy being assembled in convocation, the king gave them leave to treat and consult upon canons: which they did, and presented them to the king, who gave them the royal assent: These were a collection out of the several preceding canons and injunctions. Some of these canons are now obsolete. In the reign of Charles I. several canons were passed by the clergy in convocation.

**CANONESS**, in the Romish church, a woman who enjoys a prebend, annexed, by the foundation, to nuns, without their being obliged to renounce the world, or make any vows.

**CANONIZATION**, a ceremony in the Romish church, by which persons deceased are ranked in the catalogue of the saints. It succeeds beatification. See **BEATIFICATION**.

Before a beatified person is canonized, the qualifications of the candidate are strictly examined into, in some consistories held for that purpose; after which one of the consistorial advocates, in the presence of the pope and cardinals, makes the panegyric of the person who is to be proclaimed a saint, and gives a particular detail of his life and miracles: Which done, the holy father decrees his canonization, and appoints the day.

On the day of canonization, the pope officiates in white, and their eminences are dressed in the same colour. St Peter's church is hung with rich tapestries, upon which the arms of the pope, and of the prince or state requiring the canonization, are embroidered in gold and silver. An infinite number of lights blaze all round the church, which is crowded with pious souls, who wait with a devote impatience, till the new saint has made his public entry, as it were, into paradise, that they may offer up their petitions to him, without danger of being rejected.

The following maxim, with regard to canonization, is now observed, though it has not been followed a-

love a century, *viz.* not to enter into the inquiries prior to canonization, till fifty years, at least, after the death of the person to be canonized. By the ceremony of canonization, it appears, that this rite of the modern Romans, has something in it very like the apotheosis or deification of the ancient Romans, and in all probability owes its rise to it; at least, several ceremonies of the same nature are conspicuous in both.

**CANONOR**, a town on the Malabar coast, in the Hither India: E. long. 75°, N. lat. 10°.

Here the Dutch have a fort and factory, which they took from the Portuguese in 1563.

**CANONRY**, the benefice filed by a canon. It differs from a prebend, in that the prebend may subsist without the canonicate; whereas the canonicate is inseparable from the prebend; again, the rights of suffrages, and other privileges, are annexed to the canonicate, and not to the prebend.

**CANOPUS**, in astronomy, a star of the first magnitude in the rudder of Argo, a constellation of the southern hemisphere. See **ASTRONOMY**, *Of the fixed stars*.

**CANTABRICA**, in botany, a synonyme of a species of convolvulus. See **CONVOLVULUS**.

**CANTALIVERS**, in architecture, pieces of wood framed into the front or other sides of a house, to suspend the mouldings and eyes over it.

**CANTAR**, or **CANTARO**, in commerce, a weight used in Italy, particularly at Leghorn, to weigh some sorts of merchandises.

There are three sorts of cantari, or quintals, one weighs 150 pounds, the other 151, and the third 160: The first serves to weigh alum and cheese, the second is for sugar, and the third for wool and codfish.

**CANTAR** is also a measure of capacity used at Cochin, and containing four rubis.

**CANTATA**, in music, a song or composition, intermixed with recitatives, airs, and different movements, chiefly intended for a single voice, with a thorough bass, though sometimes for other instruments.

The cantata when performed with judgment, has something in it very agreeable; the variety of the movement not clogging the ear, like other compositions. It was first used in Italy, then in France, whence it passed to us.

**CANTERBURY**, the capital city of Kent, fifty-five miles east of London, and sixteen north-west of Dover: E. long. 1° 15'. N. lat. 51° 10'.

It is a county of itself, and the see of an archbishop, who is primate and metropolitan of all England. It is a large, populous, and trading city; has a good silk manufactory, and sends two members to parliament.

**CANTERBURY-BELL**, in botany. See **CAMPANULA**.

**CANTHARIS**, in zoology, a genus of insects belonging to the order of insects coleoptera. The feelers of this genus are setaceous; the breast is marginated, and shorter than the head; the elytra, or wing-cases, are flexile; and the sides of the belly are plaited and papillous. Linnæus enumerates 27 species of the cantharis, most of them to be found in different parts of Europe.

Europe. The catharis used in making blistering plasters, is ranked under a different genus, *viz.* the Meloe. See MELOE.

**CANTICLES**, a canonical book of the Old Testament. The Talmudists ascribe it to Hezekiah, but the learned are agreed that king Solomon was the author of it; and his name is prefixed to it in the title of the Hebrew text, and of the ancient Greek version.

**CANTO**, in music, the treble, or at least the higher part of a piece.

This word more properly signifies the first treble, unless the word *secundo*, for the second, or *ripieno*, for the treble of the grand chorus, be added.

**CANTON**, in geography, denotes a small country, or district, constituting a distinct government: such are the cantons of Switzerland.

**CANTON** is also the name of a large, populous, and wealthy city and port-town of China, situated on the river Ta, about fifty miles from the Indian ocean: E. long. 112° 30', N. lat. 23° 25'.

It is a fortified place, within the walls of which no Christians are permitted to enter, notwithstanding their great trade thither; it being from thence that they import all manner of Chinese goods, as china-ware, tea, cabinets, raw and wrought silks, gold-dust, &c.

**CANTONING**, in the military art, is the allotting distinct and separate quarters to each regiment of an army; the town where they are quartered, being divided into so many cantons, or divisions, as there are regiments.

**CANTRED**, or **CANTREF**, signifies an hundred villages, being a British word, compounded of the adjective *cant*, i. e. hundred, and *tres*, a town or village. In Wales, some of the countries are divided into cantreds, as in England into hundreds.

**CANVAS**, in commerce, a very clear unbleached cloth of hemp, or flax, wove very regularly in little squares. It is used for working tapestry with the needle, by passing the threads of gold, silver, silk, or wool, through the intervals or squares.

**CANVAS** is also a coarse cloth of hemp, unbleached, somewhat clear, which serves to cover womens stays, also to stiffen mens cloaths, and to make some other of their wearing-apparel, &c.

**CANVAS** is also a very coarse cloth made of hemp, unbleached, serving to make towels, and answering other domestic purposes. It is also used to make sails for shipping, &c.

**CANVAS** is used among the French, for the model and first words, where an air or piece of music is composed, and given to a poet to regulate and finish.

**CANATUS**, in ornithology, the trivial name of a species of tringa. See TRINGA.

**CANZONE**, in music, signifies, in general, a song where some little figures are introduced: But it is sometimes used for a sort of Italian poem, usually pretty long, to which music may be composed in the style of a cantata. If this term be added to a piece of instrumental music, it signifies much the same as cantata: If placed in any part of a sonata, it implies the same meaning as *allegro*, and only denotes that

the part to which it is prefixed, is to be played or sung in a brisk and lively manner.

**CANZONETTA**, a diminutive of canzone, denoting a little short song: The canzonette neapolitane have two strains, each whereof is sung twice over, as the vau-devilles of the French: The canzonette siciliane are a species of jig, the measure whereof is usually twelve eights, and six eights, and sometimes both, as rondeaus.

**CAP**, a part of dress made to cover the head, much in the figure thereof.

The use of caps and hats is referred to the year 1449, the first seen in these parts of the world being at the entry of Charles VII. into Rouen: from that time they began to take place of the hoods, or chaperoons, that had been used till then. When the cap was of velvet, they called it mortier; when of wool, simply bonnet. None but kings, princes, and knights, were allowed the use of the mortier. The cap was the head-dress of the clergy and graduates: Churchmen and members of universities, students in law, physic, &c. as well as graduates, wear square caps in most universities. Doctors are distinguished by peculiar caps, given them in assuming the doctorate. Pasquier says, that the giving the cap to students in the universities, was to denote that they had acquired full liberty, and were no longer subject to the rod of their superiors, in imitation of the ancient Romans, who gave a pileus or cap to their slaves, in the ceremony of making them free. The cap is also used as a mark of infamy in Italy. The Jews are distinguished by a yellow cap at Lucca, and by an orange one in France.

**CAP of maintenance**, one of the regalia, or ornaments of state belonging to the kings of England, before whom it was carried at the coronation, and other great solemnities. Caps of maintenance are also carried before the mayors of the several cities in England.

**CAPE**, in geography, an high land running out with a point, into the sea, as Cape-Nord, Cape-Horn, the Cape of Good-Hope, &c.

**CAPE of Good-Hope**. See GOOD-HOPE.

**CAPE-coast-castle**, the principal British fort and settlement on the gold-coast of Guinea, situated under the meridian of London, in 5° N. lat.

**CAPELLA**, in astronomy, a bright fixed star in the left shoulder of the constellation auriga.

**CAPER**, in botany. See CAPPARIS.

**CAPERQUIN**, a town of Ireland, in the county of Waterford, and province of Munster, situated on the river Blackwater: W. long. 7° 50', and N. lat. 52° 5'.

**CAPHAR**, a duty which the Turks raise on the Christians, who carry or send merchandises from Aleppo to Jerusalem, and other places in Syria.

This duty of caphar was first imposed by the Christians themselves, when they were in possession of the Holy land, for the maintenance of the troops, which were planted in difficult passes, to observe the Arabs, and prevent their incursions. It is still continued, and much increased by the Turks, under pretence of defending the Christians against the Arabs, with whom, never-



nevertheless, they keep a secret intelligence, favouring their excursions and plunders.

**CAPLI-AGA**, or **CAPOU-AGASSI**, a Turkish officer, who is, as it were, grand-master of the seraglio.

He is the first in dignity and repute of all the white eunuchs, and is always near the Grand Signior's person. It is he who introduces ambassadors to audience; and all great affairs pass through his hands before they come to that of the prince.

**CAPIAS**, in law, a writ of two sorts, one before judgment in an action, and the other after: That before judgment is called *capias ad respondendum*, where an original is sued out, &c. to take the defendant, and make him answer the plaintiff; and that after judgment is the *capias ad satisfaciendum*, &c.

**CAPIGLI**, in the Turkish affairs, the name of certain inferior officers belonging to the seraglio, to the number of five hundred, whose business is to assist the janizaries in guarding the first and second gate of that palace; whence also the name *capighi*, which signifies a gate.

**CAPILLAMENT**, in a general sense, signifies a hair, whence the word is applied to several things, which, on account of their length or their fineness, resemble hairs: As,

**CAPILLAMENTS of the nerves**, in anatomy, the fine fibres, or filaments, whereof the nerves are composed.

**CAPILLARY**, in a general sense, an appellation given to things on account of their extreme fineness, or resembling hair.

**CAPILLARY tubes**, in physics, little pipes whose canals are extremely narrow, their diameter being only a half, third, or fourth of a line. See **HYDROSTATICS**.

**CAPILLUS veneris**, in botany. See **ADIANTUM**.

**CAPITAL**, in geography, denotes the principal city of a kingdom, province, or state.

**CAPITAL**, among merchants, traders, and bankers, signifies the sum of money which individuals bring to make up the common stock of a partnership.

**CAPITAL crime**, such a one as subjects the criminal to capital punishment, that is, the loss of life.

**CAPITAL**, in architecture, the uppermost part of a column or pilaster, serving as the head, or crowning, and placed immediately over the shaft, and under the entablature. See **ARCHITECTURE**.

**CAPITANATE**, a province of the kingdom of Naples, situated on the gulf of Venice, and having the province of Molise on the north, and the Principate on the south.

**CAPITANIA**, in geography, an appellation given to the twelve governments established by the Portuguese in the Brasils.

**CAPITATION**, a tax or imposition raised on each person in consideration of his labour, industry, office, rank, &c. It is a very ancient kind of tribute. The Latins call it *tributum*, by which taxes on persons are distinguished from taxes on merchandise, which were called *vectigalia*.

Capitations are never practised among us but in exigencies of state. In France, the capitation was in-

roduced by Lewis XIV. in 1695, and is a tax very different from the *taille*, being levied from all persons whether they be subject to the *taille* or not. The clergy pay no capitation, but the princes of the blood are not exempted from it.

**CAPITOL**, in antiquity, a castle on the Mons Capitolinus at Rome, where there was a temple dedicated to Jupiter, in which the senate anciently assembled. The capitol consisted of three parts; a nave, sacred to Jupiter; and two wings, the one consecrated to Juno, and the other to Minerva: It was ascended to by stairs; the frontispiece and sides were surrounded with galleries, in which those who were honoured with triumphs entertained the senate at a magnificent banquet, after the sacrifices had been offered to the gods.

Both the inside and outside were enriched with infinite ornaments, the most distinguished of which was the statue of Jupiter, with his golden thunder-bolt, his sceptre, and crown. In the capitol also were a temple to Jupiter the guardian, and another to Juno, with the mint; and on the descent of the hill was the temple of Concord.

This beautiful edifice contained the most sacred deposits of religion, such as the *ancylia*, the books of the *sybils*, &c.

**CAPITOLINE games**, annual games instituted by Camillus, in honour of Jupiter Capitolinus, and in commemoration of the capitol's not being taken by the Gauls. Plutarch tells us, that a part of the ceremony consisted in the public crier's putting up the *Hetrurians* to sale by auction: They also took an old man, and, tying a golden bulla about his neck, exposed him to the public derision. Festus says, they also dressed him in a *prætexta*. There was another kind of *capitoline games*, instituted by Domitian, wherein there were rewards and crowns bestowed on the poets, champions, orators, historians, and musicians. These last *capitoline games* were celebrated every five years, and became so famous, that instead of calculating time by *lustra*, they began to count by *capitoline games*, as the Greeks did by *olympiads*. It appears, however, that this custom was not of long continuance.

**CAPITOU**, an appellation given to the chief magistrates of Tholouse, on account of their meeting in a place called the Capitol: They are eight in number, are chosen annually, and have each the government of a *capitoulate*, or precinct, like the wards of London.

**CAPITULATION**, in military affairs, a treaty made between the garrison or inhabitants of a place besieged, and the besiegers, for the delivering up the place on certain conditions.

The most honourable and ordinary terms of capitulation are, to march out at the breach, with arms and baggage, drums beating, colours flying, a match lighted at both ends, and some pieces of cannon, waggons and convoys for their baggage, and for the sick and wounded.

**CAPITULATION**, in the German polity, a contract which the emperor makes with the electors, in the name of all the princes and states of the empire, before he is declared emperor, and which he ratifies be-

fore he is raised to that sovereign dignity. The principal points which the emperor undertakes to observe, are, 1. To defend the church and the empire. 2. To observe the fundamental laws of the empire. And, 3. To maintain and preserve the rights, privileges, and immunities of the electors, princes, and other states of the empire, specified in the capitulation. These articles and capitulations are presented to the emperor by the electors only, without the concurrence of the other states, who have complained from time to time of such proceedings; and in the time of the Westphalian treaty, in 1648, it was proposed to deliberate in the following diet, upon a way of making a perpetual capitulation; but the electors have always found means of eluding the execution of this article. In order however to give some satisfaction to their adversaries, they have inserted in the capitulations of the emperors, and in that of Francis I. in particular, a promise to use all their influence to bring the affair of a perpetual capitulation to a conclusion. Some German authors own, that this capitulation limits the emperor's power; but maintain that it does not weaken his sovereignty: Though the most part maintain, that he is not absolute, because he receives the empire under conditions which set bounds to an absolute authority.

**CAPNOIDES**, in botany, the trivial name of a species of fumaria. See **FUMARIA**.

**CAPON**, a cock-chicken, gelded as soon as left by the dam, or as soon as he begins to crow. They are of use either to lead chickens, ducklings, pheasants, &c. and defend them from the kites and buzzards; or to feed for the table, they being reckoned more delicate than either a cock or a hen.

**CAPPACIA**, a town of the hither principate, in the kingdom of Naples. It is a bishop's see, and situated about fifty-five miles south-east of the city of Naples: E. long. 15° 20', and N. lat. 40° 40'.

**CAPPARIS**, in botany, a genus of the polyandria monogynia class. The calix consists of four coriaceous leaves; the corolla has four petals; the stamina are long; and the capsule is fleshy within, unilocular, and supported by a pedunculus. There are ten species, none of which are natives of Britain.

**CAPRA**, or **GOAT**, a genus of quadrupeds belonging to the order of pecora. The horns are hollow, turned upwards, erect, and scabrous. There are eight fore-teeth in the under jaw, and none in the upper; and they have no dog-teeth. This genus consists of twelve species, *viz.*

1. The hircus, or common goat, with arched carinated horns, and a long beard. The goat of Angora is only a variety of this species; its hair is white, and hangs down to the feet; and the ears are plain and pendent. The common goat is a native of the eastern mountains. See Plate LXIII.

The goat is an animal of more sagacity than the sheep. Instead of having an antipathy at mankind, they voluntarily mingle with them, and are easily tamed. Even in uninhabited countries, they betray no savage dispositions. In the year 1698, an English vessel having put in to the island of Bonovista, two

negroes came aboard, and offered gratis to the captain as many goats as he pleased. The captain expressed his astonishment at this offer. But the negroes replied, that there were only twelve persons in the island; that the goats had multiplied to such a degree, that they were become extremely troublesome; and that, instead of having any difficulty in catching them, they followed the men where-ever they went, and were so obstinately officious, that they could not get quit of them upon any account whatever.

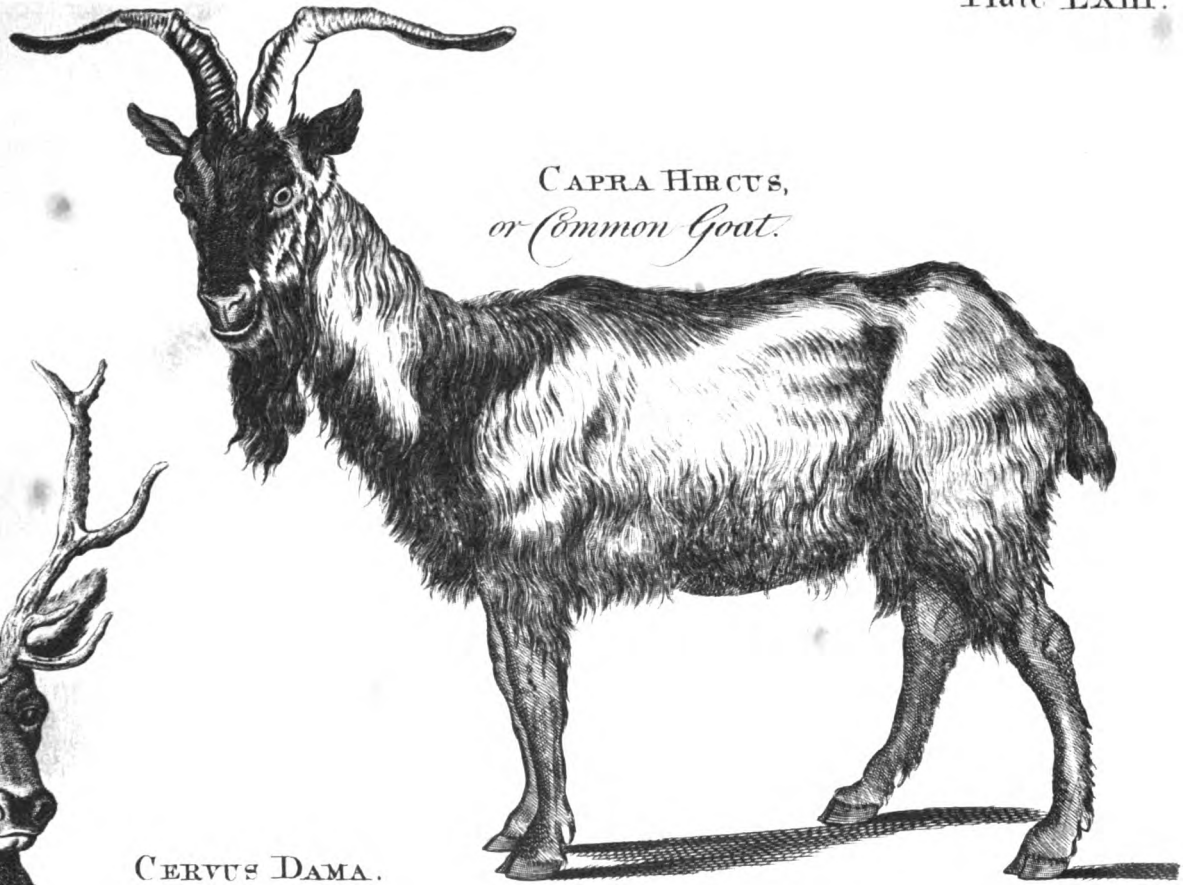
Goats are sensible of caresses, and capable of a considerable degree of friendship. They are stronger, more agile, and less timid than sheep. They have a lively, capricious, and wandering disposition; are fond of high and solitary places; and frequently sleep upon the very points of rocks. They are more easily supported than any other animal of the same size; for there is hardly an herb or the bark of a tree, which they will not eat with pleasure. Neither are they liable to so many diseases as sheep: They can bear heat and cold with less inconvenience. The actions and movements of animals depend more upon the force and variety of their sensations, than the structure of their bodies: The natural inconstancy or fancifulness of goats is accordingly expressed by the irregularity of their actions: They walk, stop short, run, jump, shew, and hide themselves, as it were by mere caprice, and without any other cause than what arises from the natural vivacity of their temper.

The buck will copulate when he is a year old, and the female when she is seven months. But as this is rather premature, they are generally restrained till they be eighteen months or two years. The buck is bald, beautiful, and vigorous; one is sufficient to serve 150 females. A buck for propagation should be large, handsome, and about two years of age; his neck should be short, and fleshy; his head slender; his ears pendent; his thighs thick; his limbs firm; his hair black, thick, and soft; and his beard should be long, and bushy. The females are generally in season from September to the end of November. The time of going with young is five months. They generally produce one kid, sometimes two, seldom three, and never more than four; and continue fruitful till they be seven years of age: But a buck is seldom kept after he is five.

Goat's flesh is not so good as mutton: The rank smell of the buck does not proceed from the flesh, but from the skin.

The food of this animal costs next to nothing, as it lives mostly upon such plants as are rejected by other cattle, and can support itself even upon the most barren mountains. But their produce is valuable. Cheese is made of their milk, which besides is reckoned good in consumptions, and other diseases. Their flesh, tallow, hair, and hides, are all useful and saleable commodities.

2. The ibex, has large knotty horns reclined upon its back, is of a yellowish colour, and its beard is black. This species is a native of Crete: and is likewise to be met with in the mountains of some of the northern parts of Europe.



CAPRA HIRCUS,  
*or Common Goat.*



CERVUS DAMA,  
*or Buck.*



CAPRIMULGUS,  
*or Goat Sucker.*



7. The *nambrica*, with reclined horns, about the length of the neck, pendent ears, and a beard. It is a native of India.

4. The *tupigara*, or shamoy-goat, has erect and hooked horns. It inhabits the inaccessible mountains of Switzerland. The body is of a dusky red colour; but the front, top of the head, gullet, and inside of the ears are white; the under part of the tail is blackish; and the upper lip is a little divided. They seldom descend from the mountains but in hard winters, when they come down to feed upon the branches and barks of fir-trees, &c. On occasions of this kind, one of the herd always keeps watch to give notice to the rest of any approaching danger.

5. The *depressa*, is an American goat, with small depressed horns, bent inwards and lying upon the head. It is about the size of a kid; and the hair is long and pendulous.

6. The *reversa*, is likewise an American goat, with erect horns curved back at the points. It is about the size of a kid of a year old.

7. The *gazella*, is an Indian goat, with long, erect, cylindrical horns, annulated near the base.

8. The *cervicapra*, is likewise an Indian goat, with plaited, cylindrical horns. The hair near the horns is longer than in any other part of the body.

9. The *Bezoartica*, or Bezoar-goat, is bearded, and has cylindrical, arched, and wholly annulated horns. It is a native of Persia. The bezoar is found in one of the stomachs called *abomasus*. See **BEZOAR**.

10. The *dorcas*, or antelope, has cylindrical, annulated horns, bent backward, contorted, and arising from the front between they eyes. It is a native of Africa and Mexico.

11. The *tartarica*, has cylindrical, strait, annulated horns, diaphanous at the points. It has no beard, and is found in the northern parts of Asia.

12. The *ammon*, has semicircular, plain, white horns, and no beard. It is about the size of a ram, and is a native of Siberia.

**CAPRAIA**, an island on the coast of Tuscany, about thirty miles south-west of Leghorn: E. long.  $11^{\circ}$ , and N. lat.  $43^{\circ} 15'$ .

**CAPRARIA**, in botany, a genus of the didynamia angiospermia class. The calix is divided into five segments; the corolla is bell-shaped, and divided into five parts; the capsule has two valves, and contains many seeds. There are three species, none of them natives of Britain.

**CAPRAROLA**, a town of St Peter's patrimony in Italy, about twenty miles north of the city of Rome, and eight south of Viterbo: E. long.  $13^{\circ}$ , and N. lat.  $42^{\circ} 20'$ .—It is a bishop's see.

**CAPRI**, or **CAPREA**, a city and island at the entrance of the gulf of Naples, about twenty miles south of that city: E. long.  $14^{\circ} 50'$ , and N. lat.  $40^{\circ} 45'$ .

The island is only four miles long, and one broad; the city is a bishop's see, situated on a high rock, at the west end of the island.

**CAPRICORN**, in zoology. See **MORDELLA**.

**CAPRICORN beetle**. See **CERAMBYX**.

**CAPRICORN**, in astronomy, one of the twelve signs of the zodiac.

**Tropic of CAPRICORN**, a lesser circle of the sphere, which is parallel to the equinoxial, and at  $23^{\circ} 30'$  distance from it southwards.

**CAPRIFICATION**, a method used in the Levant, for ripening the fruit of the domestic fig-tree, by means of insects bred in that of the wild fig-tree.

It is said, that these figs will never come to maturity, unless wounded by the insects depositing their eggs. Possibly the reason of this effect, may be their lacerating the vessels of the fruit, and thereby deriving thither a greater quantity of nutritious juice.

Plumbs and pears, wounded in the same manner, are found to ripen soonest, and the pulp about the wound has a more exquisite taste than the rest.

**CAPRIFICUS**, in botany. See **FIGUS**.

**CAPRIFOLIUM**, in botany. See **LONICERA**.

**CAPRIMULGUS**, **GOAT-SUCKER**, or **FERN-OWL**, in ornithology, a genus of birds belonging to the order of passerines. The beak is incurvated, small, tapering, and depressed at the base; the hairs at the mouth, which it opens very wide, are placed in a row. There are two species, *viz.* the *Europæus*, with the tubes of the nostrils hardly visible. It is a native of Europe, and feeds upon moths and nocturnal insects. This bird is said to suck goats in the night. See **Pl. 63.** 2. The *Americanus*, has the tubes of the nostrils very conspicuous. This is a night-bird, and is found in America.

**CAPRIOLES**, in the menage, leaps that a horse makes in the same place, without advancing, in such a manner, that when he is at the height of the leap, he jerks out with his hinder legs even and near. It is the most difficult of all the high menage. It differs from a croupade in this, that in a croupade the horse does not shew his shoes; and from a ballotade, because in this he does not jerk out. To make a horse work well at caprioles, he must be put between two pillars, and taught to raise first his fore-quarters, and then his hind-quarters, while his fore are yet in the air, for which end you must give the whip and the poinçon.

**CAPSICUM**, or **GUINEA-PEPPER**, a genus of the pentandria monogynia class. The corolla is rotated, and the berry wants juice. There are two species, both natives of the Indies. The seeds are used in sauces and pickles.

**CAPSQUARES**, in gunnery, strong plates of iron which come over the trunnions of a gun, and keep it in the carriage.

They are fastened by a hinge to the prize-plate, that they may lift up and down, and form a part of an arch in the middle to receive a third part of the thickness of the trunnions; for two thirds are let into the carriage, and the other end is fastened by two iron wedges, called the fore-locks and keys.

**CAPSTAN**, or **MAIN-CAPSTAN**, in a ship, a great piece of timber in the nature of a windlass, placed next behind the main-mast, its foot standing in a step on the lower deck, and its head between the upper decks; formed into several squares with holes in them. Its

use

use is to weigh the anchors, to hoist up or strike down top-masts, to heave any weighty matter, or to strain any rope that requireth a main force.

*Jear* CAPSTAIN is placed between the main-mast and the mizen, and serves to strain any rope, heave up on the jear rope or upon the wail, or hold off by at the weighing of an anchor.

CAPSTAN-*birs*, the pieces of wood that are put into the capstan-holes, to heave up any thing of weight into the ship.

*Panel of a* CAPSTAN, a short piece of iron made fast to the deck, and resting upon the whelps, to keep the capstan from recoiling, which is of dangerous consequence.

*Whelps of a* CAPSTAN are short pieces of wood, made fast to it, to keep the cable from coming too nigh, in turning it about.

*Pawling the* CAPSTAN, is stopping it from turning by means of the pawl.

*Come up* CAPSTAN, or *launch out the* CAPSTAN, that is, slacken the cable which you heave by.

CAPSULE, in a general sense, denotes a receptacle, or cover in form of a bag.

CAPSULE, among botanists, a species of pericarpium, or seed-vessel, composed of several dry elastic valves, which usually burst open at the points, when their seeds are ripe: It differs from a pod, in being roundish and short. This kind of pericarpium sometimes contains one cell or cavity, sometimes more: In the first case it is called unilocular, as it is bilocular, trilocular, &c. when it contains two, three, &c. cells or cavities.

CAPSULÆ *atrabiliiuricæ*, called also *glandulæ renales*, and *renes succenturiati*. See p. 269.

CAPTAIN, a military officer, whereof there are various kinds, according to their commands.

CAPTAIN *of a troop or company*, an inferior officer, who commands a troop of horse, or company of foot, under a colonel. In the same sense we say, captain of dragoons, of grenadiers, of marines, of invalids, &c.

In the horse and foot guards, the captains have the rank of colonels.

CAPTAIN *general*, he who commands in chief.

CAPTAIN *lieutenant*, he who with the rank of captain, but the pay of lieutenant, commands a troop or company in the name and place of some other person who is dispensed with on account of his quality from performing the functions of his post.

Thus the colonel, being usually captain of the first company of his regiment; that company is commanded by his deputy, under the title of captain-lieutenant.

So in England, as well as in France, the king, queen, dauphin, princes, &c. have usually the title of captains of the guards, *gens d'armes*, &c. the real duty of which offices is performed by captain-lieutenants.

CAPTAIN *reformed*, one who, upon the reduction of the forces, has his commission and company suppressed; yet is continued captain, either as second to another, or without any post or command at all.

CAPTAIN *of militia*, he who commands a company of the militia, or trained bands. See MILITIA.

CAPTAIN *of a ship of war*, the commanding officer of a ship, galley, fire-ship, or the like. This officer ranks with a colonel in the land-service.

CAPTAIN *of a merchant-ship*, he who has the direction of the ship, her crew, and lading, &c. In small ships and short voyages, he is more ordinarily called the master. In the mediterranean, he is called the patron.

The proprietor of the vessel appoints the captain or master, and he is to form the crew, and chuse and hire the pilots, mates, and seamen; though, when the proprietor and master reside on the same spot, they generally act in concert together.

CAPTAIN BASHAW, or CAPONDAN BASHAW, in the polity of the Turks, signifies the Turkish high admiral. He possesses the third office of the empire, and is invested with the same power at sea that the vizir has on shore. Soliman II. instituted this office in favour of the famous Barbarossa, with absolute authority over the officers of the marine and arsenal, whom he may punish, cashier, or put to death, as soon as he is without the Dardanelles. He commands in chief in all the maritime countries, cities, castles, &c. and, at Constantiaople, is the first magistrate of police in the villages on the side of the Poite, and the canal of the Black-sea. The mark of his authority is a large Indian cane, which he carries in his hand, both in the arsenal and with the army.

The captain-bashaw enjoys two sorts of revenues; the one fixed, the other casual. The first arise from a capitation of the islands in the Archipelago, and certain governments in Natolia and Galipoli. The latter consist in the pay of the men who die during a campaign; in a fifth of all prizes made by the begs; in the profits accruing from the labour of the slaves, whom he hires as rowers to the grand lignior; and in the contributions he exacts in all places where he passes.

CAPTION, in Scots law, a writ issuing under his majesty's signet, in his majesty's name, obtained at the instance of a creditor in a civil debt, commanding messengers at arms and other officers of the law to apprehend and imprison the person of the debtor until he pay the debt. See SCOTS LAW, title, *Sentences and their execution*.

CAPTIVITY, a punishment which God inflicted upon his people for their vices and infidelities. The first of these captivities is that of Egypt, from which Moses delivered them; after which, are reckoned six during the government of the judges; but the greatest and most remarkable, were those of Judah and Israel, which happened under the kings of each of these kingdoms. It is generally believed, that the ten tribes of Israel never came back again after their dispersion; and Josephus and St Jerom are of this opinion: nevertheless, when we examine the writings of the prophets, we find the return of Israel from captivity pointed out in a manner almost as clear as that of the tribes of Benjamin and Judah. See Hosea i. 10. xi. 12. Amos ix. 14. Isaiah xi. 13, 14. Ezekiel xxxvii. 16, &c.

The

The captivities of Judah are generally reckoned four; the fourth and last of which fell in the year of the world 3416, under Zedekiah; and from this period begins the seventy years captivity, foretold by Jeremiah.

Since the destruction of the temple by the Romans, the Hebrews boast, that they have always had their heads, or particular princes, whom they call princes of the captivity, in the east and west. The princes of the captivity in the east governed the Jews who dwelt at Babylon, in Chaldea, Assyria, and Persia; and the prince of the captivity in the west governed those who dwelt in Judea, Egypt, Italy, and in other parts of the Roman empire. He who resided in Judæa, took up his abode commonly at Tiberias, and assumed the title of Roschabboth, head of the fathers or patriarchs. He presided in assemblies, decided in cases of conscience, levied taxes for the expences of his visits, and had officers under him, who were dispatched through the provinces, for the execution of his orders. As to the princes of the captivity of Babylon, or the east, we know neither the original nor succession of them; it appears only, that they were not in being before the end of the second century.

**CAPTURE** signifies, particularly, prizes taken by privateers in time of war.

**CAPUA**, a city of the province of Lavoro, in the kingdom of Naples, situated on the river Volturno, about fifteen miles north-west of the city of Naples: E. long. 15°, and N. lat. 41° 20'.

It is the see of an archbishop.

**CAPUCHINS**, in the church of Rome. See **FRANCISCANS**.

**CAPUT mortuum**, in chemistry, that thick dry matter which remains after distillation of any thing, but of minerals especially.

**CAPY-BARA**, in zoology. See **SUS**.

**CARBINE**, a fire-arm, shorter than a musket, carrying a ball of twenty-four in the pound, borne by the light-horse, hanging at a belt over the left shoulder.

The barrel is two feet and a half long, and is sometimes furrowed spirally within, which is said to add to the range of the piece.

**CARABINEERS**, or **CARABINIERS**, regiments of light horse, carrying longer carbines than the rest, and used sometimes on foot.

**CARABUS**, in zoology, a genus of insects belonging to the order of insecta coleoptera. The feelers are bristly; the breast is shaped like a heart, and margined; and the elytra are likewise margined. There are 43 species of this genus, mostly distinguished by their colour.

**CARACATY**, a large country in the north of Asia, extending from the wall of China to the ancient Mogolistan.

**CARACOL**, in the menage. the half turn which a horseman makes, either to the right or left.

In the army, the horse always make a caracol after each discharge, in order to pass to the rear of the squadron.

VOL. II. No. 31.

**CARACOL**, in architecture, denotes a stair-case in a helix or spiral form.

**CARACOLI**, a kind of metal, of which the Caribbees, or natives of the Lesser Antilles, make a sort of ornament in the form of a crescent, which they also call caracoli.

This metal comes from the main land; and the common opinion is, that it is a compound of silver, copper, and gold, something like the Corinthian brass among the ancients. These metals are so perfectly mixed and incorporated together, that the compound which results from them, it is said, has a colour that never alters, how long soever it remains in the sea, or under ground. It is something brittle, and they who work at it, are obliged to mix a large proportion of gold with it, to make the compound more tough and malleable.

**CARACT**, **CARAT**, or **CARRAT**, the name of that weight which expresses the degree of fineness that gold is of.

The mint-masters, or custom, have fixed the purity of gold at 24 caracts; though it is not possible so to purify and refine that metal, but it will want still about one fourth part of a caract in absolute purity and perfection. The caract is divided into  $\frac{1}{4}$ ,  $\frac{1}{8}$ ,  $\frac{1}{16}$ , and  $\frac{1}{32}$ . These degrees serve to distinguish the greater or lesser quantity of alloy therein contained; for instance, gold of 22 caracts, is that which has two parts of silver, or of any other metal, and 22 of fine gold.

**CARACT** is also a certain weight which goldsmiths and jewelers use wherewith to weigh precious stones and pearls.

This caract weighs four grains, but something lighter than the grains of other weights. Each of these grains is subdivided into  $\frac{1}{4}$ ,  $\frac{1}{8}$ ,  $\frac{1}{16}$ ,  $\frac{1}{32}$ , &c.

**CARAGROUGH**, in commerce, a silver-coin of the empire, weighing nine drachms. It goes at Constantinople for 120 aspers. There are four sorts of them, which are all equally current, and of the same value.

**CARAGUATA**, in botany. See **TILLANDSIA**.

**CARAITES**, in the ecclesiastical history of the Jews, a religious sect among that people, who adhere closely to the text and letter of the scriptures, rejecting the rabbinical interpretations, and the cabbala. The Caraites pass for the most learned of the Jewish doctors; they are chiefly to be met with in Poland, Muscovy, and the east: they are but few in comparison of the bulk of the Jews, who are of the party of the rabbins: the latter have so great an aversion for the Caraites, that they will have no alliance, nor even conversation with them: they treat them as bastards; and if a carait would turn rabbinist, the other Jews would not receive him.

**CARAMANIA**, a province of Natolia, in Asia, situated on the Mediterranean sea, opposite to the island of Cyprus.

**CARAMANICO**, a large well-peopled town of the kingdom of Naples. in the hither Abruzzo.

**CARAMANTA**, the name of a province of South America, bordered on the north by the district of Carthagena;

thagena; on the east, by New Grenada; and on the south and west, by Popayan.

**CARAMANTA** is also the name of the capital of that province, situated in  $5^{\circ} 18'$  N. lat.

**CARANNA**, a resinous substance brought from New Spain in little masses rolled up in leaves of flags. It is rarely kept in the shops, and is rejected by the catalogue of the London college, though it is still retained in the Edinburgh.

**CARAPO**, in ichthyology, the trivial name of a species of gymnotus. See **GYMNOTUS**.

**CARAVAN**, or **CARAVANNE**, in the east, signifies a company or assembly of travellers and pilgrims, and more particularly of merchants, who, for their greater security, and in order to assist each other, march in a body through the deserts, and other dangerous places, which are infested with Arabs or robbers.

There is a chief, or aga, who commands the caravan, and is attended by a certain number of janizaries, or other militia, according to the countries from whence the caravans set out; which number of soldiers must be sufficient to defend them and conduct them with safety to the places for which they are designed, and on a day appointed. The caravan encamps every evening near such wells or brooks, as their guides are acquainted with; and there is a strict discipline observed upon this occasion, as in armies in time of war. Their beasts of burden are partly horses, but most commonly camels, who are capable of undergoing a very great fatigue.

**CARAVANSERA**, or **KARAVANSERA**, a place appointed for receiving and loading the caravans.

It is commonly a large square building, in the middle of which there is a very spacious court; and under the arches or piazzas that surround it there runs a bank, raised some feet above the ground, where the merchants, and those who travel with them in any capacity, take up their lodgings as well as they can; the beasts of burden being tied to the foot of the bank. Over the gates, that lead into the court, there are sometimes little rooms, which the keepers of the caravanseras let out at a very high price to such as have a mind to be private.

The caravanseras in the east are something in the nature of the inns in Europe, only that you meet with little accommodation either for man or beast, but are obliged to carry almost every thing with you: there is never a caravansera without a well, or spring of water. These buildings are chiefly owing to the charity of the Mahometans; they are esteemed sacred dwellings, where it is not permitted to insult any person, or to pillage any of the effects that are deposited there. They even carry their precautions so far, as not to suffer any man who is not married to lodge there; because they are of opinion, that a man who has no wife is more dangerous than another.

**CARAVANSERASKIER**, the steward, or keeper of a caravansera.

He keeps an account of all the merchandises that are sold upon trust, and demands the payments of the

sums due to the merchants for what has been sold in the caravansera, on the seller's paying *two per cent*.

**CARAWAY**, in botany. See **CARUM**.

**CARBUNCLE**, in natural history, a very elegant gem, whose colour is deep red, with an admixture of scarlet.

This gem was known among the ancients by the name of anthrax. It is usually found pure and faultless, and is of the same degree of hardness with the sapphire: it is naturally of an angular figure, and is found adhering, by its base, to a heavy and ferruginous stone of the emery kind: its usual size is near a quarter of an inch in length, and two thirds of that in diameter in its thickest parts: when held up against the sun, it loses its deep tinge, and becomes exactly of the colour of a burning charcoal, whence the propriety of the name which the ancients gave it. It bears the fire unaltered, not parting with its colour, nor becoming at all the paler by it. It is only found in the East Indies, so far as is yet known, and there but very rarely.

**CARBUNCLE**, or **ANTHRAX**, in surgery, an inflammation which arises, in time of the plague, with a vesicle or blister almost like those produced by burning.

**CARBUNCLE**, in heraldry, a charge or bearing, consisting of eight radii, four whereof make a common cross, and the other four a saltier.

Some call these radii buttons, or staves, because round, and enriched with buttons, or pearly like pilgrims staves, and frequently tipped or terminated with flower-de-luces; others blazon them, royal sceptres, placed in saltier, pale and fesse.

**CARCHARIAS**, in ichthyology. See **SQUALUS**.

**CARCASSE**, or **CARCASS**, in the art of war, an iron-cask, or hollow capacity, about the bigness of a bomb, of an oval figure, made of ribs of iron, filled with combustible matters, as meal-powder, saltpetre, sulphur, broken glass, shavings of horns, turpentine, tallow, &c.; the design of it is to be thrown out of a mortar to set houses on fire, and do other execution. It has two or three apertures through which the fire is to blaze.

**CARCASSONE**, a town of Languedoc, in France, situated on the river Aude, about twenty-five miles west of Narbonne: E. long.  $2^{\circ}$ , and N. lat.  $43^{\circ} 20'$ . It is a bishop's see.

**CARCERES**, in the ancient Circensian games, were inclosures, in the circus, wherein the horses were restrained till the signal was given for starting, when, by an admirable contrivance, they all at once flew open.

**CARCINOMA**. See **CANKER**.

**CARD**, among artificers, an instrument consisting of a block of wood, beset with sharp teeth, serving to arrange the hairs of wool, flax, hemp, and the like: there are different kinds of them, as hand-cards, stock-cards, &c.

**CARDS**, among gamesters, little pieces of fine thin pasteboard of an oblong figure, of several sizes, but most commonly in England three inches and an half long, and two and an half broad, on which are painted several points and figures.

The



The moulds and blocks for making cards, are exactly like those that were used for the first books: they lay a sheet of wet or moist paper on the block, which is first slightly done over with a sort of ink made with lamp-black diluted in water, and mixed with some starch to give it a body. They afterwards rub it off with a round list. The court-cards are coloured by means of several patterns, styled *stanc-filles*. These consist of papers cut through with a pen-knife, and in these apertures they apply severally the various colours, as red, black, &c. These patterns are painted with oil-colours, that the brushes may not wear them out; and when the pattern is laid on the paste-board, they slightly pass over it a brush full of colour, which, leaving it within the openings, forms the face or figure of the card.

Cards, upon sufficient security, may be exported without payment of the stamp-duty; but for every pack sold without the label of the stamp-office, in England, there is a penalty of 10l.

**CARDAMINDUM**, in botany. See **TROPÆOLUM**.

**CARDAMINE**, **LADY'S SMOCK**, in botany, a genus of the tetradynamia siliquosa class. The pod opens with a spring, and the valves are revolved: The stigma is entire; and the calix gapes a little. There are fifteen species, seven of which are natives of Britain, viz. the bellidifolia, or daisy-leaved lady's-smock; the petræa, or mountain lady's-smock; the pratensis, or common lady's-smock; the amara, bitter cresses, or lady's-smock; the impatiens, or impatient lady's-smock; the parviflora, or small-flowered lady's-smock; and the hirsuta, or hairy lady's-smock.

**CARDAMOM**, in materia medica, the seeds of a species of animum. They are distinguished into the lesser and greater. The greater cardamom is a dried fruit or pod containing two rows of small triangular seeds of a warm aromatic flavour. The lesser is about half the size of the former, and the seeds are considerably stronger both in smell and taste. Hence this sort is the only one now used as a medicine. The seeds are warm, grateful, pungent, aromatic, and frequently employed as such in practice.

**CARDIAC**, an appellation given to such medicines as are supposed to preserve or increase the strength of the heart.

**CARDIACA**, in botany. See **LEONURUS**.

**CARDIALGIA**, the **HEART-BURN**, in medicine, a disorder of the stomach attended with anxiety, a nausea, and often a reaching or actual vomiting. See **MEDICINE**.

**CARDIFF**, a borough-town of Glamorganshire, in south Wales, situated on the river Tawe, about two miles south-east of Landaff: W. long. 3° 20', N. lat. 51° 30'. It sends only one member to parliament.

**CARDIGAN**, the capital of Cardiganshire, near the mouth of the river Tivy and the Irish channel, about thirty miles north of Pembroke: W. long. 4° 40', N. lat. 52° 15'. It gives the title of earl to the noble family of Brudenel, and sends only one member to parliament.

**CARDINAL**, in a general sense, an appellation given to things on account of their pre-eminence: thus we say, cardinal virtues, &c.

**CARDINAL SIGNS** in the zodiac, are Aries, Libra, Cancer, and Capricorn.

**CARDINAL**, more particularly signifies an ecclesiastical prince in the Romish church, being one who has a voice in the conclave at the election of a pope. The cardinals were originally nothing more than deacons, to whom was intrusted the care of distributing the alms to the poor of the several quarters of Rome; and as they held assemblies of the poor in certain churches of their several districts, they took the title of these churches. They began to be called cardinals in the year 300, during the pontificate of St Sylvester, by which appellation was meant the chief priests of a parish, and next in dignity to a bishop. This office grew more considerable afterwards, and by small degrees arrived at its present height, in which it is the reward of such as have served his holiness well, even princes thinking it no diminution of their honour to become members of the college of cardinals.

The cardinals compose the pope's council, and till the time of Urban VIII. were styled *most illustrious*; but by a decree of that pope in 1630, they had the title of *eminence* conferred upon them.

At the creation of a new cardinal, the pope performs the ceremony of shutting and opening his mouth, which is done in a private consistory. The shutting his mouth, implies the depriving him of the liberty of giving his opinion in congregations; and the opening his mouth, which is performed fifteen days after, signifies the taking off this restraint. However, if the pope happens to die during the time a cardinal's mouth is shut, he can neither give his voice in the election of a new pope, nor be himself advanced to that dignity.

The cardinals are divided into six classes or orders, consisting of six bishops, fifty priests, and fourteen deacons, making in all seventy; which constitute the sacred college. The number of cardinal-bishops has very seldom been changed, but that of priests and deacons have varied at different times.

The privileges of the cardinals are very great: They have an absolute power in the church during the vacancy of the holy see: They have a right to elect the new pope, and are the only persons on whom the choice can fall: Most of the grand offices in the court of Rome are filled by cardinals. The dress of a cardinal is a red soutanne, a rochet, a short purple mantle, and the red hat. When they are sent to the courts of princes, it is in quality of legates *a latere*; and when they are appointed governors of towns, their government is called by the name of legation.

**CARDINAL** is also a title given to some bishops, as those of Mentz and Milan, to the archbishop of Bourges; and the abbot of Vendome calls himself *cardinalis natus*.

**CARDINAL'S FLOWER**. See **RAPUNTIUM**.

**CARDIROID**, in the higher geometry, an algebraical curve, so called from its resemblance to a heart.

**CARDIOS**.

- CARDIOSPERMUM**, in botany, a genus of the octandria trigynia class. The calix has four leaves; there are four petals; an unequal four-leaved nectarium; and there are three inflated capsules. There are two species, both natives of the Indies.
- CARDIUM**, in zoology, a genus of insects belonging to the order of vermes testacea. The shell consists of two equal valves, and the sides are equal. There are 21 species of this genus.
- CARDONNA**, a city of Catalonia, in Spain, situated on a river of the same name, about forty miles north-west of Barcelona: E. long.  $1^{\circ} 20'$ , N. lat.  $41^{\circ} 35'$ .
- CARDUEL**, a province of Georgia, in Asia, lying between the Caspian and Euxine seas, the capital whereof is Teflis. It belongs partly to the Turks, and partly to the Persians.
- CARDUELIS**, in ornithology, a synonyme of a species of fringilla. See **FRINGILLA**.
- CARDUUS**, in botany, a genus of the syngenesia polygamia æqualis class. The calix is ovated, and imbricated with spinous scales; and the receptacle is hairy. There are 26 species, ten of which are natives of Britain, viz. the lanceolatus, or spear-thistle; the nutans, or milk-thistle; the acanthoides, or welsted-thistle; the crispus, or thistle upon thistle; the palustris, or marsh-thistle; the dissectus, or English soft thistle; the helenioides, or melancholy thistle; the marianus, or milk-thistle; and the acaulos, or dwarf carline-thistle.
- CAREENING**, in the sea-language, the bringing a ship to lie down on one side, in order to trim and caulk the other side.  
A ship is said to be brought to the careen, when the most of her lading being taken out, she is halled down on one side by a small vessel as low as necessary; and there kept by the weight of the ballast, ordnance, &c. as well as by ropes, lest her masts should be strained too much; in order that her sides and bottom may be trimmed, seams caulked, or any thing that is faulty under water mended. Hence when a ship lies on one side when she sails, she is said to sail on the careen.
- CARELIA**, in geography, a province of Finland, bounded by the province of Savolaxia on the north, and by the gulph of Finland on the south. It is subject to Russia.
- CARELSCROON**, a port-town of the province of Gothland, in Sweden, situated on the coast of the Baltic: E. long.  $15^{\circ}$ , and N. lat.  $56^{\circ} 20'$ .  
It is an excellent harbour, where the Swedes lay up their royal navy.
- CARENTAN**, a town of Normandy, in France, situated at the mouth of a river of the same name: W. long.  $1^{\circ} 15'$ , and N. lat.  $49^{\circ} 20'$ .
- CARET**, among grammarians, a character marked thus  $\wedge$ , signifying that something is added on the margin, or interlined, which ought to have come in where the caret stands.
- CARETTA**, in zoology, the trivial name of a species of testudo. See **TESTUDO**.
- CAREX**, in botany, a genus of the monocæcia triandria class. The amenum of the male is imbricated; it has no corolla; and the calix consists of one leaf. The amenum of the female is likewise imbricated; the corolla is wanting; and the calix consists of one leaf; the nectarium is inflated and three-toothed; there are three stigmata; and the seeds are triangular and contained within the nectarium. There are 37 species, 26 of which are natives of Britain.
- CARGADORS**, a name which the Dutch give to those brokers, whose business is to find freight for ships outward bound, and to give notice to the merchants, who have commodities to send by sea, of the ships that are ready to sail, and of the places for which they are bound.
- CARGAPOL**, or **KARGAPOL**, the capital of a territory of the same name, in the province of Dwina, in Muscovy: E. long.  $36^{\circ}$ , and N. lat.  $63^{\circ}$ .
- CARGO** denotes all the merchandises and effects which are laden on board a ship.  
*Super-CARGO*, a person employed by merchants to go a voyage, and oversee the cargo, and dispose of it to the best advantage.
- CARIAMA**, in ornithology, a synonyme of the palamedæ. See **PALAMEDÆA**.
- CARIBBE-ISLANDS**, a cluster of islands, situated in the Atlantic ocean, between  $59^{\circ}$  and  $63^{\circ}$  W. long. and between  $11^{\circ}$  and  $18^{\circ}$  N. lat. They belong partly to the British, and partly to the French, Dutch, &c.
- CARIBBIANA**, or **CARIBIANA**, the north east coast of Terra-firma, in south America, otherwise called New-Andalusia. See **ANDALUSIA**.
- CARICA**, in botany, a genus of the diœcia decandria class. The male has hardly any calix; the corolla is bell-shaped, and divided into five segments; the filaments are inserted into the tube of the corolla, and are alternately shorter. The calix of the female has five teeth; the corolla consists of five petals; there are five stigmata; and the berry is unilocular, and contains many seeds.
- CARICATURA**, in painting, denotes the concealment of real beauties, and the exaggeration of blemishes, but still so as to preserve a resemblance of the object.
- CARICOUS**, an epithet given to such tumours as resemble the figure of a fig. They are frequently found in the piles.
- CARIES**, in surgery, the corruption or mortification of a bone. See **SURGERY**.
- CARIGNAN**, a fortified town of Piedmont, situated on the river Po, about seven miles south of Turin: E. long.  $7^{\circ} 25'$ , and N. lat.  $44^{\circ} 30'$ .
- CARIGUE**, or **CARIGUEYA**, in zoology, a synonyme of a species of didelphis. See **DIDELPHIS**.
- CARINTHIA**, a duchy in the circle of Austria, in Germany, bounded by the archbishopric of Saltzburg on the north, and by Carniola and the dominions of Venice on the south. It is subject to the house of Austria.
- CARIONOLA**, a city of the province of Lavoro, in the

the kingdom of Naples, about twenty miles north of the city of Naples : E. long. 15°, and N. lat. 41° 20'. It is a bishop's see.

**CARIPI**, a kind of cavalry in the Turkish army.

The caripi, to the number of about one thousand, are not slaves, nor bred up in the seraglio, like the rest, but are generally Moors, or renegado Christians, who, having followed adventures, and being poor, and having their fortune to seek by their dexterity and courage, have arrived to the rank of horse-guards to the grand signior.

**CARISHROOK-CASTLE**, a castle situated in the middle of the isle of Wight, where king Charles I. was imprisoned : W. long. 1° 30', and N. lat. 50° 40'.

**CARKE** denotes the thirtieth part of a farplar of wool. See **SARPLAR**.

**CARLINA**, or **CARLINE THISTLE**, in botany, a genus of the syngenesia polygamia æqualis class. The calix is radiated, with long coloured scales. There are seven species, only one of which, viz. the vulgaris, is a native of Britain. The roots are said to be diaphoretic and alexipharmic.

**CARLINE**, or **CAROLINE**, a silver coin, current in the Neapolitan dominions, and worth about four-pence of our money.

**CARLINGFORD**, a port-town of Ireland, in the county of Lowth, and province of Leinster, about twenty-two miles north of Drogheda : W. long. 6° 23', and N. lat. 54° 5'.

**CARLINGS**, or **CARLINES**, in a ship, two pieces of timber, lying fore and aft, along from beam to beam, whereon the ledges rest on which the planks of the ship are fastened. All the carlings have their ends let into the beams culvertail-wise : They are directly over the keel, and serve as a foundation for the whole body of the ship.

**CARLISLE**, the capital city of Cumberland, situated near the mouth of the river Eden, and the Solway frith : W. long. 2° 30', and N. lat. 54° 45'.

It is a bishop's see.

**CARLOCK**, in commerce, a sort of ising-glass made with the sturgeon's bladder, imported from Archangel. The chief use of it is for clarifying wine ; but it is also used by dyers. The best carlock comes from Astracan, where a great quantity of sturgeon is caught.

**CARLOWITZ**, a town of Sclavonia, situated on the west side of the Danube, about thirty-five miles north-west of Belgrade : E. long. 20° 45', and N. lat. 45° 25'.

**CARLSTADT**, the capital of Croatia, a frontier province of Christendom against the Turks : E. long. 16°, and N. lat. 45° 5'. It is subject to the house of Austria.

**CARLSTADT** is also the name of a town in the bishopric of Wurzburg, in the circle of Franconia in Germany, situated on the river Maine, about fourteen miles north of Wurzburg : E. long. 9° 50', and N. lat. 50°.

**CARMAGNIOL**, a fortified town of Piedmont, situated on the river Po, about ten miles south of Turin : E. long. 7° 30', and N. lat. 44° 45'.

VOL. II. No. 31.

3

**CARMELITES**, or **WHITE FRIERS**, are an order of our lady of Mount Carmel, making one of the four orders of mendicants. They pretend to derive their original from the prophets Elijah and Elisha. Their original rules contained sixteen articles, one of which confined them to their cells, and enjoined them to employ themselves day and night in prayer ; another prohibited the brethren having any property ; another enjoined fasting, from the feast of the exaltation of the holy cross till Easter, excepting on Sundays ; abstinence at all times from flesh, was enjoined by another article ; one obliged them to manual labour ; another imposed a strict silence on them, from vespers till the tierce the next day : However, these constitutions have been in some respects altered.

This order is so much increased, that it has at present thirty-eight provinces, besides the congregation of Mantua (in which there are fifty-four monasteries, under a vicar-general) and the congregation of bare-footed Carmelites in Italy and Spain, which have their peculiar generals.

If a monk of this order lie with a woman, he is prohibited saying mass for three or four years, is declared infamous, and obliged to discipline himself publicly once a week : If he is again guilty of the same offence, his penance is doubled : And if a third time, he is expelled to order.

**CARMENTALIA**, feasts celebrated by the Romans, in honour of the prophetess Carmenta, the mother of Evander.

They were solemnized twice in the month of January, viz. on the 11th and 15th.

**CARMINATIVES**, in pharmacy, medicines used in colics, or other flatulent disorders, to dispel the wind.

The four carminative flowers are those of camomile, melilot, motherwort, and dill ; besides, angelica, fennel, lovage, anise, caraway, coriander, cummin, &c. all agree in their carminative qualities, and are therefore used in compositions of that intention.

**CARMINE**, a powder of a very beautiful red colour, bordering upon purple, and used by painters in miniature ; though but rarely, because of its great price.

It is extracted from cochineal, by means of water, wherein chouan and antour have been infused ; some add rocou, but this gives it too much of the oval cast. Others make carmine with brasil-wood, fernambouc, and leaf-gold, beat in a mortar, and steeped in white-wine vinegar ; the scum arising from this mixture, upon boiling, when dried, makes carmine ; but this kind is vastly inferior to the former : There is another carmine, made of brasil-wood and fernambouc, by a different preparation.

**CARMONA**, a town of Andalusia in Spain, about seventeen miles east of Sevil : W. long. 5° 35', N. lat. 37° 20'.

**CARNARVON**, a borough-town of Carnarvonshire, in north Wales, about five miles south-west of Bangor : W. long. 4° 25', and N. lat. 53° 20'. It gives the title of earl to the noble family of Bridges ; and sends one member to parliament.

†

K

CARNA-

**CARNATION**, in botany. See **CARYOPHYLLUS**.

**CARNATION-colour**, among painters, is understood of all the parts of a picture, in general, which represent flesh, or which are naked and without drapery.

In colouring for flesh, there is so great a variety, that it is hard to lay down any general rules for instruction therein; neither are there any regarded by those who have acquired a skill this way: The various colouring for carnations, may be easily produced, by taking more or less red, blue, yellow, or bistre, whether for the first colouring, or for the finishing: The colour for women should be bluish, for children a little red, both fresh and gay; and for the men it should incline to yellow, especially if they are old.

**CARNELIAN**, in natural history, a precious stone, of which there are three kinds, distinguished by three colours, a red, a yellow, and a white. The red is very well known among us, and is found in roundish or oval masses, much like our common pebbles; and is generally met with between an inch and two or three inches in diameter: It is of a fine, compact, and close texture, of a glossy surface; and, in the several specimens, is of all the degrees of red, from the palest flesh-colour to the deepest blood-red. It is generally free from spots, clouds, or variegations; but sometimes it is veined very beautifully with an extremely pale red, or with white; the veins forming concentric circles, or other less regular figures, about a nucleus, in the manner of those of agates. The pieces of carnelian which are all of one colour, and perfectly free from veins, are those which our jewellers generally make use of for seals, though the variegated ones are much more beautiful. The carnelian is tolerably hard, and capable of a very good polish: It is not at all affected by acid menstrua: The fire divests it of a part of its colour, and leaves it of a pale red; and a strong and long continued heat will reduce it to a pale dirty gray.

The finest carnelians are those of the East Indies; but there are very beautiful ones found in the rivers of Silesia and Bohemia; and we have some not despicable ones in England.

Though the ancients have recommended the carnelian as astringent, and attributed a number of fanciful virtues to it, we know no other use of the stone, than the cutting seals on it, to which purpose it is excellently adapted, as being not too hard for cutting, and yet hard enough not to be liable to accidents, to take a good polish, and to separate easily from the wax.

**CARNERO**, in geography, a name given to that part of the gulf of Venice, which extends from the western coast of Istria to the island of Grossa and the coast of Morlachia.

**CARNERO** is likewise the name of the cape to the west of the mouth of the bay of Gibraltar.

**CARNIOLA**, a territory of Austria, in Germany, bounded by Carinthia and Stiria on the north, and by the dominions of Venice on the south.

**CARNIVAL**, or **CARNAVAL**, a time of rejoicing, a season of mirth, observed with great solemnity by the

Italians, particularly at Venice, holding from twelfth-day till lent.

Festivals, balls, operas, concerts of music, intrigues, marriages, &c. are chiefly held in carnival-time. The carnival begins at Venice the second holiday in Christmas: Then it is they begin to wear masks, and open their play-houses and gaming-houses; the Place of St Mark is filled with mountebanks, jack-puddings, pedlars, whores, and such like mob, who flock thither from all parts: There have been no less than seven sovereign princes, and thirty thousand foreigners here, to partake of these diversions.

**CAROB-tree**. See **CERATONIA**.

**CAROLINA**, a province of N. America, belonging to Great Britain: It is situated, comprehending Georgia, between 75° and 86° W. long. and between 31° and 36° N. lat. and bounded by Virginia on the north, by the Atlantic ocean on the east, by Spanish Florida on the south, and by the Apalachian mountains on the west; or rather extends westward, without any limits. It is divided into three distinct governments, *viz.* North and South Carolina, and Georgia.

**CAROLINE-books**, the name of four books, composed by order of Charlemagne, to refute the second council of Nice. These books are couched in very harsh and severe terms, containing one hundred and twenty heads of accusation against the council of Nice, and condemning the worship of images.

**CAROLSTAT**, a town of Gothland in Sweden, situated at the north end of the Wener-lake, about one hundred and forty miles west of Stockholm: E. long. 13° 30', and N. lat. 59° 40'.

**CAROLUS**, an ancient English broad piece of gold, struck under Charles I. its value has of late been at twenty-three shillings sterling, though at the time it was coined, it is said to have been rated at twenty shillings.

**CAROLUS**, a small copper coin, with a little silver mixed with it, struck under Charles VIII. of France.

The carolus was worth twelve deniers, when it ceased to be current.

Those which are still current in trade, in Lorraine, or in some neighbouring provinces, go under the name of French sols.

**CAROTID arteries**, in anatomy. See p. 226.

**CARP**, in ichthyology, the English name of a species of cyprinus. See **CYPRINUS**.

**CARPENTRY**, the art of cutting, framing, and joining large pieces of wood, for the uses of building. It is one of the arts subservient to architecture, and is divided into house-carpentry and ship-carpentry: The first is employed in raising roofing, flooring of houses, &c. and the second in the building of ships, barges, &c. The rules in carpentry are much the same with those of joinery; the only difference is, that carpentry is used in the larger coarser work, and joinery in the smaller and curious. See **JOINERY**.

**CARPET**, a sort of covering of stuff, or other materials, wrought with the needle or on a loom, which is part of the furniture of a house, and commonly spread over tables, or laid upon the floor.

Persian.

Persian and Turkey carpets are those most esteemed; though at Paris there is a manufactory after the manner of Persia, where they make them little inferior, not to say finer, than the true Persian carpets. They are velvety, and perfectly imitate the carpets which come from the Levant. There are also carpets of Germany, some of which are made of woollen stuffs, as serges, &c. and called square carpets: Others are made of wool also, but wrought with the needle, and pretty often embellished with silk; and lastly, there are carpets made of dog's hair. We have likewise carpets made in England, which are used either as floor-carpets, or to make chairs and other household furniture: It is true, we are not arrived at the like perfection in this manufacture with our neighbours the French; but may not this be owing to the want of the like public encouragement?

**CARPI**, a town of the Veronese in Italy, situated on the river Adige, twenty four miles south-east of Verona: E. long  $11^{\circ} 40'$ , and N. lat.  $45^{\circ} 10'$ .

**CARPINUS**, the **HORN-BEAN**, in botany, a genus of the monœcia polyandria class. The calix of the male is bell-shaped, and divided into five segments; it has no corolla; and the stamina are ten. The calix of the female has four teeth; there is no corolla; the styli are three; and the capsule has four valves, containing two seeds. There are but two species, both natives of America.

**CARPIO**, in ichthyology, the trivial name of a species of salmo and cyprinus. See **SALMO**, and **CYPRINUS**.

**CARPOBALSAM**, in the materia medica. the fruit of the tree which yields the true oriental balsam.

The caprobalsam is used in Egypt, according to Prosper Alpinus, in all the intentions for which the balsam itself is applied: But the only use the Europeans make of it is in venice-treacle and mithridate, and in these not a great deal; for cubebs and juniper-berries are generally substituted in its place.

**CARPOBOLUS**, in botany. See **LYCOPERDON**.

**CARPUS**, the **WRIST**, in anatomy. See p. 179, 180.

**CARR**, among the ancients, a kind of throne mounted on wheels, and used in triumphs and other solemn occasions.

**CARRIAGE**, a vehicle serving to convey persons, goods, merchandises, and other things from one place to another.

For the construction and mechanical principles of wheel-carriages, see **MECHANICS**.

**CARRIAGE of a cannon**, the frame or timber-work on which it is mounted, serving to point it for shooting, or to carry it from one place to another. It is made of two planks of wood, commonly one half the length of the gun, called the cheeks, and joined by three wooden transoms, strengthened with three bolts of iron. It is mounted on two wheels; but on a march has two fore-wheels, with limbers added. The principal parts of a Carriage are the cheeks, transoms, bolts, plates, train, bands, bridge, bed, hooks, trunion-holes, and capsquare.

**Block-CARRIAGE**, a cart made on purpose for carrying mortars and their beds from place to place.

**Truck-CARRIAGE**, two short planks of wood supported on two axle-trees, having four trucks of solid wood for carrying mortars or guns upon battery, where their own carriages cannot go. They are drawn by men.

**CARRICK**, the most southerly division of the shire of Air in Scotland.

**CARRICK on the Sure**, a town of Ireland, in the county of Tipperary, and province of Munster, about fourteen miles north-west of Waterford: W. long.  $7^{\circ} 24'$ , and N. lat.  $52^{\circ} 16'$ .

**CARRICK-FERGUS**, a town in the county of Antrim, and province of Ulster, in Ireland, about eighty-five miles north of Dublin: W. long.  $6^{\circ} 15'$ , and N. lat.  $54^{\circ} 45'$ .

**CARROT**, in botany. See **DAUCUS**.

**Candy-CARROT**. See **MYRRHIS**.

**Deadly-CARROT**. See **THAPSIA**.

**Mountain CARROT**. See **FOENICULUM**.

**CARROUSAL**, a course of hories and chariots, or a magnificent entertainment exhibited by princes on some public rejoicing. It consists in a cavalcade of several gentlemen richly dressed and equipped, after the manner of ancient cavaliers divided into squadrons, meeting in some public place, and practising juffs, tournaments, &c. The last carroufals were in the reign of Lewis XIV.

**CARS**, or **KARS**, a city of Turcomania, or the greater Armenia, situated on a river of the same name: E. long.  $44^{\circ}$ , and N. lat.  $41^{\circ} 30'$ . It is subject to the Turks.

**CARSE**, or **CARSE of Gowry**, the name of a district of Perthshire in Scotland, lying eastward of Perth, on the northern bank of the Tay.

**CART**, a land-carriage with two wheels, drawn commonly with horses, to carry heavy goods, &c. from one place to another. See **MECHANICS**.

**CARTAMA**, a town of Granada, in Spain, about ten miles north-west of Malaga: W. long.  $4^{\circ} 30'$ , and N. lat.  $36^{\circ} 40'$ .

**CARTEL**, an agreement made between two states for the exchange of their prisoners of war.

**CARTEL** signifies also a letter of defiance, or a challenge, to decide a controversy, either in a tournament, or in single combat. See **DUEL**.

**CARTERET**, a county of South Carolina, in North America.

**CARTESIANS**, a sect of philosophers, who adhere to the system of Des Cartes, and founded on the two following principles; the one metaphysical, the other physical: the metaphysical one is, *I think, therefore I am*; the physical principal is, *That nothing exists but substance*. Substance he makes of two kinds; the one a substance that thinks, the other a substance extended; whence actual thought and actual extension, are the essence of substance.

The essence of matter being thus fixed in extension, the Cartesians conclude, that there is no vacuum, nor any possibility thereof in nature, but that the world is absolutely full: mere space is precluded by this principle,

light, in regard, extension being implied in the idea of space, matter is so too.

Upon these principles, the Cartesians explain mechanically, and according to the laws of motion, how the world was formed, and whence the present appearances of nature do rise. They suppose, that matter was created of an indefinite extension, and divided into little square masses, full of angles; that the Creator impressed two motions on this matter; one whereby each part revolved round its centre, another whereby an assemblage, or system, turned round a common centre; whence arose as many different vortices as there were different masses of matter, thus moving round common centres.

The consequences of this hypothesis, according to the Cartesians, will be, that the parts of matter in each vortex could not revolve among each other, without having their angles gradually broken, and that this continual friction of parts and angles produced three elements; the first, an infinitely fine dust, formed of the angles broken off; the second, the spheres remaining, after all the angular irregularities are thus removed: these two make the matter of Des Cartes's first and second element; and those particles not yet rendered smooth and spherical, and which still retain some of their angles, make the third element.

Now, according to the laws of motion, the subtilest element must take up the centre of each system, being that which constitutes the sun, the fixed stars above, and the fire below; the second element, composed of spheres, makes the atmosphere, and all the matter between the earth and the fixed stars, in such a manner as that the largest spheres are always next the circumference of the vortex or system, and the smallest next its centre; the third element, or the hooked particles, is the matter that composes the earth, all terrestrial bodies, comets, spots in the sun, &c. Though both philosophers and divines have a just plea against this romantic system, yet it must be owned, that Des Cartes, by introducing geometry into physics, and accounting for natural phenomena by the laws of mechanics, did infinite service to philosophy.

**CARTHAGE**, or **NEW CARTHAGE**, the capital of Colarica, a province of Mexico, in North America: W. long. 86°, and N. lat. 9° 44'.

**CARTHAGENA**, a large city, with one of the best harbours in Spain, situated in the province of Murcia, about twenty miles south of that city: W. long. 1° 5', and N. lat. 37° 40'. It is a bishop's see.

**New CARTHAGENA**, the capital of a province of the same name, in South America, situated on a kind of peninsula: W. long. 77°, and N. lat. 11°. It is one of the largest and best fortified towns in South America.

**CARTHAMUS**, or **BASTARD-SAFFRON**, in botany, a genus of the syngenesia polygamia æqualis class. The calix is ovated, and imbricated with foliaceous scales of an oval shape. There are nine species, none of them natives of Britain. The seeds are purgative; but operate slowly, and disorder the bowels.

**CARTHUSIANS**, a religious order, founded in the

year 1080, by one Bruno. Their rules are very severe. They are not to go out of their cells, except to church, without leave of their superior; nor speak to any person without leave. They must not keep any portion of their meat or drink till next day; their beds are of straw, covered with a felt; their cloathing two hair-cloths, two cowls, two pair of hose, and a cloke, all coarse. In the refectory, they are to keep their eyes on the dish, their hands on the table, their attention on the reader, and their hearts fixed on God. Women are not allowed to come into their churches.

**CARTHUSIAN-POWDER**, the same with kermes mineral. See **KERMES**.

**CARTILAGE**, in anatomy, a body approaching much to the nature of bones; but lubricous, flexible, and elastic.

**CARTMEL**, a market-town of Lancashire, about ten miles north-west of Lancaster: W. long. 2° 40', and N. lat. 54° 15'.

**CARTON**, or **CARTOON**, in painting, a design drawn on strong paper, to be afterwards calked through, and transferr'd on the fresh plaster of a wall to be painted in fresco.

Carton is also used for a design coloured, for working in mosaic, tapestry, &c. The cartons at Hampton-court are designs of Raphael Urbin, intended for tapestry.

**CARTOUCHE**, in architecture and sculpture, an ornament representing a scroll of paper. It is usually a flat member, with wavings, to represent some inscription, device, cypher, or ornament of armoury. They are, in architecture, much the same as modillions; only these are set under the cornice in wainscoting, and those under the cornice at the eaves of a house.

**CARTOUCHE**, in the military art, a case of wood, about three inches thick at the bottom, girt with marlin, holding about four hundred musket-balls, besides six or eight balls of iron, of a pound weight, to be fired out of a hobit, for the defence of a pass, &c.

A cartouche is sometimes made of a globular form, and filled with a ball of a pound weight; and sometimes it is made for the guns, being of ball of half or quarter pound weight, according to the nature of the gun, tied in form of a bunch of grapes, on a tompon of wood, and coated over. These were made in the room of partridge-shot.

**CARTRIDGE**, in the military art, a case of pasteboard or parchment, holding the exact charge of a fire-arm. Those for muskets, carbines, and pistols, hold both the powder and ball for the charge; and those of cannon and mortars are usually in cases of pasteboard or tin, sometimes of wood, half a foot long, adapted to the calibre of the piece.

**CARTRIDGE-BOX**, a case of wood or turned iron, covered with leather, holding a dozen musquet-cartridges. It is wore upon a belt, and hangs a little lower than the right pocket-hole.

**CARVA**, in botany. See **LAURUS**.

**CARUI**, or **CARVI**, in botany. See **CARUM**.

**CARVING**. See **SCULPTURE**.

**CARUM**, **CARAWAY**, in botany, a genus of the pentandria

- tandria digynia clais*. The fruit is oblong and striated; the involucre consists of but one leaf; and the petals are carinated and emarginated. There is but one species, *viz.* the caroi, a native of Britain. The seeds have an aromatic smell and pungent taste; and are frequently employed as a stomachic and carminative in flatulent cases.
- CARUNCULA**, in anatomy, a term denoting a little piece of flesh, and applied to several parts of the body, thus:
- CARUNCULÆ MYRTIFORMES**. See p. 276.
- CARUS**, in medicine, a sudden deprivation of sense and motion, affecting the whole body.
- CARWAR**, a town on the coast of Malabar, in the Hither India, sixty miles south of Goa: E. long. 73°, and N. lat. 15°. Here our East-India company have a factory, from whence they import pepper.
- CARYATIDES**, or **CARAITES**, in architecture. See p. 353.
- CARYOCATACTES**, in ornithology, the trivial name of a species of *corvus*. See **CORVUS**.
- CARYOCOSTINUM**, or **ELECTORIUM ET SCAMMONIO**, in pharmacy, is composed of the following ingredients: An ounce and a half of scammony; of cloves and ginger, each six drams; half a pound of honey; half a dram of essential oil of caraway-seeds; the spices must be ground together and mixed with the honey; then add the powdered scammony, and afterwards the oil. This electuary is a warm brisk purgative.
- CARYOPHYLLATA**, in botany. See **GEUM**.
- CARYOPHYLLUS**, the **PINK**, in botany. See **DIANTHUS**.
- CARYOPHYLLUS**, the **CLOVE-TREE**, in botany, a genus of the polyandria monogynia class. The corolla has four petals; the calix consists of four duplicated leaves; and the berry contains one seed. There is but one species, *viz.* the aromaticus, a native of the Molucca islands. The cloves are the flower-cups, have a strong agreeable aromatic smell, and a bitterish pungent taste. The essential oil of cloves is an ingredient in many of our officinal compositions.
- CARYOTA**, in botany, a genus of plants ranged under the palmæ bipennatifoliæ. The calix of the male is common; the corolla is divided into three parts; and the stamina are numerous. The calix and corolla of the male are the same with those of the female; there is but one pistillum; and the berry contains two seeds. There is but one species, *viz.* the urens, a native of India.
- CASAL**, the capital of the duchy of Montferrat, in Italy, situated on the river Po, forty-five miles east of Turin: E. long. 8° 35', and N. lat. 45°.
- CASAN**, or **KASAN**, a province of Russia, lying between the province of Moscow on the west, and Siberia on the east.
- CASCADE**, a steep fall of water from a higher into a lower place.
- They are either natural, as that at Tivoli, &c. or artificial, as those of Versailles, &c. and either falling
- with gentle descent, as those of Sceaux; or in form of a buffet, as at Trianon; or down steps, in form of a peiron, as at St Clou; or from bason to bason, &c.
- CASCAIS**, a town of Estremadura, in Portugal, situated at the mouth of the river Tagus, seventeen miles east of Lisbon: W. long. 10° 15', and N. lat. 38° 40'.
- CASCARILLA**, in botany. See **CINCHONA**.
- CASE**, among grammarians, implies the different inflexions or terminations of nouns, serving to express the different relations they bear to each other, and to the things they represent.
- CASE**, among printers, denotes a sloping frame, divided into several compartments, each containing a number of types or letters of the same kind. See **PRINTING**.
- CASE of crown-glass** contains usually twenty-four tables, each table being nearly circular, and about three feet six inches diameter.
- CASE of Newcastle glass** contains thirty-five tables; of Normandy glass twenty-five.
- CASE-HARDENING**, a method of preparing iron, so as to render its outer surface hard, and capable of resisting any edged tool.
- This is a lesser degree of steel-making, and is practised by baking, calcination, or cementation in an oven or other close vessel, stratified with charcoal and powdered hoofs and horns of animals, so as to exclude the air. See **STEEL**.
- CASE-SHOT**, in the military art, musket-ball, stones, old iron, &c. put into cases, and shot out of great guns.
- CASERTA**, a city of the province of Lavoro, in the kingdom of Naples, about sixteen miles north of the city of Naples: E. long. 15° 5', and N. lat. 41° 10'. It is a bishop's see.
- CASH-BOOK**. See **BOOK-KEEPING**, p. 618.
- CASHELL**, or **CASHILL**, a city of the county of Tipperary, in Ireland, about eighty miles south-west of Dublin: W. long. 7° 40', and N. lat. 52° 16'. It is a bishop's see.
- CASHEW-NUT**, in botany. See **ANACARDIUM**.
- CASIA**, in botany. See **OSYRIA**.
- CASK**, a vessel of capacity, for preserving liquors of divers kinds; and also sometimes dry goods, as sugar, almonds, &c.
- A cask of sugar is a barrel of that commodity, containing from eight to eleven hundred weight. A cask of almonds is about three hundred weight.
- CASPIAN-SEA**, a large sea, or lake of Asia, bounded by the province of Altracan on the north, and by part of Persia on the east, south, and west. It is upwards of four hundred miles long from south to north, and three hundred miles broad from east to west.
- CASSANDRA**, the same with the lyra, or harp-shell, a species of dolium.
- CASSANO**, a fortress, in the Milanese, in Italy, situated on the river Adda, about twelve miles north-east of Milan: E. long. 10°, and N. lat. 45° 20'.
- CASSEL**, the capital of the landgravate of Hesse-cassel,

- in the circle of the Upper Rhine, in Germany, situated on the river Fulde: E. long.  $2^{\circ} 20'$ , and N. lat.  $51^{\circ} 20'$ .
- CASSEL** is also the name of a town in French Flanders, about fifteen miles south of Dunkirk: E. long.  $2^{\circ} 30'$ , and N. lat.  $50^{\circ} 5'$ .
- CASSIA**, in botany, a genus of the decandria monogynia class. The calix consists of five leaves; the petals are five; and the antheræ are rostrated and barren; the pod is a legumen. There are 30 species, all natives of warm climates. The *cassia fistula* is a native of Egypt, and the East Indies. The fruit is a cylindrical pod, the pulp of which is a gentle laxative medicine.
- CASSIDA**, in botany. See **SCUTELLARIA**.
- CASSIDA**, in zoology, a genus of insects belonging to the order of coleoptera. The feelers are like threads, but thicker on the outside; the elytra are margined; and the head is hid under the thorax. There are 21 species of this insect, distinguished principally by differences in their colour.
- CASSIMERE**, the capital city of a province of the same name in the Hither India: E. long.  $75^{\circ}$ , and N. lat.  $35^{\circ}$ . It was once the capital of a kingdom, and is still sometimes the residence of the Mogul.
- CASSINE**, in botany, a genus of the pentandria trigynia class. The calix consists of five parts or segments; the petals are five, and the berry contains three seeds. There are only two species, both natives of Æthiopia.
- CASSIOPEIA**, in astronomy, a constellation of the northern hemisphere, situated opposite to the great bear, on the other side of the pole.
- CASSIS**, the **HELMET-SHELL**. See **MUREX**.
- CASSITERIA**, in the history of fossils, a genus of crystals, the figures of which are influenced by an admixture of some particles of tin.
- The cassiteria are of two kinds: the whitish pellucid cassiterion, and the brown cassiterion; the first is a tolerably bright and pellucid crystal, and seldom subject to the common blemishes of crystal: It is of a perfect and regular form, in the figure of a quadrilateral pyramid, and is found in Devonshire and Cornwall principally. The brown cassiterion is like the former in figure: It is of a very smooth and glossy surface, and is also found in great plenty in Devonshire and Cornwall.
- CASSOCK**, or **CASSULA**, a kind of robe or gown, wore over the rest of the habit, particularly by the clergy. The word cassock comes from the French *casque*, an horseman's coat.
- CASSOWARY**, in ornithology. See **STRUTHIO**.
- CASSUMBAZAR**, a town of India, in Asia, situated on the river Ganges, in the province of Bengal: E. long.  $37^{\circ}$ , and N. lat.  $24^{\circ}$ .
- CASSUMUNAR**, in the materia medica, a root approaching to that of zedoary.
- It is cardiac and sudorific, and famous in nervous cases: It is also an ingredient in many compositions, and is prescribed in powders, bolusses, and infusions. Its dose is from five to fifteen grains.
- CASTANEA**, in botany. See **FAGUS**.
- CASTANOVITZ**, a town of Croatia, situated on the river Unna, which divides Christendom from Turkey: E. long.  $17^{\circ} 20'$ , and N. lat.  $45^{\circ} 40'$ . It is subject to the house of Austria.
- CASTEL-ARAGONESE**, a fortress of Sardinia, situated on the north-west coast of that island: E. long.  $8^{\circ} 45'$ , and N. lat.  $41^{\circ}$ .
- CASTEL-BAR**, a town of Ireland, in the county of Mayo, and province of Connaught, about thirty-eight miles north of Gallway: W. long.  $9^{\circ} 24'$ , N. lat.  $53^{\circ} 25'$ .
- CASTEL-BRANCHO**, a city of the province of Beira, in Portugal, about ninety five miles north-east of Lisbon: W. long.  $8^{\circ}$ , N. lat.  $39^{\circ} 35'$ .
- CASTEL DE VIDE**, a town of Alentejo, in Portugal, about twelve miles east of Portalegre, and thirty-five west of Alcantara: W. long.  $7^{\circ} 40'$ , N. lat.  $39^{\circ}$ .
- CASTELLA**, a town of the Mantuan, in Italy, about five miles north-east of the city of Mantua: E. long.  $11^{\circ} 15'$ , N. lat.  $45^{\circ} 30'$ .
- CASTELLAN**, the name of a dignity or charge in Poland: The castellans are senators of the kingdom, but senators only of the lower class, who, in diets, sit on low seats, behind the palatines, or great senators. They are a kind of lieutenants of provinces, and command a part of the palatinate under the palatine.
- CASTELLANY**, the territory belonging to any city or town, chiefly used in France and Flanders: Thus we say, the castellany of Lisle, Ypres, &c.
- CASTIGLIONE**, a fortified town in the duchy of Mantua, about twenty miles north-west of the city of Mantua: E. long.  $11^{\circ}$ , N. lat.  $45^{\circ} 15'$ .
- CASTILE**, the name of two inland provinces of Spain, situated almost in the middle of that kingdom: The most southerly one is called New Castile, and the other, towards the north, Old Castile; Madrid being the capital of the former, and Burges of the latter.
- CASTILLAN**, or **CASTILLANE**, a gold-coin, current in Spain, and worth fourteen rials and sixteen deniers.
- CASTILLAN** is also a weight used in Spain for weighing gold. It is the hundredth part of a pound Spanish weight.
- What they commonly call a weight of gold in Spain, is always understood of the castillan.
- CASTIL-LARA**, a town of the Mantuan, in Italy, situated six miles north-east of the city of Mantua: E. long.  $11^{\circ} 25'$ , N. lat.  $45^{\circ} 20'$ .
- CASTILLON**, a town of Perigort, in the province of Guienne, in France, situated on the river Dordonne, sixteen miles east of Bourdeaux: W. long.  $2^{\circ} 40'$ , N. lat.  $44^{\circ} 50'$ .
- CASTLE**, a fortress or place rendered defenceable, either by nature or art.
- A castle is a fort, or little citadel. See **CITADFL**.
- It frequently signifies with us the principal mansion of noblemen.
- In the time of Henry II. there were no less than 1115 castles in England, each of which contained a manor.
- CASTLE**, in the sea-language, is a part of the ship, of which there are two, the fore-castle, being the elevation.



tion at the prow, or the uppermost deck, towards the mizen, the place where the kitchens are. Hind-cuttie is the elevation which reigns on the stern, over the last deck, where the officers cabins and places of assembly are.

**CASTLE-CAREY**, a market town of Somersetshire, situated ten miles south-east of Wells: W. long.  $2^{\circ} 40'$ , N. lat.  $51^{\circ} 15'$ .

**CASTLE-RISING**, a borough-town of Norfolk situated near the sea coast, about thirty miles west of Norwich, and seven north of Lynn: E. long.  $40'$ , N. lat.  $52^{\circ} 46'$ . It sends two members to parliament.

**CASTLE-WORK**, service or labour done by inferior tenants, for the building and upholding of castles of defence, towards which some gave their personal assistance, and others paid their contributions. This was one of the three necessary charges to which all lands among our Saxon ancestors were expressly subject.

**CASTON**, a market-town of Norfolk, about eight miles north-west of Norwich: E. long.  $1^{\circ} 20'$ , N. lat.  $52^{\circ} 45'$ .

**CASTOR**, or **BEAVER**, in zoology, a genus of quadrupeds belonging to the order of glires. The fore-teeth of the upper jaw are truncated, and hollowed in a transverse angular direction. The tops of the fore-teeth of the lower-jaw lie in a transverse direction; and the tail is depressed. There are three species of castor, viz. 1. The fiber, with a plane ovated tail, is found on the banks of rivers in Europe, Asia, and America. It is from the inguinal glands of this animal that the castor is obtained; it is contained in cuds or pouches which resemble a dog's testicles.

Several writers have taken notice of the ingenuity of American beavers in making their houses, of which we shall here give some account. The first thing they do when they are about to build, is to assemble in companies, sometimes of two or three hundred together; then they chuse a place where plenty of provisions are to be had, and where all necessaries are to be found proper for their use. Their houses are always in the water, and when they can find neither lake nor pond, they endeavour to supply that defect by stopping the current of a brook or small river, by means of a dam. To this end they first cut down trees in the following manner: Three or four beavers will go to work about a large tree, and by continually gnawing of it with their teeth, they at last throw it down, and so contrive matters that it always falls towards the water, that they may have the less way to carry it, when they have divided it into pieces. After they have done this, they take each piece by itself, and roll it towards the water, where they intend to place it.

These pieces are more or less thick and long, according to the nature and situation of the places where they are required. Sometimes they make use of the large trunks of trees, which they lay down flat; sometimes the dam only consists of branches as thick as one's thigh, which are supported by stakes interwoven with the branches of trees; and all the vacant places are filled up with a sort of clay, in such a manner, that no water can pass through them. They

prepare the clay with their paws or hands; and their tails serve instead of a cartilage, as well as a trowel to lay on their clay.

The foundation of the dams are generally ten or twelve feet thick, and they lessen gradually till they come to two or three. They always observe an exact proportion, inasmuch, that the most curious architects are not capable of performing their work more regularly. That side towards the current of the water is always sloping, but the other is perpendicular.

The construction of the houses is altogether as wonderful; for they are generally built upon piles in small lakes, which are formed by making of the dams. Sometimes they are on the bank of a river, or on the extremity of a point of land, which advances into the water. They are of a round or oval form, and the top of them is like a dome.

This description of one of their houses which was examined and measured, will perhaps give the reader more satisfaction than an account in general. It was about three parts surrounded with water, and the other part was joined to the land. It was round, with an oval dome at the top, and the height above the surface of the water, was eight feet. It was about forty feet in diameter, and one hundred and twenty in circumference, which perhaps may seem strange, because the proportion is geometrical; this however is fact, for it was measured several times. The part that joined to the bank was not made out of it, but was of the same materials with the rest.

The bottom of the house was of earth, or soil, with pieces of wood laid in it, above three inches in circumference; then a parcel of poplar sticks laid with one end in the house, and another slanting a long way under water; then a layer of earth again, and then poplar sticks, which were repeated to the height of eighteen inches. From thence to the top of the house there was a mixture of earth, stones, and sticks, curiously put together; and the whole was covered with sods, that had long grass growing thereon. The largest pieces of wood made use of near the top, were about three inches in diameter, and all the rest was still itself, not above two or three fingers thick.

The outermost part of this house did not stand farther out in the creek than the edge of the shore; but that which brought the water almost round the house were the trenches, which were made by taking out the earth; these were nine feet in the broadest part, and eighteen feet in length. The creek at the front of the house was six and thirty feet broad, and seemed to be pretty deep. The house was so contrived as to be very solid, for there was no breaking into it without an ax; and in the frosty season it was quite impenetrable. From this house there were several paths into the wood, through which they drew the sticks and trees, which they made use of for food or building.

The wall of the house was two feet thick, and it was covered with smooth clay on the inside in such a manner that it would not admit the least breath of air. Two thirds of the structure was out of the water; and in the upper part, each beaver had his particular

ticular place, whereon leaves were strewed to lie upon.

There never was any fish seen in any of these houses, which are made like an oven in the inside, with a passage for these animals to go and bathe in the water. One of these will generally lodge about eight or ten beavers, though sometimes they have held thirty; but this is very uncommon.

These creatures are never surpris'd by the frost and snow; for they finish their work towards the end of September; and then they lay in provisions for the winter. In the summer-time they live upon fruits, and the barks and leaves of trees; and they likewise catch small fish, and particularly crabs or craw-fish. However, their winter-provision is the tender branches of trees, particularly poplar, of which they seem to be very fond. It is usually said, and upon pretty good authority, that these beavers make the walls of their houses of a thickness in proportion to the severity of the succeeding winter; which if true, these animals must be furnished with uncommon foresight.

When there are great floods caused by the melting of the snow, which damage the houses of the beavers, they then leave them, and thift for themselves as well as they can; however, the females return as soon as the waters are abated; but the males keep the field till July, when they assamble again to repair the damage that has been done by the flood, either to their houses or dams. When any of their houses are demolished by the hunters, they never repair them again, but build others quite new. Some authors have said, that the beavers make several rooms in their houses; but this upon examination has been found to be false.

In hunting the beavers, the savages sometimes shoot them, always getting on the contrary side of the wind; for they are very shy, quick in hearing, and of a very keen scent. This is generally done when the beavers are at work, or on shore feeding on poplar bark. If they hear any noise when at work, they immediately jump into the water, and continue there some time; and when they rise, it is at a distance from the place where they went in.

They sometimes are taken with traps: these are nothing but poplar sticks laid in a path near the water; which when the beaver begins to feed upon, they cause a large log of wood to fall upon their necks, which is put in motion by their moving of the sticks, and consequently requires an ingenious contrivance. The savages generally prefer this way of taking them, because it does not damage their skins.

In the winter-time they break the ice in two places at a distance from the house, the one behind the other. Then they take away the broken ice with a kind of a racket, the better to see where to place their stakes. They fasten their nets to these, which have large meshes, and sometimes are eighteen or twenty yards in length. When these are fixed, they proceed to demolish the house, and turn a dog therein; which terrifying the beaver, he immediately leaves it, and takes to the water; after which, he is soon entangled by the net.

Mr Lawson who was general surveyor of North Carolina, affirms, that beavers are very plenty in that coun-

try. He confirms what has been said about their ingenuity in building of their dams and houses, and observes, that their food is chiefly the bark of trees and shrubs; such as that of the sassafras, ash, sweet gum, and several others. He adds, that if they are taken young, they will become very tame; but then they will do a great deal of mischief in the orchards, by breaking the trees. They will likewise block up the doors of the houses in the night, with the sticks and wood which they bring thither. He farther informs us, that it is certain death for them to eat any thing that is salt. The flesh is looked upon as very delicate food.

2. The moschatus, with a long, compressed, lanceolated tail, and palmated feet. It is the exotic water-rat of Clusius, and is a native of Russia.

3. The zibethicus, or musk-rat, with a long, compressed, and lanceolated tail, and the toes of the feet separate from each other. The follicles of the tail are said to banish moths and other insects from cloaths, &c. For this reason the inhabitants of Russia and Canada sew them into the folds of their cloaths, to keep off vermin and contagious diseases.

CASTOR is also the name of a market-town of Lincolnshire, twenty miles north-east of Lincoln: W. long. 12', and N. lat. 53° 30'.

CASTOREA, in botany. See DURANTA.

CASTOREUM, in the materia medica, a substance obtained from the inguinal glands of the castor. See CASTOR.

CASTRATION, in surgery, the operation of gelding.

It was prohibited by a decree of the senate of Rome under Hadrian; and the Cornelian law subjected the person who performed the operation, to the same penalties as the person on whom it was performed, although it was done with his consent.

Castration is much in use in Asia and Turkey, where it is practis'd upon the slaves, to prevent any commerce with their women. In Italy, castration is frequent from another motive, namely, to preserve the voice for singing. It is sometimes found necessary in chirurgical cases, as in a sarcocele and cancer of the testicles. For the method of performing this operation, see SURGERY.

CASTRES, a city of Languedoc, in France, about thirty-five miles east of Thoulouse: E. long. 2°, and N. lat. 43° 40'. It is a bishop's see.

CASTRO, the capital of the island of Chiloe, on the coast of Chili, in south America: W. long. 82°, S. lat. 43°.

CASTRO is also the capital of a duchy of the same name in the pope's territories, in Italy, situated on the confines of Tuscany: E. long. 12° 35', N. lat. 42° 30'.

CASTRO is likewise a town in the territory of Otranto, in the kingdom of Naples, about seven miles south of Otranto: E. long. 19° 25', N. lat. 40° 8'.

CASTRO *marino*, a town in the province of Algarva, in Portugal, situated near the mouth of the river Guadiana, on the confines of Andalusia: W. long. 8° 15'. N. lat. 37°.

**CASUALTIES** of *superiority*, in Scots law, those duties and emoluments which a superior has right to demand out of his vassal's estate, over and besides the constant yearly duties established by the *reddendo* of his charter, upon certain casual events. See **SCOTS LAW**, title, *Of the casualties due to the superior*.

**CASUS amissionis**, in Scots law. In actions of proving the tenor of obligations extinguishable by the debtor's retiring or cancelling them, it is necessary for the pursuer, before he is allowed a proof of the tenor, to condescend upon such a *casus amissionis*, or accident, by which the writing was destroyed, as shews it was lost while in the creditor's possession. See **SCOTS LAW**, title, *Actions*.

**CAT**, in zoology. See **FELIS**.

**CAT-mint**, in botany. See **MENTHA**.

**CAT**, or **CAT-head**, on shipboard, a short piece of timber in a ship, lying aloft right over the hawse, having at one end two shivers, wherein is reeved a rope, with a great iron-hook fastened to it, called

**CAT-hook**. Its use is to trice up the anchor, from the hawse to the top of the fore-castle.

**CAT holes**, in a ship, are over the parts as right with the capstan as they can be: Their use is to heave the ship a-stern, upon occasion, by a cable, or hawse, called *stern-fast*. See **STERN-FAST**.

**CAT of the mountain**. See **FELIS**.

**CAT-silver**, in natural history. See **MICÆ**.

**CATACAUSTIC curves**, in the higher geometry, that species of caustic curves which are formed by reflexion. See **FLUXIONS**.

**CATACRHESES**, in rhetoric, a trope which borrows the name of one thing to express another. Thus Milton describing Raphael's descent from the empyreal heaven to paradise, says,

"Down thither prone in flight

"He speeds, and thro' the vast ethereal sky

"Sails between worlds and worlds."

**CATACOMB**, a grotto or subterraneous place for the burial of the dead.

The term is particularly used in Italy, for a vast assemblage of subterraneous sepulchres, three leagues from Rome, in the *via Appia*, supposed to be the sepulchres of the ancients. Others imagine these catacombs to be the cells wherein the primitive Christians hid themselves. Each catacomb is three feet broad, and eight or ten high, running in form of an alley or gallery, and communicating with one another.

**CATAGMATICS**, in pharmacy, remedies proper for curing a catagma or fracture.

**CATALEPSY**, in medicine. See **MEDICINE**.

**CATALONIA**, a province of Spain, bounded by the Pyrenean mountains which divide it from France, on the north; by the Mediterranean, on the east and south; and by the provinces of Aragon and Valencia, on the west.

**CATAMENIA**, in medicine. See **MENSES**.

**CATAMITE**, a boy kept for sodomitical practices.

**CATANANCHE**, in botany, a genus of plants belonging to the syngenesia polygamia æqualis class. The

receptacle is paleaceous; the calix is imbricated; and the pappus has an awn, with a kind of cetaceous calix. There are three species, none of which are natives of Britain.

**CATAPASM**, among ancient physicians, signifies any dry medicine reduced to powder, in order to be used by way of inspiration in the whole body, or any part of it.

**CATAPHONICS**, the science which considers the properties of reflected sounds.

**CATAPHORA**, in medicine, the same as coma. See **COMA**.

**CATAPHRACTA**, in antiquity, a kind of coat of mail, which covered the soldier from head to foot.

Hence, cataphracti were horsemen armed with the cataphracta, whose horses, as Sallust says, were covered with linen full of iron plates disposed like feathers.

**CATAPLASM**, an external topical medicine, prepared of ingredients of different virtues, according to the intention of the physician. Hence there are different sorts of cataplasms with respect to the matter of which they consist, as emollient, resolvent, discutient, suppurative, corroborative, anodyne, and antiseptic cataplasms. They are commonly applied hot, or lukewarm, rolled up in linen cloths, which by means of the oils which are added preserve heat for a considerable time; for which end also some, upon these, apply a swine's or ox's bladder, and sometimes on the top of all apply an earthen tile.

**CATAPULTA**, in antiquity, a military engine contrived for the throwing of arrows, darts, and stones, upon the enemy.

Some of these engines were of such force, that they would throw stones of an hundred weight. Josephus takes notice of the surprising effects of these engines, and says, that the stones thrown out of them beat down the battlements, knocked off the angles of the towers, and would level a whole file of men, from one end to the other, were the phalanx never so deep.

**CATARACT**, in hydrography, a precipice in the channel of a river, caused by rocks, or other obstacles, stopping the course of the stream, from whence the water falls with a greater noise and impetuosity: Such are the cataracts of the Nile, the Danube, Rhine, and the famous one of Niagara in America.

**CATARACT**, in medicine and surgery, a disorder of the humours in the eye, by which the pupilla, that ought to appear transparent and black, looks opaque, grey, blue, brown, &c. by which vision is variously impeded, or totally destroyed. See **MEDICINE**, and **SURGERY**.

**CATARO**, the capital of a territory of the same name, in the Venetian Dalmatia, about twenty five miles south-east of Ragusa: E. long. 19° 20', N. lat. 42° 25'.

**CATARACTES**, in ornithology, the trivial name of a species of larus. See **LARUS**.

**CATARRH**, in medicine, a distillation or defluxion from the head upon the mouth and aspera arteria,

- and through them upon the lungs. See **MEDICINE**.
- CATASTASIS**, in poetry, the third part of the ancient drama, being that wherein the intrigue, or action, set forth in the epitasis, is supported and carried on, and heightened, till it be ripe for the unravelling in the catastrophe. Scaliger defines it, the full growth of the fable, while things are at a stand in that confusion to which the poet has brought them.
- CATASTROPHE**, in dramatic poetry, the fourth and last part of the ancient drama, or that immediately succeeding the catastasis: Or, according to others, the third only; the whole drama being divided into protasis, epitasis, and catastrophe; or, in the terms of Aristotle, prologue, epilogue, and exode. See **EPIC** and **DRAMATIC compositions**.
- CATCH-fly**, in botany. See **LYCHNIS**.
- CATCH-POLE**, a term used by way of reproach, for the bailiff's follower, or assistant.
- CATCH-word**, among printers, that placed at the bottom of each page, being always the first word of the following page.
- CATECHETIC**. Catechetical schools were buildings appointed for the office of the catechist, adjoining to the church, and called *catechumena*: Such was that in which Origen, and many other famous men, read catechetical lectures at Alexandria. See **CATECHUMEN**.
- CATECHISM**, the name of a small book, designed for instructing children in the principles of religion. The church of Rome, the church of England, the presbyterian church, &c. have all catechisms containing and enforcing their peculiar opinions.
- CATECHU**, in the materia medica, the name of a troch consisting of Japan earth and gum arabic, each two ounces, and of sugar of roses sixteen ounces, beat together, with a little water. It is recommended as a mild restraining, &c.
- CATECHUMEN**, a candidate for baptism, or one who prepares himself for the receiving thereof.
- The catechumens, in church-history, were the lowest order of Christians in the primitive church. They had some title to the common name of Christian, being a degree above pagans and heretics, though not consummated by baptism. They were admitted to the state of catechumens, by the imposition of hands, and the sign of the cross. The children of believing parents were admitted catechumens, as soon as ever they were capable of instruction: But at what age those of heathen parents might be admitted, is not so clear. As to the time of their continuance in this state, there were no general rules fixed about it; but the practice varied according to the difference of times and places, and the readiness and proficiency of the catechumens themselves.
- There were four orders or degrees of catechumens; the first were those instructed privately without the church, and kept at a distance, for some time, from the privilege of entering the church, to make them the more eager and desirous of it. The next degree were the *audientes*, so called from their being admitted to hear sermons and the scriptures read in the church, but were not allowed to partake of the prayers. The third sort of catechumens were the *genu flexentes*, so called, because they received imposition of hands kneeling. The fourth order was the *competentes & electi*, denoting the immediate candidates for baptism, or such as were appointed to be baptized the next approaching festival, before which, strict examination was made into their proficiency under the several stages of catechetical exercises.
- After examination, they were exercised for twenty days together, and were obliged to fasting and confession: Some days before baptism they went veiled; and it was customary to touch their ears, saying, *Ephatha*, i. e. be opened; as also, to anoint their eyes with clay; both ceremonies being in imitation of our Saviour's practice, and intended to shadow out to the catechumens their condition both before and after their admission into the Christian church.
- CATEGORY**, in logic, a series or order of all the predicates or attributes contained under any genus.
- The school-philosophers distribute all the objects of our thoughts and ideas into certain *genera* or classes, not so much, say they, to learn what they do not know, as to communicate a distinct notion of what they do know; and these classes the Greeks called categories, and the Latins predicaments.
- Aristotle made ten categories, *viz.* quantity, quality, relation, action, passion, time, place, situation, and habit, which are usually expressed by the following technical distich:
- Arbor, sex, servos, ardore, refrigerat, usus,  
Ruri cras stabo, nec tunicatus ero.*
- CATENARIA**, in the higher geometry, the name of a curve line formed by a rope hanging freely from two points of suspension, whether the points be horizontal or not. See **FLUXIONS**.
- CATERGI**, the name of the public carriers in the grand Signior's dominions. In Europe, the merchant or traveller gives earnest to the carrier; but the catergi in Turkey give earnest to the merchant and others, as a security that they will certainly carry their goods, or not set out with them.
- CATERPILLAR**, in zoology, the name of all winged insects when in their reptile or worm-state. See **NATURAL HISTORY**, *Of insects*.
- CATESBÆA**, in botany, a genus of the tetrandria monogynia class. The corolla is long, monopetalous, and shaped like a tunnel; the stamina are within the faux; and the berry contains but one seed. There is but one species, *viz.* the spinosa, a native of Providence.
- CATHÆRETICS**, in pharmacy, medicines of a caustic nature, serving to eat off proud flesh.
- CATHARTICS**, in medicine, remedies which promote evacuation by stool.
- CATHEDRAL**, a church wherein is a bishop's see or seat.
- CATHETER**, in surgery, a fistulous instrument, usually made of silver, to be introduced into the bladder, in order to search for the stone, or discharge the urine when suppressed. See **SURGERY**.
- CATHETUS**, in geometry, a line or radius falling perpendicularly

- pendicularly on another line or surface: thus the catheti of a right-angled triangle are the two sides that include the right angle.
- CATHETUS of incidence**, in catoptrics, a right line drawn from a point of the object, perpendicular to the reflecting line.
- CATHETUS of reflection**, or of the eye, a right line drawn from the eye, perpendicular to the reflecting line.
- CATHETUS of obliquation**, a right line drawn perpendicular to the speculum, in the point of incidence or reflection.
- CATHETUS**, in architecture, a perpendicular line, supposed to pass through the middle of a cylindrical body, as a baluster, column, &c.
- CATHNESS**, the most northerly county of Scotland, having the Caledonian ocean on the north, east, and south-east, and the shire of Sutherland on the south and west. Its capital is Wick.
- CATHOLIC**, in a general sense, denotes any thing that is universal or general.
- CATHOLIC CHURCH**. The rise of heresies induced the primitive Christian church to assume to itself the appellation of catholic, being a characteristic to distinguish it from all sects, who, though they had party-names, sometimes sheltered themselves under the name of Christians.
- The Romish church distinguishes itself now by the name of catholic, in opposition to all those who have separated from her communion, and whom she considers as only heretics and schismatics, and herself only as the true and Christian church. In the strict sense of the word, there is no catholic church in being, that is, no universal Christian communion.
- CATHOLIC KING**, a title which hath been hereditary to the kings of Spain, ever since Alphonfus, who, having gained several victories over the Saracens, and re-established the Christian faith in Spain, was honoured with the title of Catholic. Some say it was in the time of Ferdinand and Isabella.
- CATHOLICON**, in pharmacy, a kind of soft purgative electuary, so called, as being supposed an universal purger of all humours.
- CATOCHÉ**, or **CATOCCHUS**, in medicine, a disease, by which the patient is rendered, in an instant, as immoveable as a statue, without either sense or motion, and continues in the same posture he was in at the moment he was seized. See **MEDICINE**.
- CATODON**, in ichthyology, the trivial name of a species of physeter. See **PHYSETER**.
- CATOPSIS**, in medicine. See **MYOPIA**.
- CATOPTRICS**, that part of optics that treats of reflex vision, and explains the laws and properties of reflection. See **OPTICS**.
- CATULUS**, in ichthyology. See **SQUALUS**.
- CATUS-PARDUS**, in zoology. See **FELIS**.
- CATUS ZIBETHICUS**. See **CASTOR**.
- CATZENELLBOGEN**, a city of Hesse, situated upon the Upper Rhine, in Germany, about sixteen miles north of Mentz: E. long.  $7^{\circ} 40'$ , N. lat.  $50^{\circ} 20'$ . It is the capital of a county of the same name.
- CAVALIER**, in fortification, an elevation of earth of different shapes, situated ordinarily in the gorge of a ballion, bordered with a parapet, and cut into more or less embrasures, according to the capacity of the cavalier.
- Cavaliers are a double defence for the faces of the opposite ballion: they defend the ditch, break the besiegers galleries, command the traverses in dry moats, scowr the saillant angle of the counter-scarpe where the besiegers have their counter-batteries, and infiltrate the enemies trenches, or oblige them to multiply their parallels: they are likewise very serviceable in defending the breach, and the retrenchments of the besieged, and can very much incommode the entrenchments which the enemy make, being lodged in the ballion.
- CAVALIER**, in the menage, one that understands horses, and is practised in the art of riding them.
- CAVALRY**, a body of soldiers that charge on horseback. They are divided into squadrons, and encamp on the wings of the army.
- CAVAN**, the capital of a county of the same name, in the province of Ulster, in Ireland, situated about sixty miles north-west of Dublin: W. long.  $7^{\circ} 35'$ , and N. lat.  $54^{\circ}$ .
- CAUCALIS**, in botany, a genus of the pentandria digynia class. The corolla is radiated; the fruit is hairy, and the involucre are entire. There are six species, three of which are natives of Britain, viz. the arvensis, or small corn-parsley; the anthriscus, or hedge-parsley; and the leptophylla, or fine-leaved bastard parsley.
- CAUCASUS**, a vast ridge of mountains, running from the Lesser Asia through the north of Persia to the East Indies; these acquire different names in the several countries through which they pass.
- CAUDIVERBERA**, in zoology, the trivial name of a species of lacerta. See **LACERTA**.
- CAVEAR**, **CAVEER**, or **CAVIARY**, the spawn, or hard roes of sturgeon, made into small cakes, an inch thick, and of an hand's breadth, salted, and dried in the sun. This sort of food is in great repute throughout Muscovy, because of their three lents, which they keep with a superstitious exactness; wherefore the Italians settled at Muscovy, drive a very great trade in this commodity throughout that empire, because there is a prodigious quantity of sturgeon taken at the mouth of the Wolga and of the other rivers which fall into the Caspian sea. There is a pretty large quantity of this commodity consumed in Italy, and they are very well acquainted with it in France and England, where it is reckoned no despicable dish.
- The French and Italians get the cavear from Archangel, but they seldom get it at the first hand, for they commonly buy it of the English and Dutch.
- CAVEAT**, in law, a kind of process in the spiritual courts, to stop the proving of a will, the granting letters of administration, &c. to the prejudice of another. It is also used to stop the institution of a clerk to a benefice.
- CAVEATING**, in fencing, is the shifting the sword from one side of that of your adversary to the other.

CAVEDO,

**CAVEDO**, in commerce, a Portuguese long measure, equal to  $27\frac{1}{8}$  English inches.

**CAVETTO**, in architecture, a hollow member, or round concave moulding, containing a quadrant of a circle, and having a quite contrary effect to that of a quarter round: it is used as an ornament in cornices.

**CAVEZON**, in the menage, a sort of nose-band, either of iron, leather, or wood, sometimes flat, and at other times hollow or twisted, clapt upon the nose of a horse, to wring it, and so forward the suppling and breaking of the horse.

**CAVIA-COBAYA**, a synonyme of the mus porcellinus, or Guinea-pig. See **MUS**.

**CAVILLON**, a town of Provence in France, situated on the river Durance, about fifteen miles south of Avignon: E. long.  $5^{\circ}$ , and N. lat.  $43^{\circ} 50'$ . It is a bishop's see, and subject to the pope.

**CAUKING**, or **CAULKING of a ship**, is driving oakum, or the like, into all the seams of the planks of a ship, to prevent leaking, and keep out the water.

**CAULKING-IRONS**, are iron chissels for that purpose. Some of these irons are broad, some round, and others grooved. After the seams are stopped with oakum, it is done over with a mixture of tallow, pitch, and tar, as low as the ship draws water.

**CAUL**, in anatomy. See p. 266. col. 2.

**CAULIFLOWERS**, in gardening, a much esteemed species of cabbage.

Cauliflowers have of late years been so much improved in Britain, as to exceed in goodness and magnitude any produced in most parts of Europe; and, by the skill of the gardener, are continued for several months together, but the most common season for them is in May, June, and July.

**CAULIS**, in botany. See p. 641. col. 2. and Plate LVII. fig. 148.

**CAUSALTY**, among metaphysicians, the action or power of a cause in producing its effect.

**CAUSALTY**, among miners, denotes the lighter, sulphureous, earthy parts of ores, carried off in the operation of washing.

This, in the mines, they throw in heaps upon banks, which, in six or seven years, they find it worth their while to work over again.

**CAUSE**, that from whence any thing proceeds, or by virtue of which any thing is done: it stands opposed to effect. We get the ideas of cause and effect from our observation of the vicissitude of things, while we perceive some qualities or substances begin to exist, and that they receive their existence from the due application and operation of other beings. That which produces, is the cause; and that which is produced, the effect: thus, fluidity in wax is the effect of a certain degree of heat, which we observe to be constantly produced by the application of such heat.

**First CAUSE**, that which acts of itself, and of its own proper power or virtue: God is the only first cause in this sense.

**Second CAUSES** are those which derive the power and faculty of action from a first cause.

**Efficient CAUSES** are the agents employed in the production of any thing.

**Material CAUSES**, the subjects whereon the agents work; or the materials whereof the thing is produced.

**Final CAUSES** are the motives inducing an agent to act; or the design and purpose for which the thing was done.

**Physical CAUSE**, that which produces a sensible corporeal effect; as the sun is the physical cause of light.

**Moral CAUSE**, that which produces a real effect, but in things immaterial; as repentance is the cause of forgiveness. A moral cause is also defined, that which determines us, though not necessarily, to do, or not to do, any thing; as advice, intreaties, commands, menaces, &c.

It is to be observed, that, in this sense, a moral cause is only applicable to a free intelligent agent: it is also observable, that the latter notion of a physical as well as a moral cause is the most just, clear, and distinct.

**CAUSE**, among civilians, the same with action. See **ACTION**.

**CAUSTICS**, in physic, an appellation given to medicines of so hot and fiery a nature, that, being applied, consume, and, as it were, burn the texture of the parts, like hot iron.

Caustics are generally divided into four sorts, the common stronger caustic, the common milder caustic, the antimonial caustic, and the lunar caustic.

The stronger caustic is prepared by boiling to a fourth part any quantity of the lees of almond-soap, adding lime that has been kept in a vessel pretty close stopp'd for several months; the lime is to be added till all the liquor is absorbed, and the whole reduced to a paste, which is to be kept in a vessel well stopp'd.

The common milder caustic is prepared by taking equal parts of soft soap and fresh quick-lime, and mixing them at the time of using.

The antimonial caustic is prepared thus: Take of antimony one pound, of corrosive sublimate two pounds; and being reduced separately into powder, mix them well, and distill them in a retort with a wide neck, in a gentle heat of sand; let what ascends into the neck of the retort be exposed to the air, that it may run into a liquor.

The method of preparing the lunar caustic is as follows: Dissolve pure silver by a sand-heat, in about twice its weight of aqua-fortis; then dry away the humidity with a gentle fire, afterwards melt it in a crucible, that it may be poured into proper moulds, carefully avoiding over-much heat, lest the matter should grow too thick.

**CAUSTIC CURVE**, in the higher geometry, a curve formed by the concurrence or coincidence of the rays of light reflected from some other curve.

**CAUSTIC GLASSES**. See **BURNING-GLASSES**.

**CAUSTICUM ANTIMONIALE**, in the London Dispensatory, the same with the oil of antimony.

**CAUSUS**, or **BURNING-FEVER**, a species of continual fever, accompanied with a remarkable inflammation of the blood.

**CAUTERIZATION**, the application of cauteries to any part of the body.

**CAUTERY**,

**CAUTERY**, in surgery, a medicine for burning, eating, or corroding any solid part of the body.

Cauteries are distinguished into two classes, actual and potential: by actual cauterics, are meant red hot instruments, usually of iron, and by potential cauterics are understood certain kinds of corroding medicines. See **MEDICINE**, and **SURGERY**.

**CAUTION**, in the civil and Scots law, denotes much the same with what, in the law of England, is called bail. See **BAIL**.

**CAUTIONER**, in Scots law, that person who becomes bound for another to the performance of any deed or obligation. As to the different kinds and effects of cautionry, see **SCOTS LAW**, title, *Obligations arising from consent*.

**CAXA**, a little coin made of lead, mixed with some scoria of copper, struck in China, but current chiefly at Bantam in the island of Java, and some of the neighbouring islands.

The caxas are of two kinds, great and small. Of the small, 300,000 are equal to fifty-six livres five sols French money; and of the great, 6000 are equal to four shillings and sixpence sterling.

**CAXAMALCA**, the name of a town and district of Peru, in South America, where there was a most sumptuous palace belonging to the Yncas, and a magnificent temple dedicated to the sun. It was at Caxamalca that Pizarro put to death Athualpha, their last king.

**CAY**, in zoology, a synonyme of the simia midas. See **SIMIA**.

**CAZEROM**, or **CAZERON**, a city of Persia, the capital of the province of Kurch Schabour, situated in 70° E. long. and 29° 15' N. lat.

**CAZIMIR**, a town of Poland, in the palatinate of Lublin.

**CEANOTHUS**, in botany, a genus of the pentandria monogynia class. The petals are vaulted; and the berry is dry, having three cells, containing each one seed. There are three species, none of them natives of Britain.

**CECROPIA**, in botany, a genus of the diœcia diandria class. The spathe of the male is caducous; the amenta are imbricated with helmet-shaped scales; and the corolla is wanting. The germina of the female are imbricated; it has but one stylus; the stigma is lacerated; and the berry contains but one seed. There is one species, viz. the peltata, a native of Jamaica.

**CEDAR**, in botany, the English name of a species of juniperus. See **JUNIPERUS**.

**CEDRELA**, in botany, a genus of the pentandria monogynia class. The calix is bell shaped, and divided into three segments; the corolla is shaped like a funnel, and has five petals inserted into the base of the receptacle; the capsule is lignous, and has five cells and five valves; the seeds are imbricated on the back part, and have membranaceous edges. There is but one species, viz. the odorata, a native of America.

**CEDRUS**, in botany. See **JUNIPERUS**, and **PINUS**.

**CELANDINE**, in botany. See **CHELIDONIUM**.

**CELASTRUS**, in botany, a genus of the pentandria monogynia class. The corolla consists of five open petals; the capsule is triangular, and has three cells; and the seeds have a calyptra. There are five species, none of them natives of Britain.

**CELERES**, in Roman antiquity, a regiment of bodyguards, belonging to the Roman kings, established by Romulus, and composed of 300 young men, chosen out of the most illustrious Roman families, and approved by the suffrages of the curiæ of the people, each of which furnished ten.

**CELERI**, in botany, the English name of the apium graveolens, or celery, which is cultivated in our gardens as a pot-herb.

**CELERITY**, in mechanics, the swiftness of any body in motion.

It is also defined to be an affection of motion, by which any moveable body runs through a given space in a given time. See **MECHANICS**.

**CELESTINS**, in church-history, a religious order of Christians, reformed from the Bernardins by pope Celestin V. Their rules are divided into three parts; the first, of the provincial chapters, and the elections of superiors; the second contains the regular observances; and the third, the visitation and correction of the monks.

The Celestins rise two hours after midnight to say matins: they eat no flesh at any time, except when they are sick: they fast every Wednesday and Friday to the feast of the exaltation of the holy cross; and from that feast to Easter, every day.

**CELIBACY**, the state of unmarried persons, to which, according to the doctrine, or at least the discipline, of the church of Rome, the clergy are obliged.

That celibacy has no pretence of divine or apostolical institution, seems no difficult point to prove: whence it is, at first, hard to conceive from what motive the court of Rome persisted so very obstinately to impose this institution on the clergy. But we are to observe, that this was a leading step to the execution of the project formed of making the clergy independent of princes, and rendering them a separate body, to be governed by their own laws. In effect, while priests had children, it was very difficult to prevent their dependence upon princes, whose favours have such an influence on private men; but having no family, they were more at liberty to adhere to the pope.

**CELOSIA**, in botany, a genus of the pentandria monogynia class. The calix has three leaves; the stamina are joined to the base of a plaited nectarium; and the capsule opens horizontally. There are eight species, none of them natives of Britain.

**CELSIA**, in botany, a genus of the didynamia angiospermia class. The calix is divided into five segments; the corolla is rotated; the filaments are barbed; and the capsule is bilocular. There is but one species, viz. the orientalis, a native of Greece.

**CELTIS**, in botany, a genus of the polygamia monœcia class. The calix of the hermaphrodite is divided into five segments; it has no corolla; there are five

stamina, and two styli; the drupa contains but one seed. The calix of the male is divided into six segments; it has no corolla; and the stamina are six. The species are three, none of them natives of Britain.

**CEMENT**, or **CÆMENT**. See **CÆMENT**.

**CEMENTATION**. See **CÆMENTATION**.

**CEMETERY**. See **COEMETERY**.

**CENADA**, a town of the Venetian territories in Italy, situated about thirty-two miles north of Padua: E. long. 12° 40'. and N. lat. 46° 5'.

**CENCHRAMIDEA**, in botany. See **CLUSIA**.

**CENCHRIS**; in zoology, a synonyme of the boa constrictor. See **BOA**.

**CENCHRUS**, in botany, a genus of the polygamia monœcia class. The involucre is lacinated, and incloses two flowers; the calix is a two flowered gluma, one of the flowers being a male, and the other a female. The corolla of the hermaphrodite is a blunt gluma; the stamina are three; and the stylus is bifid; there is but one seed. The corolla of the male is likewise an obtuse gluma; and there are three stamina. The species are six, none of them natives of Britain.

**CENCONTLAOLLI**, in ornithology. See **TURDUS**.

**CENOBITE**, or **COENOBITE**. See **COENOBITE**.

**CENOTAPH**, in antiquity, a monument erected in honour of the dead, but not containing any of their remains. Of these there were two sorts; one erected for such persons as had been honoured with funeral rites in another place; and the second sort, for those that had never obtained a just funeral.

The sign whereby honorary sepulchres were distinguished from others, was commonly the wreck of a ship, to denote the decease of the person in some foreign country.

**CENSER**, a sacred instrument made use of in the religious rites of the ancients. It was a vase, containing incense to be used in sacrificing to the gods. Censers were likewise in use among the Jews, as we find in 1 Kings vii. 50. The censer is also used in Romish churches.

**CENSOR**, in Roman antiquity, a magistrate, whose business it was to reform the manners, and to value the estates of the people.

There were two censors first created in the 311th year of Rome, upon the senate's observing that the consuls were generally so much taken up in military actions as to have no leisure to attend to private affairs. At first they were chosen out of the senate, but after the plebeians had got the consulate open to them, they soon arrived at the censorship.

After the censors were elected in the comitia centuriata, they proceeded to the capitol, where they took an oath not to manage either by favour or disaffection, but to act equitably and impartially through the whole course of their administration: and, notwithstanding their great authority, they were obliged to give an account of their management to the tribunes and *ediles curules*. In process of time, the dignity of this office dwindled very much; under the emperors it sunk to

nothing, as their majesties engrossed all the branches of that jurisdiction. The republic of Venice has at this day a censor of manners of their people, whose office lasts six months.

**CENSORS of books**, are a body of doctors or others established in divers countries, to examine all books before they go to the press, and to see they contain nothing contrary to faith and good manners.

At Paris, the faculty of theology claim this privilege, as granted to them by the pope; but in 1624, new commissions of four doctors were created, by letters-patent, the sole censors of all books, and answerable for every thing contained therein.

In England, we had formerly an officer of this kind, under the title of Licensor of the press; but, since the revolution, our press has been laid under no such restraint.

**CENSURE**, a judgment which condemns some book, person, or action, or more particularly a reprimand from a superior. Ecclesiastical censures, are penalties by which, for some remarkable misbehaviour, Christians are deprived of the communion of the church, or prohibited to execute the sacerdotal office.

**CENSUS**, in Roman antiquity, an authentic declaration made before the censors, by the several subjects of the empire, of their respective names and places of abode. This declaration was registered by the censors, and contained an enumeration, in writing, of all the estates, lands, and inheritances they possessed; their quantity, quality, place, wives, children, domestics, tenants, slaves.

The census was instituted by Servius Tullius, and was held every five years. It was of great service to the republic, because, by means of it, they discovered the number of citizens capable of bearing arms, and the money they could afford for the expence of a war. It went through all ranks of people, though under different names: that of the common people was called *census*; that of the knights, *census, recensio, recognitio*; that of the senators, *lectio, relectio*.

The census which intitled one to the dignity of a knight, was 400,000 sesterces: that of a senator, was double that sum.

In the Voconian law, census is used for a man, whose estate in the censor's books is valued at 100,000 sesterces.

**CENTAUR**, in ancient poetry, denotes a fabulous kind of animal, half man, half horse.

The Thessalians, who first taught the art of breaking horses, appearing on horseback to make only one body with the animal on which they rode, gave rise to the fiction of the hippocentaur.

**CENTAUREA**, in botany, a genus of the syngenesia polygamia frustranea class. The receptacle is bristly; the pappus is simple; the rays of the corolla are tunnel-shaped, long, and irregular. There are 61 species, five of which are natives of Britain, *viz.* the cyanus, or blue-bottle; the scabiosa, or great knapweed; the jacea, or common knapweed; the calcitrapa, or star-thistle; and the solstitialis, or St Barnaby's thistle.

**CENTAURY**.



**CENTAURY.** See **CHELIDONIUM.**

**CENTER of gravity,** in mechanics, that point about which all the parts of a body do, in any situation, exactly balance each other. See **MECHANICS.**

**CENTER of motion,** that point which remains at rest, while all the other parts of a body move about it. See **MECHANICS.**

**CENTESIMATION,** a milder kind of military punishment, in cases of desertion, mutiny, and the like, when only every hundredth man is executed.

**CENTIPES,** in zoology. See **SCOLOPENDRA.**

**CENTONARII,** in antiquity, certain officers of the Roman army, who provided tents and other stuff, called centones, made use of to quench the fire which the enemy's engines threw into the camp.

Their centonarii kept with the carpenters and other officers of the artillery.

**CENTRAL FORCES,** the powers which cause a moving body to tend towards, or recede from the centre of motion. See **MECHANICS.**

**CENTRAL RULE,** a rule discovered by Mr Thomas Baker, whereby to find the centre of a circle designed to cut the parabola in as many points, as an equation to be constructed hath real roots. Its principal use is in the construction of equations, and he has applied it with good success as far as biquadratics.

The central rule is chiefly founded on this property of the parabola, that if a line be inscribed in that curve perpendicular to any diameter, a rectangle formed of the segments of the inscript, is equal to the rectangle of the intercepted diameter and parameter of the axis.

The central rule has the advantage over Cartes and De Latere's methods of constructing equations, in that both these are subject to the trouble of preparing the equation, by taking away the second term.

**CENTRIFUGAL FORCE,** that force by which all bodies that move round any other body in a curve, endeavour to fly off from the axis of their motion in a tangent to the periphery of the curve, and that in every point of it. See **MECHANICS.**

**CENTRINA,** in ichthyology, the trivial name of a species of *Squalus*. See **SQUALUS.**

**CENTRIPETAL FORCE,** that force by which a body is every where impelled, or any how tends towards some point as a centre. See **MECHANICS.**

**CENTRISCUS,** in ichthyology, a genus belonging to the order of amphibia nantes. The head gradually ends in a narrow snout; the aperture is broad and flat; the belly is carinated; and the belly-fins are united. There are two species, *viz.* 1. The *scutatus* has its back covered with a smooth bony shell, which ends in a sharp spine, under which is the tail; but the back-fins are between the tail and the spine. It is a native of the East Indies. 2. The *scolopax* has a rough scabrous body, and a strait extended tail. It has two belly-fins, with four rays in each, and has no teeth. It is found in the Mediterranean.

**CENTUMVIRI,** in Roman antiquity, judges appointed to decide common causes among the people: they were

chosen three out of each tribe; and though five more than an hundred, were nevertheless called *centumviri*, from the round number *centum*, an hundred.

**CENTUNCULUS,** in botany, a genus of the tetrandria monogynia class. The calix consists of four segments; the corolla has four divisions, and open; the stamina are short; and the capsule has but one cell. There is only one species, *viz.* the *minimus*, or bastard pimpernel, a native of Britain.

**CENTURION,** among the Romans, an officer in the infantry, who commanded a century, or an hundred men.

The centurions held the first rank in the first cohort of a legion, and two of them the place of the two first *hastati* or pike-men: the first among the principes was also a centurion.

The centurion *primipilus* was the chief of the centurions: he was not under the command of any tribune, as all the rest were; he had four centuries under his direction, and guarded the standard and the eagle of the legion.

**CENTURY,** in a general sense, any thing divided into or consisting of an hundred parts.

The Roman people, when they were assembled for the electing of magistrates, enacting of laws, or deliberating upon any public affair, were always divided into centuries, and voted by centuries, in order that their suffrages might be the more easily collected; whence these assemblies were called *comitia centuriata*. The Roman cohorts were also divided into centuries. See **CENTURION** and **COHORT.**

**CENTURY,** in chronology, the space of one hundred years.

This method of computing by centuries is generally observed in church-history, commencing from the time of our Saviour's incarnation; in which sense we say the first century, the second century, &c.

**CENTURIES of Magdeburg,** a famous ecclesiastical history, ranged into thirteen centuries, carried down to the year 1298, compiled by several hundred Protestants of Magdeburg, the chief of whom was Matthias Flacius Illyricus.

**CENTUSSIS,** in Roman antiquity, a coin containing an hundred asses.

**CEPA,** in botany, the trivial name of a species of *Allium*. See **ALLIUM.**

**CEPÆA,** in botany. See **SEDUM.**

**CEPHALANTHUS,** in botany, a genus of the tetrandria monogynia class. It has no common calix; the proper calix is tunnel-shaped; the receptacle is globular, and naked; and the seeds are downy. There is but one species, *viz.* the *occidentalis*, a native of America.

**CEPHALIC,** in a general meaning, signifies any thing belonging to the head.

**CEPHALIC medicines** are remedies for disorders of the head.

**CEPHALIC vein,** in anatomy. See p. 241.

**CEPHALONIA,** the capital of an island of the same name, situated in the Mediterranean, near the coast of

- of Epirus, and subject to the Venetians: E. long. 21°, and N. lat. 38° 30'.
- CEPHALOPHARYNGÆI**, in anatomy. See p. 302.
- CEPHALUS**, in ichthyology, the trivial name of a species of mugil. See **MUGIL**.
- CEPHEUS**, in astronomy, a constellation of the northern hemisphere.
- CERHUS**, in ornithology, a synonyme of a species of larus. See **LARUS**.
- CERAM**, an island in the Indian ocean, between the Molucca islands on the north, and those of Amboyna and Banda on the south, lying between 126° and 129° E. long. and in 3° S. lat.  
It is about one hundred and fifty miles long, and sixty broad; and here the Dutch have a fortress, which keeps the natives in subjection.
- CERAMBYX**, in zoology, a genus of insects of the beetle kind, belonging to the order of insecta coleoptera. The antennæ are long and small; the breast is spinous or gibbous; and the elytra are linear. There are no less than 83 species enumerated by Linnæus, principally distinguished by the figure of the breast.
- CERASTES**, in zoology, the trivial name of a species of coluber; it is likewise the trivial name of a species of anguis. See **ANGUIS**, and **COLUBER**.
- CERASTIUM**, in botany, a genus of the decandria pentagynia class. The calix has five leaves; the petals are bifid; and the capsule is unilocular, and opens at the top. There are sixteen species, seven of which are natives of Britain, *viz.* the vulgatum, or narrow-leaved mouse-ear chickweed; the viscosum, or broad-leaved mouse-ear chickweed; the semidecandrium, or least mouse-ear chickweed; the arvense, or corn mouse-ear chickweed; the alpinum, or mountain mouse-ear chickweed; the tomentosum, or woolly mouse-ear chickweed; and the aquaticum, or marsh mouse-ear chickweed.
- CERASUS**, in botany, the trivial name of a species of prunus. See **PRUNUS**.
- CERATE**, in pharmacy, a kind of ointment applied to ulcerations, excoriations, &c. There are four kinds of cerate, *viz.* the *white cerate*, which is composed of a quarter of a pint of olive oil, four ounces of white wax, and half an ounce of spermaceti, liquified together and sharred till the cerate be cold. The *yellow cerate* is composed of half a pound of yellow basilicum ointment, and an ounce of yellow wax, melted together. The *ceratum epuloticum*, is composed of one pint of olive-oil, and of yellow wax and calamine prepared each half a pound. Liquify the wax with the oil, and, as soon as the mixture begins to grow stiff, sprinkle in the calamine, keeping them constantly stirring till the cerate is quite cold. The *mercurial cerate* is composed of yellow wax, hogs lard dried, each half a pound; three ounces of quick-silver; and one dram of simple balsam of sulphur. Melt the wax with the lard, then gradually add this mixture to the quick-silver and balsam of sulphur previously ground together.
- CERATION**, the name given by the ancients to the small seeds of the ceratonia, used by the Arabian physicians. as a weight to adjust the doses of medicines; as the grain weight with us took its rise from a grain of barley.
- CERATION**, or **CERATIUM**, was also a silver coin, equal to one third of an obolus.
- CERATOCARPUS**, in botany, a genus of the monœcia monandria class. The calix of the male is divided into two parts; it has no corolla; and the filament is long: The calix of the female consists of two leaves connected to the germen; it has no corolla; the styli are two; and the seeds are bicorned and compressed. There is but one species, *viz.* the arenarius, a native of Tartary.
- CERATOCEPHALOIDES**, in botany. See **VERBESINA**.
- CERATOCEPHALUS**, in botany. See **BIDENS**.
- CERATOIDES**, in botany. See **URTICA**.
- CERATONIA**, in botany, a genus of the polygamia polyœcia class. It is a native of Sicily, Crete, and other eastern countries.
- CERATOPHYLLUM**, in botany, a genus of the monœcia polyandria class. The calix of the male is divided into many segments; it has no corolla; and the stamina are from 16 to 20. The calix and corolla of the female are the same with those of the male; it has one pistil, no stylus, and one naked seed. There are two species, one of which, *viz.* the demersum or horned pondweed, is a native of Britain.
- CERATUM**, in pharmacy. See **CERATE**.
- CERBERA**, in botany, a genus of the pentandria monogynia class. The fruit is a drupa containing one seed. There are three species, all of them natives of the Indies.
- CERCELE**, in heraldry. A cross cercele is a cross which opening at the ends, turns round both ways, like a ram's horn. See **CROSS**.
- CERCIS**, in botany, a genus of the decandria monogynia class. The calix is five-toothed, and gibbous below; the corolla is papilionaceous, with a short vexillum under the wings; the capsule is a legumen. There are two species, none of them natives of Britain.
- CEREBELLUM**, in anatomy. See p. 286.
- CEREBRUM**, in anatomy. See p. 285.
- CEREMONY**, an assemblage of several actions, forms, and circumstances, serving to render a thing more magnificent and solemn; particularly used to denote the external rites of religious worship, the formalities of introducing ambassadors to audiences, &c.  
*Master of the CEREMONIES*, an officer instituted by king James I. for the more honourable reception of ambassadors and strangers of quality: he wears about his neck a chain of gold, with a medal under the crown of Great Britain, having on one side an emblem of peace, with this motto, *beati pacifici*; and on the other, an emblem of war, with *dicu et mon droit*: his salary is three hundred pounds *per annum*.  
*Assistant master of the CEREMONIES* is to execute the employment in all points, whensoever the master of the

the ceremonies is absent. His salary is one hundred and forty-one pounds thirteen shillings and fourpence *per annum*.

*Marshal of the CEREMONIES* is their officer, being subordinate to them both. His salary is one hundred pounds *per annum*.

**CEREUS**, in botany. See **CACTUS**.

**CERIGO**, or **CYTHERA**, in geography, an island of the Archipelago, on the eastern coast of the Morea, and fifty miles north of the island of Candia. It is a mountainous country, between forty and fifty miles in circumference, and situated in E. long. 23° 40', and N. lat. 36°.

**CERINTHE**, in botany, a genus of the pentandria monogynia class. The limbus of the corolla is tubular and ventricose, opening at the faux; the seeds are often four, and sometimes two. There are only two species, none of them natives of Britain.

**CERINTHIANS**, in church-history, Christian heretics, followers of Cerinthus, who lived and published his heresy in the time of the apostles themselves. They did not allow that God was the author of the creatures, but said that the world was created by an inferior power: they attributed to this creator an only son, but born in time, and different from the world: they admitted several angels and inferior powers: they maintained that the law and the prophets came not from God, but from the angels; and that the God of the Jews was only an angel: they distinguished between Jesus and Christ; and said, that Jesus was a mere man, born, like other men, of Joseph and Mary; but that he excelled all other men in prudence and wisdom; that Jesus being baptized, the Christ of the supreme God, that is, the Holy Ghost, descended upon him; and that by the assistance of this Christ, Jesus performed his miracles. It was partly to refute this sect that St John wrote his gospel.

**CERINTHOIDES**, in botany. See **CERINTHE**.

**CEROPEGIA**, in botany, a genus of the pentandria monogynia class. The limbus of the corolla is connivent; and the seeds are plumose. There are two species, both natives of India.

**CERRUS**, in botany. See **ÆGILOPS**.

**CERTHIA**, in ornithology, a genus belonging to the order of picæ. The beak of this genus is arched, slender, sharp, and triangular; the tongue is sharp at the point; and the feet are of the walking kind, *i. e.* having the toes open and unconnected. There are 25 species, *viz.* 1. The familiaris, or creeper, is grey above and white underneath, with brown wings, and ten white spots on the ten prime feathers. It is a native of Europe, creeps up trees, lays about 20 eggs, and feeds upon caterpillars and the eggs of insects. 2. The muraria, or wall-creeper, is ash-coloured, with yellow spots on the wings. It frequents towers and old walls, in the holes of which it builds its nest. 3. The pusilla, is grey above, and white below; the eye-brows are white; the prime feathers of the wings are brown, and white on the outer edge. It is a native of India. 4. The capensis, is grey, with blackish wings, the outermost prime feathers of which are

edged with white: It is a native of the Cape of Good-Hope. 5. The olivacea, is olive-coloured above, and grey below, with the orbits of the eyes white. It is found in Madagascar. 6. The currucaia is likewise olive above, but yellowish below; and the prime wing-feathers are equal. It is a native of Ceylon. 7. The jugularis is greyish above, and yellowish below; the throat is of a violet colour; and the two outermost prime feathers of the wings are yellow at the points. It is found in the Philippine Isles. 8. The cærulea has a blue belt round the eyes; and the throat, and prime wing and tail feathers are black: The bill is very long. It is a native of Surinam. 9. The cayana is of a green shining colour above, and streaked with white below. It is a native of Cayenne. 10. The chalybeata is green and shining above; the breast is red, and on the fore-part of it there is an iron-coloured belt. 11. The asra is green above; the breast is red; the belly is white; and it has a short blue tail. The above two species are found at the Cape of Good-Hope. 12. The spiza is green, with the head and prime wing-feathers black. It is a native of Brasil. 13. The sperata is purple above, and red below; the head, throat, and tail, are violet. It is found in the Philippine Isles. 14. The senegalensis is of a blackish violet colour; the top of the head and throat are greenish, and the breast is red. It is a native of Senegal. 15. The gutturalis is greenish; the throat is a shining green, and the breast is purple. It is a native of Brasil. 16. The pinus is yellow below, and olive above; the wings are blue, with two white belts. It is a native of North America. 17. The cruenta is blackish above, and white below; the top of the head, the neck, and tail, are red. It is a native of Bengal. 18. The flaveola is black above, and yellow below; the eye-brows, and the tops of the outermost prime wing-feathers, are white. It is a native of America. 19. The pulchella has a green shining body, and a red breast; the two intermediate prime wing-feathers are very long. It is a native of Senegal. 20. The famosa has the two intermediate prime wing-feathers very long; the body is of a shining green; and the axillæ of the wings are yellow. It is found at the Cape of Good-Hope. 21. The philippina has the two intermediate wing-feathers very long, a greenish grey body, and yellowish underneath. It is a native of the Philippine Isles. 22. The violacea has the two intermediate prime wing-feathers very long, a shining violet-coloured body, and the breast and belly are yellow. 23. The zeylonica has a green head, an iron-coloured back, a yellow belly, and the throat and tail are azure. It is a native of Ceylon. 24. The cyanea is blue, with a black belt round the eyes; the shoulders, wings, and tail are black, and the feet are red. It is a native of Brasil and Cayenne. 25. The lotentia is blue, with a red belt over the breast. It is a native of Ceylon.

**CERTIORARI**, a writ which issues out of the chancery, directed to an inferior court, to call up the records of a cause there depending, in order that justice may be done. And this writ is obtained upon complaint, that

the party who seeks it has received hard usage, or is not like to have an impartial trial in the inferior court. A certiorari is made returnable either in the king's bench, common pleas, or in chancery.

It is not only issued out of the court of chancery, but likewise out of the king's bench, in which last mentioned court it lies where the king would be certified of a record. Indictments from inferior courts, and proceedings of the quarter-sessions of the peace, may also be removed into the king's bench by a certiorari; and here the very record must be returned, and not a transcript of it; though usually in chancery, if a certiorari be returnable there, it removes only a tenor of the record.

**CERTITUDE**, considered in the things or ideas which are the objects of our understanding, is a necessary agreement or disagreement of one part of our knowledge with another: as applied to the mind, it is the perception of such agreement or disagreement; or such a firm well-grounded assent, as excludes not only all manner of doubt, but all conceivable possibility of a mistake.

There are three sorts of certitude, or assurance, according to the different natures and circumstances of things.

1. A physical or natural certitude, which depends upon the evidence of sense; as that I see such or such a colour, or hear such or such a sound: no body questions the truth of this, where the organs, the medium, and the object are rightly disposed. 2. Mathematical certitude is that arising from mathematical evidence; such is, that the three angles of a triangle are equal to two right ones. 3. Moral certitude is that founded on moral evidence, and is frequently equivalent to a mathematical one; as that there was formerly such an emperor as Julius Cæsar, and that he wrote the Commentaries which pass under his name; because the historians of these times have recorded it, and no man has ever disproved it since: this affords a moral certitude, in common sense so great, that one would be thought a fool or a madman for denying it.

**CERVIA**, in geography, a city and port-town of Romania, in Italy, situated on the gulph of Venice, about ten miles south-east of Ravenna, and subject to the pope: E. long. 13°, and N. lat. 44° 30'.

**CERVICAL nerves**, in anatomy. See p. 251.

**CERVIX**, in anatomy. See p. 166.

**CERVIX of the uterus**. See p. 274.

**CERUMEN**, EAR-WAX. See p. 296.

**CERUSE**, or **CERUSS**, *white lead*, a sort of calx of lead, made by exposing plates of that metal to the vapour of vinegar.

The best way of preparing it is the following: A glass-cucurbit is to be cut off in such a manner as to leave it a very long mouth; an alembic head of glass is to be fitted to this; some vinegar is to be put into the body, and a number of thin plates of lead are to be placed in the head in such a manner that they may stand somewhat erect: when the head is fitted on, the body is to be set in a gentle sand-heat for twelve hours; then unluting the vessels, the receiver, which had been

fitted to the nose of the head, will contain a sweet and styptic liquor, nauseous and turbid, called the vinegar of lead, or the solution of lead; and the plates of lead, taken out of the head, will be found covered with a white dusty matter; this is cerufs; and if the operation be repeated, the whole lead will be in fine reduced to this state of cerufs.

Cerufs is used externally either mixed in ointments, or by sprinkling it on old gleting and watery ulcers, and in many diseases of the skin. If, when it is reduced into a fine powder, it is received in with the breath in inspiration, and carried down into the lungs, it causes terrible asthma's, that are almost incurable, and at last generally prove fatal: sad instances of the very pernicious effects of this metal are too often seen among those persons who work lead in any form, but particularly among the workers in white-lead.

The painters use it in great quantities, and, that it may be afforded cheap to them, it is generally adulterated with common whiting: the English and Dutch cerufs are very bad in this respect: the Venetian ought always to be used by apothecaries.

**CERUSS of antimony**, a medicine prepared by distilling powdered regulus of antimony with spirit of nitre, till no more fumes arise; what remains in the retort being pulverised and washed, makes the cerufs of antimony, which is esteemed a powerful diuretic.

**CERVUS**, or **DEER**, in zoology, a genus of quadrupeds belonging to the order of pecora. The horns are solid, brittle, covered with a hairy skin, and growing from the top; they likewise fall off, and are renewed annually. There are eight fore-teeth in the under jaw, and they have no dog-teeth. The species of this genus are seven, viz. 1. The camelopardalis, with simple or unbranched horns, and the fore-feet remarkably longer than the hind feet. This is an uncommon animal, few of them having ever been seen in Europe. It is a native of Æthiopia, and is very mild and gentle: The head is like that of a stag; its horns are blunt and about six inches long. The neck resembles that of a camel, but much longer, being sometimes seven feet in length. The body is small, covered with white hair, and spotted with red. He is eighteen feet in length from the tail to the top of the head; and when he holds up his head, it is sixteen feet from the ground. He feeds principally on the leaves of trees.

2. The alces, or elk, has palmated horns, without any proper stem, and a fleshy protuberance on the throat. This is the largest animal of the deer kind. At the fair of St Germain at Paris, in the year 1752, a female elk was exhibited as a show. It was caught in the year 1749, in a forest of Red Russia, belonging to a Khan of Tartary. The height was six feet seven inches, the length ten feet, and the thickness eight. The hair was long, like that of a wild boar. The skin is said to resist the force of a gun bullet. The elk is a very swift animal; and he feeds upon leaves of alder, birch, willow, &c. When tamed, he devours large quantities of hay or bread. This animal is found in the northern woods of Europe, Asia, and America.

3. The

3. The claphus, is a kind of elk, with cylindrical ramified horns, bent backwards. It is a native of the northern parts of Europe and Asia.

4. The tarandus, or rein-deer, is a native of Lapland, and the northern parts of Europe, Asia, and America. The horns are large, cylindrical, branched, and palmated at the tops. Two of the branches hang over the face. He is about the size of a buck, of a dirty whitish colour; the hairs of his skin are thick and strong. These animals are of great use to the Laplanders; they feed upon their flesh; they employ their sinews in sewing the boards of sledges together, and their milk affords them good cheese: They likewise make garments of their skins. The rein-deer are always employed in drawing sledges along the snowy mountains, where horses cannot travel. In a beaten track, they will drag a sledge twenty-five miles a day. When the animal is tired, his master looses him from the sledge, and he immediately scrapes the snow from the ground with his feet, and feeds upon a species of liver-wort, called rein-deer liver-wort, which is very plentiful in these countries. This is the only nourishment they require.

5. The dama, or buck and doe, a well known animal, kept tame in parks; the horns are branched, compressed, and palmated at the top. It is a native of Europe. Their flesh, which goes by the name of venison, is in high repute with the luxurious. See Plate LXIII.

6. The capreolus, has erect, cylindrical, branched horns, and forked at the top. It is called by some authors the Brazilian goat, and is a native of Europe and Asia.

7. The Guineensis, is of a greyish colour, and black underneath. It is a native of Guinea, and the size and figure of its horns have not been hitherto described with any precision.

**CERVUS volans**, in zoology, a synonyme of a species of lucanus. See **LUCANUS**.

**CESARE**, among logicians, one of the modes of the second figure of syllogisms; the minor proposition of which is an universal affirmative, and the other two universal negatives: Thus,

**CE** No immoral books ought to be read:

**SA** But every obscene book is immoral:

**RE** Therefore no obscene book ought to be read.

**CESSIO bonorum**, in Scots law. The name of that action by which an insolvent debtor may apply for liberation from prison, upon making over his whole real and personal estate to his creditors. See **SCOTS-LAW**, title, *Sentences and their execution*.

**CESTRUM**, in botany, a genus of the pentandria monogynia class. The corolla is tunnel-shaped; and the berry is unilocular. There are two species, both natives of America.

**GESTUS**, among ancient poets, a fine embroidered girdle said to be worn by Venus, to which Homer ascribes the faculty of charming and conciliating love.

**CETACEOUS**, an appellation given to fishes of the whale kind.

**GETE**, the name of Linnæus's seventh order of mammalia, comprehending the **MONODON**, **BALÆNA**,

**PHYSETER**, and **DELPHINUS**; see these articles. **CETERACH**, in botany, the trivial name of a species of asplenium. See **ASPENIUM**.

**CETTE**, a port-town of Languedoc, in France, situated on a bay of the Mediterranean, in E. long. 5° 16', and N. lat. 43° 25'.

**CETUS**, in astronomy, a constellation of the southern hemisphere, comprehending twenty-two stars in Ptolemy's catalogue, twenty-one in Tycho's, and in the Britannic catalogue seventy-eight.

**CEUTA**, a city of the kingdom of Fez, in Africa, situated on the south side of the straits of Gibraltar, almost opposite to it: W. long. 6° 30', and N. lat. 35° 50'. It is a strong fortress, in the possession of the Spaniards.

**CEYLON**, an island in the Indian ocean, situated between 78° and 82° E. long. and between 6° and 10° N. lat. It is about two hundred and fifty miles long, and two hundred broad. The Dutch, who are in possession of all the sea-coast, monopolize all the cinnamon produced in the island, the king being obliged to keep in the centre of the island, in his capital of Candy.

**CHABLAIS**, a country of Savoy, with the title of duchy.

**CHACO**, a large country of South America, situated between 19° and 27° S. lat.

**CHÆROPHYLLUM**, or **CHERVIL**, in botany, a genus of the pentandria digynia class. The involucre is concave and reflected; the petals are cordated; and the fruit is smooth and oblong. The species are seven, only two of which are natives of Britain, *viz.* the sylvestre, or wild cicely, or cow-weed; and the tumulum, or wild chervil. The leaves of the chervil are gently aperient and diuretic, and at the same time grateful to the palate and stomach.

**CHÆTODON**, in ichthyology, a genus of fishes belonging to the order of thoraci. The teeth are very numerous, thick, setaceous, and flexile: The rays of the gills are six. The back-fin and the fin at the anus are fleshy and squamous. There are twenty-three species, distinguished from each other principally by the figure of the tail, and the number of spines in the back-fin.

**CHAFF-FINCH**, in ornithology, the English name of a species of fringilla. See **FRINGILLA**.

**CHAGRE**, a fort at the mouth of a river of the same name, a little south of Porto Bello: W. long. 82°, and N. lat. 9° 50'.

**CHAIN**, a long piece of metal composed of several links or rings, engaged the one in the other. They are made of divers metals, some round, some flat, others square; some single, some double; and serve to so many uses, that it would be tedious to give a particular account of them all.

**CHAIN** is also a kind of measure in France, in the trade of wood for fuel: There are chains for wood by tale, for wood by the rope, for faggots, for cleft wood, and for round sticks. There are also chains measuring the sheaves of all sorts of corn, particularly with regard to the payment of tythes; for measuring pottles of hay,

- hay, and for measuring horses. All these are divided into feet, inches, hands, &c. according to the use they are designed for.
- CHAIN-shot**, two bullets with a chain between them. They are used at sea to shoot down yards or masts, and to cut the shrouds or rigging of a ship.
- CHAIN**, in surveying, a measure of length, made of a certain number of links of iron-wire, serving to take the distance between two or more places.
- Gunter's chain of 100 such links, each measuring  $7\frac{1}{2}$  inches, and consequently equal to 66 feet, or four poles. See **SURVEYING**.
- CHAISE**, a sort of light, open chariot, or calash. See **CHARIOT**.
- CHALAZA**, among naturalists, a white knotty sort of string at each end of an egg, formed of a plexus of the fibres of the membranes, whereby the yolk and white are connected together. See **EGG**.
- CHALCEDONY**, in natural history, a genus of semi-transparent gems, of an even and regular not tabulated texture, of a semi-opaque crystalline basis, and variegated with different colours, dispersed in form of mists and clouds, and, if nicely examined, found to be owing to an admixture of various kinds of earths, but imperfectly blended in the mass, and often visible in distinct molecules.
- Of this genus there are a great many species, as the bluish-white chalcedony; the brownish-black chalcedony, or smoky jasper or capnitis of the ancients; and the yellow and red chalcedony.
- All the chalcedonies give fire readily with steel, and make no effervescence with aqua-fortis.
- CHALCIDES**, in zoology, the trivial name of a species lacerta. See **LACERTA**.
- CHALDEA**, or **BABYLONIA**, the ancient name of a country of Asia, now called Eyrac Arabic.
- CHALDEE**, or **CHALDAIC language**, that spoken by the Chaldeans, or people of Chaldea: It is a dialect of the Hebrew. See **HEBREW**.
- CHALDRON**, a dry English measure, consisting of thirty-six bushels, heaped up, according to the sealed bushel kept at Guild-hall, London: but on ship-board, twenty-one chaldron of coals are allowed to the score. The chaldron should weigh two thousand pounds.
- CHALK**, in natural-history, the English name of the white, dry marle, with a dusty surface, found in hard masses, and called by authors *creta*, and *terra creta*.
- Chalk thrown into water, raises a great number of bubbles, with a hissing noise, and slowly diffuses itself into an impalpable powder. It ferments more strongly with acids than any other earth, and burns to lime.
- As a medicine, chalk deserves, perhaps, the highest place among the alkaline absorbents; nor is it less useful in many of the ordinary affairs of life. Its use in cleaning various utensils is well known; and it is in no small repute as a manure, especially for cold sour lands; in which intention the soft unctuous chalk is most proper, as the dry, hard, and strong chalk is for lime. It is a great improver of lands, and will even change the very nature of them. However, it is most advisable to mix one load of chalk, with two or three of dung, mud, or fresh mould, whereby it will become a lasting advantage to the ground: The common allowance is fourteen loads of chalk to every acre.
- Black CHALK**, among painters, denotes a kind of ochreous earth, of a close structure, and fine black colour, used in drawing upon blue paper.
- Red CHALK**, an indurated clayey ochre, common in the colour-shops, and much used by painters and artificers.
- CHALLONS on the Marne**, the capital of the Châlonsis, in the province of Champaign in France, situated eighty-two miles east of Paris, and thirty south-east of Reims: E. long.  $4^{\circ} 35'$ , N. lat.  $48^{\circ} 55'$ . It is a bishop's see.
- CHALLONS on the Saon**, a city of Burgundy in France, thirty-two miles south of Dijon: E. long.  $5^{\circ}$ , N. lat.  $46^{\circ} 40'$ . It is the see of a bishop.
- CHALYBEAT**, in medicine, an appellation given to any liquid, as wine or water, impregnated with particles of iron or steel.
- Dr. Monro, professor of anatomy at Edinburgh, by pouring a tincture of galls into common water, and dissolving therein a small quantity of sal martis, adding some filings of iron, and oil of vitrol, procured a water exactly like the natural chalybeat water; and he is of opinion, that where these are not to be had, the artificial water may be made to answer all their intentions, according to its being more or less closely kept, or exposed in the air or heat, &c.
- CHAM**, or **KHAN**, a word of much the same import with *king* in English: It is the title of the sovereign princes of Tartary, and is likewise applied to the principal noblemen in Persia.
- CHAM**, in geography, a town of the Bavarian palatinate, situated on a river of the same name, about twenty-five miles north-east of Ratibon; E. long.  $13^{\circ}$ , N. lat.  $49^{\circ} 15'$ .
- CHAMA**, in zoology, a genus of shell-fish belonging to the order of vermes testacea. The shell is thick, and has two valves; it is an animal of the oyster kind. Linnæus enumerates 14 species, principally distinguished by the figure of their shells.
- CHAMÆBATOS**, in botany. See **RUBUS**.
- CHAMÆBUXUS**, in botany. See **POLYGALA**.
- CHAMÆCERASUS**, in botany. See **LONICERA**.
- CHAMÆCLEMA**, in botany. See **HEDERA**.
- CHAMÆCRISTA**, in botany. See **CASSIA**.
- CHAMÆDAPHNE**, in botany. See **KALMIA**.
- CHAMÆDRYS**, in botany. See **VERONICA**.
- CHAMÆLEA**, in botany. See **CENORUM**.
- CHAMÆLEON**, in zoology, the trivial name of a species of lacerta. See **LACERTA**.
- CHAMÆLINUM**, in botany. See **LINUM**.
- CHAMÆMILUM**, in botany. See **MATRICARIA**.
- CHAMÆNERION**, in botany. See **EPILŌBIUM**.
- CHAMÆPITYS**, in botany. See **TEUCRIUM**.
- CHAMÆRHODODENDROS**, in botany. See **AZALEA**.
- CHAMÆROPS**, or **HUMBLE PALM**, in botany, a genus ranged under the palmæ flabellifoliz of Linnæus. It is a native of Spain.

*Privy-CHAMBER.* Gentlemen of the privy-chamber, are servants of the king, who are to wait and attend on him and the queen at court, in their diversions, &c. Their number is forty-eight under the lord-chamberlain, twelve of whom are in quarterly waiting, and two of these lie in the privy-chamber.

In the absence of the lord-chamberlain, or vice-chamberlain, they execute the king's orders: at coronations, two of them personate the dukes of Aquitain and Normandy: and six of them, appointed by the lord-chamberlain, attend ambassadors from crowned heads to their audiences, and in public entries. The gentlemen of the privy-chamber were instituted by Henry VII.

**CHAMBER**, in policy, the place where certain assemblies are held, also the assemblies themselves. Of these, some are established for the administration of justice, others for commercial affairs.

Of the first kind are, 1. Star-chamber, so called, because the roof was painted with stars; the authority, power, and jurisdiction of which are absolutely abolished by the statute 17 Car. I. 2. Imperial chamber of Spire, the supreme court of judicatory in the empire, erected by Maximilian I. This chamber has a right of judging by appeal, and is the last resort of all civil affairs of the states and subjects of the empire, in the same manner as the aulic council of Vienna. Nevertheless it is restrained in several cases; it takes no notice of matrimonial causes, these being left to the pope; nor of criminal causes, which either belong to particular princes or towns in their respective territories, or are cognizable by all the states of the empire in a diet. By the treaty of Osnaburg, in 1648, fifty assessors were appointed for this chamber, whereof twenty-four were to be Protestants, and twenty-six Catholics; besides five presidents, two of them Protestants, and the rest Catholics. 3. Chamber of accounts, a sovereign court in France, where accounts are rendered of all the king's revenues, inventories, and avowels thereof registered; oaths of fidelity taken, and other things relating to the finances transacted. There are nine in France, that of Paris is the chief; it registers proclamations, treaties of peace, naturalizations, titles of nobility, &c. All the members wear long black gowns of velvet, of sattin, or damask, according to their places. 4. Ecclesiastical chambers in France, which judge by appeal of differences about collecting the tythes. 5. Chamber of audience, or grand chamber, a jurisdiction in each parliament of France, the counsellors of which are called *jugeurs*, or judges, as those of the chamber of inquests are called *rapporteurs*, reporters of processes by writing. 6. Chamber of the edict, or miparty, a court established by virtue of the edict of pacification, in favour of those of the reformed religion. This chamber is now suppressed. 7. Apostolical chamber of Rome, that wherein affairs relating to the revenues of the church and the pope are transacted. This council consists of the cardinal-camerlingo, the governor of the rota, a treasurer, an auditor, a president, one advocate-general, a solicitor-general, a commissary

ry, and twelve clerks. 8. Chamber of London, an apartment in Guildhall, where the city-money is deposited.

Of the last sort are, 1. The chambers of commerce. 2. The chambers of assurance. And, 3. The royal or syndical chamber of booksellers in France.

The chamber of commerce is an assembly of merchants and traders, where the affairs relating to trade are treated of. There are several established in most of the chief cities of France; and in our own country, we have lately seen chambers of this kind erected for carrying on the British herring-fishery. Chamber of assurance in France, denotes a society of merchants and others for carrying on the business of insuring; but in Holland, it signifies a court of justice, where causes relating to insurances are tried. Chamber of booksellers in Paris, an assembly consisting of a syndic and assistants, elected by four delegates from the printers, and twelve from the bookellers, to visit the books imported from abroad, and to search the houses of sellers of marbled paper, printfellers, and dealers in printed paper for hangings, who are prohibited from keeping any letters proper for printing books. In the visitation of books, which ought to be performed by three persons at least from among the syndic and assistants, all libels against the honour of God and the welfare of the state, and all books printed either with or without the kingdom in breach of their regulations and privileges, are stopt, even with the merchandises that may happen to be in the bales with such libels, or other prohibited books. The days appointed for this chamber to meet, are Tuesdays and Fridays, at two o'clock in the afternoon.

**CHAMBERLAIN**, an officer charged with the management and direction of a chamber. See **CHAMBER**, in policy.

There are almost as many kinds of chamberlains as chambers, the principal whereof are as follows.

*Lord CHAMBERLAIN of Great Britain*, the sixth great officer of the crown; to whom belongs livery and lodging in the king's court; and there are certain fees due to him from each archbishop or bishop, when they perform their homage to the king; and from all peers at their creation, or doing their homage. At the coronation of every king, he is to have forty ells of crimson velvet for his own robes. This officer, on the coronation-day, is to bring the king his shirt, coif, and wearing cloaths; and after the king is dressed, he claims his bed, and all the furniture of his chamber for his fees: he also carries at the coronation, the coif, gloves, and linen to be used by the king on that occasion; also the sword and scabbard, the gold to be offered by the king, and the robe-royal and crown: he dresses and undresses the king on that day, waits on him before and after dinner, &c.

To this officer belongs the care of providing all things in the house of lords, in the time of parliament; to him also belongs the government of the palace of Westminster: he disposes likewise of the sword of state, to be carried before the king, to what lord he pleases.

**Lord CHAMBERLAIN** of the household, an officer who has the oversight and direction of all officers belonging to the king's chambers, except the precinct of the king's bed-chamber.

He has the oversight of the officers of the wardrobe at all his majesty's houses, and of the removing wardrobes, or of beds, tents, revels, music, comedians, hunting, messengers, &c. retained in the king's service. He moreover has the oversight and direction of the serjeants at arms, of all physicians, apothecaries, surgeons, barbers, the king's chaplain, &c. and administers the oath to all officers above stairs.

Other chamberlains, are those of the king's court of exchequer, of North Wales, of Chester, of the city of London, &c. in which cases this officer is generally the receiver of all rents and revenues belonging to the place whereof he is chamberlain.

In the exchequer there are two chamberlains, who keep a controulment of the pells of receipts and exitus, and have certain keys of the treasury, records, &c.

**CHAMBERLAIN** of London keeps the city-money, which is laid up in the chamber of London: he also presides over the affairs of masters and apprentices, and makes free of the city, &c.

His office lasts only a year, but the custom usually obtains to re-chuse the same person, unless charged with any misdemeanor in his office.

**CHAMBERRY**, the capital of the duchy of Savoy, in Italy, situated ninety miles north-west of Turin, and forty five south of Geneva: E. long. 5° 45', N. lat. 45° 40'.

**CHAMOIS**, or **CHAMOIS-GOAT**, in zoology. See **CAPRA**.

**CHAMPAIGN**, a province of France, bounded by Picardy on the north, by Lorraine on the east, by Burgundy on the south, and by the isle of France on the west. Its capital is Troyes.

**CHAMPAIN**, or *point CHAMPAIN*, in heraldry, a mark of dishonour in the coat of arms of him who kills a prisoner of war after he has cried quarter.

**CHAMPION**, a person who undertakes a combat in the place or quarrel of another; and sometimes the word is used for him who fights in his own cause.

It appears that champions, in the just sense of the word, were persons who fought instead of those that, by custom, were obliged to accept the duel, but had a just excuse for dispensing with it, as being too old, infirm, or being ecclesiastics, and the like. Such causes as could not be decided by the course of common law, were often tried by single combat; and he who had the good fortune to conquer, was always reputed to have justice on his side. Champions who fought for interest only, were held infamous; these hired themselves to the nobility, to fight for them in case of need, and did homage for their pension.

**CHAMPION** of the king, a person whose office it is, at the coronation of our kings, to ride armed into Westminster-hall, while the king is at dinner there, and, by the proclamation of a herald, make challenge to this

effect, viz. "That if any man shall deny the king's title to the crown, he is there ready to defend it in single combat, &c." Which done, the king drinks to him, and sends him a gilt cup, with a cover, full of wine, which the champion drinks, and has the cup for his fee.

**CHANCE**, in a general sense, a term applied to events not necessarily produced as the natural effects of any proper foreknown cause. For the doctrine of chance and its application to games, &c. see **GAMING**.

**CHANCE-medley**, in law, is the accidental killing of a man, not altogether without the killer's fault, though without any evil intention; and is where one is doing a lawful act, and a person is killed thereby: For, if the act be unlawful, it is felony.

**CHANCEL**, a particular part of the fabric of a Christian church; or that part of the choir between the altar and the balustrade that incloses it, where the minister is placed at the celebration of the communion.

**CHANCELLOR**, an officer supposed originally to have been a notary or scribe under the emperors, and named *cancellarius*, because he sat behind a lattice, called in Latin *cancellus*, to avoid being crowded by the people.

According to a late treatise, the chancellor originally presided over a political college of secretaries, for the writing of treaties, and other public business; and the court of equity, under the old constitution, was held before the king and his council, in the palace, where one supreme court for business of every kind was kept. At first the chancellor became a judge, to hear and determine petitions to the king, which were preferred to him; and in the end, as business increased, the people addressed their suit to the chancellor, and not to the king; and thus the chancellor's equitable power, by degrees, commenced by prescription. *Lord high CHANCELLOR of Great Britain*, or *Lord keeper of the great seal*, is the highest honour of the long robe, being made so *per traditionem magni sigilli, per donivium regem*, and by taking the oaths: He is the first person of the realm next after the king, and princes of the blood, in all civil affairs; and is the chief administrator of justice, next the sovereign, being the judge of the court of chancery.

All other justices are tied to the strict rules of the law in their judgment: But the chancellor is invested with the king's absolute power, to moderate the written law, governing his judgment purely by the law of nature and conscience, and ordering all things according to equity and justice. In this respect Staundford says, the chancellor has two powers, one absolute, the other ordinary: Meaning, that although by his ordinary power, in some cases, he must observe the forms of proceedings, as other inferior judges; yet in his absolute power, he is not limited by the law, but by conscience and equity.

The lord chancellor not only keeps the king's great seal; but also all patents, commissions, warrants, &c. from the king, are, before they are signed, perused by him: He has the disposition of all ecclesiastical benefices



offices in the gift of the crown under 20l. a year, in the king's books; and he is speaker of the house of lords. See PARLIAMENT.

**CHANCELLOR of a cathedral**, an officer that hears sermons and lectures read in the church, either by himself or his vicar; to correct and set right the reader when he reads amiss; to inspect schools; to hear causes; apply the seal; write and dispatch the letters of the chapter; keep the books; take care that there be frequent preachings, both in the church and out of it; and assign the office of preaching to whom he pleases.

**CHANCELLOR of the dutchy of Lancaster**, an officer appointed chiefly to determine controversies between the king and his tenants of the dutchy-land, and otherwise to direct all the king's affairs belonging to that court. See DUTCHY-COURT.

**CHANCELLOR of the exchequer**, an officer who presides in that court, and takes care of the interest of the crown.

He is always in commission with the lord-treasurer, for the letting of crown-lands, &c. and has power, with others, to compound for forfeitures of lands, upon penal statutes: He has also great authority in managing the royal revenues, and in matters relating to the first-fruits.

**CHANCELLOR of the order of the garter, and other military orders**, is an officer who seals the commissions and mandates of the chapter and assembly of the knights, keeps the register of their proceedings, and delivers acts thereof under the seal of their order.

**CHANCELLOR of an university**, is he who seals the diplomas, or letters of degrees, provision, &c. given in the university.

The chancellor of Oxford is usually one of the prime nobility, chosen by the students themselves in convocation. He is their chief magistrate; his office is, *durante vita*, to govern the university, preserve and defend its rights and privileges, convoke assemblies, and do justice among the members under his jurisdiction.

Under the chancellor is the vice-chancellor, who is chosen annually, being nominated by the chancellor, and elected by the university in convocation: He is always the head of some college, and in holy orders. His proper office is to execute the chancellor's power, to govern the university according to her statutes, to see that officers and students do their duty, that courts be duly called, &c. When he enters upon his office, he chuses four pro-vice-chancellors out of the heads of the colleges, to execute his power in his absence.

The chancellor of Cambridge is also usually one of the prime nobility, and in most respects the same as that in Oxford; only he does not hold his office *durante vita*, but may be elected every three years. Under the chancellor there is a commissary, who holds a court of record for all privileged persons and scholars under the degree of master of arts, where all causes are tried and determined by the civil and statute law, and by the custom of the university.

The vice-chancellor of Cambridge is chosen annually, by the senate, out of two persons nominated by the heads of the several colleges and hall.

**CHANCEERY**, the grand court of equity and conscience, instituted to moderate the rigour of the other courts that are bound to the strict letter of the law.

The jurisdiction of this court is of two kinds, ordinary or legal, and extraordinary or absolute. The ordinary jurisdiction is that wherein the lord-chancellor, who is judge of this court, in his proceeding and judgment, is bound to observe the order and method of the common law; in such cases the proceedings, which were formerly in Latin, but now in English, are filed or enrolled in the petty-bag-office; and the extraordinary, or unlimited power, is that jurisdiction which the court exercises in cases of equity, wherein relief is to be had by bill and answer.

The ordinary court holds plea of recognizances acknowledged in the chancery, writs of *scire facias* for repeal of the king's letters-patent. &c. also of all personal actions by or against any officer of the court, and of several offences and causes by act of parliament; all original writs, commissions of bankrupts, of charitable uses, of idiots, lunacy, &c. are issued hence.

The extraordinary court gives relief for and against infants, notwithstanding their minority; for and against married women, notwithstanding their coverture. All frauds and deceits, for which there is no redress at common law; all breaches of trust, confidences and accidents, as to relieve obligors, mortgagors, &c. against penalties and forfeitures, where the intention was to pay the debt, are here remedied. But in all cases where the plaintiff can have his remedy at law, he ought not to be relieved in chancery; and a thing which may be tried by a jury, is not triable in this court.

The court of chancery will not retain a suit for any thing under ten pounds value, except in cases of charity, nor for lands. &c. under forty shillings *per ann.* In this court all patents, most sorts of commissions, deeds between parties touching lands and estates, treaties with foreign princes, &c. are sealed and enrolled. Out of it are issued writs to convene the parliament and convocation, proclamations and charters, &c. For the several officers belonging to the court of chancery, see the articles **MASTER of the rolls**, **MASTERS in chancery**, **CLERK**, &c.

**CHANDELIER**, in fortification, a kind of moveable parapet, consisting of a wooden frame, made of two upright stakes, about six feet high, with cross planks between them; serving to support fascines to cover the pioneers.

**CHANNEL**, in geography, an arm of the sea, or a narrow sea between two continents, or between a continent and an island. Such are the British channel, St George's channel, the channel of Constantinople, &c.

**CHANTILLY**, a village in France, about seven leagues from Paris, where there is a magnificent palace and fine forest belonging to the duke of Bourbon.

**CHANTOR** a singer in the choir of a cathedral. The word is almost grown obsolete, *chorister* or *singing-man* being commonly used instead of it. All great chapters

chapters have chantors and chaplains to assist the canons, and officiate in their absence.

**CHANTOR** is used by way of excellence for the præcentor or master of the choir, which is one of the first dignities of the chapter. At St David's in Wales, where there is no dean, he is next in dignity to the bishop. The ancients called the chantor *primicerius cantorum*. To him belonged the direction of the deacons and other inferior officers.

Chantors in the temple of Jerusalem, were a number of Levites employed in singing the praises of God, and playing upon instruments before his altar. They had no habits distinct from the rest of the people; yet in the ceremony of removing the ark to Solomon's temple, the chantors appeared dressed in tunics of byssus or fine linen. 2 Chron. v. 12.

**CHANTRY**, or **CHAUNTRY**, a church or chappel, endowed with lands, &c. for the maintenance of one or more priests to say mass for the souls of the donors. Hence,

**CHANTRY-rents**, are rents still paid to the crown by the purchasers of those lands.

**CHAOS**, that confusion in which matter lay when newly produced out of nothing at the beginning of the world, before God, by his almighty word, had put it into the order and condition wherein it was after the six days creation.

**CHAOS**, in zoology, a genus of insects belonging to the order of vermes zoophyta. The body has no shell or covering, and is capable of reviving after being dead to appearance for a long time: It has no joints or external organs of sensation. There are five species, mostly obtained by infusions of different vegetables in water, and only discoverable by the microscope.

**CHAPEAU**, in heraldry, an ancient cap of dignity worn by dukes, being scarlet-coloured velvet on the outside, and lined with a fur. It is frequently borne above an helmet instead of a wreath, under gentlemen's crests.

**CHAPEL**, or **CHAPPEL**, a place of divine worship, served by an incumbent under the denomination of a chaplain.

**CHAPEL** is also a name given to a printer's work-house; in which sense they say, the laws of the chapel, the secrets of the chapel.

*Knights of the CHAPEL*, called also poor knights of Windsor, were instituted by Henry VIII. in his testament. Their number was at first thirteen, but has been since augmented to twenty-six. They assist in the funeral services of the kings of England: They are subject to the office of the canons of Windsor, and live on pensions assigned them by the order of the garter. They bear a blue or red cloke, with the arms of St George on the left shoulder.

**CHAPELET**, in the menage, a couple of stirrup leathers, mounted each of them with a stirrup, and joined at top in a sort of leather buckle, called the head of the chapelet, by which they are made fast to the pommel of the saddle, after being adjusted to the rider's length and bore. They are used both to avoid

the trouble of taking up or letting down the stirrups, every time that the gentleman mounts on a different horse and saddle, and to supply the place of the academy saddles, which have no stirrups to them.

**CHAPITERS**, in architecture, the same with capitals. **CHAPITERS**, in law, formerly signified a summary of such matters as were inquired of, or presented before justices in eyre, justices of alize or of the peace, in their sessions.

Chapiters, at this time, denote such articles as are delivered by the mouth of the justice in his charge to the inquest.

**CHAPLAIN**, an ecclesiastic who officiates in a chapel. See **CHAPEL**.

The king of Great Britain hath forty-eight chaplains in ordinary, usually eminent doctors in divinity, who wait four each month, preach in the chapel, read the service to the family, and to the king in his private oratory, and say grace in the absence of the clerk of the closet. Besides, there are twenty-four chaplains at Whitehall, fellows of Oxford or Cambridge, who preach in their turns, and are allowed 30*l.* *per annum* each. According to a statute of Henry VIII. the persons vested with a power of retaining chaplains, together with the number each is allowed to qualify, is as follows: An archbishop, eight; a duke or bishop, six; marquess or earl, five; viscount, four; baron, knight of the garter, or lord-chancellor, three; a dutchess, marchioness, countess, baroness, the treasurer and comptroller of the king's house, clerk of the closet, the king's secretary, dean of the chapel, almoner, and master of the rolls, each of them two; chief justice of the king's bench, and warden of the cinque-ports, each one. All these chaplains may purchase a licence or dispensation, and take two benefices with cure of souls. A chaplain must be retained by letters testimonial under hand and seal; for it is not sufficient that he serve as chaplain in the family.

**CHAPLAIN of the order of Malta**, otherwise called diaco, and clerk conventual, the second class of the order of Malta. The knights make the first rank.

**CHAPLET**, a string of beads used by the Roman Catholics, to count the number of their prayers. The invention of it is ascribed to Peter the hermit, who probably learned it of the Turks, as they owe it to the East-Indians.

Chaplets are sometimes called pater-nosters, and are made of coral, of diamonds, of wood, &c. The common chaplet contains fifty ave-marias, and five pater-nosters. There is also a chaplet of our Saviour, consisting of thirty-three beads, in honour of his thirty-three years living on earth, instituted by father Michael the Camaldulian.

**CHAPPE'**, in heraldry, the dividing an escutcheon by lines drawn from the centre of the upper edge to the angles below, into three parts, the sections on the sides being of a different metal or colour from the rest.

**CHAPPEL in frith**, a market town of Derbyshire, about twenty-six miles north-west of Derby; W. long. 1° 50', N. lat. 53° 22'.

CHAPTER,

**CHAPTER**, in ecclesiastical polity, a society or community of clergymen belonging to the cathedrals and collegiate churches.

It was in the eighth century that the body of canons began to be called a chapter. The chapter of the canons of a cathedral were a standing council to the bishop, and, during the vacancy of the see, had the jurisdiction of the diocese. In the earlier ages, the bishop was head of the chapter; afterwards abbots and other dignitaries, as deans, provosts, treasurers, &c. were preferred to this distinction. The deans and chapters had the privilege of chusing the bishops in England; but Henry VIII. got this power vested in the crown: and as the same prince expelled the monks from the cathedrals, and placed secular canons in their room, those he thus regulated were called deans and chapters of the new foundation; such are Canterbury, Winchester, Ely, Carlisle, &c.

**CHAPTER**, in matters of literature, a division in a book for keeping the subject treated of more clear and distinct.

**CHARA**, in botany, a genus of the cryptogamia algæ class. The calix consists of two leaves; the antheræ are globular and sessile; there are three stigmata, and one round seed. The species are four, three of which are natives of Britain, viz. the tomentosa, or brittle chara; the vulgaris, or common chara; the hispida, or rough chara; and the flexilis, or smooth chara.

**CHARABON**, a sea-port town on the northern coast of the island of Java, in the Indian ocean, situated 130 miles east of Batavia; E. long. 108°, south lat. 6°.

**CHARACTER**, in a general sense, denotes any mark whatever, serving to represent either things or ideas: thus letters are characters, types, or marks of certain sounds; words, of ideas, &c.

Literal characters may be divided, with respect to the nations among whom they have been invented, into Greek characters, Roman characters, Hebrew characters, &c. The Latin character now used through all Europe was formed from the Greek, as the Greek was from the Phœnician; and the Phœnician, as well as the Chaldee, Syriac, and Arabic characters, were formed from the ancient Hebrew, which subsisted till the Babylonish captivity; for, after that event, the character of the Assyrians, which is the square Hebrew now in use, prevailed, the ancient being only found on some Hebrew medals, commonly called Samaritan medals. It was in 1091 that the Gothic characters, invented by Ulfilas, were abolished, and the Latin ones established in their room.

Medallists observe, that the Greek character, consisting only of majuscule letters, has preserved its uniformity on all medals, as low as the time of Gallienus; from that time it appears somewhat weaker and rounder: from the time of Constantine to Michael we find only Latin characters; and after Michael the Greek characters recommence; but from that time they begin to alter with the language, which was a mixture of Greek and Latin. The Latin medals preserve both their character and language as low as the translation of the seat of the empire to Constantinople: towards

the time of Decius the character began to lose its roundness and beauty; some time after, it retrieved, and subsisted tolerably till the time of Justin, when it degenerated gradually into the Gothic. The rounder, then, and better formed a character is upon a medal, the fairer pretence it has to antiquity.

**CHARACTER** is also used, in several of the arts, for a symbol, contrived for the more concise and immediate conveyance of the knowledge of things. For the

**CHARACTERS used in algebra**, see p. 79, 80.

**CHARACTERS used in astronomy**, viz.

Of the planets. See plate XXXIX.

Of the signs. See plate XXXIX.

Of the aspects.

- ♄ or S Conjunction    Δ Trine
- SS Semisextile        B<sub>4</sub> Biquintile
- \* Sextile                Vc Quincunx
- Q Quintile                ∘ Opposition
- Quartile                ☉ Dragon's head
- Td Tredecile            ☿ Dragon's tail

Of time.

A. M. *ante meridiem*, before the sun comes upon the meridian.

O. or N. noon.

P. M. *post meridiem*, when the sun is past the meridian.

**CHARACTERS in commerce**.

D° ditto, the same

N° numero, or number

F° folio, or page

C or ⊕ hundred weight, or 112 pounds

q<sup>r</sup> quarters

S or s shillings

d pence or deniers

lb pound weight.

F° recto } folio

V° vero } pounds sterling

£, per, or by, as £ ann. by the year, £ cent.

R<sup>x</sup> rixdollar

D<sup>r</sup> ducat

P. S. postscript, &c.

**CHARACTERS in chemistry**. See CHEMISTRY.

**CHARACTERS in geometry and trigonometry**.

|| the character of parallelism

Δ triangle

□ square

◻ rectangle

○ circle

∠ equiangular, or similar

⊥ equilateral

∠ an angle

L right angle

⊥ perpendicular

° denotes a degree; thus 45° implies 45 degrees. ' a minute; thus, 50', is 50 minutes. ", ""', """, denote seconds, thirds, and fourths: and the same characters are used where the progressions are by tens, as it is here by sixties.

**CHARACTERS in grammar, rhetoric, poetry, &c.**

() parenthesis

[ ] crotchet

- hyphen

' apostrophe

' emphasis or accent

~ breve

.. dialysis

^ caret and circumflex

†

Q

SS. T. D. doctor in divinity

V. D. M. minister of the word of God

LL. D. doctor of laws

J. V. D. doctor of civil and canon law

" quotation

“ quotation M. D. doctor in phy-  
 † † and \* references sic  
 § section or division A. M. master of arts  
 ¶ paragraph A. B. bachelor of arts  
 F. R. S. fellow of the royal society.

For the other characters used in grammar, see COM-  
 MA, COLON, SEMICOLON, &c.

CHARACTERS among the ancient lawyers, and in an-  
 cient inscriptions.

§ paragraphs P. P. pater patriæ  
 ¶ digests C. code  
 Scto senatus con- C. C. consules  
 sulto T. titulus  
 E. extra P. P. D. D. propria  
 S. P. Q. R. sena- pecunia dedicavit  
 tus populusque D. D. M. dono dedit  
 Romanus monumentum

CHARACTERS in medicine and pharmacy.

℞ recipe M. manipulus, a  
 á, úá, or ana, of each handful  
 alike P. a pugil  
 lb a pound or a pint P. Æ. equal quan-  
 ʒ an ounce tities  
 ʒ a drachm S. A. according to  
 ʒ a scruple art  
 gr. grains q. s. a sufficient  
 ʒ or ʒr, half of any quantity  
 thing q. pl. as much as  
 cong. congius, a gallon you please  
 coch. cochleare, a P. P. pulvis patrum,  
 spoonful the Jesuit's bark.

CHARACTERS used in music. See MUSIC.

Numeral CHARACTERS used to express numbers, are either letters or figures. The Arabic character, called also the common one, because it is used almost throughout Europe in all sorts of calculations, consists of these ten digits, 1, 2, 3, 4, 5, 6, 7, 8, 9, 0.

The Roman numeral character consists of seven majuscule letters of the Roman alphabet, viz. I, V, X, L, C, D, M. The I denotes one, V five, X ten, L fifty, C a hundred, D five hundred, and M a thousand.

The I repeated twice makes two, II; thrice, three, III; four is expressed thus IV, as I before V or X takes an unit from the number expressed by these letters. To express six, an I is added to a V, VI; for seven, two, VII; and for eight, three, VIII; nine is expressed by an I before X, thus IX.

The same remark may be made of the X before L or C, except that the diminution is by tens; thus, XL denotes forty, XC ninety, and LX sixty. The C before D or M diminishes each by a hundred.

The number five hundred is sometimes expressed by an I before a C inverted, thus, IC; and instead of M, which signifies a thousand, an I is sometimes used between two C's, the one direct, and the other inverted, thus CIC. The addition of C and O before or after, raises CIO by tens, thus, CCICIO expresses ten thousand, CCCICIOO, a hundred thousand.

The Romans also expressed any number of thousands by a line drawn over any numeral less than a thousand; thus, V̄ denotes five thousand, LX̄ sixty

thousand: so likewise M̄ is one million, MM̄ is two millions, &c.

Some modern writers have admitted variations in this method of notation; thus we find IIX expressing eight, IICIX eighty-nine, Δ or V denoting ICIO, and ∞ or ∞ standing for CIO; whence † ten thousand, ΨΨ twenty thousand.

The Greeks had three ways of expressing numbers: first, every letter, according to its place in the alphabet, denoted a number, from α, one, to ω, twenty-four. 2. The alphabet was divided into eight units, α one, β two, γ three, &c. into eight tens; ι ten, κ twenty, λ thirty, &c. and eight hundreds, ς one hundred, σ two hundred, τ three hundred, &c. 3. I stood for one, Π five, Δ ten, H a hundred, X a thousand, M ten thousand; and when the letter Π inclosed any of these, except I, it shewed the inclosed letter to be five times its value; as ΠΔ fifty, ΠΔ five hundred, ΠM five thousand, ΠX fifty thousand.

French CHARACTERS, used in the chamber of accounts, and by persons concerned in the management of the revenue, is, properly speaking, nothing else than the Roman numerals, in letters that are not majuscule: thus, instead of expressing fifty-six by LVI, they denote it by smaller characters lvj.

CHARACTERS upon tomb-stones.

S. V. Siste viator, i. e. Stop traveller.

M. S. Memoriz sacrum, i. e. Sacred to the memory.

D. M. Diis manibus.

I H S. Jesus.

X. P. a character found in the catacombs, about the meaning of which authors are not agreed.

CHARACTER, in epic and dramatic poetry, that which is peculiar in the manners of any person, and distinguishes him from all others. See EPIC, and dramatic compositions.

CHARADRIUS, in ornithology, a genus belonging to the order of grallæ. The beak is cylindrical and blunt; the nostrils are linear, and the feet have three toes. There are 12 species, viz. 1. The hiaticula, or sea-lark of Ray, has a black breast, a white streak along the front; the top of the head is brown; and the legs and beak are reddish. It is found on the shores of Europe and America. 2. The alexandrinus, or oriental dotterell, is of a brownish colour, with the fore-head, collar, and belly white; the prime tail-feathers on both sides are white; and the legs are black. It is a native of Egypt, and is much valued for its singing. It is about the size of a crow, and lives upon mice, rats, &c. 3. The vociferus, or noisy plover of Catesby, has black streaks on the breast, neck, fore-head, and cheeks; and the feet are yellow. It is a native of North America. 4. The ægyptius, has a black streak on the breast, white eye-brows, the prime tail-feathers streaked with black at the points, and bluish legs. It is found in the plains of Egypt, and feeds on insects. 5. The morinellus has an iron-coloured breast, a small white streak on the breast and eye-brows, and black legs. It is the dotterell of Ray, and a native of Europe. 6. The apricarius has a black belly; the body is brown,

brown, and variegated with white and yellow spots; and the legs are ash-coloured. It is the spotted plover of Edwards, and a native of Canada. 7. The pluvialis, is black above, with green spots, white underneath, and the feet are ash-coloured. It is the green plover of Ray, and is a native of Europe. 8. The torquatus, has a black breast and a white front; the top of the head and the collar is black; and the beak and feet are bluish. It is a native of St Domingo. 9. The calidris, has black feet and a black bill; the rump is greyish; and the body is pure white below. It frequents the shores of Europe. 10. The œdicnemus, or stone curlew of Ray, is of a grey colour, with two of the prime wing-feathers black, but white in the middle; it has a sharp bill, and ash-coloured feet. It is a native of Britain. 11. The lunantopus, is white below, with a black back, and a long black bill; the feet are red and very long. It is the autumnal dotterell of English authors, and frequents the sea-shores of Europe. 12. Spinofus, armed dotterell, or lap wing, has a black breast, legs, and wings; it has a crest on the hinder part of the head. It is of the size of a pidgeon; the French call it dominicanus, from the resemblance it has to the dress of a dominican monk: It is a native of Egypt.

**CHARANTIA**, in botany See **MOMORDICA**.

**CHARAX**, in ichthyology. See **SALMO**.

**CHARBON**, in the menage, that little black spot or mark which remains after a large spot in the cavity of the corner teeth of a horse: about the seventh or eighth year, when the cavity fills up, the tooth being smooth and equal, it is said to be rased.

**CHARCAS**, the southern division of Peru, in South America, remarkable for the silver-mines of Potosi.

**CHARCOAL**, a kind of fuel, consisting of half burnt wood, much used by artificers of different professions; and that not only as fuel, but for polishing brass or copper plates, &c.

The best charcoal for common uses is that made of oak; but in the manufacture of gunpowder they commonly use charcoal made of alder.

**CHARENTE**, a river of France, which arising in the Limosin, runs westward by Angoulesme and Saintes, falling into the bay of Biscay, opposite to the isle of Oleron.

**CHARENTON**, the name of two towns in France, the one upon the Marmaude, in the Bourbonnois; the other in the isle of France, near the confluence of the Marne with the Seine, about three miles south-east of Paris: E. long. 2° 30', and N. lat. 48° 45'.

**CHARGE**, in heraldry, is applied to the figures represented on the escutcheon, by which the bearers are distinguished from one another; and it is to be observed, that too many charges are not so honourable as fewer.

**CHARGE of lead** denotes a quantity of thirty-six pigs. See **PIG**.

**CHARGE to enter heir**, in Scots law, a writing passing under the signet, obtained at the instance of a creditor, either against the heir of his debtor, for fixing upon

him the debt as representing the debtor, which is called a general charge: Or, against the debtor himself, or his heir, for the purpose of vesting him in the right of any heritable subject to which he has made up no title, in order the creditor may attach that subject for payment of his debt, in the same manner as if his debtor or his heir were legally vested in it by service or otherwise. This last kind is called a special charge. See **SCOTS LAW**, title, *Apprisings and adjudications*.

**CHARGED**, in heraldry, a shield carrying some impress or figure, is said to be charged therewith; so also when one bearing, or charge, has another figure added upon it, it is properly said to be charged.

**CHARIOT**, a half coach, having only a seat behind, with a stool, at most, before. See **COACH**.

The chariots of the ancients, chiefly used in war, were called by the several names *bigæ*, *trigæ*, &c. according to the number of horses applied to draw them. Every chariot carried two men, who were probably the warrior and the charioteer; and we read of several men of note and valour employed in driving the chariot. When the warriors came to encounter in close fight, they alighted out of the chariot, and fought on foot; but when they were weary, which often happened, by reason of their armour, they retired into their chariot, and thence annoyed their enemies with darts and missile weapons. These chariots were made so strong, that they lasted for several generations.

Besides this sort, we find frequent mention of the *currus falcati*, or those chariots armed with hooks, or scythes, with which whole ranks of soldiers were cut off together, if they had not the art of avoiding the danger; these were not only used by the Persians, Syrians, Egyptians, &c. but we find them among our British ancestors.

**Triumphal CHARIOT** was one of the principal ornaments of the Roman celebration of a victory.

The Roman triumphal chariot was generally made of ivory, round like a tower, or rather of a cylindrical figure; it was sometimes gilt at the top, and ornamented with crowns; and, to represent a victory more naturally, they used to stain it with blood. It was usually drawn by four white horses, but oftentimes by lions, elephants, tygers, bears, leopards, dogs, &c.

**CHARISTIA**, a festival of the ancient Romans, celebrated in the month of February, wherein the relations by blood and marriage met, in order to preserve a good correspondence; and that, if there happened to be any difference among them, it might be the more easily accommodated, by the good humour and mirth of the entertainment.

**CHARITY**, among divines, one of the three grand theological virtues, consisting in the love of God and of our neighbour, or the habit and disposition of loving God with all our heart, and our neighbour as ourselves.

**CHARITY of St Hippolitus**, a religious congregation founded, about the end of the XIVth century, by one Bernardin Alvarez, a Mexican, in honour of St Hippolitus

- Hippolitus the martyr, patron of the city of Mexico; and approved by pope Gregory XIII.
- CHARLEMONT**, a town of the province of Namur, in the Austrian Netherlands, about eighteen miles south of Namur: E. long.  $4^{\circ} 40'$ , and N. lat.  $50^{\circ} 10'$ .
- CHARLEMONT** is also the name of a town of Ireland, situated on the river Blackwater, in the county of Armagh, and province of Ulster, about six miles south-east of Dungannon: W. long.  $6^{\circ} 50'$ , and N. lat.  $50^{\circ} 16'$ .
- CHARLEROY**, a strong town in the province of Namur, in the Austrian Netherlands, situated on the river Sambre, about nineteen miles west of Namur: E. long.  $4^{\circ} 20'$ , and N. lat.  $50^{\circ} 30'$ .
- CHARLES'S CAPE**, a promontory of Virginia, in North America, forming the northern head-land of the strait that enters the bay of Chesapeake.
- CHARLES'S-FORT**, a fortress in the county of Cork, and province of Munster in Ireland, situated at the mouth of Kinfales harbour: W. long.  $8^{\circ} 20'$ , and N. lat.  $51^{\circ} 21'$ .
- CHARLES'S-TOWN**, the capital of South Carolina, in North America, situated on a peninsula formed by Ashley and Cooper rivers, the former of which is navigable for ships twenty miles above the town: W. long.  $70^{\circ}$ , and N. lat.  $32^{\circ} 30'$ .
- CHARLES'S WAIN**, in astronomy, seven stars in the constellation called *ursa major*, or the great bear.
- CHARLETON**, an island at the bottom of Hudson's-bay, in North America, subject to Great Britain: W. long.  $80^{\circ}$ , and N. lat.  $52^{\circ} 30'$ .
- CHARLOCK**, the English name of the raphanus. See **RAPHANUS**.
- CHARM**, a term derived from the Latin *carmen*, a verse; and used to denote a magic power, or spell, by which, with the assistance of the devil, forcerers and witches were supposed to do wonderful things, far surpassing the power of nature.
- CHARNEL**, or **CHARNEL-HOUSE**, a kind of portico, or gallery, usually in or near a church-yard, over which were anciently laid the bones of the dead, after the flesh was wholly consumed.
- Charnel-houses are now usually adjoining to the church.
- CHARNUB**, in botany. See **CERATONIA**.
- CHART**, or **SEA-CHART**, an hydrographical map, or a projection of some parts of the earth's superficies *in plano*, for the use of navigators. See **NAVIGATION**.
- CHARTA-magna**. See **MAGNA charta**.
- CHARTER**, in law, a written instrument or evidence of things acted between one person and another.
- Charters of private persons, are deeds and instruments for the conveyance of lands, &c. Here the purchaser of land shall have all the charters and deeds, as incident to the same, and for the maintenance of his title. But this is understood where the feoffee is not bound to a general-warranty of the land.
- CHARTER**, in Scots law, that writing which contains the grant of a feudal subject to the vassal. See **SCOTS LAW**, tit. *Of the constitution of heritable rights*.
- CHARTOPHYLAX**, the name of an officer of the church of Constantinople, who attends at the door of the rails when the sacrament is administered, and gives notice to the priests to come to the holy table. He represents the patriarch upon the bench, tries all ecclesiastical causes, keeps all the marriage registers, assists at the consecration of bishops, and presents the bishop elect at the solemnity, and likewise all other subordinate clergy. This office resembles in some shape that of the bibliothecarius at Rome.
- CHARTRES**, a large city of France, in the province of Orleans, situated on the river Eure, about forty-two miles south-west of Paris: E. long.  $1^{\circ} 32'$ , N. lat.  $48^{\circ} 27'$ . It is a bishop's see.
- CHARTREUSE**, or **CHARTREUSE-GRAND**, a celebrated monastery, the capital of all the convents of the Carthusian monks, situated on a steep rock in the middle of a large forest of fir-trees, about seven miles north-east of Grenoble, in the province of Dauphine in France: E. long.  $5^{\circ} 5'$ , N. lat.  $45^{\circ} 20'$ . See **CARTHUSIANS**.
- From this mother-convent, all the others of the same order take their name; among which was the Chartreuse of London, corruptly called the charter-house, now converted into an hospital, endowed with a revenue of 600*l.* *per ann.*
- Here are maintained eighty decayed gentlemen, not under fifty years of age: Also forty boys are educated and fitted either for the university or trades. Those sent to the university, have an exhibition of 20*l.* a year for eight years; and have an immediate title to nine church-livings in the gift of the governors of the hospital, who are sixteen in number, all persons of the first distinction, and take their turns in the nomination of pensioners and scholars.
- CHARYBDIS**, a rock in the strait of Messina, between Italy and Sicily, much celebrated in the writings of ancient poets.
- CHARYBDIS** is also an appellation given by Dr Plot to certain openings in the bottom of the sea, whereby the water is conveyed to the origin or sources of springs, rivers, &c. such is Maelstrom, on the coast of Norway, supposed to be. See **MAELSTROM**.
- CHASING** of gold, silver, &c. See **ENCHASING**.
- CHASTE-tree**. See **VITEX**.
- CHATELET**, the name of certain courts of justice established in several cities in France. The grand chatelet at Paris, is the place where the presidial or ordinary court of justice of the provost of Paris is kept; consisting of a presidial, a civil chamber, a criminal chamber, and a chamber of policy. The little chatelet is an old fort, now serving as a prison.
- CHATHAM**, a port-town of Kent, adjoining to Rochester, situated on the river Medway, thirty miles south-east of London: E. long.  $40'$ , N. lat.  $51^{\circ} 20'$ .
- It is the principal station of the royal navy, furnished with timber, rope-yards, and all manner of naval stores, sufficient for the building and fitting out the largest fleet.
- CHATTEAU-CAMPRESIS**, a town of the Cambresis, in the French Netherlands, situated on the river Selle,

- Selle, thirteen miles south-east of Cambrai, E. long.  $3^{\circ} 25'$ , N. lat.  $50^{\circ} 6'$ .
- CHATTEAU DAUPHINE, a fortress situated on the frontiers of Piedmont, in the province of Dauphine, but yielded to the king of Sardinia: E. long.  $6^{\circ} 40'$ , N. lat.  $41^{\circ} 30'$ .
- CHATELLETS, in law, all sorts of goods moveable and immoveable, except such as are in the nature of freehold.
- CHATTIGAN, a port-town of India, in the province of Bengal, situated at the mouth of the most easterly branch of the Ganges, subject to the Mogul: E. long.  $91^{\circ}$ , N. lat.  $23^{\circ}$ .
- CHATTILLON, a town of Burgundy in France, about sixteen miles south-west of Geneva: E. long.  $5^{\circ} 40'$ , N. lat.  $46^{\circ} 16'$ .
- CHATTILLON is likewise the name of several other towns of France, situated upon the Indre, the Loing, the Loire, the Marne, the Saone, &c.
- CHAUMONT, the name of two towns in France; the one situated in the isle of France, thirty miles north-west of Paris, E. long.  $2^{\circ}$ , N. lat.  $49^{\circ} 18'$ ; the other situated on the river Marne, in the province of Champaign, E. long.  $5^{\circ} 15'$ , N. lat.  $48^{\circ} 12'$ .
- CHAUSE-TRAPE See CALTROP.
- CHEADLE, a market-town of Staffordshire, ten miles north-east of Stafford: W. long.  $2^{\circ}$ , N. lat.  $53^{\circ}$ .
- CHEASPEAK-BAY, a large frith or arm of the sea, which runs up about three hundred miles into the country between Virginia and Maryland, in North America: It is navigable almost all the way for large ships; being about twenty miles broad at the entrance between Charles-cape and Cape-Henry, and between twenty and thirty miles broad afterwards. See CHARLES-CAPE.
- CHECAYA, in Turkish affairs, the second officer of the janizaries, who commands them under the aga, and is otherwise called *protogero*.
- There is also a checaya of the treasury, stables, kitchen, &c. the word signifying as much as lieutenant, or the second in any office.
- CHECK, or CHECK-ROLL, a roll or book, wherein is contained the names of such persons as are attendants and in pay to the king, or other great personages, as their household servants.
- Clerk of the CHECK*, in the king's household, has the check and controulment of the yeomen of the guard, and all the ushers belonging to the royal family, allowing their absence or defects in attendance, or diminishing their wages for the same, &c. He also, by himself or deputy, takes the view of those that are to watch in the court, and has the setting of the watch, &c.
- Clerk of the CHECK*, in the king's navy at Plymouth, is also the name of an officer invested with the like power.
- CHECK, in falconry, a term used of a hawk when she forsakes her proper game, to lie at pyes, crows, rooks, or the like, that crosses her in her flight.
- CHECKY, in heraldry, is when the shield, or a part thereof, as a bordure, &c. is chequered, or divided into chequers or squares, in the manner of a chess-board.

This is one of the most noble and most ancient figures used in armory; and a certain author saith, that it ought to be given to none but great warriors, in token of their bravery: For the chess-board represents a field of battle; and the pawns of men, placed on both sides, represent the soldiers of the two armies, which move, attack, advance, or retire, according to the will of the gamblers, who are the generals.

This figure is always composed of metal and colour: But some authors would have it reckoned among the several sorts of furs.

CHEEK, in anatomy, that part of the face situated below the eyes, on each side. See p. 305.

CHEESE, a sort of food, prepared of curdled milk, purged from the serum or whey, and afterwards dried for use.

Physicians condemn the too free use of cheese, by reason it loads the stomach when new, and heats and inflames when old.

Every country has its places noted for this commodity: Thus Chester and Gloucester-cheese are famous in England; and the Parmesan cheese is in no less repute abroad, especially in France. This sort of cheese is entirely made of sweet cow's milk: But at Rochfort in Languedoc, they make cheese of ewe's milk; and in other places, it is usual to add goat or ewe's milk, in a certain proportion, to that of cow's.

There is likewise a kind of medicated cheese, made by intimately mixing the expressed juice of certain herbs, as sage, baum, mint, &c. with the curd, before it is fashioned into a cheese. The 100 weight of cheese pays on importation, 1 s.  $3\frac{1}{8}$  d. and draws back, on exportation, 1 s.  $1\frac{1}{2}$  d. at the rate of 6 s. 8 d. The cheese of Ireland is prohibited to be imported.

CHEESE-RUNNET, in botany. See GALLIUM.

CHEGFORD, a market-town of Devonshire, about thirteen miles west of Exeter: W. long.  $4^{\circ}$ , N. lat.  $50^{\circ} 40'$ .

CHEIRANTHUS, in botany, a genus of the tetradynamia siliquosa class. The germen has teeth-like glands on each side; the calix is close, and consists of two small leaves, gibbous at the base; and the seeds are plain. There are thirteen species, only two of which are natives of Britain, viz. the cheiri, wall-flower, or wild cheir; and the tricuspidatus, or sea stock-gillyflower. The leaves of the wall-flower are said to be cordial, anodyne, aperient, and emmenagogue; but are wholly neglected in practice.

CHEKAO, a kind of palle prepared by calcination and trituration from a hard stony substance, and afterwards washing the powder in large quantities of fair water.

The Chinese use the chekao in drawing the elegant figures we see in the wholly white china-ware, which they afterwards varnish in the common way. See CHINA-WARE.

CHEKAIM, a province of China, bounded by that of Nankin on the north, and by the ocean on the east.

CHELÆCANCORUM, in the materia medica. See CRAB'S CLAWS.

CHELIDONIUM, in botany, a genus of the polyandria monogynia class. The corolla has four petals;

the calix consists of two leaves; and the pod is linear and unilocular. There are four species, three of which are natives of Britain, *viz.* the majas, or celandine; the glaucium, or yellow horned poppy; and the hybridum, or violet-coloured horned poppy. The leaves and root of the majas, or celandine, are stimulant, aperient, diuretic, and sudorific: It is peculiarly recommended in the slow kind of jaundice, where there are no symptoms of inflammation, and in dropsies.

**CHELIDONIUS lapis**, in natural-history, a stone said by the ancients to be found in the stomachs of young swallows, and greatly cried up for its virtues in the falling-sickness; but from their description, it appears to be only a species of lycodontes, or bufonitzæ. See **LYCODONTES**, and **BUFONITÆ**.

**CHELM**, a town of Poland, capital of a palatinate of the same name: It is situated in the province of Red Russia, 110 miles south-east of Warsaw: E. long.  $23^{\circ} 30'$ , N. lat.  $51^{\circ} 25'$ .

**CHELMSFORD**, the county town of Essex, situated on the river Chelmer, twenty five miles north-east of London: E. long.  $30'$ , N. lat.  $51^{\circ} 40'$ . It sends two members to parliament.

**CHELONE**, in botany, a genus of the didynamia an-

giosperma class. The calix is divided into five parts; there are the rudiments of a fifth filament betwixt the two higher stamina; and the capsule is bilocular. There are three species, none of them natives of Britain.

**CHELSEA**, a fine village situated on the northern bank of the river Thames, a mile westward of Westminster, remarkable for a magnificent hospital of invalids and old decrepit soldiers; and a pleasure-house, called Ranelagh, to which a great deal of fine company resort in summer.

**CHELTENHAM**, or **CHILTHENHAM**, a market-town of Gloucestershire, seven miles north-east of Gloucester: W. long.  $2^{\circ} 10'$ , N. lat.  $51^{\circ} 50'$ . It is chiefly remarkable for its mineral waters, of the same kind with those of Scarborough. See **SCARBOROUGH**.

**CHEMISE**, in fortification, the wall with which a bastion, or any other bulwark of earth, is lined for its greater support and strength: Or it is the solidity of the wall from the talus to the stone-row.

**Fire-CHEMISE**, a piece of linen cloth, steeped in a composition of oil of petrol, camphor, and other combustible matters, used at sea, to set fire to an enemy's vessel.

## C H E M I S T R Y.

**T**HE object and chief end of chemistry is to separate the different substances that enter into the composition of bodies; to examine each of them apart; to discover their properties and relations; to decompose those very substances, if possible; to compare them together, and combine them with others; to reunite them again into one body, so as to reproduce the original compound with all its properties; or even to produce new compounds that never existed among the works of nature, from mixtures of other matters differently combined.

But this analysis, or decomposition, of bodies is finite; for we are unable to carry it beyond a certain limit. In whatever way we attempt to go further, we are always stopped by substances in which we can produce no change,

and which are incapable of being resolved into others.

To these substances we may give the title of *principles* or *elements*. Of this kind the principal are earth, water, air, and fire. For though there be reason to think, that these are not the first component parts, or the most simple elements, of matter; yet, as we know by experience, that our senses cannot possibly discover the principles of which they are themselves composed, it seems more reasonable to fix upon them, and consider them as simple homogeneous bodies, and the principles of the rest, than to tire our minds with vain conjectures about the parts or elements of which they may consist.

Before entering upon the examination of compound substances, it is necessary to consider the most simple ones, or the four first principles, with some attention.

### PART I. THEORY OF CHEMISTRY.

#### *Of the Principles of Bodies.*

##### *Of AIR.*

**AIR** is that fluid which we constantly breathe, and which encompasses the whole surface of the terrestrial globe. Being heavy, like other bodies, it penetrates in-

to all places that are not either absolutely inaccessible, or filled with some other body heavier than itself. Its principal property is, to be susceptible of condensation and rarefaction; so that the very same quantity of air may occupy a much greater, or a much smaller space, according to the different state it is in. Heat and cold are the most usual causes of its condensation and rarefaction: For if a certain quantity of air be heated, its bulk enlarges



larges in proportion to the degree of heat applied to it; the consequence whereof is, that the same space now contains fewer particles of air than it did before. Cold again produces just the contrary effect.

On this property which air has of being condensed and dilated by heat, its elasticity chiefly depends. For if air were forced by condensation into a less compass than it took up before, and then exposed to a very considerable degree of cold, it would remain quite inactive, without exerting such an effort as it usually makes against the depressing body. On the other hand, the elasticity of heated air arises only from hence, that being rarefied by the action of fire, it requires much more room than it occupied before.

Air enters into the composition of many substances, especially vegetable and animal bodies: For by analysing most of them such a considerable quantity thereof is extricated, that some naturalists have suspected it to be altogether destitute of elasticity when thus combined with the other principles in the composition of bodies. According to them, the efficacy of the elastic power of the air is so prodigious, and its force when compressed so excessive, that it is not possible the other component parts of bodies should be able to confine so much of it in that state of compression which it must needs undergo, if retaining its elasticity when pent up among them.

However that be, this elastic property of the air produces the most singular and important phenomena observable in the resolution and composition of bodies.

#### Of WATER.

WATER is a thing so well known, that it is almost needless to attempt giving a general idea of it here. Every one knows that it is a transparent, insipid substance, and usually fluid. We say it is usually so; for being exposed to a certain degree of cold, it becomes solid: Solidity therefore seems to be its most natural state.

Water exposed to the fire grows hot; but only to a limited degree, beyond which its heat never rises, be the force of fire applied to it ever so violent: It is known to have acquired this degree of heat by its boiling up with great tumult. Water cannot be made hotter, because it is volatile, and incapable of enduring the heat without being evaporated and entirely dissipated.

If such a violent and sudden heat be applied to water as will not allow it time to exhale gently in vapours, as when, for instance, a small quantity thereof is thrown upon a metal in fusion, it is dissipated at once with vast impetuosity, producing a most terrible and dangerous explosion. This surprising effect may be deduced from the instantaneous dilatation of the parts of the water itself, or rather of the air contained in it. Moreover, water enters into the texture of many bodies, both compound and secondary principles; but, like air, it seems to be excluded from the composition of all metals, and most minerals. For although an immense quantity of water exists in the bowels of the earth, moistening all its contents, it does not therefore follow, that it is one of the principles of minerals. It is only interposed between their parts; for they may be entirely robbed of it, with-

out any sort of decomposition: Indeed it is not capable of an intimate connection with them.

#### Of EARTH.

WE observed, that the two principles above treated of are volatile; that is, the action of fire separates them from the bodies they help to compose. But earth is fixed, and, when absolutely pure, resists the utmost force of fire. So that, whatever remains of a body, after it hath been exposed to the power of the fiercest fire, must be considered as containing nearly all its earthy principle, and consisting chiefly thereof.

Earth therefore is a fixed principle which is permanent in the fire. There is reason to think it very difficult, if not impossible, to obtain the terrene principle wholly free from every other substance: For after our utmost endeavours to purify them, the earths we obtain from different compounds are found to have different properties, according to the different bodies from which they are procured; or else, if those earths be pure, we must allow them to be essentially different, seeing they have different properties.

Earth, in general, with regard to its properties, may be distributed into *fusible* and *unfusible*; that is, into earth that is capable of melting or becoming fluid in the fire, and earth that constantly remains in a solid form, never melting in the strongest degree of heat to which we can expose it.

The former is also called *vitriifiable*, and the latter *unvitriifiable* earth; because, when earth is melted by the force of fire, it becomes what we call *glass*, which is nothing but the parts of earth brought into nearer contact, and more closely united by the means of fusion. Perhaps the earth, which we look upon as incapable of vitrification, might be fused if we could apply to it a sufficient degree of heat. It is at least certain, that some earths, or stones, which separately resist the force of fire, so that they cannot be melted, become fusible when mixed together. Experience convinced Mr du Hamel, that lime-stone and slate are of this kind. It is however undoubtedly true, that one earth differs from another in its degree of fusibility: And this gives ground to believe, that there may be a species of earth absolutely unvitriifiable in its nature, which, being mixed in different proportions with fusible earths, renders them difficult to melt.

Whatever may be in this, as there are earths which we are absolutely unable to vitrify, that is a sufficient reason of our division of them. Unvitriifiable earths seem to be porous, for they imbibe water; whence they have also got the name of *absorbent earths*.

#### Of FIRE.

THE matter of the sun, or of light, the phlogiston, fire, the sulphureous principle, the inflammable matter, are all of them names by which the element of fire is usually denoted. But it should seem, that an accurate distinction hath not yet been made between the different states in which it exists; that is, between the phenomena

of fire actually existing as a principle in the composition of bodies, and those which it exhibits when existing separately and in its natural state: nor have proper distinct appellations been designed to it in those different circumstances. In the latter state we may properly give it the names of fire, matter of the sun, of light, and of heat; and may consider it as a substance composed of infinitely small particles, continually agitated by a most rapid motion, and of consequence essentially fluid.

This substance, of which the sun may be called the general reservoir, seems to flow incessantly from that source, diffusing itself over the world, and through all the bodies we know; but not as a principle, or essential part of them, since they may be deprived thereof, at least in a great measure, without suffering any decomposition. The greatest change produced on them, by its presence or its absence, is the rendering them fluid or solid: so that all other bodies may be deemed naturally solid; fire alone essentially fluid, and the principle of fluidity in others. This being presupposed, air itself might become solid, if it could be entirely deprived of the fire it contains; as bodies of most difficult fusion become fluid, when penetrated by a sufficient quantity of the particles of fire.

One of the chief properties of this pure fire is to penetrate easily into all bodies, and to diffuse itself among them with a sort of uniformity and equality: for if a heated body be contiguous to a cold one, the former communicates to the latter all its excess of heat, cooling in exact proportion as the other warms, till both come to have the very same degree of heat. Heat, however, is naturally communicable soonest to the upper parts of a body; and consequently, when a body cools, the under parts become soonest cold. It hath been observed, for instance, that the lower extremity of a heated body, freely suspended in the air, grows cold sooner than the upper; and that when a bar of iron is red-hot at one end, and cold at the other, the cold end is much sooner heated by placing the bar so that the hot end may be undermost, than when that end is turned uppermost. The levity of the matter of fire, and the vicinity of the earth, may possibly be the causes of this phenomenon.

Another property of fire is to dilate all bodies into which it penetrates. This hath already been shewn with regard to air and water; and it produces the same effect on earth.

Fire is the most powerful agent we can employ to decompose bodies; and the greatest degree of heat producible by man, is that excited by the rays of the sun collected in the focus of a large burning-glass.

#### *Of the PHLOGISTON.*

FROM what hath been said concerning the nature of fire, it is evidently impossible for us to fix and confine it in any body. Yet the phenomena attending the combustion of inflammable bodies shew that they really contain the matter of fire as a constituent principle. By what mechanism then is this fluid, so subtle, so active, so difficult to confine, so capable of penetrating into every other substance in nature, so fixed as to make a com-

ponent part of the most solid bodies? It is no easy matter to give a satisfactory answer to this question. But, without pretending to guess the cause of the phenomenon, let us rest contented with the certainty of the fact, the knowledge of which will undoubtedly procure us considerable advantages. Let us therefore examine the properties of fire thus fixed and become a principle of bodies. To this substance, in order to distinguish it from pure and unfix'd fire, the chemists have assigned the peculiar title of the *Phlogiston*, which is indeed no other than a Greek word for the inflammable matter; by which latter name, as well as by that of the sulphureous principle, it is also sometimes called. It differs from elementary fire in the following particulars. 1. When united to a body, it communicates to it neither heat nor light. 2. It produces no change in its state, whether of solidity or fluidity; so that a solid body does not become fluid by the accession of the phlogiston, and *vice versa*; the solid bodies to which it is joined being only rendered thereby more apt to be fused by the force of the culinary fire. 3. We can convey it from the body with which it is joined into another body, so that it shall enter into the composition thereof, and remain fixed in it.

On this occasion both these bodies, that which is deprived of the phlogiston and that which receives it, undergo very considerable alterations; and it is this last circumstance in particular that obliges us to distinguish the phlogiston from pure fire, and to consider it as the element of fire combined with some other substance, which serves it as a basis for constituting a kind of secondary principle. For if there were no difference between them, we should be able to introduce and fix pure fire itself where-ever we can introduce and fix the phlogiston: yet this is what we can by no means do, as will appear from experiments to be afterwards produced.

Hitherto chemists have never been able to obtain the phlogiston quite pure, and free from every other substance: for there are but two ways of separating it from a body of which it makes a part; to wit, either by applying some other body with which it may unite the moment it quits the former; or else by calcining and burning the compound from which you desire to sever it. In the former case, it is evident that we do not get the phlogiston by itself, because it only passes from one combination into another; and in the latter, it is entirely dissipated in the decomposition, so that no part of it can possibly be secured.

The inflammability of a body is an infallible sign that it contains a phlogiston; but from a body's not being inflammable, it cannot be inferred that it contains none; for experiments have demonstrated, that certain metals abound with it, which yet are by no means inflammable.

We have now delivered what is most necessary to be known concerning the principles of bodies in general. They have many other properties besides those above-mentioned; but we cannot properly take notice of them here, because they presuppose an acquaintance with some other things relating to bodies, of which we have hitherto said nothing, intending to treat of them in the sequel as occasion shall offer. We shall only observe in this place, that

that when animal and vegetable matters are burnt in such a manner as to hinder them from flaming, some part of the phlogiston contained in them unites intimately with their most fixed earthy parts, and with them forms a compound that can be consumed only by making it red-hot in the open air, where it sparkles and wastes away, without emitting any flame. This compound is called a *coal*. We shall inquire into the properties of this coal under the head of oils: at present it suffices that we know in general what it is, and that it readily communicates to other bodies the phlogiston it contains.

*A general View of the Affinities or elective Attractions that subsist between Bodies.*

BEFORE we can reduce compound bodies to the first principles above pointed out, we obtain, by analysing them, certain substances which are indeed more simple than the bodies they helped to compose, yet are themselves composed of our primary principles. They are therefore at one and the same time both principles and compounds; for which reason we shall call them by the name of secondary principles. Saline and oily matters chiefly constitute this class. But before we enter upon an examination of their properties, it is fit we lay before the reader a general view of what chemists understand by the relations or affinities of bodies; because it is necessary to know these, in order to a distinct conception of the different combinations we are to treat of.

All the experiments hitherto made concur in proving, that different bodies, whether principles or compounds, have such a mutual conformity, relation, affinity, or attraction, as disposes some of them to join and unite together, while they are incapable of contracting any union with others. This effect, whatever be its cause, will enable us to account for, and connect together, all the phenomena that chemistry produces. The nature of this universal affection of matter is laid down in the following propositions.

First, If one substance has any affinity or conformity with another, the two will unite together, and form one compound.

Secondly, All similar substances have an affinity with each other, and are consequently disposed to unite; as water with water, earth with earth, &c.

Thirdly, Substances that unite together lose some of their separate properties; and the compounds resulting from their union partake of the properties of those substances which serve as their principles.

Fourthly, The simpler any substances are, the more perceptible and considerable are their affinities: whence it follows, that the less bodies are compounded, the more difficult it is to analyse them; that is, to separate from each other the principles of which they consist.

Fifthly, If a body consist of two substances, and to this compound be presented a third substance that has no affinity at all with one of the two primary substances aforesaid, but has a greater affinity with the other than those two substances have with each other, there will ensue a decomposition, and a new union; that is, the third substance will separate the two compounding substances

from each other, coalesce with that which has an affinity with it, form therewith a new combination, and disengage the other, which will then be left at liberty, and such as it was before it had contracted any union.

Sixthly, It happens sometimes that when a third substance is presented to a body consisting of two substances, no decomposition follows; but the two compounding substances, without quitting each other, unite with the substance presented to them, and form a combination of three principles: and this happens when that third substance has an equal, or nearly equal, affinity with each of the compounding substances. The same thing may also happen even when the third substance hath no affinity but with one of the compounding substances only. To produce such an effect, it is sufficient that one of the two compounding substances have to the third body a relation equal, or nearly equal, to that which it has to the other compounding substance with which it is already combined. Hence it follows, that two substances, which, when apart from all others, are incapable of contracting any union, may be rendered capable of incorporating together in some measure, and becoming parts of the same compound, by combining with a third substance with which each of them has an equal affinity.

Seventhly, A body, which of itself cannot decompose a compound consisting of two substances, because they have a greater affinity with each other than it has with either of them, becomes nevertheless capable of separating the two by uniting with one of them, when it is itself combined with another body having a degree of affinity with that one sufficient to compensate its own want thereof. In that case there are two affinities, and thence ensues a double decomposition, and a double combination.

These fundamental truths, from which we shall deduce an explanation of all the phenomena in chemistry, will be confirmed and illustrated by applying them to the several cases, of which our design in this treatise obliges us to give a circumstantial account.

*Of Saline Substances in general.*

IF a particle of water be intimately united with a particle of earth, the result will be a new compound, which, according to our third proposition of affinities, will partake of the properties of earth and of water; and this combination principally forms what is called a *saline substance*. Consequently every saline substance must have an affinity with earth and with water, and be capable of uniting with both or either of them, whether they be separate or mixed together: and accordingly this property characterises all salts or saline substances in general.

Water being volatile, and earth fixed, salts in general are less volatile than the former, and less fixed than the latter; that is, fire, which cannot volatilize and carry off pure earth, is capable of rarefying and volatilizing a saline substance; but then this requires a greater degree of heat than is necessary for producing the same effects on pure water.

There are several sorts of salts, differing from one another in respect either of the quantity or the quality of the

earth in their composition; or, lastly, they differ on account of some additional principles, which not being combined with them in sufficient quantity to hinder their saline properties from appearing, permit them to retain the name of salts, though they render them very different from the simplest saline substances.

It is easy to infer from what has been said of salts in general, that some of them must be more, some less, fixed or volatile than others, and some more, some less, disposed to unite with water, with earth, or with particular sorts of earth, according to the nature or the proportion of their principles.

Before we proceed further, it is proper just to mention the principal reasons which induce us to think that every saline substance is actually a combination of earth and water, as we supposed at our entering on this subject. The first is, the conformity salts have with earth and water, or the properties they possess in common with both. Of these properties we shall treat fully, as occasion offers to consider them, in examining the several sorts of salts. The second is, that all salts may be actually resolved into earth and water by sundry processes; particularly by repeated dissolution in water, evaporation, desiccation, and calcination. Indeed the chemists have not yet been able to produce a saline substance by combining earth and water together. This favours a suspicion, that besides these two there is some other principle in the composition of salts which escapes our researches, because we cannot preserve it when we decompose them: but it is sufficient to our purpose, that water and earth are demonstrably amongst the real principles of saline substances, and that no experiment hath ever shewn us any other.

#### Of Acids.

The simplest saline substance is that called an *acid*, on account of its taste, which is like that of verjuice, sorrel, vinegar, and other four things, which for the same reason are also called acids. By this peculiar taste are acids chiefly known. They have moreover the property of turning all the blue and violet colours of vegetables red, which distinguishes them from all other salts.

The form under which acids most commonly appear, is that of a transparent liquor; though solidity is rather their natural state. This is owing to their affinity with water; which is so great, that, when they contain but just as much of it as is necessary to constitute them salts, and consequently have a solid form, they rapidly unite therewith the moment they come into contact with it: and as the air is always loaded with moisture and aqueous vapours, its contact alone is sufficient to liquify them; because they unite with its humidity, imbibe it greedily, and by that means become fluid. We therefore say, they attract the moisture of the air. This change of a salt from a solid to a fluid state, by the sole contact of the air, is also called *deliquium*; so that when a salt changes in this manner from a solid into a fluid form, it is said to run *per deliquium*. Acids being the simplest species of saline bodies, their affinities with different substances are stronger than those of any other sort of salt with the same substances; which is agreeable to our fourth proposition concerning affinities.

Acids in general have a great affinity with earths: that with which they most readily unite is the unvitriifiable earth to which we gave the name of absorbent earth. They seem not to act at all upon vitriifiable earths, such as sand; nor yet upon some other kinds of earths, at least while they are in their natural state. Yet the nature of these earths may be in some measure changed, by making them red hot in the fire, and then quenching them suddenly in cold water: for by repeating this often they are brought nearer to the nature of absorbent earths, and rendered capable of uniting with acids.

When an acid liquor is mixed with an absorbent earth, for instance with chalk, these two substances instantly rush into union with so much impetuosity, that a great ebullition is immediately produced, attended with considerable hissing, heat, and vapours, which rise the very instant of their conjunction.

From the combination of an acid with an absorbent earth there arises a new compound, which some chemists have called *sal falsum*; because the acid by uniting with the earth loses its sour taste, and acquires another not unlike that of the common sea-salt used in our kitchens; yet varying according to the different sorts of acids and earths combined together. The acid at the same time loses its property of turning blue or violet vegetables red.

If we inquire what is become of its propensity to unite with water, we shall find that the earth, which of itself is not soluble in water, hath by its union with the acid acquired a facility of dissolving therein; so that our *sal falsum* is soluble in water. But, on the other hand, the acid hath, by its union with the earth, lost part of the affinity it had with water; so that if a *sal falsum* be dried, and freed of all superfluous humidity, it will remain in that dry solid form, instead of attracting the moisture of the air and running *per deliquium*, as the acid would do if it were pure and unmixed with earth.

Acids have likewise a great affinity with the phlogiston. When we come to treat of each acid in particular, we shall examine the combinations of each with the phlogiston: they differ so widely from one another, and many of them are so little known, that we cannot at present give any general idea of them.

#### Of Alkalis.

ALKALIS are saline combinations in which there is a greater proportion of earth than in acids. The principal arguments that may be adduced to prove this fact are these: First, if they be treated in the manner proposed above for analysing saline substances, we obtain from them a much greater quantity of earth than we do from acids. Secondly; by combining certain acids with certain earths we can produce alkalis; or at least such saline compounds as greatly resemble them. Our third and last argument is drawn from the properties of those alkalis which, when pure and unadulterated with any other principle, have less affinity with water than acids have, and are also more fixed, resisting the utmost force of fire. On this account it is that they have obtained the title of *fixed*, as well as to distinguish them from another species of alkali, to be considered hereafter, which is impure and volatile.

Though

Though fixed alkalis, when dry, sustain the utmost violence of fire without flying off in vapours, it is remarkable that, being boiled with water in an open vessel, considerable quantities of them rise with the steam; an effect which must be attributed to the great affinity between these two substances, by means whereof water communicates some part of its volatility to the fixed salt.

Alkalis freed of their superfluous humidity by calcination attract the moisture of the air, but not so strongly as acids: so that it is easier to procure and preserve them in a solid form.

They flow in the fire, and are then capable of uniting with vitrifiable earths, and of forming therewith true glass; which, however, will partake of their properties, if they be used in sufficient quantity.

As they melt more readily than vitrifiable earth, they facilitate its fusion; so that a weaker fire will reduce it to glass, when a fixed alkali is joined with it, than will melt it without that addition.

Alkalis are known by their taste, which is acrid and fiery; and by the properties they possess of turning blue or violet vegetables green; particularly syrup of violets.

Their affinity with acids is greater than that of absorbent earths; hence, if an alkali be presented to a combination of an acid with an absorbent earth, the earth will be separated from the acid by the alkali, and a new union between the acid and the alkali will take place. This is both an instance and a proof of our sixth proposition concerning affinities.

If a pure alkali be presented to a pure acid, they rush together with violence, and produce the same phenomena as were observed in the union of an absorbent earth with an acid, but in a greater and more remarkable degree.

Fixed alkalis may in general be divided into two sorts: one of these hath all the above recited properties; but the other possesses some that are peculiar to itself. We shall consider this latter sort more particularly under the head of sea-salt.

#### OF NEUTRAL SALTS.

THE acid and the alkali thus uniting, mutually rob each other of their characteristic properties; so that the compound resulting from their union produces no change in the blue colours of vegetables, and has a taste which is neither sour nor acrid, but saltish. A saline combination of this kind is for that reason named *sal falfum*, *sal medium*, or a *neutral salt*.

It must be observed, that in order to make these salts perfectly neutral, it is necessary that neither of the two saline principles of which they are compounded be predominant over the other; for in that case they will have the properties of the prevailing principle. The reason is this: neither of these saline substances can unite with the other but in a limited proportion beyond which there can be no further coalition between them. The action by which this perfect union is accomplished is termed *saturation*; and the instant when such proportions of the two saline substances are mixed together, that the one is incorporated with as much of the other as it can possibly take up, is called the *point of saturation*.

The point of saturation is known to be obtained, when, after repeated affusions of an acid in small quantities to an alkali, or an absorbent earth, we find those phenomena cease, which in such cases constantly attend the conflict of union, namely, ebullition, hissing, &c. and we may be assured the saturation is complete when the new compound hath neither an acid nor an acrid taste, nor in the least changes the blue colours of vegetables.

Neutral salts have not so great an affinity with water as either acids or alkalis have, because they are more compounded; for we observed before, that the affinities of the most compounded bodies are generally weaker than those of the most simple. In consequence hercof few natural salts, when dried, attract the moisture of the air; and those that do, attract it more slowly and in less quantity than either acids or alkalis do.

All neutral salts are soluble in water; but more or less readily, and in a greater or smaller quantity, according to the nature of their component principles.

Water made boiling hot dissolves a greater quantity of those salts which do not attract the moisture of the air, than when it is cold; and indeed it must be boiling hot to take up as much of them as it is capable of dissolving: but as for those which run in the air, the difference is imperceptible.

Some neutral salts have the property of shooting into crystals, and others have it not.

The nature of crystallization is this: Water cannot dissolve, nor keep in solution, more than a determinate quantity of any particular salt; when therefore such a quantity of water is evaporated from the solution of a salt capable of crystallization, that the remainder contains just as much salt as it can dissolve, then by continuing the evaporation the salt gradually recovers its solid form, and concretes into several little transparent masses called crystals. These crystals have regular figures, all differing from one another according to the species of salt of which they are formed. Different methods of evaporating saline solutions have different effects on the figure and regularity of the crystals; and each particular sort of salt requires a peculiar method of evaporation to make its crystals perfectly regular.

A solution of salt designed for crystallization is usually evaporated by means of fire to a pellicle: that is, till the salt begin to concrete; which is perceived by a kind of thin dark skin that gathers on the surface of the liquor, and is formed of the crystallized particles of salt. When this pellicle appears, the solution is suffered to cool, and the crystals form therein faster or slower according to the sort of salt in hand. If the evaporation be carried on briskly to perfect dryness, no crystals will be formed, and only an irregular mass of salt will be obtained.

The reasons why no crystals appear when the evaporation is hastily performed, and carried on to dryness, are, first, that the particles of salt, being always in motion while the solution is hot, have not time to exert their mutual affinities, and to unite together as crystallization requires: secondly, that a certain quantity of water enters into the very composition of crystals; which is therefore absolutely necessary to their formation, and in a greater

greater or smaller proportion according to the nature of the salt.

If these crystallized salts be exposed to the fire, they first part with that moisture which is not necessary to a saline concretion, and which they retained only by means of their crystallization: afterwards they begin to flow, but with different degrees of fusibility.

It must be observed, that certain salts melt as soon as they are exposed to the fire; namely, those which retain a great deal of water in crystallizing. But this fluor which they so readily acquire must be carefully distinguished from actual fusion; for it is owing only to their superfluous humidity, which heat renders capable of dissolving and liquifying them; so that when it is evaporated, the salt ceases to be fluid, and requires a much greater degree of fire to bring it into real fusion.

The neutral salts that do not crystallize may indeed be dried by evaporating the water which keeps them fluid; but by becoming solid they acquire no regular form; they again attract the moisture of the air, and are thereby melted into a liquor. These may be called *liquefcent salts*.

Most of the neutral salts, that consist of an acid joined with a fixed alkali, or with an absorbent earth, are themselves fixed and resist the force of fire; yet several of them, if they be dissolved in water, and the solution boiled and evaporated, lie off along with the steams.

#### *Of the several Sorts of Saline Substances.*

##### I. *Of the UNIVERSAL, or VITRIOLIC ACID.*

THE universal acid is so called, because it is in fact the acid which is most universally diffused through all nature, in waters, in the atmosphere, and in the bowels of the earth. But it is seldom pure; being almost always combined with some other substance. That from which we obtain it, with most ease, and in the greatest quantity, is vitriol; and this is the reason why it is called the *vitriolic acid*; the name by which it is best known.

When the vitriolic acid contains but little phlegm, yet enough to give it a fluid form, it is called *oil of vitriol*; on account of a certain unctuousity belonging to it.

If the vitriolic acid contain much water, it is then called *spirit of vitriol*. When it does not contain enough to render it fluid, and so is in a solid form, it is named the *icy oil of vitriol*.

When oil of vitriol, highly concentrated, is mixed with water, they rush into union with such an impetuosity, that, the moment they touch each other, there arises a hissing noise, like that of red-hot iron plunged in cold water, together with a very considerable degree of heat proportioned to the degree in which the acid was concentrated.

If instead of mixing this concentrated acid with water, you only leave it exposed to the air for some time, it attracts the moisture thereof, and imbibes it most greedily. Both its bulk and its weight are increased by this accession; and if it be under an icy form, that is, if it be concentered, the phlegm thus acquired will soon resolve it into fluid.

The addition of water renders the vitriolic acid, and indeed all other acids, weaker in one sense; which is, that when they are very aqueous, they leave on the tongue a much fainter taste of acidity, and are less active in the solution of some particular bodies: But that occasions no change in the strength of their affinities, but in some cases rather enables them to dissolve several substances which, when well dephlegmated, they are not capable of attacking.

The vitriolic acid combined to the point of saturation with a particular absorbent earth, well known, forms a neutral salt that crystallizes. This salt is called *alum*, and the figure of its crystals is that of an octahedron or solid of eight sides. These octahedra are triangular pyramids, the angles of which are so cut off that four of the surfaces are hexagons, and the other four triangles.

There are several sorts of alum, which differ according to the earths combined with the vitriolic acid. Alum dissolves easily in water, and in crystallization retains a considerable quantity of it; which is the reason that being exposed to the fire it readily melts, swelling and puffing up as its superfluous moisture exhales. When that is quite evaporated, the remainder is called *burnt alum*, and is very difficult to fuse. The acid of the alum is partly dissipated by this calcination. Its taste is saltish, with a degree of roughness and astringency.

The vitriolic acid combined with certain earths forms a kind of neutral salt called *selenites*, which crystallizes in different forms according to the nature of its earth. There are numberless springs of water infected with dissolved selenites; but when this salt is once crystallized, it is exceeding difficult to dissolve it in water a second time. For that purpose a very great quantity of water is necessary, and moreover it must boil; for, as it cools, most of the dissolved selenites takes a solid form, and falls in a powder to the bottom of the vessel.

If an alkali be presented to the selenites, or to alum, these salts will be thereby decomposed; that is, the acid will quit the earths, and join the alkali, with which it hath a greater affinity. And from this conjunction of the vitriolic acid with a fixed alkali there results another sort of neutral salt, which is called *arcannum duplicatum*, *sal de duobus*, and *vitriolated tartar*, because one of the fixed alcalis most in use is called *salt of tartar*.

Vitriolated tartar is almost as hard to dissolve in water as the selenites. It shoots into eight-sided crystals, having the apices of the pyramids pretty obtuse. Its taste is saltish, inclining to bitter; and it decrepitates on burning coals. It requires a very great degree of fire to make it flow.

The vitriolic acid is capable of uniting with the phlogiston, or rather it has a greater affinity with it than with any other body: whence it follows, that all compounds of which it makes a part may be decomposed by means of the phlogiston.

From the conjunction of the vitriolic acid with the phlogiston arises a compound called *mineral sulphur*, because it is found perfectly formed in the bowels of the earth. It is also called *sulphur vivum*, or simply *sulphur*.

Sulphur

Sulphur is absolutely insoluble in water, and incapable of contracting any sort of union with it. It melts with a very moderate degree of heat, and sublimes in fine light downy tufts called *flowers of sulphur*. By being thus sublimed it suffers no decomposition, let the operation be repeated ever so often; so that sublimed sulphur, or flower of sulphur, hath exactly the same properties as sulphur that has never been sublimed.

If sulphur be exposed to a brisk heat in the open air, it takes fire, burns, and is wholly consumed. This deflagration of sulphur is the only means we have of decomposing it, in order to obtain its acid in purity. The phlogiston is destroyed by the flame, and the acid exhales in vapours; these vapours collected have all the properties of the vitriolic acid, and differ from it only as they still retain some portion of the phlogiston; which, however, soon quits them of its own accord, if the free access of the common air be not precluded.

The portion of phlogiston retained by the acid of sulphur is much more considerable when that mineral is burnt gradually and slowly: in that case the vapours which rise from it have such a penetrating odour, that they instantaneously suffocate any person who draws in a certain quantity of them with his breath. These vapours constitute what is called the *volatile spirit of sulphur*. There is reason to think this portion of phlogiston which the acid retains is combined therewith in a manner different from that in which these two are united in the sulphur itself; for nothing but actual burning is capable of separating the vitriolic acid and the phlogiston, which by their union form sulphur; whereas in the volatile spirit of sulphur they separate spontaneously when exposed to the open air; that is, the phlogiston flies off and leaves the acid, which then becomes in every respect similar to the vitriolic acid.

That the volatile spirit of sulphur is a compound, appears evidently from hence, that whenever the vitriolic acid touches any substance containing the phlogiston, provided that phlogiston be disengaged or opened to a certain degree, a volatile spirit of sulphur is infallibly and immediately generated. This spirit hath all the properties of acids, but considerably weakened, and of course less perceptible. It unites with absorbent earths or fixed alkalis; and with them forms neutral salts: but when combined therewith it may be separated from them by the vitriolic acid, and indeed by any of the mineral acids, because its affinities are weaker. Sulphur hath the property of uniting with absorbent earths, but not near so intimately as with fixed alkalis.

If equal parts of sulphur and an alkali be melted together, they incorporate with each other; and from their conjunction proceeds a compound of a most unpleasant smell, much like that of rotten eggs, and of a red colour nearly resembling that of an animal liver, which has occasioned it to bear the name of *hepar sulphuris*, or *liver of sulphur*.

In this composition the fixed alkali communicates to the sulphur the property of dissolving in water: and hence it comes that liver of sulphur may be made as well when the alkali is dissolved by water into a fluid, as when it is fused by the action of fire.

Sulphur has less affinity than any acid with the fixed alkalis: and therefore liver of sulphur may be decomposed by any acid whatever; which will unite with the fixed alkali, form therewith a neutral salt, and separate the sulphur.

If liver of sulphur be dissolved in water, and an acid poured thereon, the liquor, which was transparent before, instantly turns to an opaque white; because the sulphur, being forced to quit its union with the alkali, loses at the same time the property of dissolving in water, and appears again in its own opaque form. The liquor thus made white by the sulphur is called *milk of sulphur*.

If this liquor be suffered to stand still for some time, the particles of sulphur, now most minutely divided, gradually approach each other, unite, and fall insensibly to the bottom of the vessel; and then the liquor recovers its transparency. The sulphur thus deposited on the bottom of the vessel is called the *magistery* or *precipitate sulphur*. The names of magistery and precipitate are also given to all substances whatever that are separated from another by this method; which is the reason that we use the expression of precipitating one substance by another, to signify the separating one of them by means of the other.

### 3. Of the NITROUS ACID.

The nitrous acid combined with certain absorbent earths, such as chalk, marle, boles, forms neutral salts which do not crystallize; and which, after being dried, run in the air *per deliquium*.

All those neutral salts which consist of the nitrous acid joined to an earth, may be decomposed by a fixed alkali, with which the acid unites, and deserts the earth; and from this union of the nitrous acid with a fixed alkali results a new neutral salt, which is called *nitre*, or *salt-petre*. This latter name signifies the *salt of stone*; and in fact, nitre is extracted from the stones and plaster, in which it forms, by boiling them in water saturated with a fixed alkali.

Nitre shoots in long crystals adhering sideways to each other; it has a saltish taste, which produces a sensation of cold on the tongue.

This salt easily dissolves in water; which, when it boils, takes up still a greater quantity thereof.

It flows with a pretty moderate degree of heat, and continues fixed therein: but being urged by a brisk fire, and in the open air, it lets go some part of its acid, and indeed flies off itself in part.

The most remarkable property of nitre, and that which characterizes it, is its fulmination or explosion; the nature of which is as follows:

When nitre touches any substance containing a phlogiston, and actually ignited, that is, red hot, it bursts out into a flame, burns, and is decomposed with much noise.

In this deflagration the acid is dissipated, and totally separated from the alkali, which now remains by itself.

Indeed the acid, at least the greatest part of it, is by this means quite destroyed. The alkali which is left when nitre is decomposed by deflagration, is called in

general *fixed nitre*, and, more particularly, nitre fixed by such and such a substance as was used in the operation. But if nitre be deflagrated with an inflammable substance containing the vitriolic acid, as sulphur, for instance, the fixed salt produced by the deflagration is not a pure alkali but retains a good deal of the vitriolic acid, and, by combining therewith, hath now formed a neutral salt.

The reason why nitre flames, and is decomposed in the manner above mentioned, when it comes in contact with a phlogiston properly circumstanced, is, that the nitrous acid, having a greater affinity with the phlogiston than with the fixed alkali, naturally quits the latter to join with the former, and so produces a kind of sulphur, differing probably from the common sulphur, formed by the vitriolic acid, in that it is combustible to such a degree, as to take fire and be consumed in the very moment of its production; so that it is impossible to prevent its being thus destroyed, and consequently impossible to save it. In support of this opinion let it be considered, that the concurrence of the phlogiston is absolutely necessary to produce this deflagration, and that the matter of pure fire is altogether incapable of effecting it: for though nitre be exposed to the most violent degree of fire, even that in the focus of the most powerful burning-glass, it will not flame; nor will that effect ever happen till the nitre be brought into contact with a phlogiston properly so called, that is, the matter of fire existing as a principle of some body; and it is moreover necessary that this phlogiston be actually on fire, and agitated with the igneous motion, or else, that the nitre itself be red-hot, and so penetrated with fire as to kindle any inflammable matter that touches it.

This experiment, among others, helps to shew the distinction that ought to be made between pure elementary fire, and fire become a principle of bodies to which we have given the name of phlogiston.

Before we leave this subject, we shall observe, that nitre deflagrates only with such substances as contain the phlogiston in its simplest and purest form; such as charcoal, sulphur, and the metalline substances; and that, though it will not deflagrate without the addition of some combustible matter, it is nevertheless the only known body that will burn, and make other combustibles burn with it, in close vessels, without the admission of fresh air.

The nitrous acid hath not so great an affinity with earths and alkalis as the vitriolic acid hath; whence it follows, that the vitriolic acid decomposes all neutral salts arising from a combination of the nitrous acid with an earth or an alkali. The vitriolic acid expels the nitrous acid, unites with the substance which served it for a basis, and therewith forms a neutral salt, which is an alum, a selenites, or a vitriolated tartar, according to the nature of that basis.

The nitrous acid, when thus separated from its basis by the vitriolic acid, is named *spirit of nitre*, or *aqua fortis*. If it be dephlegmated, or contain but little superfluous water, it exhales in reddish vapours; these vapours being condensed and collected, form a liquor of a brownish yellow, that incessantly emits vapours of the same colour, and of a pungent disagreeable smell. These

characters have procured it the names of *smoking spirit of nitre*, and *yellow aqua fortis*. This property in the nitrous acid of exhaling in vapours, shews it to be less fixed than the vitriolic acid; for the latter, though ever so thoroughly dephlegmated, never yields any vapours, nor has it any smell.

### 3. Of the ACID of SEA-SALT.

THE acid of sea-salt is so called, because it is in fact obtained from such sea-salt as is used in our kitchens. It is not certainly known in what this acid differs from the vitriolic and the nitrous, with regard to its constituent parts.

When it is combined with absorbent earths, such as lime and chalk, it forms a neutral salt that does not crystallize; and, when dried, attracts the moisture of the air. If the absorbent earth be not fully saturated with the marine acid, the salt thereby formed has the properties of a fixed alkali: And this is what made us say, when we were on the subject of those salts, that they might be imitated by combining an earth with an acid. The marine acid, like the rest, hath not so great an affinity with earths as with fixed alkalis.

When it is combined with the latter, it forms a neutral salt which shoots into cubical crystals. This salt is inclined to grow moist in the air, and is consequently one of those which water dissolves in equal quantities, at least as to sense, whether it be boiling hot or quite cold. The affinity of this acid with alkalis and absorbent earths is not so great as that of the vitriolic and nitrous acids: Whence it follows, that, when combined therewith, it may be separated from them by either of those acids.

The acid of sea-salt, thus disengaged from the substance which served it for a basis, is called *spirit of salt*. When it contains but little phlegm, it is of a lemon colour, and continually emits many white, very dense, and very elastic vapours; on which account it is named the *smoking or volatile spirit of salt*. Its smell is not disagreeable, nor much unlike that of 'affron; but extremely quick and suffocating when it smokes.

The acid of sea-salt, like the other two, seems to have a greater affinity with the phlogiston, than with fixed alkalis. We are led to this opinion by a very curious operation, which gives ground to think, that sea-salt may be decomposed by the proper application of a substance containing the phlogiston.

From the marine acid, combined with a phlogiston, results a kind of sulphur, differing from the common sort in many respects; but particularly in this property, that it takes fire of itself upon being exposed to the open air. This combination is called *English phosphorus*, *phosphorus of urine*, because it is generally prepared from urine, or only *phosphorus*.

This combination of the marine acid with a phlogiston is not easily effected; because it requires a difficult operation in appropriated vessels. For these reasons it does not always succeed; and phosphorus is so scarce and dear, that hitherto chemists have not been able to make on it the experiments necessary to discover all its properties. If phosphorus be suffered to burn away in the air,



a small quantity of an acid liquor may be obtained from it, which seems to be spirit of salt, but either altered, or combined with some adventitious matter; for it has several properties that are not to be found in the pure marine acid; such as, leaving a fixed fusible substance behind it when exposed to a strong fire, and being easily combined with the phlogiston so as to reproduce a phosphorus.

Phosphorus resembles sulphur in several of its properties: It is soluble in oils; it melts with a gentle heat; it is very combustible; it burns without producing soot; and its flame is vivid and bluish.

From what has been said of the union of the acid of sea-salt with a fixed alkali, and of the neutral salt resulting therefrom, it may be concluded, that this neutral salt is no other than the common kitchen-salt. But it must be observed, that the fixed alkali, which is the natural basis of the common salt obtained from sea-water, is of a sort somewhat differing from fixed alkalis in general, and hath certain properties peculiar to itself. For,

1. The basis of sea-salt differs from other fixed alkalis in this, that it crystallizes like a neutral salt.

2. It does not grow moist in the air: On the contrary, when exposed to the air, it loses part of the water that united with it in crystallization, by which means its crystals lose their transparency, become as it were mealy, and fall into a fine flour.

3. When combined with the vitriolic acid to the point of saturation, it forms a neutral salt differing from vitriolated tartar, first, in the figure of its crystals which are oblong six-sided solids: secondly, in its quantity of water, which in crystallization unites therewith in a much greater proportion than with vitriolated tartar: whence it follows, that this salt dissolves in water more readily than vitriolated tartar; thirdly, in that it flows with a very moderate degree of heat, whereas vitriolated tartar requires a very fierce one.

If the acid of sea-salt be separated from its basis by means of the vitriolic acid, it is easy to see, that, when the operation is finished, the salt we have been speaking of must be the result. A famous chemist, named Glauber, was the first who extracted the spirit of salt in this manner, examined the neutral salt resulting from his process, and finding it to have some singular properties, called it his *sal mirabile*, or wonderful salt: On this account it is still called Glauber's *sal mirabile*, or *Glauber's salt*.

4. When the basis of the sea-salt is combined with the nitrous acid to the point of saturation, there results a neutral salt, or a sort of nitre, differing from the common nitre, first, in that it attracts the moisture of the air pretty strongly; and this makes it difficult to crystallize: secondly, in the figure of its crystals, which are parallelepipeds; and this has procured it the name of *quadrangular nitre*.

Common salt, or the neutral salt formed by combining the marine acid with this particular sort of fixed alkali, has a taste well known to every body. The figure of its crystals is exactly cubical. It grows moist in the air, and, when exposed to the fire, it bursts, before it melts, into

many little fragments, with a crackling noise; which is called the *decrepitation* of sea-salt.

That neutral salt mentioned above, which is formed by combining the marine acid with a common fixed alkali, and called *sal sebrifugum sylvii*, hath also this property.

India furnishes us with a saline substance, known by the name of *borax*, which flows very easily, and then takes the form of glass. It is of great use in facilitating the fusion of metallic substances. It possesses some of the properties of fixed alkalis, which has induced certain chemists to represent it, through mistake, as a pure fixed alkali.

By mixing borax with the vitriolic acid, Mr Homberg obtained from it a salt, which sublimes in a certain degree of heat, whenever such a mixture is made. This salt has very singular properties; but its nature is not yet thoroughly understood. It dissolves in water with great difficulty; it is not volatile, though it rises by sublimation from the borax. According to Mr Roselle's observation, it rises then only by means of the water which carries it up; for when once made, it abides the fiercest fire, flows and vitrifies just as borax does, provided care be taken to free it previously from moisture by drying it properly. Mr Homberg called it *sedative salt*, on account of its medical effects. The sedative salt hath the appearance, and some of the properties, of a neutral salt; for it shoots into crystals, and does not change the colour of violets: but it acts the part of an acid with regard to alkalis, uniting with them to the point of saturation, and thereby forming a true neutral salt. It also acts, like the acid of vitriol, on all neutral salts; that is, it discharges the acid of such as have not the vitriolic acid in their composition.

Since Mr Homberg's time it hath been discovered, that a sedative salt may be made either with the nitrous or with the marine acid; and that sublimation is not necessary to extract it from the borax, but that it may be obtained by crystallization only. For this latter discovery we are indebted to Mr Geoffroy, as we are to Mr Lemery for the former.

Since that time M. Bayon d'Henouville, an able chemist, hath shewn that a sedative salt may be obtained by the means of vegetable acids; and hath lately demonstrated, that the sedative salt exists actually and perfectly in the borax, and that it is not produced by mixing acids with that saline substance, as it seems all the chemists before him imagined. This he proves convincingly from his analysis of borax, (which thereby appears to be nothing else but the sedative salt united with that fixed alkali which is the basis of sea-salt) and from his regenerating the same borax by uniting together that alkali and the sedative salt: a proof the most complete that can possibly be produced in natural philosophy, and equivalent to demonstration itself.

In order to finish what remains to be said upon the several sorts of saline substances, we should now speak of the acids obtained from vegetables and animals, and also of the volatile alkalis; but, seeing these saline substances differ from those of which we have already treated, only

as

as they are variously altered by the unions they have contracted with certain principles of vegetables and animals, of which nothing has been yet said, it is proper to defer being particular concerning them, till we have explained those principles.

### Of LIME.

ANY substance whatever, that has been roasted a considerable time in a strong fire without melting, is commonly called a *calc*. Stones and metals are the principal subjects that have the property of being converted into *calces*. We shall treat of metalline *calces* in a subsequent chapter, and in this confine ourselves to the *calx* of *stone*, known by the name of *lime*.

In treating of earths in general, we observed that they may be divided into two principal kinds; one of which actually and properly flows when exposed to the action of fire, and turns to glass; whence it is called a *fusible* or *vitrifiable* earth; the other resists the utmost force of fire, and is therefore said to be an *unfusible* or *unvitrifiable* earth. The latter is also not uncommonly called *calcinable* earth; though sundry sorts of unfusible earths are incapable of acquiring by the action of fire all the qualities of *calcinable* earth, or *lime* properly so called: such earths are particularly distinguished by the denomination of *refractory* earths.

As the different sorts of stones are nothing more than compounds of different earths, they have the same properties with the earths of which they are composed, and may, like them, be divided into fusible or vitrifiable, and unfusible or calcinable. The fusible stones are generally denoted by the name of *flints*; the calcinable stones, again, are the several sorts of marbles, cretaceous stones, those commonly called *free-stones*, &c. some of which, as they make the best lime, are, by way of eminence, called *lime-stones*. Sea-shells also, and stones that abound with fossil shells, are capable of being burnt to lime.

All these substances being exposed for a longer or shorter time to the violent action of fire, are said to be *calcinable*. By calcination they lose a considerable part of their weight, acquire a white colour, and become friable, though ever so solid before; as, for instance, the very hardest marbles. These substances, when thus calcined, take the name of *quick-lime*.

Water penetrates quick-lime, and rushes into it with vast activity. If a lump of newly calcined lime be thrown into water, it instantly excites almost as great a noise, ebullition, and smoke, as would be produced by a piece of red-hot iron; with such a degree of heat too, that, if the lime be in due proportion to the water, it will set fire to combustible bodies; as hath unfortunately happened to vessels laden with quick lime, on their springing a small leak.

As soon as quick-lime is put into water, it swells, and falls asunder into an infinite number of minute particles: in a word, it is in a manner dissolved by the water, which forms therewith a sort of white paste called *slacked lime*.

If the quantity of water be considerable enough for

the lime to form with it a white liquor, this liquor is called *lac calcis*; which, being left some time to settle, grows clear and transparent, the lime which was suspended therein and occasioned its opacity subsiding to the bottom of the vessel. Then there forms on the surface of the liquor a crystalline pellicle, somewhat opaque and dark coloured, which being skimmed off is reproduced from time to time. This matter is called *cremor calcis*.

Slacked lime gradually grows dry, and takes the form of a solid body, but full of cracks and destitute of firmness. The event is different when you mix it up, while yet a paste, with a certain quantity of uncalcined stony matter, such as sand for example: then it takes the name of *mortar*, and gradually acquires, as it grows drier and older, a hardness equal to that of the best stones. This is a very singular property of lime, nor is it easy to account for it; but it is a beneficial one, for every body knows the use of mortar in building.

Quick-lime attracts the moisture of the air in the same manner as concentrated acids and dry fixed alkalis, but not in such quantities as to render it fluid: it only falls into extremely small particles, takes the form of a fine powder, and the title of *lime slacked in the air*.

Lime once slacked, however dry it may afterwards appear, always retains a large portion of the water it had imbibed; which cannot be separated from it again but by means of a violent calcination. Being so recalcined it returns to be quick-lime, recovering all its properties.

Besides this great affinity of quick-lime with water, which discovers a saline character, it has several other saline properties, to be afterwards examined, much resembling those of fixed alkalis. In chemistry it acts very nearly as those salts do, and may be considered as holding the middle rank between a pure absorbent earth and a fixed alkali; and this hath induced many chemists to think that lime contains a true salt, to which all the properties it possesses in common with salts may be attributed.

But as the chemical examination of this subject hath long been neglected, the existence of a saline substance in lime hath been long doubtful. Mr du Fay was one of the first who obtained a salt from lime, by lixiviating it with a great deal of water, which he afterwards evaporated. But the quantity of salt he obtained by that means was very small; nor was it of an alkaline nature, as one would think it should have been, considering the properties of lime. Mr du Fay did not carry his experiments on this subject any further, probably for want of time; nor did he determine of what nature the salt was.

Mr Malouin had the curiosity to examine this salt of lime, and soon found that it was nothing else but what was above called *cremor calcis*. He found moreover, that, by mixing a fixed alkali with lime-water, a vitriolated tartar was formed; that, by mixing therewith an alkali like the basis of sea-salt, a Glauber's salt was produced; and, lastly, by combining lime with a substance abounding in phlogiston, he obtained a true sulphur. These very ingenious experiments prove to a demonstration, that the vitriolic acid constitutes the salt of lime; for, as hath been shewn, no other acid is capable of forming such combi-

combinations. On the other hand, Mr Malouin, having forced the vitriolic acid of this salt to combine with a phlogiston, found its basis to be earthy, and analogous to that of the selenites: whence he concluded, that the salt of lime is a true neutral salt, of the same kind as the selenites. Mr Malouin tells us he found several other salts in lime. But as none of them was a fixed alkali, and as all the saline properties of lime have an affinity with those of that kind of salt, there is great reason to think that all those salts are foreign to lime, and that their union with it is merely accidental.

Lime unites with all acids, and in conjunction with them exhibits various phenomena.

The vitriolic acid poured upon lime dissolves it with effervescence and heat. From this mixture there exhales a great quantity of vapours, in smell and colour perfectly like those of sea-salt; from which however they are found to be very different when collected into a liquor. From this combination of the vitriolic acid with lime arises a neutral salt, which ~~flows~~ <sup>flows</sup> into crystals, and is of the same kind with the selenitic salt obtained from lime by Mr Malouin.

The nitrous acid poured upon lime dissolves it in like manner with effervescence and heat: but the solution is transparent, and therein differs from the former, which is opaque. From this mixture there arises a neutral salt, which does not crystallize, and has withal the very singular property of being volatile, and rising wholly by distillation in a liquid form. This phenomenon is so much the more remarkable, as lime, the basis of this salt, is one of the most fixed bodies known in chemistry.

With the acid of sea-salt lime forms also a singular sort of salt, which greedily imbibes the moisture of the air. We shall have occasion to take further notice of it in another place.

Lime applied to fixed alkalis adds considerably to their caustic quality, and makes them more penetrating and active. An alkaline lixivium in which lime hath been boiled, being evaporated to dryness, forms a very caustic substance, which flows in the fire much more easily, attracts and retains moisture much more strongly, than fixed alkalis that have not been so treated. An alkali thus acuated by lime is called the *caustic stone*, or *potential cautery*, because it is employed by surgeons to produce eschars on the skin and cauterize it.

### *Of Metallic Substances in general.*

METALLIC substances are heavy, glittering, opaque, fusible bodies. They consist chiefly of a vitrifiable earth united with the phlogiston.

Several chemists insist on a third principle in these bodies, and have given it the name of *mercurial earth*; which, according to Becher and Stahl, is the very same that being combined with the vitriolic acid forms and characterises the acid of sea-salt. The existence of this principle hath not yet been demonstrated by any decisive experiment; but we shall shew that there are pretty strong reasons for admitting it.

We shall begin with mentioning the experiments which

prove metallic substances to consist of a vitrifiable earth united with the phlogiston. The first is this: if they be calcined in such a manner as to have no communication with any inflammable matter, they will be spoiled of all their properties, and reduced to an earth or calx, that has neither the splendour nor the ductility of a metal, and in a strong fire turns to an actual glass, instead of flowing like a metal.

The second is, that the calx or the glass resulting from a metal thus decomposed, recovers all its metalline properties by being fused in immediate contact with an inflammable substance, capable of restoring the phlogiston of which calcination had deprived it.

On this occasion we must observe, that chemists have not yet been able, by adding the phlogiston, to give the properties of metals to all sorts of vitrifiable earths indiscriminately, but to such only as originally made a part of some metallic body. For example, a compound cannot be made with the phlogiston and sand that shall have the least resemblance of a metal: and this is what seems to point out the reality of a third principle as necessary to form the metalline combination. This principle may probably remain united with the vitrifiable earth of a metallic substance, when reduced to a glass; whence it follows, that such vitrified metals require only the addition of a phlogiston to enable them to appear again in their pristine form.

It may be inferred from another experiment, that the calx and the glass of a metal are not its pure vitrifiable earth, properly so called: for by repeated or long continued calcinations, such a calx or glass may be rendered incapable of ever resuming the metalline form, in whatever manner the phlogiston be afterwards applied to it; so that by this means it is brought into the condition of a pure vitrifiable earth, absolutely free from any mixture.

When by adding the phlogiston to a metallic glass, we restore it to the form of a metal, we are said to *reduce*, *resuscitate*, or *revivify* that metal.

Metallic substances are of different kinds, and are divided into *metals* and *semi-metals*.

Those are called metals, which, besides their metalline splendor and appearance, are also malleable; that is, have the property of stretching under the hammer.

Those which have only the metalline splendor and appearance, without malleability, are called semi-metals.

Metals also are further subdivided into two sorts; *viz.* *perfect* and *imperfect* metals.

The perfect metals are those which suffer no damage or change whatever by the most violent and most lasting action of fire.

The imperfect metals are those which by the force of fire may be deprived of their phlogiston, and consequently of their metalline form.

When a moderate degree of fire only is employed to deprive a metal of its phlogiston, the metal is said to be *calcined*; and then it appears in the form of a powdered earth, which is called a *calx*; and this metalline calx being exposed to a more violent degree of fire, melts and turns to glass.

Metallic substances have an affinity with acids, but not equally with all; that is, every metallic substance is not capable of uniting and joining with every acid.

When an acid unites with a metallic substance, there commonly arises an ebullition, attended with a kind of hissing noise and fuming exhalations. By degrees, as the union becomes more perfect, the particles of the metal combining with the acid become invisible: this is termed *dissolution*; and when a metalline mass thus disappears in an acid, the metal is said to be *dissolved* by that acid. It is proper to observe, that acids act upon metalline substances, in one respect, just as they do upon alkalis and absorbent earths: for an acid cannot take up above such a certain proportion thereof as is sufficient to saturate it, to destroy several of its properties, and weaken others. For example, when an acid is combined with a metal to the point of saturation, it loses its taste, does not turn the blue colour of a vegetable red, and its affinity with water is considerably impaired. On the other hand, metalline substances, which, when pure, are incapable of uniting with water, by being joined with an acid, acquire the property of dissolving in water. These combinations of metalline substances with acids form different sorts of neutral salts; some of which have the property of shooting into crystals, while others have it not: most of them, when thoroughly dried, attract the moisture of the air.

The affinity which metalline substances have with acids is less than that which absorbent earths and fixed alkalis have with the same acids; so that all metalline salts may be decomposed by one of these substances, which will unite with the acid, and precipitate the metal.

Metalline substances thus separated from an acid solvent are called *magisteries*, and *precipitates* of metals. None of these precipitates, except those of the perfect metals, retain the metalline form: most of their phlogiston hath been destroyed by the solution and precipitation, and must be restored before they can recover their properties. In short, they are nearly in the same state with metalline substances deprived of their phlogiston by calcination; and accordingly such a precipitate is called a *calx*.

A metalline calx prepared in this manner loses a greater or a less portion of its phlogiston, the more or less effectually and thoroughly the metalline substance of which it made a part was dissolved by the acid.

Metallic substances have affinities with each other which differ according to their different kinds; but this is not universal, for some of them are incapable of any sort of union with some others.

It must be observed, that metallic substances will not unite, except they be both in a similar state; that is, both in a metalline form, or both in the form of a glass; for a metalline substance, retaining its phlogiston, cannot contract an union with any metallic glass, even its own.

### Of METALS.

THERE are six metals, of which two are perfect, and four imperfect. The perfect metals are gold and silver; the others are copper, tin, lead, and iron. Some chemists admit a seventh metal, *viz.* quick-silver; but, as it

is not malleable, it has been generally considered as a metallic body of a particular kind.

The ancient chemists, or rather the alchemists, who fancied a certain relation or analogy between metals and the heavenly bodies, bestowed on the seven metals, reckoning quick silver one of them, the names of the seven planets of the ancients, according to the affinity which they imagined they observed between those several bodies. Thus gold was called *Sol*, silver *Luna*, copper *Venus*, tin *Jupiter*, lead *Saturn*, iron *Mars*, and quick silver *Mercury*. Though these names were assigned for reasons merely chimerical, yet they still keep their ground; so that it is not uncommon to find the metals called by the names, and denoted by the characters, of the planets, in the writings even of the best chemists. Metals are the heaviest bodies known in nature.

### Of GOLD.

GOLD is the heaviest of all metals. The arts of wire drawing and gold-beating shew its wonderful ductility. The greatest violence of fire is not able to produce any alteration in it.

GOLD cannot be dissolved by any pure acid: but if the acid of nitre be mixed with the acid of sea-salt, there results a compound acid liquor, with which it has so great an affinity, that it is capable of being perfectly dissolved thereby. The chemists have called this solvent *aqua regis*, on account of its being the only acid that can dissolve gold, which they consider as the king of metals. The solution of gold is of a beautiful orange colour.

If gold dissolved in *aqua regis* be precipitated by an alkali or an absorbent earth, the precipitate gently dried, and then exposed to a certain degree of heat, is instantly dispersed into the air, with a most violent explosion and noise: gold thus precipitated is therefore called *aurum fulminans*. But if the precipitated gold be carefully washed in plenty of water, so as to clear it of all the adhering saline particles, it will not fulminate; but may be melted in a crucible without any additament, and will then appear in its usual form. The acid of vitriol being poured on *aurum fulminans* likewise deprives it of its fulminating quality.

GOLD does not begin to flow till it be red-hot like a live coal. Though it be the most malleable and most ductile of all metals, it has the singular property of losing its ductility more easily than any of them: even the fumes of charcoal are sufficient to deprive it thereof, if they come to contact with it while it is in fusion.

The malleability of this metal, and indeed of all the rest, is also considerably diminished by exposing it suddenly to cold when it is red hot; for example, by quenching it in water, or even barely exposing it to the cold air. The way to restore ductility to gold, when lost by its coming in contact with the vapour of coals, and in general to every other metal rendered less malleable by being suddenly cooled, is to heat it again, to keep them red hot a considerable time, and then to let them cool very slowly and gradually: this operation frequently repeated will by degrees much increase the malleability of a metal.

Pure sulphur hath no effect on gold; but being combined

bined with an alkali into a *hepar sulphuris*, it unites therewith very readily. Nay, so intimate is their union, that the gold by means thereof becomes soluble in water; and this new compound of gold and liver of sulphur, being dissolved in water, will pass through the pores of brown paper without suffering any decomposition; which does not happen, at least in such a manifest degree, to other metallic substances dissolved by liver of sulphur.

*Aurum fulminans* mixed and melted with flour of sulphur loses its fulminating quality: which arises from hence, that on this occasion the sulphur burns, and its acid, which is the same with the vitriolic, being thereby set at liberty, becomes capable of acting upon the gold as a vitriolic acid would; which, as was said above, deprives the gold of its fulminating quality.

### OF SILVER.

NEXT to gold, silver is the most perfect metal. Like gold, it resists the utmost violence of fire, even that in the focus of a burning-glass. However, it holds only the second place among metals; because it is lighter than gold by almost one half; is also somewhat less ductile; and lastly, because it is acted upon by a greater number of solvents.

Yet silver hath one advantage over gold, namely that of being a little harder; which makes it also more sonorous.

This metal, like gold, begins to flow when it is so thoroughly penetrated by the fire as to appear ignited like a live coal.

While this metal is in fusion, the immediate contact of the vapour of burning coals deprives it almost entirely of its malleability, in the same manner as we observed happens to gold: but both these metals easily recover that property by being melted with nitre.

The nitrous acid is the true solvent of silver, and being somewhat dephlegmated will very readily and easily take up a quantity of silver equal in weight to itself.

Silver thus combined with the nitrous acid forms a metallic salt which shoots into crystals, called by the name of *lunar crystals*, or *crystals of silver*.

These crystals are most violently caustic: applied to the skin, they quickly affect it much as a live coal would; they produce a blackish eschar, corroding and entirely destroying the parts they touch. Surgeons use them to eat away the proud fungous flesh of ulcers. As silver united with the nitrous acid hath the property of blackening all animal substances, a solution of this metallic salt is employed to die hair, or other animal matters, of a beautiful and durable black.

These crystals flow with a very moderate heat, and even before they grow red. Being thus melted, they form a blackish mass; and in this form they are used by surgeons, under the title of *lapis infernalis*, *infernal stone*, or *silver caustic*.

Silver is also dissolved by the vitriolic acid: but then the acid must be concentrated, and in quantity double the weight of the silver: nor will the solution succeed without a considerable degree of heat.

Spirit of salt and *aqua regis*, as well as the other a-

cids, are incapable of dissolving this metal, at least in the ordinary way.

Though silver be not soluble in the acid of sea-salt, nor easily in the acid of vitriol, as hath just been observed, it doth not follow, that it hath but a weak affinity with the latter, and none at all with the former: on the contrary, it appears from experiment, that it hath with these two acids a much greater affinity than with the acid of nitre: which is singular enough, considering the facility with which this last acid dissolves it.

The experiment which proves the fact is this. To a solution of silver in the nitrous acid add the acid either of vitriol or of sea-salt, and the silver will instantly quit its nitrous solvent to join with the superadded acid.

Silver thus united with the vitriolic or the marine acid is less soluble in water than when combined with the nitrous acid: and for this reason it is, that when either of these two acids is added to a solution of silver, the liquor immediately becomes white, and a precipitate is formed, which is no other than the silver united with the precipitating acid. If the precipitation be effected by the vitriolic acid, the precipitate will disappear upon adding a sufficient quantity of water, because there will then be water enough to dissolve it. But the case is not the same when the precipitation is made by the marine acid: for silver combined therewith is scarce soluble in water.

This precipitate of silver procured by means of the marine acid is very easily fused, and when fused changes to a substance in some measure transparent and flexible; which hath occasioned it to be called by the name of *luna cornea*. If it be proposed to decompose this *luna cornea*, that is, to separate the marine acid from the silver with which it is united, the *luna cornea* must be melted along with fatty and absorbent matters, with which the acid will unite, and leave the metal exceeding pure.

It must be observed, that if, instead of the marine acid, sea-salt in substance be added to a solution of silver in the nitrous acid, a precipitate is also produced, which by fusion appears to be a true *luna cornea*. The reason is, that the sea-salt is decomposed by the nitrous acid, which seizes its basis, as having a greater affinity therewith than its own acid hath; and this acid being consequently disengaged, and set at liberty unites with the silver, which, as has been shown, has greater affinity with it than with the nitrous acid. This is an instance of decomposition effected by means of one of those double affinities mentioned in the seventh proposition concerning affinities.

From what hath been already said it is clear, that all these combinations of silver with acids may be decomposed by absorbent earths and by fixed alkalis; it being a general law with regard to all metallic substances.

Silver, when separated by these means from the acids in which it was dissolved, requires nothing but simple fusion to restore it to its usual form; because it does not, any more than gold, lose its phlogiston by those solutions and precipitations.

Silver unites with sulphur in fusion. If this metal be only made red-hot in a crucible, and sulphur be then ad-

ded,

ded, it immediately flows; the sulphur acting as a flux to it. Silver thus united with sulphur forms a mass that may be cut, is half malleable, and hath nearly the colour and consistence of lead. If this sulphurated silver be kept a long time in fusion, and in a great degree of heat, the sulphur flies off and leaves the silver pure. But if the sulphur be evaporated by a violent heat, it carries off with it part of the silver.

Silver unites and mixes perfectly with gold in fusion. The two metals thus mixed form a compound with properties partaking of both.

Metallurgists have hitherto sought in vain for a perfectly good and easy method of separating these two metals by the *dry way* only: (This term is used to signify all operations performed by fusion:) but they are conveniently enough parted by the *wet way*, that is, by acid solvents. This method is founded on the above-mentioned properties of gold and silver with respect to acids. It hath been shewn, that *aqua regis* only will dissolve gold; that silver, on the contrary, is not soluble by *aqua regis*, and that its proper solvent is the acid of nitre: Consequently, when gold and silver are mixed together, if the compound mass be put into *aqua fortis*, this acid will take up all the silver, without dissolving a particle of the gold, which will therefore remain pure; and by this means the desired separation is effected. This method, which is commonly made use of by goldsmiths and miners, is called the *parting assay*.

It is plain, that if *aqua regis* were employed instead of *aqua fortis*, the separation would be equally effected; and that the only difference between this process and the former would consist in this, that now the gold would be dissolved, and the silver remain pure. But the operation by *aqua fortis* is preferable; because *aqua regis* does take up a little silver, whereas *aqua fortis* hath not the least effect on gold.

It must be observed, that when gold and silver are mixed together in equal parts, they cannot be parted by the means of *aqua fortis*. To enable the *aqua fortis* to act duly on the silver, this metal must be, at least, in a triple proportion to the gold. If it be in a less proportion, you must either employ *aqua regis* to make the separation, or, if you prefer the use of *aqua fortis*, melt the metalline mass, and add as much silver as is necessary to make up the proportion above-mentioned: And hence this process is called *quartation*.

This effect, which is pretty singular, probably arises from hence, that when the gold exceeds, or even equals the silver in quantity, the parts of both being intimately united, the former are capable of coating over the latter, and covering them so as to defend them from the action of the *aqua fortis*; which is not the case when there is thrice as much silver as gold.

There is one thing more to be taken notice of with regard to this process; which is, that perfectly pure *aqua fortis* is rarely to be met with, for two reasons: First, it is difficult in making it wholly to prevent the rising of the medium employed to disengage the nitrous acid; that is, a little of the vitriolic acid will mix with the vapours of the *aqua fortis*: Secondly, unless the saltpetre be very well purified, it will always hold some small portion of

sea-salt, the acid of which, we know, is very readily set loose by the vitriolic acid, and consequently rises together with the vapours of the *aqua fortis*. It is easy to see, that *aqua fortis*, mixed either with the one or the other, is not proper for the parting process; because, as has just been said, the vitriolic and the marine acid equally precipitate silver dissolved in the nitrous acid; by which means, when they are united with that acid, they weaken its action upon the silver, and hinder the dissolution. Add, that *aqua fortis* adulterated with a mixture of spirit of salt becomes an *aqua regis*, and consequently is rendered capable of dissolving gold, in proportion as its action upon silver is diminished.

In order to remedy this inconvenience, and free *aqua fortis* from the vitriolic or marine acid with which it is tainted, silver must be dissolved therein: By degrees, as the metal dissolves, those heterogeneous acids lay hold of it, and precipitate with it in the form of a white powder, as we observed before. This precipitate being wholly fallen, the liquor grows clear; after which, if it be found capable of dissolving more silver, without turning milky, it may be depended on as a perfectly pure *aqua fortis*. Then filtre it, dissolve more silver in it, as long as it will take up any, and you will have a solution of silver in a very pure *aqua fortis*. By means of this solution may other *aqua fortis* be purified: For, pour a few drops thereof into a very impure *aqua fortis*, and immediately the vitriolic or marine acid, with which that *aqua fortis* is contaminated, will join the silver and fall therewith to the bottom. When the solution of silver prepared as above does not in the least affect the transparency of the *aqua fortis*, it is then very pure, and fit for the purposes of quartation.

This operation of purifying *aqua fortis* by a solution of silver is called the *precipitation of aqua fortis*; and *aqua fortis* thus purified is called *precipitated aqua fortis*.

When silver is dissolved in *aqua fortis* it may be separated therefrom, as has been shewn, by absorbent earths and fixed alkalis.

#### Of COPPER.

Of all the imperfect metals, copper comes the nearest to gold and silver. Its natural colour is a deep-red yellow. It resists a very violent degree of fire for a considerable time; but losing its phlogiston at last, it changes its metalline form for that of a calx, or a pure reddish earth. This calx is hardly, if at all, reducible to glass, without the addition of something to promote its fusion; all that the fiercest heat can do being only to render it soft. Copper, even while it retains its metalline form, and is very pure, requires a considerable degree of fire to melt it, and does not begin to flow till long after it is red-hot. When in fusion, it communicates a greenish colour to the flame of the coals.

This metal is inferior to silver in point of gravity; nor is its ductility so great, though it be pretty considerable: But, on the other hand, it exceeds that metal in hardness. It unites readily with gold and silver; nor does it greatly lessen their beauty when added to them in a small quantity: Nay, it even procures them some advantages;

vantages; such as making them harder, and less subject to lose their ductility. This may probably arise from hence, that the ductility of copper has the peculiarity of resisting most of those causes which rob the perfect metals of theirs.

The property which other metalline substances have in common with copper, of losing the phlogiston by calcining and then vitrifying, furnishes us with a method of separating them from gold and silver, when they are combined therewith. Nothing more is required than to expose the mass, compounded of the perfect metals and other metalline substances, to a degree of heat sufficient to calcine whatever is not either gold or silver. It is evident that by this means these two metals will be obtained as pure as is possible; for, as hath already been said, no metalline calx or glass is capable of uniting with metals possessed of their phlogiston. On this principle is formed the whole business of refining gold and silver.

When the perfect metals have no other alloy but copper, as this metal is not to be calcined or vitrified without great difficulty, which is increased by its union with the unvitrifiable metals, it is easy to see that it is almost impossible to separate them without adding something to facilitate the vitrification of the copper. Such metals as have the property of turning easily to glass are very fit for this purpose; and it is necessary to add a certain quantity thereof, when gold or silver is to be purified from the alloy of copper. We shall have occasion to be more particular on this subject when we come to treat of lead.

Copper is soluble in all the acids, to which it communicates a green colour, and sometimes a blue. Even the neutral salts, and water itself, act upon this metal. With regard to water indeed, as the procuring it absolutely pure and free from any saline mixture is next to an impossibility, it remains a question, whether the effect it produces on copper be not owing to certain saline particles contained in it. It is this great facility of being dissolved that renders copper so subject to rust; which is nothing else but some parts of its surface corroded by saline particles contained in the surrounding air and water.

The rust of copper is always green or blue, or of a colour between these two. Internally used it is very noxious, being a real poison, as are all the solutions of this metal made by any acid whatever. The blue colour, which copper constantly assumes, when corroded by any saline substance, is a sure sign by which it may be discovered where-ever it exists, even in a very small quantity.

Copper dissolved in the vitriolic acid forms a kind of metalline salt, which shoots into rhomboidal crystals of a most beautiful blue colour. These crystals are called *blue vitriol*, or *vitriol of copper*. They are sometimes found ready formed in the bowels of the earth; and may be artificially made by dissolving copper in the vitriolic acid; but the solution will not succeed unless the acid be well dephlegmated. The taste of this vitriol is saltish and astringent. It retains a considerable quantity of water in crystallizing, on which account it is easily rendered fluid by fire.

It must be observed, that when it is exposed to a cer-

tain degree of heat in order to free it of its humidity, a great part of its acid flies off at the same time: And hence it is that, after calcination, there remains only a kind of earth, or metalline calx, of a red colour, which contains but very little acid. This earth cannot be brought to flow but with the greatest difficulty.

A solution of copper in the nitrous acid forms a salt which does not crystallize, but, when dried, powerfully attracts the moisture of the air. The same thing happens when it is dissolved in the spirit of salt, or in *aqua regis*.

If the copper, thus dissolved by any of these acids, be precipitated by an earth or an alkali, it retains nearly the colour it had in the solution: But these precipitates are scarce any thing more than the earth of copper, or copper deprived of most of its phlogiston; so that if they were exposed to a violent fire, without any additament, a great part of them would be converted into an earth that could never be reduced to a metalline form. Therefore, when we intend to reduce these precipitates to copper, it is necessary to add a certain quantity of a substance capable of restoring to them the phlogiston they have lost.

The substance which hath been found fittest for such reductions is charcoal dust; because charcoal is nothing but a phlogiston closely combined with an earth, which renders it exceedingly fixed, and capable of resisting a violent force of fire. But as charcoal will not melt, and consequently is capable of preventing rather than forwarding the flux of a metalline calx or glass, which nevertheless is essentially necessary to complete the reduction, it hath been contrived to mix it, or any other substance containing the phlogiston, with such fixed alkalis as easily flow, and are fit to promote the flux of other bodies. These mixtures are called *reducing fluxes*; because the general name of fluxes is given to all salts, or mixtures of salts, which facilitate fusion.

If sulphur be applied to copper made perfectly red-hot, the metal immediately runs; and these two substances uniting, form a new compound much more fusible than pure copper.

This compound is destroyed by the sole force of fire, for two reasons: The first is, that, sulphur being volatile, the fire is capable of subliming a great part of it, especially when it is in a great proportion to the copper with which it is joined; the second is, that the portion of sulphur which remains, being more intimately united with the copper, though it be rendered less combustible by that union, is nevertheless burnt and consumed in time. Copper being combined with sulphur, and together with it exposed to the force of fire, is found to be partly changed into a blue vitriol; because the vitriolic acid, being disengaged by burning the sulphur, is by that means qualified to dissolve the copper. The affinity of copper with sulphur is greater than that of silver.

This metal, as well as the other imperfect metals and the semi-metals, being mingled with nitre and exposed to the fire, is decomposed and calcined much sooner than by itself; because the phlogiston which it contains occasions the delagration of the nitre, and consequently the two substances mutually decompose each other. There are certain metalline substances whose phlogiston is so abundant,

dant, and so weakly connected with their earth, that, when they are thus treated with nitre, there arises immediately a detonation, accompanied with flame, and as violent as if sulphur or charcoal dust had been employed; so that in a moment the metalline substance loses its phlogiston, and is calcined. The nitre, after these detonations, always assumes an alkaline character.

#### OF IRON.

IRON is lighter and less ductile than copper; but it is much harder, and of more difficult fusion.

It is the only body that has the property of being attracted by the magnet, which therefore serves to discover it where-ever it is. But it must be observed, that it hath this property only when in its metalline state, and loses it when converted to an earth or calx. Hence very few iron-ores are attracted by the loadstone; because, for the most part, they are only sorts of earths, which require a phlogiston to be added before they can be brought to the form of true iron.

When iron hath undergone no other preparation but the fusion which is necessary to smelt it from its ore, it is usually quite brittle, and flies under the hammer: Which arises in some measure from its containing a certain portion of unmetalline earth interposed between its parts. This we call *pig-iron*.

By melting this a second time it is rendered purer, and more free from heterogeneous matters: But still, as its proper parts are probably not brought sufficiently near, or closely enough united, till the iron hath undergone some further preparation besides that of fusion, it seldom hath any degree of malleability.

The way to give it this property is to make it just red-hot, and then hammer it for some time in all directions; to the end that its parts may be properly united, incorporated, and welded together, and that the heterogeneous matters which keep them asunder may be separated. Iron made by this means as malleable as possible, we call *bar-iron*, or *forged iron*.

Bar-iron is still harder to fuse than pig-iron: To make it flow requires the utmost force of fire.

Iron has the property of imbibing a greater quantity of phlogiston than is necessary to give it the metalline form. It may be made to take in this superabundant phlogiston two ways: The first is by fusing it again with matters that contain the phlogiston; the second is, by encompassing it with a quantity of such matters, charcoal-dust, for instance, and then exposing it so encompassed, for a certain time, to a degree of fire barely sufficient to keep it red-hot. This second method, whereby one substance is incorporated with another by means of fire, but without fusing either of them, is in general called *cementation*.

Iron thus impregnated with an additional quantity of phlogiston is called *steel*. The hardness of steel may be considerably augmented by *tempering* it; that is, by making it red-hot, and suddenly quenching it in some cold liquor. The hotter the metal, and the colder the liquor in which it is quenched, the harder will the steel be. By this means tools are made, such as files and *scers*, capable of cutting and dividing the hardest bo-

dies, as glass, pebbles, and iron itself. The colour of steel is darker than that of iron, and the facets which appear on breaking it are smaller. It is also less ductile and more brittle, especially when tempered.

As iron may be impregnated with an additional quantity of phlogiston, and thereby converted into steel, so may steel be again deprived of that superabundant phlogiston, and brought back to the condition of iron. This is effected by cementing it with poor earths, such as calcined bones and chalk. By the same operation steel may be *untempered*: nay, it will lose the hardness it had acquired by tempering, if it be but made red-hot, and left to cool gradually. As iron and steel differ only in the respects we have here taken notice of, their properties being in all other respects the same, what follows is equally applicable to both.

Iron being exposed to the action of fire for some time, especially when divided into small particles, such as filings, is calcined, and loses its phlogiston. By this means it turns to a kind of reddish yellow earth, which on account of its colour is called *crocus Martis*, or *saffron of Mars*.

This calx of iron has the singular property of flowing in the fire with somewhat less difficulty than iron itself; whereas every other metalline calx flows with less ease than the metal that produced it. It has moreover the remarkable property of uniting with the phlogiston, and of being reduced to iron without fusion; requiring for that purpose only to be made red-hot.

Iron may be incorporated with silver, and even with gold, by means of certain operations. Under the article of lead, we shall see how it may be separated from these metals.

The acids produce on it much the same effects as on copper: every one of them acts upon it. Certain neutral salts, alkalis, and even water itself, are capable of dissolving it; and hence it is also very subject to rust.

The vitriolic acid dissolves it with the greatest ease: but the circumstances which attend the dissolution thereof are different from those with which the same acid dissolves copper. For, 1. Whereas the vitriolic acid must be concentrated to dissolve copper, it must on the contrary be diluted with water to dissolve iron, which it will not touch when well dephlegmated. 2. The vapours which rise in this dissolution are inflammable; so that if it be made in a small-necked bottle, and the flame of a candle be applied to the mouth thereof, the vapours in the bottle take fire with such rapidity as to produce a considerable explosion.

This solution is of a beautiful green colour; and from this union of the vitriolic acid with iron, there results a neutral metalline salt, which has the property of shooting into crystals of a rhomboidal figure, and a green colour. These crystals are called *green vitriol*, and *vitriol of Mars*.

Green vitriol hath a saltish and astringent taste. As it retains a great deal of water in crystallizing it quickly flows by the action of fire: but this fluidity is owing to its water only, and is not a real fusion; for as soon as its moisture is evaporated, it resumes a solid form. Its green transparent colour is now changed into an opaque white:



white: and, if the calcination be continued, its acid also exhales, and is dissipated in vapours; and as it loses that, it turns gradually to a yellow colour, which comes so much the nearer to a red the longer the calcination is continued, or the higher the force of the fire is raised; which being driven to the utmost, what remains is of a very deep red. This remainder is nothing but the body of the iron, which, having lost its phlogiston, is now no more than an earth, nearly of the same nature with that which is left after calcining the metal itself.

Green vitriol dissolved in water spontaneously lets fall a yellowish earthy sediment. If this solution be defecated by filtration, it still continues to deposit some of the same substance, till the vitriol be wholly decomposed. This sediment is nothing but the earth of iron, which is then called *ochre*.

The nitrous acid dissolves iron with great ease. This solution is of a yellow colour, inclining more or less to a russet, or dark-brown, as it is more or less saturated with iron. Iron dissolved by this acid also falls spontaneously into a kind of calx, which is incapable of being dissolved a second time; for the nitrous acid will not act upon iron that has lost its phlogiston. This solution does not crystallize, and if evaporated to dryness attracts the moisture of the air.

Spirit of salt likewise dissolves iron, and this solution is green. The vapours which rise during the dissolution are inflammable, like those which ascend when this metal is attacked by the vitriolic acid. *Aqua regis* makes a solution of iron, which is of a yellow colour.

Iron hath a greater affinity than either silver or copper with the nitrous and vitriolic acids: so that if iron be presented to a solution of either, in one of these two acids, the dissolved metal will be precipitated; because the acid quits it for the iron, with which it has a greater affinity.

On this occasion it must be observed, that if a solution of copper in the vitriolic acid be precipitated by means of iron, the precipitate has the form and splendour of a metal, and does not require the addition of a phlogiston to reduce it to true copper; which is not the case, when the precipitation is effected by earths or alkaline salts.

The colour of this metalline precipitate hath deceived several persons, who being unacquainted with such phenomena, and with the nature of blue vitriol, imagined that iron was transmuted into copper, when they saw a bit of iron, laid in a solution of that vitriol, become, in form and external appearance, exactly like copper: whereas the surface only of the iron was crusted over with the particles of copper contained in the vitriol, which had gradually fallen upon, and adhered to the iron, as they were precipitated out of the solution.

Among the solvents of iron we mentioned fixed alkalis: and that they have such a power, is proved by the following phenomenon. If a large proportion of alkaline salts be suddenly mixed with a solution of iron in an acid, no precipitation ensues, and the liquor remains clear and pellucid; or if at first it look a little turbid, that appearance lasts but a moment, and the liquor presently recovers its transparency. The reason is, that quantity of alkali is more than sufficient to saturate all the acid of

the solution; and the superabundant portion thereof, meeting with the iron already finely divided by the acid, dissolves it with ease as fast as it falls, and so prevents its mudding in liquor. To evince that this is so in fact, let the alkali be applied in a quantity that is not sufficient, or but barely sufficient, to saturate the acid, and the iron will then precipitate like any other metal.

Water also acts upon iron; and therefore iron exposed to moisture grows rusty. If iron-slings be exposed to the dew, they turn wholly to a rust, which is called *crocus Martis aperiens*.

Iron exposed to the fire, together with nitre, makes it detonate pretty briskly, sets it in a flame, and decomposes it with rapidity.

This metal hath a greater affinity than any other metalline substance with sulphur; on which account, it is successfully used to precipitate, and separate all metalline substances combined with sulphur.

Sulphur uniting with iron communicates to it such a degree of fusibility, that if a mass of this metal, heated red-hot, be rubbed with a bit of sulphur, it incessantly runs into as perfect a fusion as a metal exposed to the focus of a large burning-glass.

#### Of TIN.

TIN is the lightest of all metals. Though it yields easily to the impression of hard bodies, it has but little ductility. Being bent backwards and forwards it makes a small crackling noise. It flows with a very moderate degree of fire, and long before it comes to be red-hot. When it is in fusion, its surface soon grows dusky, and there forms upon it a thin dark-coloured dusty pellicle, which is no other than a part of the tin that has lost its phlogiston, or a calx of tin. The metal thus calcined easily recovers its metalline form, on the addition of a phlogiston. If the calx of tin be urged by a strong fire it grows white, but the greatest violence of heat will not fuse it; which makes some chemists consider it as a calcinable or absorbent earth, rather than a vitrifiable one. Yet it turns to glass in some sort, when mixed with any other substance that vitrifies easily. However, it always produces an imperfect glass only, which is not at all transparent, but of an opaque white. The calx of tin thus vitrified is called *enamel*. Enamels are made of several colours by the addition of this or that metalline calx.

Tin unites easily with all the metals; but it destroys the ductility and malleability of every one of them, lead excepted. Nay, it possesses this property of making metals brittle, in such an eminent degree, that the very vapour of it, when in fusion, is capable of producing this effect. Moreover, which is very singular, the most ductile metals, even gold and silver, are those on which it works this change with the most ease, and in the greatest degree. It has also the property of making silver, mixed with it, flow over a very small fire.

It adheres to, and in some measure incorporates with, the surface of copper and of iron; whence arose the practice of coating over those metals with tin. Tin-plates are no other than thin plates of iron tinned over.

If to twenty parts of tin one part of copper be added, this

this alloy renders it much more solid, and the mixed mass continues tolerably ductile.

If, on the contrary, to one part of tin ten parts of copper be added, together with a little zinc, a femimetal to be considered hereafter, from this combination there results a metalline compound, which is hard, brittle, and very sonorous; so that it is used for casting bells: This composition is called *brouze* and *bell-metal*.

Tin hath an affinity with the vitriolic, nitrous, and marine acids. All of them attack and corrode it; yet none of them is able to dissolve it without great difficulty: So that if a clear solution thereof be desired, particular methods must be employed for that purpose; for the acids do but in a manner calcine it, and convert it to a kind of white calx or precipitate. The solvent which has the greatest power over it is *aqua regis*, which has even a greater affinity therewith than with gold itself; whence it follows, that gold dissolved in *aqua regis* may be precipitated by means of tin; but then the *aqua regis* must be weakened. Gold thus precipitated by tin is of a most beautiful colour, and is used for a red in enamelling and painting on porcelain, as also to give a red colour to artificial gems. If the *aqua regis* be not lowered, the precipitate will not have the purple colour.

Tin hath the property of giving a great lustre to all red colours in general; on which account it is used by the dyers for striking a beautiful scarlet, and tin-vessels are employed in making fine syrup of violets. Water does not act upon this metal, as it does upon iron and copper; for which reason it is not subject to rust; nevertheless, when it is exposed to the air, its surface soon loses its polish and splendor.

Tin mixed with nitre, and exposed to the fire, deflagrates with it, makes it detonate, and is immediately converted to a *refractory calx*; for so all substances are called which are incapable of fusion.

Tin readily unites with sulphur, and with it becomes a brittle and friable mass.

#### Of LEAD.

NEXT to gold and mercury, lead is the heaviest of all metalline substances, but in hardness is exceeded by every one of them. Of all metals also it melts the easiest, except tin. While it is in fusion there gathers incessantly on its surface, as on that of tin, a blackish, dusty pellicle, which is nothing but a calx of lead.

This calx further calcined by a moderate fire, the flame being reverberated on it, soon grows white. If the calcination be continued it becomes yellow, and at last of a beautiful red. In this state it is called *minium*, and is used as a pigment. *Minium* is not easily made, and the operation succeeds well in large manufactures only.

To convert lead into *litharge*, which is the metal in a manner half vitrified, you need only keep it melted by a pretty strong fire; for then, as its surface gradually calcines, it tends more and more to fusion and vitrification.

All these preparations of lead are greatly disposed to perfect fusion and vitrification, and for that purpose require but a moderate degree of fire; the calx or earth of

lead being of all metalline earths that which vitrifies the most easily.

Lead hath not only the property of turning into glass with the greatest facility, but it hath also that of promoting greatly the vitrification of all the other imperfect metals; and, when it is actually vitrified, procures the ready fusion of all earths and stones in general, even those which are refractory, that is, which could not be fused without its help.

Glass of lead, besides its great fusibility, hath also the singular property of being so subtle and active as to corrode and penetrate the crucibles in which it is melted, unless they be of an earth that is exceeding hard, compact, and withal very refractory: for glass of lead being one of the most powerful fluxes that we know, if the earth of the crucible in which it is melted be in the smallest degree fusible, it will be immediately vitrified; especially if there be any metallic matter in its composition.

The great activity of glass of lead may be weakened by joining it with other vitrifiable matters; but unless these be added in a very great proportion, it will still remain powerful enough to penetrate common earths, and carry off the matters combined with it.

On these properties of lead, and of the glass of lead, depends the whole business of refining gold and silver. It hath been shewn, that as these two metals are indestructible by fire, and the only ones which have that advantage, they may be separated from the imperfect metals, when mixed therewith, by exposing the compound to a degree of fire sufficiently strong to vitrify the latter; which when once converted into glass can no longer remain united with any metal that has its metalline form. But it is very difficult to procure this vitrification of the imperfect metals, when united with gold and silver; nay, it is in a manner impossible to vitrify them entirely, for two reasons: first, because most of them are naturally very difficult to vitrify: secondly, because the union they have contracted with the perfect metals defends them, in a manner, from the action of the fire, and that so much the more effectually as the proportion of the perfect metals is greater; which being indestructible, and in some sort coating over those with which they are alloyed, serve them as a preservative and impenetrable shield against the utmost violence of fire.

It is therefore clear, that a great deal of labour may be saved, and that gold and silver may be refined to a much greater degree of purity than can otherwise be obtained, if to a mixture of these metals with copper, for instance, or any other imperfect metal, be added a certain quantity of lead. For the lead, by its known property, will infallibly produce the desired vitrification; and as it likewise increases the proportion of the imperfect metals, and so lessens that of the perfect metals, in the mass, it evidently deprives the former of a part of their guard, and so effects a more complete vitrification. As the glass of lead hath the property of running through the crucible, and carrying with it the matters which it has vitrified, it follows, that when the vitrification of the imperfect metals is effected by its means, all those vitrified matters together penetrate the vessel containing the fused metalline mass, disappear, and leave only the gold and silver perfectly

perfectly pure, and freed, as far as is possible, from all admixture of heterogeneous parts.

The better to promote the separation of such parts, it is usual to employ in this process a particular sort of small crucibles, made of the ashes of calcined bones, which are exceedingly porous and easily pervaded. They are called *cupels*, on account of their figure, which is that of a wide-mouthed cup: and from hence the operation takes its name; for when we refine gold and silver in this manner, we are said to *cupel* those metals. It is easy to perceive, that the more lead is added, the more accurately will the gold and silver be refined; and that so much the more lead ought to be added as the perfect metals are alloyed with a greater proportion of the imperfect. This is the most severe trial to which a perfect metal can be put, and consequently any metal that stands it may be fairly considered as such.

In order to denote the fineness of gold, it is supposed to be divided into twenty-four parts called *carats*; and gold, which is quite pure and free from all alloy, is said to be twenty-four carats fine; that which contains  $\frac{1}{24}$  part of alloy is called gold of twenty-three carats; that which contains  $\frac{2}{24}$  of alloy is but twenty-two carats; and so on. Silver again is supposed to be divided into twelve parts only, which are called *penny-weights*; so that when absolutely pure it is said to be twelve penny-weights fine; when it contains  $\frac{1}{12}$  of alloy, it is then called eleven penny-weights fine; when it contains  $\frac{2}{12}$  of alloy, it is called ten penny-weights fine; and so on.

In treating of copper, we promised to shew under the article of lead how to separate it from iron. The process is founded on that property of lead which renders it incapable of mixing and uniting with iron, though it readily dissolves all other metalline substances. Therefore if you have a mass compounded of copper and iron, it must be fused with a certain quantity of lead, and then the copper, having a greater affinity with lead than with iron, will desert the latter and join the former, which being incapable of any union with iron, as was said, will wholly exclude it from the new compound. The next point is to separate the lead from the copper; which is done by exposing the mass compounded of these two metals to a degree of fire strong enough to deprive the lead of its metalline form, but too weak to have the same effect on the copper: and this may be done, since of all the imperfect metals lead is, next to tin, the easiest to be calcined, and copper, on the contrary, resists the greatest force of fire longest, without losing its metalline form. Now what we gain by this exchange, *viz.* by separating copper from iron, and uniting it with lead, consists in this, that as lead is calcined with less fire than iron, the copper is less exposed to be destroyed: for it must be observed, that, however moderate the fire be, it is hardly possible to prevent a certain quantity thereof from being calcined in the operation.

Lead melted with a third part of tin forms a compound, which being exposed to a fire capable of making it thoroughly red hot, swells, puffs up, seems in some sort to take fire, and is presently calcined. These two metals mixed together are much sooner calcined than either of them separately.

Both lead and tin are in some measure affected by water, and by a moist air; but they are both much less subject than iron or copper to be corroded by these solvents, and of course are much less liable to rust.

The vitriolic acid acts upon and dissolves lead much in the same manner as it doth silver.

The nitrous acid dissolves this metal with much ease, and in great quantities; and from this solution a small portion of mercury may be obtained.

When this solution of lead is diluted with a good deal of water, the lead precipitates in the form of a white powder; which happens because the acid is rendered too weak to keep the lead dissolved.

If this solution of lead be evaporated to a certain degree, it shoots into crystals formed like regular pyramids with square bases. These crystals are of a yellowish colour, and of a saccharine taste: they do not easily dissolve in water. This nitrous metalline salt has the singular property of detonating in a crucible, without any addition, or the contact of any other inflammable substance. This property it derives from the great quantity of phlogiston contained in, and but loosely connected with the lead, which is one of its principles.

If spirit of salt, or even sea-salt in substance, be added to a solution of lead in the nitrous acid, a white precipitate immediately falls; which is no other than the lead united with the marine acid. This precipitate is extremely like the precipitate of silver made in the same manner; and that being called *luna cornea*, hath occasioned this to be named *plumbum corneum*. Like the *luna cornea*, it is very fusible, and, being melted, hardens like it into a kind of horny substance: it is volatile, and may be reduced by means of inflammable matters combined with alkalis. But it differs from the *luna cornea* in this chiefly, that it dissolves easily in water; whereas the *luna cornea*, on the contrary, dissolves therein with great difficulty, and in a very small quantity.

As this precipitation of lead from its solution in spirit of nitre is procured by the marine acid, lead is thereby proved to have a greater affinity with the latter acid than with the former. Yet, if you attempt to dissolve lead directly by the acid of sea-salt, the solution is not so easily effected as by the spirit of nitre, and it is always imperfect; for it wants one of the conditions essential to every solution in a liquor, namely transparency.

If lead be boiled for a long time in a lixivium of fixed alkali, part of it will be dissolved.

Sulphur renders this metal refractory and scarce fusible; and the mass they form when united together is friable. Hence it appears that sulphur acts upon lead much in the same manner as upon tin; that is, it renders both these metals less fusible, which are naturally the most fusible of any, while it exceedingly facilitates the fusion of silver, copper, and iron, metals which of themselves flow with the greatest difficulty.

### Of QUICK-SILVER.

WE treat of quick-silver in a chapter apart, because this metallic substance cannot be classed with the metals properly so called, and yet has some properties which

will not allow us to confound it with the semi metals. The reason why quick-silver, by the chemists commonly called mercury, is not reputed a metal, is, that it wants one of the essential properties thereof, *viz.* malleability. When it is pure and unadulterated with any mixture, it is always fluid, and of course unmallearable. But as, on the other hand, it eminently possesses the opacity, the splendor, and above all the gravity of a metal, being, next to gold, the heaviest of all bodies, it may be considered as a true metal, differing from the rest no otherwise than by being constantly in fusion; which we may suppose arises from its aptness to flow with such a small degree of heat, that be there ever so little warmth on earth, there is still more than enough to keep mercury in fusion; which would become solid and malleable if it were possible to apply to it a degree of cold considerable enough for that purpose. These properties will not allow us to confound it with the semi-metals. Add, that we are not yet assured by any undoubted experiment that it can be wholly deprived of its phlogiston, as the imperfect metals may. Indeed we cannot apply the force of fire to it as could be wished: for it is so volatile, that it flies off and exhales in vapours with a much less degree of fire than is necessary to make it red-hot. The vapours of mercury thus raised by the action of fire, being collected and united in a certain quantity, appear to be no other than true mercury retaining every one of its properties; and no experiment hath ever been able to shew the least change thus produced in its nature.

If mercury be exposed to the greatest heat that it can bear without sublimation, and continued in it for several months, or even a whole year together, it turns to a red powder, which the chemists call *mercurius precipitatus per se*. But to succeed in this operation, it is absolutely necessary that the heat be such as is above specified; for this metallic substance may remain exposed to a weaker heat for a considerable number of years, without undergoing any sensible alteration.

Some chemists fancied that by this operation they had fixed mercury, and changed its nature; but without any reason; for if the mercury thus seemingly transmuted be exposed to a somewhat stronger degree of fire, it sublimes and exhales in vapours as usual; and those vapours collected are nothing else but running mercury, which has recovered all its properties without the help of any addition.

Mercury has the property of dissolving all the metals, iron only excepted. But it is a condition absolutely necessary to the success of such dissolution, that the metallic substances be possessed of their phlogiston; for if they be calcined, mercury cannot touch them: and hence it follows, that mercury doth not unite with substances that are purely earthy. Such a combination of a metal with mercury is called an *amalgam*. Trituration alone is sufficient to effect it; however, a proper degree of heat also is of use.

Mercury amalgamated with a metal gives it a consistency more or less soft, and even fluid, according to the greater or smaller proportion of mercury employed. All amalgams are softened by heat, and hardened by cold.

Mercury is very volatile; vastly more so than the most

unfixed metals: moreover, the union it contracts with any metal is not sufficiently intimate to entitle the new compound resulting from that union to all the properties of the two substances united; at least with regard to their degree of fixity and volatility. From all which it follows, that the best and surest method of separating it from metals dissolved by it, is to expose the amalgam to a degree of heat sufficient to make all the quick-silver rise and evaporate; after which the metal remains in the form of a powder, and being fused recovers its malleability. If it be thought proper to save the quick-silver, the operation must be performed in close vessels, which will confine and collect the mercurial vapours. This operation is most frequently employed to separate gold and silver from the several sorts of earths and sands with which they are mixed in the ore; because these two metals, gold especially, are of sufficient value to compensate the loss of mercury, which is inevitable in this process: besides, as they very readily amalgamate with it, this way of separating them from every thing unmetallic is very commodious.

Mercury is dissolved by acids; but with circumstances peculiar to each particular acid.

The vitriolic acid concentrated and made boiling hot seizes on it, and presently reduces it to a kind of white powder, which turns yellow by the affusion of water, but does not dissolve in it: it is called *turbith mineral*. However, the vitriolic acid on this occasion unites with a great part of the mercury in such a manner that the compound is soluble in water. For if to the water which was used to wash the turbith a fixed alkali be added, there falls instantly a russet-coloured precipitate, which is no other than mercury separated from the vitriolic acid by the intervention of the alkali.

This dissolution of mercury by the vitriolic acid is accompanied with a very remarkable phenomenon; which is, that the acid contracts a strong smell of volatile spirit of sulphur: a notable proof that part of the phlogiston of the mercury hath united therewith. And yet, if the mercury be separated by means of a fixed alkali, it does not appear to have suffered any alteration. *Turbith mineral* is not so volatile as pure mercury.

The nitrous acid dissolves mercury with ease. The solution is limpid and transparent, and as it grows cold shoots into crystals, which are a nitrous mercurial salt.

If this solution be evaporated to dryness, the mercury remains impregnated with a little of the acid, under the form of a red powder, which hath obtained the names of *red precipitate*, and *arcannum corallinum*. This precipitate, as well as turbith, is less volatile than pure mercury.

If this solution of mercury be mixed with a solution of copper made likewise in the nitrous acid, and the mixture evaporated to dryness, there will remain a green powder called *green precipitate*. These precipitates are caustic and corrosive; and are used as such in surgery.

Though mercury be dissolved more easily and completely by the nitrous acid than by the vitriolic, yet it has a greater affinity with the latter than with the former; for if a vitriolic acid be poured into a solution of mercury in spirit of nitre, the mercury will quit the latter

ter

ter acid in which it was dissolved, and join the other which was added. The same thing happens when the marine acid is employed instead of the vitriolic.

Mercury combined with spirit of salt forms a singular body; a metalline salt which shoots into long crystals, pointed like daggers. This salt is volatile, and sublimes easily without decomposition. It is moreover the most violent of all the corrosives hitherto discovered by chemistry. It is called *corrosive sublimate*, because it must absolutely be sublimed to make the combination perfect. There are several ways of doing this: but the operation will never fail, if the mercury be rarefied into vapours and meet with the marine acid in a similar state.

Corrosive sublimate is dissolved by water, but in very small quantities only. It is decomposed by fixed alkalis, which precipitate the mercury in a reddish yellow powder, called, on account of its colour, *yellow precipitate*.

If corrosive sublimate be mixed with tin, and the compound distilled, a liquor comes over, which continually emits abundance of dense fumes, and from the name of its inventor is called the *smoking liquor of Libavius*. This liquor is no other than the tin combined with the marine acid of the corrosive sublimate, which therefore it hath actually decomposed: whence it follows, that this acid hath a greater affinity with tin than with mercury.

The marine acid in corrosive sublimate is not quite saturated with mercury; but is capable of taking up a much greater quantity thereof. For if corrosive sublimate be mixed with fresh mercury, and sublimed a second time, another compound will be produced containing much more mercury, and less acrimonious; for which reason it is named *sweet sublimate of mercury*. *mercurius dulcis*, *aquila alba*. This compound may be taken internally, and is purgative or emetic according to the dose administered. It may be rendered still more gentle by repeated sublimations, and then it takes the title of *panacea mercurialis*. No way hath hitherto been found to dissolve mercury in *aqua regis* without great difficulty, and even then it is but imperfectly dissolved.

Mercury unites easily and intimately with sulphur. If these two substances be only rubbed together in a gentle heat, or even without any heat, they will contract an union, though but an incomplete one. This combination takes the form of a black powder, which has procured it the name of *Ætiops mineral*.

If a more intimate and perfect union be desired, this compound must be exposed to a stronger heat; and then a red ponderous substance will be sublimed, appearing like a mass of shining needles: this is the combination desired, and is called *cinabar*. In this form chiefly is mercury found in the bowels of the earth. Cinabar finely levigated acquires a much brighter red colour, and is known to painters by the name of *vermilion*.

Cinabar rises wholly by sublimation, without suffering any decomposition; because the two substances of which it consists, *viz.* mercury and sulphur, are both volatile.

Though mercury unites and combines very well with sulphur, as hath been said, yet it hath less affinity with

that mineral than any other metal, gold only excepted: whence it follows, that any of the other metals will decompose cinabar, by uniting with its sulphur, and so setting the mercury at liberty to appear in its usual form. Mercury thus separated from sulphur, is esteemed the purest, and bears the name of *mercury revived from cinabar*.

Iron is generally used in this operation preferably to the other metals, because among them all it has the greatest affinity with sulphur, and is the only one that has none with mercury.

Cinabar may also be decomposed by means of fixed alkalis; the affinity of these salts with sulphur being generally greater than that of any metalline substance whatever.

## Of the SEMI-METALS.

### Of REGULUS of ANTIMONY.

REGULUS of antimony is a metallic substance of a pretty bright white colour. It has the splendor, opacity, and gravity of a metal; but it is quite unmanageable, and crumbles to dust, instead of yielding or stretching under the hammer; on which account it is classed with the semi-metals.

It begins to flow as soon as it is moderately red; but, like the other semi metals it cannot stand a violent degree of fire; being thereby dissipated into smoke and white vapours, which adhere to such cold bodies as they meet with, and so are collected into a kind of *farina* called *flowers of antimony*.

If regulus of antimony, instead of being exposed to a strong fire, be only heated so moderately that it shall not even melt, it will calcine, lose its phlogiston, and take the form of a greyish powder destitute of all splendor: this powder is called *calx of antimony*.

This calx is not volatile like the regulus, but will endure a very violent fire; and being exposed thereto will flow, and turn to a glass of the yellowish colour of a hyacinth.

It is to be observed, that the more the regulus is deprived of its phlogiston by continued calcination, the more refractory is the calx obtained from it. The glass therefore has also so much the less colour, and comes the nearer to common glass.

The calx and the glass of antimony will recover their metalline form, like every other calx and glass of a metal, if reduced by restoring to them their lost phlogiston. Yet, if the calcination be carried too far, their reduction will become much more difficult, and a much smaller quantity of regulus will be resuscitated.

Regulus of antimony is capable of dissolving the metals; but its affinities with them are various, and differ according to the following order. It affects iron the most powerfully, next copper, then tin, lead, and silver. It promotes the fusion of metals, but makes them all brittle and unmanageable.

It will not amalgamate with mercury; and though, by certain processes, particularly the addition of water and continued trituration, a sort of union between these two sub-

stances may be produced, yet it is but apparent and momentary; for being left to themselves, and undisturbed, they quickly disunite and separate.

The vitriolic acid, assisted by heat, and even by distillation, dissolves regulus of antimony. The nitrous acid likewise attacks it; but the solution can by no art be made clear and limpid; so that the regulus is only calcined, in a manner, by this acid.

The marine acid dissolves it well enough; but then it must be exceedingly concentrated, and applied in a peculiar manner, and especially by distillation. One of the best methods of procuring a perfect union between the acid of sea-salt and regulus of antimony, is to pulverize the latter, mix it with corrosive sublimate, and distil the whole. There rises in the operation a white matter, thick, and scarce fluid, which is no other than the regulus of antimony united and combined with the acid of sea-salt. This compound is extremely corrosive, and is called *butter of antimony*.

It is plain, that the corrosive sublimate is here decomposed; that the mercury is revived; and that the acid which was combined therewith hath quitted it to join the regulus of antimony, with which its affinity is greater. This butter of antimony, by repeated distillations, acquires a considerable degree of fluidity and limpidness.

If the acid of nitre be mixed with butter of antimony, and the whole distilled, there rises an acid liquor, or a sort of *aqua regis*, which still retains some of the dissolved regulus, and is called *bezoardic spirit of nitre*. After the distillation there remains a white matter, from which fresh spirit of nitre is again abstracted, and which being then washed with water, is called *bezoar mineral*. This bezoar mineral is neither so volatile, nor so caustic, as butter of antimony; because the nitrous acid hath not the property of volatilizing metallic substances, as the marine acid does, and because it remains much more intimately combined with the reguline part.

If butter of antimony be mixed with water, the liquor immediately becomes turbid and milky, and a precipitate falls, which is nothing but the metallic matter partly separated from its acid, which is too much weakened by the addition of water to keep it dissolved. Yet this precipitate still retains a good deal of acid; for which reason it continues to be a violent emetic, and in some degree corrosive. It hath therefore been very improperly called *mercurius vitæ*.

The proper solvent of regulus of antimony is *aqua regis*; by means whereof a clear and limpid solution of this semi-metal may be obtained.

Regulus of antimony mixed with nitre, and projected into a red-hot crucible, sets the nitre in a flame, and makes it detonate. As it produces this effect by means of its phlogiston, it must needs, at the same time, be calcined, and lose its metallic properties, which accordingly happens: and when the nitre is in a triple proportion to the regulus, the latter is so perfectly calcined as to leave only a white powder, which is fused with great difficulty, and then turns to a faintly coloured glass, not very different from common glass, and which is not reducible to a regulus by the addition of inflammable matter; at least it yields but a very small quantity thereof. If less nitre

be used, the calx is not so white; the glass it produces is more like a metalline glass, and is more easily reduced. The calx of the regulus thus prepared by nitre is called, on account of the medicinal virtue ascribed to it, *diaphoretic antimony*, or *diaphoretic mineral*.

Nitre always becomes an alkali by desagrivation, and in the present case retains part of the calx, which it even renders soluble in water. This calx may be separated from the alkali, if an acid be employed to precipitate it; and then it is called *materia perlata*. This pearly matter is a calx of antimony, so completely deprived of its phlogiston as to be altogether incapable of reduction to a regulus.

Regulus of antimony readily joins and unites with sulphur, forming therewith a compound which has a very faint metallic splendor. This compound appears like a mass of long needles adhering together laterally; and under this form it is usually found in the ore, or at least when only separated by fusion from the stones and earthy matters with which the ore is mixed. It is called *crude antimony*.

Antimony flows with a moderate heat, and becomes even more fluid than other metallic substances. The action of fire dissipates or consumes the sulphur it contains, and its phlogiston also, so as to convert it into a calx and a glass, as it does the regulus.

*Aqua regis*, which we observed to be the proper solvent of the regulus, being poured on antimony, attacks and dissolves the reguline part, but touches not the sulphur; in consequence whereof it decomposes the antimony, and separates its sulphur from its regulus.

There are several other ways of effecting this decomposition, and obtaining the reguline part of antimony by itself: They consist either in destroying the sulphureous part of the antimony by combustion, or in melting the antimony with some substance which has a greater affinity than its reguline part with sulphur. Most metals are very fit for this latter purpose: For though the regulus has a considerable affinity with sulphur, yet all the metals, except gold and mercury, have a greater.

If therefore iron, copper, lead, silver, or tin, be melted with antimony, the metal employed will unite with the sulphur, and separate it from the regulus.

It must be observed, that, as these metals have some affinity with the regulus of antimony, the regulus will be joined in the operation by some of the metal employed as a precipitant, (so those substances are called which serve as the means of separating two bodies from each other;) and therefore the regulus procured in this manner will not be absolutely pure: On this account care is taken to distinguish each by adding the name of the metal employed in its precipitation; and thence come these titles, *martial regulus of antimony*, or only *martial regulus*, *regulus veneris*; and so of the rest.

Antimony is employed with advantage to separate gold from all other metals with which it may be alloyed. It has been shewn, that all the metals have a greater affinity, than the reguline part of antimony, with sulphur, gold only excepted; which is incapable of contracting any union therewith: And therefore, if a mass compounded of gold and several other metals be melted with anti-

antimony, every thing in that mass which is not gold will unite with the sulphur of the antimony. This union occasions two separations, to wit, that of the sulphur of the antimony from its reguline part, and that of the gold from the metals with which it was adulterated; and from the whole two new compounds arise; namely, a combination of the metals with the sulphur, which being lightest rises to the surface in fusion; and a metalline mass formed of the gold and the reguline part of the antimony united together, which being much the heaviest sinks to the bottom. There is no difficulty in parting the gold from the regulus of antimony with which it is alloyed: For the metalline mass need only be exposed to a degree of fire capable of dissipating into vapours all the semi-metal it contains; which being very volatile, the operation is much easier, and more expeditiously finished, than if the metals with which the gold was debased were to be vitrified on the cupel; without taking into the account that if silver were one of them, recourse must needs be had to the process of quartation after that of the cupel.

If equal parts of nitre and antimony be mixed together, and the mixture exposed to the action of fire, a violent detonation ensues; the nitre deflagrating consumes the sulphur of the antimony, and even a part of its phlogiston. After the detonation there remains a greyish matter which contains fixed nitre, vitriolated tartar, and the reguline part of the antimony in some measure deprived of its phlogiston, and half vitrified by the action of the fire, which is considerably increased by the deflagration. This matter is called *liver of antimony*.

If instead of equal parts of nitre and antimony, two parts of the former be used to one of the latter, then the reguline part loses much more of its phlogiston, and remains in the form of a yellowish powder.

Again, if three parts of nitre be taken to one of antimony, the regulus is thereby entirely robbed of its phlogiston, and converted to a white calx which bears the name of *diaphoretic antimony*, or *diaphoretic mineral*. The pearly matter may be precipitated by pouring an acid on the saline substances which here remain after the detonation, in the same manner as we shewed above was to be done with regard to the regulus.

In the last two operations, where the nitre is in a double or triple proportion to the antimony, the reguline part is found after the detonation to be converted into a calx, and not into a half vitrified matter, which we have seen is the effect when equal parts only of nitre and antimony are used. The reason of this difference is, that in these two cases the reguline part, being wholly, or almost wholly, deprived of its phlogiston, becomes, as was observed, more difficult to fuse, and consequently cannot begin to vitrify in the same degree of heat as that which hath not lost so much of its phlogiston. If, instead of performing the operation with equal parts of nitre and antimony alone, a portion of some substance which abounds with phlogiston be added, in that case the sulphur only of the antimony will be consumed, and the regulus will remain united with its phlogiston, and separated from its sulphur.

VOL. II. Numb. 33.

3

The regulus prepared in this manner is absolutely pure, because no metalline substance being employed, none can mix with it and adulterate it. It is called *regulus of antimony per se*, or only *regulus of antimony*.

It is true indeed, that in this operation, much of the reguline part unavoidably loses its phlogiston and is calcined, and consequently a much smaller quantity of regulus is obtained than when metalline precipitants are employed: But this loss is easily repaired, if it be thought proper, by restoring to the calcined part its lost phlogiston.

Antimony melted with two parts of fixed alkali yields no regulus, but is entirely dissolved by the salt, and forms with it a mass of a reddish yellow colour.

The reason why no precipitate is produced on this occasion is, that the alkali uniting with the sulphur of the antimony forms therewith the combination called *liver of sulphur*, which by its nature is qualified to keep the reguline part dissolved. This mass, formed by the union of the antimony with the alkali, is soluble in water. If any acid whatever be dropt into this solution, there falls a precipitate of a reddish yellow colour; because the acid unites with the alkali, and forces it to quit the matters with which it is combined. This precipitate is called *golden sulphur of antimony*.

As in the operation for preparing regulus of antimony *per se*, some of the nitre is, by the inflammable matters added thereto, turned to an alkali; this alkali seizes on part of the antimony, and therewith forms a compound like that just described. Hence it comes, that if the scoria formed in this process be dissolved in water, and an acid dropped into the solution, a true golden sulphur of antimony is thereby separated.

This union of antimony with an alkali may also be brought about by the humid way; that is, by making use of an alkali resolved into a liquor, and boiling the mineral in it. The alkaline liquor, in proportion as it acts upon the antimony, gradually becomes reddish and turbid. If left to settle and cool, when well saturated therewith, it gradually deposits the antimony it had taken up, which precipitates in the form of a red powder: And this precipitate is the celebrated remedy known by the name of *kermes mineral*. It is plain, that the kermes is nearly the same thing with the golden sulphur: Yet it differs from it in some respects; and especially in this, that being taken inwardly it operates much more gently than the golden sulphur, which is a violent emetic. Nitre, fixed by charcoal, and resolved into a liquor, is the only alkali employed in preparing the kermes.

It was shewn above, that regulus of antimony, mixed and distilled with corrosive sublimate, decomposes it, disengages the mercury, and joining itself to the marine acid forms therewith a new combination, called *butter of antimony*. If the same operation be performed with crude antimony instead of its regulus, the same effects are produced; but then the antimony itself is also decomposed; that is, the reguline part is separated from the sulphur, which being set free unites with the mercury, now also at liberty, and these two together form a true cinabar, called *cinubar of antimony*.

†

Z

of

*Of BISMUTH.*

BISMUTH, known also by the name *tin-glass*, is a semi-metal, having almost the same appearance as regulus of antimony; yet it has a more dusky cast, inclining somewhat to red, and even presents some changeable streaks, especially after lying long in the air.

When exposed to the fire it melts long before it is red, and consequently with less heat than regulus of antimony, which does not flow, as was shewn above, till it begin to be red hot. It becomes volatile, like all the other semi-metals, when acted on by a violent fire: Being kept in fusion by a proper degree of heat it loses its phlogiston with its metallic form, and turns to powder or a calx; and that again is converted into glass by the continued action of fire. The calx and glass of bismuth may be reduced, like any other metallic calx, by restoring their phlogiston.

Bismuth mixes with all the metals in fusion, and even facilitates the fusion of such as do not otherwise flow readily. It whitens them by its union, and destroys their malleability.

It amalgamates with mercury, if they be rubbed together with the addition of water: Yet after some time these two metalline substances desert each other, and the bismuth appears again in the form of a powder. Hence it is plain that the union it contracts with mercury is not perfect; and yet it has the singular property of attenuating lead, and altering it in such a manner that it afterwards amalgamates with mercury much more perfectly, so as even to pass with it through shamoy leather without any separation. The bismuth employed in making this amalgama afterwards separates from it spontaneously, as usual; but the lead still continues united with the mercury, and always retains the property thus acquired.

The vitriolic acid does not dissolve bismuth: Its proper solvent is the nitrous acid, which dissolves it with violence, and abundance of fumes.

Bismuth dissolved in the nitrous acid is precipitated not only by alkalis, but even by the bare addition of water. This precipitate is extremely white, and known by the name of *magistry of bismuth*.

The acid of sea-salt and *aqua regis* likewise act upon bismuth, but with less violence.

This semi-metal does not sensibly deslagrate with nitre: yet it is quickly deprived of its phlogiston, and turned into a vitrifiable calx, when exposed with it to the action of fire.

It readily unites with sulphur in fusion, and forms therewith a compound which appears to consist of needles adhering laterally to each other.

It may be separated from the sulphur with which it is combined, by only exposing it to the fire, without any additament; for the sulphur is either consumed or sublimed, and leaves the bismuth behind.

*Of ZINC.*

ZINC to appearance differs but little from bismuth, and has even been confounded with it by several authors. Nevertheless, besides that it has something of a bluish cast, and is harder than bismuth, it differs from it es-

pecially in its properties, as will presently be shewn. These two metallic substances scarce resemble each other in any thing, but the qualities common to all semi-metals.

Zinc melts the moment it grows red in the fire, and then also begins to turn to a calx, which, like any other metallic calx, may be reduced by means of the phlogiston: But if the fire be considerably increased, it sublims, flames, and burns like an oily matter; which is a proof of the great quantity of phlogiston in its composition. At the same time abundance of flowers rise from it in the form of white flakes, flying about in the air like very light bodies; and into this form may the whole substance of the zinc be converted. Several names have been given to these flowers, such as *pompholix*, *philosophic wool*. They are supposed to be no other than the zinc itself deprived of its phlogiston; yet no body has hitherto been able to resuscitate them in the form of zinc, by restoring their phlogiston according to the methods used in the reduction of metals. Though they rise in the air with very great ease while the zinc is calcining, yet when once formed they are very fixed; for they withstand the utmost violence of fire, and are capable of being vitrified, especially if joined with a fixed alkali. They are soluble in acids.

Zinc unites with all metalline substances, except bismuth. It has this singular property, that being mixed with copper, even in a considerable quantity, such as a fourth part, it does not greatly lessen the ductility thereof, and at the same time communicates to it a very beautiful colour not unlike that of gold: On which account the composition is frequently made, and produces what is called *brass*. This metal melts much more easily than copper alone, because of the zinc with which it is alloyed. If it be exposed to a great degree of heat, the zinc which it contains takes fire, and sublims in white flowers, just as when it is pure.

It is to be observed, that brass is ductile only while it is cold, and not then unless the zinc used in making it was very pure; otherwise the composition will prove but *tombac*, or *prince's metal*, having very little malleability.

Zinc is very volatile, and carries off with it any metallic substance with which it is fused, making a kind of sublimate thereof. In the furnaces where they smelt ores containing zinc, the matter thus sublimed is called *cadmia fornacum*, to distinguish it from the native cadmia called also *calamine*, or *lapis calaminaris*; which, properly speaking, is an ore of zinc, containing a great deal of that semi-metal, together with some iron, and a stony substance. The name of *cadmia fornacum* is not appropriated solely to the metallic sublimate procured by means of zinc, but is given in general to all the metallic sublimate found in smelting-houses.

If a violent and sudden heat be applied to zinc, it sublims in its metalline form; there not being time for it to burn and be resolved into flowers.

This semi-metal is soluble in all the acids, but especially in spirit of nitre, which attacks and dissolves it with very great violence.

Zinc has a greater affinity than iron or copper with the vitriolic acid; and therefore it decomposes the green and blue vitriols, precipitating these two metals by



by uniting with the vitriolic acid, with which it forms a metallic salt or vitriol called *white vitriol*, or *vitriol of zinc*.

Nitre mixed with zinc, and projected into a red hot crucible, detonates with violence; and during the detonation there arises a great quantity of white flowers, like those which appear when it is declined by itself.

Sulphur has no power over zinc. Even liver of sulphur, which dissolves all other metallic substances, contracts no union with this semi-metal.

#### Of REGULUS of ARSENIC.

REGULUS of arsenic is the most volatile of all the semi-metals. A very moderate heat makes it wholly evaporate, and fly off in fumes; on which account it cannot be brought to fusion, nor can any considerable masses thereof be obtained. It has a metallic colour, somewhat resembling lead; but soon loses its splendor when exposed to the air.

It unites readily enough with metallic substances, having the same affinities with them as regulus of antimony hath. It makes them brittle, and un-malleable. It hath also the property of rendering them volatile, and greatly facilitates their scorification.

It very easily parts with its phlogiston and metallic form. When exposed to the fire it rises in a kind of shining crystalline calx, which on that account looks more like a saline matter than a metallic calx. To this calx or these flowers are given the names of *white arsenic*, *crystalline arsenic*, and most commonly plain *arsenic*.

Arsenic differs from every other metalline calx, first, in being volatile; whereas the calxes of all other metallic substances, not excepting those of the most volatile semi-metals, such as regulus of antimony and zinc, are exceedingly fixed; and secondly, in having a saline character, which is not found in any other metalline calx.

The saline character of arsenic appears, first, from its being soluble in water; secondly, from its corrosive quality, which makes it one of the most violent poisons: a quality from which the other metallic substances are free, when they are not combined with some saline matter. Regulus of antimony must however be excepted: but then the best chemists agree, that this semi-metal is either nearly of the same nature with arsenic, or contains a portion thereof in its composition: besides, its noxious qualities never discover themselves so plainly as when it is combined with some acid. Lastly, arsenic acts just like the vitriolic acid upon nitre; that is, it decomposes that neutral salt, by expelling its acid from its alkaline basis, of which it takes possession, and therewith forms a new saline compound.

This combination is a species of salt that is perfectly neutral. When the operation is performed in a close vessel, the salt shoots into crystals in the form of right-angled quadrangular prisms, terminated at each extremity by pyramids that are also quadrangular and right-angled; some of which, however, instead of ending in a point, are obtuse as if truncated. The consequence is different when the operation is performed in an open vessel; for

then nothing is obtained but an alkaline salt impregnated with arsenic, which cannot be crystallized.

The cause of this different effect is this: When the arsenic is once engaged in the alkaline basis of the nitre, it can never be separated from it by the utmost force of fire, so long as it is kept in a close vessel; whereas, if you expose it to the fire without that precaution, it readily separates from it.

This salt possesses many singular properties, the chief of which are these: First, it cannot be decomposed by the intervention of any acid, even the strongest acid of vitriol; and this, joined to its property of expelling the nitrous acid from its basis, shews that it has a very great affinity with fixed alkalis.

Secondly, this very salt, on which pure acids have no effect, is decomposed with the greatest ease by acids united with metallic substances. The reason of this phenomenon is curious, and furnishes us with an instance of what we advanced concerning double affinities.

If to a solution of any metallic substance whatever, made by any acid whatever, (except that of mercury by the marine acid, and that of gold by *aqua regis*,) a certain quantity of this salt dissolved in water be added, the metallic substance is instantaneously separated from the acid in which it was dissolved, and falls to the bottom of the liquor.

All metallic precipitates obtained in this manner are found to be a combination of the metal with arsenic; whence it necessarily follows that the neutral salt is by this means decomposed, its arsenical part uniting with the metallic substance, and its alkaline basis with the acid in which that substance was dissolved.

The affinities of these several bodies must be considered as operating on this occasion in the following manner: The acids which tend to decompose the neutral salt of arsenic, by virtue of their affinity with its alkaline basis, are not able to accomplish it, because this affinity is powerfully counteracted by that which the arsenic has with the same alkaline basis, and which is equal or even superior to theirs. But if these acids happen to be united with a substance which naturally has a very great affinity with the arsenical part of the neutral salt, then, the two parts of which this salt consists, being drawn different ways by two several affinities, tending to separate them from each other, the salt will undergo a decomposition, which could not have been effected without the help of this second affinity. Now, as metallic substances have a great affinity with arsenic, it is not surprising that the neutral salt of arsenic, which cannot be decomposed by a pure acid, should nevertheless yield to an acid combined with a metal. The decomposition of this salt, therefore, and the precipitation which of course it produces in metallic solutions, are brought about by the means of a double affinity; namely, that of the acid with the alkaline basis of the neutral salt, and that of the metal with the arsenical part of that salt.

Arsenic has not the same effect on sea-salt as on nitre, and cannot expel its acid: a very singular phenomenon, for which it is hard to assign a reason; for the nitrous acid

acid is known to have a greater affinity than the marine acid with alkalis, and even with the basis of sea-salt itself.

Yet arsenic may be combined with the basis of sea-salt, and a neutral salt thereby obtained, like that which results from the decomposition of nitre by arsenic: but for that purpose a quadrangular nitre must be first prepared, and arsenic applied thereto as to common nitre.

The salt produced by uniting arsenic with the basis of sea-salt very much resembles the neutral salt of arsenic above treated of, as well in the figure of its crystals as in its several properties.

Arsenic presents another singular phenomenon, both with the alkali of nitre and with that of sea-salt; which is, that if it be combined with these salts in a fluid state, it forms with them a saline compound, quite different from the neutral salts of arsenic which results from the decomposition of nitrous salts.

This saline compound, called *liver of arsenic*, takes up a much greater quantity of arsenic than is necessary for the perfect saturation of the alkali. It has the appearance of a glue, which is so much the thicker the more arsenic it contains. Its smell is disagreeable; it attracts the moisture of the air, and does not crystallize; it is easily decomposed by any acid whatever, which precipitates the arsenic and unites with the alkali. Lastly, the effects it produces on metallic solutions are different from those of our neutral arsenical salts.

Arsenic is easily reduced to a regulus. It need only be mixed with any matter containing the phlogiston, and by the help of a moderate heat a true regulus will sublime. This regulus is very volatile, and calcines with the greatest ease; which is the reason why it cannot be obtained but in small quantities; and also why, in order to obtain masses of it, some have thought of adding thereto some metal with which it has a great affinity, such as copper or iron; because, by joining with the metal, it is partly fixed and restrained from flying off. But it is plain the regulus obtained by this means is not pure, as it must partake considerably of the metal employed.

Arsenic readily unites with sulphur, and rises with it in a yellow compound called *orpiment*.

Sulphur cannot be separated from arsenic but by the intervention of two bodies only; to wit, a fixed alkali and mercury.

The property which mercury possesses of separating sulphur from arsenic is founded on this, that these two metallic substances are incapable of contracting any union; whereas, though most of the other metals and semi-metals have a greater affinity with sulphur than mercury hath, nevertheless they are all unable to decompose orpiment; because some of them have as great an affinity with arsenic as with sulphur; others have no affinity with either; and lastly, sulphur hath as great an affinity with arsenic as with any of them.

It must be observed, that, if fixed alkalis be employed to purify arsenic in this manner, no more must be used than is necessary to absorb the sulphur or the phlogiston, of which also it is their nature to deprive arsenic; for otherwise, as it has been shewn that arsenic readily unites

with alkalis, they would absorb a considerable quantity thereof.

### Of OIL in general.

OIL is an unctuous body, which burns and consumes with flame and smoke, and is not soluble in water. It consists of the phlogiston united with water by means of an acid. There is, moreover, in its composition a certain proportion of earth, more or less according to each several sort of oil.

The inflammability of oil evidently proves that it contains the phlogiston. That an acid is one of its constituent principles many experiments demonstrate, of which these are the chief: If certain oils be long triturated with an alkaline salt, and the alkali afterwards dissolved in water, crystals of a true neutral salt will be produced: some metals, and particularly copper, are corroded and rusted by oils, just as they are by acids: again, acid crystals are found in some oils that have been long kept. This acid in oil serves undoubtedly to unite its phlogiston with its water; because these two substances having no affinity with each other cannot be united without the intervention of such a medium as an acid, which has an affinity with both. As to the existence of water in oils, it appears plainly when they are decomposed by repeated distillations, especially after mixing them with absorbent earths. Lastly, when an oil is destroyed by burning, a certain quantity of earth is constantly left behind.

Oils exposed to the fire in close vessels pass over almost wholly from the containing vessel into any other applied to receive them. There remains, however, a small quantity of black matter, which is extremely fixed, and continues unalterable as long as it has no communication with the external air, be the force of the fire ever so violent. This matter is no other than part of the phlogiston of the oil united with its most fixed and grossest earth; and this is what we called *charcoal*, or plainly a *coal*.

### Of CHARCOAL.

WHEN oil happens to be united to much earth, as it is in vegetable and animal bodies, it leaves a considerable quantity of *coal* or charred matter.

This coal, exposed to the fire in the open air, burns and wastes, but without blazing like other combustible matters: there appears only a small bluish flame, but not the least smoke. Most commonly it only glows and sparkles, and so gradually falls into ashes, which are nothing but the earth of the body combined with an alkaline salt in burning. This alkaline salt may be separated from the earth, by lixiviating the ashes with water, which dissolves all the salt, and leaves the earth quite pure.

Charcoal is unalterable and indestructible by any other body but fire; whence it follows, that when it is not actually kindled and ignited, the most powerful agents, such as the acids, though ever so strong and concentrated, have not the least effect on it.

The case is otherwise when it is lighted, that is, when its phlogiston begins to separate from its earth; for then the pure acid of vitriol being joined therewith contracts

an instantaneous union with its phlogiston, and evaporates in a volatile sulphureous spirit. If the vitriolic acid, instead of being applied quite pure, be first clogged with some basis, especially an alkaline one, it quits that basis, enters into a more intimate union with the phlogiston of the burning coal, and so forms an actual sulphur, with which the alkali now unites and forms a hepar.

The pure acid sea-salt hath not been observed to act in the least upon charcoal, especially when it is not on fire. But when this acid is incorporated with an alkaline or metallic basis, and combined according to a peculiar process with burning charcoal, it in like manner quits its basis, unites with the phlogiston, and therewith forms a phosphorus.

Nor has the pure nitrous acid any effect on a charred coal, even when ignited: and so far is it from being able to kindle a cold one, that when poured on a live one, it extinguishes it like water. But when this acid is united with a basis, it quits it rapidly as soon as it touches a burning coal, and rushes violently into an union with the phlogiston thereof. From this union there probably arises, as we said before, a kind of sulphur or phosphorus, which is so inflammable as to be destroyed by the fire the very moment it is generated.

The acids of nitre and vitriol act upon oils; but very differently, according to the quantity of phlegm they contain. If they be awakened with much water, they have no effect at all upon oils: if they contain little water, or be dephlegmated to a certain degree, they dissolve them with heat, and with them form compounds of a thick consistence. Acids thus combined in a considerable proportion with oils render them soluble in water.

#### Of SOAP.

ALKALIS also have the same property. When an oil is combined with an acid, or an alkali, in such a manner that the compound resulting from their union is soluble in water; such a compound may in general be called *soap*. Soap itself hath the property of rendering fat bodies in some measure soluble in water; on which account it is very useful for scouring or cleansing any thing greasy.

Oily and saline substances, combined together, observe the same general rules as all other combinations; that is, they mutually communicate the properties belonging to each: thus oils, which naturally are not soluble in water, acquire by their union with saline matters the property of dissolving therein; and salts lose by their conjunction with oils part of their natural tendency to incorporate with water; so that while they serve to constitute soap, they do not, as before, attract the moisture of the air, &c. and in like manner, as they are not inflammable, they considerably lessen the inflammability of the oils combined with them.

Acid soaps are decomposed by alkalis, as alkaline soaps are by acids, according to the general rules of affinity.

The acids of nitre and vitriol, when highly concentrated, dissolve oils with such violence as to heat them, make them black, burn them, and even set them on fire. How sea-salt affects oils is not yet sufficiently ascertained.

All oils have the property of dissolving sulphur; which

is not at all surprising, seeing each of its component principles hath an affinity with oil.

It is also a property common to all oils to become more fluid, subtile, light, and limpid, the oftener they are distilled. On the contrary, by being incorporated with saline substances they acquire a greater consistence, and sometimes form compounds that are almost solid.

#### Of the several sorts of OILS.

OILS are distinguished by the substances from which they are drawn: and as oils are extracted from minerals, from vegetables, and from animals, there are of course mineral, vegetable, and animal oils.

#### Of MINERAL OILS.

IN the bowels of the earth we find but one sort of oil, called *petroleum*: Its smell is strong, and not disagreeable, and its colour sometimes more, sometimes less yellow. There are certain mineral substances which yield by distillation a great deal of oil very like petroleum. This sort of substance is called a *bitumen*, and is, indeed, nothing but an oil rendered consistent and solid by being combined with an acid; as appears from hence that, by uniting petroleum with the acid of vitriol, we can produce an artificial bitumen very like the native.

#### Of VEGETABLE OILS.

VEGETABLE substances yield a very great quantity and variety of oils; for there is not a plant, or part of a plant, that does not contain one or more sorts thereof, generally peculiar to itself, and different from all others.

By expression only, that is, by bruising and squeezing vegetable substances, particularly certain fruits and seeds, a sort of oil is obtained which has scarce any smell or taste. Oils of this sort are very mild and unctuous; and, because in this respect they resemble animal fat more than the rest do; they are called *fat oils*.

These oils, being exposed to the air for some time, sooner or later grow thick, acquire an acrid taste, and a strong disagreeable smell. Some of them congeal with the smallest degree of cold. This sort of oil is well adapted to dissolve those preparations of lead called *litharge* and *minium*, with which they form a thick tenacious substance, that is used for the basis of almost all plasters. They also dissolve lead in its metalline form, but not so easily as the sorts of calx above-mentioned; probably because its body is not so much opened, nor its parts so divided.

By expression alone we also procure from certain vegetable substances another sort of oil, which is thin, limpid, volatile, of a pungent taste, and retains the smell of the vegetable that yielded it; on which account it is called an *essential oil*. Of this there are several sorts, differing from one another, like the fat oils, according to the subjects from which they are obtained.

We must observe, that it is very difficult, or rather in most cases impossible, to force from the greatest part of vegetables, by expression only, all the essential oil they contain.

contain. For this purpose, therefore, recourse must be had to fire: a gentle heat, not exceeding that of boiling water, will extract all the essential oils of a vegetable; and this is the most usual and most convenient way of procuring them.

The fat oils cannot be obtained by the same method: these being much less volatile than the essential oils, require a much greater degree of heat to raise them; which, nevertheless, they cannot bear without being much spoiled; and entirely changed in their nature, as shall presently be shewn. All oils, therefore, which rise with the heat of boiling water, and such alone, should be called essential oils.

Essential oils, in a longer or shorter time, according to the nature of each, lose the fragrant smell they had when newly distilled, and acquire another which is strong, rancid, and much less agreeable: They also lose their tenuity, becoming thick and viscid; and in this state they greatly resemble those substances abounding in oil which flow from certain trees, and which are called *balsams* or *resins*, according as they are less or more consistent.

Balsams and resins are not soluble in water. But there are other oily compounds which likewise run from trees; and, though not unlike resins, are however soluble in water. These are called *gums*; and their property of dissolving in water arises from their containing more water and more salt than resins have; or at least their saline parts are less clogged and more disengaged.

Balsams and resins distilled with the heat of boiling water yield great quantities of a limpid, subtile, odoriferous, and, in one word, essential oil. In the still there remains a substance thicker and more consistent than the balsam or resin was before distillation. The same thing happens to essential oils which by length of time have acquired consistency, and are grown resinous. If they be redistilled, they recover their former tenuity, leaving behind them a remainder thicker and more resinous than they themselves were. This second distillation is called the *rectification* of an oil.

It must be observed, that an essential oil, combined with an acid strong enough to dissolve it, immediately becomes as thick and resinous, in consequence of this union, as if it had been long exposed to the air: which proves the consistence an oil acquires by long keeping to be owing to this, that its lightest and less acid parts being evaporated, the proportion of its acid to the remainder is so increased, that it produces therein the same change as an additional acid mixed with the oil would have wrought before the evaporation.

This also shews us, that balsams and resins are only essential oils combined with a great proportion of acid, and thereby thickened.

If vegetable substances, from which no more essential oil can be drawn by the heat of boiling water, be exposed to a stronger heat, they yield an additional quantity of oil; but it is thicker and heavier than the essential oil. These oils are black, and have a very disagreeable burnt smell which hath made them be called *fetid*, or *empyreumatic* oils. They are moreover very acrid.

It must be observed, that if a vegetable substance be exposed to a degree of heat greater than that of boiling

water, before the fat or the essential oil is extracted from it, an empyreumatic oil only will then be obtained; because both the fat and essential oils, when exposed to the force of fire, are thereby burnt, rendered acrid, acquire a smell of the fire, and, in a word, become truly empyreumatic. There is ground to think, that an empyreumatic oil is nothing else but an essential or fat oil burnt and spoiled by the fire, and that no other oil besides these two exists naturally in vegetables.

Empyreumatic oils, distilled and rectified several times by a gentle heat, acquire by every distillation a greater degree of tenuity, lightness, and limpidity. By this means also they lose something of their disagreeable odour; so that they gradually come nearer and nearer to the nature of essential oils: and if the rectifications be often enough repeated, ten or twelve times for instance, they become perfectly like those oils: except that their smell will never be so agreeable, nor like that of the substances from which they were obtained.

Fat oils may also be brought by the same means to resemble essential oils: but neither essential nor empyreumatic oils are capable of acquiring the properties of fat oils.

#### Of ANIMAL OILS.

DISTILLATION procures us considerable quantities of oil from all the parts of animal bodies, and especially from their fat. This oil at first is not very fluid, and is extremely fetid; but by many rectifications it gradually acquires a great degree of clearness and tenuity, and at the same time loses much of its disagreeable odour.

#### Of FERMENTATION in general.

BY fermentation is meant an intestine motion, which, arising spontaneously among the insensible parts of a body, produces a new disposition and a different combination of those parts.

To excite a fermentation in a mixt body, it is necessary, first, that there be in the composition of that mixt a certain proportion of watery, saline, oily, and earthy parts; but this proportion is not yet sufficiently ascertained. Secondly, it is requisite that the body to be fermented be placed in a certain degree of temperate heat; for much cold obstructs fermentation, and too much heat decomposes bodies. Lastly, the concurrence of the air is also necessary to fermentation.

All vegetable and animal substances are susceptible of fermentation, because all of them contain in a due proportion the principles above specified. However, many of them want the proper quantity of water, and cannot ferment while they remain in such a state of driness. But it is easy to supply that defect.

With respect to minerals properly so called, they are not subject to any fermentation, at least that our senses can perceive.

There are three sorts of fermentation, distinguished from one another by their several productions. The first produces wines and spiritous liquors; for which reason it is called the *winous* or *spiritous fermentation*: The result of the second is an acid liquor; and therefore it is called

called the *acetous fermentation*: and the third generates an alkaline salt; which, however, differs from the alkaline salts hitherto treated of, in this respect chiefly, that, instead of being fixed, it is extremely volatile: This last sort takes the name of the *putrid* or *putrefactive fermentation*. We shall now consider these three sorts of fermentation and their effects a little more particularly.

These three sorts of fermentation may take place successively in the same subject; which proves them to be only three different degrees of fermentation, all proceeding from one and the same cause. These degrees of fermentation always follow the order in which we have here placed them.

### Of the SPIRITUOUS, or VINOUS FERMENTATION.

THE juices of almost all fruits, all saccharine vegetable matters, all farinaceous seeds and grains of every kind, being diluted with a sufficient quantity of water, are proper subjects of spirituous fermentation. If such liquors be exposed, in vessels slightly stopped, to a moderate degree of heat, they begin in some time to grow turbid; there arises insensibly a small commotion among their parts, attended with a hissing noise; this by little and little increases, till the grosser parts appear, like little seeds or grains, moving to and fro, agitated among themselves, and thrown up to the surface. At the same time some air-bubbles rise, and the liquor acquires a pungent, penetrating smell, occasioned by the very subtiler vapours which exhale from it.

These vapours have never yet been collected, in order to examine their nature; and they are known only by their noxious effects. They are so actively pernicious, that if a man comes rashly into a close place, where large quantities of liquors are fermenting, he suddenly drops down and expires, as if he were knocked on the head.

When these several phenomena begin to go off, it is proper to stop the fermentation, if a very spirituous liquor be required: for if it be suffered to continue longer, the liquor will become acid, and from thence proceed to its last stage, that is, to putrefaction. This is done by stopping the containing vessels very close, and removing them into a cooler place. Then the impurities precipitate, and settling at the bottom leave the liquor clear and transparent: And now the palate discovers that the sweet saccharine taste it had before fermentation is changed to an agreeable pungency which is not acid.

Liquors thus fermented are in general called *wines*: For though in common life that word properly signifies the fermented juice of grapes only, and particular names are given to the fermented juices of other vegetable substances, as that obtained from apples, is called *cyder*; that made from malt is called *beer*; yet in chemistry it is of use to have one general term denoting every liquor that has undergone this first degree of fermentation.

By distillation we draw from wine an inflammable liquor, of a yellowish white colour, light, and of a penetrating pleasant smell. This liquor is the truly spirituous part of the wine, and the product of fermentation. That which comes off in the first distillation is commonly

loaded with much phlegm and some oily parts, from which it may be afterwards freed. In this state it goes by the name of *brandy*; but, when freed from these heterogeneous matters by repeated distillations, it becomes still clearer, lighter, more fragrant, and much more inflammable, and then is called *spirit of wine*, and *rectified spirit of wine*, or *ardent spirits*, if considerably purified. The properties which distinguish an ardent spirit from all other substances are, its being inflammable; its burning and consuming entirely, without the least appearance of smoke or fuliginosity; its containing no particles reducible to a coal, and its being perfectly miscible with water. Ardent spirits are lighter and more volatile than any of the principles of the mixtures from which they were produced, and consequently more so than the phlegm, the acid, and the oil of which they themselves consist. This arises from a particular disposition of these principles, which are in a singular manner attenuated by fermentation, and thereby rendered more susceptible of expansion and rarefaction.

Ardent spirits are supposed to be the natural solvents of oils and oily matters. But it is very remarkable, that they dissolve essential oils only, without touching the fat of animals, or the fat oils obtained from vegetables by expression; yet when these oils have once undergone the action of fire, they become soluble in spirit of wine, and even acquire a new degree of solubility every time they are distilled. It is not so with essential oils, which can never be rendered more soluble in ardent spirits than they are at first; and are so far from acquiring a new degree of solubility every time they are distilled, that on the contrary they even in some measure lose that property by repeated rectifications.

Spirit of wine doth not dissolve fixed alkalis; or at least it takes up but a very small quantity thereof; and hence ardent spirits may be freed from much of their phlegm by means of these salts thoroughly dried: For as they strongly imbibe moisture, and have even a greater affinity than ardent spirits with water, if a fixed alkali well exsiccated be mixed with spirit of wine that is not perfectly dephlegmated, the alkali immediately attracts its superfluous moisture, and is thereby resolved into a liquor, which on account of its gravity descends to the bottom of the vessel. The spirit of wine which swims a-top, is by this means as much dephlegmated, and as dry, as if it had been rectified by several distillations. As it takes up some alkaline particles in this operation, it is thereby qualified to dissolve oily matters with the greater facility. When rectified in this manner, it is called *tartarified spirit of wine*.

Yet spirit of wine, even when rectified to an alcohol, is not capable of dissolving all oily matters. Those named gums will by no means enter into any sort of union therewith; but it readily dissolves most of those which are known by the appellation of resins. When it has dissolved a certain proportion of resinous particles, it acquires a greater consistence, and forms what is called a *spirit varnish*, or a *drying varnish*, because it soon dries. This varnish is subject to be damaged by water. Many sorts thereof are prepared, different from each other according to the different resins employed, or the proportions

tions

tions in which they are used. Most of these varnishes are transparent and colourless.

Such bitumens or resins as spirit of wine will not touch are dissolved in oils by means of fire, and then form another kind of varnish which water does not hurt. These varnishes are usually coloured, and require much longer time to dry than the spirit-varnishes: They are called *oil-varnishes*.

Spirit of wine hath a much greater affinity with water than with oily matters; and therefore if a solution of any oil or resin in spirit of wine be mixed with water, the liquor immediately grows turbid, and acquires a whitish milky colour, owing entirely to the oily parts being separated from the spirituous menstruum by the action of water, and too finely divided to appear in their natural form. But if the liquor stands some time quiet, several of these particles unite together, and gradually acquire a bulk sufficient to render them very perceptible to the eye.

Acids have an affinity with spirit of wine, and may be combined with it. By this union they lose most of their acidity, and on that account are said to be *dulcified*.

One part of highly concentrated oil of vitriol being mixed with four parts of well dephlegmated spirit of wine, there arises immediately a considerable ebullition and effervescence, attended with great heat, and abundance of vapours, which smell pleasantly, but are hurtful to the lungs. At the same time is heard a hissing like that produced by a piece of red-hot iron plunged in water. Indeed it is proper to mix the liquors very gradually; for otherwise the vessels in which the operation is performed will be in great danger of breaking.

If two liquors thus mixed be distilled with a very gentle heat, there rises first a spirit of wine of a most penetrating and grateful odour: When about half thereof is come over, what follows has a quicker and more sulphureous smell, and is also more loaded with phlegm. When the liquor begins to boil a little, there comes off a phlegm which smells very strong of sulphur, and grows gradually more acid. On this phlegm floats a small quantity of a very light and very limpid oil. In the still there remains a thick, blackish substance, somewhat like a resin or bitumen. From this substance may be separated a good deal of a vitriolic but sulphureous acid. When that is extracted, there remains a black mass like a charred coal, which, being put into a crucible, and exposed to a violent heat, leaves a small portion of earth, very fixed, and even vitrifiable.

By rectifying the ardent spirit, which came over in distilling the above-mentioned mixture, a very singular liquor is obtained, which differs essentially both from oils and from ardent spirits, though in certain respects it resembles them both. This liquor is known in chemistry by the name of *æther*, and its chief properties are as follows.

Æther is lighter, more volatile, and more inflammable, than the most highly rectified spirit of wine. It quickly flies off when exposed to the air, and suddenly catches fire when any flame approaches it. It burns like spirit of wine without the least smoke, and consumes entirely without leaving the smallest appearance of a coal or

of ashes. It dissolves oils and oily matters with great ease and rapidity. These properties it has in common with an ardent spirit. But it resembles an oil, in that it is not miscible with water; and this makes it essentially different from spirit of wine, the nature of which is to be miscible with all aqueous liquors.

Another very singular property of æther is its great affinity with gold, exceeding even that of *aqua regis*. It does not indeed dissolve gold when in a mass, and in its metalline form: But if a small quantity of æther be added to a solution of gold in *aqua regis*, and the whole shaken together, the gold separates from the *aqua regis*, joins the æther, and remains dissolved therein.

The reason of all the phenomena above-mentioned, resulting from the mixture of spirit of wine with oil of vitriol, is founded on the great affinity between this acid and water. For if the vitriolic acid be weak, and as it were over-dosed with watery parts, neither oil nor æther can be obtained by means thereof: But when highly concentrated, it attracts the aqueous parts very powerfully; and therefore being mixed with spirit of wine, lays hold of most of the water contained in it, and even robs it of some portion of that which is essential to its nature, and necessary to constitute it spirit of wine: Whence it comes to pass, that a certain quantity of the oily particles in its composition being separated from the watery particles, and so brought nearer to each other, they unite and assume their natural form; and thus the oil that swims at top of the sulphureous phlegm is produced.

The vitriolic acid moreover thickens and even burns some of this oil; and hence comes the bituminous residuum left at the bottom of the still, which looks like the result of a vitriolic acid combined with common oil. Lastly, the vitriolic acid becomes sulphureous, as it always doth when united with oily matters, and also very aqueous, on account of the quantity of phlegm which it attracts from the spirit of wine.

Æther may be considered as a spirit of wine exceedingly dephlegmated, even to such a degree that its nature is thereby changed; so that the few aqueous particles left in it are not sufficient to dissolve the oily particles and keep them asunder; which therefore being now much nearer to one another than in common spirit of wine, the liquor hath lost its property of being miscible with water.

Spirit of nitre, well dephlegmated, and combined with spirit of wine, presents likewise some very singular appearances.

First, in the very instant of its mixture with spirit of wine, it produces a greater and more violent effervescence than the vitriolic acid occasions.

Secondly, this mixture, without the help of distillation, and only by stopping the bottle in which the liquors are contained, affords a sort of æther, produced probably by the vapours which ascend from, and swim atop of the mixture.

Thirdly, some authors pretend, that by distilling the mixture under consideration an oil is obtained greatly resembling that which rises from spirit of wine combined with vitriolic acid.

Fourthly, the two liquors we are speaking of, being intimately

intimately mixed by distillation, form a liquor slightly acid, used in medicine, and known by the name of *sweet* or *dulcified spirit of nitre*: a very proper name, seeing the nitrous acid, by uniting with the spirit of wine, actually loses almost all its acidity and corrosive quality.

Fifthly, when the distillation is finished, there remains in the bottom of the vessel a thick, blackish substance, nearly resembling that which is found after distilling oil of vitriol and spirit of wine.

Spirit of salt hath likewise been combined with spirit of wine; but it does not unite therewith so easily or so intimately as the two acids above mentioned. To mix them thoroughly, the spirit of salt must be highly concentrated, and smoking; and moreover the assistance of the still must be called in. Some authors pretend, that from this mixture also a small quantity of oil may be obtained; which probably happens when the liquors have the qualities above specified. The marine acid likewise, by uniting with spirit of wine, loses most of its acidity; on which account it is in like manner called *sweet* or *dulcified spirit of salt*. A thick residuum is also found here after distillation.

#### *Of the ACETOUS FERMENTATION.*

BESIDES an ardent spirit, wine affords a great deal of water, oil, earth, and a sort of acid which shall be considered presently. When the spirituous part is separated from these other matters, they undergo no further change. But if all the constituent parts of wine remain combined together, then, after some time, shorter or longer as the degree of heat in which the wine stands is greater or less, the fermentation begins afresh, or rather arrives at its second stage. The liquor once more grows turbid, a new intestine motion arises, and after some days it is found changed into an acid; which, however, is very different from those hitherto treated of. The liquor then takes the name of *vinegar*. The acetous fermentation differs from the spirituous, not only in its effect, but also in several of its concomitant circumstances. Moderate motion is of service to this, whereas it obstructs the spirituous; and it is attended with much more warmth than the spirituous. The vapours it produces are not noxious, like those of fermenting wine. Lastly, Vinegar deposits no tartar, even when the wine employed in this operation is quite new, and hath not had time to discharge its tartar: instead of tartar, vinegar deposits a viscid matter which is very apt to putrify.

#### *Of VINEGAR.*

IF wine, which has gone through this second stage of fermentation, be distilled, instead of an ardent spirit, only an acid liquor is obtained, which is called *distilled vinegar*.

This acid has the same properties as the mineral acids; that is, it unites with alkaline salts, absorbent earths, and metallic substances, and therewith forms neutral saline combinations.

Its affinity with these substances observes the same order as that observed by the mineral acids with regard to

the same substances; but in general it is weaker; that is, any mineral acid is capable of expelling the acid of vinegar out of all matters with which it is united.

Vinegar hath likewise a greater affinity than sulphur with alkalis: whence it follows, that it is capable of decomposing that combination of sulphur with an alkali called liver of sulphur, and of precipitating the sulphur it contains.

The acid of vinegar is always clogged with a certain proportion of oily parts, which greatly weaken it, and deprive it of much of its activity; and for this reason it is not near so strong as the mineral acids, which are not entangled with any oil. By distillation, indeed, it may be freed from this oil, and at the same time from the great quantity of water which in a manner suffocates it, and by that means may be brought much nearer to the nature of the mineral acids: but this attempt hath not yet been profecuted with the assiduity it deserves. Besides distillation, there is another way of freeing vinegar from a good deal of its phlegm; and that is, by exposing it to a hard frost, which readily congeals the watery part into ice, while the acid retains its fluidity.

Vinegar, saturated with a fixed alkali, forms a neutral oily salt, of a dark colour, which is semi-volatile, melts with a very gentle heat, flames when thrown upon burning coals, and dissolves in spirit of wine, of which, however, it requires six parts to complete the solution. This solution being evaporated to dryness leaves a matter in the form of leaves lying on each other; on which account it hath obtained the name of *terra foliata*. The same foliated matter will be obtained, though the salt be not previously dissolved in spirit of wine; but not so readily. This salt is also called *regenerated tartar*. Under the head of tartar we shall see the reason of these different appellations. Regenerated tartar is also in some degree capable of crystallizing: for this purpose a resolution thereof in water must be slowly evaporated to the consistence of a syrup, and then suffered to stand quiet in a cool place; by which means it will shoot into clusters of crystals, lying one upon another, not unlike the feathers on a quill.

With vinegar and several absorbent earths, such as calcined pearls, coral, shells of fish, &c. are also formed neutral saline compounds, each of which take the name of the particular earth employed in its composition.

Vinegar perfectly dissolves lead, and converts it to a neutral metallic salt, which shoots into crystals, and has a sweet saccharine taste. This compound is called *sugar of lead*, or *sal Saturni*.

If lead be exposed to the bare vapour of vinegar, it will be thereby corroded, calcined, and converted into a white matter much used in painting, and known by the name of *ceruse*, or, when it is finer than ordinary, *white-lead*.

Vinegar corrodes copper likewise, and converts it into a beautiful green rust, which also is used in painting, and distinguished by the name of *verdegris*. However, vinegar is not commonly employed to make verdegris: for this purpose they use wine, or the rape of wine, from which fire extricates an acid analogous to that of vinegar.

## Of TARTAR.

THIS substance is a saline compound, consisting of earthy, oily, and especially acid parts. It is found in the form of crusts, adhering to the inner sides of vessels in which wines have stood for some time, particularly acid wines, such as those of Germany.

Tartar derives its origin from the superabundant quantity of the acid contained in the juice of the grape. This superfluous acid, being more than is requisite to constitute the ardent spirit, unites with some of the oil and earth contained in the fermented liquor, and forms a kind of salt; which for some time continues suspended in that liquor, but, when the wine stands undisturbed in a cool place, is deposited, as hath been said, on the sides of the cask.

When it is purified, there appears on the surface of the liquor a sort of white crystalline pellicle, which is skimmed off as it forms. This matter is called *cream of tartar*. The same liquor which produces this cream, and in which the purified tartar is dissolved, being set to cool, yields a great number of white semi-transparent crystals, which are called *crystals of tartar*. The cream and the crystals of tartar are therefore no other than purified tartar, and differ from each other in their form only.

Though the crystals of tartar have every appearance of a neutral salt, yet they are far from being such; for they have all the properties of a true acid, which scarce differs from that of vinegar, except that it contains less water, and more earth and oil; to which it owes its solid form, as well as its property of not being soluble in water without much difficulty: for a very great quantity of water is requisite to keep the crystals of tartar in solution; and it must moreover be boiling hot; otherwise as soon as it cools most of the tartar dissolved in it separates from the liquor, and falls to the bottom in the form of a white powder.

Tartar is decomposed by calcination in the open fire. All its oily parts are consumed or dissipated in smoke, together with most of its acid. The other part of its acid, uniting intimately with its earth, forms a very strong and very pure fixed alkali, called *salt of tartar*.

It will be shewn in its proper place, that almost every vegetable matter, as well as tartar, leaves a fixed alkali in its ashes: yet tartar has these peculiar properties; first, it assumes an alkaline character even when burnt or calcined in close vessels, whereas other substances acquire it only by being burnt in the open air; secondly, the alkali of tartar is stronger and more saline than almost any that is obtained from other matters.

This alkali, when thoroughly calcined, powerfully attracts the moisture of the air, and melts into an unctuous alkaline liquor, improperly called *oil of tartar per deliquium*. This is the alkali generally used in making the *terra foliata*, mentioned under the head of vinegar; for which reason this combination is called *terra foliata tartari*.

Crystals of tartar combined with alkali of tartar produce a great effervescence while they are mixing, as all acids usually do; and if the combination be brought exactly up to the point of saturation, a perfectly neutral

salt is formed, which shoots into crystals, and easily dissolves in water; and this hath procured it the name of *soluble tartar*. It is also called the *vegetable salt*, as being obtained from vegetables only; and again *tartarified tartar*, because it consists of the acid and the alkali of tartar combined together.

Crystals of tartar combined with alkalis procured from the ashes of sea-weeds, such as soda, which alkalis resemble the basis of sea-salt, form likewise a neutral salt, which crystallizes well, and dissolves easily in water. This salt is another sort of soluble tartar. It is called *Saignette's salt*, from the inventor's name.

Tartar likewise dissolves the absorbent earths, as lime, chalk, &c. and with them forms neutral salts which are soluble in water. It even attacks metallic bodies, and when combined with them becomes soluble. A soluble tartar for medical use is prepared with crystals of tartar and iron: the metallic salt thereby produced hath the name of *chalybeated soluble tartar*. This salt attracts the moisture of the air, and is one of those which do not crystallize.

Crystallized tartar acts also upon several other metallic substances: for instance, it dissolves the regulus, liver, and glass of antimony, and thence acquires an emetic quality: It is then called *stibiated*, or *emetic tartar*. It likewise dissolves lead, and therewith forms a salt which, in the figure of its crystals, resembles tartarified tartar.

It is very extraordinary, that tartar, which of itself is not soluble in water, should be soluble therein when become a neutral salt by uniting either with alkalis or with absorbent earths, or even with metals. All the soluble tartars are easily decomposed by exposing them to a certain degree of heat. In distillation they yield the same principles which are obtained from tartar; and what remains fixed in the fire, after they are thoroughly burnt, is a compound of the alkali which tartar naturally produces, and of the alkaline or metallic substance with which it was converted into a neutral salt.

As crystal of tartar is the weakest of all acids, on account of the oily and earthy matters with which it is combined, soluble tartars are decomposed by all the acids; by any of which crystal of tartar may be separated from the substance that serves it for a basis and renders it a neutral salt.

## Of the Putrid Fermentation, or Putrefaction.

EVERY body which hath gone through the two stages of fermentation above described, that is, the spirituous and the acetous fermentation, being left to itself in a due degree of warmth, which varies according to the subject, advances to the last stage of fermentation; that is, to putrefaction.

When a body is in a putrefying state, it is easy to discover, by the vapours which rise from it, by the opacity which invades it, if a pellucid liquor, and frequently even by a greater degree of heat than is found in the two other sorts of fermentation, that an intestine motion is begun among its constituent parts, which lasts till the whole be entirely putrefied.

The effect of this intestine motion is to break the union,



union, and change the disposition, of the particles constituting the body in which it is excited, and to produce a new combination.

If we examine a substance that has undergone putrefaction, we shall soon perceive that it contains a principle which did not exist in it before. If this substance be distilled, there rises first, by means of a very gentle heat, a saline matter which is exceedingly volatile, and affects the organ of smelling briskly and disagreeably. Nor is the aid of distillation necessary to discover the presence of this product of putrefaction: it readily manifests itself in most substances where it exists, as any one may soon be convinced by observing the different smell of fresh and of putrefied urine; for the latter not only affects the nose, but even makes the eyes smart, and irritates them so as to draw tears from them in abundance.

This saline principle, which is the product of putrefaction, when separated from the other principles of the body which affords it, and collected by itself, appears either in the form of a liquor, or in that of a concrete salt, according to the different methods used to obtain it. In the former state it is called a *volatile urinous spirit*; and in the latter a *volatile urinous salt*. The qualification of urinous is given it, because a great deal thereof is generated in putrefied urine, to which it communicates its smell. It goes also by the general name of a *volatile alkali*, whether in a concrete or in a liquid form. The enumeration of its properties will shew why it is called an alkali.

Volatile alkalis, from whatever substance obtained, are all alike, and have all the same properties; differing only according to their degrees of purity. The volatile alkali, as well as the fixed, consists of a certain quantity of acid combined with, and entangled by a portion of the earth of the mixt body from which it was obtained; and on that account it has many properties like those of a fixed alkali. But there is moreover in its composition a considerable quantity of a fat or oily matter, of which there is none in a fixed alkali; and on this account again there is a great difference between them. Thus the volatility of the alkali produced by putrefaction, which is the principal difference between it and the other kind of alkali, whose nature it is to be fixed, must be attributed to the portion of oil which it contains: for there is a certain method of volatilizing fixed alkalis by means of a fatty substance.

Volatile alkalis have a great affinity with acids, unite therewith rapidly, and with ebullition, and form with them neutral salts, which shoot into crystals, but differ from one another according to the kind of acid employed in the combination.

The neutral salts which have a volatile alkali for their basis are in general called *ammoniacal salts*. That whose acid is the acid of sea-salt is called *sal ammoniac*. As this was the first known, it gave name to all the rest. Great quantities of this salt are made in Egypt, and thence brought to us. They sublime it from the foot of cow's dung, which is the fuel of that country, and contains sea-salt, together with a volatile alkali, or at least the materials proper for forming it; and consequently all

the ingredients that enter into the composition of *sal ammoniac*.

The neutral salts formed by combining the acids of nitre and of vitriol with a volatile alkali, are called, after their acids, *nitrous sal ammoniac*, and *vitriolic sal ammoniac*: The latter, from the name of its inventor, is also called *Glauber's secret sal ammoniac*.

A volatile alkali, then, has the same property as a fixed alkali with regard to acids; yet they differ in this, that the affinity of the former with acids is weaker than that of the latter: and hence it follows, that any *sal ammoniac* may be decomposed by a fixed alkali, which will lay hold of the acid, and discharge the volatile alkali.

A volatile alkali will decompose any neutral salt which has not a fixed alkali for its basis; that is, all such as consist of an acid combined with an absorbent earth or a metallic substance. By joining with the acids in which they are dissolved, it disengages the earths or metallic substances, takes their place, and, in conjunction with their acids, forms ammoniacal salts.

Hence it might be concluded, that, of all substances, next to the phlogiston and the fixed alkalis, volatile alkalis have the greatest affinity with acids in general. Yet there is some difficulty in this matter: for absorbent earths and several metallic substances are also capable of decomposing ammoniacal salts, discharging their volatile alkali, and forming new compounds by uniting with their acids. This might induce us to think that these substances have nearly the same affinity with acids.

But it is proper to observe, that a volatile alkali decomposes such neutral salts as have for their basis either an absorbent earth or a metallic substance, without the aid of fire; whereas absorbent earths or metallic substances will not decompose an ammoniacal salt, unless they be assisted by a certain degree of heat.

Now, as all these matters are extremely fixed, at least in comparison with a volatile alkali, they have the advantage of being able to resist the force of fire, and so of acting in conjunction therewith; and fire greatly promotes the natural action of substances upon one another: whereas the volatile alkali in the ammoniacal salt, being unable to abide the force of fire, is compelled to desert its acid; and that so much the more quickly, as its affinity therewith is considerably weakened by the presence of an earthy or metallic substance, both of which have a great affinity with acids.

These considerations oblige us to conclude, that volatile alkalis have a somewhat greater affinity, than absorbent earths and metallic substances, with acids.

Ammoniacal salts projected upon nitre in fusion make it detonate; and the nitrous sal ammoniac detonates by itself, without the addition of any inflammable matter. This singular effect evidently demonstrates the existence of an oily matter in volatile alkalis; for it is certain that nitre will never deslagrate without the concurrence and even the immediate contact of some combustible matter.

This oily substance is often found combined with volatile alkalis in such a large proportion as to disguise it in some measure, and render it exceeding foul. The salt may be freed from its superfluous oil by repeated sublimations;

tions; and particularly by subliming it from absorbent earths, which readily drink up oils. This is called the *rectification* of a volatile alkali. The salt, which before was of a yellowish or dirty colour, by being thus rectified, becomes very white, and acquires an odour more pungent and less fetid than it had at first, that is, when obtained by one single distillation from a putrid substance.

It is proper to observe, that the rectification of a volatile alkali must not be carried too far, or repeated too often; for by that means it may be entirely decomposed at length; and particularly if an absorbent earth, and especially chalk, be employed for that purpose, the salt may be converted into an oil, an earth, and water.

Volatile alkalis act upon several metallic substances, and particularly on copper; of which they make a most beautiful blue solution. On this property depends a pretty singular effect, which happens sometimes when we attempt by means of a volatile alkali to separate copper from an acid with which it is combined. Instead of seeing the liquor grow turbid, and the metal fall, both which generally happen when any alkali whatever is mixed with a metallic solution, we are surprised to observe the solution of copper, upon adding a volatile alkali, retain its limpidity, and let fall no precipitate; or at least if the liquor does grow turbid, it remains so but for a moment, and instantly recovers its transparency. This is occasioned by adding such a quantity of volatile alkali as is more than sufficient fully to saturate the acid of the solution, and considerable enough to dissolve all the copper as fast as it is separated from the acid. On this occasion the liquor requires a deeper blue than it had before; which arises from the property which volatile alkalis have of giving this metal, when combined with them, a fuller blue than any other solvent can: Hence we have a touchstone to discover copper where-ever it is; for, let the quantity of this metal, combined with other metals, be ever so small, a volatile alkali never fails to discover it, by making it appear of a blue colour.

Though a volatile alkali be constantly the result of putrefaction, yet it must not therefore be imagined, that none can be produced by any other means; on the contrary, most of those which contain the ingredients necessary to form it, yield no inconsiderable quantity thereof in distillation. Tartar, for example, which by being burnt in an open fire is converted, as was shewn, into a fixed alkali, yields a volatile alkali when it is decomposed in close vessels; that is, when it is distilled: Because, in this latter case, the oily part is not dissipated or burnt, as it is by calcination in a naked fire, but has time to unite with some of the earth and acid of the mixt, in such a manner as to form a true volatile alkali.

To prove that on this occasion, as well as on all others, where unputrefied bodies yield a volatile alkali, this salt is the product of the fire, we need only observe, that in these distillations it never rises till after some part of the phlegm of the acid, and even of the thick oil of the mixt, is come over; which never is the case when it is formed before-hand in the body which is the subject of the operation, as it is in those which have undergone putrefaction: For this salt, being much lighter and more

volatile than those other substances, rises of course before them in distillation.

### *A General View of Chemical Decomposition.*

THOUGH we have considered all the substances which enter into the composition of vegetables, animals, and minerals, whether as primary or as secondary principles, it will not be improper to shew in what order we obtain these principles from the several mixts; and especially from vegetables and animals, because they are much more complicated than minerals. This is called *analysing* a compound.

The method most commonly taken to decompose bodies is by applying to them successive degrees of heat, from the gentlest to the most violent, in appropriated vessels, so contrived as to collect what exhales from them. By this means the principles are gradually separated from each other; the most volatile rise first, and the rest follow in order, as they come to be acted on by the proper degree of heat: And this is called *distillation*.

But it being observed that fire, applied to the decomposition of bodies, most commonly alters their secondary principles very sensibly, by combining them in a different manner with each other, or even partly decomposing them, and reducing them to their primitive principles; other means have been used to separate those principles without the help of fire.

With this view the mixts to be decomposed are forcibly compressed, in order to squeeze out of them all such parts of their substance as they will by this means part with; or else those mixts are for a long time triturated, either along with water, which carries off all their saline and saponaceous contents; or with solvents, such as ardent spirits, capable of taking up every thing in them that is of an oily or resinous nature.

We shall here give a succinct account of the effects of these different methods, as applied to the principal substances among vegetables and animals, and likewise to some minerals.

### *The ANALYSIS of VEGETABLE SUBSTANCES.*

A vast many vegetable substances, such as kernels and seeds, yield by strong compression great quantities of mild, fat, unctuous oils, which are not soluble in ardent spirits: These are what we called *expressed oils*. They are also sometimes called *fat oils*, on account of their unctuousness, in which they exceed all other sorts of oil. As these oils are obtained without the aid of fire, it is certain that they existed in the mixt just as we see them, and that they are not in the least altered; which could not have been the case had they been obtained by distillation: For that never produces any oils but such as are acrid and soluble in spirit of wine.

Some vegetable matters, such as the rind of citrons, lemons, oranges, &c. also yield, only by being squeezed between the fingers, a great deal of oil. This spirits out in fine small jets, which being received upon any polished surface, such as a looking-glass, run together, and form a liquor that is a real oil.

But

But it must be carefully noted, that this sort of oil, though obtained by expression only, is nevertheless very different from the oils mentioned before to which the title of *expressed oils* peculiarly belongs: For this is far lighter and thinner; moreover, it retains the perfect odour of the fruit which yields it, and is soluble in spirit of wine; in a word, it is a true essential oil, but abounds so in the fruits which produce it, and is lodged therein in such a manner, occupying a vast number of little cells provided in the peel for its reception, that a very slight pressure discharges it; which is not the case with many vegetables that contain an essential oil.

Succulent and green plants yield by compression a great deal of liquor or juice, which consists of most of the phlegm of the salts, and a small portion of the oil and earth of the plant. These juices, being set in a cool place for some time, deposit saline crystals, which are a combination of the acid of the plant with part of its oil and earth, wherein the acid is always predominant. These salts, as is evident from the description here given, bear a great resemblance to the tartar of wine treated of above. They are called *essential salts*; so that tartar might likewise be called the *essential salt of wine*.

Dried plants, and such as are of a ligneous, or acid nature, require to be long triturated with water, before they will yield their essential salts. Trituration with water is an excellent way to get out of them all their saline and saponaceous contents.

A vegetable matter that is very oily yields its essential salt with much difficulty, if at all; because the excessive quantity of oil entangles the salt so that it cannot extricate itself or shoot into crystals. Mr Gerike, in his *Principles of Chemistry*, says, That if part of the oil of a plant be extracted by spirit of wine, its essential salt may be afterwards obtained with more ease and in greater quantity.

Essential salts are among those substances which cannot be extracted from mixts by distillation; for the first impression of fire decomposes them.

Though the acid which predominates in the essential salts of plants be most commonly analogous to the vegetable acid, properly so called, that is, to the acid of vinegar and tartar, which is probably no other than the vitriolic acid disguised; yet it sometimes differs therefrom, and somewhat resembles the nitrous or the marine acid. This depends on the places where the plants grow which produce these salts: If they be submarine plants, their acid is a-kin to the acid of sea-salt; if, on the contrary, they grow upon walls, or in nitrous grounds, their acid is like that of nitre. Sometimes one and the same plant contains salts analogous to all the three mineral acids; which shews that the vegetable acids are no other than the mineral acids variously changed by circulating through plants.

Liquors containing the essential salts of plants being evaporated by a gentle heat to the consistence of honey, or even further, are called *extracts*. Hence it is plain, that an extract is nothing but the essential salt of a plant, combined with some particles of its oil and earth, that re-

mained suspended in the liquor, and are now incorporated by evaporation.

Extracts of plants are also prepared by boiling them long in water, and then evaporating some part of it. But these extracts are of inferior virtue; because the fire dissipates many of the oily and saline parts.

#### EMULSIONS.

Substances which abound much in oil, being bruised and triturated with water for some time, afford a liquor of an opaque dead-white colour like milk. This liquor consists of such juices as the water is capable of dissolving, together with a portion of the oil, which being naturally indissoluble in water, is only divided and dispersed in the liquor, the limpidity whereof is by that means destroyed. This sort of oily liquor, in which the oil is only divided, not dissolved, is called an *emulsion*. The oily particles in emulsions spontaneously separate from the water, when left at rest, and, uniting into greater masses, rise, on account of their lightness, to the surface of the liquor, which by that means recovers a degree of transparency.

If vegetables, abounding in essential oils and resins, be digested in spirit of wine, the menstruum takes up these oily matters, as being capable of dissolving them; and they may afterwards be easily separated from it by the affusion of water. The water, with which spirit of wine has a greater affinity than with oily matters, separates them by this means from their solvent, agreeable to the common laws of affinities.

Without the help of fire scarce any thing, besides the substances already mentioned, can be obtained from a plant: But by the means of distillation we are enabled to analyse them more completely. In prosecuting this method of extracting from a plant the several principles of which it consists, the following order is to be observed.

A plant being exposed to a very gentle heat, in a distilling vessel set in the *balneum marie*, yields a water which retains the perfect smell thereof. Some chemists, and particularly the illustrious Boerhaave, have called this liquor the *spiritus rectior*. The nature of this odoriferous part of plants is not yet thoroughly known; because it is so very volatile, that it is difficult to subject it to the experiments necessary for discovering all its properties.

If instead of distilling the plant in the *balneum marie*, it be distilled over a naked fire, with the precaution of putting a certain quantity of water into the distilling vessel along with it, to prevent its suffering a greater heat than that of boiling water, all the essential oil contained in that plant will rise together with that water, and with the same degree of heat.

On this occasion it must be observed, that no essential oil can be obtained from a plant after the *spiritus rectior* hath been drawn off; which gives ground to think that the volatility of these oils is owing to that spirit.

The heat of boiling water is also sufficient to separate from vegetable matters the fat oils which they contain: That, however, is to be done by the way of decoction

only, and not by distillation; because, though these oils will swim on water, yet they will not rise in vapours without a greater degree of heat,

When the essential oil is come over, if the plant be exposed to a naked fire, without the addition of water, and the heat be increased a little, a phlegm will rise that gradually grows acid; after which, if the heat be increased as occasion requires, there will come over a thicker and heavier oil; from some a volatile alkali; and last of all, a very thick, black, empyreumatic oil.

When nothing more rises with the strongest degree of heat, there remains of the plant a mere coal only, called the *caput mortuum*, or *terra damnata*. This coal when burnt falls into ashes, which being lixiviated with water give a fixed alkali.

It is observable, that in the distillation of plants which yield an acid and a volatile alkali, these two salts are often found quite distinct and separate in the same receiver; which seems very extraordinary, considering that they are naturally disposed to unite, and have a great affinity with one another. The reason of this phenomenon is, that they are both combined with much oil, which embarrasses them so that they cannot unite to form a neutral salt, as they would not fail to do were it not for that impediment.

All vegetables, except such as yield a great deal of volatile alkali, being burnt in an open fire, and so as to flame, leave in their ashes a large quantity of an acid, caustic, fixed alkali. But if care be taken to smother them, so as to prevent their flaming while they burn, by covering them with something that may continually beat down again what exhales, the salt obtained from their ashes will be much less acid and caustic; the cause whereof is, that some part of the acid and oil of the plant being detained in the burning, and stopped from being dissipated by the fire, combines with its alkali. These salts crystallize, and being much milder than the common fixed alkalis may be used in medicine, and taken internally. They are called *Tachenius's salts*, because invented by that chemist.

Marine plants yield a fixed alkali analogous to that of sea-salt. As for all other plants or vegetable substances, the fixed alkalis obtained from them, if rightly prepared and thoroughly calcined, are all perfectly alike, and of the same nature.

The last observation we have to make on the production of a fixed alkali is, that if the plant you intend to work upon be steeped or boiled in water before you burn it, a much smaller quantity of salt will be obtained from it; nay, it will yield none at all, if repeated boilings have robbed it entirely of those saline particles which must necessarily concur with its earth to form a fixed alkali.

#### *The ANALYSIS of ANIMAL SUBSTANCES.*

SUCCULENT animal substances, such as new-killed flesh, yield by expression a juice or liquid, which is no other than the phlegm, replete with all the principles of the animal body except the earth, of which it contains but little. The hard or dry parts, such as the horns, bones, &c. yield a similar juice, by boiling them in water. These juices become thick, like a glue or jelly,

when their watery parts are evaporated; and in this state they are true extracts of animal matters. These juices afford no crystals of essential salt, like those obtained from vegetables, and shew no sign either of an acid or an alkali.

Great part of the oil which is in the flesh of animals may be easily separated without the help of fire; for it lies in a manner by itself: It is commonly in a concrete form, and is called *fat*. This oil somewhat resembles the fat oils of vegetables; for like them it is mild, unctuous, indissoluble in spirit of wine, and is subtilized and attenuated by the action of fire. But there is not in animals, as in vegetables, any light essential oil, which rises with the heat of boiling water; so that, properly speaking, animals contain but one sort of oil.

Few animal substances yield a perceptible acid. Ants and bees are almost the only ones from which any can be obtained; and indeed the quantity which they yield is very small, as the acid itself is extremely weak.

The reason thereof is, that as animals do not draw their nourishment immediately from the earth, but feed wholly either on vegetables or on the flesh of other animals, the mineral acids, which have already undergone a great change by the union contracted between them and the oily matters of the vegetable kingdom, enter into a closer union and combination with these oily parts while they are passing through the organs and strainers of animals; whereby their properties are destroyed, or at least so impaired that they are no longer sensible.

Animal matters yield in distillation, first, a phlegm, and then, on increasing the fire, a pretty clear oil, which gradually becomes thicker, blacker, more fetid, and empyreumatic. It is accompanied with a great deal of volatile alkali; and if the fire be raised and kept up till nothing more comes over, there will remain in the distilling vessel a coal like that of vegetables; except that when it is reduced to ashes, no fixed alkali, or at least very little, can be obtained from them, as from the ashes of vegetables. This arises from hence that, as we said before, the saline principle in animals being more intimately united with the oil than it is in plants, and being consequently more attenuated and subtilized, is too volatile to enter into the combination of a fixed alkali; on the contrary, it is more disposed to join in forming a volatile alkali, which on this occasion does not rise till after the oil, and therefore must certainly be the production of the fire.

The chyle, and the milk of animals which feed on plants, still retain some likeness to vegetables; because the principles of which these liquors are composed have not gone through all the changes which they must suffer before they enter into the animal combination.

Urine and sweat are excrementitious aqueous liquors, loaded chiefly with the saline particles which are of no service towards the nourishment of the animal, but pass through its strainers without receiving any alteration; such as the neutral salts which have a fixed alkali for their basis, and particularly the sea-salt which happens to be in the food of animals, whether it exist therein naturally, as it does in some plants, or whether the animals eat it to please their palates.

The

The saliva, the pancreatic juice, and especially the bile, are saponaceous liquors; that is, they consist of saline and oily particles combined together; so that being themselves dissolved in an aqueous liquor, they are capable of dissolving likewise the oily parts, and of rendering them miscible with water.

Lastly, The blood being the receptacle of all these liquors, partakes of the nature of each, more or less in proportion to the quantity thereof which it contains.

#### The ANALYSIS of MINERAL SUBSTANCES.

MINERALS differ greatly from vegetables, and from animals; they are not near so complex as those organized bodies, and their principles are much more simple; whence it follows, that these principles are much more closely connected, and that they cannot be separated without the help of fire; which not having on their parts the same action and the same power as on organized bodies, hath not the same ill effect on them; we mean the effect of changing their principles, or even destroying them entirely.

We do not here speak of pure, vitrifiable, or refractory earths; of mere metals and semi-metals; of pure acids; or even of their simplest combinations, such as sulphur, vitriol, alum, sea-salt: Of all these we have said enough.

We are now to treat of bodies that are more complex, and therefore more susceptible of decomposition. These bodies are compound masses or combinations of those above-mentioned; that is, metallic substances as they are found in the bowels of the earth, united with several sorts of sand, stones, earths, semi-metals, sulphur, &c. When the metallic matter is combined with other matters in such a proportion to the rest that it may be separated from them with advantage and profit, these compounds are called *ores*: when the case is otherwise, they are called *pyrites*, and *marcasites*; especially if sulphur or arsenic be predominant therein, which often happens.

In order to analyse an ore, and get out of it the metal it contains, the first step is to free it from a great deal of earth and stones which commonly adhere to it very slightly and superficially. This is effected by pounding the ore, and then washing it in water; to the bottom of which the metalline parts presently sink, as being the heaviest, while the small particles of earth and stone remain suspended some time longer.

Thus the metallic part is left combined with such matters only as are most intimately complicated with it. These substances are most commonly sulphur and arsenic. Now, as they are much more volatile than other mineral matters, they may be dissipated in vapours, or the sulphur may be consumed, by exposing the ore which contains them to a proper degree of heat. If the sulphur and arsenic be desired by themselves, the fumes thereof may be caught and collected in proper vessels and places. This operation is called *roasting* in ore.

The metal thus separated is now fit to be exposed to a greater force of fire, capable of melting it.

On this occasion the semi-metals and the imperfect metals require the addition of some matter abounding in phlogiston, particularly charcoal-dust; because these me-

tallic substances lose their phlogiston by the action of the fire, or of the fluxes joined with them, and therefore without this precaution would never acquire either the splendor or the ductility of a metal. By this means the metallic substance is more accurately separated from the earthy and stony parts, of which some portion always remains combined therewith till it is brought to fusion. For, as we observed before, a metallic glass or calx only will contract an union with such matters; a metal possessed of its phlogiston and metalline form being utterly incapable thereof.

We took notice of the cause of this separation above, where we shewed that a metal possessed of its phlogiston and metalline form will not remain intimately united with any calcined or vitrified matter, not even with its own calx or glass.

The metal therefore on this occasion gathers into a mass, and lies at the bottom of the vessel, as being most ponderous; while the heterogeneous matters float upon it in the form of a glass, or a semi-vitrification. These floating matters take the name of *scoriae*, and the metalline substance at bottom is called the *regulus*.

It frequently happens, that the metalline regulus thus precipitated, is itself a compound of several metals mixed together, which are afterwards to be separated.

It is proper to observe, before we quit this subject, that the rules here laid down for analysing ores are not absolutely general: For example, it is often advisable to roast the ore before you wash it; for by that means some ores are opened, attenuated, and made very friable, which would cost much trouble and expence, on account of their excessive hardness, if you should attempt to pound them without a previous torrefaction.

It is also frequently necessary to separate the ore from part only of its stone; sometimes to leave the whole; and sometimes to add more to it, before you smelt it. This depends on the quality of the stone, which always helps to promote fusion when it is in its own nature fusible and vitrifiable: It is then called the *flux* of the ore.

We shall now give a succinct account of the principal ores and mineral bodies, contenting ourselves with just pointing out the particulars of which they severally consist.

#### Of the PYRITES.

##### The Yellow Pyrites.

THE yellow pyrites is a mineral consisting of sulphur, iron, an unmetallic earth, and frequently a little copper: The sulphur, which is the only one of these principles that is volatile, may be separated from the rest by sublimation: It usually makes a fourth, and sometimes a third, of the whole weight of these pyrites. The other principles are separated from one another by fusion and reduction with the phlogiston, which, by metallizing the ferruginous and cupreous earths, parts them from the unmetallic earth: for this earth vitrifies, and cannot afterwards continue united with metallic matters possessed of their metalline form.

There is yet another way of decomposing the yellow pyrites, which is to let it lie till it effloresces, or begins

to

to shoot into flowers; which is nothing but a sort of slow accretion of the sulphur it contains. The sulphur being by this means decomposed, its acid unites with the ferruginous and cupreous parts of the pyrites, and therewith forms green and blue vitriols; which may be extracted by steeping in water the pyrites which has effloresced or been burnt, and then evaporating the lixivium to a pellicle; for by this means the vitriol will shoot into crystals. Sometimes the pyrites contains also an earth of the same nature with that of alum: A pyrites of this sort, after flowering, yields alum as well as vitriol.

#### *The White Pyrites.*

THE white pyrites contains much arsenic, a ferruginous earth, and an unmetallic earth. The arsenic being a volatile principle, may be separated by sublimation or distillation from the rest, which are fixed; and these again may be disjoined from each other by fusion and reduction, as was said in relation to the yellow pyrites.

#### *The Copper Pyrites.*

THE copper pyrites contains sulphur, copper, and an unmetallic earth. A great deal thereof likewise holds arsenic, and its colour approaches more or less to orange, yellow, or white, according to the quantity of arsenic in it. It may be decomposed by the same means as the yellow and white pyrites.

### OF ORES.

#### *Of Gold Ores.*

GOLD being constantly found in its metalline form, and never combined with sulphur and arsenic, its ores are not, properly speaking, ores; because the metal contained in them is not mineralized. The gold is only lodged between particles of stone, earth, or sand, from which it is easily separated by lotion, and by amalgamation with quick-silver. The gold thus found is seldom pure, but is frequently alloyed with more or less silver, from which it is to be separated by quartation.

It is also very common to find gold in most ores of other metals or semi-metals, and even in the pyrites; but the quantity contained therein is generally so small, that it would not pay the cost of extracting it. However, if any should incline to attempt it, merely out of curiosity, it would be necessary to begin with treating these ores in the manner proper for separating their metalline part; then to cupel the metalline regulus so obtained; and lastly, to refine it by quartation.

#### *Of Silver Ores.*

IT is no rare thing to find silver, as well as gold, in its metalline form, only lodged in sundry earths and stony matters, from which it may be separated in the same manner as gold. But the greatest quantities of this metal are usually dug out of the bowels of the earth in a truly mineral state; that is, combined with different substances, and particularly with sulphur and arsenic.

Several silver ores are distinguished by peculiar characteristics, and are accordingly denoted by particular

names. That which is called the *vitreous silver ore*, is scarce any thing else but a combination of silver and sulphur. Another is known by the name of the *horny silver ore*, because when in thin plates it is semi-transparent: In this ore the silver is mineralized by sulphur and a little arsenic. The *red silver ore* is of the colour which its name imports, sometimes more, sometimes less vivid; and is chiefly composed of silver, arsenic, and sulphur: It also contains a little iron.

These three ores are very rich in silver: the first contains nearly three-fourths of its weight, and the others about two-thirds of theirs.

There is a fourth, called the *white silver ore*, which though it be heavier, is not so rich in silver, because it contains much copper. Many other ores contain silver, yet are not, properly speaking, silver ores; because a much greater quantity of other metals than of silver is found in them.

When a silver ore is to be decomposed, in order to have the silver pure, or when silver is to be extracted out of any ore that contains it, the first thing to be done is to roast the ore in order to clear it of the volatile minerals: and as silver cannot be had pure without the operation of the cupel, which requires more or less lead to be joined with it, it is usual to mix with the torrefied silver ore a quantity of lead proportioned to that of the heterogeneous matters combined with the silver, and to melt the whole together. Part of the added lead vitrifies during the fusion, and at the same time converts some of the heterogeneous matter also into glass, with which it forms a scoria that rises to the surface of the matter. The other part of the lead, with which the silver is mixed, falls to the bottom in the form of a regulus, which must be cupelled in order to have the silver pure.

#### *Of Copper Ores.*

COPPER is much seldomer found in a metalline form, than gold or silver; it is commonly in a mineral state: it is mineralized by sulphur and arsenic: almost all its ores contain also more or less iron; sometimes a little silver or even gold, together with unmetallic earths and stones, as all ores do.

Most copper ores are of a beautiful green or blue, or else in shades blended of these two colours. The minerals called mountain green, and mountain blue, are true copper ores; not in the form of hard stones, like other ores, but crumbly and friable like earth.

Nevertheless there are several copper ores of different colours, as ash-coloured, whitish, and shaded with yellow or orange: which colours arise from the different proportions of arsenic, sulphur, and iron, which these ores contain.

In order to decompose a copper ore, and to extract the copper it contains, it is first of all to be freed from as many of its earthy, stony, sulphureous, and arsenical parts, as is possible, by roasting and washing; then what remains is to be mixed with a flux compounded of a fixed alkali and some inflammable matter; a little sea-salt is to be put over all, and the whole melted by a strong fire. The salts facilitate the fusion and scorification of the

the unmetall'ic matters, and therewith form a slag, which being the lightest rises to the surface. The metalline matters are collected below in the form of a shining regulus of copper; which however, is not usually fine copper, but requires to be purified.

In order to separate the copper from the unmetall'ic matters, it is absolutely necessary to melt its ore along with the inflammable substances abounding in phlogiston. For, as this metal is not possessed of its metalline form while it is in a mineral state, as it is destitute of the true quantity of phlogiston, and, though it were not, would lose it by the action of the fire, it would come to pass, that, if its ore were melted without the addition of any inflammable matter, the cupreous earth, or calx, would be scorified and confounded with the unmetall'ic matters; and as all metallic matters, except gold and silver, are subject to this inconvenience as well as copper, the addition of an inflammable substance, in fluxing all ores that contain them, is a general rule that ought constantly to be observed.

#### *Of Iron Ores.*

IRON is seldom found pure and malleable in the earth; yet it is much seldomer found in the mineral state, properly so called, than any of the other metals: for most iron ores are scarce any thing more than a ferruginous earth mixed in different proportions with unmetall'ic earths and stones. Some of them, however, contain also volatile minerals, such as sulphur and arsenic; and therefore it is necessary to roast the iron ores, like all others, before you attempt to extract the metal out of them. That being done, they are to be smelted with a flux consisting of fusible and inflammable matters, as the general rule directs.

Iron is the commonest of all metals; nay, it is so universally diffused through the earth, that it is difficult to find any stone, earth, or sand, that does not contain some of it; and therefore none of these are usually considered and treated as iron ores, except such as contain a great deal of that metal, and melt easily. The hematites, emery, yellow pyrites, calamine, all contain a pretty considerably quantity of iron; but nobody attempts to extract it from them, because they are very hard to melt.

Ferruginous earth being naturally of an orange colour, a stone or earth may be judged to contain iron, if either naturally or after roasting it appears to have any shade of yellow or red.

The singular property which iron has of being attracted by the magnet, and of being the only body, exclusive of all others, that is so, likewise affords us an easy method of discovering the presence of this metal among other matters, where it often exists in such a small quantity that it could not otherwise be found out. For this purpose the body in which iron is suspected to lurk, must be pulverised and torrefied with some inflammable matter; and then the powder thus roasted being touched with a magnet, or a magnetical bar, if it contains any particles of iron they will infallibly adhere to the magnet or bar.

#### *Of Tin Ores.*

TIN is never found in the earth pure and malleable,

but always in a mineral state, and always mineralised by arsenic. Tin ores are not sulphureous; whence it comes that though tin be the lightest of all metals, its ores are nevertheless heavier than those of other metals, as arsenic greatly exceeds sulphur in gravity. Some tin ores contain also a little iron. The ores of tin are to be washed, roasted, and smelted with a reducing flux, according to the general rules.

#### *Of Lead Ores.*

LEAD, like tin, is never found but in a mineral state. It is most commonly mineralised by sulphur; yet there are some lead ores which also contain arsenic.

Lead ores, as well as all others, must be roasted and smelted with a reducing flux: however, as it is difficult to free them from all their sulphur by torrefaction only, the reducing flux employed in their fusion may be made up with a quantity of iron filings, which being incapable of any union with lead, and having a much greater affinity than that metal with sulphur, will on this occasion be of great service by interposing between them.

#### *Of Quick-Silver Ores.*

RUNNING mercury is sometimes found in certain earths, or grey friable stones; but most commonly in a mineral state. It is always mineralized by sulphur, and by sulphur alone: so that cinabar is the only ore of quick-silver that we know of; and a very rich one it is, seeing it contains six or seven times as much mercury as sulphur.

Roasting can be of no use towards decomposing the ore of mercury, and separating its sulphur; because mercury being itself very volatile would be carried off by the fire together with the sulphur. In order therefore to part the two substances of which cinabar consists, recourse must necessarily be had to some third body, which will unite with one of them, and by that means separate it from the other. Now all the metals, except gold, having a greater affinity than mercury with sulphur, such a body is easily found: any metal but gold may be employed with success in this decomposition; but as iron hath a greater affinity with sulphur than any of the rest, and is, moreover, the only one that cannot unite with mercury, it must, on account of these two qualities, be preferred to all the rest.

Fixed alkalis are also well qualified to absorb the sulphur of cinabar. Cinabar must be decomposed in close vessels, and by the way of distillation: otherwise the mercury, as soon as it separates from the sulphur, will be dissipated in vapours and entirely lost.

In this operation it is needless to add either flux or phlogiston; because the cinabar is decomposed without melting, and the mercury, though in a mineral state, contains, like gold and silver, all the phlogiston requisite to secure its metalline properties.

#### *Of the Ores of Regulus of Antimony.*

REGULUS of antimony is always found in a mineral state: it is mineralised by sulphur: but sometimes, tho' rarely, it is also combined with a little arsenic.

When the ore of regulus of antimony is to be decomposed,

posed, the first thing to be done, is to expose it to a degree of heat too weak to melt its earthy and stony parts, but strong enough to fuse its reguline together with its sulphureous parts, which by this means are separated from the earth, and united into one mass, known by the name of Antimony.

It is plain, that this first operation, which is founded on the great fusibility of antimony, produces, with regard to the ore of regulus of antimony, the same effect that washing hath on other ores: so that after this first fusion nothing more is requisite to the obtaining of a pure regulus of antimony, but to separate it from its sulphur by roasting, and to melt it with some matter abounding in phlogiston, in the same manner as other metallic matters are treated. The term calcination is generally used to express this torrefaction of antimony, by means whereof the metallic earth of the regulus of antimony is separated from its sulphur.

As regulus of antimony hath, like mercury, much less affinity with sulphur than the other metals have, it follows that antimony may be decomposed by the same means as cinabar; but the regulus so obtained is adulterated with a portion of the additament made use of, which combines therewith.

#### *Of the Ores of Bismuth.*

THE ore of bismuth consists of the semi-metal mineralised by the arsenic, and of an unmetallic earth. It is very easy to decompose this ore, and to extract the bismuth it contains: for this purpose it need only be exposed to a moderate heat, whereby the arsenic will be dissipated in vapours, and the bismuth melted, which will then separate from the unmetallic earth. This earth, at least in several ores of bismuth, possesses the property of tinging all vitrifiable matters with which it is melted of a beautiful blue colour.

To decompose the ore of bismuth no flux or inflammable matter is used; because this semi-metal is possessed, even in its mineral state, of all the phlogiston requisite to maintain its metalline properties; and its great fusibility makes it unnecessary to melt the metallic earth contained in its ore.

#### *Of the Ores of Zinc.*

ZINC is not generally obtained from a particular ore of its own; but sublimes during the fusion of a mineral, or rather a confused mass of minerals, that contains this semi metal together with iron, copper, lead, sulphur, arsenic, and, like all other ores, an unmetallic earth.

Nevertheless there is a substance which may be considered as the proper ore of zinc, because it contains a pretty large quantity of that semi-metal, a little iron, and an unmetallic earth. It is called calamine, or *lapis calaminaris*: but hitherto the art of procuring zinc directly from this mineral hath no where been practised. Calamine is commonly employed only to convert copper into brass or a yellow metal, by cementing it therewith. Indeed till lately no easy or practicable method of obtaining pure zinc from calamine was publicly known; for that semi-metal being volatile and very inflammable, its

ore cannot be fused like others. Mr Margraaf was the first who, by mixing powdered charcoal with calamine in close vessels, obtained a perfect zinc from it, by the means of distillation or sublimation.

#### *Of Arsenical Minerals.*

ARSENIC; as well as sulphur, is naturally combined with almost all ores, or minerals containing metallic substances. As it is very volatile, while the matters with which it is united are fixed, at least in comparison therewith, it is easily separated by sublimation.

The minerals that contain most arsenic are the white pyrites, orpiment, and cobalt. We have already considered the white pyrites: as to orpiment, it consists of sulphur and arsenic. Both these substances being very volatile, it is difficult to separate them by sublimation: yet, with proper management, and a due regulation of the fire, this separation may be effected; because sulphur sublimes a little more easily than arsenic. But it is more convenient, as well as more expeditious, to make use of some additament that hath a greater affinity with one of those substances than with the other. Fixed alkalis and mercury, both of which have more affinity with sulphur than with arsenic, may be very properly employed on this occasion. Cobalt is a mineral composed of arsenic, an unmetallic earth, and frequently, bismuth: and as none of these are very volatile, except the arsenic, this may be easily separated from the rest by sublimation. The unmetallic earth which remains has, like that of the ore of bismuth, the property of giving a blue colour to any vitrifiable matters melted with it; whence it is conjectured, that cobalt and the ore of bismuth have a great resemblance, or are often blended with each other.

Besides the minerals already recited, there is found in the bowels of the earth another species of compound body, of which we have already taken notice; but which is supposed, with some degree of probability, to belong as much to the vegetable as to the mineral kingdom: we mean the bitumens; which the best observations oblige us to consider as vegetable oils, that by lying long in the earth have contracted an union with the mineral acids, and by that means acquired the thickness, consistence, and other properties observable in them.

By distillation they yield an oil, and an acid not unlike a mineral acid. Mr Bourdelin has even demonstrated, by a very artful and ingenious process, that amber contains a manifest acid of sea-salt.

#### *Explanation of the Table of Affinities or elective Attractions.*

WE have already explained what is meant by affinities, and have laid down the principal laws to which the relations of different bodies are subject. The late Mr Geoffroy, being convinced of the advantages which all who cultivate chemistry would receive from having constantly before their eyes a state of the best ascertained relations between the chief agents in chemistry, was the first who undertook to reduce them into order, and unite them all in one point of view, by means of a table. This table will be of considerable use to such as are beginning to study

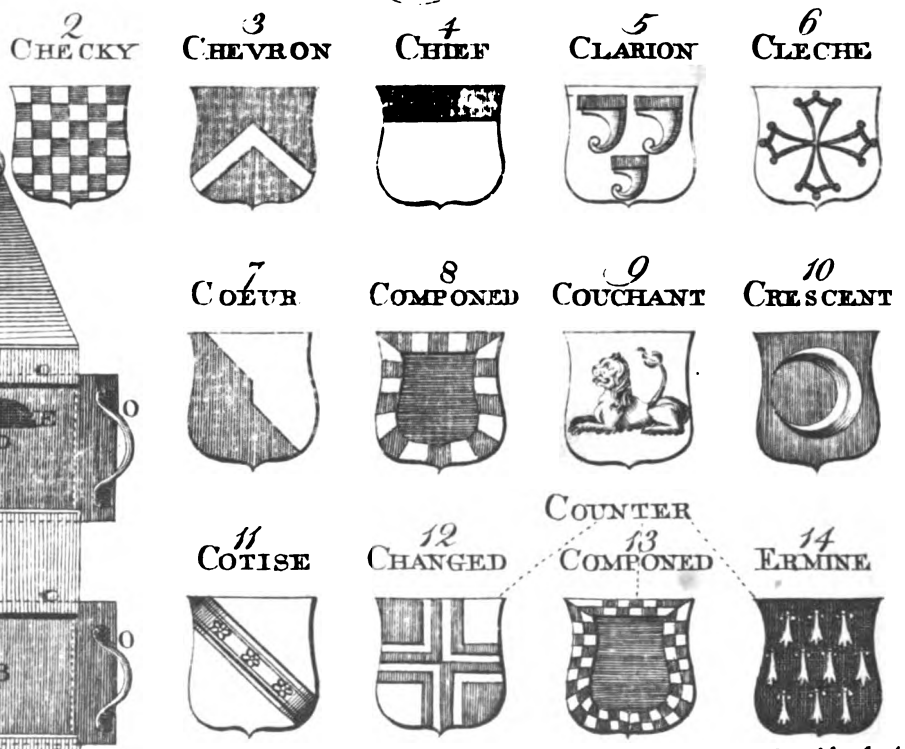
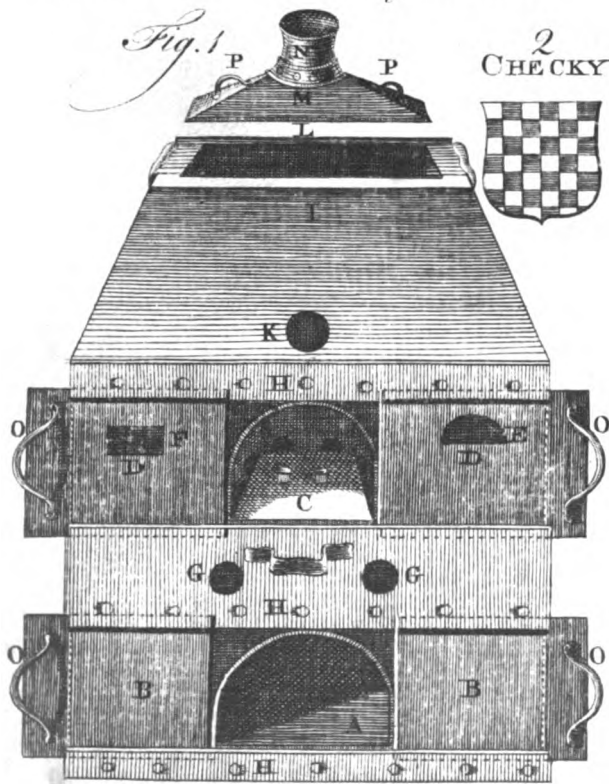




I.	II.	III.	IV.	V.	VI.	VII.	VIII.	IX.	X.	XI.	XII.	XIII.	XIV.	XV.	XVI.
							MS								

Explanation of the Characters

- 
- 
- 
- 
- 
- 
- 
- 
- 
- 
- 
- 
- 
- 
- 



A. Bell. Sculp.

study chemistry, in helping them to form a just idea of the relations which different substances have with one another; and the practical chemist will thereby be enabled to account for what passes in several of his operations, otherwise difficult to be understood, as well as to judge what may be expected to result from mixtures of different compounds. These reasons have induced us to insert it at the end of this elementary treatise, and to give a short explanation of it here; especially as it will serve at the same time for a recapitulation of the whole work, in which the several axioms of this table are dispersed. See Plate LXV.

The upper line of Mr Geoffroy's table comprehends several substances used in chemistry. Under each of those substances are ranged in distinct columns several matters compared with them, in the order of their relation to that first substance; so as that which is the nearest to it is that which hath the greatest affinity with it, or that which none of the substances standing below it can separate therefrom; but which, on the contrary, separates them all when they are combined with it, and expels them in order to join itself therewith. The same is to be understood of that which occupies the second place of affinity; that is, it has the same property with regard to all below it, yielding only to that which is above it: and so of all the rest.

At the top of the first column stands the character which denotes an acid in general. Immediately under this stands the mark of a fixed alkali, being placed there as the substance which has the greatest affinity with an acid. After the fixed alkali, appears the volatile alkali, whose affinity with acids yields only to the fixed alkali. Next come the absorbent earths; and, last of all, metallic substances. Hence it follows, that when a fixed alkali is united with an acid, it cannot be separated therefrom by any other substance; that a volatile alkali united with an acid cannot be separated from it by any thing but a fixed alkali; that an absorbent earth combined with an acid may be separated from it either by a fixed or by a volatile alkali; and lastly, that any metallic substance combined with an acid, may be separated from it by a fixed alkali, a volatile alkali, or an absorbent earth.

At the head of the second column stands the character of the marine acid, which signifies that the affinities of this acid are the subject of the column. Immediately below it is placed the mark of tin. As this is a metalline substance, and as the first column places metalline substances in the lowest degree of affinity with all acids, it is plain we must suppose fixed alkalis, volatile alkalis, and absorbent earths, to be placed here in order after the marine acids, and before tin. Tin, then, is of all metalline substances that which has the greatest affinity with the marine acid; and then follow regulus of antimony, copper, silver mercury. Gold comes last of all; and there are no less than two vacant places above it. By this means it is in some sort excluded from the rank of substances that have an affinity with the marine acid. The reason thereof is, that this acid alone is not capable of dissolving gold and combining therewith, necessarily requiring for that purpose the aid of the nitrous acid, or at least of the phlogiston.

The third column exhibits the affinities of the nitrous acid, the character whereof stands at its head. Immediately below it is the sign of iron, as the metal which has the greatest affinity with this acid; and then follow other metals, each according to the degree of its relation, *viz.* copper, lead, mercury, and silver. In this column, as in the preceding one, we must suppose the substances, which in the first column stand above metallic substances, to be placed in their proper order before iron.

The fourth column is intended to represent the affinities of the vitriolic acid. The phlogiston stands uppermost. Below it the fixed alkalis, volatile alkalis, and absorbent earths, to shew that this is an exception to the first column. As to metalline substances, Mr Geoffroy has set down but three, being those with which the vitriolic acid has the most perceptible affinity: these metals, placed in the order of their affinities, are iron, copper, and silver.

The fifth column shews the affinities of absorbent earths. As these earths have no sensible affinity but with acids, this column contains only the characters of the acids ranked according to the degree of their strength, or affinity with the earths, *viz.* the vitriolic, the nitrous, and the marine acids. Underneath this last might be placed the acid of vinegar, or the vegetable acid.

The sixth column expresses the affinities of fixed alkalis with acids, which are the same with those of absorbent earths. Moreover, we find sulphur placed here below all the acids; because liver of sulphur, which is a combination of sulphur with a fixed alkali, is actually decomposed by any acid: for any acid precipitates the sulphur and unites with the alkali.

Immediately over the sulphur, or in the same square with it, might be set a mark denoting the volatile sulphureous spirit; because, like sulphur, it has less affinity than any other acid with fixed alkalis. Oils might also be ranked with sulphur, because they unite with fixed alkalis, and therewith form soaps which are decomposed by any acid whatever.

The seventh column points out the affinities of volatile alkalis, which are likewise the same as those of absorbent earths; and the vegetable acid might be placed here also under the marine acid.

The eighth column specifies the affinities of metallic substances with acids. The affinities of the acids, which with respect to fixed alkalis, volatile alkalis, and absorbent earths, succeed each other uniformly, do not appear in the same order here. The marine acid, instead of being placed below the vitriolic and nitrous acids, stands, on the contrary, at their head: because, in fact, this acid separates metalline substances from all the other acids with which they happen to be united, and, forcing these acids to quit possession, intrudes into their place. Nevertheless, this is not a general rule; for several metalline substances must be excepted, particularly iron and copper.

The ninth column declares the affinities of sulphur. Fixed alkalis, iron, copper, lead, silver, regulus of antimony, mercury, and gold, stand below it in the order of their affinities. With regard to gold, it must be observed, that it will not unite with pure sulphur; it suf-

fers.

fers itself to be dissolved only by the liver of sulphur, which is known to be a composition of sulphur and fixed alkali.

At the head of the tenth column appears mercury, and beneath it several metalline substances, in the order of their affinities with it. Those metalline substances are gold, silver, lead, copper, zinc, and *regulus* of antimony.

The eleventh column shews that lead has a greater affinity with silver than with copper.

The twelfth, that copper has a greater affinity with mercury than with calamine.

The thirteenth, that silver has a greater affinity with lead than with copper.

The fourteenth contains the affinities of iron. *Regulus* of antimony stands immediately underneath it, as being the metallic substance which has the greatest affinity with it. Silver, copper, and lead, are placed together in the next square below, because the degrees of affinity which those metals have with iron are not exactly determined.

The same is to be said of the fifteenth column: *Regulus* of antimony stands at its head; iron is immediately below it; and below the iron the same three metals occupy one square as before.

Lastly, The sixteenth column indicates that water has a greater affinity with spirit of wine than with salts. By this general expression must not be understood any saline substance whatever; but only the neutral salts, which spirit of wine frees from the water that kept them in solution. Fixed alkalis, on the contrary, as well as the mineral acids, have a greater affinity than spirit of wine with water; so that these saline substances, being well dephlegmated and mixed with spirit of wine, imbibe the water it contains and rectify it.

### *The Theory of Constructing the Vessels most commonly used in Chemistry.*

CHEMISTS cannot perform the operations of their art without the help of a considerable number of vessels, instruments, and furnaces, adapted to contain the bodies on which they intend to work, and to apply to them the several degrees of heat required by different processes.

Vessels intended for chemical operations should be able to bear, without breaking, the sudden application of great heat and great cold; be impenetrable to every thing, and unalterable by any solvent; unvitrifiable, and capable of enduring the most violent fire without melting: But hitherto no vessels have been found with all these qualities united.

They are made of sundry materials, namely, of metal, of glass, and of earth. Metalline vessels, especially those made of iron or copper, are apt to be corroded by almost every saline, oily, or even aqueous substance. For this reason, in order to render the use of them a little more extensive, they are tinned on the inside. But, notwithstanding this precaution, they are on many occasions not to be trusted; and should never be employed in any nice operations which require great accuracy; they are, moreover, incapable of resisting the force of fire.

Earthen vessels are of several sorts. Some, that are made of a refractory earth, are capable of being suddenly exposed to a strong fire without breaking, and even of sustaining a great degree of heat for a considerable time: But they generally suffer the vapours of the matters which they contain, as well as vitrified metals, to pass through them; especially the glass of lead, which easily penetrates them, and runs through their pores, as through a sieve. There are others made of an earth, that, when well baked, looks as if it were half vitrified: These being much less porous are capable of retaining the vapours of the matters which they contain, and even glass of lead in fusion; which is one of the severest trials a vessel can be put to: But then they are more brittle than the other sort.

Good glass-vessels should constantly be employed in preference to all others, whenever they can possibly be used: And that not only because they are no way injured by the most active solvents, nor suffer any part of what they contain to pass through, but also because their transparency allows the chemist to observe what passes within them; which is always both curious and useful. But it is pity, that vessels of this sort should not be able to endure a fierce fire without melting.

Distillation, as hath been already said, is an operation by which we separate from a body, by the help of a gradual heat, the several principles of which it consists.

There are three methods of distilling. The first is performed by applying the heat over the body whose principles are to be extracted. In this case, as the liquors when heated and converted into vapours constantly endeavour to fly from the centre of heat, they are forced to re-unite in the lower part of the vessel that contains the matter in distillation, and so passing through the pores or holes of that vessel, they fall into another cold vessel applied underneath to receive them. This way of distilling is, on this account, called distilling *per descensum*. It requires no other apparatus than two vessels figured like segments of hollow spheres, whereof that which is pierced with little holes, and intended to contain the matter to be distilled, ought to be much less than the other which is to contain the fire, and close its aperture exactly; the whole together being supported vertically upon a third vessel, which is to serve the purpose of a recipient, admitting into its mouth the convex bottom of the vessel containing the matter to be distilled, which must accurately fill it. This method of distilling is but little used.

The second method of distilling is performed by applying the heat underneath the matter to be decomposed. On this occasion the liquors being heated, rarefied, and converted into vapours, rise, and are condensed in a vessel contrived for that purpose, which we shall presently describe. This way of distilling is called distilling *per ascensum*, and is much used.

The vessel in which the distillation *per ascensum* is performed, we call an alembic. Plate LXIV. fig. 1.

There are several sorts thereof differing from one another both in the matter of which, and the manner in which, they are made.

Those

Those employed to draw the odoriferous waters and essential oils of plants are generally made of copper, and consist of several pieces. The first, which is designed to contain the plant, is formed nearly like a hollow cone, the vertex whereof is drawn out in the shape of a hollow cylinder or tube: This part is named the cucurbit, Plate LXIV. fig. 1. A; and its tube the neck of the alembic B. To the upper end of this tube another vessel is soldered: This is called the head C, and commonly has likewise the form of a cone, joined to the neck of the alembic by its base, round which on the inside is hollowed a small groove communicating with an orifice that opens at its most depending part. To this orifice is soldered a small pipe in a direction sloping downwards, which is called the nose, spout, or beak D of the alembic.

As soon as the matters contained in the alembic grow hot, vapours begin to arise from them, and ascending through the neck of the alembic into the head, are by the sides thereof stopped and condensed: From thence they trickle down in little streams to the groove, which conveys them to the spout; and by that they pass out of the alembic into a glass vessel or receiver G with a long neck, the end of the spout being introduced into that neck and luted thereto.

To facilitate the refrigeration and condensation of the vapours circulating in the head, all alembics of metal are moreover provided with another piece, which is a kind of large pan of the same metal, fitted and soldered round the head. This piece serves to keep cold water in, which incessantly cools the head, and therefore it is called the refrigeratory E. The water in the refrigeratory itself grows hot after some time, and must therefore be changed occasionally; the heated water being first drawn off by means of a cock fixed near the bottom of the refrigeratory. All copper alembics should be tinned on the inside for the reasons already given.

When saline spirits are to be distilled, alembics of metal must not be used; because the saline vapours would corrode them. In this case recourse must be had to alembics of glass. These consist of pieces only; namely, a cucurbit, whose superior orifice is admitted into, and exactly luted with its head, which is the second piece.

In general, as alembics require that the vapours of the matter to be distilled should rise to a considerable height, they ought to be used only when the most volatile principles are to be drawn from bodies: And the lighter and more volatile the substances to be separated by distillation are, the taller must the alembic be; because the most ponderous parts, being unable to rise above a certain height, fall back again into the cucurbit as soon as they arrive there, leaving the lighter to mount alone, whose volatility qualifies them to ascend into the head.

When a matter is to be distilled that requires a very tall alembic, and yet does not admit of a metalline vessel, the end will be best answered by a glass vessel of a round or oval shape, having a very long neck, with a small head fitted to its extremity. Such a vessel serves many purposes: It is sometimes employed as a receiver, and at other times as a digesting vessel; on which last occasion it goes under the name of a matras, fig. 3. When

one of these provided with a head, (fig. 3. C), is applied to the purpose of distilling, it forms a sort of alembic.

There are some alembics of glass, blown in such a manner by the workmen, that the body and head form but one continued piece. As these alembics do not stand in need of having their several pieces luted together, they are very useful on some occasions, when such exceeding subtle vapours rise as are capable of transpiring through lutes. The head must be open at the top, and provided with a short tube, through which by means of a funnel with a long pipe, the matter to be distilled may be introduced into the cucurbit. This is to be exactly closed with a glass stopple, the surface whereof must be made to fit the inside of the tube in every point, by rubbing those two pieces well together with emery.

Another sort of alembic hath also been invented, which may be used with advantage when cohobation is required; that is, when the liquor obtained by distillation is to be returned upon the matter in the cucurbit; and especially when it is intended that this cohobation shall be repeated a great number of times. The vessel we are speaking of is constructed exactly in the same manner as that last described; except that its beak, instead of being in a straight line as in the other alembics, forms a circular arch, and re-enters the cavity of the cucurbit, in order to convey back again the liquor collected in the head. This instrument hath commonly two beaks opposite to each other, both turned in this manner, and is called a *pelican*: It saves the artist the trouble of frequently unluting and reluting his vessels, as well as the loss of a great many vapours.

There are certain substances which in distillation afford matters in a concrete form, or rise wholly in the form of a very light powder, called *flowers*. When such substances are to be distilled, the cucurbit which contains them is covered with a head without a nose, which is named a *blind-head*.

When the flowers rise in great quantities and very high, a number of heads is employed to collect them; or rather a number of a kind of pots, consisting of a body only without any bottom, which fitting one into the other form a canal, that may be lengthened or shortened at pleasure, according as the flowers to be sublimed are more or less volatile. The last of the heads, which terminates the canal, is quite close at one end, and makes a true blind-head. These vessels are called *aludels*: they are usually of earthen or stone ware.

All the vessels above mentioned are fit only for distilling such light volatile matters as can be easily raised and brought over; such as phlegm, essential oils, fragrant waters, acid oily spirits, volatile alkalis, &c. But when the point is to procure, by distillation, principles that are much less volatile, and incapable of rising high, such as the thick fetid oils, the vitriolic, the nitrous, and the marine acids, &c. we are under a necessity of having recourse to other vessels, and another manner of distilling.

It is easy to imagine, that such a vessel must be much lower than the alembic. It is indeed no more than a hollow globe, whose upper part degenerates into a neck

or tube, that is bent into a horizontal position; for which reason this instrument is called a *retort*: It is always of one single piece.

The matter to be distilled is introduced into the body of the retort by means of a ladle with a long tubular shank. Then it is set in a furnace built purposely for this use, and so that the neck of the retort coming out of the furnace may, like the the nose of the alembic, stand in a sloping position, to facilitate the egress of the liquors, which by its means are conveyed to a receiver, into which it is introduced, and with which it is luted. This way of distilling, in which the vapours seem rather to be driven out of the vessel horizontally and laterally, than raised up and sublimed, is for that reason called distillation *per latus*.

Retorts are, of all the instruments of distillation, those that must sustain the greatest heat, and resist the strongest solvents; and therefore they must not be made of metal. Some, however, which are made of iron may do well enough on certain occasions: The rest are either of glass or earth. Those of glass, for the reasons above given, are preferable to the other sort, in all cases where they are not to be exposed to such a force of fire as may melt them. The best glass, that which stands both heat and solvents best, is that in which there are fewest alkaline salts: Of this sort is the green German glass: The beautiful white crystal glass is far from being equally serviceable.

Retorts, as well as alembics, may be of different forms. For example, some matters are apt to swell and rise over the neck of the retort in substance without suffering any decomposition; when such matters are to be distilled in a retort, it is proper that the body of the vessel, instead of being globular, be drawn out into the form of a pear, so as nearly to resemble that of a cucurbit. In a retort of this kind, the distance between the bottom and the neck being much greater than in those whose bodies are spherical, the matters contained have much more room for expansion; so that the inconvenience here mentioned is thereby prevented. Retorts of this form are called English retorts: as they hold the middle place between alembics and common retorts, they may be used to distill such matters as have a mean degree of volatility between the greatest and the least.

It is moreover proper to have in a laboratory sundry retorts with necks of different diameters. Wide necks will be found the fittest for conveying thick matters, and such as readily become fixed; for instance, some very thick fetid oils, butter of antimony, &c. for as these matters acquire a consistence as soon as they are out of the reach of a certain degree of heat, they would soon choke up a narrow neck, and by stopping the vapours, which rise at the same time from the retort, might occasion the bursting of the vessels.

Some retorts are also made with an opening on their upper side, like that of tubulated glass alembics, which is to be closed in the same manner with a glass stopple. These retorts are also called *tubulated retorts*, and ought always to be used whenever it is necessary to introduce fresh matter into the retort during the operation; seeing it may be done by means of this invention, without un-

luting and reluting the vessels; which ought always to be avoided as much as possible.

One of the things that most perplexes the chemists is, the prodigious elasticity of many different vapours, which are frequently discharged with impetuosity during the distillation, and are even capable of bursting the vessels with explosion, and with danger to the artist. On such occasions it is absolutely necessary to give these vapours vent, as we shall direct in its proper place: But as that can never be done without losing a great many of them; as some of them in particular are so elastic, that scarce any at all would remain in the vessel; for instance, those of the spirit of nitre, and especially those of the smoking spirit of salt: the practice is to make use of very large receivers, of about eighteen or twenty inches diameter, that the vapours may have sufficient room to circulate in, and, by applying to the wide surface presented them by the extensive inside of such a large vessel, may be condensed into drops. These huge receivers are commonly in the form of hollow globes, and are called *ballons*.

To give these vapours still more room, ballons have been contrived with two open gullets in each, diametrically opposite to one another; whereof one admits the neck of the retort, and the other is received by one of the gullets of a second ballon of the same form, which is joined in like manner to a third, and so on. By this artifice the space may be enlarged at pleasure. These ballons with two necks are called *adapters*.

Operations on bodies that are absolutely fixed, as metals, stones, sand, &c. require only such vessels as are capable of containing those bodies and resisting the force of fire. These vessels are little hollow pots, of different dimensions, which are called crucibles. Crucibles can hardly be made of any thing but earth; they ought to have a cover of the same material fitted to shut them close. The best earth we know is that whereof those pots are made in which butter is brought from Bretagne: These pots themselves are exceeding good crucibles; and they are almost the only ones that are capable of holding glass of lead in fusion, without being penetrated by it.

For the roasting of ores, that is, freeing them by the help of fire from their sulphureous and arsenical parts, little cups made of the same material with crucibles are used; but they are made flat, shallow, and wider above than below, that these volatile matters may the more freely exhale. These vessels are called *tests*, or *scorifiers*: They are scarce used but in the docimastic art, that is, in making small assays of ores.

### *The Theory of constructing the Furnaces most commonly used in Chemistry.*

SKILL in conducting and applying fire properly, and determining its different degrees, is of very great consequence to the success of chemical operations.

As it is exceeding difficult to govern and moderate the action of fire, when the vessels in which any operation is performed are immediately exposed to it, chemists have contrived to convey heat to their vessels, in nice operations, through different mediums, which they place occasionally between those vessels and the fire.

Those

Those intermediate substances in which they plunge their vessels are called *baths*. They are either fluid or solid: -The fluid baths are water, or its vapours. When the distilling vessel is set in water, the bath is called *balneum marie*, or the water-bath; and the greatest degree of heat of which it is susceptible is that of boiling water. When the vessel is exposed only to the vapours which exhale from water, this forms the vapour-bath: the heat of which is nearly the same with that of the *balneum marie*. These baths are useful for distilling essential oils, ardent spirits, sweet-scented waters; in a word, all such substances as cannot bear a greater heat without prejudice either to their odour, or to some of their other qualities.

Baths may also be made of any other fluids, such as oils, mercury, &c. which are capable of receiving and communicating much more heat; but they are very seldom used. When a more considerable degree of heat is required, a bath is prepared of any solid matter reduced to a fine powder, such as sand, ashes, filings of iron, &c. The heat of these baths may be pushed so far as to make the bottom of the vessel become faintly red. By plunging a thermometer into the bath, by the side of the vessel, it is easy to observe the precise degree of heat applied to the substance on which you are working. It is necessary that the thermometers employed on this occasion be constructed on good principles, and so contrived as to be easily compared with those of the most celebrated natural philosophers. Those of the illustrious Reaumur are most used and best known, so that it would not be amiss to give them the preference. When a greater heat is required than any of those baths can give, the vessels must be set immediately on live-coals, or in a flaming fire: this is called working with a naked fire; and in this case it is much more difficult than in the other to determine the degrees of heat.

There are several ways of applying a naked fire. When the heat or flame is reflected upon the upper part of the vessel which is exposed to the fire, this is called a reverberated heat. A melting heat is that which is strong enough to fuse most bodies. A forging heat is that of a fire which is forcibly excited by the constant blast of a pair of bellows, or more.

There is also another sort of fire which serves very commodiously for many operations, because it does not require to be fed or frequently mended: This is afforded by a lamp with one or more wicks, and may be called a lamp-heat. It is scarce ever employed but to heat baths, in operations which require a gentle and long continued warmth: if it hath any fault, it is that of growing gradually hotter.

All these different ways of applying fire require furnaces of different constructions: We shall therefore describe such as are of principal and most necessary use.

Furnaces must be divided into different parts or stories, each of which has its particular use and name.

The lower part of the furnace designed for receiving the ashes, and giving passage to the air, is called the ash hole. The ash-hole is terminated above by a grate, the use of which is to support the coals and wood, which are to be burnt thereon: This part is called the fire-place.

The fire-place is in like manner terminated above by several iron bars, which lie quite across it from right to left, in lines parallel to each other: The use of these bars is to sustain the vessels in which the operations are to be performed. The space above these bats to the top of the furnace is the upper story, and may be called the laboratory of the furnace. Lastly, some furnaces are quite covered above, by means of a kind of vaulted roof called the dome.

Furnaces have moreover several apertures: one of these is at the ash-hole, which gives passage to the air, and through which the ashes that fall through the grate are raked out; this aperture is called the ash-hole door: another is at the fire-place, through which the fire is supplied with fuel, as occasion requires; this is called the mouth or door of the fire-place, or the stoke-hole: there is a third in the upper story, through which the neck of the vessel passes; and a fourth in the dome, for carrying off the fuliginosities of combustible matters, which is called the chimney.

To conclude, there are several other openings in the several parts of the furnace, the use whereof is to admit the air into those places, and also, as they can be easily shut, to incite or slacken the activity of the fire, and so to regulate it; which has procured them the title of *registers*. All the other openings of the furnace should be made to shut very close, the better to assist in governing the fire; by which means they likewise do the office of registers.

In order to our forming a just and general idea of the construction of furnaces, and of the disposition of the several apertures in them, with a view to increase or diminish the activity of the fire, it will be proper to lay down, as our ground-work, certain principles of natural philosophy, the truth of which is demonstrated by experience.

And first, every body knows that combustible matters will not burn or consume unless they have a free communication with the air; inasmuch that if they be deprived thereof, even when burning most rapidly, they will be extinguished at once: that consequently combustion is greatly promoted by the frequent accession of fresh air; and that a stream of air, directed so as to pass with impetuosity through burning fuel, excites the fire to the greatest possible activity.

Secondly, It is certain that the air which touches or comes near ignited bodies is heated, rarefied, and rendered lighter than the air about it; that is, further distant from the centre of heat: and consequently that this air so heated and become lighter is necessarily determined thereby to ascend and mount aloft, in order to make room for that which is less heated and not so light, which by its weight and elasticity tends to occupy the place quitted by the other. Another consequence hereof is, that if fire be kindled in a place inclosed every where but above and below, a current of air will be formed in that place, running in a direction from the bottom to the top; so that if any light bodies be applied to the opening below, they will be carried up towards the fire; but, on the contrary, if they be held at the opening above, they will be impelled by a force which will drive them up and carry them away from the fire.

Thirdly,



Thirdly, and lastly, it is a truth demonstrated in hydraulics, that the velocity of a given quantity of any fluid, determined to flow in any direction whatever, is so much the greater, the narrower the channel is to which that fluid is confined; and consequently that the velocity of a fluid will be increased by making it run from a wider through a narrower passage.

These principles being established, it is easy to apply them to the construction of furnaces. First, if a fire be kindled in the fire-place of a furnace, which is open on all sides, it burns nearly as if it were in the open air. It has with the surrounding air a free communication; so that fresh air is continually admitted to facilitate the entire combustion of the inflammable matters employed as fuel. But there being nothing to determine that air to pass with rapidity through the fire in this case, it does not at all augment the activity thereof, but suffers it to waste away quietly.

Secondly, If the ash-hole or dome of a furnace in which a fire is burning be shut quite close, then there is no longer any free communication between the air and the fire: if the ash-hole be shut, the air is debarred from having free access to the fire; if the dome be stopt, the egress of the air rarefied by the fire is prevented; and consequently the fire must in either case burn very faintly and slowly, gradually die away, and at last go quite out.

Thirdly, If all the openings of the furnace be wholly closed, it is evident that the fire will be very quickly extinguished.

Fourthly, If only the lateral openings of the fire-place be shut, leaving the ash-hole and upper part of the furnace open; it is plain that the air entering by the ash-hole will necessarily be determined to go out at top, and that consequently a current of air will be formed, which will pass through the fire, and make it burn briskly and vigorously.

Fifthly, If both the ash-hole and the upper story of the furnace be of some length, and form canals either cylindrical or prismatic, then the air being kept in the same direction through a longer space, the course of its stream will be both stronger and better determined, and consequently the fire will be more animated by it.

Sixthly, and lastly, if the ash hole and the upper part of the furnace, instead of being cylindrical or prismatic canals, have the form of truncated cones or pyramids, standing on their bases, and so ordered that the upper opening of the ash-hole adjoining to the fire-place may be wider than the base of the superior cone or pyramid; then the stream of air, being forced to pass incessantly from a larger channel through a smaller, must be considerably accelerated, and procure to the fire the greatest activity which it can receive from the make of a furnace.

The materials fittest for building furnaces are, 1. Bricks, joined together with potters clay mixed with sand, and moistened with water. 2. Potters clay mingled with potsherds, moistened with water, and baked in a violent fire. 3. Iron; of which all furnaces may be made; with this precaution, that the inside be provided with a great many prominent points, as fastenings for a coat of earth, with which the internal parts of the furnace

must necessarily be covered to defend it from the action of the fire.

The reverberating furnace is one of those that are most employed in chemistry: it is proper for distillations by the retort, and should be constructed in the following manner.

First, The use of the ash-hole being, as was said, to give passage to the air, and to receive the ashes, no bad consequence can attend its being made pretty high: It may have from twelve to twenty or twenty-four inches in height. Its aperture should be wide enough to admit billets of wood when a great fire is to be made.

Secondly, The ash-hole must be terminated at its upper part by an iron grate, the bars of which should be very substantial, that they may resist the action of the fire: this grate is the bottom of the fire-place, and destined to support the coals. In the lateral part of the fire-place, and nearly about the same height with the grate, there should be a hole of such a size that it may easily admit charcoal, as well as little tongs and shovels for managing the fire. This aperture or mouth of the fire-place should be perpendicularly over the mouth of the ash-hole.

Thirdly, from six to eight or ten inches high above the grate, over the ash-hole, little apertures must be made in the walls of the furnace, of eight or ten lines in diameter, an inch from one another, and those in one side must be diametrically opposite to those in the other. The use of these holes is to receive bars of iron for the retort to rest on; which should be, as was said, at different heights, in order to accommodate retorts of different sizes. At the upper extremity of this part of the furnace, which reaches from the iron bars to the top, the height whereof should be somewhat less than the width of the furnace, must be cut a semi-circular aperture for the neck of the retort to come through. This hole must by no means be over the doors of the fire-place and ash-hole; for then, as it gives passage to the neck of the retort, it must of course be opposite to the receiver, and in that case the receiver itself would stand over against those two apertures; which would be attended with this double inconvenience, that the receiver would not only grow very hot, but greatly embarrass the operator, whose free access to the fire-place and ash-hole would be thereby obstructed. It is proper therefore, that the semi-circular cut we are speaking of be so placed, that, when the greatest ballons are luted to the retort, they may leave an open passage to the fire-place or ash-hole.

Fourthly, in order cover in the laboratory of the reverberating furnace, there must be a roof made for it in the form of a cupola, or concave hemisphere, having the same diameter as the furnace. This dome should have a semi-circular cut in its rim answering to that above-mentioned to be made in the upper extremity of the furnace, so that, when adjusted to each other, the two together may form a circular hole for the neck of the retort to pass through. At the top of this dome there must also be a circular hole of three or four inches diameter, carrying a short tapering funnel of the same diameter, and three inches high, which will serve for a chimney



chimney to carry off all fuliginosities, and accelerate the current of the air. This passage may be shut at pleasure with a flat cover. Moreover, as it is necessary that the dome should be taken off and put on with ease, it should have two ears or handles for that purpose: a portable or moveable furnace should also have a pair of handles fixed opposite to each other between the ash-hole and the fire place.

Sixthly and lastly, a conical canal must be provided of about three foot long, and sufficiently wide at its lower end to admit the funnel of the aperture at the top of the dome. This conical tube is to be applied to the dome when the fire is required to be extremely active: it tapers gradually from its base upwards, and breaks off as if truncated at top, where it should be about two inches wide.

Besides the apertures already mentioned as necessary to a reverberating furnace, there must also be many other smaller holes made in its ash-hole, fire-place, laboratory, and dome, which must all be so contrived as to be easily opened and shut with stopples of earth: these holes are the registers of the furnace, and serve to regulate the activity of the fire according to the principles before laid down.

When the action of the fire is required to be exactly uniform and very brisk, it is necessary to stop carefully with moist earth all the little chinks in the juncture of the dome with the furnace, between the neck of the retort and the circular hole through which it passes, and which it never fills exactly, and lastly the holes which receive the iron bars that sustain the retort.

It is proper to have in a laboratory several reverberating furnaces of different magnitudes; because they must be proportioned to the size of the retorts employed. The retort ought to fill the furnace, so as to leave only the distance of an inch between it and the inside of the furnace.

Yet when the retort is to be exposed to a most violent fire, and especially when it is required that the heat shall act with equal force on all parts of the furnace, and as strongly on its vault as on its bottom, a greater distance must be left between the retort and the inside of the furnace; for then the furnace may be filled with coals, even to the upper part of the dome. If moreover some pieces of wood be put into the ash-hole, the conical canal fitted on to the funnel of the dome, and all the apertures of the furnace exactly closed, except the ash-hole and the chimney, the greatest heat will then be excited that this furnace can produce.

The furnace now described may also be employed in many other chemical operations. If the dome be laid aside, an alembic may very well be placed therein: but then the space, which will be left between the body of the alembic and the top of the upper part of the furnace, must be carefully filled up with Windsor-loam moistened; for without that precaution the heat would soon reach the very head, which ought to be kept as cool as possible, in order to promote the condensation of the vapours.

On this occasion therefore it will be proper to leave no holes open in the fire-place, but the lateral ones; of

which also those over against the receiver must be stopped.

A pot or broad-brimmed earthen pan may be placed over this furnace, and being so fitted to it as to close the upper part thereof accurately, and filled with sand, may serve for a sand-heat to distill with.

The bars designed to support distilling vessels being taken out, a crucible may stand therein, and many operations be performed that do not require the utmost violence of fire. In a word, this furnace is one of the most commodious that can be, and more extensively useful than any other.

The melting furnace is designed for applying the greatest force of heat to the most fixed bodies, such as metals and earths. It is never employed in distilling: it is of no use but for calcination and fusion; and consequently need not admit any vessels but crucibles.

The ash-hole of this furnace differs from that of the reverberating furnace only in this, that it must be higher, in order to raise the fire-place to a level with the artist's hand; because in that all the operations of this furnace are performed. The ash-hole therefore must be about three foot high: and this height procures it moreover the advantage of a good draught of air. For the same reason, and in consequence of the principles we laid down, it should be so built that its width lessening insensibly from the bottom to the top, it may be narrower where it opens into the fire-place than any where below.

The ash-hole is terminated at its upper end, like that of the reverberating furnace, by a grate which serves for the bottom of the fire-place, and ought to be very substantial that it may resist the violence of the fire. The inside of this furnace is commonly an elliptic curve; because it is demonstrated by mathematicians, that surfaces having that curvature reflect the rays of the sun, or of fire, in such a manner, that, meeting in a point or a line, they produce there a violent heat. But to answer this purpose, those surfaces must be finely polished; an advantage hardly procureable to the internal surface of this furnace, which can be made of nothing but earth: besides, if it were possible to give it a polish, the violent action of the fire that must be employed in this furnace would presently destroy it. Yet the elliptical figure must not be entirely disregarded: for, if care be taken to keep the internal surface of the furnace as smooth as possible, it will certainly reflect the heat pretty strongly, and collect it about the center.

The fire-place of this furnace ought to have but four apertures.

First, that of the lower grate, which communicates with the ash-hole.

Secondly, a door in its fore-side, through which may be introduced coals, crucibles, and tongs for managing them: this aperture should be made to shut exactly with a plate of iron, having its inside coated with earth, and turning on two hinges fixed to the furnace.

Thirdly, over this door a hole slanting downwards towards the place where the crucible is to stand. The use of this hole is to give the operator an opportunity of examining

aming the condition of the matters contained in his crucible, without opening the door of the fire-place: this hole should be made to open and shut easily, by means of a stopple of earth.

Fourthly, a circular aperture of about three inches wide in the upper part or vault of the furnace, which should gradually lessen and terminate, like that of the dome of the reverberating furnace, in a short conical funnel of about three inches long, and fitted to enter the conical pipe before described, which is applied when the activity of the fire is to be increased.

When this furnace is to be used, and a crucible to be placed in it, care must be taken to set on the grate a cake of baked earth somewhat broader than the foot of the crucible. The use of this stand is to support the crucible, and raise it above the grate, for which purpose it should be two inches thick. Were it not for this precaution, the bottom of the crucible, which would stand immediately on the grate, could never be thoroughly heated, because it would be always exposed to the stream of cold air which enters by the ash-hole. Care should also be taken to heat this earthen bottom red-hot before it be placed in the furnace, in order to free it from any humidity, which might otherwise happen to be driven against the crucible during the operation, and occasion its breaking.

We omitted to take notice, in speaking of the ash hole, that, besides its door, it should have about the middle of its height a small hole, capable of receiving the nose of a good perpetual bellows, which is to be introduced into it and worked, after the door is exactly shut, when it is thought proper to excite the activity of the fire to the utmost violence.

The forge is only a mass of bricks of about three foot high, along whose upper surface is directed the nose or pipe of a pair of large perpetual bellows, so placed that the operator may easily blow the fire with one hand. The coals are laid on the hearth of the forge near the nose of the bellows; they are confined, if necessary, to prevent their being carried away by the wind of the bellows, within a space inclosed by bricks; and then by pulling the bellows the fire is continually kept up in its greatest activity. The forge is of use when there is occasion to apply a great degree of heat suddenly to any substance, or when it is necessary that the operator be at liberty to handle frequently the matters which he proposes to fuse or calcine.

The cupelling furnace is that in which gold and silver are purified, by the means of lead, from all alloy of other metallic substances. This furnace must give a heat strong enough to vitrify lead, and therewith all the alloy which the perfect metals may contain. This furnace is to be built in the following manner.

First, of thick iron-plates, or of some such composition of earth as we recommended for the construction of furnaces, must be formed a hollow quadrangular prism, whose sides may be about a foot broad, and from ten to eleven inches high; and extending from thence upwards may converge towards the top, so as to form a pyramid truncated at the height of seven or eight inches, and terminated by an aperture of the width of seven or eight

inches every way. The lower part of the prism is terminated and closed by a plate of the same materials of which the furnace is constructed.

Secondly, in the fore-side or front of this prism there is an opening of three or four inches in height by five or six inches in breadth: this opening, which should be very near the bottom, is the door of the ash-hole. Immediately over this opening is placed an iron grate, the bars of which are quadrangular prisms of half an inch square, laid parallel to each other, and about eight or nine inches asunder, and so disposed that two of their angles are laterally opposite, the two others looking one directly upwards, and the other downwards. As in this situation the bars of the grate present to the fire-place very oblique surfaces, the ashes and very small coals do not accumulate between them, or hinder the free entrance of the air from the ash-hole. This grate terminates the ash-hole at its upper part, and serves for the bottom of the fire-place.

Thirdly, three inches, or three and a half, above the grate, there is in the fore-side of the furnace another opening terminated by an arch for its upper part, which consequently has the figure of a semi-circle: it ought to be four inches wide at bottom, and three inches and an half high at its middle. This opening is the door of the fire-place; yet it is not intended for the same uses as the door of the fire-place in other furnaces: the purpose for which it is actually destined shall be explained when we come to shew how the furnace is to be used. An inch above the door of the fire-place, still in the fore-side of the furnace, are two holes of about an inch diameter, and at the distance of three inches and a half from each other, to which answer two other holes of the same size; made in the hinder part, directly opposite to these. There is, moreover, a fifth hole of the same width about an inch above the door of the fire-place. The design of all these holes shall be explained when we describe the manner in which these furnaces are to be used.

Fourthly, the fore-part of the furnace is bound by three iron braces, one of which is fixed just below the door of the ash-hole; the second occupies the whole space between the ash-hole door and the door of the fire-place, and has two holes in it, answering to those which we directed to be made in the furnace itself about this place; and the third is placed immediately over the door of the fire-place. These braces must extend from one corner of the front of the furnace to the other, and be fastened thereto with iron pins, in such a manner that their sides next to the doors may not lie quite close to the body of the furnace, but form a kind of grooves for the iron plates to slide in, that are designed to shut the two doors of the furnace when it is necessary. Each of these iron plates should have a handle, by which it may be conveniently moved; and to each door there should be two plates, which meeting each other, and joining exactly in the middle of the door-place, may shut it very close. Each of the two plates belonging to the door of the fire-place ought to have a hole in its upper part; one of these holes should be a slit of about two lines wide, and half an inch long; the other may be a semi-circular opening of one inch in height and two in  
breadth.

breadth. These holes should be placed so that neither of them may open into the fire-place when the two plates are joined together in the middle of the door to shut it close.

Fifthly, to terminate the furnace above, there must be a pyramid, formed of the same materials with the furnace, hollow, quadrangular, three inches high, on a base of seven inches, which base must exactly fit the upper opening of the furnace: the top of this pyramidal cover must end in a tube of three inches in diameter and two in height, which must be almost cylindrical, and yet a little inclining to the conical form. This tube serves, as in the furnaces already described, to carry the conical funnel, which is fitted to the upper part when a fire of extraordinary activity is wanted.

The furnace thus constructed is fit to serve all the purposes for which it is designed; yet, before it can be used, another piece must be provided, which, though it does not properly belong to the furnace, is nevertheless necessary in all the operations performed by it; and that is a piece contrived to contain the cupels, or other vessels which are to be exposed to the fire in this furnace. It is called a *muffle*, and is made in the following manner.

On an oblong square, of four inches in breadth, and six or seven in length, a concave semi-cylinder is erected, in the form of a vault, which makes a semi-circular canal, open at both ends. One of these is almost entirely closed, except that near the bottom two small semi-circular holes are left. In each of its sides likewise two such holes are made, and the other end is left quite open.

The muffle is intended to bear and communicate the fiercest heat; and therefore it must be made thin, and of an earth that will resist the violence of fire, such as that of which crucibles are made. The muffle being thus constructed, and then well baked, is fit for use.

When it is to be used, it must be put into the furnace by the upper opening, and set upon two iron bars, introduced through the holes made for that purpose below the door of the fire-place. The muffle must be placed on these bars in the fire-place, in such a manner that its open end shall stand next to and directly against the door of the fire-place, and may be joined to it with lute. Then the cupels are ranged in it, and the furnace is filled up, to the height of two or three inches above the muffle, with small coals not bigger than a walnut, to the end that they may lie close round the muffle, and procure it an equal heat on every side. The chief use of the muffle is to prevent the coals and ashes from falling into the cupels, which would be very prejudicial to the operations carrying on in them: for the lead would not vitrify as it ought, because the immediate contact of the coals would continually restore its phlogiston; or else the glass of lead, which ought to penetrate and pass through the cupels, would be rendered incapable of so doing; because the ashes mixing therewith would give it such a consistence and tenacity as would destroy that property, or at least considerably lessen it. The openings, therefore, which are left in the lower part of the muffle, should not be so high as to admit coals or ashes to get into the cupels; the use of them is to procure an easier passage for the heat and the air to those vessels. The muffle is left quite

open in its fore-part, that the operator may be at liberty to examine what passes in the cupels, to stir their contents, to remove them from one place to another, to convey new matters into them, &c. and also to promote the free access of the air, which must concur with the fire towards the evaporation necessary to the vitrification of lead; which air, if fresh were not often enough admitted, would be incapable of producing that effect; because it would soon be loaded with such a quantity of vapours that it could not take up any more.

The government of the fire in this furnace is founded on the general principles above laid down for all furnaces. Yet as there are some little differences, and as it is very essential to the success of the operations for which this furnace is intended, that the artist should be absolutely master of his degree of heat, we shall in few words shew how that may be raised or lowered.

When the furnace is filled with coals and kindled, if the door of the ash-hole be set wide open, and that of the fire place shut very close, the force of the fire is increased; and if, moreover, the pyramidal cover be put on the top, and the conical funnel added to it, the fire will become still more fierce.

Seeing the matters contained in this furnace are encompassed with fire on all sides, except in the fore part opposite to the door of the fire place, and as there are occasions which require that the force of the fire should be applied to this part also, an iron box, of the shape and size of the door, hath been contrived to answer that purpose. This box is filled with lighted coals, and applied immediately to the door-place, by which means the heat there is considerably augmented. This help may be made use of at the beginning of the operation, in order to accelerate it, and bring the heat sooner to the desired degree; or in case a very fierce heat be required; or at a time when the air being hot and moist will not make the fire burn with the necessary vigour.

The heat may be lessened, by removing the iron box, and shutting the door of the fire-place quite close. It may be still further and gradually diminished, by taking off the conical funnel from the top; by shutting the door of the fire-place with one of its plates only, that which has the least, or that which has the greatest aperture in it; by taking off the pyramidal cover; by shutting the ash-hole door wholly or in part; and lastly, by setting the door of the fire-place wide open: but, in this last case, the cold air penetrates into the cavity of the muffle, and refrigerates the cupels more than is almost ever necessary. If it be observed, during the operation, that the muffle grows cold in any particular part, it is a sign there is a vacancy left by the coals in that place: in this case an iron wire must be thrust into the furnace, through the hole which is over the door of the fire-place, and the coals stirred therewith, so as to make them fall into their places and fill up the vacant interstices.

It is proper to observe, that, besides what has been said concerning the ways of increasing the activity of the fire in the cupelling furnace, several other causes also may concur to procure to the matters contained in the muffle a greater degree of heat: for example, the smaller the muffle is, the wider and more numerous the holes in it are;

are; the nearer to its bottom, or further end, the cupels are placed, the more will the matters therein contained be affected with heat.

Besides the operations to be performed by the cupel, this furnace is very useful, and even necessary, for many chemical experiments; such, for instance, as those relating to sundry vitrifications and enamelling. As it is pretty low, the best way is to place it, when it is to be used, on a base of brick-work that may raise it to a level with the operator's hand.

A lamp-furnace is exceeding useful for all operations that require only a moderate, but long continued degree of heat. The furnace for working with a lamp heat is very simple: it consists only of a hollow cylinder, from fifteen to eighteen inches high, and five or six in diameter, having at its bottom an aperture large enough for a lamp to be introduced and withdrawn with ease. The lamp must have three or four wicks, to the end that by lighting more or fewer of them a greater or less degree of heat may be produced. The body of the furnace must moreover have several small holes in it, in order to supply the flame of the lamp with air enough to keep it alive.

On the top of this furnace stands a basin five or six inches deep, which ought to fill the cavity of the cylinder exactly, and to be supported at its circumference by a rim which may entirely cover and close the furnace: The use of this basin is to contain the sand through which the lamp-heat is usually conveyed.

Besides this, there must be a kind of cover or dome made of the same material with the furnace, and of the same diameter with the sand-bath, without any other opening than a hole, nearly circular, cut in its lower extremity. This dome is a sort of reverberatory, which serves to confine the heat and direct it towards the body of the retort; for it is used only when something is to be distilled in a vessel of this fashion; and then the hole at its bottom serves for a passage to the neck of the retort. This dome should have an ear or handle, for the convenience of putting it on and taking it off with ease.

#### *Of Lutes.*

CHEMICAL vessels, especially such as are made of glass, and the earthen vessels commonly called stoneware, are very subject to break when exposed to sudden heat or cold; whence it comes that they often crack when they begin to heat, and also when being very hot they happen to be cooled, either by fresh coals thrown into the furnace, or by the access of cold air. There is no way to prevent the former of these accidents, but by taking the pains to warm your vessel very slowly, and by almost insensible degrees. The second may be avoided by coating the body of the vessel with a paste or lute, which being dried will defend it against the attacks of cold.

The fittest stuff for coating vessels is a composition of fat earth, Windfor-loam, fine sand, filings of iron, or powdered glass, and chopped cow's hair, mixed and made into a paste with water. This lute serves also to defend glass vessels against the violence of the fire, and to prevent their melting easily.

In almost all distillations it is of great consequence,

as hath been said, that the neck of the distilling vessel be exactly joined with that of the receiver into which it is introduced, in order to prevent the vapours from escaping into the air and so being lost: And this junction is effected by means of a lute.

A few slips of paper, applied round the neck of the vessels with common lute, will be sufficient to keep in such vapours as are aqueous, or not very spirituous.

If the vapours are more acrid and more spirituous, recourse may be had to slips of bladder long steeped in water, which, containing a sort of natural glue, close the junctures of the vessels very well.

If it be required to confine vapours of a still more penetrating nature, it will be proper to employ a lute that quickly grows very hard; particularly a paste made with quick-lime and any sort of jelly, whether vegetable or animal; such as the white of an egg, stiff size, &c. This is an excellent lute, and not easily penetrated. It is also used to stop any cracks or fractures that happen to glass vessels. But it is not capable of resisting the vapours of mineral acid spirits, especially when they are strong and smoking: For that purpose it is necessary to incorporate the other ingredients thoroughly with fat earth softened with water; and even then it frequently happens that this lute is penetrated by acid vapours, especially those of the spirit of salt, which of all others are confined with the greatest difficulty.

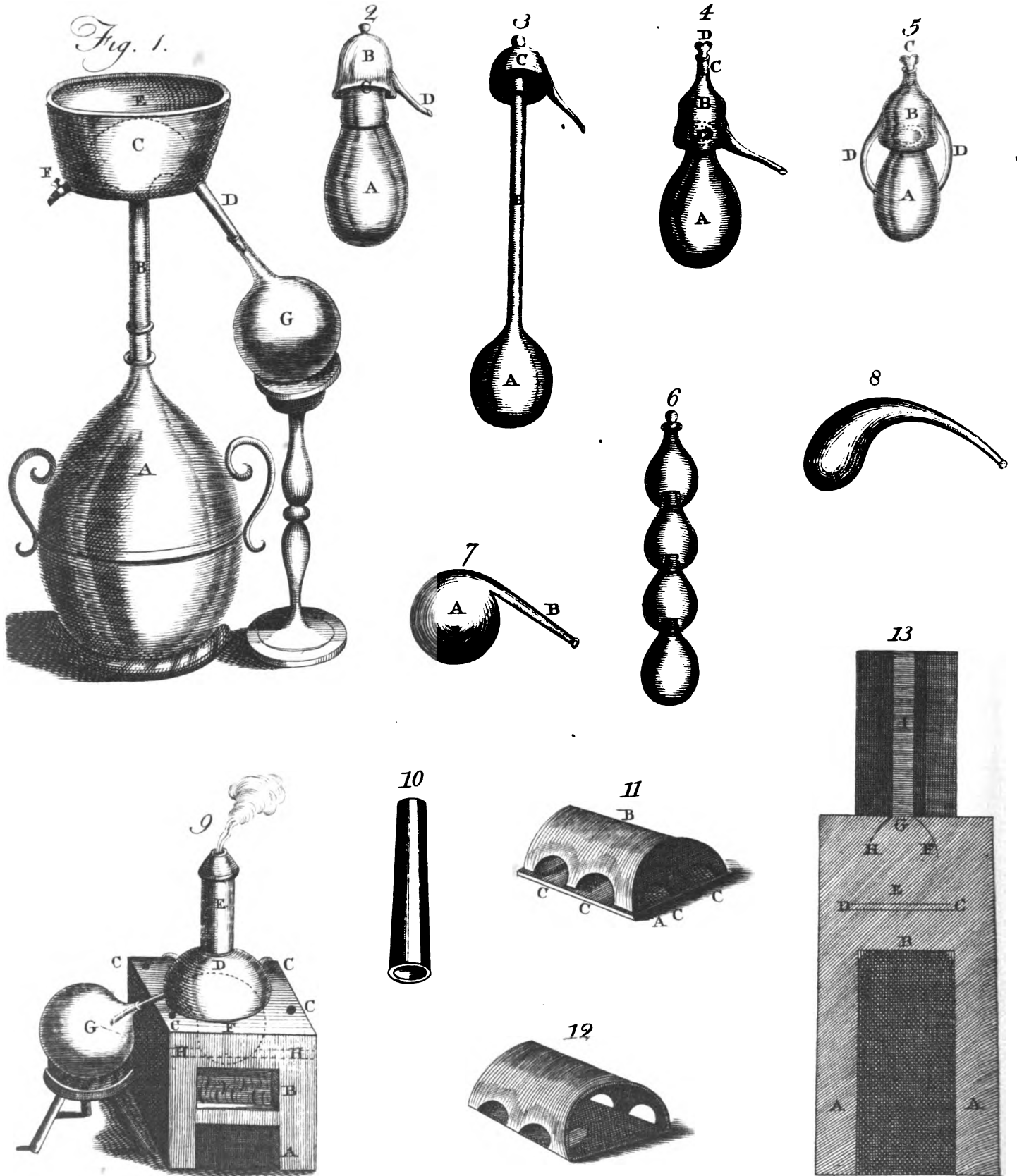
In such cases its place may be supplied with another, which is called fat lute, because it is actually worked up with fat liquors. This lute is composed of a very fine cretaceous earth, called tobacco-pipe clay, moistened with equal parts of the drying oil of lint-seed, and a varnish made of amber and gum copal. It must have the consistence of a stiff paste. When the joints of the vessels are closed up with this lute, they may, for greater security, be covered over with slips of linen smeared with the lute made of quick-lime and the white of an egg.

Chemical vessels are liable to be broken in an operation by other causes besides the sudden application of heat or cold. It frequently happens that the vapours of the matters, exposed to the action of fire, rush out with such impetuosity, and are so elastic, that finding no passage through the lute with which the joints of the vessels are closed, they burst the vessels themselves, sometimes with explosion and danger to the operator.

To prevent this inconvenience, it is necessary, that in every receiver there be a small hole, which being stopped only with a little lute may easily be opened and shut again as occasion requires. It serves for a vent-hole to let out the vapours, when the receiver begins to be too much crowded with them. Nothing but practice can teach the artist when it is requisite to open this vent. If he hits the proper time, the vapours commonly rush out with rapidity, and a considerable hissing noise; and the vent should be stopped again as soon as the hissing begins to grow faint. The lute employed to stop this small hole ought always to be kept so ductile, that by taking the figure of the hole exactly it may entirely stop it. Besides, if it should harden upon the glass, it would stick so fast, that it would be very difficult to remove it without breaking

ing





ing the vessel. This danger is easily avoided by making use of the fat lute, which continues pliant for a long time, when it is not exposed to an excessive heat.

This way of stopping the vent-hole of the receiver has yet another advantage: For if the hole be of a proper width, as a line and half, or two lines, in diameter, then when the vapours are accumulated in too great a quantity, and begin to make a great effort against the sides of the receiver, they push up the stopple, force it out, and make their way through the vent-hole: So that by this means the breaking of the vessels may always be certainly prevented. But great care must be taken that the vapours be not suffered to escape in this manner, except when absolute necessity requires it; for it is generally the very strongest and most subtle part of a liquor which is thus dissipated and lost.

Heat being the chief cause that puts the elasticity of the vapours in action, and prevents their condensing into a liquor, it is of great consequence in distillation that the receiver be kept as cool as possible. With this view a thick plank should be placed between the receiver and the body of the furnace, to intercept the heat of the latter, and prevent its reaching the former. As the vapours themselves rise very hot from the distilling vessel, they soon communicate their heat to the receiver, and especially to its upper part, against which they strike first. For this reason it is proper, that linen cloths dipt in very cold water be laid over the receiver, and frequently shifted. By this means the vapours will be considerably cooled, their elasticity weakened, and their condensation promoted.

By what hath been said in this first part, concerning the properties of the principal agents in chemistry, the construction of the most necessary vessels and furnaces, and the manner of using them, we are sufficiently prepared for proceeding directly to the operations, without being obliged to make frequent and long stops, in order to give the necessary explanations on those heads.

Nevertheless, we shall take every proper occasion to extend the theory here laid down, and to improve it by the addition of several particulars, which will find their places in our treatise of chemical operations.

EXPLANATION of PLATE LXIV.

FIG. 1. *A copper alembic.* A, The cucurbit or body. B, the neck. C, The head. D, The beak,

nose, or spout. E, The refrigeratory, or cooler. F, Its cock. G, The receiver.

Fig. 2. *A glass alembic.* A, The cucurbit. B, The head. C, The gutter within the head. D, The beak.

Fig. 3. *A long-necked glass alembic.* A, The body of the matras. B, The neck. C, The head.

Fig. 4. *A glass alembic of one piece.* A, The cucurbit. B, The head. C, The aperture in the head. D, Its stopple. E, The mouth of the cucurbit.

Fig. 5. *A pelican.* A, The cucurbit. B, The head. C, The aperture in the head, with its stopple. D D, The two curved spouts.

Fig. 6. *A row of aludels.*

Fig. 7. *A retort.* A, Its bowl. B, Its neck.

Fig. 8. *An English retort.*

Fig. 9. *A reverberating furnace.* A, The ash-hole door. B, The fire-place door. C C C C, Registers. D, The dome, or reverberatory. E, The conical funnel. F, The retort in the furnace. G, The receiver. H H, Iron bars to sustain the retort.

Fig. 10. *The conical furnace by itself.*

Fig. 11. *Back-view of a muffle.* A, The bottom of the muffle. B, Its arch. C C C, Lateral apertures.

Fig. 12. *Fore-view of a muffle.*

Fig. 13. *A melting furnace.* A A, The base of the furnace. B, The ash-hole. C D, The grate for the fire. E, The fire-place. F G H, Curvature of the inside of the upper part of the fire-place. I, The shaft, or chimney.

PLATE LXV. Fig. 1. *A cupelling furnace.* A, The ash-hole. B B, Its sliding doors. C, The fire-place. D D, Its sliding doors. E F, Small apertures in the sliders. G G, Holes for bars to bear the muffles. H H H, Iron braces in the fore-part of the furnace, which form grooves for the doors of the fire-place and ash-hole to slide in. I, The upper pyramidal part of the furnace. K, An aperture therein for managing the coals. L, The opening at top. M, The pyramidal cover. N, The chimney, or end of the shaft, on which the conical funnel may be fitted. O O O O, Handles for moving the sliding-doors. P P, Ears of the pyramidal covers.

PART II. PRACTICE OF CHEMISTRY.

Of the VITRIOLIC ACID.

To extract Vitriol from the Pyrites.

TAKE any quantity you please of iron pyrites; leave them for some time exposed to the air: They will crack, split, lose their brightness, and fall into powder. Put this powder into a glass cucurbit, and pour upon it twice

its weight of hot water; stir the whole with a stick, and the liquor will grow turbid. Pour it while it is yet warm into a glass funnel lined with brown filtering paper; and having placed your funnel over another glass cucurbit, let the liquor drain into it. Pour more hot water on the powdered pyrites, filter as before, and so go on, every time lessening the quantity of water, till that which comes off the pyrites appears to have no astringent vitriolic taste.

Put all these waters together into a glass vessel that widens upwards; set it on a sand bath, and heat the liquor till a considerable smoke arises; but take care not to make it boil. Continue the same degree of fire till the surface of the liquor begins to look dim, as if some dust had fallen into it; then cease evaporating, and remove the vessel into a cool place: In the space of four and twenty hours there will be formed therein a quantity of crystals, of a green colour and a rhomboidal figure: These are vitriol of Mars, or copperas. Decant the remaining liquor; add thereto twice its weight of water; filter, evaporate, and crystallize as before: repeat these operations till the liquor will yield no more crystals, and keep by themselves the crystals obtained at each crystallisation.

In large works for extracting vitriol from the pyrites, they proceed thus. They collect a great quantity of pyrites on a piece of ground exposed to the air, and pile them up in heaps of about three foot high. There they leave them exposed to the action of the air, sun, and rain, for three years together; taking care to turn them every six months, in order to facilitate the efflorescence of those which at first lay undermost. The rain-water which has washed those pyrites is conveyed by proper channels into a cistern; and when a sufficient quantity thereof is gathered, they evaporate it to a pellicle in large leaden boilers, having first put into it a quantity of iron, some part of which is dissolved by the liquor, because it contains a vitriolic acid that is not fully saturated therewith. When it is sufficiently evaporated, they draw it off into large leaden or wooden coolers, and there leave it to shoot into crystals. In these last vessels several sticks are placed, crossing each other in all manner of directions, in order to multiply the surfaces on which the crystals may fasten.

*To extract Sulphur from the Pyrites, and other sulphurous Minerals.*

REDUCE to a coarse powder any quantity of yellow pyrites, or other mineral containing sulphur. Put this powder into an earthen or glass retort, having a long wide neck, and so large a body that the matter may fill but two thirds of it. Set the retort in a sand-bath fixed over a reverberating furnace: Fit to it a receiver half full of water, and so placed that the nose of the retort may be about an inch under the water: Give a gradual fire, taking care you do not make it so strong as to melt the matter. Keep the retort moderately red for one hour, or an hour and half, and then let the vessels cool.

Almost all the sulphur, separated by this operation from its matrix, will be found at the extremity of the neck of the retort, being fixed there by the water. You may get it out either by melting it with such a gentle heat as will not set it on fire, or by breaking the neck of the retort.

*To extract Alum from aluminous Minerals.*

TAKE such minerals as are known or suspected to contain alum. Expose them to the air, that they may effloresce. If they remain there a year without any sensible

change, calcine them, and then leave them exposed to the air, till a bit thereof being put on the tongue imparts an astringent aluminous taste.

When your matters are thus prepared, put them into a leaden or glass vessel; pour upon them thrice their weight of hot water; boil the liquor; filter it; and repeat these operations till the earth be so edulcorated that the water which comes off it hath no taste. Mix all these solutions together, and let them stand four and twenty hours, that the gross and earthy parts may settle to the bottom; or else filter the liquor: then evaporate till it will bear a new-laid egg. Now let it cool, and stand quiet four and twenty hours: in that time some crystals will shoot, which are most commonly vitriolic; for alum is rarely obtained by the first crystallisation. Remove these vitriolic crystals: if any crystals of alum be found amongst them, these must be dissolved anew, and set to crystallise a second time in order to their purification; because they partake of the nature as well as of the colour of vitriol. By this method extract all the alum that the liquor will yield.

If you get no crystals of alum by this means, boil your liquor again, and add to it a twentieth part of its weight of a strong alkaline lixivium, or a third part of its weight of putresced urine, or a small quantity of quick-lime. Experience and repeated trials must teach you which of these three substances is to be preferred, according to the particular nature of the mineral on which you are to operate. Keep your liquor boiling, and if there be any alum in it, there will appear a white precipitate; in that case let it cool and settle. When the white precipitate is entirely fallen, decant the clear, and leave the crystals of alum to shoot at leisure, till the liquor will yield no more; it will then be exceeding thick.

Alum is obtained from several sorts of minerals. In some parts of Italy, and in sundry other places, it effloresces naturally on the surface of the earth. There it is swept together with brooms, and thrown into pits full of water. This water is impregnated therewith till it can dissolve no more. Then it is filtered, and set to evaporate in large leaden vessels; and when it is sufficiently evaporated, and ready to shoot into crystals, it is drawn off into wooden coolers, and there left for the salt to crystallise.

In aluminous soils there are often found springs strongly impregnated with alum; so that to obtain it the water need only be evaporated.

In the country about Rome there is a very hard stone, which is hewn out of the quarry, just like other stones for building: this stone yields a great deal of alum. In order to extract it, the stones are calcined for twelve or fourteen hours; after which they are exposed to the air in heaps, and carefully watered three or four times a day for forty days together. In that time they begin to effloresce, and to throw out a reddish matter on their surface. Then they are boiled in water, which dissolves all the alum they contain, and being duly evaporated gives it back in crystals. This is the alum called Roman alum.

Several sorts of pyrites also yield a great deal of alum. The English have a stone of this kind, which in colour is very like a slate. This stone contains much sulphur, which



which they get rid of by roasting it. After this they steep the calcined stone in water, which dissolves the alum it contains, and to this solution they add a certain quantity of a lye made of the ashes of sea-weeds.

*To extract the Vitriolic Acid from Green Vitriol.*

TAKE any quantity of green vitriol: put it in an unglazed earthen vessel, and heat it gradually. Vapours will soon begin to rise. Increase the fire a little, and it will liquify by means of the water contained in it, and acquire what we called an *aqueous fluor*. Continue the calcination, and it will become less and less fluid, grow thick, and turn of a greyish colour. Now raise your fire, and keep it up till the salt recover its solidity, acquire an orange colour, and begin to grow red where it immediately touches the sides of the vessel. Then take it out and reduce it to powder.

Put the vitriol thus calcined and pulverised into a good earthen retort, of which one half at least must remain empty. Set the retort in a reverberatory furnace: Fit thereto a large glass receiver, and, having luted the joint well, give fire by degrees. You will soon see white clouds rise into the receiver, which will render it opaque and heat it. Continue the same degree of fire till these clouds disappear: They will be succeeded by a liquor which will trickle down the sides of the receiver in veins. Still keep up the fire to the same degree as long as these veins appear. When they begin to abate, increase the fire, and push it to the utmost extremity: Upon this there will come over a black, thick liquor: It will even be found congealed, and prove the icy oil of vitriol, if care hath been taken to change the receiver, keep the vessels perfectly close, and give a sufficient degree of heat. Proceed thus till nothing more comes over, or at least very little. Let the vessels cool, unlute them, pour the contents of the receiver into a bottle, and seal it hermetically.

*To decompose Sulphur, and extract its Acid, by burning it.*

TAKE any quantity of the purest sulphur; fill therewith a crucible or other earthen dish; heat it till it melts; then set it on fire, and when its whole surface is lighted, place it under a large glass head, so that the flame of the sulphur do not touch either its sides or bottom; that the air have free access, in order to make the sulphur burn clear; that the head incline a little toward the side on which its beak is, that as the vapours condense therein the liquor may run off with ease. To the beak of this vessel fit a receiver: The fumes of the lighted sulphur will be condensed, and gather into drops in the head, out of which they will run into the receiver. There, when the sulphur has done burning, you will find an acid liquor, which is the spirit of sulphur.

*To concentrate the Vitriolic Acid.*

TAKE the vitriolic acid you intend to concentrate, that is, to dephlegmate and make stronger: Pour it into a good glass retort of such a size that your quantity of acid may but half fill it: Set this retort in the sand-bath of a reverberating furnace; fit it to a receiver;

lute it on, and give a gradual fire. There will come over into the receiver a clear liquor, the first drops of which will be but faintly acid: This is the most aqueous part.

When the drops begin to follow one another much more slowly, raise your fire, till the liquor begin to bubble a little in the middle. Keep it thus gently boiling, till one half or two thirds thereof be come over into the receiver. Then let your vessels cool; unlute them; what remains in the retort pour into a crystal bottle, and stop it exactly with a glass stopple rubbed with emery.

*To decompose vitriolated Tartar by means of the Phlogiston; or to compose Sulphur by combining the Vitriolic Acid with the Phlogiston.*

TAKE equal parts of vitriolated tartar, and very dry salt of tartar, separately reduced to powder; add an eighth part of their weight of charcoal dust; and mix the whole together very accurately. Throw this mixture into a red-hot crucible, placed in a furnace filled with burning coals. Cover it very close, and keep it very hot, till the mixture melt, which may be known by uncovering the crucible from time to time. There will then appear a bluish flame, accompanied with a pungent smell of sulphur.

Take the crucible out of the fire; dissolve its contents in hot water; filter the solution through brown paper supported by a glass funnel; drop into the filtered liquor by little and little any acid whatever. As you add the acid, the liquor will grow more and more turbid, and let fall a grey precipitate. Continue dropping in more acid till the liquor will yield no more precipitate. Filter it a second time to separate it from the precipitate: What remains on the filter is a true inflammable sulphur, which you may either melt or sublime into flowers.

*Of the NITROUS ACID.*

*To extract nitre out of nitrous earths and stones. The purification of salt petre. Mother of nitre. Magnesia.*

TAKE any quantity of nitrous earths or stones; reduce them to powder; and therewith mix a third part of the ashes of green wood and quick-lime. Put this mixture into a barrel or vat, and pour on it hot water to about twice the weight of the whole mass. Let it stand thus for twenty four hours, stirring it from time to time with a stick. Then filter the liquor through brown paper, or pass it through a flannel bag, till it come clear: it will then have a yellowish colour. Boil this liquor, and evaporate till you perceive that a drop of it let fall on any cold body coagulates. Then stop the evaporation, and set your liquor in a cool place. In the space of four and twenty hours crystals will be formed in it, the figure of which is that of an hexagonal prism, having its opposite planes generally equal, and terminated at each extremity by a pyramid of the same number of sides. These crystals will be of a brownish colour, and deslagrate on a live coal.

Decant the liquor from these crystals; mix it with  
twice

twice its weight of hot water; evaporate and crystallise as before. Repeat the same operation till the liquor will yield no more crystals: it will then be very thick, and goes by the name of *mother of nitre*.

Earths and stones that have been impregnated with animal or vegetable juices susceptible of putrefaction, and have been long exposed to the air, but sheltered from the sun and rain, are those which yield the greatest quantity of nitre. But all sorts of earths and stones are not equally fit to produce it. None is ever found in flints or sands of a crystalline nature.

Some earths and stones abound so with nitre, that it effloresces spontaneously on their surface, in the form of a crystalline down. This nitre may be collected with brooms, and accordingly has the name of *salt-petre sweepings*. Some of this sort is brought from India.

The process by which our salt-petre makers extract nitre in quantities, out of rubbish and nitrous earths, is very nearly the same with that here set down: so that we shall not enter into a particular account of it. We shall only take notice of one thing, which it is of some consequence to know; namely, that there is no nitrous earth which does not contain sea-salt also. The greatest quantities of this salt are to be found in those earths which have been drenched with urine or other animal excrements. Now, as the rubbish of old houses in great cities is in this class, it comes to pass, that when the salt-petre workers evaporate a nitrous lixivium drawn from that rubbish, as soon as the evaporation is brought to a certain pitch, a great many little crystals of sea-salt form in the liquor, and fall to the bottom of the vessel.

The salt-petre workers in France call these saline particles *the grain*, and take great care to separate them from the liquor, (which as long as it continues hot keeps the salt-petre dissolved) before they set it to crystallise. This fact seems a little singular, considering that sea-salt dissolves in water more easily than salt-petre, and crystallises with more difficulty.

In order to discover the cause of this phenomenon, we must recollect, first, that water can keep but a determinate quantity of any salt in solution, and that if water fully saturated with a salt be evaporated, a quantity of salt will crystallise in proportion to the quantity of water evaporated. Secondly, that those salts which are the most soluble in water, particularly those which run in the air, will dissolve in cold and in boiling water equally; whereas much greater quantities of the other salts will dissolve in hot and boiling water than in cold water. These things being admitted, when we know that sea-salt is one of the first sort, and salt-petre of the second, the reason why sea-salt precipitates in the preparation of salt-petre appears at once. For,

When the solution of salt-petre and sea salt comes to be evaporated to such a degree that it contains as much sea-salt as it possibly can, this salt must begin to crystallise, and continue to do so gradually as the evaporation advances. But because at the same time it does not contain as much salt-petre as it can hold, seeing it is capable of dissolving a much greater quantity thereof when it is boiling hot than when it is cold, this last named salt will not crystallise so soon. If the evaporation were continued till the case

of the salt-petre came to be the same with that of the sea salt, then the salt-petre also would begin to crystallise gradually in proportion to the water evaporated, and the two salts would continue crystallising promiscuously together: but it is never carried so far; nor is it ever necessary; for as the water cools it becomes more and more incapable of holding in solution the same quantity of salt-petre as when it was boiling hot.

And then comes the very reverse, with regard to the crystallising of the two salts; for then the salt-petre shoots, and not the sea-salt. The reason of this fact also is founded on what has just been said. The sea-salt, of which cold water will dissolve as much as boiling water, and which owed its crystallising before only to the evaporation, now ceases to crystallise as soon as the evaporation ceases; while the salt-petre, which the water kept dissolved only because it was boiling hot, is forced to crystallise merely by the cooling of the water.

When the solution of salt-petre has yielded as many crystals of that salt as it can yield by cooling, it is again evaporated, and being then suffered to cool yields more crystals. And thus they continue evaporating and crystallising till the liquor will afford no more crystals. It is plain, that as the salt-petre crystallises, the proportion of sea-salt to the dissolving liquor increases; and as a certain quantity of water evaporates also during the time employed in crystallising the salt-petre, a quantity of sea-salt, proportioned to the water so evaporating, must crystallise in that time: and this is the reason why salt-petre is adulterated with a mixture of sea-salt. It likewise follows, that the last crystals of nitre, obtained from a solution of salt-petre and sea-salt, contain much more sea-salt than the first.

From all that has been said concerning the crystallisation of salt-petre and sea-salt, it is easy to deduce the proper way of purifying the former of these two salts from a mixture of the latter. For this purpose the salt-petre to be refined need only be dissolved in fair water. The proportion between the two salts in this second solution is very different from what it was in the former; for it contains no more sea-salt than what had crystallised along with the salt-petre under favour of the evaporation, the rest having been left dissolved in the liquor that refused to yield any more nitrous crystals.

As there is therefore a much greater quantity of salt-petre than of sea-salt in this second solution, it is easy to evaporate it to such a degree that a great deal of salt-petre shall crystallise, while much more of the water must necessarily be evaporated before any of the sea-salt will crystallise.

However, the salt-petre is not yet entirely freed from all mixture of sea-salt by this first purification; for the crystals obtained from this liquor, in which sea-salt is dissolved, are still incruited, and, as it were, infected therewith: hence it comes, that, to refine the salt-petre thoroughly, these crystallisations must be repeated four or five times.

The salt-petre men commonly content themselves with crystallising it thrice, and call the produce salt-petre of the first, second, or third shoot, according to the number of crystallisations it has undergone. But their best refined

refined salt-petre, even that of the third shooting, is not yet sufficiently pure for chemical experiments that require much accuracy: so that it must be further purified, but still by the same method.

The nitrous acid is not pure in the earths and stones from which it is extracted. It is combined partly with the very earth in which it is formed, and partly with the volatile alkali produced by the putrefaction of the vegetable or animal matters that concurred to its generation. A fixed alkali and quick-lime are added to the lixivium of a nitrous earth, in order to decompose the nitrous salts formed in that earth, and to separate the acid from the volatile alkali and the absorbent earth with which it is united: thence comes that copious sediment which appears in the lye at the beginning of the evaporation. These matters form with that acid a true nitre, much more capable than the original nitrous salts of crystallisation, detonation, and the other properties which are essential thereto. The basis of nitre is therefore a fixed alkali mixed with a little lime.

The mother of nitre, which will yield no more crystals, is brown and thick: by evaporation over a fire it is further inspissated, and becomes a dry, solid body; which however being left to itself soon gives, and runs into a liquor. This water still contains a good deal of nitre, sea-salt, and the acids of these salts united with an absorbent earth. It contains moreover a great deal of a fat, viscid matter, which prevents its crystallising.

All saline solutions in general, after having yielded a certain quantity of crystals, grow thick, and refuse to part with any more, though they still contain much salt. They are all called *mother-waters*, as well as that which hath yielded nitre. The mother-waters of different salts may prove the subjects of curious and useful enquiries.

If a fixed alkali be mixed with the mother of nitre, a copious white precipitate immediately falls, which being collected and dried is called *magnesia*. This precipitate is nothing but the absorbent earth that was united with the nitrous acid, together with a good deal of the lime that was added, and was also united with that acid, from which they are now separated by the fixed alkali, according to the usual laws of affinities or elective attractions.

The vitriolic acid poured upon mother of nitre causes many acid vapours to rise, which are a compound of the nitrous and marine acids, that is, an *aqua regia*. On this occasion also there falls a large quantity of a white powder, which is still called *magnesia*; yet it differs from the former in that it is not, like it, a pure absorbent earth, but combined with the vitriolic acid.

An *aqua regis* may also be drawn from nitrous earths by the force of fire only, without the help of any adjuvant.

*To decompose Nitre by means of the Phlogiston.*  
*Nitre fixed by Charcoal.* Clyffus of Nitre. Sal Polychrestum.

TAKE the purest salt-petre in powder; put it into a large crucible, which it may but half fill; set the crucible in a common furnace, and surround it with coals. When it is red-hot the nitre will melt, and become as fluid as

water. Then throw into the crucible a small quantity of charcoal-dust: the nitre and the charcoal will immediately deflagrate with violence; and a great commotion will be raised, accompanied with a considerable hissing, and abundance of black smoke. As the charcoal wastes, the detonation will abate, and cease entirely as soon as the coal is quite consumed.

Then throw into the crucible the same quantity of charcoal-dust as before, and the same phenomena will be repeated. Let this coal also be consumed: then add more, and go on in the same manner till you can excite no further deflagration; always observing to let the burning coal be entirely consumed before you add any fresh. When no deflagration ensues, the matter contained in the crucible will have lost much of its fluidity.

Nitre will not take fire, unless the inflammable matter added to it be actually burning, or the nitre itself red-hot, and so thoroughly ignited as immediately to kindle it. Therefore, if you would procure the detonation of nitre with charcoal, and make use of cold charcoal, as in the process, the nitre in the crucible must be red-hot, and in perfect fusion: but you may also use live coals, and then the nitre need not be red-hot.

The matter remaining in the crucible after the operation, is a very strong fixed alkali. Being exposed to the air, it quickly extracts the moisture thereof, and runs into a liquor. It is called *alkalized nitre*, or to distinguish it from nitre alkalized by other inflammable matters, *nitre fixed by charcoal*.

The nitrous acid is not only dissipated during the deflagration of the nitre, but is even destroyed, and perfectly decomposed. The smoke that rises during the operation has not the least odour of an acid.

In order to collect the vapours discharged by the deflagration of nitre, fit to a tubulated earthen retort two or three large adoptions: set the retort in a furnace; and under it make a fire sufficient to keep its bottom moderately red. Then take a small quantity, two or three pinches for example, of a mixture of three parts of nitre with one of charcoal-dust, and drop it into the retort through its tube, which must be uppermost, and immediately stopped close. A detonation instantly ensues, and the vapours that rise from the inflamed mixture of nitre and charcoal, passing out through the neck of the retort into the adoptions, circulate therein for a while, and at last condense into a liquor.

When the detonation is over, and the vapours condensed, or nearly so, drop into the retort another equal quantity of the mixture; and repeat this till you find there is liquor enough in the recipients to be examined with ease and accuracy. This liquor is almost insipid, and shews no tokens of acidity; or at most but very slight ones. It is called *clyffus* of nitre.

Nitre is also decomposed and takes fire by the means of sulphur; but the circumstances and the result differ widely from those produced therewith by charcoal or any other inflammable body.

Nitre deflagrates with sulphur on account of the phlogiston which the latter contains. If one part of sulphur be mixed with two or three parts of nitre, and the mixture thrown by little and little into a red-hot crucible,

upon every projection there arises a detonation accompanied with a vivid flame.

The vapours discharged on this occasion have the mingled smell of a sulphureous spirit and spirit of nitre; and if they be collected by means of a tubulated retort, and such an apparatus of vessels as was used in the preceding experiment, the liquor contained in the recipients is found to be an actual mixture of the acid of sulphur, the sulphureous spirit, and the acid of nitre; the first being of greater quantity than the other two, and the second greater than the last.

Nor is the remainder after detonation a fixed alkali, as in the former experiments; but a neutral salt, consisting of the acid of sulphur combined with the alkali of nitre; a sort of vitriolated tartar, known in medicine by the name of *sal polychrestum*.

*To decompose Nitre by means of the Vitriolic Acid.*

*The Smoking Spirit of Nitre. Sal de duobus.*

*The Purification of Spirit of Nitre.*

TAKE equal parts of well purified nitre and green vitriol: dry the nitre thoroughly, and bruise it to a fine powder. Calcine the vitriol to redness: reduce it likewise to a very fine powder; and mingle these two substances well together. Put the mixture into an earthen long neck, or a good glass retort coated, of such a size that it may be but half full.

Set this vessel in a reverberating furnace covered with its done; apply a large glass receiver, having a small hole in its body, stopped with a little lute. Let this receiver be accurately luted to the retort with the fat lute, and the joint covered with a slip of canvas smeared with lute made of quick-lime and the white of an egg. Heat the vessels very gradually. The receiver will soon be filled with very dense red vapours, and drops will begin to distill from the nose of the retort.

Continue the distillation, increasing the fire a little when you observe the drops to follow each other but slowly, so that above two thirds of a minute passes between them; and, in order to let out the redundant vapours, open the small hole in the receiver from time to time. Towards the end of the operation raise the fire so as to make the retort red. When you find that, even when the retort is red-hot, nothing more comes over, unlute the receiver, and without delay pour the liquor it contains into a crystal bottle, and close it with a crystal stopple rubbed in its neck with emery. This liquor will be of a reddish yellow colour, smoking exceedingly, and the bottle containing it will be constantly filled with red fumes like those observed in the receiver.

By the process here delivered, a very strong, perfectly dephlegmated, and vastly smoking spirit of nitre is obtained.

When the operation is over, you will find a red mass at the bottom of the retort, cast as it were in a mould. This is a neutral salt of the nature of vitriolated tartar, resulting from the union of the acid of the vitriol with the alkaline basis of the nitre.

The ferruginous basis of the vitriol, which is mixed with this salt, gives it the red colour. To separate it therefrom, you must pulverise it, dissolve it in boiling

water, and filter the solution several times through brown paper; because the ferruginous earth of the vitriol is so fine, that some of it will pass through the first time. When the solution is very clear, and deposits no sediment, let it be set to shoot, and it will yield crystals of vitriolated tartar; to which chemists have given the peculiar title of *sal de duobus*.

Nitre may also be decomposed, and its acid obtained, by the interposition of any of the other vitriols, alums, gypsums, boles, clays; in short, by means of any compound in which the vitriolic acid is found, provided it have not a fixed alkali for its basis.

The distillers of *aqua fortis*, who make large quantities at a time, and who use the least chargeable methods, do their business by the means of earths impregnated with the vitriolic acid; such as clays and boles. With these earths they accurately mix the nitre from which they intend to draw their spirit: this mixture they put into large oblong earthen pots, having a very short curved neck, which enters a recipient of the same matter and form. These vessels they place in two rows opposite to each other in long furnaces, and cover them over with bricks cemented with Windsor-loam, which serves for a reverberatory: then they light the fire in the furnace, making it at first very small, only to warm the vessels; after which they throw in wood, and raise the fire till the pots grow quite red-hot, in which degree they keep it up till the distillation is entirely finished.

Most experiments require the spirit of nitre to be absolutely pure; and if it be intended for such, it must be perfectly cleansed from the vitriolic taint.

This is easily effected by mixing your spirit with very pure nitre, and distilling it a second time. The vitriolic acid, with which this spirit of nitre is adulterated, coming in contact with a great quantity of undecomposed nitre, unites with its alkaline basis, and expels a proportionable quantity of the nitrous acid.

### *Of the MARINE ACID.*

*To extract Sea-salt from Sea-water, and from Brine-springs. Epsom Salt.*

FILTER the salt-water from which you intend to extract the salt; evaporate it by boiling, till you see on its surface a dark pellicle: this consists wholly of little crystals of salt just beginning to shoot: now slacken the fire, that the brine may evaporate more slowly, and without any agitation. The crystals, which at first were very small, will become larger, and form hollow truncated pyramids, the apices whereof will point downwards, and their bases be even with the surface of the liquor.

These pyramidal crystals are only collections of small cubical crystals concentered into this form. When they have acquired a certain magnitude they fall to the bottom of the liquor. When they come to be in such heaps as almost to reach the surface of the liquor, decant it from them, and continue the evaporation till no more crystals of sea-salt will shoot.

The acid of sea-salt is scarce ever found, either in sea-water or in the earth, otherwise than united with a fixed  
alkali

alkali of a particular kind, which is its natural basis; and consequently it is in the form of a neutral salt. This salt is plentifully dissolved in the waters of the ocean, and when obtained therefrom bears the name of *sea-salt*. It is also found in the earth in vast crystalline masses, and is then called *sal-gem*; so that sea-salt and sal-gem are but one and the same sort of salt, differing very little from each other, except as to the places where they are found.

In the earth are also found springs and fountains, whose waters are strong brines, a great deal of sea-salt being dissolved in them. These springs either rise directly from the sea, or run through some mines of sal-gem, of which they take up a quantity in their passage.

As the same, or at least nearly the same quantity of sea-salt will continue dissolved in cold water as boiling water will take up, it cannot shoot, as nitre does, by the mere cooling of the water in which it is dissolved: it crystallises only by the means of evaporation, which continually lessens the proportion of the water to the salt; so that it is always capable of containing just so much the less sea-salt the more there is crystallised.

The brine should not boil after you perceive the pellicle of little crystals beginning to form on its surface; for the calmness of the liquor allows them to form more regularly, and become larger. Nor after this should the evaporation be hurried on too fast; for a saline crust would form on the liquor, which, by preventing the vapours from being carried off, would obstruct the crystallisation.

If the evaporation be continued after the liquor ceases to yield any crystals of sea-salt, other crystals will be obtained of an oblong four-sided form, which have a bitter taste, and are almost always moist. This sort of salt is known by the name of *Epsom salt*, which it owes to a salt spring in England, from the water of which it was first extracted. This salt, or rather saline compound, is a congeries of Glauber's salt and sea-salt, in a manner confounded together, and mixed with some of the mother of sea-salt, in which is contained a kind of bituminous matter. These two neutral salts, which constitute the Epsom salt, may be easily separated from each other, by means of crystallisation only. Epsom salt is purgative and bitter; and therefore named *sal cathartici cum amarum*, or bitter purging salts.

There are different methods used in great works for obtaining sea-salt out of water in which it is dissolved. The simplest and easiest is that practised in France, and in all those countries which are not colder. On the sea-shore they lay out a sort of broad shallow pits, pans, or rather ponds, which the sea fills with the tide of flood. When the ponds are thus filled, they stop their communication with the sea, and leave the water to evaporate by the heat of the sun; by which means all the salt contained in it necessarily crystallises. These pits are called *salt ponds*. Salt can be made in this way in the summer-time only, at least in France, and other countries of the same temperature; for during the winter, when the sun has less power, and rains are frequent, this method is not practicable.

For this reason, as it often rains in the province of

Normandy, the inhabitants take another way to extract salt from sea-water. The labourers employed for this purpose raise heaps of sand on the shore, so that the tide waters and drenches them when it flows, and leaves the sand dry when it ebbs. During the interval between two tides of flood the sun and the air easily carry off the moisture that was left, and so the sand remains impregnated with all the salt that was contained in the evaporated water. Thus they let it acquire as much salt as it can by several returns of flood, and then wash it out with fresh water, which they evaporate over a fire in leaden boilers.

To obtain the salt from brine-springs, the water need only be evaporated: but as several of these springs contain too little salt to pay the charges that would be incurred, if the evaporation were effected by the force of fire only, the manufacturers have fallen upon a less expensive method of getting rid of the greatest part of the water, and preparing the brine for crystallisation, in much less time, and with much less fire, than would otherwise have been necessary.

The method consists in making the water fall from a certain height on a great many small spars of wood, which divide it into particles like rain. This is performed under sheds open to all the winds, which pass freely through this artificial shower. By this means the water presents to the air a great extent of surface, being indeed reduced almost entirely to surface, and the evaporation is carried on with great ease and expedition. The water is raised by pumps to the height from which it is intended to fall.

*Experiments concerning the decomposition of Sea-salt, by means of the phlogiston. Kunckel's Phosphorus.*

“OF pure urine that has fermented five or six days take a quantity in proportion to the quantity of phosphorus you intend to make: it requires about one third part of a hoghead to make a dram of phosphorus. Evaporate it in iron pans, till it become clotted, hard, black, and nearly like chimney-oot; at which time it will be reduced to about a sixtieth part of its original weight before evaporation.

“When the urine is brought to this condition, put it in several portions into so many iron pots, under which you must keep a pretty brisk fire so as to make their bottoms red, and stir it incessantly till the volatile salt and the fetid oil be almost wholly dissipated, till the matter cease to emit any smoke, and till it smell like peach-blossoms. Then put out the fire, and pour on the matter, which will now be reduced to a powder, somewhat more than twice its weight of warm water. Stir it about in this water, and leave it to soak therein for twenty-four hours. Pour off the water by inclination; dry the drenched matter, and pulverise it. The previous calcination carries off from the matter about a third of its weight, and the lixiviation washes out half the remainder.

“With what remains thus calcined, washed, and dried, mix half its weight of gravel, or yellow freestone rasped, having sifted out and thrown away all the finest particles. River-sand is not proper on this occasion, because it flies in a hot fire. Then add to this mixture

mixture a sixteenth part of its weight of charcoal, made of beech, or of any other wood except oak, because that also flies. Moisten the whole with as much water as will bring it to a stiff paste, by working and kneading it with your hands: Now introduce it into your retort, taking care not to daub its neck. The retort must be of the best earth, and of such a size, that when your matter is in it, a full third thereof shall still be empty.

Place your retort, thus charged, in a reverberating furnace, so proportioned, that there may be an interval of two inches all round between the sides of the furnace and the bowl of the retort, even where it contracts to form the neck, which should stand inclined at an angle of sixty degrees. Stop all the apertures of the furnace, except the doors of the fire-place and ash-hole.

Fit on to the retort a large glass ballon two thirds full of water, and lute them together, as in distilling the smoking spirit of nitre. In the hinder part of this ballon, a little above the surface of the water, a small hole must be bored. This hole is to be stopped with a small peg of birch-wood, which must slip in and out very easily, and have a small knob to prevent its falling into the ballon. This peg is to be pulled out from time to time, that by applying the hand to the hole it may be known whether the air rarefied by the heat of the retort, issues out with too much or too little force.

If the air rushes out with too much rapidity, and with a hissing noise, the door of the ash-hole must be entirely shut, in order to slacken the fire. If it do not strike pretty smartly against the hand, that door must be opened wider, and large coals thrown into the fire-place to quicken the fire immediately.

The operation usually lasts four and twenty hours; and the following signs shew that it will succeed, provided the retort resist the fire.

You must begin the operation with putting some unlighted charcoal in the ash-hole, and a little lighted charcoal at the door thereof, in order to warm the retort very slowly. When the whole is kindled, push it into the ash hole, and close the door thereof with a tile. This moderate heat brings over the phlegm of the mixture. The same degree of heat must be kept up four hours, after which some coals may be laid on the grate of the fire-place, which the fire underneath will kindle by degrees. With this second heat brought nearer the retort, the ballon grows warm, and is filled with white vapours which have the smell of fetid oil. In four hours after, this vessel will grow cool and clear; and then you must open the door of the ash-hole one inch, throw fresh coals into the fire-place every three minutes, and every time shut the door of it, lest the cold air from without should strike against the bottom of the retort and crack it.

When the fire has been kept up to this degree for about two hours, the inside of the ballon begins to be netted over with a volatile salt of a singular nature, which cannot be driven up but by a very violent fire, and which smells pretty strong of peach-kernels. Care must be taken that this concrete salt do not stop the little hole in the ballon: for in that case it would burst, the retort being then red-hot, and the air exceedingly rarefied. The water in the ballon, being heated by the vicinity of

the furnace, exhales vapours which dissolve this sprigged salt, and the ballon clears up in half an hour after it has ceased rising.

In about three hours from the first appearance of this salt, the ballon is again filled with new vapours, which smell like sal ammoniac thrown upon burning coals. They condense on the sides of the receiver into a salt which is not branched like the former, but appears in long perpendicular streaks, which the vapours of the water do not dissolve. These white vapours are the fore-runners of the phosphorus; and a little before they cease to rise they lose their first smell of sal ammoniac, and acquire the odour of garlick.

As they ascend with great rapidity, the little hole must be frequently opened, to observe whether the hissing be not too strong; for in that case it would be necessary to shut the door of the ash-hole quite close. These white vapours continue two hours. When you find they cease rising, make a small passage through the dome, by opening some of its registers, that the flame may just begin to draw. Keep up the fire in this mean state till the first volatile phosphorus begin to appear.

This appears in about three hours after the white vapours first begin to rise. In order to discover it, pull out the little birchen peg once every minute, and rub it against some hot part of the furnace, where it will leave a trail of light, if there be any phosphorus upon it.

Soon after you observe this sign, there will issue out through the little hole of the ballon a stream of bluish light, which continues of a greater or shorter extent to the end of the operation. This stream or spout of light does not burn. If you hold your finger against it for twenty or thirty seconds, the light will adhere to it; and if you rub that finger over your hand, the light will befear it, and render it luminous.

But from time to time this streamer darts out to the length of seven or eight inches, snapping and emitting sparks of fire; and then it burns all combustible bodies that come in its way. When you observe this, you must manage the fire very warily, and shut the door of the ash-hole quite close, yet without ceasing to throw coals into the fire-place every two minutes.

The volatile phosphorus continues two hours; after which the little spout of light contracts to the length of a line or two: And now is the time for pushing your fire to the utmost: Immediately set the door of the ash hole wide open, throw billets of wood into it, unstop all the registers of the reverberatory, supply the fire-place with large coals every minute: In short, for six or seven hours all the inside of the furnace must be kept of a white heat, so that the retort shall not be distinguishable.

In this fierce extremity of heat the true phosphorus distills like an oil, or like melted wax: One part thereof floats on the water in the recipient, the other falls to the bottom. At last the operation is known to be quite over when the upper part of the ballon, in which the volatile phosphorus appears condensed in a blackish film, begins to grow red: For this shews that the phosphorus is burnt where the red spot appears. You must now stop all the registers, and shut all the doors of the furnace, in order to smother the fire; and then close up the little hole

in

in the ballon with fat lute or bees-wax. In this condition the whole must be left for two days; because the vessels must not be separated till they are perfectly cold, lest the phosphorus should take fire.

“As soon as the fire is out, the ballon, which is then in the dark, presents a most agreeable object: All the empty part thereof above the water seems filled with a beautiful blue light; which continues for seven or eight hours, or as long as the ballon keeps warm, never disappearing till it is cooled.

“When the furnace is quite cold, take out the vessels, and separate them from each other as neatly as possible. With a linen cloth wipe away all the black stuff you find in the mouth of the ballon; for if that filth should mix with the phosphorus, it would hinder it from being transparent when moulded. This must be done with great expedition: After which pour into the ballon two or three quarts of cold water, to accelerate the precipitation of the phosphorus that swims at top. Then agitate the water in the ballon, to rinse out all the phosphorus that may stick to the sides; pour out all the water thus shaken and turbid, into a very clean earthen pan, and let it stand till it grows clear. Then decant this first useless water, and on the blackish sediment left at the bottom of the pan pour some boiling water to melt the phosphorus; which thereupon unites with the fuliginous matter, or volatile phosphorus, that precipitated with it, both together forming a mass of the colour of slate. When this water in which you have melted the phosphorus is cool enough, take out the phosphorus, throw it into cold water, and therein break it into little bits in order to mould it.

“Then take a matras, having a long neck somewhat wider next the body than at its mouth: Cut off half the body, so as to make a funnel of the neck part, the smaller end of which must be stopped with a cork. The first mould being thus prepared, plunge it endwise, with its mouth uppermost, in a vessel full of boiling water, and fill it with that water. Into this funnel throw the little bits of your slate-like mass, which will melt again in this hot water, and fall so melted to the bottom of the tube. Stir this melted matter with an iron wire, to promote the separation of the phosphorus from the fuliginous matter with which it is fouled, and which, being less ponderous than the phosphorus, will gradually rise above it towards the upper part of the cylinder.

“Keep the water in the vessel as hot as at first, till on taking out the tube you see the phosphorus clean and transparent. Let the clear tube cool a little, and then set it in cold water, where the phosphorus will congeal as it cools. When it is perfectly congealed, pull out the cork, and with a small rod near as big as the tube, push the cylinder of phosphorus towards the mouth of the funnel, where the feculency lies. Cut off the black part of the cylinder, and keep it apart: For when you have got a quantity thereof, you may melt it over again in the same manner, and separate the clean phosphorus which it still contains. As to the rest of the cylinder which is clean and transparent, if you intend to mould it into smaller cylinders, you may cut it in slices, and melt it

again by the help of boiling water in glass tubes of smaller dimensions.”

It is proper to observe, in the first place, that one of the most usual causes of miscarriage in this operation is a defect of the requisite qualities in the retort employed. It is absolutely necessary to have that vessel made of the best earth, and so well made that it shall be capable of resisting the utmost violence of fire, continued for a very long time.

We shall, in the second place, observe with M. Hellot, “that, before you set your retort in the furnace, it is proper to make an essay of your matter, to see if there be reason to hope for success. For this purpose put about an ounce thereof into a small crucible, and heat it till the vessel be red. The mixture, after having smoked, ought to chop and crack without puffing up, or even rising in the least. From these cracks will issue undulated flames, white and bluish, darting upwards with rapidity. This is the first volatile phosphorus, which occasions all the danger of the operation. When these first flashes are over, increase the heat of your matter by laying a large live coal upon the crucible. You will then see the second phosphorus, like a luminous, steady vapour, of a colour inclining to violet, covering the whole surface of the matter: It continues for a very long time, and diffuses a smell of garlick, which is the distinguishing odour of the phosphorus you are seeking.

“When this luminous vapour is entirely gone, pour the red hot matter out of the crucible upon an iron plate. If you do not find one drop of salt in fusion, but that, on the contrary, the whole falls readily into powder, it is a proof that your matter was sufficiently lixiviated, and that it contains no more fixed salt, or sea-salt, if you will, than is requisite. If you find on the plate a drop of salt coagulated, it shews that there is too much left in it, and that there is danger of your miscarrying in the operation because the redundant salt would corrode and eat through the retort. In this case your matter must be washed again, and then sufficiently dried.”

The furnace must be so constructed, that within a narrow compass it may give a heat at least equal to that of a glass-house furnace, or rather greater, especially during the last seven or eight hours of the operation. M. Hellot, in his Memoir, gives an exact description of such a furnace.

“As certain accidents may happen in the course of the operation, some precautions are to be taken against them. For instance, if the ballon should break while the phosphorus is distilling, and any of it should fall on combustible bodies, it would set them on fire, and probably burn the laboratory, because it is not to be distinguished without the greatest difficulty. The furnace must therefore be erected under some vault, or upon a bed of brick-work, raised under some chimney that draws well: Nor must any furniture or utensil of wood be left near it. If a little flaming phosphorus should fall on a man's legs or hands, in less than three minutes it would burn its way to the very bone. In such a case nothing but urine will stop its progress.

“If the retort crack while the phosphorus is distilling, there

there is an unsuccessful end of your operation. It is easy to perceive this by the stink of garlic which you will smell about the furnace; and moreover, the flame that issues through the apertures of the reverberatory will be of a beautiful violet colour. The acid of sea-salt always gives this colour to the flame of such matters as are burnt along with it. But if the retort break before the phosphorus hath made its appearance, its contents may be saved by throwing a number of cold bricks into the fire-place, and upon them a little water to quench the fire at once." All these useful observations we owe also to M. Hellot.

The phosphorus here described was first discovered by a citizen of Hamburg named Brandt, who worked upon urine in search of the philosopher's stone. Afterwards two other skilful chemists, who knew nothing more of the process than that phosphorus was obtained from urine, or in general from the human body, likewise endeavoured to discover it; and each of them separately did actually make the discovery. These two chemists were Kunckel and Boyle.

The former perfected the discovery, and found out a method of making it in considerable quantities at a time; which occasioned it to be called *Kunckel's phosphorus*. The other, who was an English gentleman, had not time to bring his discovery to perfection, and contented himself with lodging a voucher of his having discovered it in the hands of the secretary of the Royal Society of London, who gave him a certificate thereof.

"Though Brandt, who had before this sold his secret to a chemist named Krafft, sold it afterwards to several other persons, and even at a very low rate: and though Mr Boyle published the process for making it; yet it is extremely probable that both of them kept in their own hands the master-key; I mean, *the particular management necessary to make the operation succeed*: For till Kunckel found it out, no other chemist ever made any considerable quantity thereof, except Mr Godfrey Hankwitz, an English chemist, to whom Mr Boyle revealed the whole mystery.

"And thus it came to pass, that, after Kunckel and Boyle died, M. Godfrey Hankwitz was the only chemist that could supply Europe therewith; on which account it is likewise very well known by the name of *English phosphorus*."

Almost all the chemists consider phosphorus as a substance consisting of the acid of sea-salt combined with the phlogiston, in the same manner as sulphur consists of the vitriolic acid combined with the phlogiston. This opinion is founded on the following principles.

First, urine abounds with sea-salt, and contains also a great deal of phlogiston: now these are the ingredients of which they conjecture phosphorus to be composed.

Secondly, phosphorus has many of the properties of sulphur; such as being soluble in oils; melting with a gentle heat; being very combustible; burning without any soot; giving a vivid and bluish flame; and lastly, leaving an acid liquor when burnt: sensible proofs that it differs from sulphur in nothing but the nature of its acid.

Thirdly, this acid of phosphorus, being mixed with a solution of silver in spirit of nitre, precipitates the silver; and this precipitate is a true *luna cornea*, which appears to be more volatile even than the common sort. This fact proves more incontestably that the acid of phosphorus is of the same nature with that of sea-salt.

Fourthly, M. Stahl observes, that if sea-salt be cast on live coals, they instantly burn with great activity; that they emit a vivid flame, and are much sooner consumed than if none of this salt had touched them; that sea-salt in substance, which will bear the violence of fire a considerable time when fused in a crucible, without sustaining any sensible diminution, yet evaporates very quickly, and is reduced to white flowers, by the immediate contact of burning coals; and lastly, that the flame which rises on this occasion is of a blue colour inclining to violet, especially if it be not thrown directly on the coals themselves, but kept in fusion amidst burning coals, in a crucible so placed that the vapour of the salt may join with the inflamed phlogiston as it rises from the coals.

These experiments of Mr Stahl's prove, that the phlogiston acts upon the acid of sea-salt, even while it is combined with its alkaline basis. The flame that appears on this occasion may be considered as an imperfect phosphorus: and indeed its colour is exactly like that of phosphorus.

All the facts above related evince, that the acid of phosphorus is akin to that of sea-salt; or rather, that it is the very same. But there are other facts which prove, that this acid undergoes some change at least, some peculiar preparation, before it enters into the composition of a true phosphorus; and that, when extricated therefrom by burning, it is not a pure acid of sea-salt, but is still adulterated with a mixture of some other substance, which makes it considerably different from that acid. For these observations we are obliged to M. Marggraff.

M. Marggraff hath also published a process for making phosphorus, and assures us, that by means thereof we may obtain in less time, with less heat, less trouble, and less expence, a greater quantity of phosphorus than by any other method. His operation is this:

He takes two pounds of sal ammoniac in powder, which he mixes accurately with four pounds of minium. This mixture he puts into a glass retort, and with a graduated fire draws off a very sharp, volatile, urinous spirit.

We observed in Part I. that some metallic substances have the property of decomposing sal ammoniac, and separating its volatile alkali. Minium, which is a calx of lead, is one of those metallic substances. In this experiment it decomposes the sal ammoniac, and separates its volatile alkali: what remains in the retort is a combination of the minium with the acid of sal ammoniac, which is well known to be the same with the marine acid; and consequently the residue of this operation is a sort of *plumbum corneum*.

The quantity thereof is four pounds eight ounces. Of this he mixes three pounds with nine or ten pounds of urine, that has stood putrefying for two months, evaporated to the consistence of honey. These he mixes

by



by little and little in an iron pan over the fire, stirring the mixture from time to time. Then he adds half a pound of charcoal dust, and evaporates the matter, kept continually stirring, till the whole be brought to a black powder. He next distills the mixture in a glass retort with degrees of fire, which he raises towards the end so as to make the retort red-hot, in order to expel all the urinous spirit, superfluous oil, and ammoniacal salt. The distillation being finished, there remains no thing in the retort but a very friable *caput mortuum*.

This remainder he pulverises again, and throws a pinch of it on live coals to discover whether or no the matter be rightly prepared for yielding phosphorus. If it be so, it presently emits an arsenical odour, and a blue undulating flame, which passes over the surface of the coals like a wave.

Being thus assured of the success of his operation, he puts one half of his matter, in three equal parts, into three small earthen German retorts, capable of holding about eighteen ounces of water a-piece. These three retorts, none of which is above three quarters full, he places together in one reverberatory furnace, built much like those we have described, except that it is so constructed as to hold the three retorts disposed in one line. To each retort he lutes a recipient something more than half full of water, ordering the whole in such a manner, that the noses of his retorts almost touch the surface of the water.

He begins the distillation with warming the retorts slowly, for about an hour, by a gentle heat. When that time is elapsed he raises the fire gradually, so that in half an hour more the coals begin to touch the bottoms of the retorts. He continues throwing coals into the furnace by little and little, till they rise half way the height of the retorts; and in this he employs another half hour. Lastly, in the next half hour he raises the coals above the bowels of the retorts.

Then the phosphorus begins to ascend in clouds: on this he instantly increases the heat of the fire as much as possible, filling the surface quite up with coals, and making the retorts very red. This degree of fire causes the phosphorus to distill in drops which fall to the bottom of the water. He keeps up this intense heat for an hour and half, at the end of which the operation is finished; so that it lasts but four hours and a half in all: In the same manner he distills the second moiety of his mixture in three other such retorts.

He purifies and moulds his phosphorus much in the same manner as M. Hellot does. From the quantity of ingredients above-mentioned, he obtains two ounces and a half fine crystalline moulded phosphorus.

The acid of phosphorus seems to be more fixed than any other: and therefore if you would separate it by burning from the phlogiston with which it is united, there is no occasion for such an apparatus of vessels as is employed for obtaining the spirit of sulphur. For this acid will remain at the bottom of the vessel in which you burn your phosphorus: indeed, if it be urged by the force of fire, its most subtile part evaporates, and the remainder appears in the form of a vitrified matter.

This acid effervesces with fixed and volatile alkalis,

and therewith forms neutral salts; but very different from sea-salt, and from sal ammoniac. That which has a fixed alkali for its basis does not crackle when thrown on burning coals; but swells and vitrifies like borax. That which has a volatile alkali for its basis shoots into long pointed crystals; and, being urged by fire in a retort, lets go its volatile alkali, a vitrified matter remaining behind.

We shall conclude this article with an account of certain properties of phosphorus which have not yet been mentioned.

Phosphorus dissolves by lying exposed to the air. What water cannot effect, says M. Hellot, or at least requires eight or ten years to bring about, the moisture of the air accomplishes in ten or twelve days; whether it be that the phosphorus takes fire in the air, and the inflammable part evaporating, almost entirely, leaves the acid of the phosphorus naked, which like all other acids, when exceedingly concentrated, is very greedy of moisture; or else that the moisture of the air, being water divided into infinitely fine particles, is so subtile as to find its way through the pores of the phosphorus, into which the grosser particles of common water can by no means insinuate themselves.

Phosphorus heated by the vicinity of fire, or by being any way rubbed, soon takes fire and burns fiercely. It is soluble in all oils, and in æther, giving to those liquors the property of appearing luminous, when the bottle containing the solution is opened. Being boiled in water, it likewise communicates thereto this luminous quality.

The late Mr Grosse observed, that phosphorus being dissolved in essential oils crystallises therein. These crystals take fire in the air, either when thrown into a dry vessel, or wrapt up in a piece of paper. If they be dipped in spirit of wine, and taken out immediately, they do not afterwards take fire in the air: they smoke a little, and for a very short time, but hardly waste at all. Though some of them were left in a spoon for a fortnight, they did not seem to have lost any thing of their bulk: but when the spoon was warmed a little they took fire, just like common phosphorus that had never been dissolved and crystallised in an essential oil.

M. Marggraff, having put a dram of phosphorus with an ounce of highly concentrated spirit of nitre into a glass retort, observed, that, without the help of fire, the acid dissolved the phosphorus; that part of the acid came over into the recipient which was luted to the retort; that at the same time the phosphorus took fire, burnt furiously, and burst the vessels with explosion. Nothing of this kind happens when any of the other acids, though concentrated, are applied to phosphorus.

*To decompose Sea salt by means of the Vitriolic Acid, Glauber's Salt. The Purification and Concentration of Spirit of Salt.*

Put the sea-salt from which you mean to extract the acid into an unglazed earthen pipkin, and set it amidst live coals. The salt will decrepitate, grow dry, and fall into a powder. Put this decrepitated salt into a tubulated glass retort, leaving two thirds thereof empty. Set the retort in a reverberating furnace; apply a receiver

ceiver like that used in distilling the smoking spirit of nitre, and lute it on in the same manner, or rather more exactly if possible. Then through the hole in the upper convexity of the retort pour a quantity of highly concentrated oil of vitriol, equal in weight to about a third part of your salt, and immediately shut the hole very close with a glass stopple, first rubbed therein with emery so as to fit it exactly.

As soon as the oil of vitriol touches the salt, the retort and receiver will be filled with abundance of white vapours; and soon after, without lighting any fire in the furnace, drops of a yellow liquor will distill from the nose of the retort. Let the distillation proceed in this manner without fire, as long as you perceive any drops come; afterwards kindle a very small fire under the retort, and continue distilling and raising the fire by very slow degrees, and with great caution, to the end of the distillation; which will be finished before you have occasion to make the retort red-hot. Unlute the vessels, and without delay pour the liquor, which is a very smoking spirit of salt, out of the receiver into a crystal bottle, like that directed for the smoking spirit of nitre.

When the operation is finished, we find a white, saline mass at the bottom of the retort as in a mould. If this mass be dissolved in water, and the solution crystallized, it yields a considerable quantity of sea-salt that hath not been decomposed, and a neutral salt consisting of the vitriolic acid united with the alkaline basis of that part which hath been decomposed. This neutral salt, which bears the name of *Glauber* its inventor, differs from vitriolated tartar, or the *Sal de duobus*, which remains after distilling the nitrous acid, especially in that it is more fusible, more soluble in water, and hath its crystals differently figured. But as in these two salts the acid is the same, the differences that appear between them must be attributed to the peculiar nature of the basis of sea-salt.

Spirit of salt drawn by the process above described is tainted with a small mixture of the vitriolic acid, carried up by the force of fire before it had time to combine with the alkali of the sea-salt; which happens likewise to the nitrous acid procured in the same manner. If you desire to have it pure, and absolutely free from the acid of vitriol, it must be distilled a second time from sea-salt, as the acid of nitre was before directed to be distilled again from fresh nitre, in order to purify it from any vitriolic taint.

*To decompose Sea-salt by means of the Nitrous Acid. Aqua regis. Quadrangular Nitre.*

**TAKE** dried sea-salt: bruise it to powder: put it into a glass retort, leaving one half of the vessel empty. Pour upon it a third of its weight of good spirit of nitre. Place your retort in the sand-bath of a reverberating furnace; put on the dome; lute to the retort a receiver having a small hole in it, and heat the vessels very slowly. There will come over into the receiver some vapours, and an acid liquor. Increase the fire gradually till nothing more rises. Then unlute the vessels, and pour the liquor out of the receiver into a crystal bottle, stopped like others containing acid spirits.

The nitrous acid hath a greater affinity than the marine acid with fixed alkalis. When therefore spirit of nitre and sea-salt are mixed together, the same consequences will follow as when the vitriolic acid is mixed with that salt; that is, the nitrous acid will, like the vitriolic, decompose it, by dislodging its acid from its alkaline basis, and assuming its place. But as the nitrous acid is considerably weaker, and much lighter, than the vitriolic acid, a good deal of it rises along with the acid of sea-salt during the operation. The liquor found in the receiver is therefore a true *aqua regis*.

If decrepitated salt, and a right smoking spirit of nitre, be employed in this process, the *aqua regis* obtained will be very strong.

The operation being finished, there is left in the retort a saline mass, containing sea-salt not decomposed, and a new species of nitre, which having for its basis the alkali of sea-salt, that is, an alkali of a peculiar nature, differs from the common nitre, 1. In the figure of its crystals; which are solids of four sides, formed like lozenges: 2. In that it crystallizes with more difficulty, retains more water in its crystals, attracts the moisture of the air, and dissolves in water with the same circumstances as sea salt.

### Of BORAX.

*To decompose Borax by the means of Acids, and to separate from it the Sedative Salt by Sublimation and by Crystallisation.*

**REDUCE** to a fine powder the borax from which you intend to extract the sedative salt. Put this powder into a wide-necked glass retort. Pour upon it an eighth part of its weight of common water, to moisten the powder; and then add concentrated oil of vitriol, to the weight of somewhat more than a fourth part of the weight of the borax. Set the retort in a reverberatory, make a moderate fire at first, and augment it gradually till the retort become red-hot.

A little phlegm will first come over, and then, with the last moisture that the heat expels, the sedative salt will rise; by which means some of it will be dissolved in this last phlegm, and pass therewith into the receiver; but most of it will adhere in the form of saline flowers to the fore-part of the neck of the retort, just where it is clear of the groove of the furnace. There they collect into a heap, which the succeeding flowers push insensibly forward till they slightly stop the passage. Those which rise after the neck is thus stopped stick to the after part of it which is hot, vitrify in some measure, and form a circle of fused salt. In this state the flowers of the sedative salt seem to issue out of the circle, as from their basis: They appear like very thin, light, shining scales, and must be brushed off with a feather.

At the bottom of the retort will be left a saline mass: Dissolve this in a sufficient quantity of hot water; filter the solution, in order to free it from a brown earth which it deposits; set the liquor to evaporate, and crystals of sedative salt will form in it.

Though borax is of great use in many chemical operations, especially in the fusion of metals, as we shall have

have occasion to see, yet, till of late years, chemists were quite ignorant of its nature, as they still are of its origin; concerning which we know nothing with certainty, but that it comes rough from the East Indies, and is purified by the Dutch.

### Of Operations on METALS.

#### Of GOLD.

*To separate Gold, by Amalgamation with Mercury, from the Earths and Stones with which it is found mixed.*

PULVERISE the earths and stones containing gold. Put the powder into a little wooden tray; dip this tray in water, gently shaking it and its contents. The water will grow muddy, by taking up the earthy parts of the ore. Continue washing it in this manner till the water cease to appear turbid. Upon the ore thus washed pour strong vinegar, having first dissolved therein, by the help of heat, about a tenth part of its weight of alum. The powder must be quite drenched and covered with this liquor, and so left to stand for twice twenty-four hours.

Decant the vinegar, and wash your powder with warm water, till the last that comes off hath no taste: then dry it, and put it into an iron mortar, with four times its weight of quick-silver: triturate the whole with a heavy wooden pestle, till all the powder be of a blackish colour: then pour in a little water, and continue rubbing for some time longer. More earthy and heterogeneous particles will be separated from the metalline parts by means of this water, which will look dirty: it must then be decanted, and more fair water added. Repeat this several times; then dry what remains in the mortar with a sponge, and by the help of a gentle heat; you will find it an amalgam of the mercury with the gold.

Put this amalgam into a chamoy bag: tie a knot on its neck, and squeeze it hard between your fingers, over some wide-mouthed vessel; there will issue through the pores of the leather numberless little jets of mercury, forming a sort of shower, that will collect into large globules in the vessel placed underneath. When you can force out no more mercury by this means, open the bag, and in it you will find the amalgam freed from the superfluous mercury; the gold retaining only about as much thereof as nearly equals itself in weight.

Put this amalgam into a glass retort: set this retort in the sand-bath of a reverberating furnace; cover it quite over with sand; apply a glass receiver half full of water, so that the nose of the retort may be under the water. The receiver need not be luted to the retort. Give a gradual heat, and raise the fire till drops of the sublimed mercury appear in the neck of the retort, and fall into the water with a hissing noise. If you hear any noise in the retort, slacken your fire a little. Lastly, when you observe, that, though you raise the fire still higher than before, nothing more will come over, take out your retort, break it, and there you will find the gold, which must be melted in a crucible with borax.

*To dissolve Gold in Aqua regis, and by that means to separate it from Silver.*

TAKE gold that is perfectly pure, or alloyed with

silver only. Reduce it to little thin plates, by hammering it on an anvil. If it be not sufficiently tough, heat it till it be red in a moderate, clear fire, quite free from smoking coals, and then let it cool gradually, which will restore its ductility.

When the plates are thin enough, make them red-hot once more, and cut them into small bits with a pair of sheers. Put these bits into a tall, narrow-mouthed cucurbit, and pour on them twice their weight of good *aqua regis*, made of one part sal-ammoniac, or spirit of salt, and four parts spirit of nitre. Set the cucurbit in a sand-bath moderately heated, stopping its orifice slightly with a paper coffin, to prevent any dirt from falling in. The *aqua regis* will presently begin to smoke. Round the little bits of gold will be formed an infinite number of small bubbles, which will rise to the surface of the liquor. The gold will totally dissolve, if it be pure, and the solution will be of a beautiful yellow colour: if the gold be alloyed with a small quantity of silver, the latter will remain at the bottom of the vessel in the form of a white powder. If the gold be alloyed with much silver, when the gold is dissolved the silver will retain the form of the little metalline plates put into the vessel.

When the dissolution is completed, gently pour off the liquor into another low, wide-mouthed, glass cucurbit, taking care that none of the silver, which lies at the bottom in the form of a powder escape with the liquor. On this powder of silver pour as much fresh *aqua regis* as will cover it entirely; and repeat this till you are sure that nothing more can be taken up by it. Lastly, having decanted the *aqua regis* from the silver, wash the silver with a little spirit of salt weakened with water, and add this spirit of salt to the *aqua regis* in which your gold is dissolved. Then to the body containing these liquors fit a head and a receiver, and distill with a gentle heat, till the matter contained in the cucurbit becomes dry.

Mix together equal parts of common brimstone, and a very strong fixed alkali; for instance, nitre fixed by charcoal. Put them in a crucible, and melt the mixture, stirring it from time to time with a small rod. There is no occasion to make the fire very brisk, because the sulphur facilitates the fusion of the fixed alkali. Some sulphureous vapours will rise from the crucible: the two substances will mix intimately together, and form a reddish compound. Then throw into the crucible some little pieces of gold beat into thin plates, so that the whole do not exceed in weight one third part of the liver of sulphur: raise the fire a little. As soon as the liver of sulphur is perfectly melted, it will begin to dissolve the gold with ebullition; and will even emit some flashes of fire. In the space of a few minutes the gold will be entirely dissolved, especially if it was cut and slatted into small thin leaves.

The process here delivered is taken from M. Stahl. The design of his inquiries was to discover how Moses could burn the golden calf, which the Israelites had set up and worshipped while he was on the mount; how he could afterwards reduce that calf to powder, throw it into the water which the people used, and make all who had apostatized drink thereof, as related in the book of

Exodus; and he concludes, that Moses must have performed this operation by means of liver of sulphur.

*To separate Gold from all other metallic Substances by means of Antimony.*

HAVING put the gold you intend to purify into a crucible, set it in a melting furnace, cover it, and make the gold flow. When the metal is in fusion, cast upon it, by a little at a time, twice its weight of pure crude antimony in powder, and after each projection cover the crucible again immediately: this done keep the matter in fusion for a few minutes. When you perceive that the metallic mixture is perfectly melted, and that its surface begins to sparkle, pour it out into a hollow iron cone, previously heated, and smeared on the inside with tallow. Immediately strike with a hammer the floor on which the cone stands; and when all is cold, or at least sufficiently fixed, invert the cone and strike it: the whole metallic mass will fall out, and the under part thereof, which was at the point of the cone, will be a regulus more or less yellow as the gold was more or less pure. On striking the metallic mass, the regulus will freely part from the sulphureous crust at top.

Return this regulus into the crucible, and melt it. Less fire will do now than was required before. Add the same quantity of antimony, and proceed as at first. Repeat the same operation a third time, if your gold be very impure.

Then put your regulus into a good crucible, much larger than is necessary to hold it. Set your crucible in a melting furnace, and heat the matter but just enough to make it flow, with a smooth, brilliant surface. When you find it thus conditioned, point towards it the nose of a long-snouted pair of bellows, and therewith keep gently and constantly blowing. There will arise from the crucible a considerable smoke, which will abate greatly when you cease to blow, and increase as soon as you begin again. You must raise the fire gradually as you approach towards the end of the operation. If the surface of the metal lose its brilliant polish, and seem covered with a hard crust, it is a sign the fire is too weak; in which case it must be increased, till the surface recover its shining appearance. At last, when no more smoke rises, and the surface of the gold looks neat and greenish, cast on it, by little and little, some pulverized nitre, or a mixture of nitre and borax. The matter will swell up. Continue thus adding more nitre gradually, till no commotion is thereby produced in the crucible; and then let the whole cool. If you find, when the gold is cold, that it is not tough enough, melt it over again; when it begins to melt cast it in the same salts as before; and repeat this till it be perfectly ductile.

*To separate Silver from its Ore, by means of Scorification with Lead.*

BEAT to powder in an iron mortar the ore from which you mean to separate the silver, having first roasted it well in order to free it from all the sulphur and arsenic that it may contain. Weigh it exactly: then weigh out by itself eight times as much granulated lead. Put one half of this lead into a test, and spread it equally there-

on: upon this lead lay your ore, and cover it quite over with the remaining half of the lead.

Place the test thus loaded under the further end of the muffle in a cupelling furnace. Light your fire, and increase it by degrees. If you look through one of the apertures in the door of the furnace, you will perceive the ore, covered with calcined lead, swim upon the melted lead. Presently afterwards it will grow soft, melt, and be thrown towards the sides of the vessel, the surface of the lead appearing in the midst thereof bright and shining like a luminous disc: the lead will then begin to boil, and emit fumes. As soon as this happens, the fire must be a little checked, so that the ebullition of the lead may almost entirely cease for about a quarter of an hour. After this it must be excited to the degree it was at before, so that the lead may begin again to boil and smoke. Its shining surface will gradually lessen, and be covered with *scoria*. Stir the whole with an iron hook, and draw in towards the middle what you observe towards the sides of the vessel; to the end that, if any part of the ore should still remain undissolved by the lead, it may be mixed therewith.

When you perceive that the matter is in perfect fusion, that the greatest part of what sticks to the iron hook, when you dip it in the melted matter, separates from it again, and drops back into the vessel; and that the extremity of this instrument, when grown cold, appears varnished over with a thin, smooth, shining crust; you may look on these as marks that the business is done; and the more uniform and evenly the colour of the crust is, the more perfect may you judge the scorification to be.

Matters being brought to this pass, take the test with a pair of tongs from under the muffle, and pour its whole contents into an iron cone, first heated and greased with tallow. This whole operation lasts about three quarters of an hour. When all is cold, the blow of a hammer will part the regulus from the scoria; and as it is not possible, how perfect soever the scorification be, to avoid leaving a little lead containing silver in the scoria, it is proper to pulverise this scoria, and separate therefrom whatever extends under the hammer, in order to add it to the regulus.

*The refining of Silver by the Cupel.*

TAKE a cupel capable of containing one third more matter than you have to put into it: set it under the muffle of a furnace like that described in our theoretical elements, as peculiarly appropriated to this sort of operation. Fill the furnace with charcoal; light it; make the cupel red-hot, and keep it so till all its moisture be evaporated; that is, for about a good quarter of an hour, if the cupel be made wholly of the ashes of burnt-bones; and for a whole hour, if there be any washed wood-ash in its composition.

Reduce the regulus which remained after the preceding operation to little thin plates, flattening them with a small hammer, and separating them carefully from all the adherent scoria. Wrap these in a bit of paper, and with a small pair of tongs put them gently into the cupel. When the paper is consumed, the regulus will soon melt,

and

and the scoria, which will be gradually produced by the lead as it turns to litharge, will be driven to the sides of the cupel, and immediately absorbed thereby. At the same time the cupel will assume a yellow, brown, or blackish colour, according to the quantity and nature of the scoria imbibed by it.

When you see the matter in the cupel in a violent ebullition, and emitting much smoke, lower the fire by the methods formerly prescribed. Keep up such a degree of heat only that the smoke which ascends from the matter may not rise very high, and that you may be able to distinguish the colour which the cupel acquires from the scoria.

Increase the fire by degrees, as more and more litharge is formed and absorbed. If the regulus examined by this assay contain no silver, you will see it turn wholly into scoria, and at last disappear. When it contains silver, and the quantity of lead is much diminished, you will perceive little vivid risers, or beautiful rain-bow colours, shooting swiftly along its surface, and crossing each other in many different directions. At last, when all the lead is destroyed, the thin dark skin, that is continually protruded by the lead while it is turning into litharge, and which hitherto covered the silver, suddenly disappears; and, if at this moment the fire happen not to be strong enough to keep the silver in fusion, the surface of that metal will at once dart out a dazzling splendor; but, if the fire be strong enough to keep the silver in fusion, though freed from all mixture of lead, this change of colour, which is called its *fulguration*, will not be so perceptible, and the silver will appear like a bead of fire.

These phenomena shew that the operation is finished. But the cupel must still be left a minute or two under the muffle, and then drawn slowly out with the iron hook towards the door of the furnace. When the silver is so cooled as to be but moderately red, you may take the cupel from under the muffle with your little tongs, and in the middle of its cavity you will find an exceeding white bead of silver, the lower part whereof will be unequal, and full of little pits.

*To purify Silver by Nitre.*

GRANULATE the silver you intend to purify, or reduce it to thin plates; put it into a good crucible; add thereto a fourth part in weight of very dry pulverised nitre, mixed with half the weight of the nitre of calcined wine-lees, and about a sixth part of the same weight of common glass in powder. Cover this crucible with another crucible inverted; which must be of such a size that its mouth may enter a little way into that of the lower one, and have its bottom pierced with a hole of about two lines in diameter. Lute the two crucibles together with clay and Windsor-loam. When the lute is dry, place the crucibles in a melting furnace. Fill the furnace with charcoal, taking care however that they do not rise above the upper crucible.

Kindle the fire, and make your vessels of a middling red heat. When they are so, take up with the tongs a live coal, and hold it over the hole of the upper crucible. If you immediately perceive a vivid splendor round the

coal, and at the same time hear a gentle hissing noise, it is a sign that the fire is of a proper strength; and it must be kept up at the same degree till this phenomenon cease.

Then increase the fire to the degree requisite to keep pure silver in fusion; and immediately take your vessels out of the furnace. You will find the silver at the bottom of the lower crucible covered with a mass of alkaline scoria of a greenish colour. If the metal be not rendered perfectly pure and ductile by this operation, it must be repeated a second time.

*To dissolve Silver in Aqua Fortis, and thereby separate it from every other metalline Substance.*

THE silver you intend to dissolve being beaten into thin plates, put it into a glass cucurbit; pour on it twice its weight of good precipitated *aqua fortis*; cover the cucurbit with a paper, and set it on a sand-bath moderately heated. The *aqua fortis* will begin to dissolve the silver as soon as it comes to be a little warm. Red vapours will rise; and from the upper surfaces of the silver there will seem to issue streams of little bubbles, ascending to the top of the liquor, between which and the silver they will form, as it were, a number of fine chains: This is a sign that the dissolution proceeds duly, and that the degree of heat is such as it ought to be. If the liquor appear to boil and be agitated, a great many red vapours rising at the same time, it is a sign that the heat is too great, and should be lessened till it be reduced to the proper degree indicated above: having obtained that, keep it equally up till no more bubbles or red vapours appear.

If your silver be alloyed with gold, the gold will be found, when the dissolution is finished, at the bottom of the vessel in the form of a powder. The solution must now be decanted while it is yet warm: on the powder pour half as much fresh *aqua fortis* as before, and make it boil; again decant this second *aqua fortis*, and repeat the same a third time; then with fair water wash the remaining powder well: It will be of a brown colour inclining to red.

*To separate Silver from the Nitrous Acid by Distillation. Crystals of Silver. The Infernal Stone.*

INTO a large, low, glass body, put the solution of silver from which you intend to separate the silver by distillation. To this body fit a tubulated head provided with its stopple. Set this alembic in a sand-bath, so that the body may be almost covered with sand: apply a receiver, and distill with a moderate heat, so that the drops may succeed each other at the distance of some seconds. If the receiver grow very hot, check the fire. When red vapours begin to appear, pour into the alembic, through the hole in its head, a fresh quantity of your solution of silver, first made very hot. Continue distilling in this manner; and repeating the addition of fresh liquor, till all your solution be put into the alembic. When you have no more fresh solution to put in, and when, the phlegm being all come over, red vapours begin again to appear, convey into the alembic half a dram or a dram of tallow, and distill to driness; which being

being done, increase your fire so as to make the vessel containing the sand-bath red-hot. In the alchemical you will find a calx of silver, which must be melted in a crucible with some soap and calcined wine-lees.

If the distillation be stopped when part of the phlegm is drawn off, and the liquor be then suffered to cool, many crystals will shoot therein, which are a neutral salt constituted of the nitrous acid and silver. If the distillation be carried further, and stopped when near its conclusion, the liquor being then suffered to cool will wholly coagulate into a blackish mass called the *infernal stone*.

*To separate Silver from the nitrous Acid by Precipitation.* Luna Cornea. Luna Cornea reduced.

INTO your solution of silver pour about a fourth part in weight of spirit of salt, solution of sea-salt, or solution of sal ammoniac. The liquor will instantly become turbid and milky. Add twice or thrice its weight of fair water, and let it stand some hours to settle. It will deposite a white powder. Decant the clear liquor, and on the precipitate pour fresh *aqua fortis*, or spirit of salt, and warm the whole on a sand bath with a gentle heat for some time. Pour off this second liquor, and boil your precipitate in pure water, shifting it several times, till the precipitate and the water be both quite inspid. Filter the whole, and dry the precipitate, which will be a *luna cornea*, and must be reduced in the following manner.

Smear the inside of a good crucible well with soap. Put your *luna cornea* into it; cover it with half its weight of salt of tartar, thoroughly dried and pulverised; press the whole hard down; pour thereon as much oil, or melted tallow, as the powder is capable of imbibing; set the crucible thus charged, and close covered, in a melting furnace, and, for the first quartet of an hour, kindle no more fire than is necessary to make the crucible moderately red; after that raise it so as to melt the silver and the salt, throwing into the crucible from time to time little bits of tallow. When it ceases to smoke, let the whole cool; or pour it into a hollow iron cone, warmed and tallowed.

*To dissolve Silver, and separate it from Gold, by Cementation.*

Mix thoroughly together fine brick-dust four parts, vitriol calcined to redness one part, and sea-salt or nitre one part. Moisten this powder with a little water. With this cement cover the bottom of a crucible half an inch thick; on this first bed lay a thin plate of the mass of gold and silver you intend to cement, and which you must previously take care to beat into such thin plates. Cover this plate with a second layer of cement, of the same thickness as the former; on this second bed lay another plate of your metal; cover it in like manner with cement; and so proceed till the crucible be filled to within half an inch of its brim. Fill up the remaining space with cement, and close the crucible with a cover, luted with a paste made of Windsor-loam and water: Set your crucible thus charged in a furnace, whose fire-place is deep enough to let it be entirely surrounded with coals, quite up to its mouth. Light some coals in the furnace,

taking care not to make the fire very brisk at first; increase it by degrees, but only so far as to make the crucible moderately red; keep up the fire in this degree for eighteen or twenty hours: Then let the fire go out; open the crucible when it is cold, and separate the cement from your plates of gold. Boil the gold repeatedly in fair water, till the water come off quite inspid.

### Of COPPER.

*To separate Copper from its Ore.*

BEAT your copper ore to a fine powder, having first freed it as accurately as possible, by washing and roasting, from all stony, earthy, sulphureous, and arsenical parts. Mix your ore thus pulverised with thrice its weight of the black flux; put the mixture into a crucible; cover it with common salt to the thickness of half an inch, and press the whole down with your finger. With all this the crucible must be but half full. Set it in a melting furnace; kindle the fire by degrees, and raise it insensibly till you hear the sea-salt crackle. When the decrepitation is over, make the crucible moderately red-hot for half a quarter of an hour. Then give a considerable degree of heat, exciting the fire with a pair of good perpetual bellows, so that the crucible may become very red hot, and be perfectly ignited. Keep the fire up to this degree for about a quarter of an hour; then take out the crucible, and with a hammer strike a few blows on the floor on which you set it. Break it when cold. If the operation hath been rightly and successfully performed, you will find at the bottom of the vessel a hard regulus, of a bright yellow colour, and semi-malleable; and over it a scoria of a yellowish brown colour, hard, and shining, from which you may separate the regulus with a hammer.

*To purify black Copper, and render it malleable.*

BREAK into small bits the black copper you intend to purify; mix therewith a third part in weight of granulated lead, and put the whole into a cupel set under the muffle in a cupelling furnace, and previously heated quite red. As soon as the metals are in the cupel raise the fire considerably, making use, if it be needful, of a pair of perpetual bellows, to melt the copper speedily. When it is thoroughly melted, lower the fire a little, and continue it just high enough to keep the metalline mass in perfect fusion. The melted matter will then boil, and throw up some scoria, which will be absorbed by the cupel.

When most of the lead is consumed, raise the fire again till the face of the copper become bright and shining, thereby shewing that all its alloy is separated. As soon as your copper comes to this state, cover it with charcoal dust conveyed into the cupel with an iron ladle: Then take the cupel out of the furnace, and let it cool.

*To deprive Copper of its Phlogiston by Calcination.*

PUR your copper in filings into a test, and set it under the muffle of a cupelling furnace; light the fire, and keep up such a degree of heat as may make the whole quite

quite red, but not enough to melt the copper. The surface of the copper will gradually lose its metalline splendor, and put on the appearance of a reddish earth. From time to time stir the filings with a little rod of copper or iron, and leave your metal exposed to the same degree of fire till it be always calcined.

*To resuscitate the Calx of Copper, and reduce it to Copper, by restoring its Phlogiston.*

Mix the calx of copper with thrice as much of the black flux; put the mixture into a good crucible, so as to fill two thirds thereof, and over it put a layer of sea-salt a finger thick. Cover the crucible, and set it in a melting furnace; heat it gradually, and keep it moderately red till the decrepitation of the sea-salt be over. Then raise the fire considerably by means of a good pair of perpetual bellows; satisfy yourself that the matter is in perfect fusion, by dipping into the crucible an iron wire; continue the fire in this degree for half a quarter of an hour. When the crucible is cold, you will find at its bottom a button of very fine copper, which will easily separate from the saline scoria at top.

*To dissolve Copper in the Mineral Acids.*

On a sand-bath, in a very gentle heat, set a matras containing some copper filings; pour on them twice their weight of oil of vitriol. That acid will presently attack the copper. Vapours will rise, and issue out of the neck of the matras. A vast number of bubbles will ascend from the surface of the metal to the top of the liquor, and the liquor will acquire a beautiful blue colour. When the copper is dissolved, put in a little and a little more, till you perceive the acid no longer acts upon it. Then decant the liquor, and let it stand quiet in a cool place. In a short time great numbers of beautiful blue crystals will shoot in it. These crystals are called *vitriol of copper*, or *blue vitriol*. They dissolve easily in water.

## Of I R O N.

*To separate Iron from its Ore.*

POUND into a coarse powder the martial stones or earths out of which you design to extract the iron: Roast this powder in a test under the muffle for some minutes, and let your fire be brisk. Then let it cool, beat it very fine, and roast it a second time, keeping it under the muffle till it emit no more smell.

Then mix with this powder a flux composed of three parts of nitre fixed with tartar, one part of fusile glass, and half a part of borax and charcoal-dust. The dose of this reducing flux must be thrice the weight of the ore.

Put this mixture into a good crucible; cover it with about half a finger thick of sea-salt; over the crucible put its cover, and lute it on with Windsor-loam made into a paste with water. Having thus prepared your crucible, set it in a melting furnace, which you must fill up with charcoal. Light the fire, and let it kindle by gentle degrees, till the crucible become red-hot. When the decrepitation of the sea-salt is over, raise your fire to

the highest by the blast of a pair of perpetual bellows, or rather several. Keep up this intense degree of heat for three quarters of an hour, or a whole hour, taking care that during all this time the furnace be kept constantly filling up with fresh coals as the former consume. Then take your crucible out of the furnace; strike the pavement on which you set it several times with a hammer, and let it stand to cool: Break it, and you will find therein a regulus of iron covered with slag.

In smelting-houses iron ore is fused amidst charcoal, the phlogiston of which combines with the martial earth, and gives it the metalline form. The iron thus melted runs down to the bottom of the furnace, from whence it is let out into large moulds, in which it takes the shape of oblong blocks, called *pigs* of iron. This iron is still very impure, and quite unmalleable. Its want of ductility after the first melting arises partly from hence, that, notwithstanding the previous roasting which the ore underwent, there still remains, after this first fusion, a considerable quantity of sulphur or arsenic combined with the metal.

A certain quantity of quick-lime, or of stones that will burn to lime, is frequently mixed with iron ore on putting it into the smelting furnace. The lime being an absorbent earth, very apt to unite with sulphur and arsenic, is of use to separate those minerals from the iron.

It is also of use to mix some such matters with the ore, when the stones or earths which naturally accompany it are very fusible; for, as the iron is of difficult fusion, it may happen that the earthy matters mixed with the iron shall melt as easily as the metal, or perhaps more easily. In such a case there is no separation of the earthy from the metalline part, both of which melt and precipitate together promiscuously: Now quick-lime, being extremely refractory, serves on this occasion to check the melting of those matters which are too fusible.

Yet quick-lime, notwithstanding its refractory quality, may sometimes be of use as a flux for iron: This is the case when the ore happens to be combined with substances which, being united with lime, render it fusible: Such are all arsenical matters, and even some earthy matters, which, being combined with quick-lime, make a fusible compound.

When the ore of an iron mine is found difficult to reduce, it is usually neglected even though it be rich; because iron being very common, people chuse to work those mines only whose ores are smelted with the most ease, and require the least consumption of wood.

Yet refractory ores are not to be altogether rejected, when another iron ore of a different quality is found near them. For it often happens, that two several iron ores, which being worked separately are very difficult to manage, and yield at last but bad iron, become very tractable, and yield excellent iron, when smelted together: And accordingly such mixtures are often made at iron-works.

The iron obtained from ores by the first fusion may be divided into two sorts. The one, when cold, resists the hammer, doth not easily break, and is in some measure extensible on the anvil; but if struck with a hammer, when red-hot, flies into many pieces: This sort of iron hath

always a mixture of sulphur in it. The other sort, on the contrary, is brittle when cold, but somewhat ductile when red-hot. This iron is not sulphurated, is naturally of a good quality, and its brittleness arises from its metalline parts not being sufficiently compacted together.

Iron abounds so much, and is so universally diffused through the earth, that it is difficult to find a body in which there is none at all: And this hath led several chemists into the error of thinking, that they had transmuted into iron several sorts of earths in which they suspected no iron, by combining them with an inflammable matter; whereas, in fact, all they did was to give the metalline form to a true martial earth which happened to be mixed with other earths.

*To render Pig-iron and brittle Iron malleable.*

INTO an earthen vessel widening upwards, put some charcoal-duft, and thereon lay the pig-iron which you propose to render ductile; cover it all over with a quantity of charcoal; excite the fire violently with a pair, or more, of perpetual bellows till the iron melt. If it do not readily flow and form a great deal of slag on its surface, add some flux, such as a very fusible sand.

When the matter is in fusion, keep stirring it from time to time, that all the parts thereof may be equally acted on by the air and the fire. On the surface of the melted iron *scoriae* will be formed, which must be taken off as they appear. At the same time you will see a great many sparkles darted up from the surface of the metal, which will form a sort of fiery shower. By degrees, as the iron grows purer, the number of these sparkles diminishes, though they never vanish entirely. When but few sparkles appear, remove the coals which cover the iron, and let the slag run out of the vessel; whereupon the metal will grow solid in a moment. Take it out while it is still red-hot, and give it a few strokes with a hammer, to try if it be ductile. If it be not yet malleable, repeat the operation a second time, in the same manner as before. Lastly, when it is thus sufficiently purified by the fire, work it for a long time on the anvil, extending it different ways, and making it red-hot as often as there is occasion. Iron thus brought to the necessary degree of ductility, so as to yield to the hammer, and suffer itself to be extended every way, either hot or cold, without breaking to bits, or even cracking in the least, is very good and very pure. If it cannot be brought to this degree by the method here prescribed, it is a proof, that the ore from which this iron was extracted, ought to be mixed with other ores; but it frequently requires a great number of trials to obtain an exact knowledge of the quality and proportion of those other ores with which it is to be mixed.

*To convert Iron into Steel.*

TAKE small bars of the best iron; that is, of such as is malleable both hot and cold; set them on their ends in a cylindrical earthen vessel, whose depth is equal to the length of the bars, and in such a manner that they may be an inch distant from each other, and from the sides of the crucible. Fill the vessel with a cement compounded of two parts of charcoal, on part of bones burnt in a

close vessel till they become very black, and one half part of the ashes of green wood; having first pulverised and thoroughly mixed the whole together. Take care to lift up the iron bars a little, to the end that the cement may cover the bottom of the vessel, and so that there be about the depth of half an inch thereof under every bar: Cover the crucible and lute on the cover.

Set the crucible thus prepared in a furnace, so contrived, that the crucible may be surrounded with coals from top to bottom: For eight or ten hours keep up such a degree of fire that the vessel may be moderately red; after this take it out of the furnace; plunge your little iron bars into cold water, and you will find them converted into steel.

The principal difference between iron and steel consists in this, that the latter is combined with a greater quantity of phlogiston than the former.

It appears by this experiment, that, to make iron unite with an inflammable matter, it is necessary it should be in fusion; it is sufficient that it be so red-hot as to be opened and softened by the fire.

Every kind of charcoal is fit to be an ingredient in the composition of the cement employed to make steel, provided it contain no vitriolic acid. However, it hath been observed, that animal coals produce a speedier effect than others: for which reason it is proper to mix something of that kind with charcoal-duft, as above directed.

The following signs shew that the operation hath succeeded, and that the iron is changed into good steel.

This metal being quenched in cold water as proposed above, acquires such an extraordinary degree of hardness, that it will by no means yield to any impression of the file or hammer, and will sooner break in pieces than stretch upon the anvil. And here it is proper to observe, that the hardness of steel varies with the manner in which it is quenched. The general rule is, that the hotter the steel is when quenched, and the colder the water is in which you quench it, the harder it becomes. It may be deprived of the temper thus acquired, by making it red-hot, and letting it cool slowly; for it is thereby softened, rendered malleable, and the file will bite upon it. For this reason the artificers who work in steel begin with untempering it, that they may with more ease shape it into the tool they intend to make. They afterwards new-temper the tool when finished, and by this second temper the steel recovers the same degree of hardness it had acquired by the first temper.

The colour of steel is not so white as that of iron, but darker, and the grains, facets, or fibres, which appear on breaking it, are finer than those observed in iron.

If the bars of iron thus cemented, in order to convert them into steel, be too thick, or not kept long enough in cementation, they will not be turned into steel throughout their whole thickness: their surfaces only will be steel to a certain depth, and the centre will be mere iron; because the phlogiston will not have thoroughly penetrated them. On breaking a bar of this sort, the difference in colour and grain between the steel and the iron is very visible.

It is easy to deprive steel of the superabundant quantity of



of phlogiston which constitutes it steel, and thereby reduce it to iron. For this purpose it need only be kept red-hot for some time, observing that no matter approach it all the while that is capable of refunding to it the phlogiston which the fire carries off. The same end is still sooner obtained by cementing it with meagre hungry matters, capable of absorbing the phlogiston; such as bones calcined to whiteness, and cretaceous earths.

*The Calcination of Iron. Sundry Saffrons of Mars.*

TAKE filings of iron, what quantity you please; put them into a broad unglazed earthen vessel, set under the muffle of a cupelling furnace: make it red-hot; stir the filings frequently; and keep up the same degree of fire till the iron be wholly turned into a red powder.

Iron easily loses its phlogiston by the action of fire. The calx that remains after its calcination is exceeding red; which makes this be thought the natural colour of the earth of that metal. It hath accordingly been observed, that all the earths and stones, which either are naturally red, or acquire that colour by calcination, are ferruginous.

The yellowish red colour which every calx of iron hath, in whatever manner it be prepared, hath procured the name of *crocus*, or *saffron*, to every preparation of this kind. That made in the manner above directed is called in medicine *crocus martis astringens*.

The rust produced on the surface of iron, is a sort of calx of iron made by the way of dissolution. The moisture of the air acts upon the metal, dissolves it, and robs it of some of its phlogiston. This rust is called in medicine *crocus martis aperiens*; because it is thought that the saline parts, by means whereof the humidity dissolves the iron, remain united with the metal after its dissolution, and give it an aperitive virtue. The apothecaries prepare this sort of saffron of mars by exposing iron filings to the dew till they be turned entirely to rust; which is then called *saffron of mars by dew*.

Another saffron of mars is also prepared in a much shorter manner, by mixing filings of iron with pulverised sulphur, and moistening the mixture, which after some time ferments and grows hot. It is then set on the fire; the sulphur burns away, and the mars is kept stirring till it become a red matter. This saffron is nothing but iron dissolved by the acid of sulphur, which is known to be of the same nature with that of vitriol; and consequently this saffron of mars is no way different from vitriol calcined to redness.

*Iron dissolved by the mineral Acids.*

PUT any mineral acid whatever into a matras with some water; set the matras on a sand-bath gently heated; drop into the vessel some filings of iron: the phenomena which usually accompany metalline dissolutions will immediately appear. Add more filings, till you observe the acid hath lost all sensible action upon them: then remove your matras from the sand-bath; you will find in it a solution of iron.

Of T I N.

*To extract Tin from its Ore.*

BREAK your tin ore into a coarse powder, and by washing carefully, separate from it all the heterogeneous matters and ores of a different kind that may be mixed therewith. Then dry it, and roast it in a strong degree of fire, till no more arsenical vapour rise from it. When the ore is roasted, reduce it to a fine powder, and mix it thoroughly with twice its weight of the black flux well dried, a fourth part of its weight of clean iron filings, together with as much borax and pitch: put the mixture into a crucible; over all put sea-salt to the thickness of four fingers, and cover the crucible close.

Set the crucible thus prepared in a melting furnace: apply at first a moderate and slow degree of fire, till the flame of the pitch, which will escape through the joint of the cover, disappear entirely. Then suddenly raise your fire, and urge it with rapidity to the degree necessary for melting the whole mixture. As soon as the whole is in fusion, take the crucible out of the furnace, and separate the regulus from the scoria.

All tin ores contain a considerable quantity of arsenic, and no sulphur at all, or at most very little. Hence, though tin be the lightest of all metals, its ore is nevertheless much heavier than any other; arsenic being much heavier than sulphur, of which the ores of every other kind always contain a pretty large proportion. This ore is moreover very hard, and is not brought to a fine powder with so much ease as the rest.

These properties of tin ore furnish us with the means of separating it easily by lotion, not only from earthy and stony parts, but even from the other ores which may be mixed with it. And this is of the greater advantage on two accounts, *viz.* because tin cannot endure, without the destruction of a great part thereof, the degree of fire necessary to scorify the refractory matters which accompany its ore; and again, because this metal unites so easily with iron and copper, the ores of which are pretty commonly blended with tin ore, that after the reduction it would be found adulterated with a mixture of these two metals, if they were not separated from it before the fusion.

Into an unvarnished earthen dish put the quantity of tin you intend to calcine; melt it, and keep stirring it from time to time. Its surface will be covered with a greyish white powder: Continue the calcination till all your tin be converted into such a powder, which is the calx of tin.

*The dissolution of Tin by Acids.*

Put into a glass vessel what quantity you please of fine tin cut into little bits. Pour on it thrice as much *aqua regis*, compounded of two parts *aqua fortis* weakened with an equal quantity of very pure water, and one part spirit of salt. An ebullition will arise, and the tin will be very rapidly dissolved; especially if the quantities of metal and of *aqua regis* be considerable.

*To extract Lead from its Ore.*

HAVING roasted your lead-ore, reduce it to a fine powder; mix it with twice its weight of the black flux, and one fourth of its weight of clean iron filings and borax; put the whole into a crucible capable of containing at least thrice as much; over all put sea-salt four fingers thick; cover the crucible; lute the juncture; dry the whole with a gentle heat, and set it in a melting furnace.

Make the crucible moderately red: you will hear the sea-salt decrepitate, and after the decrepitation a small hissing in the crucible. Keep up the same degree of fire till that be over.

Then throw in as many coals as are necessary to complete the operation entirely, and raise the fire suddenly, so as to bring the whole mixture into perfect fusion. Keep up this degree of fire for a quarter of an hour, which is time sufficient for the precipitation of the regulus.

When the operation is finished, which may be known by the quietness of the matter in the crucible, and by a bright vivid flame that will rise from it, take the crucible out of the furnace, and separate the regulus from the scoria.

*To separate Lead from Copper.*

WITH luting earth and charcoal-dust make a flat vessel, widening upwards, and large enough to contain your metalline mass. Set it shelving downwards from the back towards the fore-part; and in the fore-part, at the bottom, make a little gutter communicating with another vessel of the same nature, placed near the former and a little lower. Let the mouth of the gutter within side the upper vessel be narrowed, by means of a small iron plate fixed across it, while the loam is yet soft; so as to leave a very small aperture in the lower part of this canal sufficient to discharge the lead as it melts. Dry the whole by placing lighted coals round it.

When this apparatus is dry, put your mixed mass of copper and lead into the upper vessel: both in that, and in the other vessel, light a very gentle fire of wood or charcoal, so as not to exceed the degree of heat necessary to melt lead. In such a degree of heat the lead contained in the mixed mass will melt, and you will see it run out of the upper vessel into the lower; at the bottom of which it will unite into a regulus. When in this degree of heat no more lead flows, increase the fire a little, so as to make the vessel moderately red.

When no more will run, collect the lead contained in the lower vessel. Melt it over again in an iron ladle, with a degree of fire sufficient to make the ladle red; throw into it a little tallow or pitch, and while it burns keep stirring the metal, in order to reduce any part of it that may be calcined. Remove the pellicle or thin crust which will form on the surface; squeeze out all the lead it contains, and then put it to the mass of copper left in the upper vessel. Check the fire, and in the same manner take off a second skin that will form on the surface of the lead. Lastly, when the metal is ready to fix, take off the skin that will then appear on it. The lead

remaining after this will be very pure, and free from all alloy of copper.

With regard to the copper itself, you will find it in the upper vessel covered with a thin coat of lead, and if the lead mixed with it was in the proportion of a fourth or a fifth part only, and the fire applied was gentle and slow, it will retain nearly the same form after the operation that the mixed mass had before.

*The Calcination of Lead.*

TAKE what quantity of lead you please; melt it in one or more unglazed earthen pans: a dark grey powder will be found on its surface. Keep stirring the metal incessantly till it be wholly converted into such a powder, which is the *calx of lead*.

In the calcination of all metals, and particularly in this of lead, there appears a singular phenomenon which is not easily accounted for. It is this: though these matters lose a great deal of their substance, either by the dissipation of their phlogiston, or because some of the metal perhaps exhales in vapours, yet, when the calcination is over, their calxes are found to be increased in weight, and this increase is very considerable. An hundred pounds of lead, for example, converted into minium, which is nothing but a calx of lead brought to a red colour by continuing the calcination, are found to gain ten pounds weight; so that for an hundred pounds of lead we have one hundred and ten pounds of minium: a prodigious and almost incredible augmentation, if it be considered that, far from adding any thing to the lead, we have on the contrary dissipated part of it.

*To prepare Glass of Lead.*

TAKE two parts of litharge, and one part of pure crystalline sand; mingle them together as exactly as possible, adding a little nitre and sea-salt: put this mixture into a crucible of the most solid and most compact earth. Shut the crucible with a cover that may perfectly close it.

Set the crucible thus prepared in a melting furnace; fill the furnace with coals; light the fire gradually, so that the whole may be slowly heated: Then raise the fire so as to make the crucible very red, and bring the matter it contains into fusion; keep it thus melted for a quarter of an hour.

Then take the crucible out of the furnace, and break it: In the bottom thereof you will most commonly find a small button of lead, and over it a transparent glass of a yellow colour nearly resembling that of amber. Separate this glass from the little button of metal, and from the saline matters which you will find above it.

*Lead dissolved by the Nitrous Acid.*

PUT into a matras some *aqua fortis* precipitated like that used to dissolve silver; weaken it by mixing therewith an equal quantity of common water; set the matras in a hot sand-bath; throw into it, little by little, small bits of lead, till you see that no more will dissolve. *Aqua fortis* thus lowered will dissolve about a fourth of its weight of lead.

There is gradually formed upon the lead, as it dissolves, first a grey powder, and afterwards a white crust, which

which at last hinder the solvent from acting on the remaining part of the metal; and therefore the liquor should be made to boil, and the vessel should be shaken to remove those impediments, by which means all the lead will be dissolved.

### Of MERCURY.

*To extract Mercury from its Ore, or to revivify it from Cinabar.*

PULVERIZE the cinabar from which you would extract the mercury; with this powder mix an equal part of clean iron filings; put the mixture into a retort of glass or iron, leaving at least one third part thereof empty. Set the retort thus prepared in a sand-bath, so that its body may be quite buried in the sand, and its neck decline considerably downwards: fit on a receiver half filled with water, and let the nose of the retort enter about half an inch into the water.

Heat the vessel so as to make the retort moderately red. The mercury will rise in vapours, which will condense into little drops, and fall into the water in the receiver. When you see that nothing more comes over with this degree of heat, increase it, in order to raise what mercury may still be left. When all the mercury is thus brought over, take off the receiver, pour out the water contained in it, and collect the mercury.

Mercury is never mineralized in the bowels of the earth by any thing but sulphur: with which it forms a compound of a brownish red colour, known by the name of *Cinabar*.

The oldest and richest mine of mercury is that of Almaden in Spain. It is a singular property of that mine, that though the mercury found in it is combined with sulphur, and in the form of cinabar, yet no additament is required to procure the separation of these two; the earthy and stony matter, with which the particles of the ore are incorporated, being itself an excellent absorbent of sulphur.

In the quick-silver works carried on at this mine they make no use of retorts. They place lumps of the ore on an iron grate, which stands immediately over the furnace. The furnaces which serve for this operation are closed at the top by a sort of dome, behind which stands the shaft of a chimney that communicates with the fire-place, and gives vent to the smoke. These furnaces have in their fore-side sixteen apertures, to each of which is luted an aludel in a horizontal position, communicating with a long row of other aludels placed likewise in an horizontal direction; which aludels so connected together form one long pipe or canal, the further end whereof opens into a chamber destined to receive and condense all the mercurial vapours. These rows of aludels are supported from end to end by a terrass, which runs from the body of the building, wherein the furnaces are erected, to that where the chambers are built that perform the office of receivers.

This a very ingenious contrivance, and saves much labour, expence, and trouble, that would be unavoidable if retorts were employed.

That part of the furnace which contains the lumps of ore, serves for the body of the retort; the row of aludels for its neck; and the little chambers in which these canals terminate are actual receivers. The terrass of communication, which reaches from the one building to the other, is formed of two inclined planes, the lower edges of which, meeting in the middle of the terrass, rise from thence insensibly; the one quite to the building where the furnaces are, and the other to that which forms the recipient chambers. By this means, when any mercury escapes through the joints of the aludels, it naturally runs down along these inclined planes, and so is collected in the middle of the terrass, where the inferior sides of the planes meeting together form a sort of canal, out of which it is easily taken up.

*To give Mercury, by the action of Fire, the appearance of a Metalline Calx.*

Put mercury into several little glass matrasses with long and narrow necks. Stop the matrasses with a little paper, to prevent any dirt from falling into them. Set them all in one sand-bath, so that they may be surrounded with sand as high as two thirds of their length. Apply the strongest degree of heat that mercury can bear without subliming: continue this heat without interruption, till all the mercury be turned to a red powder. The operation lasts about three months.

Mercury thus converted to a red powder is known in chemistry and medicine by the name of *mercury precipitated per se*.

*To dissolve Mercury in the Vitriolic Acid. Turbith mineral.*

Put mercury into a glass retort, and pour on it thrice its weight of good oil of vitriol. Set the retort in a sand-bath; fit on a recipient; warm the bath by degrees till the liquor just simmer. With this heat the mercury will begin to dissolve. Continue the fire in this degree till all the mercury be dissolved.

The vitriolic acid dissolves mercury pretty well: but for this purpose the acid must be very hot, or even boil; and then too it is a very long time before the dissolution is completed. We have directed the operation to be performed in a retort; because this solution is usually employed to make another preparation called *turbith mineral*, which requires that as much as possible of the acid solvent be abstracted by distillation. Having therefore dissolved your mercury in the vitriolic acid, if you will now prepare the turbith, you must, by continuing to heat the retort, drive over all the liquor into the receiver, and distill till nothing remains but a white powdery matter: then break the retort; pulverise its contents in a glass mortar, and thereon pour common water, which will immediately turn the white matter of a lemon-colour; wash this yellow matter in five or six warm waters, and it will be what is called in medicine *turbith mineral*; that is, a combination of the vitriolic acid with mercury, five or six grains whereof is a violent purgative, and also an emetic; qualities which it possesses in common

common with the vegetable turbit, whose name it hath therefore taken.

*To combine Mercury with sulphur. Æthiops Mineral.*

MIX a dram of sulphur with three drams of quicksilver, by trituration the whole in a glass mortar with a glass pestle. By degrees, as you triturate, the mercury will disappear, and the matter will acquire a black colour. Continue the triture till you cannot perceive the least particle of running mercury. The black matter you will then have in the mortar is known in medicine by the name of *æthiops mineral*. An *æthiops* may also be made by fire in the following manner.

In a shallow unglazed earthen pan melt one part of flowers of sulphur: add three parts of running mercury, making it fall into the pan in the form of small rain, by squeezing it through chamoy leather. Keep stirring the mixture with the shank of a tobacco-pipe all the while the mercury is falling: you will see the matter grow thick and acquire a black colour. When the whole is thoroughly mixed, set fire to it with a match, and let as much of the sulphur burn away as will flame.

*To sublime the combination of Mercury and Sulphur into Cinabar.*

GRIND to powder *æthiops mineral* prepared by fire. Put it into a cucurbit; fit thereto a head; place it in a sand-bath, and begin with applying such a degree of heat as is requisite to sublime sulphur. A black matter will rise, and adhere to the sides of the vessel. When nothing more will rise with this degree of heat, raise the fire so as to make the sand and the bottom of the cucurbit red; and then the remaining matter will sublime in the form of a brownish red mass, which is true *cinabar*.

*To dissolve Mercury in the Nitrous acid. Sundry Mercurial Precipitates.*

PUT into a matras the quantity of mercury you intend to dissolve: pour on it an equal quantity of good spirit of nitre, and set the matras in a sand-bath moderately heated. The mercury will dissolve with the phenomena that usually attend the dissolutions of metals in this acid. When the dissolution is completed, let the liquor cool. You will know that the acid is perfectly saturated, if there remain at the bottom of the vessel, notwithstanding the heat, a little globule of mercury that will not dissolve.

Mercury dissolves in the nitrous acid with much more facility, and in much greater quantity, than in the vitriolic; so that it is not necessary, on this occasion, to make the liquor boil. This solution when cold yields crystals, which are a nitrous mercurial salt. If you desire to have a clear limpid solution of mercury, you must employ an *aqua fortis* that is not tainted with vitriolic or marine acid: for, the affinity of these two acids with mercury being greater than that of the nitrous acid, they precipitate it in the form of a white powder, when they are mixed with the solvent.

Mercury thus precipitated in a white powder, out of a solution thereof in the spirit of nitre, is used in medi-

cine. To obtain this precipitate, which is known by the name of the *white precipitate*, sea salt, dissolved in water, together with a little sal ammoniac is used; and the precipitate is washed several times in pure water, without which precaution it would be corrosive, on account of the great quantity of the marine acid which it would contain.

The preparation known by the name of *red precipitate*, is also obtained from our solution of mercury in spirit of nitre. It is made by abstracting all the moisture of the solution, either by distillation in a retort, or by evaporation in a glass basin set on a sand-bath. When it begins to grow dry, it appears like a white ponderous mass. Then the fire is made strong enough to drive off almost all the nitrous acid, which, being now concentrated, rises in the form of red vapours. If these vapours be caught in a receiver, they condense into a liquor, which is a very strong and vastly smoking spirit of nitre.

By degrees, as the nitrous acid is forced up by the fire, the mercurial mass loses its white colour, and becomes first yellow, and at last very red. When it is become entirely of this last colour, the operation is finished. The red mass remaining is a mercury that contains but very little acid, in comparison of what it did while it was white: and indeed the first white mass is such a violent corrosive, that it cannot be used in medicine; whereas, when it is become red, it makes an excellent escharotic, which those who know how to use it properly apply with very great success, particularly to venereal ulcers.

*To combine Mercury with the Acid of Sea-salt. Corrosive Sublimate.*

EVAPORATE a solution of mercury in the nitrous acid till there remain only a white powder, as mentioned in our observations on the preceding process. With this powder mix as much green vitriol calcined to whiteness, and decrepitated sea-salt, as there was mercury in the solution. Triturate the whole carefully in a glass mortar. Put this mixture into a matras, so that two thirds thereof may remain empty, having first cut off the neck to half its length; or instead thereof you may use an apothecary's phial. Set your vessel in a sand-bath, and put sand round it as high as the contents reach. Apply a moderate fire at first, and raise it by slow degrees. Vapours will begin to ascend. Continue the fire in the same degree till they cease. Then stop the mouth of the vessel with paper, and increase the fire till the bottom of the sand-bath be red-hot. With this degree of heat a sublimate will rise, and adhere to the inside and upper part of the vessel, in the form of white, semi-transparent crystals. Keep up the fire to the same degree till nothing more sublimes. Then let the vessel cool; break it, and take out what is sublimed, which is *corrosive sublimate*.

*Sweet Sublimate.*

TAKE four parts of corrosive sublimate; pulverise it in a glass or marble mortar; add by little and little three parts of mercury revived from cinabar; triturate the whole carefully, till the mercury be perfectly killed, so that

that no globule thereof can be perceived. The matter will then be grey. Put this powder into an apothecary's phial, or into a matras, whose neck is not above four or five inches long, leaving two thirds thereof empty. Set the vessel in a sand-bath, and put sand round it to one third of its height. Apply a moderate fire at first; and afterwards raise it gradually till you perceive that the mixture sublimes. Keep it up to this degree till nothing more will rise, and then break the vessel. Reject, as useless, a small quantity of earth which you will find at the bottom; separate also what adheres to the neck of the vessel, and carefully collect the matter in the middle, which will be white. Pulverise it; sublime it a second time, in the same manner as before; and in the same manner separate the earthy matter left at the bottom of the vessel, and what you find sublimed into the neck. Pulverise, and sublime a third time, the white matter you last found in the middle. The white matter of this third sublimation is the *sweet sublimate*, called also *aquila alba*.

#### *The Panacea of Mercury.*

PULVERISE some sweet sublimate, and sublime it in the same manner as you did thrice before. Repeat this nine times. After these sublimations it will make no impression on the tongue. Then pour on it aromatic spirit of wine, and set the whole in digestion for eight days. After that decant the spirit of wine, and dry what remains, which is the *panacea of mercury*.

#### Of ANTIMONY.

##### *To separate Antimony from its Ore by Fusion.*

HAVING drilled some small holes, of about two lines diameter, in the bottom of a crucible, put into it your antimonial ore broken into little bits, about the size of a hazel nut; lute on its cover; set the crucible thus prepared in the mouth of another crucible, and close the joints with lute.

At the distance of half a foot from this compound vessel place bricks all round, so as to form a furnace; the sides of which must rise as high as the brim of the uppermost crucible.

Let the bottom of this furnace be filled with ashes, up to the top of the lower crucible, and the rest of the furnace with lighted coals. Blow the fire, if it be necessary, with bellows, till the upper crucible become red. Keep it up in this degree for about a quarter of an hour. Then take your vessels out of the furnace, and you will find the antimony collected in the bottom of the lower crucible, having run through the holes of the upper one.

##### *The common Regulus of Antimony.*

REDUCE crude antimony to powder. Mix it with three fourths of its weight of white tartar, and half its weight of refined salt-petre, both pulverised. Into a large crucible, made red-hot in the fire, throw a spoonfull of your mixture, and cover it. There will be a very considerable detonation. When it is over, throw in a second spoonfull of your mixture, and cover the crucible

as before: this will produce a second detonation. Go on thus, till you have thrown in all your mixture.

When the whole has thus fulminated, increase the fire so as to bring the matter into fusion; that being done, take the crucible out of the furnace, and immediately pour its contents into an iron cone heated and greased with tallow. Strike the floor and the cone some gentle blows with a hammer, to make the regulus precipitate; and when the matter is fixed and cold, invert the cone, and turn it out. You will see it consist of two distinct substances; the uppermost of which is a saline scoria, and the undermost the reguline part. Strike this mass a blow with a hammer, in the place where these substances join, and you will by this means separate the scoria from the regulus; the latter of which will have the form of a metallic cone, on whose base you will observe the signature of a bright star.

##### *Regulus of Antimony precipitated by Metals.*

PUT one part of small iron nails into a crucible, and set it amidst burning coals, in a melting furnace. When the iron is thoroughly red-hot, and begins to grow white, add thereto little by little, and at several times, two parts of crude antimony in powder. The antimony will immediately flow and unite with the iron. When the antimony is entirely melted, add thereto, at several times, the fourth of its weight of pulverised nitre: a detonation will ensue, and the whole mixture will be in fusion.

After you have kept the matter in this condition for some minutes, pour it into an iron cone, first heated and tallowed. Strike the sides of the cone with a hammer, that the regulus may fall to the bottom; and, when all is cold, separate it from the scoria by a blow with a hammer. Melt this first regulus again in another crucible, adding a fourth part of its weight of crude antimony. Keep the crucible close shut, and give no more heat than is necessary to melt the matter. When it is in perfect fusion, add to it at several times, as you did before, the sixth part of its weight of pulverised nitre; and, in half a quarter of an hour after this, pour the whole into a cone as you did the first time.

Lastly, Melt your regulus over again a third or even a fourth time, always adding a little nitre, which will detonate as before. If after all these fusions you pour the regulus into an iron cone, you will find it very beautiful, and the star well formed: it will be covered with a semi-transparent, lemon-coloured scoria. This scoria is extremely acrid and caustic.

##### *The Calcination of Antimony.*

TAKE an unglazed earthen vessel, wider at top than at bottom; put into it two or three ounces of crude antimony finely pulverised. Set this vessel over a weak charcoal-fire, and increase the heat till you see the antimony begin to smoke a little. Continue the fire in this degree, and keep incessantly stirring the antimony with the shank of a tobacco-pipe all the while it is upon the fire.

The powder of antimony, which, before calcination, was of a brilliant colour inclining to black, will become dull,

dull, and look like an earth. When it comes to have this appearance, raise your fire till the vessel be red-hot, and keep it up in this degree till the matter cease entirely to smoke.

*Calx of Antimony reduced to a Regulus.*

MIX the calx of antimony, which you intend to reduce, with an equal quantity of black soap. This mixture will make a thin paste. Put it little by little into a crucible, previously made red-hot amidst live coals. Thus let the soap burn, till it cease to emit an oily smoke. Then cover the crucible; make the fire strong enough to melt the matter, and you will hear it effervesce and boil. When this noise is over, let the crucible cool, and then break it: you will find in it a beautiful scoria, marked with circles of several colours; and under that a button of regulus, which is not yet quite pure, and must be purified in the following manner.

Pound this regulus, and mix it with half its weight of an antimonial calx as perfectly desulphurated as possible. Put it into a crucible, and cover it: melt the whole, so that the surface of the melted matter may be smooth and uniform. Let the crucible cool, and then break it: you will find in it a beautiful button of very pure regulus, covered with a scoria, having the appearance of an opaque glass, or a kind of greyish enamel, moulded on the finely radiated surface of the regulus.

*Antimony calcined with Nitre. Liver of Antimony.*

PULVERISE and mix perfectly together equal parts of nitre and antimony: put the mixture into an iron mortar, and cover it with a tile, which however must not shut it quite close. With a live coal set fire to the matter in the mortar, and immediately withdraw it. The mixture will flame, with great detonation; which being over, and the mortar cooled, invert it, and strike its bottom to make all the matter fall out. Then, by a blow with a hammer, separate the scoria from the shining part, which is the *liver of antimony*.

*Another Calcination of Antimony with Nitre. Diaphoretic Antimony.*

MIX one part of antimony with three parts of nitre; project this mixture by spoonfulls into a crucible kept red hot in a furnace. Each projection will be attended with a detonation. Continue doing this till you have used all your mixture: then raise the fire, and keep it up for two hours; after which throw your matter into a pan full of hot water. Let it lie steeping in water kept hot for a whole day. Then pour off the liquor: wash the white powder you find at bottom in warm water; and repeat the ablutions till the powder become insipid. Dry it, and you have *diaphoretic antimony*.

*Calx of Antimony vitrified.*

TAKE any quantity you please of calx of antimony, made without addition; put it into a good crucible, which set in a melting furnace: kindle the fire gradually, and leave the crucible uncovered at the beginning.

A quarter of an hour after the matter is red-hot, cover the crucible, and excite the fire vigorously till the

calx melt. You may know when it is thoroughly melted, by dipping into the crucible an iron wire, to the end of which a little knob of glass will adhere, if the matter be in perfect fusion. Keep it in fusion for a quarter of an hour, or rather longer if your crucible can bear it. Then take it out of the furnace, and immediately pour out the melted matter on a smooth stone, made very hot for the purpose: it will presently fix into a yellow glass.

*Kermes Mineral.*

BREAK any quantity you will of Hungarian antimony into little bits: put it into a good earthen coffee-pot: pour on it twice its weight of rain-water, and a fourth part of its weight of well filtered liquor of nitre fixed by charcoal. Boil the whole briskly for two hours, and then filter the liquor. As it cools it will acquire a red colour, grow turbid, and leave a red powder on the filter.

Return your antimony into the coffee-pot. Pour on it as much rain-water as before, and three fourths of the former quantity of the liquor of fixed nitre. Boil it again for two hours, and then filter the liquor. It will again deposit a red sediment. Return your antimony into the coffee pot: pour on it the same quantity of rain-water, and half the first quantity of the liquor of fixed nitre. Boil it again for two hours, and filter the liquor as formerly. Wash all these sediments with warm water, till they become insipid; then dry them, and you have the *kermes mineral*.

*Regulus of Antimony dissolved in the Mineral Acids.*

COMPOUND an *aqua regis* by mixing together four measures of spirit of nitre, and one measure of spirit of salt: on a sand-bath moderately heated place a matras, into which pour sixteen times as much of this *aqua regis* as you have regulus to dissolve. Break your regulus in little bits; and throw them successively one after another into the matras, observing not to add a new one till that put in before is entirely dissolved: continue this till your regulus be all used. By degrees, as the dissolution advances, the liquor will acquire a beautiful golden colour; which however will insensibly disappear, as the white fumes that continually ascend from it evaporate.

*Regulus of Antimony combined with the Acid of Sea-salt. Butter of Antimony. Cinabar of Antimony.*

PULVERISE and mix thoroughly six parts of regulus of antimony, and sixteen parts of corrosive sublimate. Put this mixture into a glass retort that hath a wide short neck, and let one half of its body at least be left empty. Set it in a reverberatory furnace, and having fitted a recipient thereto and luted the joint, make a very small fire at first to heat it slowly. Increase it afterwards by degrees, till you see a liquor ascend from the retort that grows thick as it cools. Keep up the fire to this degree as long as you see any of this matter come over.

When no more arises with this degree of fire, unlute your vessels, take off the receiver, and in its place substitute another filled with water. Then increase your fire by degrees till the retort be red-hot. Some running

ning mercury will fall into the water, which you may dry and keep for use; it being very pure.

Soon after mixing the regulus with the corrosive sublimate, the matter sometimes grows considerably hot: This is occasioned by the marine acid's beginning to act on the reguline part, and to desert its mercury.

The butter of antimony rises with a very moderate heat; because the acid of sea-salt hath the property of volatilizing, and carrying up along with it, the metallic substances with which it is combined: And for this reason a very gentle heat only is required at the beginning of the operation.

It is absolutely necessary that the neck of the retort be wide and short: for otherwise, if the butter of antimony should fix and be accumulated therein, it might stop up the passage entirely, and occasion the bursting of the vessels. By this operation we obtain eight parts and three quarters of fine butter of antimony, and ten parts of running mercury; there being left in the retort one part and a half of a rarefied matter, black, white, and red. This is probably the most earthy and most impure part of the regulus of antimony.

If crude antimony, instead of regulus of antimony, be mixed with corrosive sublimate, a butter of antimony will be obtained in the same manner; but, instead of having a running mercury after the butter, you will find a cinabar sublimed into the neck and upper concavity of the retort.

The reason of this difference is easily conceived: for, when the regulus is used, the mercury being deserted by its acid, finds no other substance to unite with, and so rises in the form of quick-silver; but when crude antimony is employed instead of its regulus, as the reguline part thereof cannot combine with the acid without quitting its sulphur, so this sulphur, being at liberty, unites with the mercury, which is so likewise, and therewith forms a cinabar; which from its origin is named *cinabar of antimony*.

*Butter of Antimony decomposed by means of Water only. The Pulvis Algaroth, or Mercurius Vitæ.*

MELT with a gentle heat as much butter of antimony as you please. When it is melted, pour it into a large quantity of warm water. The water will immediately grow turbid, but whitish, and let fall a great quantity of white powder. When all the precipitate is settled, decant the water: pour on fresh warm water; and having thus edulcorated it by several ablutions, dry it, and you have the *pulvis Algaroth, or mercurius vitæ*.

#### *Bezoar Mineral.*

MELT butter of antimony over warm ashes, and put it into a phial or matras. Gradually pour on it good spirit of nitre, till the matter be entirely dissolved. This usually requires as much spirit of nitre as there is butter of antimony. During the dissolution fumes will rise, which must be carefully avoided. Pour your solution, which will be clear and of a reddish colour, into a glass cucurbit, or a pan of stone-ware; set it in a sand-bath, and evaporate to dryness with a moderate heat. There will be left a white mass, weighing a fourth part less

than the whole quantity used, both of butter and the spirit of nitre. Let it cool, and again pour on it as much spirit of nitre as you used the first time. Place the vessel again in the sand-bath, and evaporate the moisture as before. You will have a white mass that hath neither gained nor lost in weight. On this pour, for the third time, the same quantity of spirit of nitre as you did the first time. Again evaporate the moisture to perfect dryness: then increase your fire, and calcine the matter for half an hour. You will have left a dry, friable, light, white matter, of an agreeable acid taste; which will fall into a coarse powder, and must be kept in a phial carefully stoppt. This is Bezoar mineral: it is neither caustic nor emetic, and has only a sudorific virtue. It obtained the name it bears, because, like the animal bezoar, it was imagined to have the property of resisting poison.

#### *Flowers of Antimony.*

TAKE an unglazed earthen pot, having an aperture in its side, with a stopple to shut it close. Set this pot in a furnace, the cavity whereof it may fit as exactly as possible; and fill up with lute the space, if any, left between the vessel and the furnace. Over this vessel fix three aludels with a blind-head at the top; and light a fire in the furnace under the pot.

When the bottom of the pot is thoroughly red, throw into the lateral aperture a small spoonful of powdered antimony. Stir the matter immediately with an iron spatula made a little bending, in order to spread it over the bottom of the vessel, and then stop the hole. The flowers will rise and adhere to the insides of the aludels. Keep up the fire so that the bottom of the pot may always continue red; and, when nothing more sublimes, put in a like quantity of antimony, and operate as before. In this manner go on subliming your antimony, till you have as many flowers as you want. Then let the fire go out; and when the vessels are cold, unlute them. You will find flowers adhering all round the insides of the aludels and the head, which you may collect with a feather.

#### *Regulus of Antimony converted into flowers.*

PULVERISE your regulus of antimony: put the powder into an unglazed earthen port: three or four fingers breadth above the powder, fit into the pot a little cover, made of the same earth and having a small hole in its middle, so that it may with ease be placed in the pot and taken out when there is occasion: cover the mouth of the pot with a common lid; set it in a furnace, and kindle a fire under it sufficient to make the bottom of the pot red and to melt the regulus. When it hath been thus kept in fusion for about an hour, let the fire go out and the whole cool. Then remove the two covers. You will find adhering to the surface of the regulus, which will be in a mass at the bottom of the pot, white flowers resembling snow, intermixed with beautiful, brilliant, silver coloured needles. Take them out, and you will find them make about one part in sixty-two of the whole regulus employed.

Put the covers again in their places, and proceed in the same manner as before: When the vessels are cold,

cold, you will find half as many more flowers as you got the first time.

Proceed thus till you have converted all your regulus into flowers. This will require a considerable number of sublimations, which, as you advance, will always yield you a greater portion of flowers; respect, however, being had to the quantity of regulus remaining in the pot.

#### Of BISMUTH.

##### To extract Bismuth from its Ore.

**BREAK** the ore of bismuth into small pieces, and therewith fill a crucible either of earth or iron. Set the crucible in a furnace, and light such a fire that the bits of ore may become moderately red. Stir the ore from time to time; and if you perceive it crackle and fly, keep the crucible covered. At the bottom you will find a button of bismuth.

##### *Bismuth dissolved by Acids. Magistery of Bismuth-Sympathetic Ink.*

**INTO** a matras put bismuth broken into little bits: pour on it, by little and little, twice as much *aqua fortis*. This acid will attack the semi-metal briskly, and dissolve it entirely, with heat, effervescence, vapours, and puffing up. The solution will be clear and limpid.

If you would have a magistery of bismuth beautifully white, you must perform the dissolution with an *aqua fortis* that is not tainted with any mixture of the vitriolic acid; for this gives the precipitate a dirty white colour, inclining to grey.

Bismuth may also be precipitated by the means of fixed or volatile alkalis; but the precipitate is not of so fine a white as when procured by the means of pure water only.

A solution of bismuth prepared with the proper quantity of *aqua fortis*, that is, with two parts of the acid to one of the semi metal, coalesces into little crystals almost as soon as made.

*Aqua fortis* not only acts on bismuth when separated from its ore, and reduced to a regulus, but attacks it even in its ore, and likewise dissolves at the same time some portion of the ore itself. With this solution of the ore of bismuth Mr Hellot makes a very curious sympathetic ink, differing from all that were known before.

Mr Hellot prepares the liquor in the following manner: "He bruises the ore of bismuth to a coarse powder. On two ounces of this powder he pours a mixture of five ounces of common water with five ounces of *aqua fortis*. He does not heat the vessel till the first ebullitions are over. He then sets it in a gentle sand-heat, and lets it digest there till he sees no more air-bubbles rise. When none appear in this heat, he increases it so as to make the solvent boil slightly for a full quarter of an hour. It takes up a tincture nearly of the colour of brown beer. The ore that gives the *aqua fortis* this colour is the best. He then lets the solution cool, laying the matras on its side, that he may decant the liquor more conveniently when all is precipitated that is not taken up by the solvent.

"The second vessel, into which the liquor is first decanted, he also lays declining, that a new precipitation of the undissolved matters may be obtained; after which he pours the liquor into a third vessel. This liquor must not be filtered, if you would have the rest of the process succeed perfectly; because the *aqua fortis* would dissolve some of the paper, and that would spoil the colour of your liquor.

"When this solution, which Mr Hellot calls the *impregnation*, is thoroughly clarified by being decanted three or four times, he puts it into a glass basin with two ounces of very pure sea-salt. The fine white salt made by the sun succeeded best with Mr Hellot. If that cannot be had, common bay-salt purified by solution, filtration, and crystallisation, may be used instead of it. But as it is rare to meet with any of the sort that is not a little tainted with iron, the white bay salt is to be preferred. The glass basin he sets in a gentle sand-heat, and keeps it there till the mixture be reduced by evaporation to an almost dry saline mass.

"If you desire to save the *aqua regis*, the impregnation must be put into a retort, and distilled with the gentle heat of a sand-bath. But there is an inconvenience, as Mr Hellot observes, in employing a retort; which is, that, as the saline mass cannot be stirred while it coagulates in the retort, it is reduced to a compact cake of coloured salt, which presents but one single surface to the water in which it must be dissolved; so that the dissolution thereof takes up sometimes no less than five or six days. In the basin, on the contrary, the saline mass is easily brought to a granulated salt, by stirring it with a glass rod; and, when thus granulated, it has a great deal more surface; it dissolves more easily, and yields its tincture to water in four hours time. Indeed one is more exposed to the vapours of the solvent, which would be dangerous, if the operation were to be often performed, without proper precautions.

"When the basin, or little vessel containing the mixture of the impregnation and sea-salt, is heated, the liquor, which was of an orange-coloured red, becomes a crimson red; and, when all the phlegm of the solvent is evaporated, it acquires a beautiful emerald colour. By degrees it thickens, and turns of the colour of a mass of verdegris. It must then be carefully stirred with the glass rod, in order to granulate the salt, which must not be kept over the fire till it be perfectly dry: because you run a risk of losing irrecoverably the colour you are seeking. You may be sure you have lost it, if by too much heat the salt that was of a green colour turn to a dirty yellow. If it be once brought to this state, it will continue without changing when cold: but if care be taken to remove it from the fire while it is still green, you will see it gradually grow pale, and become of a beautiful rose-colour as it cools.

"Mr Hellot separates it from this vessel, and throws it into another containing distilled rain-water: and this second vessel he keeps in gentle digestion, till he observes that the powder which falls to the bottom is perfectly white. If, after three or four hours digesting, this powder still continues tinged with a rose colour, it is a proof that water enough was not added to dissolve all the salt.



salt impregnated with the tincture of the solution. In this case, the first tinged liquor must be poured off, and fresh water added in proportion to the quantity of tinged salt that is supposed to remain mixed with the precipitate.

“ When the ore is pure, and doth not contain a great deal of fusible stone, commonly called *flus*, or *quartz*, an ounce of it generally yields tincture enough for eight or nine ounces of water, and the liquor is of a beautiful colour, like that of the lilach or pipe-tree blossom. In order to prove the effect of this tincture, you must write with this lilach-coloured liquor on good well-gummed paper, that does not sink : or you may use it to shade the leaves of some tree or plant, having first drawn the outlines thereof lightly with China ink or with a black lead pencil. Let this coloured drawing, or writing, dry in a warm air. You will perceive no colour while it is cold; but, if it be gently warmed before the fire, you will see the writing, or the drawing, gradually acquire a blue or greenish blue colour, which is visible as long as the paper continues a little warm, and disappears entirely when it cools.”

The singularity of this sympathetic ink consists in its property of disappearing entirely, and becoming invisible, though it be not touched with any thing whatever : and this distinguishes it from all others ; which, when once rendered visible by the application of proper means, do not again disappear, or at least not without touching the strokes on the paper with some other liquor.

### Of Z I N C.

*To extract Zinc from its Ore, or from Calamine.*

TAKE eight parts of calamine reduced to a powder ; mix this powder accurately with one part of fine charcoal dust, previously calcined in a crucible to free it from all moisture : put this mixture into a stone retort coated with lute, leaving a third part of it empty : set your retort in a reverberatory furnace, capable of giving a very fierce heat. To the retort apply a receiver, with a little water in it. Kindle the fire, and raise it by degrees till the heat be strong enough to melt copper. With this degree of fire the zinc being metallised will separate from the mixture, and sublime into the neck of the retort, in the form of metallic drops. Break the retort when it is cold, and collect the zinc.

Most of the zinc we have comes from an ore of difficult fusion that is worked at Goslar, and yields, at one and the same time, lead, zinc, and another metallic matter called *cadmia fornacum*, which also contains much zinc.

The furnace used for smelting this ore is closed on its fore-side with thin plates or tables of stone, not above an inch thick. This stone is greyish, and bears a violent fire.

In this furnace the ore is melted amidst charcoal, by the help of bellows. Each melting takes twelve hours, during which time the zinc flowing with the lead is resolved into flowers and vapours, great part of which adheres to the sides of the furnace in the form of a very

hard crust of earth. The workmen take care to remove this crust from time to time ; for it would otherwise grow so thick at last, as to lessen the cavity of the furnace very considerably.

There adheres moreover to the fore-part of the furnace, which is formed, as we said before, of thin plates of stone, a metallic matter, which is the zinc, and is carefully collected at the end of each melting, by removing from this part all the live coals. A quantity of small-coal is laid unlighted at the bottom ; and on this small-coal, by striking the stone-plates gently with a hammer, the zinc is made to fall out of the other matter, known by the Latin name of *cadmia fornacum*, among which it appears fixed in a radiated form. To this other matter we may properly enough give the name of *furnace-calamine*. The zinc falls in the form of a melted metal, all on fire, and in a bright flame. It would soon be entirely burnt and reduced to flowers, if it were not extinguished, and easily cooled and fixed, by being hid under the unlighted small-coal placed below on purpose to receive it.

The zinc adheres to the fore-part of the furnace preferably to any other, because that being the thinnest, is therefore the coolest : and, in order further to promote its fixing on this part, they take care to keep the thin stone-plates cool during the operation, by throwing water on them.

Hence it appears that zinc is not extracted from its ore by fusion and the precipitation of a regulus, like other metallic substances. This is owing to the great volatility of our semi-metal, which cannot, without subliming, bear the degree of fire necessary to melt its ore. It is at the same time so combustible, that a great part of it rises in flowers which have not the metalline form.

*To sublime Zinc into Flowers.*

TAKE a very deep, large crucible : place this crucible in a furnace, so that it may stand inclining in an angle of forty-five degrees nearly. Throw some zinc into it, and kindle a fire in the furnace somewhat stronger than would be necessary to keep lead in fusion. The zinc will melt. Stir it with an iron wire, and there will appear on its surface a very bright white flame : two inches above this flame a thick smoke will be formed, and with this smoke exceeding white flowers will rise, and remain some time adhering to the sides of the crucible, in the form of a very fine light down. When the flame slackens, stir your melted matter again with the iron wire : you will see the flame renewed, and the flowers begin again to appear in greater abundance. Go on thus till you observe that the matter will not flame, nor any more flowers rise.

*To combine Zinc with Copper. Bras. Prince's Metal, &c.*

POUND one part and an half of calamine, and an equal quantity of charcoal : mingle these two powders together, and moisten them with a little water. Put this mixture into a large crucible, or some other earthen vessel that will bear a melting heat. Amongst and over this mixture put one part of very pure copper in thin plates, and then put fresh charcoal-dust over all : close the

the crucible; set it in a melting furnace; put coals all round it, and let them kindle gradually. Raise the fire so as to make the crucible very red hot. When you observe that the flame hath acquired a purple or bluish-green colour, uncover the crucible, and dip into it an iron wire, to examine whether or no the copper be in fusion under the charcoal dust. If you find it is, moderate the force of the fire a little, and let your crucible remain in the furnace for a few minutes. Then take it out and let it cool: you will find your copper of a gold colour, increased in weight a fourth, or perhaps a third part, and yet very malleable.

The *lapis calaminaris* is not the only substance with which copper may be converted into brass: all other ores containing zinc, the furnace-calamine that sublimes where such ores are worked, tutty, zinc in substance, may be substituted for it, and, like it, will make very fine brass; but, in order to succeed, sundry precautions are necessary.

This process is a sort of cementation; for the calamine doth not melt; only the zinc is converted into vapours, and then combines with the copper. On this the success of the operation partly depends, as it is the means of the copper's preserving its purity and malleability; because the other metallic substances that may be united with the ore of zinc, or with the zinc itself, not having the same volatility, cannot be reduced to vapours. If you are apprised that the calamine, or other ore of zinc used on this occasion, is contaminated with a mixture of any other metallic matter, you must mingle luting earth with the charcoal-dust and the matter containing the zinc; make it into a stiff paste with water; of this make a bed at the bottom of your crucible, and ram it hard down; lay the copper-plates thereon, cover them with charcoal-dust, and then proceed as before. By this means, when the copper melts, it cannot fall to the bottom of the crucible, nor mix with the ore; but is borne up by the mixture, and cannot combine with any thing but the zinc, that rises in vapours, and, passing through the lute, fixes in the copper.

*Lapis Calaminaris*, or other ore of zinc, may be also purified before it be used for making brass; especially if adulterated with lead ore, which is often the case. For this purpose the ore must be roasted in a fire strong enough to give a small degree of fusion to the leaden matter; which will thereby be reduced into larger, heavier, and tougher masses. The most subtile particles are dissipated in the torrefaction, together with some of the calamine. The calamine, on the contrary, is by roasting made more tender, lighter, and much more friable. When it is in this condition, put it into a washing tray or fan; dip the tray in a vessel full of water, and bruise the matter it contains. The water will carry off the lightest powder, which is the calamine, and leave nothing at the bottom of the tray but the heaviest substance; that is, the leaden matter, which is to be rejected as useless. The powder of the calamine will settle at the bottom of the vessel, where, after pouring off the water, it may be found, and used as above directed.

In this operation the charcoal-dust serves to prevent both the copper and the zinc from being calcined: and

for this reason, when you work on a great quantity of materials at once, it is not necessary to use so much charcoal dust, in proportion, as when you work but on a small quantity; because, the greater the mass of metal, the less easily will it calcine.

Though the copper melts in this operation, yet it is far from being necessary to apply such a strong fire as copper usually requires to melt it: for the accession of the zinc, on this occasion, communicates to it a great degree of fusibility. The increase of its weight is also owing to the quantity of zinc combined with it. Copper acquires still another advantage by its association with this semi-metal; for it remains longer in the fire without calcining.

Brass well prepared ought to be malleable when cold. But in whatever manner it be made, and whatever proportion of zinc there be in it, it is constantly found quite unmalleable when red-hot.

Brass melted in a crucible, with a fierce heat, takes fire almost like zinc, and from its surface many white flowers ascend, dancing about in flakes like the flowers of zinc. They are indeed the flowers of zinc, and the flame of brass urged by a strong fire is no other than the flame of the zinc that is united with the copper, and then burns. If brass be thus kept long in fusion, it will lose almost all the zinc it contains. It will also lose much of its weight, and its colour will be nearly that of copper. It is therefore necessary, towards performing this operation aright, to seize the moment when the copper is sufficiently impregnated with zinc, when it hath acquired the most weight and the finest colour, with the least detriment to its ductility, that is possible, and that instant to put out the fire; because, if the copper be left longer in fusion, it will only lose the zinc already united with it. Skill acquired by much practice, and an acquaintance with the particular calamine employed, are necessary to guide the artist surely through this operation; for there are very considerable differences between the sundry ores of zinc. Some of them contain lead, and in others there is iron. When these heterogeneous metals come to be mixed with the copper, they do indeed augment its weight, but they render it at the same time pale, and make it very harsh. Some calamines require to be roasted before they can be used for this purpose, and in the torrefaction emit vapours of a volatile alkali, succeeded by vapours of a sulphureous spirit: others exhale no vapours while roasting, and may be employed without any antecedent preparation. These different qualities must evidently produce great differences in the operation.

Brass may also be made, as prince's metal and other imitations of gold are actually made, by using zinc in substance, instead of the ores that contain it. But these compositions have not, when cold, the ductility of brass prepared with *lapis calaminaris*, because zinc is seldom pure, or free from a mixture of lead. Perhaps also the different manner in which the zinc unites with the copper may contribute to this variation.

To obviate this inconvenience, the zinc must be refined from all alloy of lead. The property of being indissoluble by sulphur, which this semi-metal possesses, points  
out

out a very practicable method of doing it. The zinc must be melted in a crucible, and stirred briskly with a strong iron wire, while tallow and mineral sulphur are alternately projected upon it; but so that the quantity of sulphur may greatly exceed that of the tallow. If the sulphur do not burn entirely away, but form a kind of scoria on the surface of the zinc, it is a sign that your semi-metal contains lead. In this case you must continue throwing in more sulphur, and keep stirring the zinc incessantly, till you perceive that the sulphur ceases to unite any more with a metallic substance, but burns freely on the surface of the zinc. The semi-metal is then refined; because the sulphur, which cannot dissolve it, unites very readily with the lead, or other metallic substance, contained in it.

If zinc thus refined be mixed with pure copper, in the proportion of a fourth or a third part, and the mixture be kept in fusion and constantly stirring for some time, the brass produced will be as ductile, when cold, as that made by cementation with the *lapis calaminaris*.

With regard to prince's metal, and other imitations of gold, they are made either with copper or brass recombined with more zinc. As it is necessary, for giving them a fine golden colour, to mix with them other proportions of zinc than that required to make brass only, they are generally much less ductile.

#### *Zinc dissolved in the Mineral Acids.*

WEAKEN concentrated oil of vitriol by mixing with it an equal quantity of water. Into a matras put the zinc you intend to dissolve, first broken to small pieces. Pour on it six times its weight of the vitriolic acid, lowered as above directed, and set the matras in a sand-bath gently heated. The zinc will dissolve entirely, without any sediment. The neutral metallic salt resulting from this dissolution shoots into crystals, which go by the name of *white vitriol*, or *vitriol of zinc*.

Zinc is dissolved by the nitrous and marine acids, much in the same manner as by the vitriolic; except that the marine acid does not touch a black, spongy, rarefied matter, which it separates from the zinc. M. Hellot found upon trial that this matter is not mercury, and that it cannot be reduced to a metallic substance.

A solution of zinc in the marine acid, being distilled to dryness, yields a sublimate on applying a violent heat to it.

All the acids dissolve with ease; not only zinc, but its flowers also; and that nearly in the same quantity, and with almost all the same phenomena.

#### Of ARSENIC.

*To extract Arsenic from its Matrices. Zaffre or Smalt.*

POWDER some cobalt, white pyrites, or other arsenical matters. Put this powder into a retort with a short wide neck, leaving a full third thereof empty. Set your retort in a reverberating furnace; lute on a receiver; heat your vessel by degrees, and increase the fire till you see a powder sublime into the neck of the retort. Keep up the fire in this degree as long as the sublimation continues: when this begins to slacken, raise your fire,

and make it as strong as the vessels will bear. When nothing more ascends, let it go out. On unluting the vessels, you will find in the receiver a little arsenic in the form of a fine light *farina*. The neck of the retort will be full of white flowers, not quite so fine, some of which will appear like little crystals; and if a good deal of arsenic be sublimed, a ponderous matter, like a white, semi-transparent glass, will be found adhering to that part of the neck of the retort which is next its body.

When all the arsenic the cobalt will yield is thus separated, the earthy fixed matter left behind is mixed with divers fusible matters and vitrified, and produces a glass of beautiful blue colour. It is called *smalt*. This glass is to be prepared in the following manner.

Take four parts of fine fusible sand, an equal quantity of any fixed alkali perfectly depurated, and one part of cobalt from which the arsenic hath been sublimed by torrefaction. Pulverise these different substances very finely, and mix them thoroughly together; put the mixture into a good crucible, cover it, and set it in a melting furnace. Make a strong fire, and keep it up constantly in the same degree for some hours. Then dip an iron wire into the crucible; to the end of which a glassy matter will stick, in the form of threads, if the fusion and vitrification be perfect. In this case take the crucible out of the fire; cool it by throwing water on it, and then break it. You will find in it a glass, which will be of an exceeding deep blue, and almost black, if the operation hath succeeded. This glass, when reduced to a fine powder, acquires a much brighter and more lively blue colour.

If you find after the operation that the glass hath too little colour, the fusion must be repeated a second time, with twice or thrice the quantity of cobalt. If, on the contrary, the glass be too dark, less cobalt must be used.

In order to make the essay of a particular cobalt, with a view to know what quantity of blue glass it will yield, it is not necessary to perform the operation in the manner here set down; a great deal of time and trouble may be saved by melting one part of cobalt with two or three parts of borax. This salt is very fusible, and turns, when melted, into a substance which, for a time, possesses all the properties of glass. In this trial the glass of borax will be nearly of the same colour as the true glass, or smalt, made with the same cobalt.

The ores of bismuth, as well as cobalt, yield a matter that colours glass blue; nay, the smalt made with those ores is more beautiful than that procured from the ore of pure arsenic. Some cobalts yield both arsenic and bismuth. When such cobalts are used, it is common to find at the bottom of the crucible a little button of metallic matter, which is called *regulus of cobalt*. This regulus is a sort of bismuth, generally adulterated with a mixture of ferruginous and arsenical parts.

The heaviest and most fixed flowers of arsenic, procured from cobalt, have likewise the property of giving a blue colour to glass. But this colour is faint: it is owing to a portion of the colouring matter carried up along with the arsenic. These flowers may be made an ingredient in the composition of blue glass, not only because of the colouring principle they contain, but also because

they greatly promote fusion; arsenic being one of the most efficacious fluxes known.

In short, all those blue glasses, or smalts, contain a certain quantity of arsenic; for a portion of this semi-metal always remains united with the fixed matter of the cobalt, though roasted for a long time, and in a very hot fire. The portion of arsenic that is thus fixed vitrifies with the colouring matter, and enters into the composition of the smalt.

The blue glass made with the fixed part of cobalt hath several names, according to the condition in which it is.

When it hath undergone the first imperfect degree of fusion only, it is called *zaffre*. It takes the name of *smalt* when perfectly vitrified: and this again being pulverised is called *powder blue*; or, if finely levigated, *blue enamel*; because it is used in enamelling, as well as in painting earthen ware and porcelain.

*To separate Arsenic from Sulphur.*

**POWDER** the yellow or red arsenic which you intend to separate from its sulphur. Moisten this powder with a fixed alkali resolved into a liquor. Dry the mixture gently; put it into a very tall glass cucurbit, and fit on a blind-head. Set this cucurbit in a sand-bath; warm the vessels gently, and increase the fire by degrees, till you perceive that no more arsenic sublimes. The arsenic, which before was yellow and red, rises into the head partly on white flowers, and partly in a compact, white, semi-transparent matter, which looks as if it were vitrified. The sulphur combined with the fixed alkali remains at the bottom of the cucurbit.

*To give Arsenic the Metalline Form. Regulus of Arsenic.*

Take two parts of white arsenic in fine powder, one part of the black flux, half a part of borax, and as much clean iron filings. Rub the whole together, in order to mix them thoroughly. Put this mixture into a good crucible, and over it put sea salt three fingers thick. Cover the crucible; set it in a melting furnace; and begin with a gentle fire to heat the crucible equally.

When arsenical vapours begin to ascend from the crucible, raise the fire immediately so as to melt the mixture. Examine whether or no the matter be thoroughly melted, by introducing an iron wire into the crucible; and if the fusion be perfect, take the crucible out of the furnace. Let it cool; break it; and you will find in it a regulus of a white and livid metallic colour, very brittle, scarcely hard, but rather friable.

*To distil the Nitrous Acid by the Interposition of Arsenic. Blue Aqua Fortis.*

**PULVERISE** finely any quantity you please of refined salt-petre. Mix it accurately with an equal weight of white crystalline arsenic well pulverised, or else with very white and very fine flowers of arsenic. Put this mixture into a glass retort, leaving one half of it empty. Set your retort in a reverberating furnace; apply a receiver, having a small hole drilled in it, and containing a little

filtered rain-water; lute the receiver to the retort with stiff lute. Begin with putting two or three small live coals in the ash-hole of the furnace, and replace them with others when they are ready to go out. Go on thus warming your vessels by insensible degrees, and put no coals in the fire-place till the retort begin to be very warm. You will soon see the receiver filled with vapours of a dark red, inclining to a russet colour. With a bit of lute stop the little hole of the receiver. The vapours will be condensed in the water of this vessel, and give it a very fine blue colour, that will grow deeper and deeper as the distillation advances. If your salt-petre was not very dry, some drops of acid will also come over, and falling from the nose of the retort mix with the water in the receiver. Continue your distillation, increasing the fire little by little as it advances, but exceeding slowly, till you see that when the retort is red-hot nothing more comes off; and then let your vessels cool.

When the vessels are cold, unlute the receiver, and as expeditiously as you can pour the blue *aqua fortis* it contains into a crystal bottle; which you must seal hermetically, because this colour disappears in a short time when the liquor takes air. You will find in the retort a white saline mass moulded in its bottom, and some flowers of arsenic sublimed to its upper cavity, and into its neck.

Pulverise the saline mass, and dissolve it in warm water. Filter the solution, in order to separate some arsenical parts that will be left on the filter. Let the filtered liquor evaporate of itself in the open air; when it is sufficiently evaporated, crystals will shoot in it representing quadrangular prisms terminated at each extremity by pyramids that are also quadrangular. These crystals will be in confused heaps at the bottom of the vessel: Over them will be other crystals in the form of needles; a saline vegetation creeping along the sides of the vessel; and the surface of the liquor will be obscured by a thin dusty pellicle.

*To alkalisate Nitre by Arsenic.*

**MELT** in a crucible the nitre you intend to alkalisate. When it is melted, and moderately red, project upon it two or three pinches of pulverised arsenic. A considerable effervescence and ebullition will immediately be produced in the crucible, attended with a noise like that which nitre makes when it detonates with an inflammable matter. At the same time a thick smoke will rise, which at first will smell like garlick, the odour peculiar to arsenic; it will also smell afterwards like spirit of nitre. When the effervescence in the crucible is over, throw again upon the nitre as much pulverised arsenic as you did the first time; and all the same phenomena will be repeated. Continue thus throwing in arsenic in small parcels, till it produce no more effervescence; taking care to stir the matter at every projection with an iron wire, the better to mix the whole together. Then increase your fire, and melt what remains. Keep it thus in fusion for a quarter of an hour, and then take the crucible out of the fire. It will contain a nitre alkalisated by arsenic.

of

## Of VEGETABLES.

*Of the Substances obtained from Vegetables by Expression only.**To express and deplete the Juice of a Plant, containing its Essential Salt. The Crystallisation of that Salt.*

BEFORE sun-rise, gather a good quantity of the plant, from which you design to express the juice, in order to obtain its salt. Wash it well in running water, to clear it of earth, insects, and other adventitious matters. Bruise it in a marble mortar; put it into a bag of new, strong, thick linen cloth; tie the bag tight, and commit it to a press. By pressing it strongly you will squeeze out a great quantity of green, thick juice, which will have the same taste as the plant. Dilute this juice with six times as much pure rain water, and filter it repeatedly through a woollen bag, till it pass clear and limpid. Evaporate the filtered juice with a gentle heat, till it be almost as thick as before it was mixed with water. Put this inspissated juice into a jar, or other vessel of earth or glass; on its surface pour olive oil to the depth of a line, and set it in a cellar. Seven or eight months after this pour off gently the liquor contained in the vessel, the inside of which you will find covered with a crystallised salt. Separate the crystals gently; wash them quickly with a little fair cold water, and dry them: this is the essential oil of the plant.

Every plant is not equally disposed to yield its essential salt by the method here proposed. Succulent vegetables only, whose juices are aqueous and not too viscid, are fit for this purpose. Such, for example, as sorrel, brook-lime, succory, fumitory, water-creffes, plantain, &c. An essential salt cannot be procured from those that yield thick, viscid, mucilaginous juices, such as the seeds of flea-wort, unless their juices be previously attenuated by fermentation, and that viscosity destroyed which obstructs the crystallisation of this salt.

Nor can the essential salt be obtained in any quantity from vegetable matters abounding in oil. Most kernels and seeds are of this sort: they all contain a great quantity of fat oil, which so entangles and clogs this salt, that the particles thereof cannot shoot away from the tenacious juices into crystals.

The same is to be said of dry aromatic plants; because they contain much essential oil, or resinous matters that produce the same effect. It is true, the essential salt itself contains a certain portion of oil; for it is no other than the acid of the plant incorporated and crystallised with part of its oil and of its earth: but then the oil must not be in too great a quantity; because it sheaths the acid, renders it clammy, as it were, and hinders it from extricating itself so as to be able to exert its qualities, and appear in the form of salt.

The juice of plants obtained by expression is very thick; because it contains many particles of the bruised plant that are unavoidably squeezed out along with it. In order to clear it of these superfluous parts it is proper to filter it: but as that would be difficult, on account of the

thickness of the juice, it must be thinned, by diluting it with a quantity of water, sufficient to give it the requisite degree of fluidity.

Instead of thus diluting the expressed juice, the plant may be ground with water before it is put into the press: it will by this means furnish a more fluid juice, that will easily pass through the filter. This method may be employed with success on dry plants, or such as are not very succulent. For this operation rain-water is to be preferred to any other; because it is the purest.

The juice of the plant, when diluted with the quantity of water sufficient to facilitate its filtration, is too aqueous to let the salt it contains unite into crystals: It must therefore be evaporated till it hath recovered a somewhat thicker consistence. The heat applied for that purpose must be gentle; lest the acid and oily parts that are to form the salt, be spoiled or dissipated, as they are not very fixed.

The oil poured on the liquor prevents its fermenting, putrefying, or growing mouldy, during the long space of time required for the crystallisation of the essential salt.

These salts are excellent medicines, being endued with the same virtues as the plants from which they were obtained.

*To draw the Oils out of Kernels, Seeds, and Fruits, by Expression.*

POUND in a marble mortar, or grind in a mill, the kernels, seeds, or fruits, out of which you intend to express the oil. If your matters be meagre, and grind to meal, suspend that meal in the steam of boiling water, in order to moisten it a little, and then dry it.

Tie up your matters thus prepared in a new, strong, thick canvas bag, and put it into a press, between two iron plates previously heated in boiling water: squeeze it strongly, and you will see the oil run in streams into the receiving vessel.

*To draw the Essential Oil of certain Fruits by Expression.*

TAKE the rind of a citron, lemon, orange, Bergamot-pear, or other fruit of that kind; cut it in slices, and doubling the slices squeeze them between your fingers over against a polished glass set upright, with its lower end in a vessel of earth or porcelain. Every time you squeeze the peel in a new ply, there will squirt out of it several fine jets of liquor, which, meeting with the surface of the glass, will be condensed into drops, and trickle down in small streams into the recipient. This liquor is the essential oil of the fruit.

*Of the Substances obtained from Vegetables by Trituration.**To make the Extracts of a Plant by Trituration.*

BRUISE the vegetable substance of which you intend to make the extracts; or, if it be hard and dry, grind it to a powder: put the matter thus prepared, together with seven or eight times as much rain-water, into an earthen vessel; and into this vessel fit a churning staff, so that

hat it may be continually whirled round with a rotatory motion, by means of a cord, a wheel, and a winch. Ply this machine for ten or twelve hours; and then filter the liquor through two linen cloths spread on a hair-sieve. Let your filtered liquor stand quiet for twelve hours more: Then pour it off by inclination from the sediment you will find at bottom; and filter it a second time through a flannel bag.

Pour fresh water, but in a smaller quantity, on the mass left after trituration with the machine. Triturate it again for four or five hours. Treat the liquor of this second triture just as you did that of the first, and mix them both together. Distribute all the liquor you now have among a sufficient number of shallow earthen plates, and evaporate it by a gentle heat, such as that of the sun, or of a vapour-bath, to the consistence of an extract, or even to dryness, as you think proper.

*To extract from Seeds and Kernels, by Trituration, the Matter of Emulsions.*

**BLANCH** the kernels of which you desire to make an emulsion; put them into a marble mortar; add a very little water; and pound them with a wooden pestle. Continue pounding and triturating till the matter become like a white paste. From time to time pour on it, by little and little, more fair water warmed, still continuing the trituration; by which means the paste will grow thinner. Go on thus till every particle of your kernels be crushed to pap. Then add, still rubbing the mixture, enough of water to make the whole an actual fluid; and you will have a liquor of a dead-white colour, resembling milk. Strain it through a clean linen cloth: it will leave on the filter some coarse parts, which must be returned to those left in the mortar. Again triturate and rub the remainder of the kernels, with the addition of water as before. This second liquor will not be so white nor so rich as the former: filter it in the same manner, and again grind with water the solid parts remaining. In this manner proceed, repeatedly rubbing and adding fresh water, till it appear no longer milky, but come off clear. The white milky waters thus obtained go by the name of an *emulsion*.

All the matters, from which a fat oil is obtainable by expression, produce emulsions when triturated with water.

An emulsion consists chiefly of two substances. One of these is mucilaginous, and soluble in water. This substance by itself would not give a milky appearance to the emulsion, which, with it alone, would be limpid. The other is a fat oil, which of itself is not soluble in water; but being divided by the means of trituration into very small globules, it is dispersed through the whole liquor, and suspended therein by the aid of the mucilaginous part. It is this oily part that gives the emulsion its dead-white milky colour; because it is not actually dissolved in the water, but only diffused through it.

If oil be mixed with water in a phial, and the mixture strongly shaken for some time, with a rapid and continued motion, the oil will be divided into a vast number of little globules, which intervening between the parts of the water will destroy its transparency, and give it a dead-

white colour, like that of our emulsion. But, as the oil is not so minutely divided by this means as by triturating the matters containing it; and again, there being no mucilage in this liquor, as there is in emulsions, the oil soon separates from the water when it is left at rest, re-unites into round globules, and these joining together rise to the surface of the liquor, which then recovers its transparency.

The case is not exactly the same with emulsions; but something like it happens to them also. If they be left to stand quiet in a long bottle, the liquor, which at first appeared homogeneous, separates into two manifestly different parts. The upper part retains its dead-white colour, but is thicker and more opaque; while the lower part becomes perfectly transparent. This is the beginning of an entire separation of the oily from the aqueous parts. The former, being the lighter, ascend and gain the upper part of the liquor; while the lower, being freed from that which obstructed its translucence, recovers its proper limpidity: but the oily parts do not re-unite into masses large enough to form one homogeneous whole, with the appearance and limpidness of oil; their being minutely divided and entangled in the mucilage impeding their natural tendency.

Emulsions first begin to spoil, as they grow old, not by turning rancid and acrimonious like the fat oils drawn by expression, but by turning sour; which is owing to the great quantity of mucilage they contain. As there is a fat oil in their composition, they have the same virtues with that sort of oil: but they are moreover incrassating, cooling, and emollient; qualities which render them extremely useful in acute and inflammatory disorders. They grow sour in a very short time, especially in the heat of summer; nay, they sometimes do so in two hours: and therefore they ought to be prepared from time to time as they are to be used.

The matter that is left when all the substance of the emulsion is extracted, and from which the water comes off clear and limpid, is scarce any thing but the earthy part of the seed or kernel that was triturated; which, however, still retains a portion of tenacious and gross oil, adhering to it so firmly as not to be separable by water.

The chyle and milk of animals resemble an emulsion in several respects, and particularly in their dead-white colour; which arises, in the same manner, from the very minute particles of oil contained in them, and distributed through an aqueous gelatinous fluid, but not dissolved therein. In general, whenever any oil of any kind happens to be lodged in this manner between the parts of an aqueous liquor, it always makes the whole of an opaque white: for oil will not mix with water, so as to produce a liquor that shall appear homogeneous and transparent, unless it be intimately dissolved in the water; which cannot be effected but by means of an union previously contracted between it and some saline matter; as is the case of mucilages, certain saponaceous matters, and some other combinations of which we shall have occasion to treat in the sequel.

The methods we have hitherto proposed, for extracting from vegetable substances all that they will yield without

without the assistance of fire, are not capable of analysing those substances accurately; since by expression and trituration we obtain only the liquid parts, impregnated indeed with almost all the principles of plants, which however are still combined with each other, and barely separated from the grossest earthy and oily parts. We must therefore necessarily have recourse to a more effectual expedient for carrying our analysis further. This expedient consists in making them undergo the action of fire, successively graduated, from the gentlest to the most violent heat.

But, before we enter on this analysis of vegetables, it is proper to describe the different operations that may be performed on oils, the only pure principle we have been able to obtain without the help of fire.

### *Of Operations on Fat Oils.*

*To attenuate Fat Oils, and change their Nature, by exposing them to the Action of Fire, and distilling them.*

Mix thoroughly three or four pounds of any fat oil whatever with twice its weight of lime slaked in the air. Put this mixture into a large earthen retort, leaving a third part of it empty. Set it in a reverberating furnace, and lute on a receiver. Heat the vessel with a very gentle fire. A little flame will rise first, and will soon be followed by an oil that will fall in drops from the nose of the retort. Continue the distillation very slowly, till you perceive the oil that comes over begin to be not quite so fluid as before, but rather a little thicker.

Then unlute your receiver, and put another in its place. Continue the distillation, increasing your fire by degrees. The oil that comes over will grow thicker and thicker, its fluidity will decrease, and it will acquire a dark-brown colour, which at last will become blackish. The oil will then be very thick. Push the operation till nothing more will come off, though the retort be red-hot. During the whole time this distillation lasts, there rises a good deal of water in company with the oil. Keep the second thick oil by itself.

Mix the oil that came over first in this operation with an equal part of fresh lime slaked in the air. Put the mixture into an earthen or glass retort, of a size so proportioned to the quantity, that a third part thereof may remain empty. Distill as before. The same phenomena will appear: a clear oil will first come over, and be succeeded by one a little thicker. Then shift your receiver, and distill off all the rest of the oil with an increased fire. The first oil obtained by this second distillation, will be clearer and thinner than that of the first distillation; and the second oil will not be so thick nor of so deep a colour as before.

Distill over again in the same manner the thin oil of this second distillation, and go on thus repeatedly distilling, till the first clear oil come over with a degree of heat not exceeding that of boiling water. Then, instead of mixing your oil with lime, put it with some water into a glass retort, or into a body with its head fitted on, and distill it, keeping the water just in a simmer. Your

oil will be more and more attenuated, and, after being thus distilled twice or thrice with water, will be so limpid, so thin, and so clear, that you will scarce be able to distinguish it from water itself.

### *To combine Fat Oils with Acids.*

Put any fat oil whatever into a glass basin, and set it in a sand-bath very moderately heated. Pour on this oil an equal quantity of concentrated oil of vitriol, which will immediately dissolve it with violence; a considerable ebullition and effervescence will arise, attended with great heat, and a prodigious quantity of black thick vapours, in which may be easily perceived the smell of burnt oil, together with that of a sulphureous acid. The mixture will become of a deep-red, black, and thick. Stir it with a small stick, till you observe that all is quiet.

### *To combine Fat Oils with Fixed Alkalis. Hard and Soft Soap. The Decomposition of Soap.*

TAKE a lixivium of Alicant kelp made more caustic by lime, as we shall shew when we come to speak of alkalis. Evaporate this lye till it be capable of bearing a new-laid egg. Divide it into two parts; and to one of these put just water enough to weaken it so that a new laid egg will not swim in it, but fall to the bottom. With the lye thus weakened, mix an equal quantity of fresh-drawn olive oil. Stir and agitate the mixture well till it become very white. Set it over a gentle fire, and continue stirring it incessantly, that the two ingredients of which it is compounded may gradually combine together, as part of the water evaporates. When you perceive they begin to unite, pour into the mixture thrice as much of the first strong lye as you took of olive oil. Continue the coction with a gentle fire, always stirring the matter, till it become so thick that a drop of it fixes, as it cools, into the consistence that soap ought to have. By dissolving a little of this soap in water, you will discover whether or no it contains more oil than ought to be in the composition. If it dissolve therein wholly and perfectly, without the appearance of the least little drop of oil floating on the water, it is a sign that it doth not contain too much oil. If, on the contrary, you perceive any of these little globules, you must pour into the vessel containing your matter a little more of the strong lye, to absorb the redundant oil. If there be too much of the alkali, it may be discovered by the taste. If the soap leave on your tongue the sensation of an alkaline salt, and produce an urinous savour, it is a sign that there is too much salt in proportion to the oil. In this case a little oil must be added to the mixture, to saturate the superabundant alkali. An excess in the quantity of alkali discovers itself likewise by the soap's growing moist in the air, on being exposed to it for some time.

Fixed alkalis, even when resolved into a liquor, that is, when loaded with much water, unite easily with fat oils, as appears from the experiment just recited, and require but a moderate heat to perfect that union. This combination may even be completely effected without the aid of fire, and by the heat of the sun only, provided sufficient time be allowed for that purpose. It only requires the mixture of the oil and alkali to be kept five or six

six days in digestion, and stirred from time to time. A lixivium of pure alkali, not acuated by lime, may also be used to make soap: but it is observed, that the combination succeeds better, and that the alkali unites sooner and more perfectly with the oil, when it is sharpened by lime.

The oil is first mixed with a weaker and more aqueous lye, to the end that the combination may not take place too hastily, but that all the particles of the two substances to be compounded together may unite equally. But as soon as the alkali begins to dissolve the oil gradually and quietly, the dissolution may then be accelerated; and that is done by adding the remaining lye, which is stronger and less diluted than the other.

Soap made with olive oil is white, hard, and hath not a very disagreeable smell: but as that oil is dear, others, even the fat and oils of animals, are sometimes substituted for it. The soaps made with most of these other matters are neither so hard, nor so white, as that made of olive oil: they are called *soft soaps*.

Oils thus associated with fixed alkalis are by that means rendered soluble in water; because the alkaline salts, having a great affinity with water, communicate part thereof to the oils with which they are now incorporated. Yet the oil is not for all that rendered thoroughly miscible with water, or perfectly soluble therein; for the water in which soap is dissolved hath always a milky cast: now there is no other criterion of a perfect solution but transparency.

Alkalis also lose part of their affinity with water, by the union they thus contract with oils: for, when the combination is properly made, they no longer attract the moisture of the air, nor doth water dissolve them in such quantities as before. The composition of soap is plainly a saturation of an alkali with an oil; and, in order to make perfect soap, we are forced, as was said in the process, to grope, in a manner, by repeated trials, for this point of saturation; just as when we prepare a neutral salt by saturating an alkali with an acid. The union which the oil contracts with the alkali makes it lose, in part, the readiness with which it naturally takes fire; because the salt is not inflammable: the water also, which enters, in pretty considerable quantities, into the composition of soap, contributes a good deal to hinder the ascension of the oil.

Soap may be decomposed either by distilling it, or by mixing it with some substance that hath a greater affinity than oil with alkalis.

If we decompose it by distillation, a phlegm, or transparent spirit, of a somewhat yellowish colour, first comes over. This liquor is the aqueous part of the soap, quickened by a little of its alkali, which gives it an acid taste. It is followed by a red oil, which at first is pretty thin and limpid, but thickens as the distillation advances, grows black, and has a very disagreeable empyreumatic smell. This oil is soluble in spirit of wine.

When the distillation is finished, that is, when the retort being kept red-hot for some time will discharge no more, there is left in it a saline mass; which is the alkali of the soap, cruised over with some of the most fixed parts of the oil, that are charred to a coal. This salt

may be restored to the same degree of purity it had before its combination with the oil, by calcining it in a crucible with a naked fire, that may consume this burnt part of the oil, and reduce it to ashes.

It is plain, that the oil contained in soap is affected by distillation, much in the same manner as that which we mixed with lime and distilled.

Mr Geoffroy, by analysing soap with care, discovered that two ounces thereof contain ninety-six grains of salt of kelp, freed from all oil and moisture; or two drams and forty-eight grains of that salt, as it is used in manufacturing soap; that is, containing water enough to make it crystallise; one ounce three drams twenty grains of olive oil; and about two drams four grains of water.

As acids have a greater affinity than any other substance with alkalis, they may be very effectually employed to decompose soap.

If you propose to decompose soap by means thereof, you must first dissolve it in a sufficient quantity of water. Mr Geoffroy, who made this experiment likewise, dissolved two ounces thereof in about three gallons of warm water, and to the solution added oil of vitriol, which he let fall into it drop by drop. Every time a drop of acid falls into it, a *coagulum* is formed in the liquor. The vessel in which the solution is contained must then be shaken, that the acid may equally attack all the alkali diffused in it. When no new coagulation is produced by a drop of the acid, it is a sign you have added enough. The liquor then begins to grow clear: and if another quart of water be added, in order to facilitate the separation of the oily particles, you will see them rise and unite together on the surface of the liquor.

This is a pure, clear, true olive oil, hath its taste, its smell, and, like it, is fluid in warm weather, and becomes fixed by cold. Yet it differs in some respects from that which never hath been united with an alkali in order to form a soap; for it burns more vividly and more rapidly; and is soluble in spirit of wine. We shall account for these differences when we come to treat of ardent spirits.

Not only the vitriolic acid, but all others, even those obtained from vegetables, are capable of decomposing soap, and separating the oil from the alkali. In the liquor wherein soap is thus decomposed, is found a neutral salt, consisting of the acid made use of, united with the alkali of the soap. If the vitriolic acid be used, you will have a Glauber's salt; a quadrangular nitre, if the nitrous acid be used; and so of the rest.

The facility with which acids decompose soap is the reason that no water, but what is very pure, will dissolve it, or is fit to be used in washing with it.

Water that doth not dissolve soap well is usually called hard water. Such waters contain a certain quantity of saline matters, washed out of the earths through which they pass. The hardness of water is generally occasioned by selenitic particles.

The hardness of most well-waters is owing to a considerable quantity of selenitic gypsum with which the soil abounds. The selenites are neutral salts consisting of the vitriolic acid united with an earthy basis. If, therefore, soap be put into water in which a salt of this kind is dissolved,



solved, it is evident that the vitriolic acid in the selenites, having a greater affinity with the fixed alkali of the soap than with its own earthy basis, will quit the latter to unite with the former; and thus the soap will be decomposed instead of being dissolved. Accordingly we see, that, when we attempt to dissolve soap in our well-water, the surface of the liquor is in a short time covered with a fat oily pellicle. However, this decomposition of soap is not complete; at least but a small part of it is perfectly decomposed; because the great quantity of selenites, with which the water is impregnated, hinders the soap from mixing so thoroughly with it, as is requisite to produce a total decomposition thereof.

All mineral waters are likewise hard, with regard to soap; for, as most of them owe their virtues to the efflorescencies they have washed off, from pyrites that have grown hot and begun to be decomposed, they are impregnated with the saline matters produced by pyrites in that state; that is, with aluminous, vitriolic, and sulphureous substances, which have the same effect on soap as the selenites hath.

Mineral waters containing neutral salts only, such as sea-salt, Epsom salt, Glauber's salt, are nevertheless hard with regard to soap, though the acids of those salts, being united with fixed alkalis, are incapable of decomposing it. The reason is, that those neutral salts are more soluble in water than soap is; so much indeed as even to exclude it: because each of the two principles that compose them hath a very great affinity with water; whereas only one of the principles of soap, namely, its alkali, hath that affinity; the other, *viz.* the oily principle, having none at all. Thus water impregnated with an acid, or with any neutral salt, is hard with regard to soap, and incapable of dissolving it; and hence it follows, that soap is a sort of touchstone for trying the purity of water.

Wine dissolves soap; but imperfectly, because it contains an acid or tartarous part. Spirit of wine also dissolves it: but neither is this dissolution perfect; because it contains too little water: for its spirituous part can dissolve nothing but the oil of the soap; and the alkali is not at all, or at least in a very small quantity, soluble in this menstruum. The true solvent of soap is therefore a liquor that is partly spirituous, partly aqueous, and not acid.

Brandy has these qualities: and accordingly it is the solvent that unites best with soap, dissolves the greatest quantity, and makes the most limpid solution thereof. Yet even this solution hath something of a milky cast, occasioned by its not being entirely free from an acid, or the tartarous principle. This fault may be easily corrected, by mixing with it a little alkali to absorb the acid. A dram of crystallised salt of kelp mixed with three ounces and a half of good brandy, renders it capable of dissolving an ounce and two drams of good hard soap into a perfectly limpid liquor.

Some years ago it was discovered that soap might be used with great success in medicine, and that it possesses the property of dissolving the stony concretions that form in several parts of the body, particularly in the kidneys

and bladder. Soap is the basis of the composition known by the name of *Mrs Stephen's remedy*; and in this one ingredient its whole virtue resides.

From what hath been said on the nature of this compound, as well as on the cause and phenomena of its dissolution, it plainly appears to be of the last consequence, in administering it to a patient, that his constitution be considered, and a proper regimen ordered. All acids should be absolutely forbid him; as we know they hinder the soap from dissolving, and decompose it: and if the patient have any acidities in the first passages, matters capable of neutralising them should be prescribed him; as prepared crabs eyes, and other absorbents known in medicine: In such cases those with which the soap is compounded in *Mrs Stephen's remedy* may be of use.

#### *To combine Fat Oils with Sulphur.*

PUT any fat oil whatever into an earthen vessel; add to it about a fourth part of its weight of flower of sulphur, and set the vessel in a furnace, with lighted coals under it. When the oil hath acquired a certain degree of heat, the sulphur will melt, and you will see it fall immediately to the bottom of the oil, in the form of a very red fluid. The two substances will remain thus separated, without mixing together, while the heat is no greater than is necessary to keep the sulphur in fusion. Increase it therefore; but slowly, and with circumspection, lest the matter take fire. When the oil begins to smoke, the two liquors will begin to mix and look turbid: at last they will unite so as to appear one homogeneous whole. If you keep up the heat, so that the mixture shall always continue smoking and ready to boil, you may add more sulphur, which will perfectly incorporate with it: and thus may a pretty considerable quantity thereof be introduced into this composition.

#### *To combine Fat Oils with Lead, and the Calxes of Lead. The Basis of Plasters. The Decomposition of this Combination.*

INTO an earthen vessel put granulated lead, litharge, ceruse, or minium; and pour thereon twice its weight of any fat oil whatever. If you set the vessel over a brisk fire, the lead at bottom will melt before the oil begin to boil. When it boils, stir the matter with a stick: the lead, or the calx of lead, will gradually disappear, and at last be totally dissolved by the oil, to which it will give a very thick consistence.

Fat oils dissolve not only lead, but its calxes also: nay, they dissolve the latter more readily than lead in substance; probably because they are more divided. The result of a combination of these matters is a thick, tenacious mass, that grows in some degree hard in the cold, and soft by heat. This composition is known in pharmacy by the name of *plaster*. It is made up with several drugs into plasters, which partake of the virtues of those drugs; so that it is the basis of almost all plasters.

Lead itself is seldom used to make plasters: ceruse, litharge, or minium, are preferred to it; because these matters unite more readily with oils.

or

*Of the Substances obtained from Vegetables with a Degree of heat not exceeding that of boiling Water.*

*To obtain from Plants, by distilling them with the mean Degree of heat between freezing and boiling Water, a Liquor impregnated with their Principle of Odour.*

IN the morning, before sun-rise, gather the plant from which you design to extract its odoriferous water. Chuse the plant in its full vigour, perfectly sound, and free from all adventitious matters, except dew. Put this plant, without squeezing it, into the body of a tinned copper alembic, and set it in a water-bath. Fit on its head, and to the nose thereof lute a glass receiver with wet bladder.

Warm the bath to the mean degree between freezing and boiling water. You will see a liquor distill and fall drop by drop into the receiver. Continue the distillation with this degree of heat, till no more drops fall from the nose of the alembic. Then unlute the vessels; and if you have not as much liquor as you want, take out of the cucurbit the plant already distilled, and put a fresh one in its place. Distill as before, and go on thus till you have a sufficient quantity of odoriferous liquor. Put it into a bottle; stop it close; and set it in a cool place.

The liquor obtained from plants, with the degree of heat here prescribed, consists of the dew that was on the plant, and some of the phlegm of the plant itself, together with its odorous principle. Mr Boerhaave, who examined this odoriferous part of plants with great care, calls it the *spiritus r. flor.* The nature of this spirit is not yet thoroughly ascertained; because it is so very volatile, that it cannot easily be subjected to the experiments that are necessary to analyse it, and to discover all its properties. If the bottle containing the liquor, which may be considered as the vehicle of this spirit, be not exceeding carefully stopped, it flies quite off: so that in a few days nothing will be found but an insipid inodorous water.

Great part of the virtue of plants resides in this their principle of odour; and to it must be ascribed the most singular and the most wonderful effects we every day see produced by them. Every body knows that a great number of odorous plants affect, in a particular manner, by their scent only, the brain and the *genus nervosum*, of such especially whose nerves are very sensible, and susceptible of the slightest impression; such as hypochondriacal or melancholy men, and hysterical women. The smell of the tuberose, for instance, is capable of throwing such persons into fits, so as to make them drop down and swoon away. The smell of rue again, which is equally strong and penetrating, but of a different kind, is a specific remedy against the ill effects of the tuberose; and brings those persons to life again, with as quick and as surprising an efficacy as that by which they were reduced to a state not unlike death. This is Mr Boerhaave's observation.

The odorous exhalations of plants must be considered as a continual emanation of their *spiritus rector*: but as growing plants are in a condition to repair, every instant, the losses they sustain by this means, as well as by transpiration, it is not surprising that they are not soon exhausted while they continue in vigour. Those, on the contrary, which we distill, having no such resource, are very soon entirely exhausted of this principle.

The separation of the *spiritus rector* from plants requires but a very gentle heat, equally distant from the freezing point, and from the heat of boiling water. Accordingly the heat of the sun in summer is sufficient to dissipate it almost entirely. This shews why it is dangerous to stay long in fields, or woods, where many noxious plants grow. The virtues of plants residing chiefly in their exhalations, which the heat of the sun increases considerably, a sort of atmosphere is formed round them, and carried by the air and the wind to very great distances.

For the same reason the air of a country may be rendered salutary and medicinal, by the exhalations of wholesome plants growing therein. From the facility with which the odorous principle of plants evaporates, we learn what care ought to be taken in drying those intended for medical uses, so as to preserve their virtues. They must by no means be exposed to the sun, or laid in a warm place: a cool, dry place, into which the rays of the sun never penetrate, is the properest for drying plants with as little loss of their virtue as possible.

Though there is reason to believe that every vegetable matter hath a *spiritus rector*, seeing each hath its particular scent, yet this principle is not very perceptible in any but those which have a very manifest odour: and accordingly it is extracted chiefly from aromatic plants, or the most odoriferous parts of plants.

*To extract the Fat Oils of Plants by the Decoction in boiling Water. Cacao-Butter.*

POUND or bruise in a marble mortar your vegetable substances abounding with the fat oil which you intend to extract by decoction: tie them up in a linen cloth: put this packet into a pan, with seven or eight times as much water, and make the water boil. The oil will be separated by the ebullition, and float on the surface of the water. Skim it off carefully with a ladle, and continue boiling till no more oil appear.

The heat of boiling water is capable of separating the fat oils from vegetable matters that contain any: but this is to be effected by actual decoction only, and not by distillation; because these oils will not rise in an alembic with the heat of boiling water. We are therefore necessitated to collect them from the surface of the water, as above directed.

The water used in this coction generally becomes milky, like an emulsion. Nevertheless this way of obtaining the fat oils is not generally practised; because the heat, to which they are exposed in the operation, occasions their being less mild than they generally are: but it is an excellent method, and indeed the only one that can be employed, for extracting from particular vegetables certain concrete oily matters, in the form of butter or wax; which

which matters are no other than fat oils in a fixed state. The cacao yields, by this means, a very mild butter; and in the same manner is a wax obtained from a certain shrub in America.

*To extract the Essential Oils of Plants by distillation with the heat of boiling water. Distilled waters.*

Put into a cucurbit the plant from which you design to extract the essential oil. Add as much water as will fill two thirds of your vessel, and dissolve therein half an ounce of sea-salt for every quart of water you use. To this body fit on an alembic head, and to the nose thereof lute a receiver with sized paper or wet bladder. Set it in a furnace, and let the whole digest together, in a very gentle warmth, for twenty-four hours.

This being done, light a wood-fire under your vessel, brisk enough to make the water in it boil immediately. Then slacken your fire, and leave it just strong enough to keep the water simmering. There will come over into the receiver a liquor of a whitish colour, somewhat milky; on the surface of which, or at the bottom, will be found an oil, which is the essential oil of the vegetable you put into the cucurbit. Continue your distillation with the same degree of heat, till you perceive the liquor come off clear, and unaccompanied with an oil.

When the distillation is finished, unlute the receiver; and, if the essential oil be of that sort that is lighter than water, fill the vessel up to the top with water. On this occasion a long-necked matras should be used for a receiver; that the oil which floats on the water may collect together in its neck, and rise up to its mouth. Then in the neck of this vessel put the end of a thread of cotton twine, so that the depending part without the vessel may be longer than that in the oil, and the extremity thereof hang within the mouth of a little phial, just big enough to contain your quantity of oil. The oil will rise along the yarn as in a siphon filter through it, and fall drop by drop into the little phial. When all the oil is thus come over, stop your little bottle very close, with a cork coated over with a mixture of wax and a little pitch.

If your oil be ponderous and of the sort that sinks in water, pour the whole contents of the receiver into a glass funnel, the pipe of which must terminate in a very small aperture that may be stopped with your fore-finger. All the oil will be collected in the lower part of the funnel: then remove your finger, and let the oil run out into a little bottle through another small funnel. When you see the water ready to come, stop the pipe of the funnel, and cork the bottle containing your oil.

*To extract the Essential Oils of Plants by Distillation per descensum.*

Reduce to a powder, or a paste, the vegetable substances from which you intend to extract the essential oil by the method proposed. Lay this matter about half an inch thick on a fine, close, linen cloth. If it be dry and hard, expose the cloth containing it to the steam of boiling water, till the matter become moist and soft. Then lay the cloth, with its contents, over the mouth

of a very tall cylindrical glass vessel, which is to do the office of a receiver in this distillation; and, by means of a piece of small pack-thread, fasten down the extremities of the cloth, by winding the thread several times over them and round the vessel; in such a manner, however, that the cloth be not tight, but may yield to a small weight, and sink about five or six lines deep into the vessel over which it is fastened. Set this recipient in a larger vessel, containing so much cold water as will reach half way up the cylindrical vessel, which, having little in it but air, must be ballasted with as much lead as will sink it to the bottom of the water.

On the cloth, containing the substance to be distilled, set a flat pan of iron or copper, about five or six lines deep, that may just fit the mouth of the glass vessel over which the cloth is fastened, so as to shut it quite close. Fill this pan with hot ashes, and on these lay some live coals. Soon after this you will see vapours descend from the cloth, which will fill the recipient, and drops of liquor will be formed on the under side of the cloth, from whence they will fall into the vessel. Keep up an equal gentle heat, till you perceive nothing more discharged. Then uncover the recipient: you will find in it two distinct liquors; one of which is the phlegm, and the other the essential oil of the substance distilled.

*Infusions, Decoctions, and Extracts of Plants.*

MAKE some water boiling-hot, and then take it off the fire. When it ceases to boil, pour it on the plant of which you desire to have the infusion; taking care there be enough of it to cover the plant entirely. Cover the vessel, and let your plant lie in the hot water for the space of half an hour, or longer if it be of a firm close texture. Then pour off the water by inclination: it will have partly acquired the colour, the smell, the taste, and the virtues of the plant. This liquor is called an *infusion*.

To make the decoction of a vegetable substance, put it into an earthen pan, or into a tinned copper vessel, with a quantity of water sufficient to bear being boiled for several hours without leaving any part of the plant dry. Boil your plant more or less according to its nature; and then pour off the water by inclination. This water is impregnated with several of the principles of the plant.

If the infusions and decoctions of plants be filtered, and evaporated in a gentle heat, they become extracts, that may be kept for whole years, especially if they be evaporated to a thick consistence; and better still if they be evaporated to dryness.

*Of Operations on Essential Oils.*

*The Rectification of Essential Oils.*

Put into a cucurbit the essential oil you propose to rectify. Set the cucurbit in a *balneum marie*; fit to it a head of tin, or of copper tinned, together with its refrigeratory; and lute on a receiver. Make the water in the bath boil, and keep up this degree of heat till nothing more will come over. When the distillation is finished,

nished, you will find in the receiver a rectified essential oil, which will be clearer, thinner, and better scented than before it was thus before re-distilled; and in the bottom of the cucurbit will be left a matter of a deeper colour, more tenacious, more resinous, and of a less grateful smell.

Essential oils, even the purest, the best prepared, and the thinnest, suffer great changes, and are much impaired by growing old: they gradually turn thick and resinous; their sweet, grateful scent is lost, and succeeded by a more disagreeable smell, somewhat like that of turpentine. The cause of these changes is, that their finest and most volatile part, that which contains most of the odorous principle, is dissipated and separated from that which contains least of it; which therefore grows thicker, and comes so much the nearer to the nature of a resin, as the quantity of acid, that was distributed through the whole oil before the dissipation of the more volatile part, is, after such dissipation, united and concentrated in the heaviest part; the acid in oils being much less volatile than the odorous part, to which alone they owe their levity.

Hence it appears what precautions are to be used for preserving essential oils as long as possible without spoiling. They must be kept in a bottle perfectly well stopped, and always in a cool place, because heat quickly dissipates the volatile parts. Some authors direct the bottle to be kept under water.

*To fire Oils by combining them with highly concentrated Acids: instanced in Oil of Turpentine.*

Mix together in a glass equal parts of concentrated oil of vitriol, and highly smoking fresh-drawn spirit of nitre: pour this mixture at several times, but suddenly, on three parts of oil of turpentine, set for that purpose in a glass basin. By a part here must be understood a dram at least. A most violent commotion, accompanied with smoke, will immediately be raised in the liquors, and the whole will take fire in an instant, flame, and be consumed.

There is not in chemistry a phenomenon more extraordinary, and more surprising, than the firing of oils by mixing them with acids. It could never have been suspected, that a mixture of two cold liquors would produce a sudden, violent, bright, and lasting flame, like that we are at present considering.

*To combine Essential Oils with Mineral Sulphur.  
Balsam of Sulphur.*

Put into a matras one part of flowers of sulphur; pour on them six parts of the essential oil of turpentine, for instance; set the matras in a sand-bath, and heat it gradually till the oil boil. The sulphur, which at first lay at the bottom of the matras, will begin to melt, and appear to dissolve in the oil. When it hath boiled in this manner for about an hour, take the matras from the fire, and let the liquor cool. A great deal of the sulphur that was dissolved therein will separate from it as it cools, and fall to the bottom of the vessel in the form of needles, much like a salt shooting in water.

When the liquor is perfectly cold, decant it from the sulphur that lies at the bottom of the vessel: to that

sulphur put fresh oil of turpentine, and proceed as before: the sulphur will again disappear, and be dissolved in the oil; but when the mixture is cold you will find new crystals of sulphur deposited at the bottom. Decant once more this oil from the crystals, and pour on fresh oil to dissolve them: continue the same method, and you will find, that about sixteen parts of essential oil are required to keep one part of sulphur dissolved when cold. This combination is called *balsamum sulphuris terebinthinatum*, if made with oil of turpentine; *anisatum*, if with oil of anise-seeds; and so of others.

*To combine Essential Oils with fixed Alkalis.  
Starkey's Soap.*

Take salt of tartar, or any other alkali, thoroughly calcined. Heat it in a crucible till it be red, and in that condition throw it into a hot iron mortar: rub it quickly with a very hot iron pestle; and as soon as it is powdered, pour on it, little by little, nearly an equal quantity of oil of turpentine. The oil will enter into the salt, and unite intimately with it, so as to form a hard paste. Continue rubbing this composition with a pestle, in order to complete the union of the two substances; and, as your oil of turpentine disappears, add more, which will unite in the same manner, and give a softer consistence to the soapy mass. You may add still more oil, according to the consistence you intend to give your soap.

Starkey, the first chemist who found the means of making soap with an essential oil, and by whose name this kind of soap is therefore called, made use of a much more tedious method than that proposed in our process. He began with mixing a very small quantity of oil with his salt, and waited till all the oil united therewith of its own accord, so as to disappear entirely, before he added any more; and thus protracted his operation exceedingly, though in the main it was the same with ours. The method here proposed is more expeditious, and was invented by Dr Geoffroy.

Starkey's soap dissolves in water much as common soap does, without any separation of the oil: and by this mark it is known to be well made. It may also be decomposed, either by distillation, or by mixing it with an acid: and its decomposition, in either of these ways, is attended with nearly the same phenomena as the decomposition of common soap.

*Of the Substances obtained from Vegetables by means of a graduated Heat, from that of boiling Water, to the strongest that can be applied to them in close Vessels.*

*To analyse Vegetable Substances that yield neither a Fat nor an Essential Oil. Instanced in Guaiacum-wood.*

Take thin shavings of Guaiacum-wood, and put them into a glass or stone retort, leaving one half thereof empty. Set your retort in a reverberating furnace, and lute on a large glass receiver having a small hole drilled in it, such as is used for distilling the mineral acids. Put a  
live

live coal or two in the furnace, to warm the vessels gently and slowly.

With a degree of heat below that of boiling water, you will see drops of a clear intipid phlegm fall into the receiver. If you raise the fire a little, this water will come slightly acid, and begin to have a pungent smell. With a degree of fire somewhat stronger, a water will continue to rise which will be still more acid, smell stronger, and become yellowish. When the heat comes to exceed that of boiling water, the phlegm that rises will be very acid, high coloured, have a strong pungent smell, like that of matters long smoked with wood in a chimney, and will be accompanied with a red, light oil, that will float on the liquor in the receiver.

And now it is necessary, that the operation be carried on very cautiously, and vent frequently given to the rarefied air by opening the small hole in the receiver; such an incredible quantity thereof rushing out of the wood, with this degree of heat, as may burst the vessels to pieces, if not discharged from time to time.

When this red, light oil is come over, and the air ceases to rush out with impetuosity, raise your fire gradually, till the retort begin to redden. The receiver will be filled with dense vapours; and together with the watery liquor, which will then be extremely acid, there will rise a black, thick, ponderous oil, which will fall to the bottom of the receiver and lie under the liquor.

Then give the utmost degree of heat; that is, the greatest your furnace will allow, and your vessels bear. With this excessive heat a little more oil will rise, which will be very ponderous, as thick and black as pitch; and the vessels will continue full of vapours that will not condense.

At last, when you have kept the retort exceeding red for a long time in this extremity of heat, so that it begins to melt if it be of glass, and you perceive nothing more come over, let the fire go out and the vessel cool. Then take off your receiver: from the black oil at bottom decant the acid liquor with the red oil floating on it, and pour them both into a glass funnel, lined with brown filtering paper, and placed over a bottle. The acid liquor will pass through the filter into the bottle, and the oil will be left behind, which must be kept by itself in a separate bottle. Lastly, into another funnel, prepared as the former, pour the thick oil remaining with a little of the acid liquor at the bottom of the receiver. This liquor will filter off in the same manner, and thus be separated from the heavy oil.

In the retort you will find your Guaiacum shavings not in the least altered as to their figure, but light, friable, very black, scentless and tasteless, easily taking fire, and consuming without flame or smoke: in short you will find them charred to a perfect coal.

**HITHERTO** we have examined the substances that may be obtained from vegetables, either without the help of fire, or with a degree of heat not exceeding that of boiling water. The analysis of plants can be carried no further without a greater degree of heat: for, when the principle of odour and the essential oil of an aromatic

plant are wholly extracted by the preceding processes, if the distillation be afterward continued without increasing the heat, nothing more will be obtained but a little acid; which will soon cease, as a small part only of the quantity contained in the plant will be elevated; the rest being either too ponderous, or too much entangled with the other principles of the body, to rise with so small a degree of heat.

In order therefore to carry on the decomposition of a plant, from which you have, by the methods before proposed, extracted all the principles it is capable of yielding when so treated; or, in order to analyse a vegetable matter, which affords neither an expressed nor an essential oil, it must be distilled in a retort with a naked fire, as directed in the process, and be made to undergo all the degrees of heat successively, from that of boiling water to the highest that can be raised in a reverberating furnace.

A heat inferior to that of boiling water, with which we must begin in order to warm the vessel gradually, brings nothing over, but an insipid water, destitute of all acidity. By increasing it nearly to the degree of boiling water, the distilled water comes to be slightly acid.

When the heat is made a little stronger than that which is necessary for the elevation of an essential oil, the acidity of the water that comes off is much more considerable. It hath now both colour and smell, and there rises with it a red, light oil, that floats on the liquor in the receiver. This is not an essential oil; it hath none of the odour of the plant. Though so light as to float on water, yet it will not rise with the degree of heat that raises essential oils, even those that much surpass it in gravity, and will not swim on water as they do. This proves, that the ease or difficulty with which a particular degree of heat raises any substance in distillation doth not depend altogether on its gravity: its dilatibility, or the volatile nature of the matters with which it is so closely united as not to be separated from them by distillation, may probably contribute greatly to produce this effect.

It is very surprising, that a substance so hard, so compact, so dry in appearance, as Guaiacum-wood, should yield such a large quantity of water by distillation; and it is equally so, that it should discharge so much air, and with so much impetuosity, as nothing but experience could render credible.

It hath been remarked, that the heaviest and most compact woods yield the most air in distillation: and accordingly Guaiacum-wood, as exceeding almost all others in hardness and weight, discharges a vast quantity of air when analysed.

The thick, burnt, empyreumatic oil, that comes over last in this distillation, is heavier than water; on account, probably, of the great quantity of acid with which it is replete. The two kinds of oil obtained in this analysis may be rectified, by distilling them a second time, or rather several times; by which means they will become lighter and more fluid. In general, all thick, heavy oils constantly owe these qualities to an acid united with them; and it is by being freed from some of that acid in distillation, that they always acquire a greater

er degree of lightness and fluidity from that operation.

The analysis of a vegetable substance, shews what may be obtained from them when distilled in close vessels, with a graduated heat, from that of boiling water, to that which converts the mixt to a perfect coal; viz. phlegm, an acid, a light oil, much air, and a thick oil. But this analysis is far from being a complete one: it may be carried much farther, and made more perfect.

None of the principles obtained by this analysis are pure, simple, and thoroughly separated from the rest. They are still in some measure blended all together: their separation is but begun; and each requires a second and more accurate analysis, to reduce it to the greatest degree of purity of which it is capable. The oil and the acid chiefly merit so much pains.

A great deal of the acid of the plant remains, combined with the two sorts of oil here obtained; which we have reason to think differ no otherwise from one another; than as there is more or less acid united with each. The best way of freeing these oils from their redundant acid is to distill them frequently from alkalis and absorbents.

The acid is in the same circumstances nearly as the oil. The first that rises is mortified with much water, to which it owes a good deal of its volatility. That which comes over last is much more concentrated, and consequently heavier; yet it is still very aqueous. It might be freed in a great measure from this adventitious water, and so rendered much stronger; which would give us a better opportunity to discover its nature and properties, of which we know but very little.

Water is not the only heterogeneous substance that disguises the vegetable acid: a pretty considerable quantity of the oil of the plant is also combined with it, and contaminates its purity. The proof of this is, that when these acids are kept, in the same condition in which they first come over, for any length of time, in a glass vessel, they gradually deposit, on the bottom and sides of the vessel, an oily incrustation, which grows thicker and thicker the longer it stands; and, as this oily matter separates from it, the acid liquor appears less unctuous and saponaceous.

A very good way to separate this oil more effectually from the acid is to combine the whole with absorbents, and abstract the oil again by distillation. By this means a very sensible quantity of oil may be separated that was not perceived before.

The air, that is discharged with impetuosity in the operation, and must be let out, is loaded with many particles of acid and oil reduced to vapours, which it carries off; and by this means the quantity of the principles extracted from the mixt cannot be accurately determined: nor are the vapours, of which the vessels remain full after the operation, any other than particles of acid and oil, which the violence of the fire hath rarefied exceedingly, and which do not easily condense.

If we distill in this manner a vegetable aromatic substance, which of course contains an essential oil, provided it hath not been previously extracted by the appropriated process, this essential oil will rise first, as soon as the distilling vessel acquires the heat of boiling water: but its

scent will not be near so sweet or grateful, as if it were distilled in the manner before directed as properest for it. On the contrary, it will have an empyreumatic smell: because in this way it is impossible to avoid scorching, and half-burning some of the matter distilled; especially that part of it which touches the sides of the retort. Moreover, the very same equable degree of heat can hardly be kept up with a naked fire. The essential oil therefore, though it rises first, will not be pure, but contaminated with a mixture of the empyreumatic oil that first comes over, and will be confounded therewith.

Most vegetable substances, when distilled with a strong fire, yield the same principles with that which we have chosen for an instance. Entire plants of this kind, those from which the odorous principle; the essential oil, or the fat oil, hath been drawn, those of which extracts have been made by infusion or decoction, or the extracts themselves; all such matter being distilled yield a phlegm, an acid, a thin oil, air, and a thick oil; and the products of their several analyses differ from each other, only on account of the different quantity or proportion that each contains of the principles here enumerated.

But there are many other plants, which, besides these substances, yield also a considerable quantity of a volatile alkaline salt. This property is possessed chiefly by that tribe of plants which is distinguished by having cruciform flowers, among which there are some that, being analysed, greatly resemble animal-matters. We shall now analyse one of these; mustard-seed, for instance.

*To analyse a Vegetable Substance which yields the same Principles as are obtained from Animal-matters: instanced in Mustard-seed.*

WITH an apparatus like that of the preceding process, and with the same fire, distill mustard-seed. With a degree of heat, inferior to that of boiling water, there will come over a phlegm somewhat coloured, and impregnated with a volatile alkaline salt. With a degree of heat, greater than that of boiling water, the same kind of phlegm, impregnated with the same salt, will continue to come over; but it will be much higher coloured, and will be accompanied with a light oil. At this time a considerable quantity of air is discharged; with regard to which the same precautions must be taken as in distilling Guaiacum.

If the fire be gradually raised, there will come over a black thick oil. Lighter however than water; and at the same time vapours will rise, and, condensing on the sides of the receiver, form into springs or ramifications. This is a volatile alkaline salt, in a concrete form, like that of animals, as we shall hereafter see. These vapours are much whiter than those of Guaiacum.

When you have thus drawn off, with a very strong fire, all the volatile alkali and thick-oil contained in the subject, there will be nothing left in the retort but a sort of coal, from which a small quantity of phosphorus may be obtained, provided the retort you employ for that purpose be good enough to stand a very violent heat.

Mustard-seed furnishes us with an instance of a vegetable, from which we obtain, by analysing it, the very same principles that animal-matters yield. Instead

of

of getting an acid from it, we obtain only a volatile alkali.

We shall not here speak of the manner of separating and dehydrating the principles obtained by this process; but reserve it for the analysis of animals, which is absolutely the same. We shall content ourselves with observing, that the first volatile alkali, which rises at the beginning of the operation together with the phlegm, in a degree of heat below that of boiling water, differs from that which doth not come over till towards the end of the distillation, when the last thick oil ascends. The different times, and different degrees of heat, in which these two alkalis rise, shew that the former exists actually and perfectly in the plant; but that the latter is generated during the distillation, and is the product of the fire, which combines together the materials whereof it is composed.

Vegetables, that thus yield a volatile alkali with a heat less than that of boiling water, irritate the organ of smelling, affecting it with a sensation of acrimony; and the effluvia, which rise from them when bruised, make the eyes smart so as to draw tears from them in abundance. Several of these matters, being only bruised, effervesce with acids: effects producible only by a very volatile alkaline principle.

This is that alkali, the lightest of all the principles that can be extracted from bodies, which rises first in our distillation along with the phlegm, and with a degree of heat much inferior to that of boiling water. As the phlegm with which it rises is very copious, it is dissolved thereby; which is the reason it doth not appear in a concrete form. To this water it gives a slight yellowish tinge, because it is impure and oily. The saline alkaline properties of this liquor have procured it the title of a volatile spirit. This volatile alkali, which exists naturally and perfectly formed in mustard-seed, onions, garlick, cresses, and other such vegetables, constitutes a difference between them and animal substances, which contain only the materials requisite to form a volatile alkali, but none ready formed, unless they have undergone the putrid fermentation.

The second volatile alkali, which rises in our distillation, but not without a very strong degree of fire, and at the same time with the last thick oil, seems to be a production of the fire; for, if it were already formed in the mixt, as the other is, it would rise with the same heat, and at the same time, being equally volatile.

#### *Of the Substances obtained from Vegetables by Combustion.*

*To procure a fixed Caustic Alkaline Salt from a Vegetable Substance, by burning it in the open Air.*

TAKE any vegetable matter whatever; set it on fire, and let it burn in the open air till it be wholly reduced to ashes. On these ashes pour a quantity of boiling water sufficient to drench them thoroughly. Filter the liquor, in order to separate the earthy parts; and evaporate your lye to dryness, stirring it incessantly; and you will have a yellowish-white salt.

Put this salt in a crucible; set it in a melting furnace, and make a moderate fire, so as not to fuse the salt. It

will turn first of a blue-grey colour, afterwards of a blue-green, and at last reddish. Put on the dome of the furnace; fill it with coals; make your fire strong enough to melt the salt, and keep it in fusion for an hour, or an hour and half. Then pour it into a heated metal mortar; pound it while it is red-hot; put it as soon as possible into a glass bottle, first made very hot and dry, and shut it up close with a glass stopple rubbed with emery. By this means you will have the pure fixed alkali of the vegetable substance you burnt.

Burning a vegetable substance in the open air is a kind of violent and rapid analysis made by fire, which separates, resolves, and decomposes several of its principles.

When any wood or plant is laid on a quick fire, there ascends from it immediately an aqueous smoke, which consists of little more than phlegm; but this smoke soon becomes thicker and blacker; it is then pungent, draws tears from one's eyes, and excites a cough if drawn into the lungs with the breath. These effects arise from its being replete with the acid, and some of the oil, of the vegetable converted into vapours. Soon after this the smoke grows exceeding black and thick; it is now still more acrid, and the plant turns black. Its strongest acid and last thick oil are now discharged with impetuosity.

This rarefied oil being heated red-hot suddenly takes fire and flames. The vegetable burns and desagrates rapidly, till all its oil is consumed. Then the flame ceases; and nothing remains but a coal, like that found in a retort after all the principles of a plant have been extracted by the force of fire. But this coal having a free communication with the air, which is absolutely necessary to keep a combustible burning, continues to red, sparkles, and wastes till all its phlogiston is dissipated and destroyed. After this nothing remains but the earth and fixed salt of the vegetable; which, mixed together, form what we call the ashes. Water, which is the natural solvent of salts, takes up every thing of that kind that is contained in the ashes; so that by lixiviating them, as directed, all the salt is extracted, and nothing left but the pure earth of the mixt which is thus decomposed.

The phenomena observed in the burning of a vegetable substance, and the production thereby of a fixed alkali, seem to prove that this salt is the work of the fire; that it did not exist in the plant before it was burnt; that the plant only contained materials adapted to form this salt; and that this salt is no other than a combination of some of the acid, united with a portion of earth, by means of the igneous motion.

The alkali obtained from the ashes of burnt plants is not perfectly pure: it is contaminated with a small mixture of fatty matters, which were probably defended thereby against the action of the fire, and which render it somewhat saponaceous. In order to free it from this extraneous matter, and to render it very caustic, it must be calcined a long time in a crucible, but without melting it at first; because it is with this salt as with most metallic matters, which are sooner and more easily deprived of their phlogiston by being calcined without melting, provided they be comminuted into small particles, than when they are in fusion; all melted matters having but

a small surface exposed to the air, by the contact of which the evaporation of any thing whatever is exceedingly promoted.

*To procure the fixed Salt of a Plant, by burning it after the manner of Tachenius.*

INTO an iron pot put the plant whose salt you desire to obtain in the manner of Tachenius, and set it over a fire, strong enough to make its bottom red-hot; at the same time cover your plant with a plate of iron, that may lie immediately upon it in the pot. The plant will grow black, and smoke considerably; but will not flame, because it hath not a sufficient communication with the air. The black smoke only will escape through the interstice left between the side of the pot and the rim of the plate; which, for that purpose, should be made so as not to fit exactly into the pot. From time to time take up the iron plate, stir the plant, and cover it again immediately, to prevent its taking fire, or to smother it if it should happen to flame: go on thus till the black smoke cease.

Then take off the iron plate: the upper part of the half-burnt plant will take fire as soon as the air is admitted, consume gradually, and be reduced to a white ash. Stir your matter with an iron wire, that the undermost parts, which are still black, may be successively brought uppermost, take fire, and burn to white ashes.

Go on thus as long as you perceive the least blackness remaining. After this, leave your ashes some time longer on the fire; but stir them frequently, to the end that, if any black particles should still be left, they may be entirely consumed.

Your ashes being thus prepared, lixiviate them with seven times their quantity of water, made to simmer over the fire, and keep stirring it with an iron ladle. Then filter the liquor, and evaporate it to dryness in an iron pot, stirring it incessantly towards the end, lest the matter, when it grows stiff, should adhere too closely to the vessel. When all the humidity is evaporated, you will have a salt of a darkish colour and alkaline nature; which you may melt in a crucible, and mould into cakes. This is the fixed salt of plants, prepared in the manner of Tachenius.

*To render Fixed Alkalis very caustic by means of Lime. The Caustic Stone.*

TAKE a lump of newly burnt quick-lime, that hath not yet begun to slake in the air: put it into a stone pan, and cover it with twice its weight of the unwashed ashes of some plant that are full of the salt you design to render caustic. Pour on them a great quantity of hot water; let them steep in it five or six hours, and then boil them gently. Filter the liquor through a thick canvas bag, or through brown filtering paper supported by a linen cloth.

Evaporate the filtered liquor in a copper basin set over the fire; and there will remain a salt, which must be put into a crucible set in the fire. It will melt, and boil for some time; after which it will be still, and look like an oil, or melted fat. When it comes to this condition, pour it out on a very hot copper plate, and cut it into

oblong tapering slips, before it grow hard by cooling. Put these slips, while they are still hot, into a very dry glass bottle, and seal it hermetically. This is the *caustic Stone*, or *common caustic*.

*The Analysis of Soot.*

TAKE wood-soot from a chimney under which no animal matter hath been dressed or burnt: put it into a glass retort set in a reverberating furnace; lute on a receiver, and begin to distill with a degree of heat somewhat less than that of boiling water. A considerable quantity of limpid phlegm will come over. Keep the fire in the same degree as long as any of this phlegm rises, but increase it when the drops begin to come slow; and then there will ascend a good deal of a milky water. When this water ceases to run, change the receiver, and increase your fire a little: a yellow volatile salt will rise, and stick to the sides of the receiver. The fire ought now to be very fierce, and, if so, will force up at the same time a very thick black oil. Let the vessels cool: you will find a saline matter risen into the neck of the retort, which could not pass over into the receiver: in the bottom of the retort will be a *caput mortuum*, or black charred substance, the upper part of which will be cruised over with a saline matter, like that in the neck of the retort.

As we are at present inquiring into the nature of vegetables only, it is evidently necessary that we chuse a soot produced by burning vegetables alone. Soot, though dry in appearance, contains nevertheless much humidity, as appears from this analysis; seeing there comes over at first a considerable quantity of phlegm, that doth not seem to be impregnated with any principle, except perhaps an extremely subtile, saline, and oily matter, that communicates to it a disagreeable smell, from which it cannot by any means be entirely freed.

The volatile alkali obtained from soot is, in a double respect, the product of the fire. In the first place, though it derives its origin wholly from wood, or other vegetables, which, when distilled in close vessels, yield no volatile alkali at all, yet it produces such a salt when analysed in the present manner: whence it must be inferred, that the principles of those vegetables are metamorphosed into a volatile alkali, by being burnt in the open air, and sublimed in the form of soot. Secondly, though soot, when analysed, yields a great deal of this salt, yet this salt doth not formally pre-exist therein; for it doth not rise till after the phlegm, nor without a very considerable degree of heat: therefore soot contains only the materials necessary to form this salt; therefore the perfect combination of this salt requires that the force of fire be applied a second time; therefore it is, as was said, doubly the product of the fire.

The saline matter which we find sublimed into the neck of the retort, and which also forms the crust that covers the *caput mortuum* of the soot, appears by all chemical trials to be an ammoniacal salt; that is, a neutral salt, consisting of an acid and a volatile alkali. This ammoniacal salt rises only into the neck of the retort, and doth not come over into the receiver; because it is but semi-volatile. We shall treat more at large of the production



production of a volatile alkali, and of this ammoniacal salt, when we come to the analysis of animals, and the article of sal ammoniac.

*The Analysis of some particular Substances belonging to the Vegetable Kingdom.*

*Analysis of the natural Balsams: instanced in Turpentine.*

INTO a cucurbit put as much rain-water as will fill about a fourth part of its cavity, and pour into it the turpentine you intend to analyse. Cover the cucurbit with its head, and lute it on with slips of sized paper or wet bladder. Set your alembic in a sand-heat; lute on a long-necked receiver; and give a gradual fire till the water in the cucurbit boil. There will come over into the receiver a good deal of phlegm, which, by little and little, will become more and more acid; and at the same time there will rise a great quantity of an æthereal oil, extremely light, fluid, and as limpid and colourless as water.

When you observe that no more oil comes off, unlute your vessels; and in the receiver you will find an acidulated water, and the æthereal oil floating on it. These two liquors may be easily separated from each other, by means of a glass funnel.

In the cucurbit will be left some of the water you put in, together with the remainder of your turpentine; which, when cold, instead of being fluid, as it was before distillation, will be solid, and of the consistence of a resin, and is then called *rosin*.

Put this residuum into a glass retort, and distill it in a reverberatory with a naked fire, gradually increased according to the general rule for all distillations. At first, with a degree of heat a little greater than that of boiling water, you will see two liquors come over into the recipient; one of which will be aqueous and acid, the other will be a transparent, limpid, yellowish oil, floating on the acid liquor.

Continue your distillation, increasing your fire from time to time, by slow degrees. These two liquors will continue to come off together; and the nearer the operation draws to its end, the more acid will the aqueous liquor become, and the thicker and deeper coloured will the oil grow. At last the oil will be very thick, and of a deep reddish-yellow colour. When nothing more ascends, unlute your vessels: in the retort you will find only a very small quantity of a charred, light, friable substance.

All natural balsams, as well as turpentine, are oily, aromatic matters, which flow in great quantities from the trees containing them, either spontaneously, or thro' incisions made on purpose. As these matters have a strong scent, it is not surprising that they should greatly abound with essential oils. They may even be considered as essential oils, that naturally, and of their own accord, separate from the vegetables in which they exist.

Natural balsams, and essential oils grown thick with age, are exactly one and the same thing. Accordingly

we see that fire and distillation produce the same effects on both. The rectification of an essential oil, thickened by keeping, is nothing but a decomposition thereof, by separating, with the heat of boiling water, all those parts that are light enough to rise with that degree of heat, from what is so loaded with acid as to remain fixed therein.

The newer natural balsams are, the thinner they are, and the more essential oil do they yield; and this essential oil, like all others, grows thick in time, and at last turns again to an actual balsam.

These balsams, by being long exposed to the heat of the sun, acquire such a consistence as to become solid. They then take another name, and are called *resins*. Resins yield much less essential oil when distilled, than balsams do. Hence it follows, that resins are to balsams, what balsams are to essential oils.

*The Analysis of Resins: instanced in Benjamin. The Flowers and Oil of Benjamin.*

INTO a pretty deep earthen pot, having a border or rim round its mouth, put the benjamin you intend to analyse. Cover the pot with a large conical cap of very thick white paper, and tie it on under the rim. Set your pot in a sand-bath, and warm it gently till the benjamin melt. Continue the heat in this degree for an hour and half. Then untie the paper cap and take it off, shaking it as little as possible. You will find all the inside of the cap covered with a great quantity of beautiful, white, shining flowers, in the form of little needles. Brush them off gently with a feather, put them into a bottle, and stop it close.

As soon as you take off the first cap, cover your pot immediately with a second like the former. In this manner go on till you perceive the flowers begin to grow yellowish; and then it is proper to desist.

The matter left in the pot will be blackish and friable when cold. Pulverise it; mix it with sand; and distill it in a glass retort with a graduated heat. There will come over a light oil, of a fragrant scent, but in very small quantity; a little of an acid liquor, and a great quantity of a red thick oil. There will be left in the retort a charred, spongy substance.

*Of the Nature and Properties of Camphor.*

WE do not propose to give an analysis of this singular body; because hitherto there is no process known in chemistry by which it can be decomposed. We shall therefore content ourselves with reciting its principal properties, and making a few reflections on its nature.

Camphor is an oily concrete substance; a kind of resin, brought to us from the island of Borneo, but chiefly from Japan. This substance resembles resins, in being inflammable, and burning much as they do; it is not soluble in water, but dissolves entirely and perfectly in spirit of wine; it is easily separated again from this menstruum, as all other oily matters are, by the addition of water; it dissolves both in expressed and in distilled oils; it hath a very strong aromatic smell. These are the chief

chief properties which camphor possesses in common with resins: but in other respects it differs totally from them; especially in the following particulars.

Camphor takes fire and flames with vastly more ease than any other resin. It is so very volatile, that it vanishes entirely in the air, without any other heat than that of the atmosphere. In distillation it rises entire, without any decomposition, or even the least alteration. It dissolves in concentrated mineral acids; but with circumstances very different from those that attend other oily or resinous substances. The dissolution is accompanied with no effervescence, no sensible heat; and consequently can produce no inflammation. Acids do not burn, blacken, or thicken it, as they do other oily matters; on the contrary, it becomes fluid, and runs with them into a liquor that looks like oil.

Camphor doth not, like other oily matters, acquire a disposition to dissolve in water by the union it contracts with acids; though its union with them seems to be more intimate than that of many oily matters with the same acids. On the contrary, if a combination of camphor and an acid be diluted with water, these two substances instantly separate from each other: the acid unites with the water, and the camphor, being entirely disengaged from it, swims on the surface of the liquor. Neither volatile alkalis, nor the most caustic fixed alkalis, can be brought into union with it; for it always eludes their power.

Notwithstanding these wide differences between camphor and all other oily and resinous substances, the rule, that acids thicken oils, seems to be so universal, and so constantly observed by nature, that we cannot help thinking this substance, like all the rest, is an oil thickened by an acid. But what oil? what acid? and how are they united? This is a subject for very curious inquiries.

With a yellow oil drawn from wine, and an acid visuous spirit, Mr Hellot made a kind of artificial camphor; a substance having the odour, savour, and inflammability of camphor; an imperfect camphor. True camphor hath the levity, the volatility, and the inflammability of æther. Can it be a substance of the same nature with æther, a kind of solid æther, an æther in a concrete form?

*The Analysis of Bitumens: instanced in Amber. The Volatile Salt and Oil of Amber.*

INTO a glass retort put some small bits of amber, so as to fill but two thirds of the vessel. Set your retort in a furnace covered with its dome; sit on a large glass receiver; and beginning with a very gentle heat, distill with degrees of fire. Some phlegm will first come off, which will gradually grow more acid, and be succeeded by a volatile salt, figured like fine needles, that will stick to the sides of the receiver.

Keep the fire up to this degree, in order to drive over all the salt. When you perceive that little or none rises, change the receiver, and increase your fire a little. A light, clear, limpid oil will ascend. As the distillation advances, this oil will grow higher coloured, less

limpid, and thicker; till at last it will be opaque, black, and have the consistence of turpentine.

When you perceive that, though the retort be red-hot, nothing more comes off, let the fire go out. You will have in the retort a black, light, spongy coal. If you have taken care to shift the receiver, from time to time, during the distillation of your oil, you will have sundry separate portions thereof, each of which will have a different degree of tenuity or thickness, according as it came over at the beginning, or towards the end of the distillation.

THE substance of which we have here given the analysis, together with all others of the same, that is, of the bituminous kind, is, by most chemists and naturalists, classed with minerals: and so far they are right, that we actually get these mixts, like other minerals, out of the bowels of the earth, and never procure them immediately from any vegetable or animal compound. Yet we have our reasons for acting otherwise, and for thinking that we could not, in this work, place them better, than immediately after those vegetable substances which we call *resins*.

Several motives determine us to proceed in this manner. The analysis of bitumens demonstrates, that, with regard to the principles of which they consist, they are totally different from every other kind of mineral; and that, on the contrary, they greatly resemble vegetable resins in almost every respect. In short, though they are not immediately procured from vegetables, there is the greatest reason for believing that they were originally of the vegetable kingdom, and that they are no other than resinous and oily parts of trees or plants, which by lying long in the earth, and there contracting an union with the mineral acids, have acquired the qualities that distinguish them from resins.

Mineralogists know very well that we find, every where in the earth, many vegetable substances, that have lain very long buried under it, and frequently at a considerable depth. It is not uncommon to find, under ground, vast beds of fossil trees, which seem to be the remains of immense forests: and bitumens, particularly amber, are often found among this subterraneous wood.

These considerations, joined to proofs drawn from their analysis, make this opinion more than probable: nor are we singular in maintaining it, as it is adopted by many able modern chemists.

The analysis of amber, above described, may serve as a general specimen of the decomposition of other bitumens: with this single difference, that amber is the only one among them which yields the volatile salt aforesaid; and this determined us to examine it preferably to any other. As for the rest, they all yield a phlegm, an acid liquor, and an oil; which is thin at first, but grows thicker and thicker as the distillation draws towards an end. It must be understood, however, that these acids and these oils may differ, according to the nature of the bitumens from which they are drawn; just as the phlegm, the acid, and the oil, resulting from the decomposition of resins, differ in quantity and quality, according to the nature of the resins from which they are procured.

The

The principal differences observed between resins and bitumens are these: the latter are less soluble in spirit of wine; have a peculiar scent, which cannot be accurately described, and of which the sense of smelling only can judge; and their acid is stronger and more fixed. This last property is one of the motives which induce us to think, that besides the vegetable acid, originally combined with the resinous or oily matter now become a bitumen, a certain quantity of mineral acid hath, in a course of time, been superadded to constitute this mixt. We shall presently see that the fact is certainly so, in the case of amber at least.

*The Analysis of Bees-wax.*

MELT the wax you intend to analyse, and mix with it as much fine sand as will make it into a stiff paste. Put this paste in little bits into a retort, and distil as usual, with a graduated fire, beginning with a very gentle heat. An acid phlegm will come over, and be followed by a liquor which at first will look like an oil, but will soon congeal in the receiver, and have the appearance of a butter or grease. Continue the distillation, increasing the fire by insensible degrees, till nothing more will come off. Then separate the butter from the acid phlegm in the receiver, mix it with fresh sand, and distil it again just as you did the wax before. Some acid phlegm will still come off, and an oil will ascend, which will not fix in the receiver, though it be still thick. Continue the distillation, with a fire so governed that the drops may succeed each other at the distance of six or seven seconds of time. Do not increase it, till you perceive the drops fall more slowly; and then increase it no more than is necessary to make the drops follow each other as above directed. When the distillation is finished, you will find in the receiver the oil come wholly over, and a little acid phlegm. Separate the oil from this liquor; and, if you desire to have it more fluid, redistil it a third time in the same manner.

*The Saccharine Juices of Plants analysed: instanced in Honey.*

PUT into a stone cucurbit the honey you intend to distil; set it in a moderate sand-heat, and evaporate the greatest part of its humidity, till you perceive the phlegm to be acid. Then take out the matter remaining in the cucurbit, put it into a retort, leaving a full third thereof empty, and distil in a reverberatory with degrees of fire. An acid amber-coloured liquor will come over. As the operation advances, this liquor will continually become deeper coloured and more acid, and at the same time a little black oil will ascend. When the distillation is over, you will find in the retort a pretty large charred mass, which being burnt in the open air, and lixiviated, affords a fixed alkali.

Sugar, manna, and the saccharine juices of fruits and plants, are of the same nature as honey, yield the same principles, and in the same proportions. All these substances must be considered as native soaps; because they consist of an oil rendered miscible with water, by means of a saline substance. They differ from the common artificial soaps in several respects; but chiefly in this, that

their saline part is an acid, whereas that of common soap is an alkali. The natural soaps are not for that reason the less perfect: on the contrary, they dissolve in water without destroying its transparency, and without giving it a milky colour; which proves, that acids are not less proper than alkalies, or rather that they are more proper additaments, for bringing oils into a saponaceous state.

*Gummy Substances analysed: instanced in Gum Arabic.*

DISTIL gum arabic in a retort with degrees of fire. A limpid, scentless, and tasteless phlegm will first come over; and then a rusted coloured acid liquor, a little volatile alkali, and an oil, which will first be thin and afterwards grow thick. In the retort will be left a good deal of a charred substance, which, being burnt and lixiviated, will give a fixed alkali.

Gums have at first sight some resemblance of resins; which hath occasioned many resinous matters to be called gums, though very improperly: for they are two distinct sorts of substances, of natures absolutely different from each other. It hath been shewn, that resins have an aromatic odour; that they are indissoluble in water, and soluble in spirit of wine; that they are only an essential oil grown thick. Gums, on the contrary, have no odour, are soluble in water, indissoluble in spirit of wine, and, by being analysed as in the process, are converted almost wholly into a phlegm and an acid. The small portion of oil contained in them is so thoroughly united with their acid, that it dissolves perfectly in water, and the solution is clear and limpid. In this respect gums resemble honey, and the other vegetable juices analogous to it. They are all fluid originally; that is, when they begin to ooze out of their trees. At that time they perfectly resemble mucilages, or rather they are actual mucilages, which grow thick and hard in time by the evaporation of a great part of their moisture: just as resins are true oils, which, losing their most fluid parts by evaporation, at last become solid. Infusions or slight decoctions of mucilaginous plants, when evaporated to dryness, become actual gums.

Some trees abound both in oil and in mucilage: these two substances often mix and flow from the tree blended together. Thus they both grow dry and hard together in one mass, which of course is at the same time both gummy and resinous: and accordingly such mixts are named *gum resins*.

*Of Operations on FERMENTED VEGETABLE SUBSTANCES.*

*Of the Product of Spirituous Fermentation.*

*To make Wine of Vegetable Substances that are susceptible of Spirituous Fermentation.*

LET a liquor susceptible of, and prepared for, the spirituous fermentation, be put into a cask. Set this cask in a temperately warm cellar, and cover the bung hole with a bit of linen cloth only. In more or less time, according to the nature of the liquor to be fermented,

and to the degree of heat in the air, the liquor will begin to swell, and be rarefied. There will arise an intestine motion, attended with a small hissing and effervescence, throwing up bubbles to the surface, and discharging vapours; while the gross, viscous, and thick parts, being driven up by the fermenting motion, and rendered lighter by little bubbles of air adhering to them, will rise to the top, and there form a kind of soft spongy crust, which will cover the liquor all over. The fermenting motion still continuing, this crust will, from time to time, be lifted up and cracked by vapours making their escape through it; but those fissures will presently close again, till, the fermentation gradually going off, and at last entirely ceasing, the crust will fall in pieces to the bottom of the liquor, which will insensibly grow clear. Then stop the cask close with its bung, and set it in a cooler place.

Matters that are susceptible of the spirituous fermentation are seldom so perfectly prepared for it by nature as they require to be. If we except the juices that flow naturally from certain trees, but oftener from incisions made on purpose in them, all other substances require some previous preparation.

Boerhaave divides the substances that are fit for spirituous fermentation into five classes. In the first he places all the meally seeds, the legumens, and the kernels of almost all fruits. The second class includes the juices of all fruits that do not tend to putrefaction. In the third class stand the juices of all the parts of plants which tend rather to acidity than to putrefaction; and consequently those which yield much volatile alkali are to be excluded. The fourth class comprehends the juices or saps that spontaneously distil from several trees and plants, or flow from them when wounded. He forms his fifth and last class of the saponaceous, saccharine, and concrete or thick juices of vegetables. Resinous or purely gummy matters are excluded, as not being fermentable.

These five classes may be reduced into two; one comprehending all the juices, and another all the meally parts of vegetables that are susceptible of fermentation. The juices want nothing to fit them for fermentation, but to be expressed out of the substances containing them, and to be diluted with a sufficient quantity of water. If they be very thick, the best way is to add so much water as shall render the mixed liquor just capable of bearing a new-laid egg. With respect to farinaceous substances, as they are almost all either oily or mucilaginous, they require a little more management. The method of brewing malt liquors will furnish us with examples of such management. See BREWING.

Besides the preparations relating chiefly to malt-liquors, there are many other things to be observed relating to spirituous fermentation in general, and to all matters susceptible of that fermentation. For example; all grains and fruits designed for that fermentation must be perfectly ripe; for otherwise they will not ferment without difficulty, and will produce little or no inflammable spirit. Such matters as are too austere, too acrid, or astringent, are for the same reason unfit for spirituous fermentation; as well as those which abound too much in oil.

In order to make the fermentation succeed perfectly, so as to produce the best wine that the fermented liquor is capable of affording, it is necessary to let it stand quiet without stirring it, lest the crust that forms on its surface should be broken to little fragments, and mix with the liquor. This crust is a kind of cover, which hinders the spirituous parts from exhaling as fast as they are formed. The free access of the air is another condition necessary to fermentation: and for this reason the vessel that contains the fermenting liquor must not be close stopped; the bung-hole is only to be covered with a linen cloth, to hinder dirt and insects from falling into it. Nor must the bung-hole be too large, lest too much of the spirituous parts should escape and be lost.

Lastly, a just degree of warmth is one of the conditions most necessary for fermentation: for in very cold weather there is no fermentation at all; and too much heat precipitates it in such a manner that the whole liquor becomes turbid, and many fermenting and fermented particles are dissipated.

If, notwithstanding the exactest observance of every particular requisite to excite a successful fermentation, the liquor cannot, without difficulty, be brought to effervesce, which scarce ever happens but to malt-liquor, it may be accelerated by mixing therewith some matter that is very susceptible of fermentation, or actually fermenting. Such matters are called *ferments*. The crust that forms on the surface of fermenting liquors is a most efficacious ferment, and on that account very much used.

It sometimes happens, that there is occasion to check the fermentation excited in the liquor, before it ceases of itself. To effect this, such means must be used as are directly opposite to those mentioned above for promoting fermentation. The same end is obtained by mixing with the liquor a quantity of alkali, sufficient to absorb the acid contained therein: but this method is seldom made use of, because it spoils the liquor; which, after being thus treated, is incapable of any spirituous fermentation, but on the contrary will certainly putrefy.

Spirituous fermentation may also be stopped by mixing with the liquor a great quantity of some mineral acid. But this likewise alters its nature; because these acids, being fixed, always remain confounded therewith, and never separate from it.

The best method yet found out for checking this fermentation, without injury to the fermenting liquor, is to impregnate it with the fumes of burning sulphur. These fumes are known to be acid, and it is that quality in them which suspends the fermentation. But at the same time this acid is extremely volatile; so that it separates spontaneously from the liquor, after some time, and leaves it in a condition to continue its fermentation.

For this reason, when a wine is desired that shall be but half fermented, and shall partly retain the sweet taste it had in the state of *muß*, (the proper name for the unfermented juice of the grape), it is put into casks in which sulphur hath been previously burnt, and the vapours thereof confined by stopping the bung-hole. These are called *matched wines*. If the same operation be performed on must, its fermentation will be absolutely prevented: it will retain all its saccharine taste, and is then called

called *stum*. As the sulphureous acid evaporates spontaneously, in no long space, it is necessary to fumigate matched wines or stums from time to time, when they are intended to be kept long without fermenting.

*To draw an Ardent Spirit from Substances that have undergone the Spirituous Fermentation. The Analysis of Wine.*

FILL a large copper cucurbit half full of wine. Fit on its head and refrigeratory. Lute on a receiver with wet bladder, and distill with a gentle fire; yet so that the drops which fall from the nose of the alembic may succeed one another pretty quick, and form a sort of small continued stream. Go on thus till you perceive that the liquor which comes over ceases to be inflammable; and then desist. You will find in the receiver a clear liquor, somewhat inclining to an amber-colour, of a pleasant quick smell, and which being thrown into the fire instantly flames. The quantity thereof will be nearly a fourth part of the wine you put into the alembic; and this is what is called *brandy*; that is, the ardent spirit of wine loaded with much phlegm.

In order to rectify it, and reduce it to spirit of wine, put it into a long-necked matras, capable of holding double the quantity. Fit a head to the matras, and lute on a receiver: place your matras over a pot half full of water: set this pot over a moderate fire; and with this vapour-bath distil your spirit, which will rise pure. Continue this degree of heat till nothing more will come over. You will find in the receiver a very clear colourless spirit of wine, of a quick but agreeable smell, which will catch fire at once by the bare contact of any flaming substance.

*To dephlegmate Spirit of Wine by the Means of Fixed Alkalis.*

INTO a glass cucurbit pour the spirit of wine you intend to dephlegmate, and add to it about a third part of its weight of fixed alkali, newly calcined, perfectly dry, heated, and pulverised. Shake the vessel, that the two matters may be mixed and blended together. The salt will gradually grow moist, and, if the spirit of wine be very aqueous, melt into a liquor, that will always lie at the bottom of the vessel, without uniting with the spirit of wine which will swim at top.

When you perceive that the alkali attracts no new moisture, and that no more of it melts, decant your spirit of wine from the liquor beneath it, and add to your spirit fresh salt thoroughly dried as before. This salt also will imbibe a little moisture; but it will not grow liquid, because the alkali, with which it was mixed before, hath left too little phlegm to melt this. Decant it from this salt as at first, and continue to mix and shake it in the same manner with fresh salt, till you observe that the salt remains as dry after as it was before mixing it with the spirit of wine. Then distil your spirit in a small alembic with a gentle heat, and you will have it as much dephlegmated as it can be.

*Spirit of Wine combined with different Substances.*

*To combine Spirit of Wine with the Vitriolic Acid. This Combination decomposed. Ether.*

INTO an English glass retort put two pounds of spirit of wine perfectly dephlegmated, and pour on it at once two pounds of highly concentrated oil of vitriol: shake the retort gently several times, in order to mix the two liquors. This will produce an ebullition, and considerable heat; vapours will ascend, with a pretty loud hissing noise, which will diffuse a very aromatic smell, and the mixture will be of a deeper or lighter red colour, according as the spirit of wine was more or less oily. Set the retort on a sand-bath made nearly as hot as the liquor; lute on a tubulated ballon, and distil the mixture with a fire strong enough to keep the liquor always boiling; a very aromatic spirit of wine will first come over into the ballon, after which the æther will rise. When about five or six ounces of it are come off, you will see in the upper concavity of the retort a vast number of little points in a veined form, which will appear fixed, and which are nevertheless so many little drops of æther, rolling over one another, and trickling down into the receiver. These little points continue to appear and succeed each other to the end of the operation. Keep up the same degree of fire, till upon opening the little hole in the ballon you perceive that the vapours, which instantly fill the receiver, have the suffocating smell of volatile spirit of sulphur.

Then unlute the ballon, pour the liquor it contains into a crystal bottle, and stop it close: there will be about eighteen ounces of it. Lute on your receiver again, and continue the distillation with a greater degree of fire. There will come over an aqueous, acid liquor, smelling strong of a sulphureous spirit, which is not inflammable. It will be accompanied with undulating vapours; which being condensed will form an oil, most commonly yellow, one part of which will float on the surface of the liquor, and another will sink to the bottom.

Towards the end of the distillation of this acid liquor, and of the yellow oil of which it is the vehicle, that part of the mixture, which is left in the retort and grown black, will begin to rise in froth. Then suppress your fire at once: stop the distillation, and change your receiver once more. When the vessels are grown pretty cool, finish your distillation with a lamp-heat kept up for twelve or fifteen days, which in all that time will raise but a very little sulphureous spirit. Then break your retort, in which you will find a black, solid mass, like a bitumen. It will have an acid taste, arising from a remainder of the acid imperfectly combined with oil.

This artificial bitumen may be freed from its redundant acid, by washing it in several waters. Then put it into a glass retort, and distil it with a strong reverberated fire. You will obtain a reddish oil that will swim on water, much like the oil obtained by distilling the natural bitumens.

bitumens. This oil also will be accompanied with an aqueous acid liquor. In the retort will be left a charred matter, which, being put into an ignited crucible in the fire, burns for some time, and, when well calcined, leaves a white earth.

The liquors that rise first in this distillation, and which we directed to be kept by themselves, are a mixture consisting, 1. of a highly dephlegmated spirit of wine, of a most fragrant smell; 2. of æther, which the spirit of wine wherewith it is united renders miscible with water; 3. of a portion of oil, which commonly rises with the æther towards the end of the operation; 4. and sometimes of a little sulphurous acid, if the receiver be not changed soon enough.

In order to separate the æther from these other substances, put the whole into an English retort, with a little oil of tartar *per deliquum* to absorb the sulphureous acid, and distil very slowly in a sand bath heated by a lamp, till near half the liquor be come over. Then cease distilling; put the liquor in the receiver into a phial with some water, and shake it; you will see it rise with rapidity to the upper part of the phial, and float on the surface of the water: this is the æther.

*Spirit of Wine combined with Spirit of Nitre.*  
*Sweet Spirit of Nitre.*

INTO an English retort of crystal glass put some highly rectified spirit of wine; and, by means of a glass funnel with a long pipe let fall into your spirit of wine a few drops of the smoking spirit of nitre. There will arise in the retort an effervescence attended with heat, red vapours, and a hissing noise like that of a live coal quenched in water. Shake the vessel a little, that the liquors may mix thoroughly, and that the heat may be equally communicated to the whole. Then add more spirit of nitre, but in a very small quantity, and with the same precautions as before. Continue thus adding spirit of nitre, by little and little at a time, till you have put into the retort a quantity equal to a third part of your spirit of wine. Let this mixture stand quiet, in a cool place, for ten or twelve hours; then set it to digest in a very gentle warmth for eight or ten days, having first luted on a receiver to the retort.

During this time a small quantity of liquor will come over into the receiver, which must be poured back into the retort. Then distill with a somewhat stronger degree of heat, but still very gently, till nothing be left in the retort but a thick matter. In the receiver you will find a spirituous liquor, of a quick grateful smell, which will excite a very smart sensation on the tongue, but without any corrosive acrimony. This is the *sweet spirit of nitre*.

*Spirit of Wine combined with the Acid of Sea salt.*  
*Dulcified Spirit of Salt.*

MIX together, little by little, in a glass retort, two parts of spirit of wine with one part of spirit of salt. Set this mixture to digest for a month in a gentle heat, and distill it, till nothing remain in the retort but a thick matter.

The acid of sea-salt is much less disposed to unite with

inflammable matters than the other two mineral acids; and therefore, though it be ever so highly concentrated, when mixed with spirit of wine, it never produces effervescence comparable to that which is produced by the spirit of nitre. Neither the proportion nor strength of the spirit of salt, requisite to prepare the sweet spirit of salt, are unanimously agreed upon by authors.\* Some direct equal parts of the two liquors; while others prescribe from two to four or five parts of spirit of wine to one part of spirit of salt. Some use only common spirit of salt; others require the smoking spirit distilled by means of spirit of vitriol. Lastly, some order the mixture to be distilled, after some days digestion; and others content themselves with barely digesting it. The whole depends on the degree of strength which the sweet spirit of salt is intended to have. This composition, as well as the sweet spirit of nitre, is esteemed in medicine to be very aperitive and diuretic.

When the mixture of spirit of salt and spirit of wine is distilled, there comes over but one liquor, which appears homogeneous. This is the *sweet spirit of salt*. The nature of the marine acid is not changed in this combination: the acid is only weakened and rendered more mild; but in other respects it retains its characteristic properties.

*Oils, or Oily matters, that are soluble in Spirit of Wine, separated from Vegetables, and dissolved by means of that Menstruum. Tinctures; Elixirs; Varnishes. Aromatic strong waters.*

PUT into a matras the substances from which you intend to extract a tincture, having first pounded them, or pulverised them if they are capable of it. Pour upon them spirit of wine to the depth of three fingers breadth. Cover the matras with a piece of wet bladder, and tie it on with packthread. Make a little hole in this bit of bladder with a pin, leaving it in the hole to keep it stoppered. Set the matras in a sand-bath very gently heated. If the spirit of wine dissolve any part of the body, it will accordingly acquire a deeper or lighter colour. Continue the digestion till you perceive that the spirit of wine gains no more colour. From time to time pull out the pin, to give vent to the vapours, or rarefied air, which might otherwise burst the matras. Decant your spirit of wine, and keep it in a bottle well corked. Pour on some fresh spirit in its stead: digest as before; and go on in this manner, pouring on and off fresh spirit of wine, till the last come off colourless.

Spirit of wine impregnated with such parts of any vegetable substance as it is capable of dissolving, is commonly called a *tincture*. Several tinctures mixed together, or a tincture drawn from sundry vegetable substances at the same time, and in the same vessel, take the name of an *elixir*. Tinctures of elixirs impregnated with resinous matters only, are true *varnishes*. All these preparations are made in the same manner; to wit, as directed in our process. We shall only add here, that if the substances from which a tincture or elixir is to be made contain too much moisture, it is proper to free them from it by gentle desiccation; especially if you design that the tincture should be well impregnated with the oily and resinous

resinous parts: for their excess of moisture uniting with the spirit of wine would weaken it, and render it unable to act on those matters, which it cannot dissolve when it is aqueous.

If your tinctures or elixirs be not so strong or so saturated as you desire, you may by distillation abstract part of the spirit of wine which they contain, and by that means give them such a degree of thickness as you judge proper. But the spirit of wine thus drawn off constantly carries along with it a good deal of the aromatic principle. It is a truly *aromatic strong water*. This spirit of wine also carries up with it a portion of thin oil, which is so much the more considerable as the degree of heat employed is greater: and this is the reason why it becomes of a milky colour when mixed with water.

If you intend to make an aromatic strong water only, you need not previously extract a tincture from the vegetable substance with which you mean to prepare your water: you need only put it in a cucurbit, pour spirit of wine upon it, and distil with a gentle heat. By this means you will obtain a spirit of wine impregnated with all the odour of the plant.

#### Of TARTAR.

*Tartar analysed by distillation. The Spirit, Oil, and Alkaline Salt of Tartar.*

INTO a stone retort, or a glass one coated with lute, put some white tartar broken into small bits; observing that one half, or at least a full third, of the vessel be left empty. Set your retort in a reverberating furnace. Fit on a large ballon, having a small hole drilled in it; lute it exactly with fat lute, and secure the joint with a linen cloth smeared with lute made of quick-lime and the white of an egg. Apply at first an exceeding gentle heat, which will raise a limpid, sourish, pungent water, having but little smell, and a bitterish taste.

When this first phlegm ceases to come off, increase your fire a little, and make the degree of heat nearly equal to that of boiling water. A thin, limped oil will rise, accompanied with white vapours, and with a prodigious quantity of air, which will issue out with such impetuosity, that if you do not open the little hole in the receiver time enough to give it vent, it will burst the vessels with explosion. An acid liquor will rise at the same time. Continue the distillation, increasing the heat by insensible degrees, and frequently unstopping the little hole of the receiver, till the elastic vapours cease to issue, and the oil to distil.

Then raise your fire more boldly. The acid spirit will continue to rise, and will be accompanied with a black, fetid, empyreumatic, ponderous, and very thick oil. Urge the fire to the utmost extremity so that the retort may be of a perfect red heat. This violent fire will raise a little volatile alkali, besides a portion of oil as thick as pitch. When the distillation is finished, you will find in the retort a black, saline, charred matter, which grows hot when wetted, attracts the moisture of the air, runs *per deliquium*, and hath all the properties of a fixed alkali.

VOL. II. No. 37.

3

The mass, being exposed to a naked fire in the open air, burns, consumes, and is reduced to a white ash, which is a fiery, caustic, fixed alkali.

The lees of wine resemble tartar, in as much as they contain, and yield when analysed, the same principles; but they differ from it in this, that they contain, moreover, a greater quantity of earth, of phlegm, and a little ardent spirit, which are only mixed, but not united, with its tartarous acid.

*The Depuration of Tartar. Cream and Crystals of Tartar.*

REDUCE to a fine powder the tartar you intend to purify, and boil it in twenty five or thirty times as much water. Filter the boiling liquor through a flannel bag, and then gently evaporate some part of it: there will soon form on its surface a saline crust, which is the *cream of tartar*. Let your liquor cool, and there will adhere to the sides of the vessel a great quantity of a crystallised saline matter, which is *crystal of tartar*.

*Crystal of Tartar combined with several substances.*

*Crystal of Tartar combined with Absorbent Earths: Soluble Tartars.*

BOIL an absorbent earth, such as chalk, in a pan with water; and, when you perceive the earth thoroughly divided and equally distributed through the water, throw into the pan, from time to time, some pulverised crystal of tartar, which will excite a considerable effervescence. Continue these projections, till you observe no effervescence excited thereby. All the absorbent earth, which obscured the transparency of the water, and gave it an opaque white colour, will gradually disappear as the crystal of tartar combines with it; and when the combination is perfected, the liquor will be clear and limpid. Then filter it, and there will be left on the filter but a very small quantity of earth. Evaporate all the filtered liquor with a gentle heat; and then set it in a cool place to shoot. Crystals will form therein, having the figure of flat quadrangular prisms, with almost always one, sometimes two, of the angles of the prism shaved down, as it were; and then the surfaces at each end are oblique answering to those depressed angles. These crystals are a neutral salt which readily dissolves in water; a true *soluble tartar*.

*Crystal of Tartar combined with fixed Alkalis. The Vegetable Salt. Saignette's Salt. The decomposition of Soluble Tartars.*

IN eight parts of water dissolve one part of a very pure alkaline salt, perfectly freed from the phlogiston by calcination. Heat this lixivium in a stone pan set on a sand bath, and from time to time throw into it a little powdered cream or crystal of tartar. Each projection will excite a great effervescence, attended with many bubbles, which will rise to a considerable height one over the other. Stir the liquor when the effervescence ceases, and you will see it begin again.

† 2 T

When

When no effervescence appears upon stirring the liquor, add a little more cream of tartar, and the same phenomena will be renewed. Go on thus till you have obtained the point of perfect saturation.

Then filter your liquor. If the alkali you made use of was the salt of Soda, evaporate your liquor quickly to a pellicle, and there will shoot in it crystals of nine sides resembling a coffin; the bottom part thereof being concave, and streaked with a great many parallel lines; and this is *Suignette's salt*. If you have employed any other alkali but soda, or the basis of sea-salt, evaporate your liquor slowly to the consistence of a syrup: let it stand quiet, and there will form in it crystals having the figure of flatted parallelo-pipeds; and this is the *vegetable salt*, or *tartarified tartar*.

All soluble tartars are easily decomposed, by means of a certain degree of heat. They yield in distillation the same principles as tartar; and the alkali that remains when they are perfectly calcined, consists of that which the tartar naturally affords, and of the alkaline matter with which it was converted into a neutral salt.

*Crystal of Tartar combined with Iron. Chalybeated Tartar. Tincture of Steel with Tartar. Soluble Chalybeated Tartar.*

Mix four ounces of iron in filings with one pound of white tartar finely pulverised. Boil the mixture in about twelve times as much water as you took of tartar. When the saline part of the tartar is dissolved, filter the liquor boiling-hot through a flannel bag, and then set it in a cool place. In a very little time crystals of a ruflet colour will shoot therein. Decant the liquor from these crystals; evaporate it to a pellicle, and set it again to crystallise. Go on in this manner till it will shoot no more. Collect all the salt you have thus obtained, and keep it under the name of *chalybeated tartar*.

To make the tincture of steel with tartar, mix together six ounces of clean iron filings, and one pound of white tartar in powder. Put this mixture into a large iron kettle, and pour thereon as much rain-water as will moisten it. Make a paste of this matter, and leave it thus in a mass for twenty-four hours. Then pour on it twelve pounds of rain-water, and boil the whole for twelve hours at least, stirring the mixture frequently, and adding from time to time some hot water, to supply the place of what evaporates. When you have thus boiled the liquor, let it stand quiet for some time, and then pour it off from the sediment at bottom. Filter, and evaporate to the consistence of a syrup; and you have the *tincture of Mars with tartar*. The dispensaries generally order an ounce of rectified spirit of wine to be poured on this tincture, in order to preserve it, and to keep it from growing mouldy, as it is very apt to do.

*Soluble chalybeated tartar* is prepared by mixing four ounces of tartarified tartar with one pound of the tincture of Mars with tartar, and evaporating them together in an iron vessel to dryness; after which it is kept in a well stopped phial to prevent its growing moist in the air.

*Crystal of Tartar combined with the reguline part of Antimony. Stibiated or Emetic tartar.*

PULVERISE and mix together equal parts of the glass and of the liver of antimony. Put this mixture, with the same quantity of pulverised cream of tartar, into a vessel capable of containing as much water as will dissolve the cream of tartar. Boil the whole for twelve hours, from time to time adding warm water, to replace what is dissipated by evaporation. Having thus boiled your liquor, filter it while boiling hot; evaporate to dryness; and you will have a saline matter, which is *emetic tartar*.

*Of the Product of Acetous Fermentation.*

*Substances susceptible of the Acetous Fermentation turned into Vinegar.*

THE wine, the cyder, or the malt-liquor, you intend to convert into vinegar, being first thoroughly mixed with its lees, and with the tartar it may have deposited, put your liquor into a fat used before either for making or for holding vinegar. This vessel must not be quite full, and the external air must have access to the liquor contained in it. Set it where the air may have a degree of warmth answering nearly to the twentieth degree above 0 in Mr de Reaumur's thermometer. Stir the liquor from time to time. There will arise in it a new fermentative motion, accompanied with heat: its vinous odour will gradually change, and turn to a sour smell, which will become stronger and stronger till the fermentation be finished and cease of itself. Then stop your vessel close; the liquor it contains will be found converted into vinegar.

All substances that have undergone the spirituous fermentation are capable of being changed into an acid by passing through this second fermentation, or this second stage of fermentation. Spirituous liquors, such as wine, cyder, beer, being exposed to a hot air, grow sour in a very short time. Nay, these liquors, though kept with all possible care, in very close vessels, and in a cool place, degenerate at last, change their natures, and insensibly turn sour. Thus the product of spirituous fermentation naturally and spontaneously degenerates to an acid.

For this reason it is of great importance, in making wine, or any other vinous liquor, to stop the fermentation entirely, if you desire the wine should contain as much spirit as possible. It is even more advantageous to check the fermentation a little before it come to the height than afterwards: because the fermentation, tho' slackened and in appearance totally ceased, still continues in the vessels; but in a manner so much the less perceptible as it proceeds more slowly. Thus those liquors, in which the fermentation is not quite finished, but checked, continue for some time to gain more spirit; whereas, on the contrary, they degenerate and gradually turn sour, if you let the spirituous fermentation go on till it be entirely finished.

The production of the second fermentation, which we are now to consider, is an acid of so much the greater strength.



strength; the stronger and more generous the spirituous liquor in which it is excited originally was. The strength of this acid, commonly called *vinegar*, depends likewise in a great measure on the methods used in fermenting the vinous liquor, in order to convert it into vinegar: for if it be fermented in broad, flat vessels, and left to grow four of itself, the spirituous parts will be dissipated, and the liquor be sour indeed, but vapid and effete.

The vinegar-makers, to increase the strength of their vinegar, use certain methods of which they make a mystery, keeping them very secret. However, Mr. Boerhaave give us, from some authors, the following description of a process for making vinegar:

“ Take two large oak vats or hogheads, and in each of these place a wooden grate or hurdle, at the distance of a foot from the bottom. Set the vessel upright, and on the grates place a moderately close layer of green twigs, or fresh cuttings of the vine. Then fill up the vessel with the foot-stalks of grapes, commonly called the *rape*, to within a foot of the top of the vessel, which must be left quite open.

“ Having thus prepared the two vessels, pour into them the wine to be converted into vinegar, so as to fill one of them quite up, and the other but half full. Leave them thus for twenty-four hours, and then fill up the half-filled vessel with liquor from that which is quite full, and which will now in its turn be left only half full. Four and twenty hours afterwards repeat the same operation, and go on thus, keeping the vessels alternately full and half full during every twenty-four hours, till the vinegar be made. On the second or third day there will arise, in the half-filled vessel, a fermentative motion, accompanied with a sensible heat, which will gradually increase from day to day. On the contrary, the fermenting motion is almost imperceptible in the full vessel; and as the two vessels are alternately full and half full, the fermentation is by that means, in some measure, interrupted, and is only renewed every other day, in each vessel.

“ When this motion appears to be entirely ceased, even in the half-filled vessel, it is a sign that the fermentation is finished; and therefore the vinegar is then to be put into common casks close stopped, and kept in a cool place.

“ A greater or less degree of warmth accelerates or checks this, as well as the spirituous fermentation. In France it is finished in about fifteen days, during the summer; but if the heat of the air be very great, and exceed the twenty-fifth degree of Mr de Réaumur's thermometer, the half-filled vessel must be filled up every twelve hours; because if the fermentation be not so checked in that time, it will become so violent, and the liquor will be so heated, that many of the spirituous parts, on which the strength of the vinegar depends, will be dissipated; so that nothing will remain, after the fermentation, but a vapid wash, sour indeed, but effete. The better to prevent the dissipation of the spirituous parts, it is a proper and usual precaution to close the mouth of the half-filled vessel, in which the liquor ferments, with a cover made also of oak wood. As to the

full vessel, it is always left open, that the air may act freely on the liquor it contains: for it is not liable to the same inconveniences, because it ferments but very slowly.”

The vine-cuttings and grape-stalks, which the vinegar-makers put into their vessels, serve to increase the strength of the liquor. These matters contain a very manifest and perceptible acid. They also serve as a ferment; that is, they dispose the wine to become eager more expeditiously and more vigorously. They are the better and the more efficacious for having been once used, because they are thereby thoroughly drenched with the fermented acid: and therefore the vinegar-makers lay them by for preparing other vinegar, after washing them nimbly in running water, in order to free them from a viscid oily matter which settles on them during the fermentation. This matter must by all means be removed; because it is disposed to grow mouldy and rot; so that it cannot but be prejudicial to any liquor in which you put it.

As the acetous fermentation differs from the spirituous in its production, so it doth in many circumstances attending it. 1. Motion and agitation are not prejudicial to the acetous fermentation, as they are to the spirituous; on the contrary, moderate stirring, provided it be not continued, is of service to it. 2. This fermentation is accompanied with remarkable heat; whereas the warmth of the spirituous fermentation is scarce sensible. 3. We do not believe there ever was an instance of the vapour that rises from a liquor in acetous fermentation proving noxious, and producing either disorders or sudden death, as the vapour of fermenting wine doth. 4. Vinegar deposits a viscid oily matter, as hath just been observed, very different from the lees and tartar of wine. Vinegar never deposits any tartar; even though new wine, that hath not yet deposited its tartar, should be used in making it.

#### *To concentrate vinegar by Frost.*

Expose to the air, in frosty weather, the vinegar you desire to concentrate. Icicles will form in it; but the whole liquor will not freeze. Take out those icicles and if you desire a further concentration of your vinegar by this method, the liquor which did not freeze the first time must be exposed to a stronger frost. More icicles will form therein, which must likewise be separated, and kept by themselves. The liquor which doth not freeze this second time will be a very strong concentrated vinegar.

#### *Vinegar analysed by Distillation.*

Into a glass or stone cucurbit put the vinegar to be distilled; fit to it a glass head; place your alembic in the sand-bath of a distilling furnace, and lute on a receiver. Apply a very gentle heat at first. A clear, limpid, light liquor will rise, and fall in distinct drops, like water, from the nose of the alembic.

Continue distilling this first liquor, till the vinegar contained in the cucurbit be diminished about a fourth part. Then shift your receiver, and increase the fire a little. A clear liquor will still come over, but heavier and more acid

acid than the former. Distil in this manner till you have drawn off into your second receiver two thirds of the liquor that was left in the cucurbit.

A thick matter will now remain at the bottom of the still: put it into a retort; lute on a receiver; set your retort in a reverberating furnace, and distil with degrees of fire. There will come over a limpid liquor, very acid and sharp, yet ponderous, and requiring a great degree of fire to raise it; on which account it makes the receiver very hot. It hath a strong empyreumatic smell. When the distillation begins to slacken, increase your fire. There will rise an oil of a fetid, quick smell. At last when nothing more will rise with the strongest fire, break the retort, and in it you will find a black charred matter: burn it, and from the ashes lixiviated with water you will obtain a fixed alkali.

*The Acid of Vinegar combined with different Substances.*

*The Acid of Vinegar combined with Alkaline Substances. Foliated Salt of Tartar, or regenerated Tartar. Decomposition of that Salt.*

INTO a glass cucurbit put some very pure and well dried salt of tartar; and pour on it some good distilled vinegar, by little and little at a time. An effervescence will arise. Pour on more vinegar, till you attain the point of saturation. Then fit a head to the cucurbit; set it in a sand bath; and, having luted on a receiver, distil with a gentle heat, and very slowly, till nothing remain but a dry matter. On this residuum drop a little of the same vinegar; and if any effervescence appears, add more vinegar till you attain the point of saturation, and distil again as before. If you observe no effervescence, the operation was rightly performed.

It is not easy to hit the exact point of saturation in preparing this neutral salt; because the oily parts, with which the acid of vinegar is loaded, hinder it from acting so briskly and readily as it would do, if it were as pure as the mineral acids: and for this reason it often happens, that, when we have nearly attained the point of saturation, the addition of an acid makes no sensible effervescence, though the alkali be not yet entirely saturated; which deceives the operator, and makes him conclude erroneously that he hath attained the true point of saturation.

But he easily perceives his mistake, when, after having separated from this saline compound all its superfluous moisture by distillation, he drops fresh vinegar upon it: for then the salts being more concentrated, and consequently more active, produce an effervescence, which would not have been sensible if this last portion of acid, instead of coming into immediate contact with the dried alkali, could not have mixed therewith till diffused through, and in a manner suffocated by that phlegm from which the acid of the vinegar before neutralised was gradually separated by its combining with the alkali; that phlegm keeping in solution both the neutral salt already formed, and the alkali not yet saturated. And for this reason it is necessary to try, after the first desiccation of

this salt, which is called *regenerated tartar*, whether or no the just point of saturation hath been attained.

From what hath been said, concerning the desiccation of this neutral salt, it is plain, that the use of it is only to free the salt from the great quantity of superfluous moisture wherein it is dissolved: which proves, that the acid of vinegar, like all other acids dissolved in much water, is separated from most of this redundant phlegm by being combined with a fixed alkali. And hence we must conclude, that the acid of vinegar, contained in regenerated tartar desiccated, is vastly stronger and more concentrated than it was before.

Though the acid of vinegar is freed, by combining with a fixed alkali, from a great quantity of superfluous phlegm, yet the oily parts with which it is entangled still cleave to it: these parts are not separated from it by its conversion into a neutral salt, but, without quitting it, combine also with the fixed alkali; and this gives regenerated tartar a saponaceous quality, and several other peculiar properties.

Regenerated tartar, when dried, is of a brown colour. It is semi-volatile; melts with a very gentle heat, and then resembles an unctuous liquor; which indicates its containing an oil: when cast upon live coals, it flames; and, when distilled with a strong heat, yields an actual oil; all which evidently proves the existence of that oil.

This salt is soluble in spirit of wine; a quality which it probably owes also to its oil. It requires about six parts of spirit of wine to dissolve it; and the dissolution succeeds very well in a matras, with the help of a gentle warmth. If the spirit of wine be abstracted from this solution, by distilling with a small fire, it remains at the bottom of the cucurbit, in the form of a dry substance composed of leaves lying one upon another; which hath procured it the name of *terra foliata tartari*, or *foliated salt of tartar*.

It is not absolutely necessary that regenerated tartar be dissolved in spirit of wine to make the foliated salt: for it may be procured in this form only by evaporating the water in which it is dissolved. But the operation succeeds better with spirit of wine; probably because the success thereof depends on using an exceeding gentle warmth: now spirit of wine evaporates with much less heat than water.

Regenerated tartar may also be crystallised. If you desire to have it in this form, combine the acid with the alkali to the point of saturation; evaporate the liquor slowly to the consistence of a syrup, and set it in a cool place; where it will shoot into clusters of crystals lying one upon another like feathers.

Vinegar perfectly dissolves absorbent matters also, and particularly those of the animal kingdom; such as corals, crabs eyes, pearls, &c. In order to a dissolution of such matters, you must pulverise them, put them into a matras, and pour on them spirit of vinegar to the depth of four fingers breadth: an effervescence will arise: when that is over, set the mixture to digest two or three days in a sand-bath; then decant the liquor, filter it, and evaporate it to dryness with a very gentle heat. The matter which remains is called *salt of coral, of pearls,*

of

of crabs-eyes, &c. according to the substances dissolved. If, instead of evaporating the liquor, a fixed alkali be mixed therewith, the absorbent matter, that was dissolved by the acid, will precipitate in the form of a white powder, which is called the *magistry of coral, of pearls, &c.*

*The Acid of Vinegar combined with copper. Verdegris. Crystals of Copper. This Combination decomposed. Spirit of Verdegris.*

INTO a large matras put verdegris in powder. Pour on it distilled vinegar to the depth of four fingers breadth. Set the matras in a moderate sand-heat, and leave the whole in digestion, shaking it from time to time. The vinegar will acquire a very deep blue-green colour. When the liquor is sufficiently coloured, pour it off by inclination. Put some fresh vinegar into the matras; digest as before; and decant the liquor again when it is sufficiently coloured. Proceed in this manner till the vinegar will extract no more colour. There will remain in the matras a considerable quantity of undissolved matter. The vinegar thus impregnated with verdegris is called *tincture of copper*.

Mix these several tinctures, and evaporate them with a gentle heat to a pellicle. Then set the liquor in a cool place: in the space of a few days a great many crystals of a most beautiful green colour will shoot therein, and stick to the sides of the vessel. Pour off the liquor from the crystals; evaporate it again to a pellicle, and set it by to crystallise. Continue these evaporations and crystallisations, till no more crystals will shoot in the liquor. These are called *crystals of copper*, and are used in painting. To this combination of the acid of vinegar with copper the painters and dealers have given them the title of *distilled verdegris*.

Verdegris is prepared at Montpellier. To make it they take very clean plates of copper, which they lay, one over another, with husks of grapes between, and after a certain time take them out. Their surfaces are then covered all over with a very beautiful green crust, which is *verdegris*. This verdegris is nothing but copper corroded by the acid of tartar, analogous to the acid of vinegar, which abounds in the wines of Languedoc, and especially in the rape, husks, and stones of grapes that have a very austere taste. Verdegris is a sort of rust of copper, or copper corroded and opened by the acid of wine, but not yet converted entirely into a neutral salt: for it is not soluble in water, nor does it crystallise. This arises from its not being united with a sufficient quantity of acid. The design of the operation here described is to furnish the verdegris with the quantity of acid requisite to make it a true metallic salt; for which purpose distilled vinegar is very fit.

Crystals of copper may be obtained, without employing verdegris, by making use of copper itself dissolved by the acid of vinegar, according to the method practised with respect to lead, as shall be shewn hereafter. But verdegris is generally used, because it dissolves soonest; it being a copper already half dissolved by an acid correspondent to that of vinegar.

Crystals of copper are decomposed by the action of

fire alone, without any additament; because the acid of vinegar adheres but loosely to copper. In order to decompose this salt, and extract its acid, it must be put into a retort, and distilled in a reverberatory furnace with degrees of fire. An insipid phlegm rises first, which is the water retained by the salt in crystallising. This phlegm is succeeded by an acid liquor, which rises in the form of white vapours that fill the receiver. Towards the end of the distillation the fire must be violently urged, in order to raise the strongest and most fixed acid. At last there remains in the retort a black matter, which is nothing but copper, that may be reduced by melting it in a crucible with one part of saltpetre and two parts of tartar. A similar acid, but more oily, and in a much smaller quantity, may be obtained from verdegris by distillation.

The acid, which in this distillation comes over after the first phlegm, is an exceeding strong and concentrated vinegar. It is known by the title of *spirit of verdegris*.

*The Acid of Vinegar combined with Lead. Ceruse. Salt or Sugar of Lead. This Combination decomposed.*

INTO the glass head of a cucurbit put thin plates of lead, and secure them so that they may not fall out when the head is put upon the cucurbit. Fit on this head to a wide-mouthed cucurbit containing some vinegar. Set it in a sand-bath; lute on a receiver, and distil with a gentle heat for ten or twelve hours. Then take off the head: in it you will find the leaden plates covered, and, in a manner, crusted over with a white matter. This being brushed off with a hare's foot is what we call *ceruse*. The leaden plates thus cleansed may be employed again for the same purpose, till they be wholly converted into ceruse by repeated distillations. During the operation there will come over into the receiver a liquor somewhat turbid and whitish. This is a distilled vinegar in which some lead is dissolved.

Reduce a quantity of ceruse into powder; put it into a matras; pour on it twelve or fifteen times as much distilled vinegar; set the matras in a sand-bath; leave the matter in digestion for a day, shaking it from time to time: then decant your liquor, and keep it apart. Pour fresh vinegar on what is left in the matras, and digest as before. Proceed thus till you have dissolved one half, or two thirds, of the ceruse.

Evaporate to a pellicle the liquors you poured off from the ceruse, and set them in a cool place. Greyish crystals will shoot therein. Decant the liquor from the crystals; evaporate it again to a pellicle, and set it by to crystallise. Proceed thus evaporating and crystallising, as long as any crystals will shoot. Dissolve your crystals in distilled vinegar, and evaporate the solution, which will then shoot into whiter and purer crystals. This is the *salt, or sugar of lead*.

Lead is easily dissolved by the acid of vinegar. If it be barely exposed to the vapour of that acid, its surface is corroded, and converted into a kind of calx or white rust, much used in painting, and known by the name of *ceruse, or white lead*. But this preparation of lead is not combined with a sufficient quantity of acid to convert

it into a salt: it is no more than lead divided and opened by the acid of vinegar; a matter which is to lead what verdgris is to copper. And therefore if you desire to combine ceruse with the quantity of acid necessary to convert it into a true neutral salt, you must treat it in the same manner as we did verdgris in order to procure crystals of copper; that is, you must dissolve it in distilled vinegar, as the process directs.

The salt of lead is not very white when it first shoots; and for this reason it is dissolved again in distilled vinegar, and crystallised a second time. If salt of lead be repeatedly dissolved in distilled vinegar, and the liquor evaporated, it will grow thick; but still cannot be desiccated without great difficulty. If the same operation be oftener repeated, this quality will be thereby more and more increased; till at last it will remain on the fire like an oil or melted wax: it coagulates as it cools, and then looks, at first sight, like a metallic mass, somewhat resembling silver. This matter runs with a very gentle heat, almost as easily as wax.

The salt of lead hath a saccharine taste, which hath procured it the name also of sugar of lead. For this reason, when wine begins to turn sour, the sure way to cure it of that disagreeable taste, is to substitute a sweet one which is not disagreeable to the taste, by mixing therewith ceruse, litharge, or some such preparation of lead; for the acid of the wine dissolves the lead, and therewith forms a sugar of lead, which remains mixed with the wine, and hath a taste which, joined with that of the wine, is not unpleasant. But, as lead is one of the most dangerous poisons we know, this method ought never to be practised; and whoever uses such a pernicious drug deserves to be most severely punished. Yet some thing very like this happens every day, and must needs have very bad consequences; while there is nobody to blame, and those to whom the thing may prove fatal can have no mistrust of it.

Salt of lead may be decomposed by distillation without additament. In order to perform this, you must put the salt of lead into a glass or stone retort, leaving a full third thereof empty, and distil in a reverberating furnace with degrees of fire. A spirit rises, which fills the receiver with clouds. When nothing more will come over with a fire that makes the retort red-hot, let the vessels cool, and then unlute them. You will find in the receiver an austere liquor, which is inflammable; or, at least, an inflammable spirit may be obtained from it, if about one half thereof be drawn off by distillation in a glass alembic. The retort in which the salt of lead was decomposed contains, at the end of the operation, a blackish matter: this is lead, which will resume its metallic form on being melted in a crucible; because the acid by which it was dissolved, and from which it hath been separated, being of a very oily nature, hath left in it a sufficient quantity of phlogiston.

What is most remarkable in this decomposition of salt of lead, is the inflammable spirit which it yields, though the vinegar which entered into the composition of the salt seemed to contain none at all.

### *Of the Putrid Fermentation of Vegetable Substances.*

#### *The Putrefaction of Vegetables.*

FILL a hoghead with green plants, and tread them down a little; or, if the vegetables be dry and hard substances, divide them into minute parts, and steep them a little in water to moisten them: then leave them, or the green plants, in the vessel, uncovered and exposed to the open air. By degrees a heat will arise in the center of the vessel, which will continue increasing daily, at last grow very strong, and be communicated to the whole mass. As long as the heat is moderate, the plants will retain their natural smell and taste. As the heat increases, both these will gradually alter, and at last become very disagreeable, much like those of putrid animal substances. The plants will then be tender as if they had been boiled; or even be reduced to a kind of pap, more or less liquid according to the quantity of moisture they contained before.

Almost all vegetable matters are susceptible of putrefaction; but some of them rot sooner, and others more slowly. As putrefaction is only a species of fermentation, the effect whereof is to change entirely the state of the acid, by combining it with a portion of the earth and oil of the mixt, which are so attenuated that from this union there results a new saline substance in which no acid is discernible; which on the contrary hath the properties of an alkali, but rendered volatile; it is plain, that, the nearer the acid of a plant set to putrefy is to this state, the sooner will the putrefaction of that plant be completed. Accordingly all plants that contain a volatile alkali ready formed, or from which it can be obtained by distillation, are the most disposed to putrefaction.

Those plants, in which the acid is very manifest and sensible, are less apt to putrefy; because all their acid must undergo the change above specified. But vegetable matters, whose acid is entangled and clogged by several of their other principles, must be still longer elaborated before they can be reduced to the condition into which complete putrefaction brings all vegetables. The earthy and oily parts, in which the acids of these substances are sheathed, must be attenuated and divided by a previous fermentation, which, of those parts subtilised and united with the acid, forms an ardent spirit, wherein the acid is more perceptible than in the almost insipid or saccharine juices out of which it is produced. The acid contained in the ardent spirit must be still further disengaged, before it can enter into the combination of a volatile alkali: consequently the ardent spirit must undergo a sort of decomposition; its acid must be rendered more sensible, and be brought to the same condition as the acid of plants in which it manifests all its properties.

Hence it appears that the spirituous and acetous fermentations are only preparatives which nature makes use of for bringing certain vegetable matters to putrefaction. These fermentations therefore must be considered as ad-

vanops:

vances towards that putrefaction in which they terminate, or rather as the first stages of putrefaction itself.

*Putrefied Vegetable Substances analysed.*

Put the putrefied plants you mean to analyse into a glass cucurbit, and set it in a sand-bath. Fit to it a head; lute on a receiver; distil with a gentle fire, and a limpid fetid liquor will come over. Continue the distillation till the matter contained in the retort be almost dry.

Then unlute your vessels, and keep the liquor you find in the receiver by itself. Put the matter remaining in the cucurbit into a retort, and distil with a graduated heat. There will rise white vapours; a pretty considerable quantity of liquor nearly like that of the former distillation; a volatile salt in a concrete form; and a black oil, which towards the end will be very thick. In the retort there will remain a black charred matter, which being burnt in the open air will fall into ashes, from which no fixed alkali can be extracted.

By means of a funnel separate your oil from the aqueous liquor. Distil this liquor with a gentle heat. You will by this means obtain a volatile salt like that of animals; of which you may also get some, by the same means, from the liquor which came over in the first distillation.

This analysis shews the changes which putrefaction produces in vegetable matters. Scarce any of their principles are now to be discerned. They now yield no aromatic liquor; no essential oil; no acid; and consequently no essential salt, ardent spirit, or fixed alkali: in a word, whatever their natures were before putrefaction, they are all alike when they have once undergone this fermentative motion in its full extent. Nothing can then be obtained from them but phlegm, a volatile alkali, a fetid oil, and an insipid earth.

Almost all these changes are owing to the transmutation of the acid, which is depraved by putrefaction, and combined with a portion of the oil and subtilised earth of the mixt; so that the result of their union is a volatile alkali. Now, as the fixed alkali, found in the ashes of unputrefied plants, is only the most fixed part of their earth and of their acid, closely united together by the igneous motion, it is not surprising, that, when all the acid, with a part of the earth, is subtilised and volatilised by putrefaction, no fixed alkali can be found in the ashes of putrefied vegetables. The alteration which the acid suffers by the putrefactive motion is, in our opinion, the greatest it can undergo, without being entirely destroyed and decomposed, so as to be no longer a salt.

*Of Operations on ANIMAL SUBSTANCES.*

*Of MILK.*

*Milk separated into Butter, Curd, and Whey: illustrated in Cow's-Milk.*

Put new cow's milk into a flat earthen pan, and set it in a temperate heat. In ten or twelve hours time there will gather on its surface a thick matter, of a somewhat

yellowish white: this is called *cream*. Gently skim off this cream with a spoon, letting the milk you take up with it run off. Put all this cream into another vessel, and keep it. The milk thus skimmed will not be quite so thick as before; nor will it be of such a dead white, but have a little bluish cast. If all the cream be not separated from it, more will gather on its surface after some time, which must be taken off as the former. In two or three days the skimmed milk will coagulate into a soft mass called *curd*, and then it tastes and smells sour.

Cut this curd across in several places. It will immediately discharge a large quantity of *serum*. Put the whole into a clean linen cloth; hang it up, and underneath it set a vessel to receive the serum as it drops. When the aqueous part hath done dripping, there will remain in the filter a white substance somewhat harder than the curdled milk. This substance is called *cheese*, and the *serum* separated from it is known by the name of *whey*.

The milk of animals that feed only on vegetables is, of all animal matters, the least removed from the vegetable nature. The truth of this will be demonstrated by the experiments we shall produce by and by, for the further analysis of milk.

Most chemists justly consider milk as of the same nature with chyle. Indeed there is great reason to think, that, except some small differences to be afterwards taken notice of, these two matters are nearly the same. They are both of a dead white colour, like that of an emulsion; which proves that, like emulsions, they consist of an oily matter divided, diffused and suspended, but not perfectly dissolved, in an aqueous liquor.

It is not surprising that these liquors should resemble emulsions; for they are produced in the same manner, and may very justly be called *animal emulsions*. For how are vegetable substances converted into chyle and milk in an animal body? They are bruised, divided, and triturated by mastication and digestion, as perfectly, at least, as the matters pounded in a mortar to make an emulsion; and must thereby undergo the same changes as those matters; that is, their oily parts, being attenuated by those motions, must be mixed with and lodged between the aqueous parts, but not dissolved therein; because they do not, in the bodies of animals, meet with saline matters, sufficiently disentangled and active, to unite intimately with them, and by that means render them soluble in water.

Nevertheless, chyle and milk, though produced in the same manner as emulsions, and very much resembling them, differ greatly from them in some respects; owing chiefly to the time they remain in the bodies of animals, their being heated while there, the elaborations they undergo therein, and the animal juices commixed with them.

New milk hath a mild agreeable taste, without any saline pungency; nor hath any chemical trial discovered in it either an acid or an alkali. Yet it is certain, that the juices of plants, out of which milk is formed, contain many saline matters, and especially acids: accordingly milk also contains the same; but the acids are so sheathed and combined, that they are not perceptible. The case

is.

is the same with all the other liquors intended to constitute part of an animal body: there is no perceptible acid in any of them.

Hence it may be inferred, that one of the principal changes which vegetables undergo, in order to their being converted into an animal substance, consists in this, that their acids are combined, entangled, and sheathed in such a manner, that they become imperceptible, and exert none of their properties.

Milk left to itself, without the help of distillation, or any additament whatever, undergoes a sort of decomposition. It runs into a kind of spontaneous analysis; which doth not indeed reduce it to its first principles, yet separates it into three distinct substances, as the process shews; namely, into cream, or the buttery fat part, into curd or cheese, and into serum or whey: which shews, that those three substances of which milk consists, are only mixed and blended together, but not intimately united.

The first parts, being the lightest, rise gradually to the surface of the liquor as they separate from the rest: and this forms the cream.

Cream, as skimmed from the surface of milk, is not however the pure buttery or fat part; it is still mixed with many particles of cheese and whey, which must be separated in order to reduce it into butter. The most simple, and at the same time the best method of effecting this, is daily practised by the country people. It consists in beating or churning the cream, in a vessel contrived for that purpose, with the flat side of a circular piece of wood, in the centre of which a staff is fixed. One would think that the motion, impressed one the cream by this instrument, should rather serve to blend more intimately the particles of butter, cheese, and whey, of which it consists, than to separate them from each other; as this motion seems perfectly adapted to divide and attenuate those particles. But, if we consider what passes on this occasion, we shall soon perceive that the motion by which butter is churned is nothing like triture: for churning is no other, properly speaking, than a continually repeated compression, the effect whereof is to squeeze out from amongst the buttery particles those of cheese and whey mixed therewith; by which means the particles of butter are brought into contact with each other; unite, and adhere together.

Milk, whether skimmed or no, grows sour of itself, and curdles in a few days. When it is newly curdled, the cheese and whey seem to be united, and to make but one mass: but these two matters separate spontaneously from each other, with the greatest ease, and in a very short time.

The acidity, which milk naturally contracts in the space of a few days, must be considered as the effect of a fermenting motion, which discovers in that liquor an acid that was not perceptible before. This, properly speaking, is an acetous fermentation, which milk passes through in its way to putrefaction; and it soon follows, especially if the milk be exposed to a hot air.

If, instead of leaving milk to grow sour and curdle of itself, an acid be mixed therewith, while it is yet sweet and newly milked, it immediately coagulates; which

gives reason to think, that its curdling naturally is the effect of the acid, which discovers itself therein as it grows stale.

The coagulation of milk may also be considerably accelerated, by setting it in a sand-bath gently heated; or by mixing therewith a little of what, in the language of the dairy, is called *runnet*; which is nothing but some curdled and half-digested milk taken from the stomach of a calf: or both these methods may be employed at once, which will produce the effect still more expeditiously.

It is not difficult to find out the cause of these effects. The runnet, which is milk already curdled and grown sour, is an actual ferment to sweet milk, disposing it to turn sour much more readily: for though milk, when thus hastily curdled by the runnet, hath not a manifestly acid taste, yet it is certain that this acid begins to exert itself. The proof thereof is, that, being exposed to the same degree of heat with milk equally new, that is not mixed with this ferment, it turns sour much sooner. As to the effect of heat in coagulating milk, there is nothing extraordinary in it: we know how much it promotes and accelerates all fermentative motion. The whole of this perfectly agrees with what we said before concerning fermentation.

Fixed alkalis also coagulate milk; but at the same time they separate the whey from the cheese, which floats on the liquor in cloats. They give the milk a russet colour inclining to red; which may arise from their attacking the fat part.

The separation of milk into butter, cheese, and whey, is a kind of imperfect analysis thereof, or rather the beginning of one. In order to render it complete, we must examine each of these substances separately, and find the principles of which they consist. This we shall endeavour to do in the following process.

#### *Butter analysed by Distillation.*

INTO a glass retort put the quantity of fresh butter you intend to distil. Set the retort in a reverberatory; apply a receiver; and let your fire be very gentle at first. The butter will melt, and there will come over some drops of clear water, which will have the peculiar smell of fresh butter, and shew some tokens of acidity. If the fire be increased a little, the butter will seem to boil: a froth will gather on its surface, and the phlegm, still continuing to run, will gradually come to smell just like butter clarified in order to be preserved. Its acidity will be stronger and more manifest than that of the first drops that came over.

Soon after this, by increasing the fire a little more, there will rise an oil, having nearly the same degree of fluidity as fat oils; but it will grow thicker as the distillation advances, and at last will fix in the receiver when it cools. It will be accompanied with some drops of liquor, the acidity whereof will always increase, while its quantity decreases, as the distillation advances.

While this thick oil is distilling, the butter contained in the retort, which at first seemed to boil, will be calm and smooth, without the least appearance of ebullition; though the heat be then much greater than when it boiled. Continue the distillation, constantly increasing the fire

fire by degrees as you find it necessary for the elevation of the thick oil. This oil, or rather this kind of butter, will be at last of a russet colour. There will rise along with it some white vapours exceeding sharp and pungent.

When you observe that nothing more comes over, though the retort be quite red-hot, let the vessels cool, and unlute them. You will find in the receiver an aqueous acid liquor, a fluid oil, and a kind of fixed brown butter. Break the retort, and you will find therein a kind of charred matter; the surface of which, where it touched the glass, will be of a shining black, and have a fine polish.

The analysis of butter proves, that this substance, which is an oily matter in a concrete form, owes its consistence to the acid only, with which the oily part is combined: that is, it follows the general rule frequently mentioned above in treating of other oily compounds; the consistence whereof we shewed to be so much the firmer, the more acid they contain. The first portions of oil that come over in the distillation of butter are fluid, because a pretty considerable quantity of acid rose before them, which, being mixed with the phlegm, gives it the acidity we took notice of.

This oil, being freed from its acid, and by that means rendered fluid, rises first; because it is by the same means rendered lighter. The kind of butter that comes over afterwards, though it be fixed, is nevertheless far from having the same consistence as it had before distillation; because it loses much of its acid in the operation. This acid is what rises in the form of white vapours. These vapours are at least as pungent and irritating as the sulphureous acid or volatile alkalis: but their smell is different: it hath a resemblance, or rather is the same, with that which rises from butter when it is burnt and browned in an open vessel. But, when concentrated and collected in close vessels, as in the distillation of butter, they are vastly stronger: they irritate the throat so as to inflame it; they are exceeding sharp and pungent to the smell, and are so hurtful to the eyes that they quickly inflame them, as in an ophthalmy, and and make them shed abundance of tears. The great volatility of this acid is entirely owing to a portion of the phlogiston of the butter with which it is still combined.

We took notice in the process, that butter seems to boil with a very moderate heat at the beginning of the distillation, and that in the course of the operation the ebullition ceases entirely, though the heat be then greatly increased; which is contrary to the general rule. The reason is, that butter, though a seemingly homogeneous mass, contains nevertheless some particles of cheese and whey. The particles of whey, being much the lightest, endeavour, on the first application of heat, to extricate themselves from amongst the particles of butter, and to rise in distillation. Thus they form the drops of acidulated phlegm which come over at first, and, in struggling to get free, lift up the buttery parts, or actually boil, which occasions the ebullition observable at the beginning of the process. When they are once separated, the melted butter remains calm and smooth, without boiling. If you want to make it boil, you must apply a much greater degree of heat; which you cannot do in close

vessels, without spoiling the whole operation: because the degree of heat necessary for that purpose would force up the butter in substance, which would rush over into the receiver, without any decomposition. Indeed if the vessels were luted, they would be in danger of bursting.

As to the caseous parts, which are mixed with fresh butter, they also separate at the beginning of the distillation when the butter is melted, and gather on its surface in a scum. These particles of cheese and whey, which are heterogeneous to butter, help to make it spoil the sooner. And for this reason, those who want to keep butter a long time, without the use of salt, melt it, and thereby evaporate the aqueous parts. The lightest portion of the particles of cheese rises to the surface, and is skimmed off; the rest remains at the bottom of the vessel, from which the butter is easily separated, by decanting it while it is yet fluid.

Butter may also be distilled, by incorporating it with some additament which will yield no principle itself, nor retain any of those of the butter. It may be distilled in this manner with the additament of fine sand: the operation succeeds very well, is sooner finished, and more easily conducted.

If you desire to convert the butter wholly into oil, you must take the fixed matter you find in the receiver, and distil it once more, or oftener, according to the degree of fluidity you want to give it. The case is the same with this matter as with all other thick oils, which, the oftener they are distilled, grow always the more fluid, because in every distillation they are separated from part of the acid, to which alone they owe their consistence.

#### *The Curd of Milk analysed by Distillation.*

INTO a glass retort put some new curd having first drained it thoroughly of all its whey, and even squeezed it in a linen cloth to express all its moisture. Distil it as you did butter. There will come over at first an acidulated phlegm, smelling like cheese or whey. As the distillation advances, the acidity of this phlegm will increase.

When it begins to run but very slowly, raise your fire. There will come over a yellow oil, somewhat empyreumatic. Continue the distillation, still increasing the fire by degrees as occasion requires. The oil and acid phlegm will continue to rise; the phlegm growing gradually more acid, and the oil deeper coloured and more empyreumatic. At last, when the retort is almost red-hot, there comes off a second black oil, of the consistence of turpentine, very empyreumatic, and so heavy as to sink in water. In the retort will be left a considerable quantity of charred matter.

Cheese-curd barely drained, till no more whey will drip from it, is not entirely freed thereof; and for this reason we directed it to be pressed in a linen cloth, before it be put into the retort to be distilled. Without this precaution, the remaining whey would rise in a considerable quantity on the first application of heat; and, instead of analysing the curd only, we should at the same time analyse the whey also. This is to be understood of green curd and new-made cheese; for, if it be suffered to grow

old, it will at length dry of itself: but then we should not obtain from it the same principles by distillation; as it corrupts and begins to grow putrid after some time, especially if it be not mixed with some seasoning to preserve it.

The first phlegm that rises in this distillation, as in that of butter, is a portion of the whey that was left in the cheese, notwithstanding its being well pressed. This phlegm grows gradually more acid, being the vehicle of the acids of the cheese, which are forced up along with it by the fire.

The acid obtained from this matter is less in quantity, and weaker, than that of butter: and accordingly the oil distilled from cheese is not fixed like that of butter. Yet it is remarkable that the last empyreumatic oil, which is as thick as turpentine, is heavier than water: a property which it probably derives from the quantity of acid it retains.

The quantity of charred matter, which remains in the retort after the distillation of cheese, is much greater than that left by butter: which proves that the former contains a much greater quantity of earth.

#### *Whey analysed.*

EVAPORATE two or three quarts of whey almost to dryness in a *balneum marie*; and distil the extract or residuum in a retort set in a reverberating furnace, with degrees of fire, according to the general rule. At first some phlegm will come over; then a lemon-coloured acid spirit; and afterwards a pretty thick oil. There will remain in the retort a charred matter, which being exposed to the air grows moist. Lixivate it with rain water, and evaporate the lixivium; it will yield you crystals of sea-salt. Dry the charred matter, and burn it in the open air with a strong fire, till it be reduced into ashes. A lixivium of these ashes will shew some tokens of a fixed alkali.

It will appear, on examining the three analyses of the substances whereof milk consists, that none of them yields a volatile alkali: which is worthy of notice; as it is the only animal matter from which such a salt cannot be obtained. It is true, the milk of animals that feed on vegetables may be considered as an intermediate liquor between vegetable and animal substances; as an imperfect animal-juice, which still retains much of the vegetable nature: and we actually find, that milk almost always hath, at least in part, the properties of those plants with which the animals that yield it are fed. Yet, as it cannot be formed in the body of the animal, without mixing with several of its juices that are entirely perfected, and become purely animal, it must appear strange that the analysis thereof should not afford the least vestige of that principle, which all other animal-matters yield in the greatest plenty.

The reason of this may be found in the use to which milk is destined. It is intended for the nourishment of animals of the same species with those in whose bodies it is produced. Consequently it ought as much as possible to resemble the juices of the food which is proper for those animals. Now, as animals that live only on

vegetables could not be properly nourished by animal matters, for which nature itself hath even given them an aversion, it is not surprising that the milk of such animals should be free from any mixture of such things as are unsuitable to the young ones whom it is designed to nourish. There is reason therefore to think, that nature hath disposed the organs in which the secretion of milk is performed, so as to separate it entirely from all the animal juices first mixed with it: and this is the principal difference between milk and chyle; the latter being necessarily blended with the saliva, the gastric and pancreatic juices, the bile and lymph, of the animals in which it is formed. Hence it may be concluded, that, if a quantity of chyle could be collected sufficient to enable us to analyse it, the analysis thereof would differ from that of milk, in this chiefly, that it would yield a great deal of volatile alkali, of which milk, as hath been said, yields none at all.

The same thing probably takes place in carnivorous animals. It is certain, that those animals chuse to eat the flesh of such others only as feed upon vegetables; and that nothing but extreme hunger, and the absolute want of more agreeable food, will force them to eat the flesh of other carnivorous animals. Wolves, which greedily devour sheep, goats, &c. seldom eat foxes, cats, polecats, &c. though these animals are not strong enough to resist them. Foxes, cats, and birds of prey, that make such terrible havoc among wild-fowl, and other sorts of game, do not devour one another. This being laid down, there is reason to think, that the milk of carnivorous animals is something of the nature of the flesh of those animals that feed on vegetables, and which they chuse to eat, and not of the nature of their own flesh; as the milk of animals that feed on vegetables is analogous to the juices of vegetables, and when analysed yields no volatile alkali, though every other part of their body does.

But whatever be the nature of milk, and of whatever ingredients it be formed, it always contains the three several substances above mentioned; namely, the fat, or buttery part, properly so called, the cheesy, and the ferrous part, the last of which we are now to examine. It is, properly speaking, the phlegm of the milk, and consists almost entirely of water. For this reason it is proper to lessen the quantity thereof considerably by evaporation, so that its other principles, being concentrated and brought nearer together, may become much more sensible. There is no danger of losing any essential part of the whey in the evaporation, if it be performed in the *balneum marie* with such a gentle heat as may carry off the aqueous parts only: this greatly shortens the analysis, which will be exceeding long and tedious if all the water be distilled off in close vessels.

As whey is chiefly the aqueous part of milk, as said above, it must contain all the principles thereof that are soluble in water; that is, its saline and saponaceous parts. And accordingly the analysis thereof shews that it contains an oil, rendered perfectly saponaceous by an acid; that is, made perfectly miscible with water. This quality of the oil contained in whey appears from the perfect transparency of that liquor, which we know is  
the



the mark of a complete dissolution. In the distillation of whey, the saponaceous matter contained therein is decomposed; the saline part rises first, as being the lightest; this is the acid taken notice of in the process; after which the oil, now separated from the principle which rendered it miscible with water, comes over in its natural form, and doth not afterwards mix with the aqueous part.

Besides the saponaceous matter, whey contains also another saline substance; namely, sea-salt: this is obtained by lixiviating the *caput mortuum* left in the retort, which, because of its fixedness, cannot rise with the other principles in distillation. To this salt it is owing that what remains in the retort after distillation grows moist in the air; for we know that sea-salt thoroughly dried hath this property.

The fixed alkaline salt, obtained from the *caput mortuum* burnt to ashes, proves that milk still retains something of the vegetable nature: for the following analysis will shew us that matters purely animal yield none at all.

#### *Of the Substances which compose an Animal Body.*

##### *Blood analysed. Instanced in Bullock's Blood.*

In a *balneum marie* evaporate all the moisture of the blood that the heat of boiling water will carry off. There will remain an almost dry matter. Put this dried blood into a glass retort, and distil with degrees of heat, till nothing more will come over, even when the retort is quite red-hot, and ready to melt. A brownish phlegm will rise at first: this will soon be impregnated with a little volatile alkali, and then will come over a yellow oil, a very pungent volatile spirit, a volatile salt in a concrete form, which will adhere to the sides of the receiver; and, at last, a black oil, as thick as pitch. There will be left in the retort a charred matter, which being burnt yields no fixed alkali.

Blood, which is carried by the circulation into all the parts of the animal body, and furnishes the matter of all the secretions, must be considered as a liquor consisting of almost all the fluids necessary to the animal machine: so that the analysis thereof is a sort of general though imperfect analysis of an animal.

Blood drawn from the body of an animal, and set by in a vessel, coagulates as it grows cold; and sometimes afterwards the *coagulum* discharges a yellowish *serum* or lymph; and in the midst thereof swims the red part, which continues curdled. These two substances, when analysed, yield nearly the same principles; and in that respect seem to differ little from each other. Though the serum of blood be naturally in a fluid form, yet it hath also a great tendency to coagulate; and a certain degree of heat applied to it, either by water or by a naked fire, will curdle it. Spirit of wine mixed with this liquor produces on it the same effect as heat.

Blood, while circulating in the body of a healthy animal, and when newly taken from it, hath a mild taste, which discovers nothing like either an acid or an alkali; nor doth it shew any sign of either the one or the other

in chemical trials. When tasted with attention, it betrays something like a flavour of sea-salt; because it actually contains a little thereof, which is found in the charred matter left in the retort after the distillation, when carefully examined.

We shewed that milk also contains a little of this salt. It enters the bodies of animals with the food they eat; which contains more or less thereof according to its nature. It plainly suffers no alteration by undergoing the digestions, and passing through the strainers, of the animal body. The case is the same with the other neutral salts which have a fixed alkali for their basis: we find them unchanged in the juices of animals into whose bodies they have been introduced. They are incapable of combining, as acids do, with the oily parts; and so are dissolved by the aqueous fluids, of which nature makes use to free herself from those salts, and discharge them out of the body.

Blood, like all other animal-matters, is, properly speaking, susceptible of no fermentation but that of putrefaction. Yet it turns somewhat sour before it putrefies. This small degree of acetous fermentation is most sensible in flesh; and especially in the flesh of young animals, such as calves, lambs, chickens, &c.

The quantity of pure water, which blood, in its natural state, contains, is very considerable, and makes almost seven eighths thereof. If it be distilled, without being first dried, the operation will be much longer; because it will be necessary to draw off all this insipid phlegm with a gentle fire. There is no reason to apprehend that, by drying blood in open vessels as directed, any of its other principles will be carried off with its phlegm: for it contains no other substance that is volatile enough to rise with the warmth of a *balneum marie*. This may be proved by putting some undried blood into a glass cucurbit, fitting thereto a head and receiver, and distilling, in a *balneum marie*, all that the heat of the bath, not exceeding the heat of boiling water, will raise: for, when nothing more will come over, you will find in the receiver an insipid phlegm only, scarce differing from pure water, except in having a faint smell like that of blood; wherein it resembles all the phlegms that rise first in distillation, which always retain something of the smell of the matters from which they were drawn. That part of the blood, which remains in the cucurbit after this first distillation, being put into a retort, and distilled with a stronger fire, yields exactly the same principles, and in the same proportion, as blood dried in open vessels in the *balneum marie*: so that, if this phlegm of blood contains any principles, the quantity thereof is so small as to be scarce perceptible.

The volatile alkali that rises with the oil, when blood is distilled in a retort with a degree of heat greater than that of boiling water, is either the production of the fire, or arises from the decomposition of an ammoniacal salt of which it made a part. For we shall see, when we come to treat of this saline substance, that it is so extremely volatile as to exceed, in that respect, almost all other bodies that we know: and therefore if this volatile alkali pre-existed formerly in the blood, uncombined with any other matter capable, in some measure,

of

of fixing it, it would rise at first almost spontaneously, or at least on the first application of the gentlest heat. We have an instance of this in blood, or any other animal-matter, that is perfectly putrefied; which containing a volatile alkali, either formed or extricated by putrefaction, lets go this principle when distilled, even before the first phlegm: and, for this reason, when putrefied blood is to be analysed, it must by no means be dried, like fresh blood, before distillation; for all the volatile alkali would by that means be dissipated and lost at once.

Though blood and other animal-matters afford no fixed alkali, but, on the contrary, yield much volatile alkali, it doth not therefore follow that all the acid, which those substances contained before they were analysed, is employed in the production of a volatile alkali.

*Flesh analysed. Instanced in Beef.*

INTO an alembic or retort, placed in a sand-bath, put some lean beef, from which you have carefully separated all the fat. Distil till nothing more will rise. In this first distillation a phlegm will come over, weighing at least half the mass of the distilled flesh. In the retort you will find a matter almost dry, which you must afterwards distil with a naked fire in a reverberating furnace, taking the usual precautions. There will come over at first a little phlegm replete with volatile alkali; then a volatile alkali in a dry form, which will stick to the sides of the vessel; and also a thick oil. After the distillation there will be left in the retort a black, shining, light coal. Burn it to ashes in the open air, and lixiviate those ashes: the water of the lixivium will have no alkaline property, but will shew some tokens of its containing a little sea-salt.

The flesh of an animal, as appears from the process, yields much the same principles with its blood: and it cannot be otherwise; because it is formed altogether of materials furnished by the blood.

*Bones analysed. Instanced in Ox-Bones.*

CUT into pieces the bones of a leg of beef, carefully separating all the marrow. Put them into a retort, and distil them in a reverberating furnace as usual. A phlegm will come over first; then a volatile spirit, which will become stronger and stronger; afterwards a volatile salt in a dry form, with some oil; and, lastly, a black oil, with a little more volatile salt. There will be left in the retort a charred matter, from which a little sea-salt may be extracted. Reduce this charred matter to ashes, by burning it in the open air. These ashes will give some slight tokens of a fixed alkali.

The analysis of bones proves, that they consist of the same principles with flesh and blood; and the same may be said in general of all matters that are truly animal, that actually constitute any part of an animal.

*Animal Fat Analysed. Instanced in Mutton-Suet.*

PUT as much mutton-suet as you please into a glass retort, only taking care that the vessel be but half full; and distil with degrees of fire as usual. A phlegm smel-

ling of the suet will rise first, and soon grow very acid. After this some drops of oil will come over, and be followed by a matter like oil, in appearance, when it comes over; but it will fix in the receiver, and acquire a consistence somewhat softer than suet. This kind of butter of suet will continue to rise to the end of the distillation; and there will be left in the retort a small quantity of charred matter.

*Eggs analysed. Instanced in Pullet's Eggs.*

PUT some hens eggs in water, and boil them till they be hard. Then separate the yolks from the whites. Cut the whites into little bits; put them into a glass cucurbit; fit on a head and receiver; distil in a *balneum marie* with degrees of fire, raising it towards the end to the strongest heat which that bath can give; that is, to the heat of boiling water. There will come over an aqueous liquor, or insipid phlegm; the quantity whereof will be very considerable, seeing it will make about nine tenths of the whole mass of the whites of the eggs. Continue your distillation, and keep the water in the bath constantly boiling, till not a drop more of liquor will ascend from the alembic. Then unlute your vessels. In the cucurbit you will find your whites of eggs considerably shrunk in their bulk. They will look like little bits of brown glass, and be hard and brittle.

Put this residuum into a glass retort, and distil, as usual, in a reverberating furnace with degrees of heat. There will come over a volatile oily spirit, a yellow oil, a volatile salt in a dry form, and, at last, a black thick oil. There will be left in the retort a charred matter.

Reduce also into the smallest pieces you can the hard yolks of the eggs which you separated from the whites. Set them in a pan over a gentle fire: stir them with a stick till they turn a little brown, and discharge a substance like melted marrow. Then put them into a new, strong, canvas bag, and press them between two iron plates well heated; whereby you will obtain a considerable quantity of a yellow oil.

Let what remains in the bag be distilled in a retort set in a reverberating furnace: it will give you the same principles as you got from the whites.

Of the two perfectly distinct substances that constitute the egg, the yolk contains the embryo of the chick, and is destined to hatch it: the white is to serve for the nourishment of the chick when it is formed.

These two matters, though they contain the very same principles, yet differ considerably from each other; and chiefly in this, that their principles are not in the same proportions.

The white of an egg contains so much phlegm, that it seems to consist almost totally thereof. All the aqueous liquor, obtained by distilling it in the *balneum marie*, is, properly speaking, nothing but pure water; for no chemical trial can discover in it either an acid or a volatile alkali; or any very perceptible oily part. And yet it must contain some oil, because the liquor that rises last is a little bitterish to the taste, and smells somewhat of empyreuma. But the principles from which it derives these properties are in too small quantities to be distinctly perceived.

If, instead of distilling the hard white of an egg, with a view to draw off the great quantity of water it contains, you leave it some time in an air that is not too dry, the greatest part of its moisture separates spontaneously, and becomes very sensible. In all probability this is the effect of a beginning putrefaction, which attenuates this substance, and breaks its contexture. The liquor thus discharged by the white of an egg thoroughly dissolves the gum-resins, and particularly myrrh. If you desire to dissolve myrrh in this manner, cut a hard-boiled egg in halves; take out the yolk; put the powdered gum-resin into the cavity left by the yolk; join the two halves of the white; fasten them together with a thread, and hang them up in a cellar. In a few days time the myrrh will be dissolved by the moisture that issues from the white of the egg, and will drop into the vessel placed underneath to receive it. This liquor is improperly called *oil of myrrh per deliquium*.

All the properties of the whites of eggs, as well as the principles obtained by analysing them, are the same with those of the lymphatic part of the blood; so that there is a great resemblance between these two substances.

As to the yolk, it is plain from its analysis, that oil is the predominant principle thereof. If the yolk of an egg be mixed with water, the oil with which it is replete, and which is by nature very minutely divided, diffuses easily through the whole liquor, and remains suspended therein by means of its viscosity. The liquor at the same time becomes milk-white like an emulsion, and is in fact a true animal emulsion.

In order to obtain the oil of eggs by expression with the more ease, care must be taken to chuse eggs that are seven or eight days old; because they are then a little less viscous. Nevertheless their viscosity is still so great, that they will not easily yield their oil by expression: and therefore, in order to attenuate and destroy entirely this viscosity, they must be torrefied before they are put to be pressed.

The oil of eggs, like all other oily animal matters, seems analogous to the fat oils of vegetables. It hath all the properties that characterise those oils. Its colour is yellow, and it smells and tastes a little of the empyreuma, occasioned by torrefying the yolks. It is rendered somewhat less disagreeable by being exposed to the dew for thirty or forty nights, if care be taken to stir it often in the mean time.

To conclude: all the principles both in the yolk and the white of an egg are the same as those found in blood, flesh, and all other matters that are perfectly animal.

### *Of the Excrements of Animals.*

*Dung analysed. Instanced in human Excrements.  
Mr Homberg's Phosphorus.*

TAKE any quantity you please of human excrement, and distil it in a glass alembic set in the *balneum marie*. You will obtain an aqueous, clear, insipid liquor; which will nevertheless have a disagreeable odour. Having urged the distillation as far as is possible with the heat of

VOL. II. No. 37.

this bath, unlute your vessels, and you will find at the bottom of the cucurbit a dry matter, making about an eighth part only of what you put into it. Put this residuum into a glass retort, and distil in a reverberating furnace, with degrees of heat. You will obtain a volatile spirit, and a volatile salt, with a fetid oil; and a charred matter will be left in the retort.

This substance, consisting of matters subject to putrefaction, hath constantly a fetid smell, like that of all putrid matters; having been for some time confined in a warm, moist place, which we know promotes putrefaction, and even quickly produces it. Yet the analysis thereof proves that it is not putrefied, or at least not entirely so: for all putrefied matters contain a volatile alkali perfectly formed and extricated; and, as this principle rises with less heat than that of boiling water, it always comes over first in distillation. Now we have seen that, with the heat of boiling water, it parts with nothing but an insipid phlegm, containing no volatile alkali: a sure proof that the fecal matter is not completely putrefied.

One of the methods by which Mr Homberg endeavoured to obtain from excrement a clear oil, without any bad smell, was to separate its earthy and gross parts, by filtering it before he distilled it. "For this purpose he diluted excrement newly discharged with hot water, using a quart of water to an ounce of feces. Then he let the mixture stand to cool, and the gross parts falling to the bottom, he poured off the water by inclination. This liquor he filtered through brown paper, and evaporated to a pellicle over a gentle fire. There shot in it long crystals of four, five, and six sides, which Mr Homberg thinks may be called the essential salt of excrement. They resemble salt-petre, in some measure, and desflagrate in the fire much like it; with this difference, that their flame is red, and they burn slowly; whereas the flame of salt-petre is white and very vivid: probably, says Mr Homberg, because there is too much of an oily matter in the one, and less in the other.

"Mr Homberg distilled this salt in a glass retort with degrees of fire, and at last with a very violent one. At first there came over an aqueous liquor, sharp and acid, which was followed by a brown fetid oil, smelling very strong of empyreuma. This distillation he attempted four several times; and each time the matter in the retort took fire, just when the oil began to come off."

The salt which Mr Homberg obtained from excrement is very remarkable. Its nitrous character is by no means ambiguous: its desflagrating on live coals convinced Mr Homberg of its being a true nitre. But its constantly taking fire in the retort, as oft as distilled, is a sure proof that it is a nitrous salt: for nitre only hath the property of thus taking fire in close vessels, and making other combustible matters burn along with it.

The process, by which Mr Homberg at last obtained from excrement a clear oil without any bad smell, is curious, and worthy of a place here, on account of the views and occasions of reflection which it may open.

"Mr Homberg having tried in vain, by distilling excrement a great many different ways, to obtain from it such an oil as he wanted, resolved to employ fermentation,

†

2.Y

tion,

tion, the effect whereof is to change the disposition of the principles of mixts. With this view he dried some excrement in the water-bath, and, having pulverised it, poured thereon six times its weight of phlegm that had been separated from it by distillation, and put the whole into a large glass cucurbit, covered with an inverted vessel that fitted exactly into it, and was close luted. This vessel he set in a *balneum marie* for six weeks, keeping up such a gentle heat as would not burn one's hand; after which he uncovered the cucurbit, and having fitted thereto a head and a receiver, distilled off all the aqueous moisture in the *balneum marie* with a very gentle heat. It had now lost almost all its bad smell, which was changed into a faint one. It came over somewhat turbid, whereas it was very clear when put into the cucurbit. Mr Homberg found this water to have a cosmetic virtue: he gave some of it to persons whose complexion, neck, and arms, were quite spoiled, being turned brown, dry, rough, and like a goose skin: they washed with it once a day, and, by continuing the use of this water, their skin became very soft and white.

"The dry matter left in the cucurbit after the first distillation, had not the least smell of feces: on the contrary, it had an agreeable aromatic odour; and the vessel in which Mr Homberg had digested it, being left open in a corner of his laboratory, acquired in time a strong smell of ambergris. It is surprising, as Mr Homberg justly observes, that digestion alone should change the abominable smell of excrement into an odour as agreeable as that of ambergris.

"This dry matter he powdered coarsely, and put two ounces thereof at once into a glass retort that would hold about a pound or a pound and a half of water. This he distilled in a sand-bath with a very gentle heat. A small quantity of an aqueous liquor came over first, and then an oil as colourless as spring-water. Mr Homberg continued the same gentle degree of heat till the drops began to come off a little redish; and then he changed the receiver, stopping that which contained the clear oil very close with a cork. Having carried on the distillation with a fire gradually augmented, there came over a considerable quantity of red oil; and there remained in the retort a charred matter which burnt very readily."

The clear oil, without any ill smell, which Mr Homberg obtained from the fecal matter by this process, was the very thing he was in search of, and which he had been assured would convert mercury into fine fixed silver; yet he ingenuously owns, that, whatever way he applied it he could never produce any change in that metallic substance. We shall now proceed to the other discoveries made by Mr Homberg on this occasion.

In his attempt to obtain a clear oil from excrement, he distilled it with different additaments, and amongst the rest with vitriol and alum. He found that the matters left in the retort, when he made use of these salts, being exposed to the open air, took fire of themselves; that they kindled combustible matters; in a word, that they were a true phosphorus, of a species different from all then known. Pursuing these first hints, he sought and found the means of preparing this phosphorus by a way

much more expeditious, certain, and easy. His process is this.

"Take four ounces of feces newly excreted: mix therewith an equal weight of roch alum coarsely powdered: put the whole into a little iron pan that will hold about a quart of water, and set it over a gentle fire under a chimney. The mixture will melt, and become as liquid as water. Let it boil with a gentle fire, constantly stirring it, breaking it into little crumbs, and scraping off with a spatula whatever sticks to the bottom or sides of the pan, till it be perfectly dry. The pan must from time to time be removed from the fire, that it may not grow red hot; and the matter must be stirred, even while it is off the fire, to prevent too much of it from sticking to the pan. When the matter is perfectly dried, and in little clots, let it cool, and powder it in a metal mortar. Then put it again into the pan, set it over the fire and stir it continually. It will again grow a little moist, and adhere together in clots, which must be continually roasted and bruised till they be perfectly dry; after which they must be suffered to cool, and then be pulverised. This powder must be returned a third time to the pan, set on the fire, roasted, and perfectly dried; after which it must be reduced to a fine powder, and kept in a paper in a dry place. This is the first or preparatory operation.

"Take two or three drams of this powder. Put it into a little matras, the belly of which will hold an ounce, or an ounce and half of water, and having a neck about six or seven inches long. Order it so that your powder shall take up no more than about a third part of the matras. Stop the neck of the matras slightly with paper: then take a crucible four or five inches deep: in the bottom of the crucible put three or four spoonfulls of sand: set the matras on this sand, and in the middle of the crucible, so as not to touch its sides. Then fill up the crucible with sand, so that the belly of the matras may be quite buried therein. This done, place your crucible with the matras in the midst of a little earthen furnace, commonly called a *fove*, about eight or ten inches wide above, and six inches deep from the mouth to the grate. Round the crucible put lighted coals about half way up, and when it hath stood thus half an hour, fill up with coals to the very top of the crucible. Keep up this fire a full half hour longer, or till you see the inside of the matras begin to be red. Then increase your fire, by raising your coals above the crucible. Continue this strong heat for a full hour, and then let the fire go out.

"At the beginning of this operation dense fumes will rise out of the matras, through the stopple of paper. These fumes issue sometimes in such abundance as to push out the stopple; which you must then replace, and slacken the fire. The fumes cease when the inside of the matras begins to grow red: and then you may increase the fire without any fear of spoiling your operation.

"When the crucible is so cold that it may be safely taken out of the furnace with one's hand, you must gradually draw the matras out of the sand, that it may cool slowly, and then stop it close with a cork.

"If the matter at the bottom of the matras appear to

be in powder when shaken, it is a sign the operation hath succeeded: but if it be in a cake, and doth not fall into powder on shaking the matras, it shews that your matter was not sufficiently roasted and dried in the iron pan during the preparatory operation."

Mr Lemerî hath shewn, that excrement is not the only matter capable of producing this phosphorus with alum; but that, on the contrary, almost all animal and even vegetable matters are fit for this combination; that though Mr Homberg mixed alum in equal quantities only with the fecal matter, it may be used in a much greater proportion, and, in certain cases, will succeed the better; that, according to the nature of the substances to be worked on, the quantity of that salt may be more or less increased; and that whatever is added, more than the dose requisite for each matter, serves only to lessen the virtue of the phosphorus, or even destroys it entirely; that the degree of fire applied must be different according to the nature of those matters; and, lastly, that salts containing exactly the same acid with that of alum, or the acid of those salts separated from its basis and reduced into spirit, do not answer in the present operation: which shews, says Mr Lemerî, that many sulphureous matters may be substituted for excrement in this operation: but that there are no salts, or very few, if any, that will succeed in the place of alum.

This phosphorus, made either by Mr Homberg's or by Mr Lemerî's method, shines both by day and by night. Besides emitting light, it takes fire soon after it is exposed to the air, and kindles all combustible matters with which it comes in contact; and this without being rubbed or heated.

Mess. Homberg and Lemerî have given the most probable and the most natural explanation of the cause of the accension and other phenomena of this phosphorus. What they say amounts in short to what follows.

Alum is known to be a neutral salt, consisting of the vitriolic acid and a calcareous earth. When this salt is calcined with the fecal matter, or other substances abounding in oil, the volatile principles of these substances, such as their phlegm, their salts, and their oils, exhale in the same manner as if they were distilled; and there is nothing left in the matras, when those principles are dissipated, but a charred matter, like that which is found in retorts wherein such mixts have been decomposed by distillation.

This remainder therefore is nothing but a mixture of alum and charcoal. Now, as the acid of this salt, which is the vitriolic, hath a greater affinity with the phlogiston than with any other substance, it will quit its basis to unite with the phlogiston of the coal, and be converted by that union into a sulphur. And this is the very case, of which we have certain proofs in the operation for preparing this phosphorus; for when, after the volatile principles of the oily matter are drawn off, the fire is increased, in order to combine closely together the fixed parts that remain in the matras, that is, the alum and the charred matter, we perceive at the mouth of the matras a small blue sulphureous flame, and a pungent smell of burning sulphur. Nay, when the operation is finish-

ed, we find a real sulphur sticking in the neck of the matras; and, while the phosphorus is burning, it hath plainly a strong sulphureous smell. It is therefore certain, that this phosphorus contains an actual sulphur; that is, a matter disposed to take fire with the greatest ease. But though sulphur be very inflammable, it never takes fire of itself, without being either in contact with some matter that is actually ignited, or else being exposed to a considerable degree of heat. Let us see then what may be the cause of its accension, when it is a constituent part of this phosphorus.

We mentioned just now, that the acid of the alum quits its basis, in order to form a sulphur by combining with the phlogiston of the coal. This basis we know to be an earth capable of being converted into lime; and that it is actually converted into quick-lime by the calcination necessary to produce the phosphorus. We know that new made lime hath the property of uniting with water so readily, that it thereby contracts a very great degree of heat. Now when this phosphorus, which is partly constituted of the basis of the alum converted into quick-lime, is exposed to the air, the lime instantly attracts the moisture of which the air is always full, and by this means, probably, grows so hot as to fire the sulphur with which it is mixed. Perhaps also the acid of the alum is not totally changed into sulphur: some part thereof may be only half-disengaged from its basis, and in that condition be capable of attracting strongly the humidity of the air, or growing very hot likewise by imbibing the moisture, and so of contributing to the accension of the phosphorus.

There is also room to think that all the phlogiston of the charred matter is not employed in the production of sulphur in this phosphorus, but that some part of it remains in the state of a true coal. The black colour of the unkindled phosphorus, and the red sparkles it emits while burning, sufficiently prove this.

#### *Human Urine analysed.*

Put some human urine into a glass alembic; set it in a water bath, and distil till there remain only about a fortieth part of what you put in; or else evaporate the urine in a pan set in the *balneum marie* till it be reduced to the same quantity. With this heat nothing will exhale but an insipid phlegm, smelling however like urine. The residuum will, as the evaporation advances, become of a darker and darker russet, and at last acquire an almost black colour. Mingle this residuum with thrice its weight of sand, and distil it in a retort set in a reverberating furnace, with the usual precautions. At first there will come over a little more insipid phlegm like the former. When the matter is almost dry, a volatile spirit will rise. After this spirit, white vapours will appear on increasing the fire; a yellow oily liquor will come off, trickling down in veins; and together with this liquor a concrete volatile salt, which will stick to the sides of the receiver. At last there will come over a deep-coloured fetid oil. In the retort there will remain a saline earthy residuum, which being lixiviated will yield some sea-

of

*Of the Volatile Alkali.**Volatile Alkalis rectified and depurated.*

Mix together the spirit, the volatile salt, the phlegm, and the oil, obtained from any substance whatever. Put the whole into a large wide-mouthed glass body, and thereto fit a head with a large beak. Set this alembic in a water-bath, lute on a receiver, and distil with a very gentle heat. There will ascend a spirit strongly impregnated with volatile alkali, and a volatile salt in a concrete form, which must be kept by itself. Then increase your heat to the degree of boiling water; whereupon there will rise a second volatile spirit, somewhat more ponderous than the former, with a light oil that will swim on its surface, and a little concrete volatile salt. Proceed till nothing more will rise with this degree of heat. Keep by itself what came over into the receiver. At the bottom of the cucurbit you will find a thick fetid oil.

Into such another distilling vessel put the spirit and salt that rose first in this distillation, and distil them in the *balneum marie* with a heat still gentler than before. A whiter, purer, volatile salt will sublime. Continue the distillation till an aqueous moisture rise, which will begin to dissolve the salt. At the bottom of the vessel will be left a phlegm, with a little oil floating on it. Keep your salt in a bottle well stopped.

*Volatile Alkalis combined with Acids. Sundry Ammoniacal Salts. Sal Ammoniac.*

On a volatile spirit or salt pour gradually any acid whatever. An effervescence will arise, and be more or less violent according to the nature of the acid. Go on adding more acid in the same manner, till no effervescence be thereby excited, or at least till it be very small. The liquor will now contain a semi-volatile neutral salt, called an *ammoniacal salt*; which may be obtained in a dry form by crystallising as usual, or by subliming it in close vessels; after the superfluous moisture hath been drawn off.

Volatile alkalis have the same properties with fixed alkalis, fixity only excepted: so that a volatile alkali must produce an effervescence when mixed with acids, and form therewith neutral salts, differing from each other in nothing but the nature of the acid in their composition.

It must be observed, that the point of saturation is very difficult to hit on this occasion; owing probably to the volatility of the alkali, which, being much lighter than the acid, tends always to possess the uppermost part of the mixture, while the acid sinks to the bottom: whence it comes to pass, that the lower part of the liquor is sometimes overcharged with acid, while the upper part is still very alkaline. But it is most eligible that the alkali should predominate in the mixture; because the excess of this principle easily flies off while the moisture is evaporating in order to the crystallisation or sublimation of the ammoniacal salt; which being only semi-volatile, resists the heat longer, and remains perfectly neutral.

If the vitriolic acid be combined with a volatile alkali, and the mixture distilled in a retort to draw off the su-

perfluous moisture, a liquor comes over into the receiver which smells strong of a sulphureous acid. Now, as the acid of vitriol never becomes sulphureous, but when it is combined with an inflammable matter, this experiment is one of those which demonstrate that volatile alkalis contain a very sensible quantity of inflammable matter. This same liquor tastes of an ammoniacal salt; which proves that it carries up with it some of the neutral salt contained in the mixture. The rest of this salt, which is called *Glauber's secret sal ammoniac*, or *vitriolic sal ammoniac*, sublimes into the neck of the retort. It is very pungent on the tongue; it crackles a little when thrown on a red-hot shovel, and then flies off in vapours.

The ammoniacal salt formed by the acid of nitre exhibits much the same phenomena; but it requires greater care in drying and subliming it, because it hath the property of detonating all alone, without the addition of any other inflammable matter: and it will infallibly do so, if too strong a fire be applied towards the end of the operation, when it begins to be very dry. This property of detonating by itself it derives from the inflammable matter contained in the volatile alkali which serves for its basis: and this is another demonstrative proof of the existence of such an inflammable matter in the volatile alkali. This salt is called *nitrous ammoniacal salt*.

With the vegetable acids, that of vinegar for instance, is formed an ammoniacal salt of a singular nature, and which can scarce be brought to a dry form.

A volatile alkali, combined to the point of saturation with the acid of sea-salt, forms another neutral salt, which takes a concrete form either by sublimation or crystallisation. The crystals of this salt are so very soft and fine, that a parcel of it looks like cotton or wool. This is the salt properly called *sal ammoniac*. It is of great use in chemistry and in manufactures; but that which is daily consumed in great quantities is not made in the manner above mentioned. It would come extremely dear, if we had no other way of procuring it, but by forming it thus with the acid of sea-salt and a volatile alkali. This salt, or at least the materials of which it is formed, may be found in the fuliginosities and soots of most animal, and of some vegetable substances. The greatest part of what we use comes from Egypt, where vast quantities thereof are made.

The method of preparing sal ammoniac in Egypt was not known among us till Mess. Lemaire and Granger. Their memoirs inform us, that chimney-foot alone, without any additament, is the matter from which they obtain their sal ammoniac; that those chimneys under which nothing is burnt but cow's-dung, furnish the best foot. Six and twenty pounds of that foot yield usually six pounds of sal ammoniac.

“ The operation takes up about fifty, or two and fifty hours. The vessels in which they put the foot are balloons of very thin glass, terminating in a neck of fifteen or sixteen lines long, and an inch in diameter: but they are not all of the same size. The least contain twelve pounds of foot, and the greatest fifty; but they fill them only three quarters full, in order to leave room for the sublimation of the salt.

“ The furnace, in which they place these balloons, consists

## A TABLE. Showing acids defined; and the manner in which they are obtained, pointed out.

powerful as a solvent of all the acids. Obtained chiefly from sulphur by inflammation. This acts less powerfully as a solvent than when in its first state. The next acid in strength to the vitriolic. Obtained chiefly from nitre.

Obtained from sea-salt.

, &c.

nted.

At the vinous state. All these vegetable acids are much less corrosive, and less powerful than the former.

little known.

ing sea-weed, as kelp, &c.  
It is naturally in a solid state.

ic.

wing table.

itated by art. Of this kind is sugar, manna, honey, and others of that sort.

expression; as, oil of olives, rapeseed, almonds, &c. Animal-fats are of the same

they are drawn, and are soluble in alcohol. Of this kind are oil of cloves, spike,

oil of hartshorn. These are soluble in spirit of wine.

ly volatile; not miscible with alcohol. A great many inflammable fossils contain

part obtained from pyrites.

the juice of the grape, malt-liquors, rice, &c.

its metallic state than any other metal. There is no proper ore of it: But it is found

ntly in that of an ore, with sulphur, sometimes arsenic; assuming different appearances.

its metallic state; usually in an ore with sulphur or arsenic, but seldom with sulphur

of fusion. This is generally found in the state of an ore with sulphur. The ores

ne appearance. The colour most usually a dark brown, and sometimes very beautiful. It is found in almost every body, and its ores are infi-

. It is sometimes found in its fluid form; but usually in a beautiful red ore with

volatilized. Lapis calaminaris is its principal ore.

asily converted into glass. Its only ore is with sulphur, which is the crude antimony

duced to an ore by arsenic. Its appearance much the same as the regulus.

in the ores of other metals.

s which have usually been applied for discovering the purity of gold, supposed from

obtained from an arsenical ore, which is likewise called *cobalt*.

kinds of lime-stone which feel unctuous to the touch are generally impregnated with the other for manure.

nd is easily calcined into quick-lime. This is probably nothing else than lime-stone

s likewise obtained from the mother-lye of nitre, the ashes of burnt vegetables, &c.

n Yorkshire, &c. Clay of any kind may, by a particular process, be converted into

glass; and is therefore used as a basis to white enamels, &c.

into glass, and hence are termed *vitrescent*.

nd transparency than the others.

s white in the fire.

but turn extremely hard in the air. Many other varieties of these earths might be and being all mixed with one another, they more properly belong to the natural

separated.

th them. The most common sorts are impregnated with sulphur and iron.

r water and other volatile bodies; but as it only suspends them, without altering

es from what it was without it. The bodies whose qualities we certainly know to be but experiments are yet wanting here.

NATURAL BODIES, considered as the objects of CHEMISTRY, may be divided into the six following classes, viz.

ACIDS: Vitriolic, Nitrous, Muriatic, Vegetable, of Urine, of Amber, as in the foregoing part of this table.

ALKALIS: Fixt, and Volatile, as above.

OIL: Essential, Empyreumatic, and Fossile. By mixture; but their uses are not much known.

SULPHUR. *Balsam of Sulphur*. By solution in a boiling heat.

COPPER. Harder than silver alone. Used in small proportions as alloy in coins.

IRON. A hard whitish compound.

MERCURY\*. By amalgamation with silver-leaf, or calx of silver precipitated by copper, but not by salts. This is used for silverizing on other metals, in the same way as the amalgamum of gold.

ZINC. Hard, somewhat malleable, and of a white colour.

SEMI-METALS.

ANTIMONY. A brittle mass.

BISMUTH. A whitish semi-malleable body.

ARSENIC. Brittle; the silver being rendered in part volatile.

PLATINA. Pretty pure and malleable. Difficult of fusion; and in part separates when cold.

COBALT.

CRYSTALLINE EARTHS, and other vitreous matters. A fine yellow opaque glass. The finest yellow paint for porcelain is procured from a glass mixed with silver.

ACIDS: Vitriolic, Nitrous, Muriatic, Vegetable, of Urine, of Ants\*, as above.

ALKALIS: Fixt, and Volatile, as above.

OILS: Express'd\*, and Essential, as above.

SULPHUR, as above.

GOLD and Silver, as above.

METALS.

TIN. A little harder than either of the metals, and easily fused: hence it is used as a solder for lead; and it forms the principal ingredients of pewter. If the fire is long continued, the tin floats on the surface.

COPPER\*. Brittle and granulated, like tempered iron or steel when broke. By throwing pieces of copper into melted lead. The union here is very slight.

IRON\*. An opaque brownish glass. By a great degree of heat if the iron has been previously reduced to the state of a calx; but never in its metallic state.

MERCURY\*. By amalgamation. Effected only in a melting heat, unless some bismuth has been previously united with the mercury.

ZINC. Hard and brittle. By pouring zinc on melted lead. If the zinc is first melted, and the lead injected upon it, it then desintegrates.

ANTIMONY\*.

BISMUTH. A grey-coloured semi-malleable body, easily fused; and thence used as a solder for lead or tin.

ARSENIC. { A grey-coloured brittle mass; easily fused, and extremely volatile.

SEMI-METALS. { A hyacinth-coloured glass. By fusion in a considerable heat. This glass is easily fused; and is a much more powerful flux than pure glass of lead.

PLATINA. Of a leafy or fibrous texture, and purplish or blue colour, when exposed to the air. If a large proportion of platina is used, it separates in the cold.

COBALT. The nature of this compound is not known.

NICKEL. A brittle metallic body.

CRYSTALLINE EARTHS. A thin glass. By fusion in a moderate heat.

ACIDS: Vitriolic\*, Nitrous\*, Muriatic, Vegetable\*, of Urine, as above.

ALKALIS: Fixt, and Volatile, as above.

OIL: Express'd\*, as above.

SULPHUR, as above.

GOLD, Silver, and Lead, as above.

METALS.

COPPER. A brittle mass. When the copper is in small proportions, it is firmer and harder than pure tin. This in right proportions with a little zinc, forms bell-metal.

IRON. A white brittle compound. By heating filings of iron red-hot, and pouring melted tin upon them. A metal resembling the finest silver is made of iron, tin, and a certain proportion of arsenic.

MERCURY. This amalgamum forms foils for mirrors; and forms the yellow pigment called *aurum mosaicum*. By being sublimed with sulphur and sal ammoniac.

ZINC. Hard and brittle. When the zinc is in small proportions, it forms a very fine kind of pewter.

ANTIMONY\*. *Regulus generis*. By elective attraction from copper and crude antimony.

BISMUTH. Bright, hard, and sonorous, when a small proportion of bismuth is used. This is very easily fused; and employed as a solder.

ARSENIC. A substance in external appearance resembling zinc.

PLATINA. A coarse hard metal which tarnishes in the air.

COBALT. By fusion.

NICKEL. A brittle metallic mass.

CRYSTALLINE EARTHS, or other vitreous matters. An opaque white vitreous mass, which forms the basis of white enamels.

ACIDS: Vitriolic, Nitrous, Muriatic, Vegetable, of Urine, of Ants, as above.

ALKALIS: Fixt, and Volatile, as above.

OIL: Essential, as above.

SILVER.

I.F.A.D.

TIN.



being its acid ioned. in the re cloth kample salt in at all, its alis inti be de- s basis,

moniac anufac- i foot; les of ontry d me- o bath cerning ; from dy said f these , from tes non- antity. tained a prin-

ned in obably animal

ies up d mat- vessel : d only porate a very if you head, the form e bare e moni- and the When ans to

ould re- Cy fixed

some there- vitriol, flow- ch de- subli-

Sal

METAL.

IRON. Harder and paler than copper. Easily fused. MERCURY \*. A curious amalgum. Soft at first, but afterward brittle. By triturating mercury with verdigris, common salt, vinegar, and water. Brési. Commonly made by cementation with calamine. The larger the proportion of zinc, the paler, harder, and more brittle is the brass. Prince's metal, pinsbeck, and other metals resembling gold. By employing zinc in substance in small proportions. The best pinsbeck about 1-4th of zinc. ZINC. Spelter. A native substance, found in Cornwall, consisting of zinc and copper, and used as a folder.

SEMI-METALS.

ANTIMONY. By fusion. BISMUTH. A palish brittle mass. Somewhat resembling silver. ARSENIC. White copper. By pouring arsenic, fused with nitre, upon copper in fusion. If too large a proportion of arsenic is used, it makes the come pound black and apt to tarnish. PLATINA. A white and hard compound, which does not tarnish so soon as pure copper, and admits of a fine polish. COBALT. White and brittle. NICKEL. White and brittle, and apt to tarnish. ACIDS: Vitriolic, Nitrous, Muriatic, Vegetable, of Urine, of Amber, of Ants, as above. ALKALIS: Fixt \*, and Volatile, as above. SULPHUR, as above. METALS: Gold, Silver \*, Lead \*, Tin, and Copper, as above.

SEMI-METALS.

ZINC. A white substance resembling silver. ANTIMONY. The magnetic quality of the iron is totally destroyed in this compound. BISMUTH. In a strong heat, this emiteth flames. ARSENIC. A whitish, hard, and brittle compound. By fusing with soap or tartar. A metal resembling fine steel is made by fusing cast iron with a little arsenic and glass. PLATINA. With cast iron it forms a compound remarkably hard, somewhat ductile, and susceptible of a fine polish. COBALT. A compound remarkably ductile. By fusion in a moderate heat. NICKEL. A brittle mass. VITRESCENT EARTHS. A transparent glass. In general blackish; but sometimes yellow, green, or blue. The colour is influenced by the degree of heat as well as na-

SEMI-METALS.

ture of the ingredients. ACIDS: Vitriolic, Nitrous, Muriatic, Vegetable \*, of Urine, as above. ALKALI: Fixt \*, as above. SULPHUR, as above. METALS: Gold, Silver \*, Lead \*, Tin, and Copper, as above. ZINC. An amalgum. Soft or hard, according to the proportions employed. ANTIMONY \*. By melting the regulus, and pouring it upon boiling mercury. By frequently distilling from this amalgum, the mercury is rendered much more pure, and is then called animated mercury. BISMUTH. A silvcrizing for iron. By putting this amalgum upon iron, and evaporating the mercury. It has much the appearance of silver. PLATINA. The compound resulting from this mixture is not known. COBALT. By mixing first with nickel, and then adding mercury.

SEMI-METALS.

ACIDS: Vitriolic, Nitrous, Muriatic, Vegetable \*, and Urinous. With the phenomena, and by the means above described. OIL: Expressed \*, as above. METALS: Gold, Silver, Lead, Tin, Copper, and Iron, as above. MERCURY, as above. ANTIMONY. This mixture is applied to no particular use. ARSENIC. A black and friable mass. PLATINA. A hard substance. COBALT. The particular nature and properties of this mixt is not known.

SEMI-METALS.

ACIDS: Vitriolic \*, Nitrous, Vegetable \*, and Volatile, as above. ALKALIS: Fixed and Volatile, as above. SULPHUR, as above. METALS: Gold, Silver, Lead, Tin \*, Copper, and Iron, as above. MERCURY, and Zinc, as above. BISMUTH, A mass resembling regulus of antimony. ARSENIC. The nature and qualities of this mixt are not known. PLATINA. A hard mass.

SEMI-METALS.

ACIDS: Vitriolic \*, Nitrous, Vegetable \*, and Volatile, as above. ALKALIS: Fixed and Volatile, as above. SULPHUR, as above. METALS: Gold, Silver, Lead, Tin \*, Copper, and Iron, as above. MERCURY, and Zinc, as above. BISMUTH, A mass resembling regulus of antimony. ARSENIC. The nature and qualities of this mixt are not known. PLATINA. A hard mass.

ANTI-MONY.

ACIDS: Vitriolic, Nitrous, Muriatic, Vegetable, of Urine, of Amber, as in the foregoing part of this table.  
 ALKALIS: Fixed, and Volatile, as above.  
 OILS: Essential, Empyreumatic, and Fossile. By mixture; but their uses are not much known.

{ NICKEL. Ditto.

VITREOUS EARTHS. A thin penetrating glass; which is a powerful flux of metals.

ACIDS: Vitriolic, Nitrous, Muriatic, Vegetable, and urinous; with the phenomena, &c. above described.

ALKALIS: Fixed \*, and Volatile \*, as above.

SULPHUR, as above.

METALS: Gold, Silver, Lead, Tin, Copper, and Iron, as above.

MERCURY and ANTIMONY, as above.

ARSENIC. Nature not known.

SEMI-METALS. } PLATINA. This mixture changes its colour much on being exposed to the air.

COBALT \*. By mixing first with nickel or regulus of antimony, and then adding cobalt; but it cannot be united by itself.

BISMUTH.

consists of four walls built in a quadrangular form. The two front-walls are ten, and the sides nine foot long; but they are all five foot high, and ten inches thick. Within the quadrangle formed by these walls, three arches run lengthwise from end to end thereof, at the distance of ten inches asunder. The mouth of this furnace is in the middle of one of its fronts, and of an oval form; two foot four inches high, and sixteen inches wide.

“ The ballons lie in the spaces between the arches of the furnace, which serve instead of a grate to support them. Four of them are usually placed in each interval; which makes sixteen for one furnace. They are set at the distance of about half a foot from each other, and secured in their places with brick and earth. But they leave about four inches on the upper part of the ballon uncovered, with a view to promote the sublimation, as they also do six inches of the inferior part, that the heat may the better act on the matters to be sublimed. Things being thus prepared, they first make a fire with straw, which they continue for an hour. Afterwards they throw in cow's-dung made up in square cakes like bricks. (The want of wood in this country is the reason that they generally make use of this fuel.) These cakes of dung add to the violence of the fire, which they continue in this manner for nineteen hours; after which they increase it considerably for fifteen hours more; and then they slacken it by little and little.

“ When the matter contained in the vessels begins to grow hot, that is, after six or seven hours baking, it emits a very thick and ill-scented smoke, which continues for fifteen hours. Four hours after that, the sal ammoniac is observed to rise in white flowers, which adhere to the inside of the neck of the vessel; and those who have the direction of the operation take care from time to time to pass an iron rod into the neck of the ballon, in order to preserve a passage through the saline vault, for giving vent to some blueish vapours, which constantly issue out of the vessel during the whole operation.”

From this history of the preparation of sal ammoniac it appears, that soot, and particularly the soot of animal matters, either contains abundance of this salt perfectly formed, and waiting only for sublimation to separate it therefrom, or at least that it contains the proper materials for forming it; and that during the operation, which is a kind of distillation of soot, these materials combine together and sublime.

We shewed, in our analysis of soot, that this substance yields by distillation a great deal of volatile alkali; and this is an ingredient which makes at least one half of sal ammoniac. As to the other principle of this salt, the marine acid, this also must needs exist in soot: but it is not so easy to conceive how it should come there.

It is very true that vegetable and animal substances, the only ones that produce soot in burning, contain some portion of sea-salt: but then this salt is very fixed, and seems unfit to rise with the acid, the oil, and the subtle earth, of which the volatile alkali is formed. Therefore we must suppose either that its elevation is procured by the force of the fire, aided by the volatility

of the matters that exhale in burning; or that, being decomposed by the violence of the combustion, its acid alone rises with the other principles above mentioned. The latter seems probable enough: for though in the common operations of chemistry the bare force of fire doth not seem sufficient to decompose sea-salt; yet the example of sea-plants, which, before burning, contain this salt in abundance, and whose ashes contain scarce any at all, but are replete with its fixed part, that is, with its alkaline basis, seems to prove, that, when this salt is intimately mixed with inflammable matters, it may be destroyed by burning; so that its acid shall desert its basis, and fly off with the soot.

Before the exact method of procuring sal ammoniac was known, it was generally imagined that the manufacturers mixed sea-salt, and even urine, with the soot; because these two substances contain the principles of which this salt consists. But, besides that the contrary now certainly appears from the above mentioned memoirs, it hath been shewn by Mr Duhamel, who hath published several memoirs and experiments concerning the composition and decomposition of sal ammoniac, from which we have partly taken what we have already said on this subject; it hath been shewn, in the first of these memoirs, that the addition of sea-salt to the soot, from which sal ammoniac is to be extracted, contributes nothing to its production, and cannot increase its quantity. That alone, therefore, which was originally contained in the matters that produced the soot, enters as a principle into the composition of sal ammoniac.

Sal ammoniac is sometimes found perfectly formed in the neighbourhood of volcanos. This salt is probably produced from the fuliginosities of vegetable or animal matters consumed by the fire of the vulcano.

Sal ammoniac is often impure, because it carries up with it, in sublimation, some of the black charred matter which ought to be left at the bottom of the vessel; but it is easily purified. For this purpose you need only dissolve it in water, filter the solution, then evaporate and crystallize; by which means you will have a very white and very pure sal ammoniac. You may if you please, sublime it again in a cucurbit and blind head, with a fire not too brisk. Some of it will rise in the form of a light white powder, called *flowers of sal ammoniac*. These flowers are no other than true sal ammoniac, which hath suffered no decomposition; because the bare action of fire is not capable of separating the acid and the volatile alkali, of which this neutral salt consists. When you intend to decompose it, you must use the means to be mentioned hereafter.

Though sal Ammoniac be only semi-volatile, and requires a considerable heat to sublime it, yet it hath the property of carrying up with it matters that are very fixed and ponderous; such as metallic substances, and some kinds of earths. For medicinal uses we sublime therewith iron, lapis hæmatites, the copper in blue vitriol, &c. and then it takes different names, as *martial flowers of sal ammoniac, ens veneris*, and other such denominations, which it borrows from the matters sublimed with it.

*Sal Ammoniac decomposed by acids.*

INTO a large tubulated retort put a small quantity of sal ammoniac in powder: set your retort in a furnace, and lute on a large ballon, as in the distillation of the fuming acids of nitre and sea-salt. Through the hole in your retort pour a quantity of oil of vitriol or spirit of nitre equal in weight to your sal ammoniac. An effervescence will instantly follow. The mixture will swell, and discharge white vapours which will come over into the receiver. Stop the whole in the retort immediately, and let the first vapours pass over, together with some drops of liquor, which will distil without fire. Then put a few coals into the furnace, and continue the distillation with a very gentle heat; which however must be increased little by little till nothing more will come over. When the operation is finished, you will find in the receiver a spirit of salt if you made use of oil of vitriol or an *aqua regis*, if the spirit of nitre was employed: and in the retort will be left a saline mass, which will be either a glauber's secret sal ammoniac, or a nitrous sal ammoniac, according to the nature of the acid used to decompose the sal ammoniac.

*Sal ammoniac decomposed by fixed Alkalis. Volatile salt. The Febrifuge of Sylvius.*

INTO a glass alembic or retort put sal ammoniac and salt of tartar pulverised and mixed together in equal quantities. Set your vessel in a proper furnace, and immediately lute on a large receiver. A little volatile spirit will ascend; and a volatile alkali, in a concrete form, very white and beautiful will sublime into the head, and come over into the receiver, in quantity near two thirds or three fourths of the sal ammoniac used. Continue the distillation, increasing the fire by degrees till nothing more will sublime. Then unlute the vessels. Put up your volatile salt immediately into a wide mouthed bottle, and stop it close with a crystal stopple. At the bottom of the retort or cucurbit you will find a saline mass, which, being dissolved and crystallised, will form a salt nearly cubical, having the taste and other properties of sea-salt. This is the *sal febrisugum silvii*.

*Sal Ammoniac decomposed by absorbent Earths and Lime. Fixed Sal Ammoniac.*

LET one part of sal ammoniac and three parts of lime

slaked in the air be pulverised separately, and expeditiously mixed together. Put this mixture immediately into a glass retort, so large that half of it may remain empty. Apply thereto a capacious receiver, with a small hole in it to give vent to the vapours, if needful. Let your retort stand in the furnace about a quarter of an hour, without any fire under it. While it stands thus, a great quantity of invisible vapours will rise, condense into drops, and form liquor in the receiver. Then put two or three live coals in your furnace, and gradually increase the fire till no more liquor will rise. Now unlute your vessels, taking all possible care to avoid the vapours, and quickly pour the liquor out of the receiver into a bottle, which you must stop with a crystal stopple, rubbed with emery. There will remain, at the bottom of the retort, a white mass, consisting of the lime employed in the distillation, together with the acid of the sal ammoniac: this is called *fixed sal ammoniac*.

*Volatile Alkalis combined with oily matters. A Volatile Oily Aromatic salt.*

PULVERISE and mix together equal parts of sal ammoniac and salt of tartar: put the mixture into a glass or stone cucurbit: pour on it good spirit of wine till it rise half an inch above the matter. Mix the whole with a wooden spatula; apply a head and a receiver, and distil in a sand-bath, gently heated, for two or three hours. A volatile salt will rise into the head; and then the spirit of wine will distil into the receiver, carrying with it a portion of the volatile salt.

When nothing more will come over, let your vessels cool; then unlute them, separate the volatile salt, and weigh it directly. Return it into a glass cucurbit, and for every ounce thereof add a dram and a half of essential oil, drawn from one or more sorts of aromatic plants. Stir the whole with a wooden spatula, that the essence may incorporate thoroughly with the volatile salt. Cover the cucurbit with a head, fit on a receiver, and, having luted it exactly, distil in a sand-bath, as before, with a very gentle heat. All the volatile salt will rise, and stick to the head. Let the fire go out, and when the vessels are cooled take your salt out of the head. It will have an odour compounded of its own proper smell, and the smell of the essence with which it is combined. This is an *aromatic oily salt*. Put it into a bottle stopped close with a crystal stopple.

A T A B L E.

**CHEMOSIS**, a disease of the eyes, proceeding from an inflammation, when the white of the eye swells above the black, and overtops it to such a degree, that there appears a sort of gap between them.

Others define it to be an elevation of the membrane which surrounds the eye, and is called the white; being an affection of the eye, like white flesh.

**CHENOPODIUM**, in botany, a genus of the pentandria digynia class. The calix consists of five leaves; it has no corolla; and there is but one lenticular seed. There are 18 species, 13 of which are natives of Britain, *viz.* the bonus henricus, common English mercury, or all-good; the urticum, or upright blite; the rubrum, or sharp-leaved goose-foot; the murale, common goose-foot, or sow-bane; the hybridum, or maple-leaved blite; the album, or common orache; the viride, or green blite; the serotinum, or late-flowered blite; the glaucum, or oak-leaved blite; the vulvaria, or stinking orache; the polyspermum, round-leaved blite, or all seed; the maritimum, sea blite, or white glass-wort; and the fruticosum, shrub stone-crop, or glass-wort. The leaves of the vulvaria, or stinking orache, are said to be an excellent anti hysteric.

**CHEPELLO**, an island in the bay of Panama, and province of Darien, in South America, situated about three leagues from the city of Panama, which it supplies with provisions: W. long. 81°, N. lat. 9°.

**CHEPSTOW**, a market-town in Monmouthshire, situated on the river Wye, near its mouth, about ten miles south of Monmouth: W. long. 2° 40', N. lat. 51° 40'.

**CHEQ**, or **CHERIF**, the prince of Mecca, who is, as it were, high priest of the law, and sovereign pontiff of all the Mahometans, of whatever sect or country they be. See **CALIPH**.

The grand signior, soppies, moguls, Khans of Tartary, &c. send him yearly presents, especially tapestry to cover Mahomet's tomb withal, together with a sumptuous tent for himself, and vast sums of money to provide for all the pilgrims during the seventeen days of their devotion.

**CHERBURG**, a port-town of France, in the province of Normandy, situated on a bay of the English channel, opposite to Hampshire, in England: W. long. 1° 40', N. lat. 49° 45'.

**CHEREM**, in Jewish antiquity, the second and greater sort of excommunication among the Jews.

The cherem deprived the excommunicated person of almost all the advantages of civil society: he could have no commerce with any one, could neither buy nor sell; except such things as were absolutely necessary for life; nor resort to the schools, nor enter the synagogues; and no one was permitted to eat or drink with him.

The sentence of cherem was to be pronounced by ten persons, or at least in the presence of ten: but the excommunicated persons might be absolved by three judges, or even by one, provided he were a doctor of the law. The form of this excommunication was loaded with a multitude of curses and imprecations, taken from different parts of the scripture.

**CHERESOU**, the capital of Curdistan, in Asiatic Turkey, and the seat of the beglerbeg, or viceroys, of the province: E. long. 45°, N. lat. 36°.

**CHERLERIA**, in botany, a genus of the decandria trigynia class. The calix consists of five leaves; it has five petals less than the leaves of the calix, and five bifid nectaria; the anthers are alternately barren: and the capsule has three cells and as many valves. There is but one species, *viz.* the sedoides, a native of Switzerland.

**CHERLESQUIOR**, in Turkish affairs, denotes a lieutenant-general of the Grand Signior's armies.

**CHERMES**, in zoology, a genus of insects belonging to the order of insecta hemiptera. The rostrum is situated on the breast; the feelers are longer than the breast; the four wings are deflected; the breast is gibbous; and the feet are of the jumping kind. There are 17 species, and the trivial names are taken from the plants which they frequent, as the chermes graminis, or grass-bug; the chermes ulmi, or elm-bug, &c.

**CHERRY TREE**, in botany. See **PRUNUS**.

**CHERRY ISLE**, in geography, an island situated in the north or frozen ocean, between Norway and Greenland: E. long. 20°, N. lat. 75°.

**CHERSO**, the capital of an island of the same name, in the gulf of Venice, and subject to the Venetians: E. long. 15°, N. lat. 45° 25'.

**CHERSONESUS**, among geographers, the same with a peninsula. See **PENINSULA**.

**CHERTSEY**, a market-town of Surry, about seven miles west of Kingston: W. long. 30', N. lat. 51° 25'.

**CHERUB**, or **CHERUBIN**, a celestial spirit, which in the hierarchy is placed next to the seraphim. See **HiERARCHY**.

The several descriptions which the scripture gives us of cherubins, differ from one another; but all agree in representing a figure composed of various creatures, as a man, an ox, an eagle, and a lion.

**CHERVIL**, in botany. See **CHEROPHYLLUM**.

**CHERWEL**, a river, which, arising in Northamptonshire, runs southwards by Banbury, and unites its waters with those of the Isis, near Oxford.

**CHESHAM**, a market-town of Buckinghamshire, about nine miles south-east of Aylesbury: W. long. 35', N. lat. 51° 36'.

**CHESHIRE**, a maritime county of England, bounded by Staffordshire on the east, and by the Irish sea on the west: its chief commodities are salt and cheese; the last of which is much esteemed all over Britain.

**CHESNUT-TREE**, in botany. See **FACTUS**.

**CHESS**, an ingenious game, performed with different pieces of wood, on a board divided into sixty-four squares or houses; in which chance has so small a share, that it may be doubted whether a person ever lost but by his own fault.

Each gamester has eight dignified pieces, *viz.* a king, a queen, two bishops, two knights, and two rooks; also eight pawns: all which, for distinction sake, are painted of two different colours, as white and black.

As

As to their disposition on the board; the white king is to be placed on the fourth black house from the corner of the board, in the first and lower rank; and the black king is to be placed on the fourth white house on the opposite or adversary's end of the board. The queens are to be placed next to the kings, on houses of their own colour. Next to the king and queen, on each hand, place the two bishops; next to them, the two knights; and last of all, on the corners of the board, the two rooks. As to the pawns, they are placed without distinction, on the second rank of the house, one before each of the dignified pieces.

Having thus disposed the men, the onset is commonly begun by the pawns, which march straight forward in their own file, one house at a time, except the first move, when it can advance two houses, but never moves backwards: the manner of their taking the adversary's men, is side-ways, in the next house forwards; where having captivated the enemy, they move forward as before. The rook goes forward or cross-ways through the whole file, and back again. The knight skips backward and forward to the next house, save one, of a different colour, with a sidling march, or a slope, and thus kills his enemies that fall in his way, or guards his friends that may be exposed on that side. The bishop walks always in the same colour of the field that he is placed in at first, forward and backward, aslope, or diagonally, as far as he hits. The queen's walk is more universal, as she takes all the steps of the before-mentioned pieces, excepting that of the knight; and as to the king's motion, it is one house at a time, and that either forward, backward, sloping, or side-ways.

As to the value of the different pieces, next to the king is the queen, after her the rooks, then the bishops, and last of the dignified pieces comes the knight. The difference of the worth of pawns, is not so great as that of noblemen; only, it must be observed, that the king's bishop's pawn is the best in the field, and therefore the skilful gamester will be careful of him. It ought also to be observed, that whereas any man may be taken, when he falls within the reach of any of the adversary's pieces, it is otherwise with the king, who, in such a case, is only to be saluted with the word *check*, warning him of his danger, out of which it is absolutely necessary that he move; and, if it so happen that he cannot move without exposing himself to the like inconveniency, it is check-mate, and the game is lost.

**CHEST**, in commerce, a kind of measure, containing an uncertain quantity of several commodities.

A chest of sugar, *v. g.* contains from ten to fifteen hundred weight; a chest of glass, from two hundred to three hundred feet; of Castile soap, from two and an half to three hundred weight; of indigo, from one and an half to two hundred weight, five score to the hundred.

**CHEST**, or **THORAX**, in anatomy. See p. 277.

**CHESTER**, the capital city of Cheshire, situated sixteen miles south of Liverpool: W. long. 3°, N. lat.

53° 15'. It is a bishop's see, and gives the title of earl to the prince of Wales.

**NEW-CHESTER**, the capital of a county of the same name in Pennsylvania, in North America, situated on the river Delaware, south of Philadelphia: W. long. 74°, N. lat. 40° 15'. Its harbour is fine and capacious, admitting vessels of any burden.

**CHESTERFIELD**, a market-town of Derbyshire, fifteen miles north of Derby, W. long. 1° 25', N. lat. 53° 20'. It gives the title of earl to a branch of the noble family of Stanhope.

**CHEVALER**, in the menage, is said of a horse when in passing upon a walk or trot, his off fore-leg crosses or overlaps the near fore-leg every second motion.

**CHEVALIER**, in a general sense, signifies a knight, or horseman.

**CHEVAUX DE FRISE**, in fortification; a large joist, or piece of timber, about a foot in diameter, and ten or twelve in length, into the sides whereof are driven a great number of wooden pins, about six foot long, armed with iron points, and crossing one another. See **FORTIFICATION**.

**CHEVERON**, in heraldry. See **CHEVRON**.

**CHEVIL**. See **KEVIL**.

**CHEVIOT**, or **TIVIOT-HILLS**, run from north to south through Cumberland, and were formerly the borders or boundaries between England and Scotland, where many a bloody battle has been fought between the two nations, one of which is recorded in the ballad of Chevy-chase.

**CHEVISANCE**, in law, denotes an agreement or composition, as an end or order set down between a creditor and his debtor, &c.

In our statutes, this word is most commonly used for an unlawful bargain, or contract.

**CHEVRON**, or **CHEVERON**, in heraldry, one of the honourable ordinaries of a shield, representing two rafters of an house, joined together as they ought to stand; it was anciently the form of the priestesses head attire: some say, it is a symbol of protection; others, of constancy; others, that it represents knights spears, &c. It contains the fifth part of the field, and is figured as in Plate LV. fig. 3.

A chevron is said to be abased, when its point does not approach the head of the chief, nor reach farther than the middle of the coat; mutilated, when it does not touch the extremes of the coat; cloven, when the upper pieces are taken off, so that the pieces only touch at one of the angles; broken, when one branch is separated into two pieces; couched, when the point is turned towards one side of the escutcheon; divided, when the branches are of several metals, or when metal is opposed to colour; inverted, when the point is turned towards the point of the coat, and its branches towards the chief.

*Per* **CHEVRON**, in heraldry, is when the field is divided only by two single lines, rising from the two base points, and meeting in the point above, as the chevron does.

**CHEVRONED**,

- CHEVRONED**, is when the coat is filled with an equal number of chevrons, of colour and metal.
- CHEVRONEL**, a diminutive of chevron, and as such only containing half a chevron.
- CHEVRONNE**, or **CHEVRONNY**, signifies the dividing of the shield several times chevron-wise.
- CHEWING-BALLS**, a kind of balls made of asphaltida, liver of antimony, bay-wood, juniper-wood, and pellitory of Spain; which being dried in the sun, and wrapped in a linen-cloth, are tied to the bit of the bridle for the horse to chew: they create an appetite; and it is said, that balls of Venice treacle may be used in the same manner with good success.
- CHIAMPA**, the south division of Cochin-china, a country of the East-Indies.
- CHIAN earth**, in pharmacy, one of the medicinal earths of the ancients, the name of which is preserved in the catalogues of the materia medica, but of which nothing more than the name has been known for many ages in the shops.
- It is a very dense and compact earth, and is sent hither in small flat pieces from the island of Chios, in which it is found in great plenty at this time. It stands recommended to us as an astringent. They tell us, it is the greatest of all cosmetics, and that it gives a whiteness and smoothness to the skin, and prevents wrinkles, beyond any of the other substances that have been celebrated for the same purposes.
- CHIAPA**, the capital of a province of the same name in Mexico, situated about 300 miles east of Acapulco: W. long. 98°, N. lat. 16° 30'.
- CHIARASCO**, a fortified town of Piedmont in Italy, situated on the river Tanaro, twenty miles south-east of Turin, and subject to the king of Sardinia: E. long. 7° 45', N. lat. 44° 40'.
- CHIARENZA**, a port-town of the north-west coast of the Morea, opposite to the island Zant, in the Mediterranean, and subject to the Turks: E. long. 21° 15', N. lat. 37° 35'.
- CHIARO-SCURO**, among painters, See **CLARO-OSCURO**.
- CHICHESTER**, the capital city of Sussex, situated fifty-two miles south-west of London, and twelve miles east of Portsmouth: W. long. 50', and N. lat. 50° 50'. It is a bishop's see, and sends two members to parliament.
- New* **CHICHESTER**, a port-town of Pensilvania, situated on the river Delaware, below Chester. See **CHESTER**.
- CHICK**, or **CHICKEN**, in zoology, denotes the young of the gallinaceous order of birds, especially the common hen. See **PHASIANUS**.
- CHICKEN-pox**. See **Small-Pox**, and **MEDICINE**.
- CHICK-wired**, in botany. See **ALSINE**.
- CHICKLING pea**, in botany, a name given to the lathyrus. See **LATHYRUS**.
- CHICUITO**, or **CUYO**, a province of South America, bounded by the province of La Plata on the north-east, and by Chili on the west.
- CHIDLEY**, or **CHIMLEY**, a market-town of Devonshire, about eighteen miles north-west of Exeter: W. long. 4°, N. lat. 51°.
- CHIEF**, a term signifying the head or principal part of a thing or person. Thus we say, the chief of a party, the chief of a family, &c.
- CHIEF**, in heraldry, is that which takes up all the upper part of the escutcheon from side to side, and represents a man's head. See **Platè LXV. fig. 4.**
- It is to take up just the third part of the escutcheon, as all other honourable ordinaries do, especially if they are alone on the shield; but if there be several of them, they must be lessened in proportion to their number, and the same holds when they are cantoned, attended and bordered upon by some other figures; then the painter or engraver may be allowed to bring them into a smaller compass, to the end that all that is represented about the ordinaries may appear with some proportion and symmetry. Chiefs are very much varied, for they may be covert, supported, crenellè, surmounted, abaisè, rempli, dentillè, engressè, canellè, danchè, nebulè, fleurdelezèe, fleuronné, vair, echequetè, lozangè, burellè, pattè, frettè, gironné, chaperonné, chappè, mantelè, emmanché, chaussè, vèstu or revèstu. See **COUVERT**, **SUPPORTED**, &c.
- In* **CHIEF**, imports something borne in the chief part or top of the escutcheon.
- CHIEF lord**, the feudal lord, or lord of an honour on whom others depend.
- CHIEF-justice of the king's bench and common pleas**. See **JUSTICE**.
- CHIEFTAIN**, denotes the captain, or chief, of any class, family, or body of men: thus, the chieftains, or chiefs, of the highland clans, were the principal noblemen or gentlemen of their respective clans.
- CHIERI**, a fortified town of Piedmont in Italy, situated eight miles east of Turin: E. long. 7° 45', N. lat. 44° 50'.
- CHILBLAINS**, in medicine. See **PERNIQ.**
- CHILD-bed.** } See **MIDWIFERY.**  
**CHILD birth.** }
- CHILDERMAS-day**, or **INNOCENT'S-day**, an anniversary held by the church, on the 28th of December, in commemoration of the children at Bethlehem, massacred by order of Herod.
- CHILI**, a province of south America, bounded by Peru on the north, by the province of La Plata on the east, by Patagonia on the south, and by the Pacific ocean on the west; lying between 25° and 45° S. lat. and between 75° and 85° W. long. But some comprehend Patagonia in Chili, extending it to cape Horn, in 57° 30' S. lat.
- CHILIAD**, denotes a thousand of any things, ranged in several divisions, each whereof contains that number.
- CHILIARCHA**, or **CHILIARCHUS**, in antiquity, a military officer, who had the command of a thousand men.
- CHILIASTS**, in church-history. See **MILLENARIANS.**
- CHILMINAR**, **CHELMINAR**, or **TCHELMINAR**, the most beautiful piece of architecture remaining of all antiquity; being the ruins of the famous palace of Persepolis, to which Alexander the Great, in a drunken fit, set fire, at the instigation of Thais the courtesan:

the word comes from the Persian *tebble minar*, that is to say, forty towers.

Don Garcias de Silva Figueroa, Pietro della Valle, Sir John Chardin, and Le Brun, have been very particular in describing these ruins.

There appear, say they, the remains of near four-score columns, the fragments of which are at least six feet high; but there are only nineteen can be called entire, with another detached from the rest, about an hundred and fifty paces: a rock of hard black marble serves as a foundation to the edifice: the first plan of the house is ascended to by ninety-five steps, all cut in the rock; the gate of the palace is about twenty feet wide, with the figure of an elephant on one side, and that of a rhinoceros on the other, thirty feet high, and both of polished marble: near these animals there are two columns, and not far from thence the figure of a pegasus. After passing this gate, are found fragments of magnificent columns in white marble, the smallest of which are fifteen cubits high, the largest eighteen, having forty flutings three full inches wide each; from whence we may judge of their thickness and other proportions. Near the gate is seen an inscription on a square piece of black marble, containing about twelve lines; the characters are of an extraordinary figure, resembling triangles, or pyramids: besides this, there are other inscriptions, the characters of which resemble the Hebrew, Chaldaic, or Syriac; others the Arabic or Persian; and others, in fine, the Greek characters. Dr Hyde, who hath explained the Greek inscription, by supplying some words that are effaced, observes, that the inscriptions are engraved very negligently, and perhaps by some soldiers; or, if they are the work of an engraver, he thinks that he was from Palmyra, and consequently that they are in the Phœnician tongue: he adds, that as they are in praise of Alexander, they were probably done in the time of that conqueror.

**CHILTERN**, a chain of chalky hills, running from east to west through Buckinghamshire.

**CHIMÆRA**, in geography, a port-town of Turkey in Europe, situated at the entrance of the gulph of Venice, in the province of Epirus, about thirty-two miles north of the city Corfu, near which are the mountains of Chimæra, which divide Epirus from Thessaly: E. long. 20° 40', and N. lat. 40° 20'.

**CHIMAY**, the name of a great lake, lying in the province of Acham, between the East-Indies and China.

**CHIMERA**, a fabulous monster, which the poets feign to have the head of a lion, the body of a goat, and the tail of a dragon; and add, that this odd beast was killed by Bellerophon. The foundation of the fable was, that in Lycia there was a burning mountain, or volcano, of this name: that the top of this mountain was seldom without lions, nor the middle, which had very good grass, without goats; that serpents bred at the bottom, which was marshy; and that Bellerophon rendered the mountain habitable.

By a chimera, among the philosophers, is understood a mere creature of the imagination, composed of

such contradictions and absurdities as cannot possibly any where exist but in thought.

**CHIMES** of a clock, a kind of a periodical music, produced at equal intervals of time, by means of a particular apparatus added to a clock.

**CHIMNEY**, in architecture, a particular part of a house, where the fire is made, having a tube or funnel to carry away the smoke. See **ARCHITECTURE**.

**CHINA**, including Chinese Tartary, a large empire, situated between 95° and 135° E. long. and between 21° and 55° N. lat. being accounted two thousand miles in length, and one thousand five hundred in breadth; it is bounded by Russian Tartary on the north, by the Pacific ocean on the east and south, and by Tonquin, Tibet, and the territories of Russia on the west. It is usually divided into sixteen provinces, which will be described in their alphabetical order. In these provinces there are computed to be one hundred and fifty-five capital cities, one thousand three hundred and twelve of the second rank, two thousand three hundred and fifty seven fortified towns, and upwards of ten millions of families, which may amount to about fifty millions of people.

The principal commodities of this country are silk, tea, China ware, Japan-ware, and gold dust; of all which the maritime states of Europe import great quantities, sending them silver in return.

**CHINA-root**, in pharmacy, a medicinal root, brought both from the East and West Indies, thence distinguished into oriental and occidental; it is the root of a species of smilax. See **SMILAX**.

**CHINA-ware**. See **PORCELAIN**.

**CHINCA**, a port-town of Peru, in South America, situated in an extensive valley, on a river of the same name, about sixty miles south of Lima: W. long. 76°, and S. lat. 13°.

**CHIN COUGH**, a convulsive kind of cough, which children are chiefly subject to. See **MEDICINE**.

**CHINESE**, in general, denotes any thing belonging to China. See **CHINA**.

It is observed by some, that the Chinese language has no analogy with any other language in the world: it only consists of three hundred and thirty words, which are all monosyllables, at least they are pronounced so short that there is no distinguishing above one syllable or sound in them; but the same word, as pronounced with stronger or weaker tone, has different significations; accordingly, when the language is accurately spoke, it makes a sort of music, which has a real melody, that constitutes the essence and distinguishing character of the Chinese tongue.

As to the Chinese characters, they are as singular as the language; the Chinese have not, like us, any alphabet, containing the elements, or, as it were, the principles of their words: instead of an alphabet they use a kind of hieroglyphics, whereof they have above eighty thousand.

As the Chinese pretend to an antiquity both with regard to their nation and arts, far beyond that of any other nation, it will not perhaps be unacceptable to

give



give a short view of these pretensions, principally extracted from their own writers. But, when any thing is quoted from the Chinese history, it is absolutely necessary to attend, 1. To the times purely fabulous and mythological; 2. To the doubtful and uncertain times; and, 3. To the historical times, when the Chinese history, supported by indisputable monuments, begins to proceed on sure grounds.

1. Some ascribe to Tiene-hoang, a book in eight chapters, which contains the origin of letters. They add, that the characters used by the Sane hoang were natural, without any determinate form, that they were nothing but gold and precious stones.

Lieou-jou, author of Ouai-ki, says, that Tiene-hoang gave names to the ten *KANE*, and to the twelve *TCHI*, to determine the place of the year: this is meant of the cyclic characters.

*Tiene-hoang* signifies emperor of heaven. They call him also *Tiene ling*, the intelligent heaven; *Tsee jun*, the son who nourishes and adorns all things; and finally *Tchong-tiene-hoang-kune*, the supreme king of the middle heaven, &c. This Tiene-hoang succeeded Fouane-cou.

The Ouai-ki says, that Ti-hoang (emperor of the earth), the successor of Tiene-hoang, divided the day and the night, and appointed thirty days to make one moon. The book Tong li, quoted in Lopi, adds further, that this emperor fixed the winter-solstice to the eleventh moon. A proof that the Chinese year was originally very incorrect, and that the course of it was regulated only by that of the seasons, is, that for a long time, to express a year, they said a change of the leaves.

This Ti hoang, say they, was father of Tiene-hoang, and of Gine-hoang who follows.

They give Gine-hoang (sovereign of men) nine brothers, and pretend, that they divided the government among them. They were nine brothers (says Yuene-loa-fane) who divided the earth among them, and built cities, which they surrounded with walls. It was under this prince (says Lopi), that there first began to be a distinction between the sovereign and the subject; they drank, they eat, and the two sexes united.

After these three emperors which we have just now named, they place the period named *Ou-long* (the five Long or dragons) composed of five different families. But they do not tell us their names, nor the duration of their reigns. In these times (says an author) men dwelt in the bottom of caves, or perched upon trees as it were in nests. This fact contradicts the invention of building cities, and surrounding them with walls, which they place under the reign of Gine-hoang; but we will meet with many such contradictions in the sequel.

They say nothing of the third Ki. Of the fourth, named *Ho lo*, and composed of three families, they say, that the Ho-lo taught men to retire into the hollows of rocks. This is all they say of it. Neither do they say any thing of the fifth Ki, named *Lienc tong*, and composed of six families; of the sixth Ki, named *Su ming*, and composed of four families.

It is a folly to dwell upon the epocha of these six Ki;

nothing is more absurd. Lopi cites an author who generously gives them 1,100,750 years duration; Lopi says himself, that the five first Ki after Gine hoang make in all 50,000 years.

The seventh Ki is named *Sune-fei*, and comprehends twenty-two families. But they say nothing under all these reigns that has any relation to the arts or sciences. Only under the twenty-second and last, named *Tsee-che-chi*, they say, that it was not till then men ceased to dwell in caves. Is it not a palpable absurdity, that after so many ages, and under kings of whom they relate so many wonders, they had not yet found out the art of building huts to shelter them from the winds and rains!

The eighth Ki, named *Yne-ti*, contains thirteen families or dynasties. Tchine-fang-chi, the first of this period, reigned after Tsee-che-chi, and founded the first family. They say, that at the beginning men covered their bodies with leaves and herbs; serpents and beasts were very numerous; the waters which had overflowed, were not yet returned into their channels; and the misery of mankind was extreme. Tchine-fang taught men to prepare skins, to take off the hair with rollers of wood, and use them against the winds and frost which incommoded them very much. He taught them also to make a kind of web of their hair, to serve them as a covering to their heads against the rain. They obeyed him with joy; he called his subjects *people clothed with skins*; he reigned 350 years. To Tchine-fang-chi succeeded Chouchaue-chi, then Hai-kouei-chi, of whom they say nothing which has any relation to our subject.

The fourth prince, who also succeeded Hai-kouei-chi, was named *Hoene-tune*; he founded the fourth dynasty, (for each of these princes which we have just now mentioned, was the founder of a family or dynasty.) In the history of this king, Lopi quotes Lao-chene-tsee, who speaks thus:

“The ancient kings wore their hair dishevelled, without any ornament upon their heads. They had neither sceptre nor crown, and they governed their people in peace. Being of a beneficent disposition, they cherished all things, and put no person to death. Always giving, and never receiving any thing, their subjects, without dreading their power as masters, revered their virtue in their hearts. Then heaven and earth observed a most beautiful order, and every thing flourished in a surprising manner. The birds built their nests so low, that they might be reached with the hand; all the animal creation tamely submitted to the will of man. Then the just medium was observed, and harmony reigned over all. They did not reckon the year by the days. There was no distinction between within and without, between mine and thine. In this manner reigned Hoene-tune. But when mankind had degenerated from this happy state, birds and beasts, insects and serpents, all together, and as it were in concert, made war against them.”

To this dynasty of Hoene-tune, succeeded that of Tong-hou-chi, containing seven kings which are not named. To this fifth dynasty succeeded the sixth, whose founder was Hoang-tane-chi.

The 7th, the dynasty of Ki-teng-chi\*.

The 8th, the dynasty of Ki-y-chi\*.

The

The 9th, the dynasty of Ki-kiu-chi \*.

The 10th, the dynasty of Hi-ouci-chi \*.

The 11th, the dynasty of Yeou-tfao-chi.

The 12th, the dynasty of Soui-gine.

The 13th and last, the dynasty of Yong-tching-chi.

Of these seven kings, or founders of dynasties, which remain to be considered to complete the number of dynasties included in this eighth period, nothing is said of those marked \* that has any relation to our subject.

As to Yeou-tfao-chi, founder of the eleventh dynasty, whose reign, say they, lasted more than 300 years, and whose family, they add, continued more than 100 generations during the space of 12 or 18,000 years: here is what we find recorded.

Hanc-tsee says, that, in the first ages of the world, animals multiplied very fast; and that men being but few, they could not subdue the beasts and serpents.

Yene-tsee says also, that the ancients, either perched on trees, or stretched in hollow caves, possessed the universe, (Tiene-hia, that is to say, China). These good kings (continues he) breathed nothing but charity without any shadow of hatred. They gave much, and took nothing. The people did not go to pay their court to them, but all the world submitted to their virtues.

Lopi and Ouai-ki say almost in the same words, that, in the most remote antiquity, men sheltered themselves in the hollows of rocks, that they dwelt in deserts, and lived in society with all the other creatures. They had no thought of doing any injury to the beasts, and the beasts did not think of hurting them. But in the succeeding ages they became too wise, which made the animals rebel; armed with claws, teeth, horns, and venom, they assaulted man, and man was not able to resist them. Yeou tfao reigned then. He was the first who built houses of wood, in the form of birds nests; he persuaded men to retire into them to avoid the wild beasts. They did not know as yet how to cultivate the earth, they lived on herbs and fruits. They drank the blood of animals, they devoured their fish quite raw, they swallowed the hair and the feathers. This is what they say of Yeou-tfao chi: after him comes Soui gine, founder of the 12th dynasty.

Soui-gine chi is esteemed the inventor of fire.

On the summit of the mountain Pou-tcheou, says an author, are to be seen the walls of Justice. The sun and the moon cannot approach them; there is no difference of seasons there, nor vicissitudes of days and nights. This is the kingdom of light on the confines of Siouang mou. A faint (a great man) went to make a tour beyond the bounds of the sun and moon: he beheld a tree, and upon that tree a bird, who made fire come out of it by picking it. He was surprised at this; he took a branch of this tree, and from thence struck fire; from whence they called this great personage *Soui-gine*.

Other authors say also, that Soui-gine made fire with a certain kind of wood, and taught men to dress their vituals. By this means all diseases, and all disorders of the stomach and bowels were prevented. In this he followed the direction of heaven, and from thence was named *Soui gine*.

They say further, that, in the days of Soui-gine, there was much water upon the earth, and that this prince taught men the art of fishing. He must, of consequence, have invented nets or lines, which invention is after this ascribed to Fou-hi.

One Long-ma, or Dragon-horse, brought him a kind of table, and the tortoise letters. Soui-gine is the first to whom they apply this event, but the same thing will be said in the sequel of several others.

Soui-gine was the first who gave names to plants and animals; and these names (say they) were so expressive, that the nature of every thing was known by its name. He invented weights and measures for the regulation of commerce, which had been unknown before him.

Anciently (says an author) men married at fifty, and women at thirty years of age: Soui-gine shortened this period, and appointed that young men should marry at thirty, and girls at twenty.

Lastly, the Liki says, that it was Soui-gine who first taught men urbanity and politeness.

It now remains to speak of Yong tching-chi, the founder of the thirteenth and last dynasty of this period.

In his time, they used slender cords on which they tied various knots, and this served them instead of writing. But, after the invention of letters, how could they return again to the use of these cords, which is so limited and imperfect? This evidently implies a contradiction?

We come now to the ninth Ki or period, named *Chene-tong*. This ninth period will bring us down to the times of Fou hi. It comprehends twenty-one kings, whose names are as follow:

- |                            |                     |
|----------------------------|---------------------|
| 1. Sfe hoang, or Tfan hie, | 12. Hiene-yuene,    |
| 2. Pe-hoang-chi,           | 13. He sou,         |
| 3. Tchong hoang-chi,       | 14. Kai-tiene,      |
| 4. Tai-ting-chi,           | 15. Tsfune liu chi, |
| 5. Kouene-liene,           | 16. Tcho jong,      |
| 6. Yene-chi,               | 17. Hao-yng,        |
| 7. Tai chi,                | 18. Yeou-tfao-chi,  |
| 8. Tchong hoei-chi,        | 19. Tchu-siang-chi, |
| 9. Li lou, or Hoei-chi,    | 20. Yne khang-chi,  |
| 10. Sohoang chi,           | 21. Vou-hoai-chi.   |
| 11. Nuei-touane chi,       |                     |

Liu-pou ouei says plainly, that Sfe-hoang made letters. This Sfe-hoang, is called also *Tfang hie*. Some historians place him under Hoang-ti, whose minister they make him; while others make him a sovereign prince, and much anterior to Hoang-ti.

The first inventor of letters was Tfang-hie, then the king Vou-hoai made them be engraved on the coin, and Fou-hi used them in the public acts for the government of the empire. But observe, that these three emperors were even before Chini-nong; how can it be said then, that letters were not invented till under Hoang-ti? Such is the reasoning of Lopi, who was quite confounded with these fabulous times.

To this criticism it may be answered, You have told us, that letters had been invented in the reign of Soui-gine, the 12th king of the eighth period; how then can you pretend to give the honour of this invention to

Tfang-

T'ang-hie, who, according to your own testimony, did not flourish till the ninth period? However this may be, S'ee-hoan (say some romancers) knew to form letters the moment he was born. He was endowed with great wisdom, &c. After he had received the Ho-ton, he visited the south, went upon mount Yang-yu, and stepped on the bank of the river Lo. A divine tortoise carrying blue letters upon his shell, delivered them to him: then S'ee-hoang penetrated all the changes of Heaven and earth; above he observed the various configurations of the stars; below he examined all the marks he had seen upon the tortoise; he viewed the plumage of birds, he took notice of the mountains, and of the rivers which flow from them, and of all this he composed letters. Some very learned Chinese think, that this was the ancient kind of writing named *Ko-tou-ku*, which continued (say they) to the reign of the emperor Suene-ouang, that is, to the year 827 before J. C.

But Cong-yng-ta very well observes, that though the external figures of the letters have changed several times in some things, the six rules on which T'ang-hie formed them, have never suffered any change.

Then (continues Lopi) there was a difference between the sovereign and the subject, relation between the father and the son, distinction between the precious and the vile; laws appeared, rites and music reigned. Punishments were inflicted with vigour. Thus S'ee-hoang laid the foundations of good government, he appointed officers for each affair, the smallest did not escape him; and thus heaven and earth arrived at their full perfection.

They say nothing of the successor of S'ee-hoang which has any relation to our subject; but they say, that, under the reign of Tchong-hoang-chi, the third king of this period, they still used slender cords for writing.

From this prince we come at once to Hiene-yuene, the 12th in order of this period, because nothing is said of his predecessors.

We find a great many things under the reign of this prince, because he is the same with Hoang-ti, or at least they have confounded these two princes together.

They ascribe to Hiene-yuene the invention of cars. He joined two pieces of wood together, the one placed upright, and the other across, to the honour of the Most High. It is from this he is called *Hiens yuene*. The piece of wood placed across is called *hiene*, and that which is placed upright is called *yuene*. Hiene-yuene struck copper money, and made use of the balance to determine the weight of things. By this means he ruled the world in peace. *Ho* signifies merchandise in general. Formerly they wrote simply *hoa*, which signifies exchange. These merchandises (say they) consisted in metal, *kin*, in precious stones, *yu*, in ivory, *tchi*, in skins, *pi*, in coined money, *tsuene*, and in stuffs, *pou*, &c.

They then denominatèd money (as is done still) by the name of the reigning family. That of Hiene-yuene was one inch seven lines, and weighed twelve *tchu*, [the *tchu* is the 20th part of a *yo*, and a *yo* weighs 1200 little grains of millet]. They then ingraved letters on their money (as is still done at present.) It is for this reason that *van-tsee*, letters, signifies also a piece of money, which is called likewise *kini*, and *tsuene*, and *tao*.

Tcho-jong (16th emperor of the 9th period) hearing, at Cane-tcheou, the singing of birds, composed a music of union, whose harmony penetrated every where, touched the intelligent spirit, and calmed the heart of man, in such a manner, that the external senses were sound, the humours in equilibrio, and the life very long. He called this music *T'jie-ouene*, that is to say, temperance, grace, and beauty.

But the design, and in some sort the only aim of the ancient music of the Chinese, according to their authors, was the harmony of the virtues, the moderation of the passions, elegance of manners, and, in a word, every thing that can contribute to the perfection of a good and wise government, &c. For they were persuaded that music was capable of working all these miracles. It is difficult for us to believe them in this, especially when we consider the music which is at present used among them. But we appeal to the Greeks, who related as astonishing effects from this agreeable invention, whilst the modern Greeks, like most part of the Orientals, have no music but a wretched and contemptible monotony.

The 17th king of the 9th period is named *Hao-yng*. In his time they cut down the branches of trees to kill beasts with. Men were few. Nothing but vast forests were every where to be seen, and these frightful woods were filled with wild beasts. How contradictory is this, and how incompatible with the times in which this prince is said to have reigned!

The 18th king of the 9th period is called *Yeou-t'fao-chi*. We have seen in the preceding period, a prince of the same name. The Ouai-ki places this king at the beginning of the last ki, and gives him for successor Soui-gine. At this rate, nine entire periods, or ki, must have elapsed before men knew how to build huts, or had the use of fire. Lopi follows another method: he has ranged Yeou-t'fao-chi and Soui-gine in the preceding period; and although the king we are now speaking of bears the same name; he speaks of him quite differently.

The 19th king of the 9th period is named *Tchu-siang-chi*.

They say, that he commanded S'ee-kouei to make a kind of guitar with five strings named *se*, to remedy the disorders of the universe, and preserve every thing that had life.

The 20th king of the 9th period is named *Yne-khang-chi*.

In his time, the waters did not flow, the rivers did not pursue their usual course, which occasioned a great number of diseases.

Yne-khang instituted the dances called *Ta-vou* (grand dances), with a view to preserve health: for, as Lopi says, when the body is not in motion, the humours have not a free course; matter is amassed in some part, from whence come diseases, which all proceed from some obstruction.

The Chinese also imagine, that a man's virtues may be known by his manner of touching the lute and drawing the bow, &c.

Thus the Chinese make dances as well as music have a reference to good government; and the Liki say,

that we may judge of a reign by the dances which are used in it.

The 21st and last king of the 9th period is named *Vou-boai-chi*; but they relate nothing of this prince which is worthy of notice.


2. This is all that the fabulous times contain. If these times cannot enable us to fix the real epocha of various inventions, (as the Chinese are so full of contradictions about the time of these different discoveries), we see at least from them, that the origin of arts has been much the same among them as among other nations. We are now come down to Fou-hi, who is considered by the Chinese historians as the founder of their monarchy. What they say of this prince and his successors, has some more solidity in it than what we have hitherto seen.

### F O U H I.


The Ouai-ki, quoted in the Chinese annals, thus describes the manners of mankind in these days. "In the beginning, men differed nothing from other animals in their way of life. As they wandered up and down in the woods, and women were in common, it happened that children never knew their fathers, but only their mothers. They abandoned themselves to lust without shame, and had not the least idea of the laws of decency. They thought of nothing but sleeping and snoring, and then getting up and yawning. When hunger pressed them, they fought for something to eat; and when they were glutted, they threw the rest away. They eat the very feathers and hair of animals, and drank their blood. They clothed themselves with skins quite hairy. The emperor Fou-hi began by teaching them to make lines for catching fish, and snares for taking birds. It was for this, that this prince was named *Fou hi-chi*. He taught them further to feed domestic animals, and to fatten them for slaughter; for which they gave him the surname of *Poa-hi-chi*."

It seems evident, that the ancient Chinese had at first no other habitation than caves, the hollows of rocks, and natural dens. They were then infected with a kind of insect or reptile called *iang*; and when they met they asked one another, Are you troubled with *iangs*? To this day they make use of this expression, in asking after any person's health; *Couei-iang*? What disease have you? How do you do? *Vou-iang*. I am without *iang*; that is to say, I am hearty, in perfect health, without any ailment.

It would be superfluous to relate here, what the Chinese say, in their annals, of the invention of characters, and of *coua*, after what hath been said by F. Couplet and so many others on that subject. We shall only add, that the treatise *Hu-see* bears, that, at the beginning nations were governed by means of certain knots which they made on slender cords: that afterwards the saint introduced writing in their place, to assist the mandarins in performing all their offices, and the people in examining their conduct; and that it was by the sym-

bol  *Kouai*, that he conducted himself in the execution of his work.

Lopi, whom we have so often quoted already, says, that Fou-hi extracted from the symbol of six lines every thing that concerned good government. For example,

 *Li* gave him the hint of making lines for hunting

and fishing, and these lines were a new occasion of inventing stuffs for garments. Lopi adds, that it is a mistake to imagine, that, in the times of Fou-hi, they still used cords tied and knotted, and that books were not introduced till under Hoang-ti.

Fou-hi taught men to rear the six domestic animals, not only for food, but also for victims, in the sacrifices which they offered to *Chine*. and to *Ki*. They pretend that Fou-hi regulated the rites *Kiao-chene*.

Fou-hi also instituted marriage; before this the intercourse of the sexes was indiscriminate; he settled the ceremonies with which marriages were to be contracted, in order to render this great foundation of society respectable. He commanded the women to wear a different dress from that of the men, and prohibited a man's marrying a woman of the same name, whether a relation or not, a law which is actually still in force.

Fou-hi appointed several ministers and officers to assist him in the government of the empire.

One of these officers made the letters, another drew up the calendar, a third built the houses, a fourth practised medicine, a fifth cultivated the ground, a sixth was the master of the woods and waters.

They pretend that Fou-hi applied himself very much to astronomy. The Tcheou-pi-souane says, that he divided the heavens into degrees. Lopi takes notice, that properly the heavens have no degrees, but that this term is used with relation to the path of the sun in the course of a year.

The period of sixty years is reckoned due to Fou-hi. The Thiene-piene says plainly, that this prince made a calendar to six the year, and that he is the author of *Kia-tse*. The Sane-fene says the same thing; and the Hane-li-tchi says, that Fou-hi made the first calendar by the *Kia-tse*; but the Chi-pene ascribes this to Hoang-ti. This is one of these contradictions so common in the Chinese historians.

The same Fou hi, they say, made arms, and ordained punishments. These arms were of wood, those of Chin-nong were of stone, and Tchi-yeou made some of metal.

Fou-hi drained off the waters, and surrounded the cities with walls. In the mean time, as Chin-nong is esteemed the first who made walls of stone, we must suppose that those raised by Fou-hi were only of earth or brick.

Fou-hi gave rules to music. Those who ascribe this fine art to Hoang-ti are deceived (or *vice versa*.) After Fou-hi had invented fishing, he made a song for the fishers. It was from his example that Chin nong made one for the labourers.

Fou-hi took of the wood of Tong; he made it hollow; and of it made a *kine* (a lyre, or what you please to translate it) seven feet two inches long; the strings were of silk, to the number of 27; he commanded this instrument to be named *Lj*. Others say it had but 25 strings,

strings, others 10, and others only 5; (which of them shall we believe?) Besides, others make this instrument only three feet six inches six lines in length.

Fou hi made this instrument, say some, to ward off enchantments, and banish impurity of heart.

He took of the wood of *jung*, and made also a guitar of 36, or rather of 50 strings. This instrument served to adorn the person with virtues, and to regulate the heart, &c. Lastly, he made a third instrument of baked earth; after which, say they, ceremonies and music were in high esteem.

The money which Fou-hi introduced, was of copper; round within to imitate heaven, and square without to resemble the earth.

He himself made trial of many medicinal plants. (This is most commonly said of Chin-nong: but it is pretended, that Chin-nong finished what Fou-hi had begun.)

This is all we read of Fou-hi. Several contradictions will be remarked in most of these traditions, especially when we come to see in the sequel, that almost all these inventions are ascribed to the successors of Fou-hi. From hence may be judged what regard is due to the beginnings of the Chinese history.

We have still some reigns to examine, before we have done with the fabulous and uncertain times.

They say of Koung-koung, that he employed iron in making hangers and hatchets.

They ascribe to Niu-oua (who is the Eve of the Chinese) several instruments of music. The instruments *senq* and *hoang* served her, say they, to communicate with the eight winds. By means of *kouene*, or double flutes, she united all sounds into one, and made concord between the sun, moon, and stars. This is called *perfect harmony*. Niu-oua had a guitar (*je*) of five strings; she made another of 50 strings, whose sound was so affecting, that it could not be borne; wherefore she reduced these 50 strings to 25, to diminish its force.

The emperor Chin-nong is very famous among the Chinese, by the great discoveries which, they say, he made in medicine, agriculture, and even in the military art, since they believe, that, in the times of *Han*, they had a book of this prince on the military art.

A fondness for the marvellous has made some say, that, at three years of age, he knew every thing that concerned agriculture. The very name *Chin-nong*, in the Chinese language, signifies, *the spirit of husbandry*. Chin-nong took very hard wood, of which he made the coulter of the plough, and softer wood of which he made the handle. He taught men to cultivate the earth. They ascribe to him the invention of wine. He sowed the five kinds of grains on the south of Mount Ki, and taught the people to make them their food.

Chin-nong commanded that they should be diligent in gathering the fruits which the earth produced. He taught every thing relative to hemp, to the mulberry tree, and the art of making cloth and stuffs of silk. They owe also to Chin-nong the potters and the founders art; others, however, ascribe pottery to Hoang-ti, and the art of melting metals to Tchi-yeou.

Chin-nong invented fairs in the middle of the day. This was the origin of commerce and mutual exchange.

He made use of money to facilitate trade. He instituted festivals.

Chin-nong distinguished plants, determined their various properties, and applied them skilfully in the cure of diseases. They say, that, in one day, he made trial of 70 kinds of poisons, spoke of 400 diseases, and taught 365 remedies. This makes the subject of a book, intitled, *Pouen-tsao*, which they ascribe to him, and which contains four chapters. Others alledge, and with reason, that this book is not ancient. They say, with as little truth, that Chin-nong made books engraved on square plates.

Chin-nong commanded Tsiou-ho-ki to commit to writing every thing relative to the colour of sick persons, and what concerned the pulse, to teach how to examine its motions if they were regular and harmonious, and, for this end, how to feel it from time to time, and acquaint the patient.

Chin-nong composed ballads or songs on the fertility of the country. He made a very beautiful lyre, and a guitar adorned with precious stones, to form the grand harmony, to bridle concupiscence, to elevate virtue to the intelligent spirit, and bring men back to the celestial verity.

Chin-nong ascended a car drawn by five dragons. He was the first that measured the figure of the earth, and determined the four seas. He found 900,000 lys is west, and 850,000 is north and south. He divided all this vast space into kingdoms.

Among the successors of Chin-nong they place Hoang-ti, and the rebel Tchi-yeou, whom they make the inventor of arms of iron, and several kinds of punishments. Tchi-yeou had the power of raising mists and darkness extremely thick. Hoang-ti knew not how to attack and overcome him. He accomplished it, however, by forming a car, on which he placed a figure whose arm of itself always turned to the south, in order to point out the four regions. Hoang-ti used the lance and buckler.

Tchi-yeou ordered sabres, lances, and cross-bows to be made. They ascribe to Hoang-ti the *kia-tse*, or cycle of 60 years; or at least Ta-nao, made it by his direction.

The Mandarin Tsang-kiai was charged to compose history. Yong-tcheng made a sphere which represented the celestial orbs, and discovered the polar star.

Li-cheou regulated numbers, and invented an instrument for computation, like to, or the same with that which is still in use in China and India; and of which Martini, in his *Decades*, and la Loubere, in his voyage to Siam, have given us the design and description.

Ling-lune, a native of Yuene yu, in the west of Tachia, (that is, Khorassan), took reeds in the valley of Hiai-ki; he cut two of an equal length, and blew into them: this gave occasion to the invention of bells. He adjusted twelve of these reeds to imitate the song of song-hoang, the royal bird, (one of the fabulous birds of the Chinese). He divided these reeds into twelve *lu*; six served to imitate the song of the male, and six that of the female. Finally, this man brought music to perfection, and explained the order and arrangement of different sounds. By means of these *lu-lu*, he governed the

the Kli of the Yne and of Yang, he determined the change of the four seasons, and gave calculations for astronomy, geometry, and arithmetic.

Yong yuene, by order of Hoang-ti, made twelve bells of copper, which corresponded to the moons, and served to adjust the five tones, and fix the seasons, &c. fables.

Hoang ti invented a kind of diadem or tiara, called *Alinc*. He ordered a blue and yellow robe to be made for himself, in imitation of the colours of heaven and earth. Having viewed the bird *hoei*, and considered the variety of its colours, as well as those of the flowers, he made garments be dyed of different colours, to make a distinction between the great and small, the rich and poor.

Nin-fong and Tche-tsiang invented mortars for pounding rice; kettles or caldrons: they invented the art of building bridges, and of making shoes; they made coffins for the dead; and men reaped great advantages from all these inventions. Hoi invented the bow, Y-meou arrows; Khy-pe invented the drum, which made a noise like thunder, trumpets and horns, which imitated the voice of the dragon.

Kong kou and Hoa-hu, by order of the Emperor Hoang ti, hollowed a tree of which they made a ship; of the branches of the same tree they made oars; and by this means they were able to penetrate into places which seemed inaccessible, and where men had never been.

For the transportation of merchandize by land, they also invented chariots under this reign, and trained oxen and horses to draw them.

Hoang-ti also turned his thoughts to buildings, and gave models of them. He built a temple, called *Hokong*, in which he sacrificed to *Chang-ti*, or to the Supreme Being.

With a view to facilitate commerce, Hoang-ti struck money, called *kine-tao*, *knife of metal*, because it had the shape of the blade of a knife.

Hoang-ti having observed that men died before the time fixed by nature, of diseases which carried them off, he commanded Yu-fou, Ki-pe, and Lei-kong, three famous physicians of these times, to assist him to determine what remedies were proper for each disease.

Si-ling-chi, the chief consort of that emperor, contributed on her part to the good of the state, and taught the people the art of rearing silk-worms, of spinning their cots, and making stuffs of them.

The Ouai-ki takes notice, that Hoang-ti commanded China to be measured, and divided into provinces or tcheou. Each *tcheou* was composed of ten *che*, each *che* was composed of ten *tau*, and each *tau* contained ten *ye*, or ten cities. These ten *ye*, or cities, had each five *ly*, or streets, &c.

The empire of Hoang-ti, which, according to this historian, seems to have been considerable, extended on the east to the sea, on the west to Khong tong. It was bounded on the south by Kiang, and on the north by the country of Heene-jo.

They say nothing that has any relation to the arts under the three princes who follow Hoang-ti; that is to

say, under the reigns of Chao-hao, who reigned 84 years; of Tchouene-hio, who reigned 78 years; and of Cao sine, who reigned 70 years. They observe only, that Chao-hao made them beat the watches with a drum: this supposes that they had then some instrument for marking the hours. The Se-ki adds, that this emperor levelled the highways, in order to render the mountains accessible, and that he cleared the channels of rivers. He made also a new kind of music, called *Ta yuene*, to unite men and genii, and reconcile high and low.

3. After having overcome the fatigue of so many fabulous traditions, we now come to the historical times. But before we enter upon them, it will not be improper to make some reflections which are absolutely necessary to shew how little regard is due to this sort of traditions. These reflections are thought to be so much the more important, as they will help to undeceive a great many people of the mistake they are in about the Chinese antiquities.

The Chinese monarchy begun by three princes, distinguished by the title of *Sane-hoang*, that is to say the *three Augusti*. These three Augusti, according to the most generally received opinion, are *Fou-hi*, *Ching-nong*, and *Hoang-ti*. The five emperors, successors of the Sane-hoang, are distinguished by the title of *Ou-ti*, that is to say, the *five emperors*. The five emperors are, *Chao-hao*, *Tchouene-hio*, *Tico*, *Yao*, and *Chune*. This division has been followed by Cong-ngane-coue, the great-grandson of Confucius, in the eighth generation, and one of the most celebrated writers of the dynasty of Hane. It has been adopted also by Hoang-fou-mi, and by most part of the best writers. The proofs of this opinion are taken partly from the book *Tcheou li*, an ancient record, or state of the empire, which many ascribe to the famous Tcheou-cong, minister and brother of Vou-vang, who was the founder of the imperial dynasty of Tcheou, eleven hundred and some odd years before the Christian æra; partly from the commentaries of Tso-kieou-mine on the Tchine-tsicou of Confucius's master. In these works, mention is made of the books, *Sane-fene*, and *Ou-tiene*, which, they say, are the histories of the three Hoang, and of the five Ti: now, the two first chapters of Chou-king, which contain an extract of the histories of Yao and of Chune, bore the title of *Tiene-yao* and *Tiene-Chune*; from whence it was concluded, that Yao and Chune were two of the five Ti; consequently Fou-hi, Ching-nong, and Hoang-ti, were what are called the three Hoang; and Chao-hao, Tchouene-hio, Tico, Yao, and Chune, were the five Ti.

These may perhaps be thought but feeble proofs to support an historical fact of this kind; but those who are of a contrary opinion, bring nothing to induce us to believe them, rather than Cong-ngane-coue and Hoang-fou-mi.

Hou-chouang-hou, in a preface before the *Tsiene-piene* of Kine-gine-chane confesses, that we find in the *Tcheou-li*, the existence of the book of three Hoang, and that of five Ti: but he adds, that we do not find there the names of these eight monarchs; that, under the Yin, they spoke of *Tiene hoang*, of *Ti-hoang*, and of *Gine hoang*; that Cong-ngane-coue, in his preface to Chou-

Chou-king, gives Fou hi, Chine nong, Hoang-ti, for the three Hoang, and that he takes Chao-hao, Tchouene-hio, Tio, Yao, and Chune for the five Ti; but that we know not on what foundation he does this, since Confucius, in the Kia-yu, distinguishes by the title of *Ti*, all the kings after Fou hi. The same thing is proved by some passages of Tso-chi and of Liu-pou-ouei; from whence they conclude, that Fou-hi, Chine-nong, and Hoang ti are not the three Hoang, and that there are no other Hoang but heaven, earth, and man.

Tchine-huene retrenches Hoang-ti from the number of the Sane hoang, and puts in his place Niu-oua, whom he ranges between Fou-hi and Chine nong. Others strike out Niu-oua, and put Tcho-yong in the place of Hoang-ti. Niu-oua was the sister of Fou hi, and Fou-hi, they say, reigned 115 years. At what age must this princess have mounted the throne, for they make her succeed her brother?

The famous Se ma-tsiene, to whom the Chinese, from their high esteem of him, have given the name of *Tai-sseng*, or *father of history*, will have Hoang-ti, Tchouene-hio, Cao-sine, Yao, and Chune to be the five Ti; and he gave these princes for their predecessors Soui-gine chi, Fou-hi, and Chine-nong, who, according to him, were the three Hoang. This opinion, since his time, has been embraced by several other writers, who depended upon his authority more than upon proofs which he could not produce.

Confucius says in his Kia yu, that the princes who had governed the empire began at Fou hi to take the name of *Ti* or Emperor. The same philosopher says further, in the treatise Hi-tsee, or commentary upon the Y-king, that anciently Fou hi governed China, that Chine nong succeeded him, that after them Hoang-ti, Yao, and Chune were seated on the throne. From so decisive a testimony, Hou-ou-sang, and several others with him, have not doubted, that these five princes named by Confucius were the Ou-ti, or five emperors. As to the Sane-hoang, they admitted Tiene-hoang chi, Ti-hoang chi, Gine-hoang chi, as three chiefs of the people who had governed the empire before Fou-hi.

As it is from Tao-ssé, that the several authors we have now quoted, have borrowed their idea of this chimerical division of the eight first Chinese emperors, into three Hoang and five Ti, it is necessary to relate what these religious think themselves. They have opinions peculiar to themselves about these first ages of the monarchy. They believe, that at the first there were three Augusti, Sane-hoang; then five emperors, Ou ti; next three kings, Sane-vang; and lastly, five Pa, Ou-pa; that is to say, five chiefs of Regulos.

This order so regularly observed of three and then five, which is repeated twice shews plainly, that all this has no foundation in truth, but that it is a system invented at pleasure. Wherefore Tou-chong-chu, who lived under the Hané, explained this in an allegorical manner. The three Hoang were, according to him, the three powers, (heaven, earth, and man); The five Ti were the five duties (the duties of king and subject, of father and children, of husband and wife, of elder and younger brothers, of friends); the three Vang were the three

lights, (sun, moon, and stars); finally, the five Pa were the five mountains, four of which are situated at the four cardinal points of the empire, and the fifth at the centre. Thus Tong-tchong-chu allegorized this pretended succession of kings. But Lopi, who relates this explanation, adds, it was not his own. This is a point of criticism of little importance to us; let them, if they please, ascribe it to some other than Tong-tchong-chu; we have still ground to say, that it came from some writer who lived in an age not far from that of Tong-tchong-chu. This is enough for our present purpose, since we see from hence the little regard they then paid to this division, which they considered as chimerical. It would be in vain to attempt to reconcile all these contradictions. All these imaginary reigns are in the manner of the Tao-ssé, who have darkened the origin of the Chinese monarchy by their fables and mythology. The ten Ki or periods are of their inventing; they gave them between two and three millions of years duration. But before these ten periods, they place three dynasties, viz. the dynasty of Thiene-hoang-chi, that of Ti hoang-chi, and finally, that of Gine-hoang-chi. If we attend to the signification of these names, they must be interpreted thus: the *Sovereign of heaven*, the *Sovereign of earth*, the *Sovereign of men*. We see from hence, that the allegorical explanation of Tong-tchong chu, which made the three Hoang signify the three powers, that is, heaven, earth, and man, is not without probability.

These three Hoang succeeded to Pouane-cou, otherwise Hoene tune, the chaos, the origin of the world, which several of the Tao ssé take for the first man, or the first king who governed China.

The dynasty of Thiene-hoang-chi had thirteen kings, who reigned, say they, 18,000 years; then came the dynasty of Ti-hoang-chi, whose kings, to the number of eleven, make up a like duration of 18,000 years. Finally, to Ti-hoang-chi succeeded the Gine-hoang-chi, whose dynasty, composed of nine kings, furnishes a space of 45,600 years. These three sums added, give us precisely 81,600 years. But if we add to these three dynasties, those which are comprehended in each of the ten Ki, and which amount, according to some calculations, to more than 230; we shall find that the pretensions of the Chinese very much exceed those of the Chaldeans and Egyptians. For if we believe the calculations of various authors, from Pouane-cou to the death of Confucius, which happened in the year 479 before J. C. there is elapsed 276,000 years, or 2,276,000, or 2,59,860, or even 3,276,000; or, finally, which is a great deal more, 96,961,740 years: for we find all these different calculations.

It is visible enough, that these extravagant numbers can be nothing else but astronomical periods, contrived to give the conjunction of the planets in certain constellations, or calculations which have some relation to the ideas of the Tao ssé, concerning the perpetual destructions and reproductions of worlds. In fact, some have endeavoured to make these numbers agree with the period of Tchao-cang-tsie, a famous philosopher in the days of Song, who had undertaken to determine the period of the duration of the world; for the system of the de-

struction and reproduction of worlds was very current, not only in the sect of Ju or of the learned, but also among the Bonzes, Ho-chang or the religious of Fo. and among the Tao-ssé or followers of Lao Kiune, that is to say, among the three great sects. who have the most influence in the empire. Tchao-cang tse established then a great period of 129 000 years, called *Yuene*, composed of twelve equal parts. called *hoei*, or *conjunctions*, which were each of 10,800 years. In the first conjunction, said he, heaven was formed by little and little, by the motion which the Tai ki, or the Supreme Being, impressed upon matter which was formerly at perfect rest. During the second conjunction, the earth was produced in the same manner. At the middle of the third conjunction, man and all other beings began to spring up, in the manner that plants and trees are produced in the islands, which afterwards preserve their several kinds by their seeds. At the middle of the eleventh conjunction, all things shall be destroyed, and the world shall fall back again into its primitive chaos; from whence it shall not arise till after the twelfth conjunction is expired.

It is not difficult at present to conceive, that the Tao-ssé had invented that prodigious number of reigns before Fou-hi, for no other reason, but to fill up that interval, which, according to them, had elapsed from the production of man, to the beginning of the Chinese monarchy, that is to say, to the reign of Fou hi. The same calculator determined the half of Yuene, or of his great period of 129,000 years, at the reign of Yao.

These Tao-ssé, as was said already, laid down these ten ages or ten Ki as an indisputable principle; each Ki comprehended several dynasties, whose duration they determined as they thought fit, and as their calculation required: but if they were at liberty to increase or diminish the duration of the ten Ki, it was not the same as to their number, which was in some sort a fundamental principle of their sect, from which they were not allowed to depart.

Some missionaries, to whom this doctrine of Tao-ssé was not unknown, imagined, that they discerned in these ten Ki, the ten generations before Noah. and as the writers cited by Lopi, and by Cong-ing-ta, say; that of these ten Ki, six were before Fou he, and four after him; these same missionaries have imagined, that Fou-hi was Enoch. It must be owned, in the mean time, that Tchine-huene and several others do not observe the same order; that they place Chine-noug in the ninth Ki, Hoang-ti in the tenth, &c. By this computation Hoang-ti would be Noah, and Fou-hi Methuselah, which contradicts their hypothesis.

The opinion which considers the ten Ki of the Chinese as the ten generations which preceded Noah, is very ingenious, and not improbable. Towards the end of the reign of Tchou, about 300 years before the Christian æra, some Jews travelled into China, who might have made the writings of Moses known there, and, of consequence, the ten generations which preceded the deluge: besides, this knowledge was common to the Chaldeans, who might have penetrated into China before the Jews.

CHINEY, a city of the Austrian Netherlands, on the confines of the bishopric of Liege, about twelve miles south-east of Namur: E. long. 5°, N. lat. 50° 20'.

CHINON, a town of France in the province of the Orleanois, about twenty three miles south-west of Tours; E. long. 20', and N. lat. 47° 15'.

CHIO, CHIOS, XIO, or SCIO, an Asiatic island, lying near the coast of Ionia, in Natolia or Lesser Asia, about one hundred miles west of Smyrna. It is called by the Turks Sakisaduci, and is about one hundred miles in circumference; being chiefly inhabited by Christians of the Greek church, who are said to have three hundred churches in the island.

CHIO is also the capital of the above island, situated on the east coast: E. long. 27°, and N. lat. 38°.

CHIONANTHUS, or SNOW DROP TREE, in botany, a genus of the diandria-monogynia class. The calix divided into four oval segments; and the drupa contains but one seed. There are two species, viz. the virginica and zeylonica, both natives of the Indies.

CHIOZZO, or CHIOGGIO, a town on an island of the same name, in the gulph of Venice, by which there is a passage into the Lagunes situated about twelve miles south of the city of Venice.

CHIPPENHAM, a borough town in Wiltshire, about twenty two miles north west of Salisbury: W. long. 2° 12', and N. lat. 51° 25'. It sends two members to parliament.

CHIPPING, or MUCH-WICCOMB, a borough town of Buckinghamshire, about ten miles south of Aylesbury: W. long. 42', and N. lat. 51° 35'. It sends two members to parliament.

CHIROGRAPHY, a writing under one's own hand.

CHIROMANCY, a species of divination, drawn from the different lines and lineaments of a person's hand; by which means, it is pretended, the inclinations may be discovered.

CHIRONIA, in botany, a genus of the pentandria monogynia class. The corolla is rotated; the pistillum declines; the stamens are inserted into the tube of the corolla; the anthers are spiral; and the pericarpium is bilocular. There are eight species, none of them natives of Britain.

CHIRONOMY, in antiquity, the art of representing any past transaction by the gestures of the body, more especially by the motions of the hands: this made a part of liberal education; it had the approbation of Socrates, and was ranked by Plato among the political virtues.

CHIROTONY, among ecclesiastical writers, denotes the imposition of hands used in conferring priestly orders.

However, it is proper to remark, that chirotony originally was a method of electing magistrates, by holding up the hands.

CHIRVAN, a province of Persia, lying on the western coast of the Caspian sea.

CHIRURGERY. See SURGERY.

CHISLEY-LAND, in agriculture, a soil of a middle nature between sandy and clayey land, with a large admixture of pebbles.

CHISSEL,



**CHISSEL**, an instrument much used in carpentry, masonry, joinery, sculpture, &c. and distinguished according to the breadth of the blade into half-inch chisfels, quarter-inch chisfels, &c. They have also different names according to the different uses to which they are applied; as, 1. The former, used by carpenters, &c. just after the work is scribed: it is struck with a mallet. 2. The paring-chissel, which is used in paring off the irregularities made by the former: this is pressed with the workman's shoulder. 3. The skew-former cleanses acute angles with the point of its narrow edge. 4. The mortice chissel, used in cutting deep square holes in wood, for mortices: it is narrow, but thick and strong, to endure hard blows. 5. Socket-chissels, having their shank made with a hollow socket at top, to receive a strong wooden sprig fitted into it with a shoulder. 6. Ripping chissel, having a blunt edge, with no basul, used in tearing two pieces of wood asunder. And, 7. the gouge. See **GOUGE**.

**CHITAU**, in the materia medica, a kind of lignum-aloës, of a reddish colour. See **LIGNUM-ALOËS**.

**CHIVALRY**, in law, is a tenure of service, whereby the tenant is bound to perform some noble or military office to his lord; and is either regal, when held only of the king; or common, such as may be held of a common person as well as the king: the former is properly called fejeanty, and the latter escuage.

A statute of Charles II. abolishes all tenures by chivalry, in capite, &c. and ordains that all tenures shall be construed to be free and common soccage.

**CHIVES**, in botany. See **ANTHERÆ**.

**CHIUSI**, a city of Italy. in the dutchy of Tuscany, situated on the confines of the pope's territories, about thirty-five miles south-east of Sienna: E. long. 13°, and N. lat. 33°.

**CHLAMYS**, in antiquity, a military habit worn by the ancients over the tunica. It belonged to the patricians, and was the same in the time of war that the toga was in the time of peace. This sort of gown was called picta, from the rich embroidery with figures in Phrygian-work; and purpurea, because the ground-work was purple. The chlamydes of the emperors were all purple, adorned with a golden or embroidered border.

**CHLORIS**, in ornithology, the trivial name of a species of Loxia. See **LOXIA**.

**CHLOROSIS**, in medicine, a disease commonly called the green-sickness, incident to young girls. See **MEDICINE**.

**CHOCOLATE**, in commerce, a kind of paste, or cake, prepared of certain ingredients, the basis of which is the cacao-nut.

The Indians, in their first making of chocolate, used to roast the cacao in earthen pots; and having afterwards cleared it of the hulks, and bruised it between two stones, they made it into cakes with their hands. The Spaniards improved this method: when the cacao is properly roasted, and well cleaned, they pound it in a mortar, to reduce it into a coarse mass which they afterwards grind on a stone, till it be of the utmost fineness: the paste being sufficiently ground, is put quite

hot into tin moulds, in which it congeals in a very little time. The form of these moulds is arbitrary; the cylindrical ones, holding two or three pounds, are the most proper, because the bigger the cakes are, the longer they will keep. Observe, that these cakes are very liable to take any good or bad scent, and therefore they must be carefully wrapt up in paper, and kept in a dry place. Complaints are made, that the Spaniards mix with the cacao nuts too great a quantity of cloves and cinnamon, besides other drugs without number, as musk, ambergrise, &c. The grocers of Paris use few or none of these ingredients; they only chuse the best nuts, which are called Caracca, from the place from whence they are brought, and with these they mix a very small quantity of cinnamon, the freshest vanilla, and the finest sugar, but very seldom any cloves. Among us in England, the chocolate is made of the simple cacao, excepting that sometimes sugar, and sometimes vanilla is added.

Chocolate ready made, and cacao paste, are prohibited to be imported from any part beyond the seas. If made and sold in Great Britain, it pays inland-duty 1 s. 6 d. per lb. avoirdupoise: it must be inclosed in papers containing one pound each, and produced at the excise-office, to be stamped. Upon three days notice given to the officer of excise, private families may make chocolate for their own use, provided no less than half an hundred weight of nuts be made at one time.

**CHOENIX**, a dry measure, containing a forty-eighth part of a medimnus, or six bushels. Hence the celebrated proverb of Pythagoras, *Super chœnice ne fedas*.

**CHOIR**, that part of the church or cathedral where choirsters sing divine service: it is separated from the chancel, where the communion is celebrated; and also from the nave of the church, where the people are placed: the patron is said to be obliged to repair the choir of the church.

**CHOLEDOCHUS**, in anatomy. See Vol. i. p. 265.

**CHOLER**. See **BILE**.

**CHOLERA morbus**, in medicine. See **MEDICINE**.

**CHONDRILLA**, in botany, a genus of the syngenesia polygamia æqualis class. The calix is caliculated; the receptacle is naked; the pappus is simple, and furnished with a stipes; and the floscules are numerous. There is but one species, viz. the jancœa, a native of Germany.

**CHONDROPTERYGII**, in ichthyology, a term formerly applied to the order of fishes, now called amphibia nantes by Linnæus. See **AMPHIBIA**.

**CHOPIN**, or **CHOPINE**, a liquid measure, used both in Scotland and France, and equal to half their pint. See **PINT**, and **MEASURE**.

**CHORASSAN**, a province of Persia, on the north-east, adjoining to Ubec Tartary; this was the ancient Bactria, and the native country of the late Kouli Kan.

**CHORD**, in geometry, a right line drawn from one part of an arch of a circle to the other. Hence,

**CHORD of an arch** is a right line joining the extremes of that arch. See **TRIGONOMETRY**.

**CHORDS,**

**CHORDS, or CORDS,** in music, are strings, by the vibration of which the sensation of sound is excited, and by the divisions of which the several degrees of tune are determined.

**CHORD** is also used in music for the note or tone to be touched or sounded: in this sense the fifth is said to consist of five chords or sounds.

**CHORDAPSUS,** in medicine, a disease of the intestines, when to the touch they feel like stretched cords: it is the same with the iliac passion.

**CHORDEE,** in medicine and surgery, a symptom attending a gonorrhœa, consisting in a violent pain under the frenum, and along the duct of the urethra, during the erection of the penis, which is incurvated downwards. These erections are frequent and involuntary. See **MEDICINE**.

**CHOREUS,** in ancient poetry. See **TROCHEE**.

**CHORGES, or GORGES,** a town of Dauphiny, in France, about six miles east of Gap: E. long. 6°, and N. lat. 44° 36'.

**CHORIAMBUS,** in ancient poetry, a foot consisting of four syllables, whereof the first and last are long, and the two middle ones are short; or, which is the same thing, it is made up of a trochæus and iambus: such is the word *nōbilitās*.

**CHORION,** in anatomy, the exterior membrane which invests the fœtus in the uterus.

**CHOROBATA, or CHOROBATES,** a kind of water-level among the ancients, of the figure of the letter T, according to Vitruvius's description.

**CHOROGRAPHY,** the art of making a map of some country or province.

**CHORUS,** in dramatic poetry, one or more persons present on the stage during the representation, and supposed to be by-standers without any share in the action.

Tragedy in its origin was no more than a single chorus, who trod the stage alone, and without any actors, singing dithyrambics or hymns in honour of Bacchus. Theſpis, to relieve the chorus, added an actor, who rehearsed the adventures of some of their heroes; and Æschylus, finding a single person too dry an entertainment, added a second, at the same time reducing the singing of the chorus, to make more room for the recitation. But when once tragedy began to be formed, the recitative, which at first was intended only as an accessory part to give the chorus a breathing time, became a principal part of the tragedy. At length, however, the chorus became inserted and incorporated into the action: sometimes it was to speak, and then their chief, whom they called coryphæus, spoke in behalf of the rest: the singing was performed by the whole company; so that when the coryphæus struck into a song, the chorus immediately joined him.

The chorus sometimes also joined the actors in the course of the representation, with their complaints and lamentations on account of any unhappy accidents that befel them: but the proper function, and that for which it seemed chiefly retained, was to shew the intervals of the acts: while the actors were behind the scenes, the chorus engaged the spectators; their songs

usually turned on what was exhibited, and were not to contain any thing but what was suited to the subject, and had a natural connection with it; so that the chorus concurred with the actors for advancing the action. In the modern tragedies the chorus is laid aside, and the fiddles supply its place. Mr Dacier looks on this retrenchment as of ill consequence, and thinks it robs tragedy of a great part of its lustre; he therefore judges it necessary to re-establish it, not only on account of the regularity of the piece, but also to correct, by prudent and virtuous reflections, any extravagancies that might fall from the mouths of the actors, when under any violent passion.

Mr Dacier observed also, that there was a chorus, or *greg*, in the ancient comedy; but this is suppressed in the new comedy, because it was used to reprove vices by attacking particular persons; as the chorus of the tragedy was laid aside to give the greater probability to those kind of intrigues which require secrecy.

**CHORUS,** in music, is when, at certain periods of a song, the whole company are to join the singer in repeating certain couplets, or verses.

**CHOTZIM,** a frontier-town of Moldavia, on the confines of Poland, situated on the river Niefter, and subject to the Turks: E. long. 27°, and N. lat. 48°.

**CHOUG,** a town of Syria, upon the road from Aleppo to Sayde, called by some travellers Shoggle.

**CHOUGH,** in ornithology. See **CORVUS**.

**CHREMnitz,** the principal of the nine-towns in Upper Hungary, situated about sixty-eight miles north-east of Presburg, and subject to the house of Austria: E. long. 19°, and N. lat. 48° 45'.

**CHREMPS,** in ichthyology. See **SPARUS**.

**CHRISM,** oil consecrated by the bishop, and used in the Romish and Greek churches in the administration of baptism, confirmation, ordination, and extreme unction.

**Order of CHRIST,** a military order, founded by Dionysius I. king of Portugal, to animate his nobles against the Moors.

The arms of this order are gules, a patriarchal cross, charged with another cross argent: they had their residence at first at Castromarin, afterwards they removed to the city of Thomar, as being nearer to the Moors of Andalusia and Estremadura.

**CHRIST** is also the name of a military order in Livonia, instituted in 1205, by Albert bishop of Riga. The end of this institution was to defend the new Christians, who were converted every day in Livonia, but were persecuted by the heathens. They wore on their cloaks a sword with a cross over it, whence they were also denominated brothers of the sword.

**CHRIST-BURGH,** a town of Poland, near the lake Drausen, and about three Polish miles from Marienburgh.

**CHRIST-CHURCH,** a borough-town of Hampshire, thirty miles south-west of Winchester, near the sea-coast: W. long. 2°, N. lat. 50° 40'. It sends two members to parliament.

**CHRIST-thorn,** in botany. See **RHAMNUS**.

*Moß*

*Most* CHRISTIAN king, one of the titles of the king of France.

The French antiquaries trace the origin of this appellation up to Gregory the Great, who, writing a letter to Charles Martlet, occasionally gave him that title, which his successors have since retained.

CHRISTIAN religion, that instituted by Jesus Christ. See RELIGION.

CHRISTIANS, those who profess to believe the Christian religion. See RELIGION.

CHRISTIANS of *St John*, a sect of Christians very numerous in Balsara and the neighbouring towns: they formerly inhabited along the river Jordan, where St John baptized, and it was from thence they had their name. They hold an anniversary feast of five days, during which they all go to the bishop, who baptizes them with the baptism of St John. Their baptism is also performed on rivers, and that only on Sundays; they have no notion of the third person in the Trinity, nor have they any canonical book, but abundance full of charms, &c. Their bishoprics descend by inheritance, as our estates do, though they have the ceremony of an election.

CHRISTIANS of *St Thomas*, a sort of Christians in a peninsula of India, on this side of the gulf: they inhabit chiefly at Cranganor, and the neighbouring country; these admit of no images, and receive only the cross, to which they pay a great veneration: they affirm, that the souls of the saints do not see God till after the day of judgment: they acknowledge but three sacraments, *viz.* baptism, orders, and the eucharist: they make no use of holy oils in the administration of baptism, but after the ceremony anoint the infant with an unction composed of oil and walnuts, without any benediction. In the eucharist, they consecrate with little cakes made of oil and salt, and instead of wine make use of water in which raisins have been infused.

CHRISTIANA, a town of Norway, in the province of Aggerhuys, situated on a bay of the sea, a hundred miles north of Gottenburgh: E. long.  $10^{\circ} 15'$ , N. lat.  $59^{\circ} 30'$ .

CHRISTIANOPLE, a port-town of Sweden, situated on the Baltic sea, in the territory of Bleking, and province South Gothland, about thirteen miles north-east of Carlescroon: E. long.  $15^{\circ} 40'$ , and N. lat.  $57^{\circ}$ .

CHRISTIANSBURGH, a Danish factory upon the gold-coast of Africa, near Acra.

CHRISTIANSTADT, a town of Sweden, situated on the river Helles, in the territory of Bleking, and province of South Gothland, forty-five miles west of Carlescroon: E. long.  $14^{\circ} 40'$ , N. lat.  $56^{\circ} 30'$ .

CHRISTMAS, a festival of the Christian church, observed on the 25th of December, in memory of the nativity of Jesus Christ.

CHRISTOPHER-herb, in botany. See CHRISTOPHORIANA.

CHRISTOPHERS, or *St CHRISTOPHERS*, one of the Caribbee islands, to which Columbus gave his Christian name: W. long.  $62^{\circ}$ , N. lat.  $71^{\circ} 30'$ .

It is about twenty miles long, and seven broad;

and has a high mountain in the middle, from whence some rivulets run down. Its produce is chiefly sugar, cotton, ginger, and indigo. It is a British colony, and lies about sixty miles west of Antego.

CHRISTOPHORIANA, in botany. See АСТРА.

CHROASTACES, in natural history, a genus of pellucid gems, comprehending all those of variable colours, as viewed in different lights; of which kinds are the opal and the asteria, or oculus cati. See OPAL, and ASTERIA.

CHROMA, in music, a note or character of time, usually termed a quaver.

Chroma is also a graceful way of singing, or playing with quavers and trilloes.

CHROMATIC, in the ancient music, the second of the three kinds into which the consonant intervals were subdivided into their concinnous parts. The other two kinds are enharmonic and diatonic.

CHROMATIC, in painting, a term used to signify the colouring, which makes the third part in the art of painting.

CHROMIS, in ichthyology. See SPARUS.

CHRONIC, or CHRONICAL, among physicians, an appellation given to diseases that continue a long time, in contradistinction to those that soon terminate, and are called *acute*. See MEDICINE.

CHRONICLE, in matters of literature, a species or kind of history, disposed according to the order of time, and agreeing in most respects with annals. See ANNALS.

*Books of CHRONICLES*, in the canon of scripture, two sacred books, called by the Greeks *paralipomena*, that is, remains, additions, or supplements, as containing many circumstances omitted in the other historical books.

CHRONOGRAM, a species of false wit, consisting in this, that a certain date or epocha is expressed by numeral letters of one or more verses: such is that which makes the motto of a medal struck by Gustavus Adolphus, in 1632.

CHRISTVS DVX, ergo trIVMphVs.

CHRONOLOGY, the science or doctrine of time; in so far as it regards history, whether civil or ecclesiastical.

The business of chronology, is to ascertain and adjust the various epochas, æras, and other periods mentioned in history; so that the revolutions of empires and kingdoms, and other remarkable events, may be truly stated. For the principles of chronology, see ASTRONOMY, *Of the division of time*.

CHRONOMETER, in general, denotes any instrument or machine, used in measuring time; such are dials, clocks, watches, &c. See CLOCK, DIAL, &c.

CHRONOSCOPE, denotes much the same with chronometer. See the preceding article.

CHROSTASIMA, in natural history, a genus of pellucid gems, comprehending all those which appear of one simple and permanent colour in all lights: such are the diamond, carbuncle, ruby, garnet, amethyst, sapphire, beryl, emerald, and the topaz. See DIAMOND, CARBUNCLE, &c.

**CHRYSÆTUS**, in ornithology. See **FALCO**.

**CHRYSALIS**, in natural history, a state of rest and seeming insensibility which butterflies, moths, and several other kinds of insects, must pass through before they arrive at their winged or most perfect state. See **NATURAL HISTORY**.

**CHRYSANTHEMOIDES**, in botany. See **OSTEOSPERMUM**.

**CHRYSANTHEMUM**, in botany, a genus of plants belonging to the syngenesia polygamia superflua class. The receptacle is naked, it has no pappus; the calix is hemispherical and imbricated; and the scales on the margin are membranaceous. There are nineteen species, two of which are natives of Britain, *viz.* the fegetum, or corn mary-gold; and the leucanthemum, or ox-eye daisy.

**CHRYSOBALANUS**, in botany, a genus of the icandria monogynia class. The corolla consists of five petals; the calix has five teeth; and the drupa contains a nut with five furrows. There is but one species, *viz.* the icaco, a native of America.

**CHRYSOBERYL**, a kind of beryl with a tincture of yellow. See **BERYL**.

**CHRYSOCOLLA**, in natural history, a species of green ochres. See **OGHRA**.

**CHRYSOCOMA**, in botany, a genus of plants belonging to the syngenesia polygamia æqualis class. The receptacle is naked; the pappus is simple; the calix is imbricated and hemispherical; and the stylus is hardly longer than the floccules. There are nine species, none of which are natives of Britain.

**CRYSOGONUM**, or **MOTH-MULLEIN**, in botany, a genus of plants belonging to the syngenesia polygamia necessaria class. The receptacle is paleaceous; the pappus is monophyllous, and three-toothed; the calix consists of five leaves; and the seeds are caliculated, and involved in four leaves. There is but one species, a native of Virginia.

**CHRYSOLITE**, in natural history, a gem which the ancients knew under the name of the topaz; and the true chrysolite of the ancients, which had its name from its fine gold-yellow colour, is now universally called topaz by modern jewellers. See **TOPAZ**.

**CHRYSOLITE-paste**, a kind of glass made in imitation of natural chrysolite, by mixing two ounces of prepared crystal, with ten ounces of red-lead, adding twelve grains of crocus martis made with vinegar; and then baking the whole for twenty-four hours, or longer, in a well luted cucurbit.

**CHRYSOMELA**, in zoology, a genus of insects, belonging to the order of coleoptera. The antennæ are shaped like bracelets, and thicker on the outside; and neither the breast nor the elytra are marginated. There are no less than 122 species, principally distinguished by differences in their colour.

**CHRYSOPHYLLUM**, in botany, a genus of the pentandria monogynia class. The corolla is bell-shaped, and divided into ten segments, which alternately spread wider; and the berry contains ten seeds. There are but two species, both natives of America.

**CHRYSOPRASUS**, or **CHRYSOPRASIVUS**, the tenth

of the precious stones, mentioned in the Revelations, as forming the foundation of the heavenly Jerusalem.

The chrysoprasius is a species of prasius, of a pale but pure green colour, with an admixture of yellow.

**CHRYSOSPLENIUM**, in botany, a genus of the decandria digynia class. The calix is divided into four or five coloured segments; it has no corolla; and the capsule has two beaks, and one cell containing many seeds. The species are two, *viz.* the alternifolium, or alternate-leaved golden saxifrage; and the oppositifolium, or common golden saxifrage; both natives of Britain.

**CRYSTAL**, or **CRYSTAL**. See **CRYSTAL**.

**CHUB**, or **CHUBB**, in ichthyology. See **CYPRINUS**.

**CHURCH**, has different significations, according to the different subjects to which it is applied. 1. It is understood of the collective body of Christians, or all those over the face of the whole earth who profess to believe in Christ, and acknowledge him to be the Saviour of mankind. This is what the ancient writers call the catholic or universal church. Sometimes the word church is considered in a more extensive sense, and divided into several branches; as the church militant, is the assembly of the faithful on earth; the church triumphant, that of the faithful already in glory; to which the Papists add the church patient, which, according to their doctrines, is that of the faithful in purgatory.

2. Church is applied to any particular congregation of Christians, who associate together and concur in the participation of all the institutions of Jesus Christ, with their proper pastors and ministers. Thus we read of the church of Antioch, the church of Alexandria, the church of Thessalonica, and the like.

3. Church denotes a particular sect of Christians distinguished by particular doctrines and ceremonies. In this sense, we speak of the Romish church, the Greek church, the reformed church, the church of England, &c.

The Latin or western church, comprehends all the churches of Italy, France, Spain, Africa, the north, and all other countries whither the Romans carried their language. G. Britain, part of the Netherlands, of Germany, and of the North, have been separated from hence ever since the time of Henry VIII. and constitute what we call the reformed church, and what the Romanists call the western schism.

The Greek or eastern church, comprehends the churches of all the countries anciently subject to the Greek or eastern empire, and through which their language was carried; that is, all the space extended from Greece to Mesopotamia and Persia, and thence into Egypt. This church has been divided from the Roman, ever since the time of the emperor Phocas.

The Gallican church, denotes the church of France, under the government and direction of their respective bishops and pastors. This church has always enjoyed certain franchises and immunities, not as grants from popes, but as derived to her from her first original, and which she has taken care never to relinquish. These liberties depend upon two maxims; the first, that the

pope

pope has no authority or right to command or order any thing either in general or in particular, in which the temporalities and civil rights of the kingdom are concerned; the second, that notwithstanding the pope's supremacy is owned in cases purely spiritual, yet, in France, his power is limited and regulated by the decrees and canons of ancient councils received in that realm.

4. The word church is used to signify the body of ecclesiastics, or the clergy, in contradistinction to the laity. See CLERGY.

5. Church is used for the place where a particular congregation or society of Christians assemble for the celebration of divine service. In this sense, churches are variously denominated, according to the rank, degree, discipline, &c. as metropolitan church, patriarchal church, cathedral church, parochial church, collegiate church, &c. See METROPOLIS, PATRIARCH, &c.

CHURCH-reeves, the same with church-wardens.

CHURCH-STRETTON, a market-town of Shropshire, about twelve miles south of Shrewsbury: W. long.  $2^{\circ} 50'$ , N. lat.  $52^{\circ} 35'$ .

CHURCH-wardens, formerly called church-reeves, are officers chosen yearly, in Easter week, by the minister and parishoners of every parish, to look after the church, church-yard, church-revenues, &c. also to observe the behaviour of the parishoners in relation to such misdemeanors as appertain to the censure or jurisdiction of the ecclesiastical court.

They are to be chosen by the joint consent of the minister and his parishoners; and by custom, the minister may chuse one, and the parishoners another; or, if there be a custom for it, the parishoners may elect both, though it is against the canon. They were sworn into their office by the archdeacon; and if he refuses to swear a church-warden, a mandamus may issue out to compel him: for as the church-wardens have a trust reposed in them by the parish, as temporal officers, the parishoners are the proper judges of their abilities to serve, and not the archdeacon who swears them.

The church wardens are a corporation: to sue, and be sued, for the goods of the church: they are to take care of the repairs of the church; and if they erect or add any thing new to the same, they must have the consent of the parishoners, or vestry; and if in the church, the license of the ordinary: they have, with consent of the minister, the placing of the parishoners in the seats of the body of the church, appointing gallery keepers, &c. reserving to the ordinary a power to correct the same. In London, the church-wardens have this authority in themselves: there also they are bound to fix fire-cocks, keep engines, &c. in their parishes, under the penalty of 10*l*.

Besides their ordinary power, the church-wardens have the care of the benefice during its vacancy: they are to join with the overseers of the poor in making rates for their relief, setting up trades for employing them, placing out poor apprentices, settling poor

persons, &c. It is their duty to collect the charity money upon briefs read in churches; they are to sign the certificates of those persons who receive the sacrament, to qualify them to bear offices, &c.

CHURCHING of women after child-birth, an office in the liturgy, containing a thanksgiving to be used by women after being delivered from the great pain and peril of child-birth.

CHURN-OWL, in ornithology. See CAPRIMULGUS.

CHURN-WORM, in zoology. See GRYLLOALPA.

CHUSAN, or CHEUXAN, an island on the eastern coast of China, near the province of Chekiang: E. long.  $124^{\circ}$ , N. lat.  $30^{\circ} 40'$ .

CHUSISTAN, a province in the south-west part of Persia, bounded by the gulph of Persia on the south, and by the province of Eyraca Agem on the north.

CHUTON, CHUTTON, a market-town of-Somerfetshire, about seven miles north-east of Wells: W. long.  $2^{\circ} 36'$ , N. lat.  $51^{\circ} 25'$ .

CHYLE, in the animal economy, a milky fluid, secreted from the aliments by means of digestion.

The principles of the chyle seem to be sulphureous, mucilaginous, saline, and aqueous. It is a kind of natural emulsion, both with regard to the colour, the ingredients, and the manner of preparation. There is the difference between the artificial and natural emulsion, that the latter is far more pure, and is prepared with much greater apparatus, not by the sudden expression of part of the liquid, but by a gentle and successive percolation. The chyle is made sooner or later, according to the difference of the temperaments, strength, aliments and customs: therefore how many hours chylification requires, cannot be certainly determined. When the chyle enters the villous oscula of the lacteals, it is not a fluid extracted merely from the aliment and drink, but a mixture of fluids; that is, the saliva and thinner mucus of the mouth, and the two fluids of the œsophagus, one proceeding from the villous membrane of the tube itself, the other from its glands. To these may be added the glutinous fluid of the stomach, the pancreatic juice, the fluid of peyer's glands, which are very numerous in the small intestines. Hence the reason appears, why men may live upon bread and water, why the oriental nations use rice in the room of all kinds of pulse, and why acids, spirituous liquors, saline things, and many vegetable juices, herbs, roots, acrid and aromatic substances, are the least fit to generate chyle.

CHYLIFICATION, the formation of the chyle, or the act whereby the food is changed into chyle.

Chylification commences by comminuting the aliment in the mouth, mixing it with saliva, and chewing it with the teeth; by these means the food is reduced into a kind of pulp, which, being received into the stomach, mixes with the juices thereof; and thus diluted, begins to ferment or putrify, and, assuming a very different form from what it had before, grows either acid or rancid. Here it meets with a juice separated from the blood by the glands of that part; whose excretory ducts open into the cavity of the stomach.

Stomach: by the commixture of these liquors, whether of saliva or the juice of the stomach, a proper menstruum is composed, by which the parts of the aliment are still more and more divided by its insinuating into their pores, and acquire still a greater likeness to the animal fluids. The stomach, by means of its muscular fibres, contracting itself, does gradually discharge its contents by the pylorus into the duodenum; in which gut, after a small semicircular descent, it meets with the pancreatic juice and bile; both which joining it, renders some part of the aliment more fluid, by still disuniting the grosser part from the more pure, and here the chylification is made perfect. The bile which abounds with lixivial salts, and apt to entangle with the grosser parts of the concocted aliment, stimulates the guts, and cleanses their cavities of the mucous matter separated from the blood by the glands of the guts, and lodged in their cavities; which not only moistens the inside of the guts, but defends the mouth of the lacteal vessels from being injured by alien bodies which often pass that way.

The contents of the intestines move still on, by means of the peristaltic motion of the guts; whilst those thinner parts, fitted to the pores of the lacteal vessels, are absorbed by them: the thicker move still more slowly on, and by the many stops they continually meet with by the connivent valves, all the chyle or thin parts are at length entirely absorbed: the remains being merely excrementitious, are only fit to be protruded by stool.

In the passage through the small intestines, the finer part of the mass, which we call the chyle (as has been already observed) enters the orifices of the lacteal vessels of the first kind, wherewith the whole mesentery is intermixed, which either alone, or together with the meseraic veins, discharge themselves into the glands, at the basis of the mesentery.

Then the chyle is taken up by the lacteals of the second kind, and is conveyed into glands between the two tendons of the diaphragm, called Pecquet's reservoir; whence it is carried to the heart by the thoracic duct, and the subclavian vein: and here it first mixes with the blood, and in time becomes assimilated thereto.

**CHYLOSIS**, among physicians, the act of reducing the aliment in the stomach to chyle.

**CHYME**, or **CHYMUS**, in the common signification of the word, denotes every kind of humour which is intrassated by concoction, under which notion it comprehends all the humours fit or unfit for preserving and nourishing the body, whether good or bad. It frequently imports the finest part of the chyle, when separated from the feces, and contained in the lacteal and thoracic duct.

**CHYMISTRY**, or **CHEMISTRY**. See **CHEMISTRY**.

**CHYMOLOGI**, an appellation given to such naturalists as have employed their time in investigating the properties of plants from their taste and smell.

**CHYMOSIS**, in medicine, the act of making or preparing chyme. See **CHYME**.

**CHYMOSIS** is also a distortion of the eye-lids, arising

from an inflammation; also an inflammation of the cornea tunica in the eye.

**CIALIS**, the name of the capital of a kingdom of that name in independent Tartary, situated on the road from Samarcand to China.

**CIBDELOPLACIA**, in natural history, a genus of spars debased by a very large admixture of earth: they are opaque, formed of thin crusts, covering vegetables and other bodies, by way of incrustations.

Of this genus we have the following species: 1. A greyish-white one, with a rough surface. 2. A whitish brown one: both these are friable. 3. A hard, pale-brown kind, which is the ostecolla of the shops. 4. The whitish-grey kind, with a smooth surface: this is the unicornu fossile and ceratites of authors. 5. The whitish-brown coralloide kind.

**CIBDELOSTRACIA**, in natural history, terrene spars, destitute of all brightness and transparency, formed into thin plates, and usually found coating over the sides of fissures, and other cavities of stone, with congeries of them of great extent, and of plain or botroyide surfaces.

Of these there are usually reckoned seven kinds: the first is the hard, brownish-white cibdelostracium, found in Germany: the second is the hard, whitish cibdelostracium, with thin crusts, and a smoother surface, found also in the Harts-forest in Germany: the third is the hard, pale-brown cibdelostracium, with numerous very thin crusts, found in subterranean caverns in many parts of England as well as Germany: the fourth is the white, light, and friable cibdelostracium, found also in Germany, but very rarely in any part of England: the fifth is the light, hard, pale-brown cibdelostracium, with a smooth surface, found in almost all parts of the world: the sixth is the whitish, friable, crustaceous cibdelostracium, with a rougher surface, frequent in Germany and England; and the seventh is the brownish white, friable cibdelostracium, with a dusty surface, found in several parts of Ireland, as well as Germany.

**CICADIA**, in zoology, a genus of insects belonging to the order of hemiptera. The beak is insected; the antennæ are setaceous; the four wings are membranaceous and deflected; and the feet, in most of the species, are of the jumping kind. The species are fifty-one. The larvæ of several of this genus evacuate great quantities of a frothy matter upon the branches and leaves of plants, in the midst of which they constantly reside.

**CICATRICULA**, among natural historians, denotes a small whitish speck in the yolk of an egg, supposed to be the first rudiments of the future chick.

**CICATRIX**, in surgery, a little seam or elevation of callous flesh rising on the skin, and remaining there after the healing of a wound or ulcer. It is commonly called a scar. See **SURGERY**.

**CICATRIZANTS**, in pharmacy, medicines which assist nature to form a cicatrix. Such are arminian bole, powder of tutty, dissecativum rubrum, &c.

Cicatrizzants are otherwise called escharotics, epulotics, incarnatives, agglutinants, &c.

**CICELY**.

**CICELY.** See **MYRRHIS.**

**CICER,** or **CHICK-PEA,** in botany, a genus of the dialiophia decandria class. The calix is divided into five segments, of the same length with the corolla, the four uppermost segments lying upon the vexillum; and the legumen or pod is turgid, rhomboidal, and contains two seeds. There is but one species, viz. the arietinum, a native of Spain.

**CICERBITA,** in botany. See **SONCHUS.**

**CICHORIUM,** or **SUCCORY,** in botany, a genus of the syngenesia polygamia æqualis class. The receptacle is paleaceous; the calix is caliculated; and the pappus has five teeth on its margin. The species are three. Only one of which, viz. the intybus, or wild cichory, is a native of Britain. The leaves and root are detergent, aperient, and attenuating.

**CICINDELIA,** in zoology, a genus of insects belonging to the order of coleoptera. The antennæ are setaceous; the jaws are prominent, and furnished with teeth; the eyes are a little prominent; and the breast is roundish and marginated. There are fourteen species.

**CICONIA,** in ornithology. See **ARDEA.**

**CICUTA,** in botany, a genus of the pentandria digynia class. The fruit is furrowed and ovated. The species are three, only one of which, viz. the virosa, or long-leaved water-hemlock, is a native of Britain.

**CICUTA** is also a synonyme of the conium. See **CONIUM.**

**CICUTARIA,** in botany, a synonyme of the æthusa, phellandrium, &c.

**CIDARIS,** in antiquity, the mitre used by the Jewish high-priests. The Rabbins say, that the bonnet used by priests in general was made of a piece of linen-cloth sixteen yards long, which covered their heads like a helmet or a turban: and they allow no other difference between the high-priest's bonnet, and that of other priests, than this, that one is flatter and more in the form of a turban; whereas that worn by ordinary priests, rose something more in a point.

**CIDARIS,** in conchyliology, the trivial name of a species of echinus. See **ECHINUS.**

**CIFALU,** or **CEFALEDI,** a port-town of Sicily, thirty-six miles east of Palermo: E. long. 13° 32', N. lat. 38° 30'.

**CILIA,** the **EYE-LASHES,** in anatomy. See Vol. I. p. 291.

**CILIARE,** or **LIGAMENTUM CILIARE,** in anatomy. See Vol. I. p. 290.

**CILIARIS,** in anatomy. See Vol. I. p. 291.

**CILIATED leaf,** among botanical writers, one surrounded all the way with parallel filaments, somewhat like the hairs of the eye-lids.

**CILICIUM,** in Hebrew antiquity, a sort of habit made of coarse stuff, formerly in use among the Jews in times of mourning and distress. It is the same with what the Septuagint and Hebrew versions call sack-cloth.

**CILLEY,** the capital of a territory of the same name in Stiria, and the circle of Austria in Germany: E. lon. 15° 35', N. lat. 46° 35'.

VOL. II. No. 38.

**CIMA,** or **SIMA,** in architecture, the same with **cymatium** or **ogee.** See **OGEE.**

**CIMEX,** or **BUG,** in zoology, a genus of insects belonging to the order of hemiptera. Linnæus enumerates no less than 121 species. The lectularius, or common house bug, is a well known insect. The methods of expelling them are various; as, oil of turpentine, the smoke of corn-mint, of narrow-leaved wild cress, of herb-robert, of the reddish agaric, of mustard, of Guiney pepper, of peats or turf, &c. But cleanliness is the only remedy against vermin of every kind.

**CIMOLIA terra,** in natural history, a species of white marle, which is ponderous and friable, and makes a considerable effervescence with aqua fortis.

**CINALOA,** a province of Mexico, in North America, lying on the Pacific Ocean, opposite to the south end of California.

**CINAN,** a city of China, the metropolis of the province of Zantung, situated in 37° N. lat. and 30' east of Pekin.

**CINCHONA,** in botany, a genus of the pentandria monogynia class. The corolla is bell-shaped; and the capsule is below the flower, and opens at the base. There is but one species, viz. the officinalis, a native of Peru. The Peruvian bark, which is the bark of this tree, is brought to us in pieces of different sizes, sometimes rolled up into short thick quills, and sometimes flat: the outside is brownish, and generally covered in part with a whitish moss; the inside is of a yellowish, reddish, or rusty iron colour. It has a lightly aromatic smell, somewhat musty, yet not disagreeable; a bitterish, astringent taste, which dwells long upon the tongue, accompanied with a degree of aromatic warmth. The small, thin, flat pieces are by some accounted the best; by others, the quill sort, with the roughest coat, especially if of a bright cinnamon colour on the inside; though the large flat pieces, whether rough or smooth, of a lighter or darker colour, are often of equal goodness. The best bark is that which is strongest in smell and taste: this likewise proves friable betwixt the teeth, and does not separate into fibres; it breaks, not shivery, but close and smooth.

The virtues of this bark, as a febrifuge, were discovered by the Indians about the year 1500: Europe did not become acquainted with it till 1649: nor was it received into general practice till several years after this; some ill consequences ensuing from its imprudent use, having brought it for a time into disrepute. At present, it is looked upon as the most effectual remedy in intermittent fevers of almost every kind, and safe in all ages and constitutions; provided it be judiciously and seasonably administered, and due regard be had to the circumstances of the disease. The modern practice, previous to the use of this medicine, usually gives an emetic at the beginning of a paroxysm: in some cases a cathartic, and in plethoric habits venæsection, are premised: these render the bark not only more safe, but likewise more certain and speedy in its operation: where these evacuations are neglected, or not sufficiently plentiful, the disease, if of long standing,

standing, scarce yields to the *cortex*; or if it appears at length subdued, yet the patient does not recover his strength, and soon suffers a relapse. The use of the bark is begun at the end of a paroxysm, and repeated, in the quantity of half a dram (more or less, according to the circumstances of the patient) every third or fourth hour during the intermission: where the fever is of the bilious kind, and accompanied with great heat, a little nitre is joined: in all cases, moderate exercise generally promotes its effect. At first, it usually loosens the belly, and sometimes operates as if a cathartic had been taken; and by this means supplies the omission of evacuations before its exhibition: if the purging continues, the medicine does not answer the purposes intended by it: in such case, a little opium is added, which effectually suppresses the flux: if after this the patient continues too colicive, recourse is had to glysters. The looseness, however, ought not to be stopt too soon: on the contrary, where the bark does not itself produce this effect, it is necessary, as Dr Mead informs us, to join to it a little rhubarb, so as to occasion for a time two stools a day; by this means the disease is more effectually cured, and less subject to be followed by a dropsy, or ill habit of body: after a dram or two of rhubarb have been taken, it is to be discontinued, and the bark exhibited by itself. After the fever has been removed, the medicine is continued for some time longer, to prevent a relapse; and evacuations, unless absolutely necessary, abstained from. The disease is nevertheless seldom completely cured before some very considerable evacuation, either by stool, urine, or perspiration, ensues: if this does not succeed spontaneously, cathartics, diuretics, or diaphoretics, are given in conjunction with the bark; otherwise the patient continues weak, and without appetite, till either the disease returns, or changes into one of a different kind.

In symptomatic agues, hectic and purulent fevers, cacochymic habits, and where the hypochondres are swelled and distended, this medicine is improper, and for the most part prejudicial. Its manifest astringency forbids its use in obstructions of the abdominal viscera, or suppression of any critical evacuation; until the obstruction is first removed, or the evacuation had its due course.

In acute, inflammatory, or malignant fevers, the bark does not seem to have any good effect. Nevertheless, in the decline of long nervous fevers, or after a remission, when from bad habit, old age, fatigue, or the like, the patient is extremely weak, and the pulse low, the *cortex* proves a medicine of excellent service; provided that there is no extravasation, that the vessels remain entire, and pus is not already formed.

Peruvian bark has likewise been found eminently serviceable in gangrenes and mortifications, proceeding either from an internal or external cause. In all the cases of this kind, where it proved successful, it occasioned a kind suppuration, which degenerated when the use of the medicine was discontinued, and again turned kindly upon resuming it. Some have been

hence induced to try the *cortex* in various cases, where either the pustules did not rightly suppurate, or petechiæ shewed a disposition to a gangrene; and here likewise it answered expectation: the empty vesicles filled with matter, watery sanies changed into thick white pus, the petechiæ became gradually of a pale colour, and at length disappeared, and the pox began to turn sooner than was expected.

The bark has been applied likewise, and not without success, to the cure of periodic head-achs, hysterical and hypochondriac fits, and other disorders, which have regular intermissions. By its astringency and aromatic quality, it strengthens the whole nervous system, and proves useful in weakness of the stomach, and sundry chronical disorders, proceeding from too great laxity of the fibres. In obstinate uterine fluxes, and old gleets, bark joined with chalybeates has notable effects.

The virtues of Peruvian bark reside chiefly in a resinous substance, and hence are extracted in perfection by rectified spirit. By strong coction in water, the resin is melted out, and mingled with the water; which whilst hot appears transparent, but in cooling grows turbid, and deposits great part of the resin to the bottom. Water elevates in distillation the aromatic part of the bark; pure spirit brings over nothing. Hence an aqueous extract proves not only less in quantity, but likewise inferior in quality to one made with rectified spirit. Proof-spirit extracts the virtues of this drug in tolerable perfection, in the cold; heat enables it to take up more than it can retain when cold. Spirit of sal ammoniac, prepared with fixt alkaline salts, gains very little from the *cortex*, either with or without heat: the spirit prepared with quicklime, and the dulcified spirit, in a few hours become strongly impregnated with its smell and taste.

The officinal preparations of bark are an extract resin, spirituous tincture, tincture in volatile spirit, and compound tincture. It is an ingredient also in the stomachic tincture.

The substances usually joined with bark in prescription seem calculated either to promote its efficacy, or merely for reducing it into the intended form; without much regard to its agreeableness, and the convenience of taking it: this is nevertheless a point of great consequence, as its taste, and the quantity which is necessary, make the patient too frequently loath it, before enough has been taken to produce the desired effect. If designed to be given in the solid form of a bolus, electuary, &c. it should be made up, not, as is customary, with syrups, but with mucilages: with the former, it sticks about the mouth and fauces, whence its taste remains for a considerable time; with the latter, it passes freely, scarce leaving any taste in the mouth. Aromatics do not prevent the taste of the bark from discovering itself; extract of liquorice very effectually conceals it. The extract of logwood also, joined to that of bark, and a proper quantity of mucilage, form a very elegant and agreeable composition.

CINCLUS, in ornithology. See TRINGA.

CINCTURE,



**CINCTURE**, or **CEINTURE**, in architecture, a ring, list, or orlo at the top and bottom of the shaft of a column, separating the shaft at one end from the base, and at the other from the capital. See **ARCHITECTURE**.

**CINERARIA**, in ornithology. See **MOTACILLA**.

**CINNABAR**, in natural history, is either native or factitious. The native cinnabar is an ore of quick-silver, moderately compact, very heavy, and of an elegant, striated red colour. In this ore the quick-silver is blended in different proportions with sulphur. It is so rich an ore, as to be no other than mercury impregnated with a small quantity of sulphur, just enough to reduce it to that state, being commonly more than six parts of mercury to one of sulphur; and even the purest cinnabar yields one half mercury: it is of a very bright, glittering appearance, when fresh broken, and is usually found lodged in a bluish, indurated clay, though sometimes in a greenish talcy stone.

For the method of separating mercury from cinnabar, see **MERCURY**.

**Factitious CINNABAR**, a mixture of mercury and sulphur sublimed, and thus reduced into a fine red glebe. The best is of a high colour, and full of fibres, like needles.

The receipt for making it, according to the late college-dispensatory, is as follows. Take of purified quick-silver, twenty-five ounces; of sulphur, seven ounces; melt the sulphur, and stir the quick-silver into it while fluid; if it take fire, let it be immediately extinguished, by covering it with another vessel. When cold, let it be rubbed into a fine powder. Let this powder be put into a subliming vessel, and setting it over a gentle fire, raise it by degrees till the whole is sublimed into a red, striated, heavy mass, which perfectly resembles native cinnabar. This, as well as the native cinnabar, is excellent in epilepsies, and in all complaints of the head and nerves. But the factitious is rather to be preferred, as it doth not excite nausea, vomitings, and other disorders which arise from vitriolic and perhaps arsenical particles blended by nature among some of the masses of the native mineral.

Cinnabar is likewise used by painters as a colour, and is rendered more beautiful, by grinding it with gum-water and a little saffron.

**CINNAMON-TREE**, in botany. See **LAURUS**.

**CINNAMON-WATER** is made by distilling the bark first infused in spirit of wine, brandy, or white-wine.

**Glove-CINNAMON** is the bark of a tree growing in Brazil, which is often substituted for real cloves.

**White CINNAMON**, called also **Winter's bark**, is the bark of a tree frequent in the islands of St Domingo, Guadalupe, &c. of a sharp biting taste like pepper. Some use it instead of nutmeg; and in medicine it is esteemed a stomachic and antiscorbutic.

**CINOLOA**, or **CINALOA**, the capital of the province of Cinaloa, in North America, about thirty miles east of the bay of California: W. long. 113°, and N. lat. 25°. See **CINALOA**.

**CINQUEFOIL**, *quinquefolium*, in botany. See **POTENTILLA**.

**CINQUE-PORTS**, an appellation given to five port-towns, situated on the coast of Kent and Sussex, over-against France, and famous in English history.

The cinque ports are Hastings, Dover, Hithe, Romney, and Sandwich; which have had large privileges granted them, on account of their former great importance, being then not only the keys of the kingdom, but considerable for their maritime strength: thus, we are told, that they were obliged to provide eighty ships at their own charge for forty days, as often as the king should have occasion in his wars.

**CINQUE-PORT** is also a particular kind of fishing-net much used in standing water, so called on account of the five entrances into it.

**CINTRA**, a cape and mountain of Portugal, in the province of Estremadura, usually called the rock of Lisbon, situated on the north side of the entrance of the river Tagus: W. long. 10° 15', N. lat. 39°.

**CINYRA**, or **CINNOR**, in Jewish antiquity, generally translated cithara, lyra, &c. a musical instrument used before the flood, and invented by Jubah the son of Lamech.

**CION**, or **CYON**, among gardeners, denotes a young sprig, or sprout of a tree.

**CIPHER**, or **CYPHER**, one of the Arabic characters, or figures, used in computation, formed thus, 0. See **ARITHMETIC**.

**CIPHER** is also a kind of enigmatic character, composed of several letters interwoven, which are generally the initial letters of the persons names for whom the ciphers are intended.

**CIPHER** denotes likewise certain secret characters disguised and varied, used in writing letters that contain some secret, not to be understood but by those between whom the cipher is agreed on.

**CIPPUS**, in antiquity, a low column, with an inscription, erected on the high roads, or other places, to shew the way to travellers, to serve as a boundary, to mark the grave of a deceased person, &c.

**CIRCÆA**, or **ENCHANTERS NIGHTSHADE**, in botany, a genus of the diandria-monogynia class. The corolla consists of two petals; the corolla has likewise two leaves; and the capsule contains but one seed. The species are three, two of which are natives of Britain, *viz.* the luitiana, or enchanters-nightshade; and the alpina, or mountain enchanters-nightshade.

**CIRCASSIA**, a country situated between 40° and 50° E. long. and between 45° and 50° N. lat.

It is bounded by Russia on the north, by Astracæn and the Caspian-sea on the east, by Georgia and Daghestan on the south, and by the river Don and the Palus Mæotis on the west.

The Circassian Tartars form a kind of republic, but sometimes put themselves under the protection of Persia, and sometimes of Russia, or the Turks. They live mostly in tents, removing from place to place for the benefit of pasturage; and are chiefly remarkable for the beauty of their children, the seraglios of Turkey and

and Persia being usually supplied with boys and young virgins from this and the neighbouring country of Georgia.

**CIRCENSIAN GAMES**, a general term under which was comprehended all combats exhibited in the Roman circus, in imitation of the Olympic games in Greece. Most of the feasts of the Romans were accompanied with Circensian games; and the magistrates, and other officers of the republic, frequently presented the people with them, in order to procure their favour. The grand games were held five days, commencing on the 15th of September. There were six kinds of games exhibited: the first was wrestling, and fighting with swords, with staves, and with pikes; the second was racing; the third, leaping; the fourth, quoits, arrows, and cestus; all which were on foot; the fifth was horse-coursing: the sixth courses of chariots.

**CIRCIA**, in ornithology, a species of anas, called in english the summer-teal, and all over of a dusky yellowish brown, with black feet.

**CIRCINALIS**, in botany, a name used by some for *Adiantum*, maiden-hair. See **ADIANTUM**.

**CIRCLE**, in geometry, a plane figure comprehended by a single curve line, called its circumference, to which right lines drawn from a point in the middle, called the centre, are equal to each other. To find the area of a circle, see **PRACTICAL GEOMETRY**.

**CIRCLES of the sphere**. See **GEOGRAPHY** and **ASTRONOMY**.

**CIRCLES of latitude**. See **GEOGRAPHY**.

**CIRCLES of longitude**. See **GEOGRAPHY**.

**Horary CIRCLES**, in dialling, are the lines which shew the hours on dials, though these be not drawn circular, but nearly straight. See **DIALLING**.

**Horary CIRCLE**, on the globe. See **GEOGRAPHY**.

**Polar CIRCLE**. See **GEOGRAPHY**.

**CIRCLE**, in logic, or *logical CIRCLE*, is when the same terms are proved *in orbem* by the same terms; and the parts of the syllogism alternately by each other, both directly and indirectly.

**CIRCLES of the empire**, such provinces and principalities of the German empire as have a right to be present at diets. Maximilian I. divided the empire into six, and some years after into ten circles. This last division was confirmed by Charles V. The circles, as they stand in the Imperial Matricola, are as follows, Austria, Burgundy, the Lower Rhine, Bavaria, Upper Saxony, Franconia, Swabia, Upper Rhine, Westphalia, and the Lower Saxony.

**CIRCOLO MEZZO**, in the Italian music, denotes a diminution of four quavers or semiquavers, which represent a semicircle, proceeding by conjoint degrees.

**CIRCUIT**, in law, signifies a longer course of proceedings than is needful to recover the thing sued for.

**CIRCUIT**, also signifies the journey, or progress, which the judgestake twice every year, through the several counties of England and Wales, to hold courts and administer justice, where recourse cannot be had to the king's courts at Westminster: hence England is divided into six circuits, *viz.* the Home circuit, Norfolk circuit,

Midland circuit, Oxford circuit, Western circuit, and Northern circuit.

In Wales there are but two circuits, North and South Wales: two judges are assigned by the king's commission to every circuit.

**CIRCUIT court**, in Scots law, the judges of the supreme criminal court, or court of justiciary, are divided into three separate courts, consisting of two judges each; and the kingdom into as many districts. In certain boroughs of every district, each of these courts by rotation are obliged to hold two courts in the year, in spring and autumn; which are called circuit courts. See **SCOTS LAW**, *Of the supreme judges and courts of Scotland*.

**CIRCULAR**, in a general sense, any thing that is described or moved in a round, as the circumference of a circle, or surface of a globe.

**CIRCULAR NUMBERS**, called also spherical ones, according to some, are such whose powers terminate in the roots themselves.

Thus, for instance, 5 and 6, all whose powers do end in 5 and 6, as the square of 5 is 25, the square of 6 is 36, &c.

**CIRCULAR SAILING** is the method of sailing by the arch of a great circle. See **NAVIGATION**.

**CIRCULATION**, the act of moving round, or in a circle: thus we say, the circulation of the blood, &c.

**CIRCULATION of the blood**, the natural motion of the blood in a living animal, whereby that fluid is alternately carried from the heart into all parts of the body, by the arteries, from whence it is brought back to the heart again by the veins.

This motion is chiefly caused by the dilatation and contraction of this organ, and is the principle on which life depends; for when it ceases in any part, it dies; when it is diminished, the operations are weak; and, when it ceases totally, life is extinguished.

All the veins discharge themselves into the ventricles of the heart; from hence all the arteries arise: the blood expelled out of the right ventricle must be carried, through the pulmonary artery, into the lungs; from which it must be returned, by the pulmonary veins, to the left ventricle; from the left ventricle the blood, thus imported, is, by the constriction of that part, again expelled into the aorta, and by it distributed all over the rest of the body, and thence is returned again to the right ventricle by the cava, which completes the circulation.

This circulation becomes actually visible, with the assistance of a microscope, especially in fish, frogs, &c. wherein the inoculation, or union of the extremities of the arteries with those of the veins, together with the globules of the blood flowing from the one into the other, may be plainly seen.

The auricles of the heart being large hollow muscles, furnished with a double series of strong fibres, proceeding with a contrary direction to the opposite tendons, the one adhering to the right ventricle, the other to the sinus venosus; as also with innumerable

veins

veins and arteries; by the contractile force of these auricles, the blood will be vigorously expressed and driven into the right ventricle, which, upon this contraction, is rendered flaccid, empty, and disposed to admit it.

Now, if the right ventricle, thus full of blood, by the contraction of its fibres, press the blood towards the aperture again, the venous blood at the same time pouring in; will drive it back again into the cavity, and mix it more intimately, till, rising up against the parietes, it raise the valvulæ tricuspidæ, which are so connected to the fleshy columns extended on the opposite side, as that, when laid quite down, they cannot close the parietes of the right ventricle; these it thrusts towards the right auricle, till being there joined, they stop the passage very closely, and prevent any return.

By the same means, the same blood rises into the three semilunar valves, placed in the extremity of the other mouth, and lying open to the pulmonary artery; these it shuts close against the sides of the artery, and leaves a passage into the artery alone: the blood carried by this artery into the lungs, and distributed by its branches through the whole substance thereof, is first admitted into the extremities of the pulmonary vein, called *arteria venosa*; whence passing into four large vessels, which unite together, it is brought to the left sinus venosus, or trunk of the pulmonary vein, by the force of whose musculous structure it is driven into the left ventricle, which, on this occasion, is relaxed, and by that means prepared to receive it.

Hence, as before, it is driven into the left ventricle, which is relaxed by the same means; and by the valvulæ mitrales opening, admit it into the left ventricle, and hinder its flux into the pulmonary vein: from hence it is forced into the aorta, at whose orifice there are three semilunar valves, which also prevent a reflux, by closing the same.

The motion of the blood in living animals is attended with the following phenomena: 1. Both the venous sinuses are filled, and grow turgid at the same time. 2. Both auricles grow flaccid at the same time, and both are filled at the same time with blood, impelled by the contractile force of its correspondent musculous venous sinus. 3. Each ventricle contracts and empties itself of blood at the same time; and the two great arteries are filled and dilated at the same time. 4. As soon as the blood, by this contraction, is expelled, both ventricles being empty, the heart grows larger and broader. 5. Upon which the musculous fibres of both venous sinuses contract, and express the blood contained in them into the ventricle of the heart. 6. In the mean time the venous sinuses are again filled as before, and the auricles, &c. return into their former habitude. 7. This alteration continues till the animal begins to languish under the approach of death, at which time the auricles and venous sinuses make several palpitations, for one contraction of the ventricle.

In a fœtus, the apparatus for the circulation of the blood is somewhat different from that in adults. The septum, which separates the two auricles of the heart, is pierced through with an aperture, called the for-

men ovale, and the trunk of the pulmonary artery, a little after it has left the heart, sends out a tube into the descending aorta, called the communicating canal. The fœtus being born, the foramen ovale closes by degrees, and the canal of communication dries up, and becomes a simple ligament.

As to the velocity of the circulating blood, and the time wherein the circulation is completed, several computations have been made. By Dr Keil's account, the blood is driven out of the heart into the aorta with a velocity which would carry it twenty-five feet in a minute: but this velocity is continually abated in the progress of the blood, in the numerous sections or branches of the arteries, so that before it arrive at the extremities of the body, its motion is greatly diminished. The space of time wherein the whole mass of blood ordinarily circulates, is variously determined. Some state it thus: Supposing the heart to make two thousand pulses in an hour, and that at every pulse there is expelled an ounce of blood; as the whole mass of blood is not ordinarily computed to exceed twenty-four pounds, it must be circulated seven or eight times over in the space of an hour.

The circulation of the blood was first discovered in England, in the year 1728, by Dr Harvey.

*CIRCULATION of the sap of vegetables.* See Vol. I. p. 45.

*CIRCULATION*, in chemistry, is an operation whereby the same vapour, raised by fire, falls back, to be returned and distilled several times.

*CIRCULATION of money.* See COMMERCE, and MONEY.

*CIRCULUS*, in chemistry, an iron instrument in form of a ring, which being heated red hot, and applied to the necks of retorts and other glass vessels, till they grow hot, a few drops of cold water thrown upon them, or a cold blast, will make the necks fly regularly and evenly off.

Another method of doing this, is to tie a thread, first dipt in oil of turpentine, round the place where you would have it break; and then setting fire to the thread, and afterwards sprinkling the place with cold water, the glass will crack exactly where the thread was tied.

*CIRCUMAJENTES MUSCULI*, or *OBLIQUI MUSCULI*, in anatomy. See Vol. I. p. 290.

*CIRCUMAMBIENT*, an appellation given to a thing that surrounds another on all sides; chiefly used in speaking of the air.

*CIRCUMCISION*, the act of cutting off the prepuce; a ceremony in the Jewish and Mahometan religions, wherein they cut off the foreskin of their males, who are to profess the one or the other law.

Among the Jews, the time for performing this rite was the eighth day, that is, six full days after the child was born: the law of Moses ordained nothing with respect to the person by whom, the instrument with which, or the manner how, the ceremony was to be performed; the instrument was generally a knife of stone. The child is usually circumcised at home, where the father, or godfather, holds him in his arms, while the operator

takes hold of the prepuce with one hand, and with the other cuts it off; a third person holds a porringer, with sand in it, to catch the blood; then the operator applies his mouth to the part, and having sucked the blood, spits it into a bowl of wine, and throws a styp-tic powder upon the wound. This ceremony was usually accompanied with great rejoicings and feasting, and it was at this time that the child was named in presence of the company. The Jews invented several superstitious customs at this ceremony, such as placing three stools, one for the circumcisor, the second for the person who holds the child, and the third for Elijah, who, they say, assists invisibly at the ceremony, &c.

The Jews distinguished their profelytes into two sorts, according as they became circumcised, or not: those who submitted to this rite were looked upon as children of Abraham, and obliged to keep the laws of Moses; the uncircumcised were only bound to observe the precepts of Noah, and were called *noachidæ*.

This ceremony, however, was not confined to the Jews: Herodotus and Philo Judæus observe, that it obtained also among the Egyptians and Ethiopians. Herodotus says, that the custom was very ancient among each people, so that there was no determining which of them borrowed it from the other. The same historian relates, that the inhabitants of Colchis also used circumcision; whence he concludes, that they were originally Egyptians.

The Turks never circumcise till the seventh or eighth year, as having no notion of its being necessary to salvation. The Persians circumcise their boys at thirteen, and their girls from nine to fifteen. Those of Madagascar cut the flesh at three several times; and the most zealous of the relations present, catches hold of the preputium, and swallows it.

Circumcision is practised on women by cutting off the foreskin of the clitoris, which bears a near resemblance and analogy to the preputium of the male penis. We are told that the Egyptian captive women were circumcised; and also the subjects of Prester John.

**CIRCUMCISION** is also the name of a feast, celebrated on the first of January, in commemoration of the circumcision of our Saviour.

**CIRCUMDUCTION**, in Scots law. When parties in a suit are allowed a proof of addigamus after the time limited by the judge for taking that proof is elapsed, either party may apply for circumduction of the time of proving: the effect of which is, that no proof can afterwards be brought, and the course must be determined as it stood when circumduction was obtained. See **SCOTS LAW**, title *Pobation*.

**CIRCUMFERENCE**, in a general sense, denotes the line or lines bounding a plane figure. However, it is generally used in a more limited sense, for the curve line which bounds a circle, and otherwise called a periphery; the boundary of a right-lined figure being expressed by the term perimeter.

**CIRCUMFERENTOR**, an instrument used by surveyors, for taking angles. See **PRACTICAL GEOMETRY**.

**CIRCUMFLEX**, in grammar, one of the accents. See **ACCENT**.

**CIRCUMGYRATION**, denotes the whirling motion of any body round a center: such is that of the planets round the sun.

**CIRCUMLOCUTION**, a paraphractical method of expressing one's thoughts, or saying that in many words which might have been said in few.

**CIRCUMPOLAR stars**, an appellation given to those stars which by reason of their vicinity to the pole move round it without setting.

**CIRCUMSCRIBED**, in geometry, is said of a figure which is drawn round another figure, so that all its sides or planes touch the inscribed figure.

**CIRCUMSCRIPTION**, in natural philosophy, the termination, bounds, or limits of any natural body.

**CIRCUMSTANCE**, a particularity which, though not essential to any action, yet doth some way effect it.

**CIRCUMSTANTIBUS**, in law, a term used for supplying and making up the number of jurors (in case any impelled appear not, or appearing are challenged by any party) by adding to them so many of the persons present as will make up the number, in case they are properly qualified.

**CIRCUMVALLATION**, or *line of* **CIRCUMVALLATION**, in the art of war, is a trench bordered with a parapet, thrown up quite round the besieger's camp, by way of security against any army that may attempt to relieve the place, as well as to prevent desertion.

**CIRCUMVOLUTION**, in architecture, denotes the torus of the spiral line of the ionic volute.

**CIRCUS**, in antiquity, a great building of a round or oval figure, erected by the ancients, to exhibit shews to the people.

The Roman circus was a large oblong edifice, arched at one end, encompassed with porticoes, and furnished with two rows of seats, placed ascending over each other. In the middle was a kind of foot-bank, or eminence, with obelisks, statues, and posts at each end. This served them for the courses of their bigæ and quadrigæ.

Those that have measured the circus say, that it was 2187 feet long, and 960 broad; so that it was the greatest building in Rome: some say it would contain 150,000 people, others 260,000, or 300,000.

**CIRCUS**, in zoology, See **FALCO**.

**CIRENCESTER**, a borough-town of Gloucestershire, situated on the river Churn, fifteen miles south east of Gloucester: W. long. 2°, north lat. 51° 42'. It sends two members to parliament.

**CIRLUS**, in ornithology. See **EMBERIZA**.

**CIRRI**, among botanists, fine strings or thread like filaments, by which some plants fasten themselves to walls, trees, &c. such are those of ivy.

**CIRRI**, in ichthyology, certain oblong and soft appendages, not unlike little worms, hanging from the under jaws or mouths of some fishes: these cirri, commonly translated *beards*, afford marks to distinguish the different species of the fishes on which they are found.

**CIRSIUM**, in botany. See **SERRATULA**.

**CIRSOCELE**,

**CIRSOCELE**, a species of hernia. See **MEDICINE** and **SURGERY**.

**CISALPINE**, any thing on this side the Alps. Thus the Romans divided Gaul into cisalpine and transalpine.

**CISLEU**, in Hebrew chronology, the ninth month of their ecclesiastical, and the third of the civil year, answering nearly to our November.

**CISMAR**, a town of lower Saxony, in Germany, at a little distance from the Baltic sea.

**CISSAMPELOS**, in botany, a genus of the diœcia monadelphia class. The calix of the male has four leaves; the corolla is wanting; the nectarium is rotated; and the stamina are four connected together. The calix of the female consists of one ligulated roundish leaf; it has no corolla; the styli are three; and the fruit is a berry containing one seed. There are three species, all natives of America.

**CISSOID**, in geometry, a curve of the second order, first invented by Diocles, whence it is called the cissoïd of Diocles. See **FLUXIONS**.

**CISSUS**, in botany, a genus of the tetrandria monogynia class. The berry contains but one seed, and is surrounded by the corolla and calix, which are both divided into four segments. The species are five, all natives of the Indies.

**CISTERCIANS**, in church history, a religious order founded in the eleventh century by St Robert, a benedictine. They became so powerful, that they governed almost all Europe, both in spirituals and temporals. Cardinal de Vitri describing their observances, says, they neither wore skins nor shirts; nor ever eat flesh, except in sickness; and abstained from fish, eggs, milk, and cheese: they lay upon straw-beds, in their tunics and cowls: they rose at midnight to prayers: they spent the day in labour, reading and prayer: and in all their exercises observed a continual silence. The habit of the Cistercian monks is a white robe, in the nature of a cassock, with a black scapulary and hood, and is girt with a wooden girdle. The nuns wear a white tunic, and a black scapulary and girdle.

**CISTERN**, denotes a subterraneous reservoir of rain-water; or a vessel serving as a receptacle for rain or other water, for the necessary uses of a family.

There are likewise lead-cisterns, jar-cisterns, &c. See **PLUMBERY** and **JAR**.

Authors mention a cistern of Constantinople, the vaults of which are supported by two rows of pillars, 212 in each row, each pillar being two feet in diameter. They are planted circularly, and in radii tending to that of the center.

**CISTUS**, in botany, a genus of the polyandria monogynia class. The corolla consists of five petals, and the calix of five leaves, two of them being less than the other two. The species are 37, and only five of them natives of Britain, viz. the guttulus, or annual cistus; the helianthemum, or dwarf cistus, or sun-flower; the surreianus, or narrow-leaved cistus; the polii-folius, or mountain dwarf cistus; and the hirsutus, or hoary dwarf cistus.

**CITADEL**, a place fortified with four, five, or six ba-

stions, built on a convenient ground near a city, that it may command it in case of a rebellion.

**CITATION**, in ecclesiastical courts, is the same with summons in civil courts. See **SUMMONS**.

**CITATION** is also a quotation of some law, authority, or passage of a book.

**CITHARA**, in antiquity, a musical instrument, the precise structure of which is not known; some think it resembled the Greek delta  $\Delta$ ; and others, the shape of a half moon. At first it had only three strings, but the number was at different times increased to eight, to nine, and lastly to twenty-four. It was used in entertainments and private houses, and played upon with a plectrum or quill, like the lyre.

**CITHAREXYLON**, in botany, a genus of the didynamia angiospermia class. The calix is bell-shaped, and has five teeth; the corolla is tunnel shaped; and the berry contains two seeds. There are two species, both natives of America.

**CITHARISTA**, or **CITHAROEDUS**, one who played on the cithara.

**CITILLE**, in zoology, the trivial name of a species of mus. See **MUS**.

**CITIZEN**, a native or inhabitant of a city, vested with the freedom and liberties of it.

A citizen of Rome was distinguished from a stranger, because he belonged to no certain commonwealth subject to the Romans. A citizen is either by birth or election; and sons may derive the right from their fathers. To make a good Roman citizen, it was necessary to be an inhabitant of Rome, to be enrolled in one of the tribes, and to be capable of dignities. Those to whom were granted the rights and privileges of Roman citizens, were only honorary citizens. It was not lawful to scourge a citizen of Rome.

**CITRINELLA**, in ornithology. See **EMBERIZA**.

**CITRINUS**, in natural history, a kind of sprig crystal, of a fine yellow colour, which being set in rings is often mistaken for a topaz.

**CITRON-TREE**, in botany. See **CITRUS**.

**CITRULLUS**, in botany. See **CUCURBITA**.

**CITRUS**, in botany, a genus of the polyadelphia icosaandria class. The calix is divided into five segments; the petals are five, and oblong; and the fruit is a berry, consisting of nine cells. The species are three, viz. the medica, or lemon-tree, a native of Asia; the aurantium, or orange-tree, a native of the Indies; and the trifoliata, a native of Japan.

**CITTADELLA**, the capital of the island of Minorca, about twenty-three miles west of Port-mahon: E. long.  $3^{\circ} 30'$ , N. lat.  $40^{\circ}$ .

**CITTADELLAPIEVE**, a town of Italy, in the territories of the pope, near the lake of Perugia.

**CIVENCHEU**, a city of China, the second metropolis of the province of Fokien, in  $25^{\circ}$  N. lat. and  $2^{\circ}$  east of Peking.

**CIVES**, the English name of a species of onion, growing in tufts, and seldom exceeding six inches in height: they never produce any bulbs, and are much used in sallads in spring.

**CIVET**, a soft unctuous matter produced in the manner of

of

- of musk, in bags growing from the lower part of the belly of a civet-cat. See **CASTOR**.
- CIVET-CAT**, the English name of the animal which produces the civet. See **CASTOR**.
- CIVIC CROWN**, was a crown given by the ancient Romans to any soldier who had saved the life of a citizen in any engagement.
- CIVIDAD de las Palmas**, the capital of all the Canary islands, situated in the island of Canary.
- CIVIDAD-REAL**, a city of Spain, in the province of New Castile: it is the capital of La Mancha, situated on the river Guadiana, sixty miles south of Toledo: W. long.  $4^{\circ} 20'$ , N. lat.  $39^{\circ}$ .
- CIVIL**, in a general sense, something that regards the policy, public good, or peace of the citizens, or subjects of the state; in which sense we say, civil government, civil law, civil right, civil war, &c.
- CIVIL**, in a legal sense, is also applied to the ordinary procedure in an action, relating to some pecuniary matter or interest, in which sense it is opposed to criminal.
- CIVIL DEATH**, any thing that cuts off a man from civil society, as a condemnation to the galleys, perpetual banishment, condemnation to death, outlawry, and excommunication.
- CIVIL LAW**, is properly the peculiar law of each state, country, or city: but what we usually mean by the civil law, is a body of laws compiled out of the best Roman and Grecian laws, compiled from the laws of nature and nations, and, for the most part, received and observed throughout all the Roman dominions for above 1200 years. See **LAW**.
- CIVIL WAR**, a war between people of the same state, or the citizens of the same city.
- CIVIL YEAR** is the legal year, or annual account of time, which every government appoints to be used within its own dominions, and is so called in contradistinction to the natural year, which is measured exactly by the revolution of the heavenly bodies.
- CIVILIAN**, in general, denotes something belonging to the civil law; but more especially the doctors and professors thereof are called civilians.
- CIVITA-CASTELLANA**, a city of Italy, in St Peter's patrimony, situated near the river Tiber, twenty-five miles north of Rome: E. long.  $13^{\circ}$ , N. lat.  $42^{\circ} 15'$ .
- CIVITA VECCHIA**, a port-town and fortrefs of Italy, in St Peter's patrimony, situated on a bay of the Mediterranean, thirty miles north-west of Rome: E. long.  $12^{\circ} 30'$ , N. lat.  $42^{\circ}$ .
- It is the station of the galleys belonging to the pope, who has lately declared it a free port.
- LACK**, among country-men. To lack wool, is to cut off the sheep's mark, which makes the weight less, and yields less custom to the king.
- LACKMANNAN**, the capital of Clackmannanshire, in Scotland, situated on the northern shore of the Forth, about twenty five miles north-west of Edinburgh: W. long.  $3^{\circ} 40'$ , N. lat.  $56^{\circ} 15'$ .
- The county of Clackmannan is joined with that of Kinross, which each in their turn chuse a member to represent them in parliament.
- CLAGENFURT**, or **CLAGENFORT**, the capital of Carinthia, in the circle of Austria in Germany, 120 miles south-west of Vienna: E. long.  $14^{\circ}$ , N. lat.  $47^{\circ}$ .
- CLAIM**, in law, a challenge of interest in any thing that is in possession of another.
- CLAKIS**, in ornithology, a synonyme of the *anas bernicla*. See **ANAS**.
- CLAMP in a ship**, denotes a piece of timber applied to a mast or yard, to prevent the wood from bursting; and also a thick plank lying fore and aft under the beams of the first orlop, or second deck, and is the same that the rising timbers are to the deck.
- CLAMP** is likewise the term for a pile of unburnt bricks built up for burning. These clamps are built much after the same manner as arches are built in kilns, viz. with a vacuity betwixt each brick's breadth for the fire to ascend by; but with this difference, that instead of arching, they truss over, or over-span; that is, the end of one brick is laid about half way over the end of another, and so till both sides meet within half a brick's length, and then a binding brick at the top finishes the arch.
- CLAMP-NAILS**, such nails as are used to fasten on clamps in the building or repairing of ships.
- CLAMPING**, in joinery, is the sitting a piece of board with the grain, to another piece of board cross the grain. Thus the ends of tables are commonly clamped, to prevent their warping.
- CLANDESTINA**, in botany. See **LATHRÆA**.
- CLANDESTINE**, any thing done without the knowledge of the parties concerned, or without the proper solemnities. Thus a marriage is said to be clandestine, when performed without the publication of bans, the consent of parents, &c.
- CLANGULA**, in ornithology. See **ANAS**.
- CLAP**, in medicine, the first stage of the venereal disease, more usually called a gonorrhœa. See **MEDICINE**.
- CLARAMONT-POWDER**, a kind of earth, called *Terra de Baira*. from the place where it is found: it is famous at Venice, for its efficacy in stopping hæmorrhages of all kinds, and in curing malignant fevers.
- Precept of CLARE CONSTAT*, in Scots law, the warrant of a superior for entering and infesting the heir of his former vassal, without the interposition of an inquest. See **SCOTS LAW**, title, *Succession in heritable Rights*.
- CLARE**, a market-town of Suffolk, thirteen miles south of Bury: E. long.  $35'$ , N. lat.  $52^{\circ} 15'$ . It gives the title of earl to the duke of Newcastle.
- CLARE** is also the capital of a county of the same name in the province of Connaught, in Ireland, situated about seventeen miles north-west of Limerick: W. long.  $9^{\circ}$ , N. lat.  $52^{\circ} 40'$ .
- CLARENCEUX**, the second king at arms, so called from the duke of Clarence, to whom he first belonged; for Lionel third son to Edward III. having by his wife

wife the honour of Clare, in the county of Thomond, was afterwards declared duke of Clarence; which dukedom afterwards escheating to Edward IV. he made this earl a king at arms. His office is to marshal and dispose of the funerals of all the lower nobility, as baronets, knights, esquires, on the south side of the Trent; whence he is sometimes called Surroy, or South-roy, in contradistinction to Norroy.

**CLARENDON.** The constitutions of Clarendon, are certain ecclesiastical laws drawn up at Clarendon, near Salisbury. They were sixteen in number, all tending to restrain the power of the clergy, and readily assented to by all the bishops and barons, the archbishop Becket excepted, who opposed them at first, but was afterwards prevailed upon to sign them. The pope Alexander III. declared against and annulled most of them.

**CLARENZA,** the capital of a duchy of the same name in the Morea: it is a sea-port town, situated on the Mediterranean, twenty-six miles south of Petras: E. long.  $21^{\circ} 40'$ , N. lat.  $37^{\circ} 40'$ .

**CLARET,** a name given by the French to such of their red wines as are not of a deep or high colour. See **WINE**.

**CLARICHORD,** or **MANICHORD,** a musical instrument in form of a spinnet.

It has forty-nine or fifty stops, and seventy strings, which bear on five bridges, the first whereof is the highest, the rest diminishing in proportion. Some of the strings are in unison, their number being greater than that of the stops. There are several little mortises for passing the jacks, armed with brass hooks, which stop and raise the chords instead of the feather used in virginals and spinnets: but what distinguishes it most is, that the chords are covered with pieces of cloth, which render the sound sweeter, and deaden it so, that it cannot be heard at any considerable distance: whence it comes to be particularly in use among the nuns, who learn to play, and are unwilling to disturb the silence of the dormitory.

**CLARIFICATION,** in chemistry, the act of clearing and fining any fluid from all heterogeneous matter or feculencies. See **CHEMISTRY**.

**CLARION,** a kind of trumpet, whose tube is narrower, and its tone acuter and shriller than that of the common trumpet. It is said that the clarion, now used among the Moors and Portuguese, who borrowed it from the Moors, served anciently for a treble to several trumpets, which sounded tenor and bass.

**CLARION,** in heraldry, a bearing as represented in Plate LXV. fig. 5. he bears ruby, three clarions topaz, being the arms of the earl of Bath, by the name of Granville: Guillim is of opinion, that these three clarions are a kind of old-fashioned trumpets; but others say, that they rather resemble the rudder of a ship; others, a rest for a lance.

**CLARO-OBSCURO,** or **CLAIR OBSCURE,** in painting, the art of distributing to advantage the lights and shadows of a piece, both with regard to the easing of the eye, and the effect of the whole piece.

**CLARO-OBSCURO,** or **CHIARO-SCURO,** is also used to

signify a design consisting only of two colours, most usually black and white, but sometimes black and yellow; or it is a design washed only with one colour, the shadows being of a dusky brown colour, and the lights heightened up with white.

The word is also applied to two prints of two colours, taken off at twice, whereof there are volumes in the cabinets of the curious in prints.

**CLARY,** in botany. See **SALVIA**.

**CLARY-WATER,** a spirit drawn from an infusion of the herb clary in spirit of wine, being a very pleasant and excellent cordial.

**CLASMIUM,** in natural history, constitutes a distinct genus of gypsums by itself, being more soft, dull, and opaque, than other kinds: it neither gives fire with steel, nor ferments with aqua fortis; but calcines readily in the fire, and affords a very valuable plaster.

**CLASS,** an appellation given to the most general subdivisions of any thing: thus, animal is subdivided into the classes quadrupeds, birds, fishes, &c. which are again subdivided into serieses or orders; and these last into genera. See **NATURAL HISTORY**, and **BOTANY**.

**CLASS** is also used in schools, in a synonymous sense with form, for a number of boys all learning the same thing.

**CLASSIC,** or **CLASSICAL,** an epithet chiefly applied to authors read in the classes at schools.

This term seems to owe its origin to Tullius Servius, who, in order to make an estimate of every person's estate, divided the Roman people into six bands, which he called classes. The estate of the first class was not to be under 200 l. and these by way of eminence were called *classici*, classics: hence authors of the first rank came to be called classics, all the rest being said to be *infra classim*: thus Aristotle is a classic author in philosophy; Aquinas, in school-divinity, &c.

**CLATHRUS,** in botany, a genus of the cryptogamia fungi class. This fungus is roundish, and full of cancelli. The species are four, none of them natives of Britain.

**CLATTE,** in heraldry, an appellation given to irregular lines, not reducible to those commonly used. See **LINE**.

**CLAVARIA,** in botany, a genus of the cryptogamia fungi class. It is smooth and oblong. The species are eight, seven of which are natives of Britain, *viz.* the *pillularis*, or simple clavaria; the *ophioglossoides*, or black clavaria; the *digitata*, or fingered clavaria; the *hypoxylon*, or flat clavaria; the *coralloides*, or yellow clavaria; the *fastigiata*, or sinking clavaria; and the *muscoides*, or pointed clavaria.

**CLAVES INSULÆ,** a term used in the isle of Man; where all weighty and ambiguous causes are referred to a jury of twelve, who are called *claves insule*, the keys of the island.

**CLAVICLES,** in anatomy. See Vol. I. p. 175.

**CLAVIS** properly signifies a key, and is sometimes used in English to denote an explanation of some obscure passages in any book or writing.

**CLAUSE**, in grammar, denotes a member of a period, or sentence.

**CLAUSE** signifies also an article, or particular stipulation in a contract, a charge or condition in a testament, &c.

**CLAUSENBURG**, a large city of Transilvania, situated on the river Samos, about fifty-five miles north-west of Hermanstadt: E. long.  $20^{\circ} 50'$ , N. lat.  $47^{\circ} 10'$ .

**CLAVUS**, in antiquity, an ornament upon the robes of the Roman senators and knights, which was more or less broad, according to the dignity of the person: hence the distinction of *tunica angust-clavia* and *lati-clavia*.

**CLAVUS**, in medicine and surgery, is used in several significations: 1. *Clavus hystericus*, is a shooting pain in the head, between the pericranium and cranium, which affects such as have the green-sickness. 2. *Clavus oculorum*, according to Celsus, is a callous tubercle on the white of the eye, taking its denomination from its figure. 3. *Clavus* imports indurated tubercles of the uterus. 4. *Clavus* imports a chirurgical instrument of gold, mentioned by Amatus Lusitanus, designed to be introduced into an exulcerated palate, for the better articulation of the voice. 5. *Clavus* is a callus or corn on the foot.

**CLAW**, among zoologists, denotes the sharp-pointed nails with which the feet of certain quadrupeds and birds are furnished.

*Crab's CLAWS*, in pharmacy, See **CRAB'S CLAWS**.

**CLAY**, in natural history, a genus of earths, the characters of which are these: they are firmly coherent, weighty, and compact; stiff, viscid, and ductile to a great degree, while moist; smooth to the touch, not easily breaking between the fingers, nor readily diffusible in water, and when mixed not readily subliming from it.

**CLAYTONIA**, in botany, a genus of the pentandria monogynia class. The calix consists of two valves; the corolla has five petals; the stigma is trifid; and the capsule has three valves, and contains three seeds. The species are two, none of them natives of Britain.

*Cape CLEAR*, a promontory in a little island on the south-west coast of Ireland.

**CLEAVERS**, in botany. See **GALLIUM**.

**CLEBURY**, a market-town of Shropshire, about 25 miles south-east of Shrewsbury: W. long.  $2^{\circ} 30'$ , and N. lat.  $52^{\circ} 27'$ .

**CLECHE**, in heraldry, a kind of cross, charged with another cross of the same figure, but of the colour of the field. See Plate LXV. fig. 6.

**CLEDGE**, among miners, denotes the upper stratum of fuller's earth.

**CLEF**, or **CLIFF**, in music, a mark set at the beginning of the lines of a song, which shews the tone or key in which the piece is to begin; or it is a letter marked on any line, which explains the rest.

**CLEIDOMASTOIDEUS**, in anatomy. See Vol. I. p. 215.

**CLEMA**, in antiquity, a twig of the vine, which served as the badge of a centurion's office.

**CLEMATIS**, in botany, a genus of the polyandria pu-

lygynia class. It has no calix; the petals are four; and the seeds are caudated. There are twelve species, none of them natives of Britain.

**CLEOME**, in botany, a genus of plants belonging to the tetradynamia siliquosa class. It has three nectariferous glands, one at each sinus of the calix, excepting the lowest; the siliqua or pod has two valves and one cell. There are fifteen species, none of them natives of Britain.

**CLEPSYDRA**, a water-clock, or instrument to measure time by the fall of a certain quantity of water.

**CLERGY**, a general name given to the body of ecclesiastics of the Christian church, in contradistinction to the laity.

The distinction of Christians into clergy and laity, was derived from the Jewish church, and adopted into the Christian by the apostles themselves: whenever any number of converts were made, as soon as they were capable of being formed into a congregation or church, a bishop or presbyter, with a deacon, were ordained to minister to them. Of the bishops, priests, and deacons, the clergy originally consisted; but in the third century, many inferior orders were appointed, as subservient to the office of deacon, such as subdeacons, acolythists, readers, &c.

*Benefit of CLERGY*, is an ancient privilege, whereby one in orders claimed to be delivered to his ordinary, to purge himself of felony: this purgation was to be by his own oath, affirming his innocence, and the oath of twelve compurgators, as to their belief of it, before a jury of twelve clerks: if the clerk failed in his purgation, he was deprived of his character, whereby he became a mere layman; or he was to be kept in prison till a pardon was obtained: but if he purged himself, he was set at liberty.

**CLERK**, a word originally used to denote a learned man, or man of letters; whence the term became appropriated to church-men, who were from thence called clerks, or clergymen; the nobility and gentry being usually bred up to the exercise of arms, and none left but the ecclesiastics to cultivate the sciences.

**CLERK** is also applied to such as by their course of life, exercise their pens in any court or office, of which there are various kinds: thus,

**CLERK of the bills**, an officer in the court of king's bench, whose business it is to file all bail-pieces taken in that court, where he always attends.

**CLERK of the check**, an officer belonging to the king's court, so called, because he has the check and controulment of the yeomen that belong to the king, queen, or prince. He likewise, by himself or deputy, sets the watch in the court. There is also an officer in the navy of the same name, belonging to the king's yards.

**CLERK of the crown**, an officer, in the king's bench, who frames, reads, and records all indictments against offenders, there arraigned or indicted of any public crime. He is likewise termed clerk of the crown-office, in which capacity he exhibits informations by order of the court, for divers offences.

**CLERK**



- CLERK of the crown**, in chancery, an officer whose business it is constantly to attend the lord-chancellor, in person or by deputy, to write and prepare for the great seal special matters of state by commission, both ordinary and extraordinary, *viz.* commissions of lieutenancy, of justices of assize, oyer and terminer, goal-delivery, and of the peace; all general pardons, granted either at the king's coronation, or in parliament: the writs of parliament, with the names of the knights, citizens, and burghesses, are also returned into his office. He also makes out special pardons, and writs of execution on bonds of statute-staple forfeited.
- CLERK of the deliveries**, an officer of the tower, whose function is to take indentures for all stores and ammunition issued from thence.
- CLERK of the errors**, in the court of common pleas, an officer who transcribes and certifies into the king's bench, the tenor of the record of the action on which the writ of error, made out by the curfitor, is brought there to be determined. In the king's bench, the clerk of the errors transcribes and certifies the records of causes, by bill, in that court, into the exchequer. And the business of the clerk of the errors in the exchequer, is to transcribe the records certified thither out of the king's bench, and to prepare them for judgment in the exchequer-chamber.
- CLERK of the essoins**, in the court of common pleas, keeps the essoin-roll, or enters essoins: he also provides parchment, cuts it into rolls, marks the number on them, delivers out all the rolls to every officer, and receives them again when written. See **ESSOIN**.
- CLERK of the estreats**, an officer in the exchequer, who every term receives the estreats out of the lord-treasurer's remembrancer's office, and writes them out, to be levied for the crown.
- CLERK of the green-cloth**. See **GREEN-CLOTH**.
- CLERK of the hamper, or hanaper**, an officer in chancery, whose business is to receive all money due to the king for the seals of charters, letters patent, commissions, and writs; also the fees due to the officers for enrolling and examining them.
- CLERK-comptroller of the king's household**, an officer of the king's court, authorised to allow or disallow the charges of pursuivants, messengers of the green cloth, &c. to inspect and controul all defects of any of the inferior officers; and to sit in the counting-house with the lord-steward and other officers of the household, for regulating such matters.
- CLERK of the king's silver**, an officer of the common pleas, to whom every fine is brought, after it has passed the office of the custos brevium; and who enters the effect of writs of covenant, into a book kept for that purpose, according to which all the fines of that term are recorded in the rolls of the court.
- CLERK of the market**, an officer of the king's house, to whom is given the charge of the king's measures and weights, the standards of those that ought to be used all over England.
- CLERK of the nichils, or nihils**, an officer of the exchequer, who makes a roll of all such sums as are nichilled by the sheriffs upon their estreats of green wax, and delivers them in to the remembrancer of the treasury, to have execution done upon them for the king. See **NIHIL**.
- CLERK of the outlawries**, an officer of the common pleas, and deputy to the attorney-general, for making out all writs of *capias utlagatum*, after outlawry, to which there must be the king's attorney's name.
- CLERK of the paper-office**, an officer belonging to the king's bench, whose business is to make up the paper-books of special pleadings in that court.
- CLERK of the peace**, an officer belonging to the sessions of the peace, whose business is to read indictments, enrol the proceedings, and draw the process: he likewise certifies into the king's bench, transcripts of indictments, outlawries, attainders and convictions had before the justices of peace, within the time limited by statute, under a certain penalty. This office is in the gift of the *custos rotulorum*, and may be executed by deputy.
- CLERK of the pells**, an officer that belongs to the exchequer, whose business is to enter every teller's bill into a parchment roll called *pellis receptorum*, and to make another roll of payments called *pellis exituum*.
- CLERK of the petty bag**, an officer of the court of chancery, whereof there are three, the master of the rolls being the chief: their business is to record the return of all inquisitions out of every shire, to make out patents of customers, gaugers, comptrollers, &c. liberates upon extents of statutes-staple, *conge d'aires* for bishops, summons of the nobility, clergy, and burghesses to parliament, and commissions directed to knights and others, of every shire, for assessing subsidies and taxes.
- CLERK of the pipe**, an officer of the exchequer, who having the accounts of all debts due to the king delivered out of the remembrancer's office, charges them in a great roll folded up like a pipe. He writes out warrants to sheriffs, to levy the said debts on the goods and chattels of the debtors: and if they have no good, then he draws them down, to the treasurer's remembrancer, to write estreats against their lands.
- CLERK of the pleas**, an officer of the exchequer, in whose office all the officers of the court, having special privilege, ought to sue, or be sued, in any action. In this office also actions at law may be prosecuted by other persons, but the plaintiff ought to be tenant or debtor to the king, or some way accountable to him. The under clerks are attorneys in all suits.
- CLERKS of the privy-seal**, four officers that attend the lord privy-seal, for writing and making out all things that are sent by warrant from the signet to the privy-seal, and to be passed the great-seal; and likewise to make out privy-seals, upon special occasions of his majesty's affairs, as for loan of money, or the like.
- CLERK of the rolls**, an officer of the chancery, whose business is to make searches after, and copies of deeds, officers, &c.
- CLERK of the signet**, an officer continually attending upon his majesty's principal secretary, who has the custody of the privy-signet, as well for sealing the king's

king's private letters, as those grants which pass the king's hand by bill signed. There are four of these officers, who have their diet at the secretary's table.

**CLERK, or WRITER,** *to the signet*, in Scots law. See **SCOTS LAW**, title 3.

**Six CLERKS**, officers in chancery, next in degree below the twelve masters, whose business is to enrol commissions, pardons, patents, warrants, &c. which pass the great seal: they were anciently clerici, and forfeited their places if they married. These are also attorneys for parties in suits depending in the court of chancery.

**CLERK of the treasury**, an officer belonging to the court of common pleas, who has the charge of keeping the records of the court, makes out all records of *nisi prius*, and likewise all exemplifications of records being in the treasury. He has the fees due for all searches; and has under him an under-keeper, who always keeps one key of the treasury door.

**CLERK of the warrants**, an officer of the common pleas, whose business is to enter all warrants of attorney for plaintiffs and defendants in suit; and to enroll deeds of bargain and sale, that are acknowledged in court, or before a judge. His office is likewise to estreat into the exchequer all issues, fines, estreats, and amercements, which grow due to the crown in that court.

**CLERMONT**, a city and bishop's see of France, in the territory of Auvergne, and province of Lyonois, about seventy-five miles west of Lyons: E. long. 3° 20' and N. lat. 45° 42'.

**CLERODENDRUM**, in botany, a genus of the *dynamia-angiospernia* class. The calix is bell shaped, and divided into five segments; the tube of the corolla is filiform; the limbus is divided into five equal parts; the stamina are very long; and the berry contains but one seed. The species are two, both natives of the Indies.

**CLEROMANCY**, a sort of divination performed by throwing lots, which were generally black and white beans, little clods of earth, or pebbles; also dice, or such like things, distinguished by certain characters. They cast the lots into a vessel, and having made supplication to the gods to direct them, drew them out, and, according to the characters, conjectured what should happen to them.

**CLETHRA**, in botany, a genus of the *decandria monogynia* class. The calix is divided into five segments; the petals are five; the stigma is trifid; and the capsule has three cells and three valves. There is but one species, *viz.* the *alnifolia*, a native of Carolina.

**CLEVES, or CLUF**, the capital of the dutchy of Cleve, in the circle of Westphalia, in Germany, situated near the western shore of the river Rhine: E. long. 5° 36', and N. lat. 51° 40'. It is subject to the king of Prussia.

**CLEVELAND**, a district in the north-riding of York shire, from which the noble family of Fitzroy takes the title of duke.

**CLIFNT**, among the Romans, a citizen who put himself under the protection of some great man, who, in respect of that relation, was called patron.

This patron assisted his client with his protection, interest, and goods; and the client gave his vote for his patron, when he sought any office for himself or his friends. Clients owed respect to their patrons, as these owed them their protection.

The right of patronage was appointed by Romulus, to unite the rich and poor together in such a manner, as that one might live without contempt, and the other without envy; but the condition of a client, in course of time, became little else but a moderate slavery.

**CLIENT** is now used for a party in a lawsuit, who has turned over his cause into the hands of a counsellor or solicitor.

**CLIFFORTIA**, in botany, a genus of the *diœcia polyandria* class. The calix of the male consists of three leaves; it has no corolla; and the stamina are about thirty. The calix of the female consists likewise of three leaves; and the corolla is wanting; the styli are two; and the capsule is bilocular, and contains one seed. The species are four, all natives of Æthiopia.

**CLIMACTERIC**, among physicians, a critical year in a person's life, in which he is supposed to stand in great danger of death.

According to some, every seventh year is a climacteric; but others allow only those years produced by multiplying 7 by the odd number 3, 5, 7, and 9, to be climacterical. These years, they say, bring with them some remarkable change with respect to health, life, or fortune; the grand climacteric is the sixty-third year; but some, making two, add to this the eighty-first: the other remarkable climacterics are the seventh, twenty-first, thirty-fifth, forty-ninth, and fifty-sixth.

**CLIMATE**, in geography, a space upon the surface of the terrestrial globe, contained between two parallels, and so far distant from each other, that the longest day in one differs half an hour from the longest day in the other parallel. See **GEOGRAPHY**.

**CLIMAX, or GRADATION**, in rhetoric, a figure wherein the word or expression which ends the first member of a period begins the second, and so on; so that every member will make a distinct sentence, taking its rise from the next foregoing, till the argument and period be beautifully finished; as in the following gradation of Dr Tillotson. "After we have practised good actions a while, they become easy; and when they are easy, we begin to take pleasure in them; and when they please us, we do them frequently; and by frequency of acts, a thing grows into a habit; and confirmed habit is a second kind of nature; and so far as any thing is natural, so far it is necessary; and we can hardly do otherwise; nay, we do it many times, when we do not think of it."

**CLINCH**, in the sea-language, that part of a cable which is bended about the ring of the anchor, and then seized, or made fast.

**CLINCHING**, in the sea-language, a kind of slight caulking used at sea, in a prospect of foul weather, about the posts: it consists in driving a little oakum into their seams, to prevent the water's coming in at them.

**CLINIC,**

**CLINIC**, a term applied by the ancient church-historians, to those who received baptism on their death-bed.

**CLINIC medicine**, was particularly used for the method of visiting and treating sick persons in bed, for the more exact discovery of all the symptoms of their disease.

**CLINOIDES**, in anatomy. See Vol. I. p. 158.

**CLINOPODIUM**, in botany, a genus of the didynamia gymnospermia class. The involucre is hoary. The species are three, only one of which is a native of Britain, viz. the vulgare, or great wild basil.

**CLIO**, in zoology, a genus of insects belonging to the order of vermes mollusca; the body is oblong, and fitted for swimming; and it has two membranaceous wings placed opposite to each other. The species are three, principally distinguished by the shape of their vagina, and are all natives of the ocean.

**CLIPEUS**, in natural history, a name given to the flat depressed centronæ, from their resembling a shield. See **CENTRONIA**.

**CLITORIA**, in botany, a genus of the diadelphia decandria class. The vexillum is large, open, plaited, and covers the alæ. The species are five, all natives of the Indies.

**CLITORIS**, in anatomy. See Vol. I. p. 276.

**CLOACA**, in Roman antiquity, the common sewer, by which the filth of the city of Rome was carried away.

**CLOCK**, a kind of movement, or machine, serving to measure time.

The invention of clocks is attributed to Pacificus, archdeacon of Verona, who lived in the time of Lotharius: others ascribe it to Boetius, about the year 510: be that as it will, it is certain, that the art of making clocks, such as are now in use, was either first invented, or at least retrieved in Germany, about 230 years ago; and the invention of pendulum clocks, so late as the last age, is disputed between Huygens and Galileo. For the principles of *Clock* and *Watch Work*, see **WATCH**.

**CLOGHER**, a city and bishop's see of Ireland, in the county of Tyrone, and province of Ulster, situated twelve miles west of Armagh: W. long. 7° 30', and N. lat. 54° 16'.

**CLOISTER**, an habitation surrounded with walls, and inhabited by religious.

In a more general sense, it is used for a monastery of religious of either sex. In the first sense, it is the principal part of a regular monastery, being a square surrounded with walls or buildings. It is commonly placed between the church, the chapter-house, and refectory, underneath the dormitory.

**CLOSE**, in heraldry. When any bird is drawn in a coat of arms with its wings close down about it, (*i. e.* not displayed), and in a standing posture, they blazon it by this word *close*; but if it be flying, they call it *volant*. See **VOLANT**.

**CLOT-bird**. See **FRINGILLA**.

**CLOTH**, in commerce, a manufacture made of wool, wove in the loom.

Cloths are of divers qualities, fine or coarse. The goodness of cloth, according to some, consists in the following particulars. 1. That the wool be of a good quality, and well dressed. 2. It must be equally spun, carefully observing that the thread of the warp be finer and better twisted than that of the woof. 3. The cloth must be well wrought, and beaten on the loom, so as to be every where equally compact. 4. The wool must not be finer at one end of the piece than in the rest. 5. The lifts must be sufficiently strong, of the same length with the stuff, and must consist of good wool, hair, or ostrich-feathers; or, what is still better, of Danish dog's hair. 6. The cloth must be free from knots, and other imperfections. 7. It must be well scoured with fuller's earth, well fulled with the best white soap, and afterwards washed in clear water. 8. The hair or nap must be well drawn out with the teazel, without being too much opened. 9. It must be shorn close without making it thread-bare. 10. It must be well dried. 11. It must not be tenter-stretched, to force it to its just dimensions. 12. It must be pressed cold, not hot pressed, the latter being very injurious to woollen cloth.

*Manufacturing of white cloths which are intended for dyeing.*

The best wool for the manufacturing of cloths are those England and Spain, especially those of Lincolnshire and Segovia. To use those wools to the best advantage, they must be scoured, by putting them into a liquor somewhat more than lukewarm, composed of three parts fair water, and one of urine. After the wool has continued long enough in the liquor to soak, and dissolve the grease, it is drained and well washed in running water. When it feels dry, and has no smell but the natural one of the sheep, it is said to be duly scoured.

After this it is hung to dry in the shade, the heat of the sun making it harsh and inflexible: when dry, it is beat with rods upon hurdles of wood, or on cords, to cleanse it from dust, and the grosser filth; the more it is thus beat and cleansed, the softer it becomes, and the better for spinning. After beating, it must be well picked, to free it from the rest of the filth that had escaped the rods.

It is now in a proper condition to be oiled, and carded on large iron cards, placed slopewise. Olive oil is esteemed the best for this purpose: one fifth of which should be used for the wool intended for the woof, and a ninth for that designed for the warp. After the wool has been well oiled, it is given to the spinners, who first card it on the knee with small fine cards, and then spin it on the wheel, observing to make the thread of the warp smaller by one third than that of the woof, and much compacter twisted.

The thread thus spun, reeled, and made into skeins, that designed for the woof is wound on little tubes, pieces of paper, or rushes, so disposed, as that they may be easily put in the eye of the shuttle. That for the warp is wound on a kind of large wooden bobbins, to dispose it for warping. When warped, it is stiffened with size, the best of which is that made of shreds

of parchment, and when dry, is given to the weavers, who mount it on the loom.

The warp thus mounted, the weavers, who are two to each loom, one on each side, tread alternately on the treddle, first on the right step, and then on the left, which raises and lowers the threads of the warp equally; between which they throw transversely the shuttle from the one to the other: and every time that the shuttle is thus thrown, and a thread of the woof inserted within the warp, they strike it conjunctly with the same frame, wherein is fastened the comb or reed, between whose teeth the threads of the warp are passed, repeating the stroke as often as is necessary.

The weavers having continued their work till the whole warp is filled with the woof, the cloth is finished; it is then taken off the loom by unrolling it from the beam whereon it had been rolled in proportion as it was wove; and now given to be cleansed of the knots, ends of threads, straws, and other filth, which is done with iron nippers.

In this condition it is carried to the fullery, to be scoured with urine, or a kind of potter's clay, well steeped in water, put along with the cloth in the trough wherein it is fulled. The cloth being again cleared from the earth or urine, is returned to the former hands to have the lesser filth, small straws, &c. taken off as before: then it is returned to the fuller to be beat and fulled with hot water, wherein a suitable quantity of soap has been dissolved; after fulling, it is taken out to be smoothed, or pulled by the lifts lengthwise, to take out the wrinkles, crevices, &c.

The smoothing is repeated every two hours, till the fulling be finished, and the cloth brought to its proper breadth: after which it is washed in clear water, to purge it of the soap, and given wet to the carders to raise the hair or nap on the right side with the thistle or weed. After this preparation the clothworker takes the cloth, and gives it its first cut or shearing; then the carders resume it, and after wetting, give it as many more courses with the teazle, as the quality of the stuff requires, always observing to begin against the grain of the hair, and to end with it; as also to begin with a smoother thistle, proceeding still with one sharper and sharper, as far as the sixth degree.

After these operations, the cloth being dried, is returned to the cloth worker, who sheers it a second time, and returns it to the carders, who repeat their operation as before, till the nap be well ranged on the surface of the cloth, from one end of the piece to the other.

The cloth thus wove, scoured, napped, and shorn, is sent to the dyer; when dyed, it is washed in fair water, and the worker takes it again wet as it is, lays the nap with a brush on the table, and hangs it on the tenters, where it is stretched both in length and breadth sufficiently to smooth it, set it square, and bring it to its proper dimensions, without straining it too much; observing to brush it afresh, the way of the nap, with a little moist, on the tenters.

When quite dry, the cloth is taken off the tenters, and brushed again on the table, to finish the laying of the nap; after which it is folded, and laid cold under a press, to make it perfectly smooth and even, and give it a gloss.

Lastly, the cloth being taken out of the press, and the papers, &c. for glossing it removed, it is in a condition for sale or use. With regard to the manufacture of mixt cloths, or those wherein the wools are first dyed, and then mixt, spun and wove of the colours intended, the process, except what relates to the colour, is mostly the same with that just represented.

**CLOUD**, a collection of vapours suspended in the atmosphere. See PNEUMATICS.

**CLOVE TREE**, in botany. See CARYOPHYLLUS.

**CLOVE**, a term used in weights of wool. Seven pounds make a clove.

In Essex, eight pounds of cheese and butter go to the clove.

**CLOVE JULY-FLOWER**. See CARYOPHYLLUS.

**CLOVER-GRASS**, in botany. See TRIFOLIUM.

**CLOYNE**, a city and bishop's see of Ireland, in the county of Cork, and province of Munster, about fifteen miles east of Coik: W. long. 8°, and N. lat. 51° 40'.

**CLUPEA**, or herring, in ichthyology, a genus belonging to the order of abdominales. The upper jaw is furnished with a serrated mystache; the branchiostegic membrane has eight rays; a scaly serrated line runs along the belly from the head to the tail; and the belly-fins have frequently nine rays. There are 11 species, viz.

1. The harengus, or common herring, has no spots, and the under jaw is longer than the upper one. A herring dies immediately after it is taken out of the water, whence the proverb arises, *As dead as a herring*. The flesh is every where in great esteem, being fat, soft, and delicate, especially if it is drest as soon as caught; for then it is incomparably better than on the next day. There are vast quantities of these fish taken, salted, sinoak-dried, and consumed all over Europe. They make a progress every year from the seas near the north of Scotland, into the British channel, coming in pursuit of worms and small fish, which at that time abound there. There is also plenty near Norway and Denmark, from whence they proceed annually as far as the coast of Normandy.

The herring-fishery is begun both by the English and Dutch towards the latter end of June; and the Dutch alone employ no less than one thousand ships therein, called busscs, from forty-five to sixty ton each. The best time for catching herrings is from the latter end of September, to the latter end of October; and the nets they make use of, are about twenty five yards long, and five deep. They sometimes fasten so many of these nets together, as will take in a mile in compass. They judge where the herrings lie by the hovering and motion of the sea-birds, which continually pursue them, in expectation of prey. The fishermen row very gently along, letting the nets fall into the  
sea,

sea, and taking their courses as near as they can against the tide; that so, when they draw their nets, they may have the assistance of the tide. As soon as any boat has got its load, it makes to the shore, and delivers its load to those that wash and gut them.

Herrings are put into a tub with salt or brine, where they lie for twenty-four hours, and are then taken out and put into wicker baskets and washed. After this, they are spitted on sharp wooden spits, and hang up in a chimney, built for that purpose, at such distances, that the smoke may have free access to them all. These places will hold ten or twelve thousand at a time; and they kindle billets on the floor in order to dry them. This done, they shut the doors, having before stopped up all the air-holes. This they repeat every quarter of an hour, inasmuch that a single salt of herrings requires five hundred billets to dry them. A salt is ten barrels, and each barrel contains about one thousand herrings. When they are smoke-dried in this manner, they are called red herrings. Salt herrings, and pickled herrings, are cured after a different manner; the last of which were formerly best done by the Dutch; but now the Scotch and English are become their rivals in that trade. Herrings always swim in shoals, delighting to be near the shore. They spawn but once a year, that is about the beginning of November; a little before which, like most other fish, they are in highest season.

There are likewise herrings on the coast of North America, but they are not so plenty as in Europe; and they never go farther south than the rivers of Carolina. There are none near Spain, Portugal, in the Mediterranean, nor on the coast of Africa.

2. The sprattus has 13 rays in the back-fin. It is a native of the European seas, and has a great resemblance to the herring, only it is of a less size.

3. The alosa, has a forked snout, and black spots on the sides. It is found in the European seas.

4. The encrascolus, or anchovy, has its upper jaw longer than the under one, and is found in the European seas. It is about three inches long, and is frequently used as a pickle.

5. The atherinoides has a shining line on each side, and small belly-fins. It is a native of Surinam.

6. The thrissa has 28 rays in the fin at the anus. It is found in the Indian ocean.

7. The sima has yellow fins, those of the belly being very small. The mouth is flat; the upper jaw is very short; the body is of a shining silver colour; and the fins are yellow. It is a native of Asia.

8. The sternicla has no belly-fins, and the body is broad. It is a native of Surinam.

9. The myltus is shaped like a sword, and the fins at the anus are united. It is found in the Indian ocean.

10. The tropica has a wedge-like tail, and a white, broad, compressed body; and the tail is wedge-shaped. It is found at Ascension island.

11. The sinensis is very like the common herring, but broader. It has no teeth, and is a native of China.

CLUSIA, in botany, a genus of the polygamia montecia class. The calix of the male consists of six leaves; the corolla has five petals; and the stamina are numerous. The calix and corolla of the female are the same as those of the male; the nectarium includes the germen and united antheræ; and the capsule has five cells, five valves, and a stuffed pulp. The species are four, all natives of America.

CLUGIA, in botany, a genus of the diœcia gynandria class. The calix and corolla, both of the male and female, consist of five leaves; the styli are three; and the capsule has three cells and one seed.

CLYDE, a river in Scotland, which, arising in Annandale, runs north-west by Lanerk, Hamilton, and Glasgow, and falls into the Frith of Clyde, over-against the isle of Bute.

CLYMENUM, in botany. See LATHYRUS.

CLYPEOLA, in botany, a genus of the tetradynamia siliculosa class. The pod is emarginated, roundish, entire, compressed, and deciduous. The species are two, none of them natives of Britain.

CLYPEUS, or CLYPEUM, a shield or buckler. See SHIELD.

CLYSSUS, an extract prepared, not from one, but several bodies mixt together: and, among the moderns, the term is applied to several extracts procured from the same body, and then mixed together. Thus, if from wormwood we draw the water, spirit, oil, salt, and tincture, and according to the rules of art re-unite these into a mass compounded of them all, and containing the joint virtues of all, we have a clyffus of wormwood.

CLYSTER, is a liquid remedy, to be injected chiefly at the anus into the larger intestines. It is usually administered by the bladder of a hog, sheep, or ox, perforated at each end, and having at one of the apertures an ivory pipe fastened with pack-thread. But the French, and sometimes the Dutch, use a pewter syringe, by which the liquor may be drawn in with more ease and expedition than in the bladder, and likewise more forcibly expelled into the large intestines. This remedy should never be administered either too hot or too cold, but tepid; for either of the former will be injurious to the bowels.

Clysters are prepared of different ingredients, according to the different intentions proposed.

Clysters are sometimes used to nourish and support a patient who can swallow little or no aliment, by reason of some impediment in the organs of deglutition. In which case they may be made of broth, milk, ale, and decoctions of barley and oats with wine. The English introduced a new kind of clyster, made of the smoke of tobacco, which has been used by several other nations, and appears to be of considerable efficacy when other clysters prove ineffectual, and particularly in the iliac passion, in the *hernia incarcerata*, and for the recovery of drowned persons.

CNEORUM, in botany, a genus of the triandria monogynia class. The calix has three teeth; and the corolla has three equal petals. There is but one species, viz. the tricocum, a native of Spain.

CNICUS,

**CNICUS**, or **SAFFRON FLOWER**, in botany, a genus of the syngenesia polygamia aequalis class. The calix is ovated, and imbricated with spinous branches; and the corolla are equal. The species are seven, none of them natives of Britain.

**COA**, in botany. See **HIPPOCRATEA**.

**COACH**, a commodious vehicle for travelling, so well known as to need no description. Their invention was owing to the French about the reign of Francis I.

**COAGULATION**, in a general sense, imports a certain change in the state of any liquor, by means of which, instead of retaining its fluidity, it becomes more or less consistent, according to the degree of coagulation.

**COAGULUM**, is the same with what in English we call runnet, or rather the curd formed thereby.

**COAL**, or **PIT-COAL**, in natural history. See **LITHANTHRAX**.

*Cannel-COAL*, in natural history. See **AMPELITES**.

*Small-COAL*, a sort of charcoal prepared from the spray and brush-wood stripped off from the branches of coppice-wood, sometimes bound in bavons for that purpose, and sometimes charred without binding, and then it is called coming it together.

**COALITION**, the re-union of the parts of a body before separated.

**COAT**, or **COAT OF ARMS**, in heraldry, a habit worn by the ancient knights over their arms both in war and tournaments, and still borne by heralds at arms. It was a kind of sur-coat, reaching as low as the navel, open at the sides with short sleeves, sometimes furred with ermine and hair, upon which were applied the armories of the knights embroidered in gold and silver, and enamelled with beaten tin-coloured black, green, red, and blue; whence the rule never to apply colour on colour, nor metal on metal. The coats of arms were frequently open, and diversified with bands and fillets of several colours, alternately placed, as we still see cloths scarleted, watered, &c. Hence they were called *devises*, as being divided and composed of several pieces sewed together; whence the words *false, pale, chevron, bend, cross, saltier, lozenge, &c.* which have since become honourable pieces, or ordinaries of the shield. See **CROSS**, **BEND**, **CHEVRON**, &c.

Coats of arms and banners were never allowed to be worn by any but knights and ancient nobles.

**COAT**, in anatomy. See **PART VI**.

**COAT of MAIL**. See **MAIL**.

**COATI**, in zoology, a synonyme of a species of *viverra* and *ursus*. See **VIVERRA** and **URSUS**.

**COBALT**, in chemistry, a genus of fossils, of the order of the *aphurelata*: it is a dense, compact, and ponderous mineral, very bright and shining, and much resembling some of the antimonial ores. See **ANTI-MONY**, and **CHEMISTRY**, p. 139, 140, 141.

It is sometimes found of a deep bluish-black, very heavy and hard, and of a granulated structure, looking like a piece of pure iron when fresh broken: at other times it is found more compact, not granulated,

but resembling a mass of melted lead on the surface. These are the more ordinary appearances of cobalt, besides which there are other accidental varieties of it, being sometimes found of a florid red, or a red debased by mixtures of grey, black, or yellow; and in this state, it either forms an uniform mass, or a beautifully striated and ridged one.

From this mineral are produced the several kinds of arsenic, zaffre, and smalt. See **CHEMISTRY**, p. 145.

**COBELLA**, in zoology, the trivial name of a species of coluber. See **COLUBER**.

**COBITIS**, the loache, in ichthyology, a genus of fishes belonging to the order of abdominales. The eyes are in the upper part of the head. The branchiostegic membrane has from four to five rays; and the body is nearly of an equal thickness throughout. The species are five, *viz.* the *anablops*, with two cirri, a depressed head, and prominent eyes. It is found on the coasts of Surinam. 2. The *barbatula*, with six cirri, and a compressed smooth head. 3. The *tænia*, with six cirri, and a prickle below the eye. The above two are found in the fresh-waters of Europe. 4. The *folifilis*, with eight cirri, and a prickle above the eye. It is a native of Europe. 5. The *heteroclita*, has no cirri; and the back-fin and that at the anus are full of white spots. It is a native Carolina.

**COBLENTZ**, a large city of Germany, in the archbishopric of Triers, and circle of the Lower Rhine, situated at the confluence of the Rhine and Moselle, fifty two miles north-east of Triers, and thirty-six fourth of Cologne: E. long. 7° 15', N. lat. 50° 30'.

**COBLON**, a port-town of the hither India, situated on Coromandel-coast, twelve miles south of Fort St George: E. long. 80°, N. lat. 12. 50'.

**COBWEB**, in physiology, the fine net-work which spiders spin out of their own bowels, in order to catch their prey. See **ARANEA**.

**COCCEIRA** in botany. See **THEOBROMA**.

**COCCIFEROUS PLANTS**, the same with *bacciferous*. See **BACCIFEROUS**.

**COCCINELLA**, in zoology, a genus of insects, of the coleoptera order. The antennæ are fulclavated, and truncated; the polypi are shaped like a hart; the body is of a hemispherical figure; the breast and elytra are marginated; and the belly is plain. The species are forty-nine, mostly distinguishable by the number and colour of the spots on their wings, and the plants upon which they live.—The *coccinella cacti*, a native of the warmer parts of America, is the famous cochineal animal, so highly valued in every part of the world for the incomparable beauty of its red colour, which it equally communicates to wool, silk, linen, and cotton. It is bred on a plant known in Oaxaca in New Spain, and all those parts where it abounds, by the name of *nopal*, or *nopalleca*, the Indian fig-tree, which, except in the difference of the foliage, resembles the *tunes*, so common in the kingdom of Andalusia; the leaf of the *tuna* being broad, flat and prickly, and that of the *nopal*, oblong, with several eminences;

eminences; and instead of spines has a fine smooth membrane, of a permanent and lively green.

The method of planting the nopal is by making rows of holes about half a yard deep, and about two yards distant from one another. In each of these holes is placed one or two leaves of the nopal, in a flat position, and then covered with earth. This leaf soon after shoots up into a single stem, which during its growth divides into several branches, and these successively produce fresh leaves, the largest being nearest to the stem, which is full of knots, as are also the branches, and from these the leaves have their origin. The usual height of this plant is about three yards, which it seldom exceeds. The season when the nopal displays all its beauty and vigour, is like that of other plants, from the spring to the autumn, which at Oaxaca and other parts of North America is at the same time as in Spain. Its blossom is small, of a bright red, and in the shape of a bud; from the centre of which proceeds the tuna, a name given to its fruit; and as this increases the blossom fades, till at length it falls. When the tuna, or fig, is ripe, the outward skin becomes white; but the pulp is so fully impregnated with a deep red, that it tinges the urine of those who eat it of a blood colour, a circumstance attended with no small uneasiness to those who are unacquainted with this particular. Few fruits, however, are either more wholesome or pleasant.

The ground where the nopal is intended to be planted, must be carefully cleansed from all kinds of weeds, as they drain the soil of those juices which the nopal requires. Also after the cochineal is taken from the plant, which is never done till the insects are arrived at perfection, all the superfluous leaves are plucked off, that they may be succeeded by others the following year. For it must be observed, that the cochineal which are bred on young plants thrive much better, and are of a finer quality, than those produced on such as have stood some years.

The cochineal was formerly imagined to be a fruit or seed of some particular plant; an error which probably arose from an ignorance of the manner in which it is propagated; but at present every one is convinced of its being an insect, agreeably to its name, signifying a woodlouse, which generally breeds in damp places, especially in gardens. These insects, by rolling themselves up, form a little ball something less than a pea, and in some places are known by the name of Baquilas de San Anton, *i. e.* St Anthony's little cows: and such is the figure of the cochineal, except that it has not the faculty of rolling itself up; and its magnitude, when at its full growth, does not exceed that of a tick, common in dogs and other animals.

These insects breed and are nourished on the nopals, where their eggs are placed among the leaves; the juice of the plant, which is their sole nourishment, becomes converted into their substance; when, instead of being thin and watery, and, to all outward appearance, of little or no use, is rendered a most beautiful crimson colour. The plant is in May or June in its most vigorous state, and at this most favourable season the eggs

are deposited: and in the short space of two months from an animalcule, the insect grows up to the size above-mentioned; but its infant state is exposed to a variety of dangers; the violent blasts of the north wind sweep away the eggs from the foliage of the plant; and, what is equally fatal to their tender constitutions, showers, fogs, and frosts, often attack them, and destroy the leaves, leaving the careful cultivator this only resource, namely, that of making fires at certain distances, and filling the air with smoke, which frequently preserves them from the fatal effects of the inclemency of the weather.

The breeding of cochineal is also greatly obstructed by birds of different kinds, which are very fond of these insects; and the same danger is to be apprehended from the worms, *&c.* which are found among the plantations of nopals: so that unless constant care be taken to fright the birds away from the plantation, and to clear the ground of those various kinds of vermin, which multiply so fast in it, the owner will be greatly disappointed in his expectations.

When the insects are at their full growth, they are gathered and put into pots of earthen ware; but great attention is requisite to prevent them from getting out, as, in that case, great numbers of them would be lost; though there is no danger of it, where they are at liberty on the nopal leaves, those being their natural habitation; and where they enjoy a plenty of delicious food; for, though they often remove from one leaf to another, they never quit the plant; nor is it uncommon to see the leaves entirely covered with them, especially when they are arrived at maturity. When they have been confined some time in these pots, they are killed and put in bags. The Indians have three different methods of killing these insects, one by hot water, another by fire, and a third by the rays of the sun: and to these are owing the several gradations of the colour, which in some is dark, and in others bright; but all require a certain degree of heat. Those therefore who use hot water are very careful to give it the requisite heat, and that the quantity of water be proportioned to the number of insects. The method of killing the creatures by fire is to put them on shovels into an oven moderately heated for that intention; the fine quality of the cochineal depending on its not being over dried at the time of killing the insects: and it must be owned, that among the several ways made use of to destroy this valuable creature, that of the rays of the sun seems to bid fairest for performing it in the most perfect manner.

Besides the precaution requisite in killing the cochineal, in order to preserve its quality, it is equally necessary to know when it is in a proper state for being removed from the leaves of the nopal; but as experience only can teach the cultivator this necessary criterion, no fixed rule can be laid down. Accordingly in those provinces where the cultivation of these insects is chiefly carried on, those gathered by Indians of one village differ from those gathered in another; and even those gathered by one person in the same village, are often different from those gathered by another; every individual adhering to his own method.

The cochineal insect may, in some circumstances, be compared to the silk worm, particularly in the manner of depositing its eggs. The insects destined for this particular are taken at a proper time of their growth, and put into a box well closed, and lined with a coarse cloth that none of them be lost: and in this confinement they lay their eggs and die. The box is kept close shut till the time of placing the eggs on the nopal, when, if any motion is perceived, it is a sufficient indication that the animalcule has life, tho' the egg is so minute as hardly to be perceived; and this is the seed placed on the foliage of the nopal, and the quantity contained in the shell of a hen's egg is sufficient for covering a whole plant. It is remarkable that this insect does not, or at least in any visible manner, injure the plant, but extracts its nourishment from the most succulent juice, which it sucks by means of its proboscis through the fine teguments of the leaves.

The principal countries where the cochineal insects are bred, are Oaxaca, Fascalá, Chulula, Nueva Galicia, and Chiapa, in the kingdom of New Spain; and Hambato, Loja, and Tucuman in Peru: but it is only in Oaxaca, that they are gathered in large quantities, and form a branch of commerce, the cultivation of these little creatures being there the chief employment of the Indians.

**COCCOTHRUSTES**, in ornithology, the trivial name of a species of loxia. See **LOXIA**.

**COCCULUS INDICUS**, the name of a poisonous berry, too frequently used by brewers in order to render their malt liquors intoxicating. It is the fruit of the *menispermum cocculus*. See **MENISPERMUM**.

**COCCUS**, in zoology, a genus belonging to the order of hemiptera. The rostrum proceeds from the breast; the belly is bristly behind; the wings of the male are erect; and the female has no wings. The species are twenty-two, denominated principally from the plants they frequent.

**COCCYGÆUS MUSCULUS**, in anatomy. See Vol. I. p. 220.

**COCCYX**, or **COCCYGIS OS**, in anatomy. See Vol. I. p. 171.

**COCHIN**, a port-town of India, on the Malabar-coast, about an hundred miles south of Calicut: W. long. 75°, and N. lat. 9° 30'. Here the Dutch have a factory, and a very strong fort.

**COCHIN CHINA**, a kingdom of India, situated between 104° and 109° E. long. and between 10° and 17° N. lat. being bounded by the kingdom of Tonquin on the north, by the Indian ocean on the east and south, and by the kingdom of Cambodia on the west: it is upwards of four hundred miles long, and one hundred and fifty broad, producing chiefly silk and rice.

**COCHINEAL**. See **COCCINELLA**.

**COCHLEA**, the **SNAIL-SHELL**, in zoology. See **LIMAX**.

**COCHLEA**, in anatomy. See Vol. I. p. 297.

**COCHLEARIA SCURVY-GRASS**, in botany, a genus of the tetradynamia filiculosa class. The pod is emarginated, tergid, and scabrous; and the valves are ob-

tuse and gibbous. The species are eight, six of which are natives of Britain, viz. the officinalis, or common scurvy-grass, the leaves of which are famous for curing the scurvy; the groenlandica, or Gœnland scurvy-grass; the anglica, or common sea scurvy grass; the danica, or Danish scurvy-grass; the coronopus, or swine-creffes; and the armoracia, or horse-radish.

**COCHLITES**, in natural history, an appellation given to the petrified shells of the cochleæ, or snails.

**COCK**, in zoology, the English name of the males of gallinaceous birds, but more especially used for the common dunghill-cock. See **PHASIANUS**.

**COCK'S-COMB**, in botany. See **PHIANTHUS**.

**COCK-PIT**, a sort of theatre upon which game-cocks fight.

**COCK-PIT**, in a man of war, a place on the lower floor, or deck, abaft the main-captain, lying between the platform and the steward's room, where are partitions for the purser, surgeon, and his mates.

**COCK-SWAIN**, or **COXON**, an officer on board a man of war, who has the care of the barge and all things belonging to it, and must be also ready with his crew to man the boat on all occasions: he sits at the stern of the boat, and steers.

**COCKERMOUTH**, a borough-town of Cumberland, situated on the river Derwent, near the Irish sea, about twenty-five miles south-west of Carlisle: W. lon. 3° 10', and N. lat. 54° 35'. It sends two members to parliament.

**COCKET** is a seal belonging to the king's custom-house, or rather a scroll of parchment sealed and delivered by the officers of the customs to merchants, as a warrant that their merchandises are customed.

It is also used for the office where goods transported were first entered, and paid their custom, and had a cocket or certificate of discharge.

**COCOA**, or **CACAO**, in botany. See **THEOBROMA**.

**COCOI**, in ornithology. See **ARCTEA**.

**COCONATO**, a town of Italy in the province of Piedmont, about twenty miles east of Turin; it is said to be the birth-place of the famous Columbus, who discovered America: E. long. 8°, and N. lat. 44° 50'.

**COCTION**, a general term for all alterations made in bodies by the application of fire or heat.

**COD**, in ichthyology. See **GADUS**.

**COD** is also a term used, in some parts of the kingdom, for a pod. See **POD**.

**COD-CAPE**, in geography, a promontory on the coast of New England, near the entrance of Bolton harbour: W. long. 69° 50', and N. lat. 42°.

**CODDY-MODDY**, the English name of a species of larus. See **LARUS**.

**CODE**, a collection of the laws and constitutions of the Roman emperors, made by order of Justinian. See **LAW**.

**CODEX**, in antiquity, denotes a book or tablet, upon which the ancients wrote. It was of the bark of a tree, of ivory, of parchment, or of paper.

**CODIA**, among botanists, signifies the head of any plant, but more particularly a poppy head, whence its syrup is called diacodium.

**CODICIL**,



- CODICIL** is a writing by way of supplement to a will, when any thing is omitted which the testator would have added, or wants to be explained, altered, or recalled.
- CODLIN**, an apple useful in the kitchen, being proper for baking.
- CODLING**, an appellation given to the cod fish when young. See **GADUS**.
- COECUM**, in anatomy. See Vol. I. p. 260.
- COEFFICIENTS**, in algebra. See Vol. I. p. 80.
- COELESTIAL**, in general, denotes any thing belonging to the heavens: thus we say, *coelestial observations*, the *coelestial globe*, &c.
- COELIAC artery**, in anatomy. See Vol. I. p. 232.
- COELIAC passion**, in medicine, a kind of flux, or diarrhoea, wherein the aliments, either wholly changed, or only in part, pass off by stool. See **MEDICINE**.
- COELIAC vein**, in anatomy. See Vol. I. p. 245.
- COELOMA**, among physicians, a hollow ulcer seated in the cornea tunica of the eye.
- COENOBITE**, in church-history, a sort of monks in the primitive Christian church. They were so called from living in common; in which they differed from the anchorites, who retired from society.
- COENOBITE**, in a modern sense, is a religious who lives in a convent or community, under certain rules.
- COEUR**, in heraldry, a short line of partition in pale, in the centre of the escutcheon, which extends but a little way, much short of the top and bottom, being met by other lines, which form an irregular partition of the escutcheon. See Plate LXV. fig. 7.
- COEVORDEN**, a town of the province of Overijssel, strongly fortified by the famous Coehorn, on account of its situation, it being the key to the provinces of Groningen and Friesland.
- COFFEA**, the **COFFEE-TREE**, in botany, a genus of the pentandria monogynia class. The corolla is hypocrateriform; the stamina are above the tube; the berry is below the flower, and contains two seeds, which are arillated. The species are two, *viz.* the arabica, a native of Arabia and Æthiopia; and the occidentalis, a native of America. The berries of both species have much the same qualities. This fruit is used rather as food than as a medicine. The medical effects expected from it are, to assist digestion, promote the natural secretions, and to prevent or remove a disposition to sleep.
- Coffee pays on importation 1l. 13s. 6 $\frac{1}{8}$ d. the hundred weight; the drawback on exportation is 1l. 10s. 2 $\frac{3}{4}$ d. Upon payment of the above duty, the coffee is to be put into warehouses; and upon delivery from thence, if to be consumed in Great Britain, is to pay for every hundred weight 8l. 8s. if of the British plantations in America, and 11l. 4s. if it comes from any other place.
- COFFERER** of the king's household, a principal officer in the court, next under the comptroller, who, in the counting-house, and elsewhere at other times, has a special charge and oversight of other officers of the house, for their good demeanor and charge in their offices, to all which he pays their wages.
- COGENDE**, a city of Tartary in Asia, situated in 74° E. long. and 41° N. lat. remarkable for its commerce in musk.
- COGGLE**. See **COGS**.
- COGGSHALL'S sliding rule**. See **SLIDING RULE**.
- COGITATION**, a term used by some for the act of thinking.
- COGNATE**, in Scots law, any male relation through the mother.
- COGNATION**, in the civil law, a term for that line of consanguinity which is between males and females, both descended from the same father; as agnation is for the line of parentage between males only descended from the same stock.
- COGNI**, the capital of Caramania, in the lesser Asia, anciently called Iconium, about two hundred and fifty miles south-east of Constantinople: E. long. 33°, and N. lat. 38°.
- COGNITIONIS CAUSA**, in Scots law: When a creditor charges the heir of his debtor to enter, in order to constitute the debt against him, and the heir renounces the succession, the creditor can obtain no decreet of constitution of that debt against the heir; but only a decreet subjecting the *hereditas jacens*, or the estate which belonged to the debtor, to his diligence: and this is called a decreet *cognitionis causæ*. See **SCOTS LAW**, title, *Comprisings and adjudications*.
- COGNIZANCE**, in heraldry. See **CREST**.
- COGNIZANCE**, or **CONNUSANCE**, in law, has divers significations: sometimes it is an acknowledgment of a fine, or confession of something done; sometimes the hearing of a matter judicially, as to take cognizance of a cause; and sometimes a particular jurisdiction, as cognizance of pleas is an authority to call a cause or plea out of another court, which no person can do but the king, except he can shew a charter for it. This cognizance is a privilege granted to a city or town, to hold plea of all contracts, &c. within the liberty; and if any one is impleaded for such matters in the courts at Westminster, the mayor, &c. of such franchise may demand cognizance of the plea, and that it be determined before them.
- COGNIZANCE** is also used for a badge on a waterman's or serving-man's sleeve, which is commonly the giver's crest, whereby he is discerned to belong to this or that nobleman or gentleman.
- COGS**, or **COGGLES**, a kind of flat-bottomed boats used in rivers.
- COHABITATION**, denotes the state of a man and a woman who live together like husband and wife, without being legally married.
- By the common law of Scotland, cohabitation for year and day, or a complete twelvemonth, is deemed equivalent to matrimony.
- CO-HEIR**, one who succeeds to a share of an inheritance, to be divided among several.
- COHESION**, in philosophy, that action by which the particles of the same body adhere together, as if they were but one. See **MECHANICS**.
- COHORT**, in Roman antiquity, the name of part of the

the Roman legion, comprehending about six hundred men. There were ten cohorts in a legion, the first of which exceeded all the rest, both in dignity and number of men. When the army was ranged in order of battle, the first cohort took up the right of the first line, the rest followed in their natural order, so that the third was in the centre of the first line of the legion, and the fifth on the left, the second between the first and third, and the fourth between the third and fifth: the five remaining cohorts formed a second line, in their natural order.

**COIF**, the badge of a serjeant at law, who is called serjeant of the coif, from the lawn-coif they wear under their caps when they are created serjeants.

The use of the coif was to cover the clerical tonsure. See **TONSURE**.

**COIL**. See **QUOIL**.

**COILON** in the ancient Grecian theatres, the same with the cavea of the Romans. See **CAVEA**.

**COILOPHYLLUM**, in botany. See **SARRACENA**.

**COIMBRA**, a large city of Portugal, in the province of Beira, situated on the river Mondego, about nine-six miles north of Lisbon: W. long.  $9^{\circ}$ , and N. lat.  $40^{\circ} 20'$ .

**COIN** denotes all manner of the several stamps and species of money in any nation. See **MONEY**.

**COIN**, in architecture, a kind of dye cut diagonal-wise, after the manner of a flight of a stair case, serving at bottom to support columns in a level, and at top to correct the inclination of an entablature supporting a vault.

**COIN** is also used for a solid angle composed of two surfaces inclined towards each other, whether that angle be exterior, as the coin of a wall, a tree, &c. or interior, as the coin of a chamber or chimney. See **QUOIN**.

**COINAGE**, or **COINING**, the art of making money, as performed either by the hammer or mill.

Formerly the fabric of coins was different from what it is at present. They cut a large plate of metal into several little squares, the corners of which were cut off with sheers. After having shaped these pieces, so as to render them perfectly conformable, in point of weight, to the standard piece, they took each piece in hand again, to make it exactly round, by a gentle hammering. This was called a planchet, and was fit for immediate coining. Then engravers prepared, as they still do, a couple of steel masses in form of dyes, cut and terminated by a flat surface, rounded off at the edges. They engraved or stamped on it the hollow of a head, a cross, a scutcheon, or any other figure, according to the custom of the times, with a short legend. As one of these dyes was to remain dormant, and the other moveable, the former ended in a square prism, that it might be introduced into the square hole of the block, which, being fixed very fast, kept the dye as steady as any vice could have done. The planchet of metal was horizontally laid upon this inferior mass, to receive the stamp of it on one side, and that of the upper dye, wherewith it was covered, on the other. This moveable dye, having its round

engraved surface resting upon the planchet, had at its opposite extremity a flat square, and larger surface, upon which they gave several heavy blows, with a hammer of an enormous size, till the double stamp was sufficiently, in relievo, impressed on each side of the planchet. This being finished, was immediately succeeded by another, and they thus became a standard coin, which had the degree of fineness, the weight and mark, determined by the judgment of the inspectors, to make it good current money. The strong tempering which was and is still given to the two dyes, rendered them capable of bearing those repeated blows. Coining has been considerably improved and rendered expeditious, by several ingenious machines, and by a wise application of the surest physical experiments to the methods of fining, dyeing, and stamping the different metals.

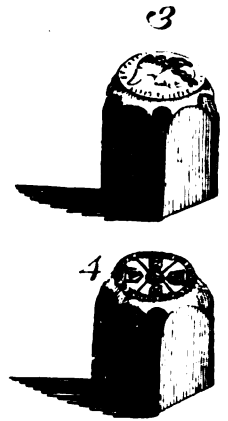
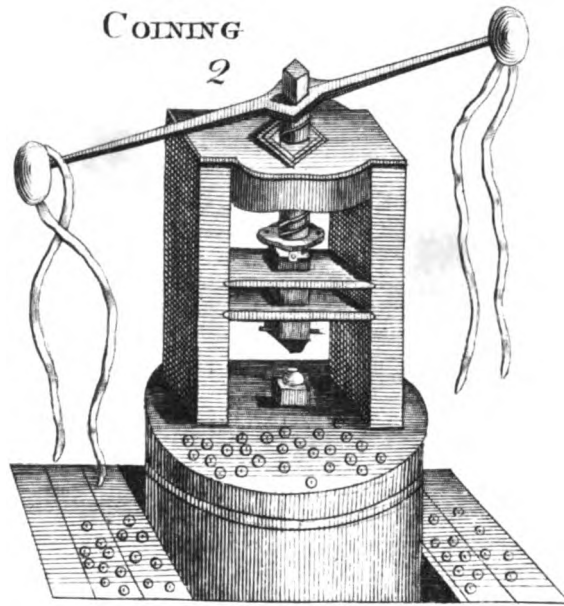
The three finest instruments the mint-man uses, are the laminating engine, the machine for making the impressions on the edges of coins, and the mill.

After they have taken the laminæ, or plates of metal, out of the mould into which they are cast, they do not beat them on the anvil, as was formerly done, but they make them pass and repass between the several rollers of the laminating engine, which being gradually brought closer and closer to each other, presently give the lamina its uniform and exact thickness. Instead of dividing the lamina into small squares, they at once cut clean out of it as many planchets as it can contain, by means of a sharp steel trepan, of a roundish figure, hollow within, and of a proportionable diameter, to shape and cut off the piece at one and the same time. After these planchets have been prepared and weighed with standard pieces, filed or scraped to get off the superfluous part of the metal, and then boiled and made clean, they arrive, at last, at the machine, (Plate LXVI. fig. 1.), which marks them upon the edge; and finally, the mill, (fig. 2.) which, squeezing each of them singly between the two dyes, brought near each other with one blow, forces the two surfaces or fields of the piece to fill exactly all the vacancies of the two figures engraved hollow. The engine which serves to laminate lead, gives a sufficient notion of that which serves to flatten gold and silver laminæ between rollers of a lesser size. See **LAMINATING**.

The principal pieces of the machine, (fig. 1.), to stamp coins on the edge, are two steel laminæ, about a line thick. One half of the legend, or of the ring, is engraved on the thickness of one of the laminæ; and the other half on the thickness of the other; and these two laminæ are straight, although the planchet marked with them be circular.

When they stamp a planchet, they first put it between the laminæ in such a manner, as that these being each of them laid flat upon a copper-plate, which is fastened upon a very thick wooden table, and the planchet being likewise laid flat upon the same plate, the edge of the planchet may touch the two laminæ on each side, and in their thick part.

One of these laminæ is immovable, and fastened with



5 CRAMPONEE



6 CRENELLE



7 CROSSELETS

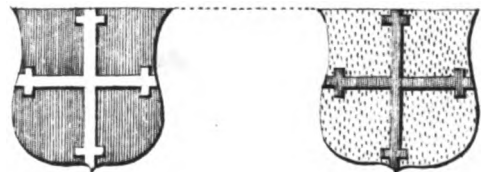


Fig. 8. ANTIENT CROWNS

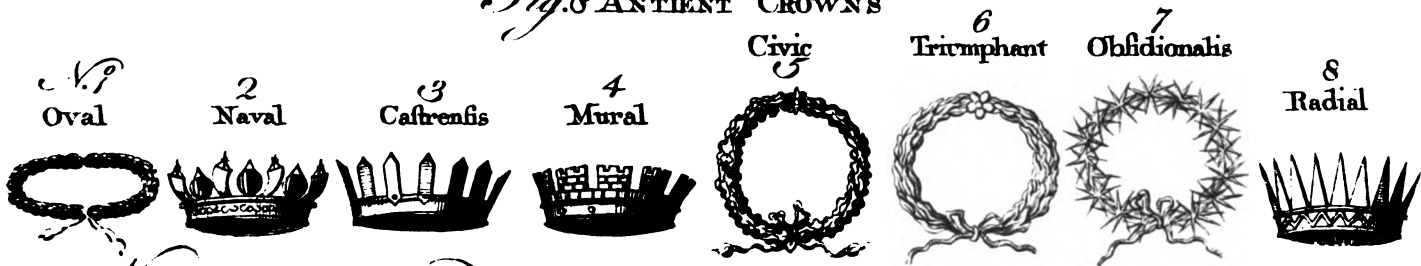


Fig. 9. ROYAL CROWNS

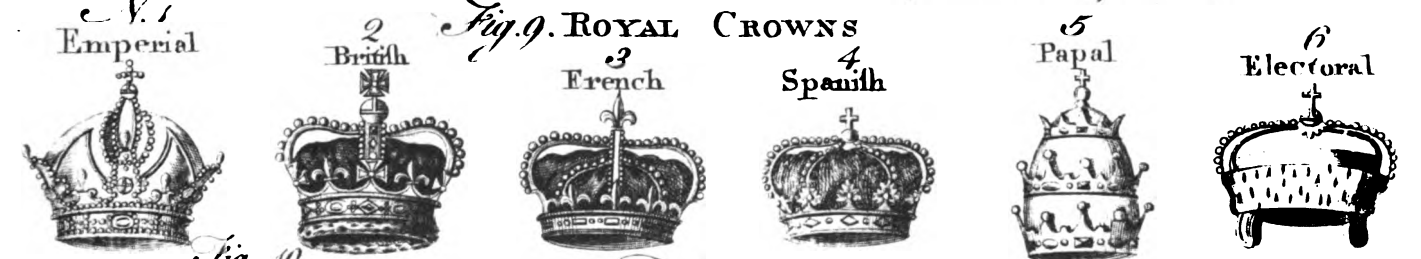


Fig. 10. CROWNS of the Blood Royal of Great Britain

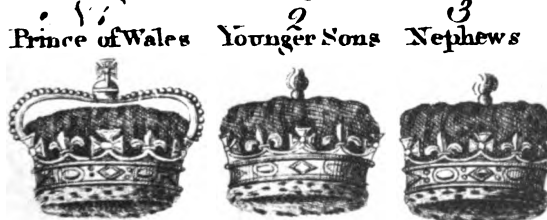


Fig. 11. CROWNS of the British Nobility





with several screws; the other slides by means of a dented wheel, which takes into the teeth that are on the surface of the lamina. This sliding lamina makes the planchet turn in such a manner, that it remains stamped on the edge, when it has made one turn. Only crown and half-crown pieces can bear the impression of letters on the thickness of their edges.

The coining engine or mill is so handy (fig. 2.) that a single man may stamp twenty thousand planchets in one day: gold, silver, and copper planchets, are all of them coined with a mill, to which the coining squares, (fig. 3.), commonly called dyes, are fastened; that of the face under, in a square box garnished with male and female screws, to fix and keep it steady; and the other above, in a little box garnished with the same screws, to fasten the coining square. The planchet is laid flat on the square of the effigy, which is dormant; and they immediately pull the bar of the mill by its cords, which causes the screw set within it to turn. This enters into the female screw, which is in the body of the mill, and turns with so much strength, that by pushing the upper square upon that of the effigy, the planchet, violently pressed between both squares, receives the impression of both at one pull, and in the twinkling of an eye.

The planchet thus stamped and coined, goes through a final examination of the mint wardens, from whose hands it goes into the world.

*In the COINING of medals*, the process is the same, in effect, with that of money; the principal difference consisting in this, that money having but a small relief, receives its impression at a single stroke of the engine; whereas for medals, the height of their relief makes it necessary that the stroke be repeated several times: to this end the piece is taken out from between the dyes, heated, and returned again; which process in medallions and large medals, is repeated fifteen or twenty times before the full impression be given, care must be taken, every time the planchet is removed, to take off the superfluous metal stretched beyond the circumference with a file. Medallions, and medals of a high relief, are usually first cast in sand, by reason of the difficulty of stamping them in the press, where they are put only to perfect them; in regard the sand does not leave them clear, smooth, and accurate enough. Therefore we may see that medals receive their form and impression by degrees, whereas money receives them all at once.

*British COINAGE*, both by the beauty of the engraving, and by the invention of the impressions on the edges, that admirable expedient for preventing the alteration of the species, is carried to the utmost perfection.

It was only in the reign of king William III. that the hammer-money ceased to be current in England, where till then it was struck in that manner, as in other nations. Before the hammer species was called in, the English money was in a wretched condition, having been filed and clipped by natives as well as foreigners, insomuch that it was scarce left of half the value: the retrieving this distressed state of the Eng-

lish money is looked upon as one of the glories of king William's reign.

The British coinage is now wholly performed in the Tower of London, where there is a corporation for it, under the title of the mint. Formerly there were here, as there are still in other countries, the rights of seignorage and brassage: but since the eighteenth year of king Charles the Second, there is nothing taken either for the king, or for the expences of coining; so that weight is returned for weight, to any person who carries their gold and silver to the Tower.

The species coined in Great Britain are esteemed contraband goods, and not to be exported. All foreign species are allowed to be sent out of the realm, as well as gold and silver in bars, ingots, dust, &c.

*Barbary COINAGE*, particularly that of Fez and Tunis, is under no proper regulations, as every goldsmith, Jew, or even private person, undertakes it at pleasure; which practice renders their money exceeding bad, and their commerce very unsafe.

*Muscovite COINAGE*. In Muscovy there is no other coin struck but silver, and that only in the cities of Muscow, Novogrod, Twer, and Pleskow, to which may be added Petersburg. The coinage of each of these cities is let out to farm, and makes part of the royal revenue.

*Persian COINAGE*. All the money made in Persia is struck with a hammer, as is that of the rest of Asia; and the same may be understood of America, and the coasts of Africa, and even Muscovy: the king's duty, in Persia, is seven and a half *per cent.* for all the monies coined, which are lately reduced to silver and copper, there being no gold coin there, except a kind of medals, at the accession of a new sopher.

*Spanish COINAGE* is esteemed one of the least perfect in Europe. It is settled at Seville and Segovia, the only cities where gold and silver are struck.

COIRE, or CHUR, the capital of the country of the Grisons, in Switzerland, situated on the river Rhine, fifty-three miles south of Constance: E. long. 9° 25', N. lat. 46° 40'.

COITION. See GENERATION.

COIX, or JOE'S TEARS, in botany, a genus of the monoecia triandria class. The calix of the male is a double-flowered glume, without any awn; the corolla is likewise a glume without an awn: the calix of the female is an open, oval, one-flowered glume; the stylus is bifid; and the seed is cartilaginous. There is but one species, *viz.* the *latifolia*, a native of Jamaica.

COKENHAUSEN, a fortress of Livonia, situated on the river Dwina, about thirty-two miles east of Riga: E. long. 25°, N. lat. 57°.

COLATURE. See FILTRATION.

COLCHESTER, a large borough-town of Essex, situated on the river Coln, twenty miles north-east of Chelmsford, on the road to Harwich: E. long. 1°, N. lat. 51° 55'. It sends two members to parliament.

COLCHICUM, or MEADOW SAFFRON, in botany, a

- genus of the hexandria trigynia class. The corolla is divided into six segments, and the tube is radicated; it has three inflated cupfules united together. The species are three, only one of which, *viz* the autumnale, or meadow-saffron, is a native of Britain.
- COLD**, in general, denotes the privation or absence of heat; and, consequently, those who suppose heat to consist in a brisk agitation of the component particles of the hot body, define cold to be such a faint motion of these parts, as is either altogether or nearly imperceptible to our organs of feeling: in which sense, cold is a mere term of relation between the cold body and the organs of sensation; and, in fact, the same body will be felt either hot or cold, according as the sensible organ is colder or hotter than it.
- COLD**, in medicine, is found to be productive of inflammatory disorders, as coughs, pleurisies, peripneumonies, rheumatic pains, consumptions, &c. See **MEDICINE**.
- COLDENIA**, in botany, a genus of the tetrandria tetragynia class. The calix has four leaves; the corolla is tunnel-shaped; the fruit consists of four seeds. There is but one species, a native of India.
- COLD-FINCH**. See **MOTACILLA**.
- COLDSHIRE-IRON**, that which is brittle when cold.
- COLE-FISH**. See **GADUS**.
- COLE-MOUSE**, in ornithology. See **PARUS**.
- COLEOPTERA**, the name of Linnæus's first order of insects. The insects belonging to this order have four wings; the upper pair, which serve as covers to the other two, are crustaceous, with a straight ridge or suture in the middle. See **NATURAL HISTORY**.
- COLE-SEED**, the seed of the *napus sativa*, or long-rooted, narrow-leaved rapa, called, in English, navew, and comprehended by Linnæus among the brassicas, or cabbage-kind. See **BRASSICA**.
- This plant is cultivated to great advantage in many parts of England, on account of the nape-oil expressed from its seeds. It requires a rich and strong soil, especially in march or fenny lands, those newly recovered from the sea, or indeed any other land that is rank and fat, whether arable or pasture. The best seeds are brought from Holland, and should be sown about Midsummer, the very day that the land is plowed: a gallon will serve an acre.
- Besides the oil already mentioned, it is likewise cultivated for winter-food to cattle, and is a very good preparative of land for barley or wheat.
- COLE-WORT**. See **BRASSICA**.
- COLIAS**, in ichthyology. See **SCOMBER**.
- COLIC**, in medicine, a severe pain in the lower venter, so called, because the disorder was formerly supposed to be seated in the colon. See **MEDICINE**.
- COLIC-SHELL**. See **SYPROEA**.
- COLIR**, an officer in China, who may properly be called an inspector, having an eye over what passes in every court or tribunal of the empire.
- In order to render him impartial, he is kept independent, by having post for life. The power of the colirs is such, that they make even the princes of the blood tremble.
- COLISEUM**, in ancient architecture, an oval amphitheatre at Rome, built by Vespasian, wherein were statues set up, representing all the provinces of the empire: in the middle whereof stood that of Rome, holding a golden apple in her hand.
- This structure was so large, that it would hold near 100,000 spectators.
- COLITES**, in natural history, a name given by some writers to a kind of pebble, found in the shape of the human penis and testes, and that either separately, or both together.
- COLLAR**, in Roman antiquity, a sort of chain put generally round the neck of slaves that had run away, after they were taken, with an inscription round it, intimating their being deserters, and requiring their being restored to their proper owners, &c.
- COLLAR**, in a more modern sense, an ornament consisting of a chain of gold, enamelled, frequently set with cyphers or other devices, with the badge of the order hanging at the bottom, wore by the knights of several military orders over their shoulders, on the mantle, and its figure drawn round their armories.
- Thus, the collar of the order of the garter consists of S S, with roses enamelled red, within a garter enamelled blue, and the George at the bottom.
- Lord Mayor's COLLAR* is more usually called chain.
- Knights of the COLLAR*, a military order in the republic of Venice, called also the order of St Mark, or the medal.
- It is the doge and the senate that confer this order; the knights bear no particular habit, only the collar, which the doge puts around their neck, with a medal, wherein is represented the winged lion of the republic.
- COLLAR of a draught horse**, a part of harness made of leather and canvas, and stuffed with straw or wool, to be put about the horse's neck.
- COLLARAGE**, a tax or fine laid for the collars of wine-drawing horses.
- COLLATERAL**, any thing, place, country, &c. situated by the side of another.
- COLLATERAL**, in genealogy, those relations which proceed from the same stock, but not in the same line of ascendants or descendants, but being, as it were, aside of each other.
- Thus, uncles, aunts, nephews, nieces and cousins, are collaterals, or in the same collateral line: those in a higher degree, and nearer the common root, represent a kind of paternity with regard to those more remote.
- COLLATERAL succession**, in Scots law: When a defunct, for want of heirs descended of himself, is succeeded in his estate by a brother or sister, or their descendants, the estate is said to have gone to *collateral heirs*. See **SCOTS LAW**, title, *Succession in heretable rights*.
- COLLATION**, in the canon law, the giving or bestowing of a benefice on a clergyman by a bishop, who has it in his own gift or patronage.
- COLLATION**, in common law, the comparison or presentation of a copy to its original, to see whether or not it be conformable; or the report or act of the officer

ficer who made the comparison. A collated act is equivalent to its original, provided all the parties concerned were present at the collation.

**COLLATION**, in Scots law, that right which an heir has of throwing the whole heritable and moveable estates of the deceased into one mass, and sharing it equally with the others in the same degree of kindred, when he thinks such share will be more than the value of the heritage to which he had an exclusive title. See **SCOTS LAW**, title, *Succession in moveables*.

**COLLATION** is also vulgarly used for a repast between dinner and supper.

**COLLEAGUE**, a partner or associate in the same office or magistrature. See **ADJUNCT**.

**COLLECTS**, in an ecclesiastical sense, the short prayers into which the public devotions of the church are divided.

In the primitive church, the collects were repeated by the bishop alone, after the joint prayers of the deacon and congregation.

**COLLECTIVE**, among grammarians, a term applied to a noun expressing a multitude, though itself be only singular; as an army, company, troop, &c. called collective nouns.

**COLLECTOR**, in general, denotes a person who gets or brings together things formerly dispersed and separated. Hence,

**COLLECTOR**, in matters of civil polity, is a person appointed by the commissioners of any duty, the inhabitants of a parish, &c. to raise or gather any kind of tax.

**COLLECTOR**, among botanists, one who gets together as many plants as he can, without studying botany in a scientific manner.

**COLLEGATORY**, in the civil law, a person who has a legacy left him in common with one or more other persons.

**COLLEGE**, an assemblage of several bodies or societies, or of several persons into one society.

College, among the Romans, served indifferently for those employed in the offices of religion, of government, the liberal, and even mechanical arts and trades; so that, with them, the word signified what we call a corporation or company.

Each of these colleges had distinct meeting-places or halls; and likewise, in imitation of the state, a treasury and common chest, a register, and one to represent them upon public occasions, and acts of government. These colleges had the privilege of manumitting slaves, of being legates, and making by-laws for their own body, provided they did not clash with those of the government.

There are various colleges on foot among the moderns, founded on the model of those of the ancients. Such are the three colleges of the empire, *viz.*

**COLLEGE of electors, or their deputies**, assembled in the diet of Ratisbon.

**COLLEGE of princes**, the body of princes, or their deputies, at the diet of Ratisbon.

**COLLEGE of cities**, is, in like manner, the body of deputies which the imperial cities send to the diet.

**COLLEGE of cardinals**, or the *sacred COLLEGE*, a body composed of the three orders of cardinals. See **CARDINALS**.

**COLLEGE** is also used for a public place endowed with certain revenues, where the several parts of learning are taught.

An assemblage of several of these colleges constitute an university. The erection of colleges is part of the royal prerogative, and not to be done without the king's license. See **UNIVERSITY**.

**COLLEGE of civilians**, commonly called *Doctors-commons*, founded by Dr Harvey, dean of the arches, for the professors of the civil law residing in the city of London. The judges of the arches, admiralty, and prerogative court, with several other eminent civilians, commonly reside here.

To this college belong thirty-four proctors, who make themselves parties for their clients, manage their causes, give licenses for marriages, &c.

In the common hall of *Doctors-commons* are held several courts, under the jurisdiction of the civil law, particularly the high court of admiralty, the court of delegates, the arches court of Canterbury, and the prerogative court of Canterbury, whose terms for sitting are much like those at Westminster, every one of them holding several court-days; most of them fixed and known by preceding holidays, and the rest appointed at the judge's pleasure.

**COLLEGE of physicians**, a corporation of physicians in London, whose number, by charter, is not to exceed eighty. The chief of them are called fellows, and the next candidates, who fill up the places of fellows as they become vacant by death, or otherwise. Next to these are the honorary fellows; and lastly, the licentiates, that is, such as being found capable, upon examination, are allowed to practise physic.

This college has several great privileges granted by charter and acts of parliament. No man can practise physic in or within seven miles of London, without license of the college, under the penalty of 5*l.* Also, persons practising physic in other parts of England are to have letters testimonial from the president and three elects, unless they be graduate physicians of Oxford or Cambridge. Every member of the college is authorized to practise surgery in London or elsewhere; and that they may be able at all times to attend their patients, they are freed from all parish-offices.

The college is governed by a president, four censors, and twelve electors. The censors have, by charter, power to survey, govern, and arrest all physicians, or others, practising physic in or within seven miles of London; to fine, amerce, and imprison them at discretion; to search apothecaries shops, &c. in and about London; to see if their drugs, &c. be wholesome, and the compositions according to the form prescribed by the college in their dispensaries; and to burn, or otherwise destroy, those that are defective or decayed, and not fit for use.

In 1656, forty-two members of the college made a subscription, to set on foot a dispensary for the relief of the sick poor, who are advised gratis every day but Sunday.

Sunday, and medicines sold at the intrinsic value: since this they have erected two other dispensaries.

**COLLEGE of justice**, in Scots law, the supreme civil court of Scotland; otherwise called *Court of session*, or, *of council and session*. See **SCOTS LAW**, title, *Supreme judges and courts of Scotland*.

**Sion COLLEGE**, or the college of the London clergy, was formerly a religious house, next to a spittal or hospital; and now it is a composition of both, viz. a college for the clergy of London, who were incorporated in 1631, at the request of Dr White, under the name of the president and fellows of Sion-college; and an hospital of ten poor men, the first within the gates of the house, and the latter without.

This college consists of a president, two deans, and four assistants, who are annually chosen from among the rectors and vicars in London, subject to the visitation of the bishop. They have one of the finest libraries in England, built and stocked by Mr Simpson, chiefly for the clergy of the city, without excluding other students on certain terms; they have also a hall with chambers for the students, generally filled with the ministers of the neighbouring parishes.

**Gresham-COLLEGE**, or **COLLEGE of philosophy**, a college founded by Sir Thomas Gresham, who built the Royal-exchange; a moiety of the revenue whereof he gave in trust to the mayor and commonalty of London, and their successors for ever, and the other moiety to the company of mercers; the first to find four able persons to read in the college divinity, astronomy, music, and geometry; and the last, three or more able men to read rhetoric, civil law, and physic; a lecture upon each subject is to be read in term-time, every day, except Sundays, in Latin, in the forenoon, and the same in English in the afternoon; only the music-lecture is to be read alone in English. The lecturers have each 50 *l. per annum*, and a lodging in the college.

In this college formerly met the royal society, that noble academy, celebrated throughout the world for their improvements in natural knowledge. See **SOCIETY**.

**COLLEGE of heralds**, commonly called the *heralds office*, a corporation founded by charter of king Richard III. who granted them several privileges, as to be free from subsidies, tolls, offices, &c. They had a second charter from king Henry VI.; and a house built near Doctors-commons, by the earl of Derby, in the reign of king Henry VII. was given them by the duke of Norfolk, in the reign of queen Mary, which house is now rebuilt.

This college is subordinate to the earl-marshal of England. They are assistants to him in his court of chivalry, usually held in the common hall of the college, where they sit in their rich coats of his majesty's arms. See **HERALD**.

**COLLEGIATE churches**, those which though no bishop's see, yet have the retinue of the bishop, the canons and prebends. Such are, among us, Westminster, Windfor, Rippon, Wolverhampton, Southwell, Manchester, &c. governed by deans and chapters.

**COLLET**, among jewelers, denotes the horizontal face or plane at the bottom of brilliants. See **BRILLIANT**.

**COLLET**, in glass-making, is that part of glass vessels which sticks to the iron instrument wherewith the metal was taken out of the melting-pot: these are afterwards used for making green glass.

**COLLETICS**, in pharmacy, denote much the same with agglutinants or vulneraries. See **VULNERARY**.

**COLLINSONIA**, in botany, a genus of the decandria monogynia class. The corolla is unequal, the inferior lip being multifid and capillary. It has but one seed. There is only one species, a native of Canada.

**COLLIQUAMENTUM**, in natural history, an extreme transparent fluid in an egg, observable after two or three days incubation, containing the first rudiments of the chick. It is included in one of its own proper membranes, distinct from the albumen. Harvey calls it the oculus.

**COLLIQUATION**, in chemistry, is applied to animal, vegetable, and mineral substances, tending towards fusion. See **FUSION**.

**COLLIQUATION**, in physic, a term applied to the blood, when it loses its crasis or balsamic texture; and to the solid parts, when they waste away, by means of the animal fluids flowing off through the several glands, and particularly those of the skin, faster than they ought: which occasions fluxes of many kinds, but mostly profuse, greasy, and clammy sweats.

**COLLIQUATIVE fever**, in physic, a fever attended with a diarrhoea, or profuse sweats.

**COLLISION**, the striking of one hard body against another; or the friction or percussion of bodies moving violently with different directions, and dashing against each other. See **MECHANICS**.

**COLLURIO**, in ornithology. See **LANIUS**.

**COLLUSION**, in law, a secret understanding between two parties, who plead or proceed fraudulently against each, to the prejudice of a third person.

**COLLUM**, the same with neck. See **NECK**, and **CERVIX**.

**COLLYRIUM**, in pharmacy, a topical remedy for a disorder of the eyes; designed to cool and repel hot, sharp humours.

They are generally of two kinds, the one liquid, and the other dry: liquid collyrials are composed of ophthalmic powders in waters, as rose water, plantain-water, or that of fennel, eye-bright, &c. wherein tully, white vitriol, or some other proper powder, is dissolved.

The dry collyrium is troches of rhasis, sugar-candy, tully prepared, &c. blown into the eye.

**COLOCASIA**, in botany. See **ARUM**.

**COLOCYNTHIS**, in botany. See **CUCUMIS**.

**COLOGNE**, the capital of the circle of the Lower Rhine, in Germany, situated on the Rhine, about forty-five miles east of Mæstricht; E. long. 6° 40', N. lat. 50° 50'. It is one of the largest and most elegant cities of Germany, being the see of an archbishop, who is one of the electors of the empire, and has a yearly revenue of 120,000 *l.*

**COLOGNE-**



**COLOGNE-earth**, a kind of very light bastard ochre, of a deep brown colour.

**COLON**, in anatomy. See Vol. I. p. 261.

**COLON**, in grammar, a point or character marked thus, (:), shewing the preceding sentence to be perfect or entire; only that some remark, farther illustration, or other matter connected therewith, is subjoined.

**COLONEL**, in military matters, the commander in chief of a regiment, whether horse, foot, or dragoons.

A colonel may lay any officer of his regiment in arrest, but must acquaint the general with it; he is not allowed a guard, only a centry from the quarter-guard.

**COLONEL-lieutenant**, he who commands a regiment of guards, whereof the king, prince, or other person of the first eminence, is colonel. These colonel-lieutenants have always a colonel's commission, and are usually general officers.

**Lieutenant-COLONEL**, the second officer in a regiment, who is at the head of the captains, and commands in the absence of the colonel.

**COLONNA**, a town of Italy, in the Campagna of Rome, eighteen miles eastward of that city: E. long. 13° 15', N. lat. 42°.

**COLONNADE**, in architecture, a peristyle of a circular figure; or a series of columns disposed in a circle, and insulated within side.

**A polystile COLONNADE**, is that whose numbers of columns is too great to be taken in by the eye at a single view. Such is the colonnade of the palace of St Peter's at Rome, consisting of 284 columns of the Doric order, each above four foot and an half diameter, all in Tiburtine marble.

**COLONY**, a company of people transplanted into a remote province, in order to cultivate and inhabit it.

Colonies are of three sorts: the first are those that serve to ease and discharge the inhabitants of a country, where the people are become too numerous; the second are those established by victorious princes in the middle of vanquished nations, to keep them in awe and obedience; and the third sort are those established for the promotion of trade, called colonies of commerce; such are those established by European nations in several parts of Asia, Africa, and America.

**COLOPHONY**, in pharmacy, black resin, or turpentine, boiled in water, and afterwards dried; or, which is still better, the caput mortuum remaining after the distillation of the ethereal oil, being further urged by a more intense and long continued fire.

**COLOQUINTIDA**, in botany. See CUCUMIS.

**COLORATURA**, in music, denotes all manner of variations, trillos, diminutions, &c. serving to make song agreeable.

**COLOSSUS**, a statue of a gigantic, or enormous size.

The most famous of this kind was the colossus of Rhodes, made, in honour of Apollo, by Chares the disciple of Lysippus. It was eighty-six feet high, and its thumb so large, that few people could fathom it. This statue was placed across the mouth of the harbour at Rhodes, and the ships with full sails passed betwixt its legs.

**COLOSTRUM**, the first milk of any animal after bringing forth young, called beestings. It is remarkable that this milk is generally cathartic, and purges off the meconium; thus serving both as an aliment and medicine.

An emulsion prepared with turpentine, dissolved with the yolk of an egg, is sometimes called by this name.

**COLOUR**. See OPTICS.

**COLOUR**, in painting, is applied both to the drugs, and to the tints produced by those drugs variously mixed and applied.

The principal colours used by painters are red and white lead, or cerufs; yellow and red ochres: several kinds of earth, umbre, orpiment, lamp-black, burnt ivory, black lead, cinnabar or vermilion, gumboge, lacca, blue and green ashes, verdigris, bistre, bicce, smalt, carmine, ultra marine: each of which, with their uses, &c. are to be found under their proper articles.

Of these colours some are used tempered with gum-water, some ground with oil, others only in fresco, and others for miniature.

Painters reduce all the colours they use under these two classes, of dark and light colours: dark colours are black, and all others that are obscure and earthy, as umbre, bistre, &c.

Under light colours are comprehended white, and all that approach nearest to it.

Painters also distinguish colours into simple and mineral.

Under simple colours they rank all those which are extracted from vegetables, and which will not bear the fire; as the yellow, made of saffron, French berries, lacca, and other tinctures extracted from flowers, used by limners, illuminers, &c.

The mineral colours are those which being drawn from metals, &c. are able to bear the fire, and therefore used by enamellers. Changeable and permanent colours is another division, which, by some, is made of colours.

Changeable colours are such as depend on the situation of the objects with respect to the eye, as that of a pigeon's neck, taffeties, &c. the first however being attentively viewed by the microscope, each fibre of the feathers appears composed of several little squares, alternately red and green, so that they are fixed colours.

**Local COLOURS**. See LOCAL.

**Water COLOURS**. See WATER.

**COLOUR**, in dying. There are, in the art of dying, five colours, called simple, primary, or mother colours, from the mixture of which all other colours are formed; these are blue, yellow, brown, red, and black. Of these colours, variously mixed and combined, they form the following colours, pansy, blue, and red; from the mixture of blue and scarlet are formed amaranth, violet, and pansy; from the same mixture of blue, crimson, and red, are formed the columbine, or dove-colour, purple-crimson, amaranth, pansy, and crimson-violet. See BOTANY, Vol. I. p. 633.

Here it is to be observed, that they give the name crimson to all colours made with cochineal.

**COLOUR**, in heraldry. The colours generally used in heraldry are red, blue, black, green, and purple, which the heralds call gules, azure, sable, vert or sinople, and purpure; tenne or tawny, and sanguine, are not so common: as to yellow and white, called *or* and *argent*, they are metals, not colours.

The metals and colours are sometimes expressed in blazon by the names of precious stones, and sometimes by those of planets or stars. See **BLAZONING**.

Oenomaus is said to have first invented the distinction of colours, to distinguish the gundillæ of combatants of the Circeanian games; the green for those who represented the earth, and blue for those who represented the sea.

**COLOURS**, in the military art, include the banners, flags, ensigns, &c. of all kinds, borne in the army or fleet. See **FLAG**, and **STANDARD**.

**Field-COLOUR**. See **FIELD**.

**COLOURS**, in the Latin and Greek churches, are used to distinguish several mysteries and feasts, celebrated therein.

Five colours only are regularly admitted into the Latin church; these are white, green, red, violet, and black: the white is for the mysteries of our Saviour, the feasts of the virgin, those of the angels, saints, and confessors; the red is for the mysteries and solemnities of the holy sacrament, the feasts of the apostles and martyrs; the green for the time between pentecost and advent, and from epiphany to septuagesima; the violet in advent and Christmas, in vigils, rogations, &c. and in votive masses in time of war; lastly, the black is for the dead, and the ceremonies thereto belonging.

In the Greek church, the use of colours is almost abolished, as well as among us: red was, in the Greek church, the colour for Christmas, and the dead, as black among us.

**To COLOUR strangers goods**, is when a freeman allows a foreigner to enter goods at the custom-house in his name.

**COLOURING**, among painters, the manner of applying and conducting the colours of a picture; or the mixtures of light and shadows, formed by the various colours employed in painting. See **PAINTING**.

**COLOURING of glass**. See **GLASS**.

**COLOURING of porcelain**. See **PORCELAIN**.

**COLT**, in zoology. See **EQUUS**.

**COLT-EVIL**, among farriers, a swelling of the yard and scrotum, incident both to stoned horses and geldings; for which, after washing the part with lukewarm vinegar, it is usual to anoint them with juice of rue, mixed with honey, and boiled in hog's grease, adding bay-leaves and the powder of fenugreek.

**COLT'S-FOOT**, in botany. See **TUSSILAGO**.

**COLTIE**, a term used by timber-merchants for a defect, or blemish, in some of the annular circles of a tree, whereby its value is much diminished.

**COLUBER**, in zoology, a genus of serpents belonging to the class of amphibia. The characters are these:

They have a number of scuta, or hard crusts, on the belly; and scutellæ, or scales, on the tail. Linnæus enumerates no less than 97 species under this genus, distinguished solely by the number of scuta and scutellæ. For the sake of brevity, we shall give the numbers in figures, the first denoting the number of scuta, and the second the number of scutellæ, thus, 140-22.

The first species is the viper, 118-22. This is the viper of the shops, the flesh of which has been much recommended in scrophulous, leprous, and other obstinate chronic disorders; but its virtues in these cases have been too much exaggerated: the flesh of the viper is however highly nutritive, and is therefore properly esteemed to be a good restorative: but, to answer any good purpose, even when given with this intention, it ought to be used liberally, and for a considerable time, as food. This animal is a native of Egypt. The body is very short, and of a pale colour, with brownish spots; and the head is gibbous, and covered with small scales. 2. The atropos, 131-22, is a native of America; the body is white, and the eyes are brown, with a white iris. 3. The lebevis, 110-50, is a native of Canada, and has many linear black rings. 4. The ammodites, 142-32, is about six inches long, and has an erect fleshy protuberance on its nose. It is a native of the East. 5. The berus, 146-39, or common British viper, is found in most countries in Europe: It is of a dusky blackish colour. 6. The chersæa, 150-34, is a native of Sweden, and rather less than the asp. 7. The prester, 152-32, is found in the northern parts of Europe, and the whole body is black. 8. The aspis, 146-46, is a native of France, and is of a reddish colour, with dusky spots on the back. 9. Lebetinus, 155-46, is a native of Asia, and is of a cloudy colour, with red spots on the belly. 10. The severus, 170-42, is likewise a native of Asia, and is ash-coloured, with white belts. 11. The stolatus, 143-76, is a native of Asia, and is of a greyish colour, with two white fillets. 12. The lacteus, 203-32, is a native of the Indies; the colour is white, with black spots. 13. The naja, 193-60, is a native of the East Indies; and is the most poisonous of all serpents; they are eat by the ichneumon. 14. The atrox, 196-69, is a native of Asia; it is of a hoary colour; and the head is compressed and covered with small scales. 15. The niveus, 209-62, is white, without any spots. It is a native of Africa. 16. The corallinus, 193-82, is a native of Asia: It is greyish, with three brown fillets. 17. The dipsas, 152-135, is a native of America: it is of a bluish colour, with the margins of the scales white. 18. The mysterizans, 192-167, is a native of America; the snout is stretched out, and triangular. Although this genus comprehends 97 species, the above 18 are all whose bite is supposed to be poisonous. The poison is contained in a little bag at the base of their long fangs. See **NATURAL HISTORY**.

The 19th species is the lutrix, 134-27; the back and belly are yellow; and the sides are bluish. It is a native of the Indies. 20. The calamarius, 140-22, is of a livid colour interspersed with dusky spots and

and lines, and is found in America. 21. The *simus*, 124-46, is a native of Carolina; the head is roundish, flat, and gibbous; the body is interspersed above with black and white; and the belly is black. 22. The *striatulus*, 126-45, is likewise a native of Carolina: the back is dusky and striated; and the belly is pale. 23. The *cerastes*, 150-29, is a native of Asia; the scales of the head are round and small: this is the horned viper of Hafs-elquift; but the horns are a mere imposition; the Arabians fix the spurs of a cock or other bird upon the head of the viper, in order to raise the admiration of travellers. 24. The *plicatilis*, 131-46, is of a livid colour, with dusky sides. 25. The *domicella*, 118-60, is a native of Asia; it is white, with black belts. 26. The *alidras*, 121-58, is a native of India, and is all white. 27. The *punctatus*, 136-43, is a native of Carolina: It is ash-coloured, variegated with yellow spots. 28. The *buccatus*, 107-72, is dusky-coloured, with white belts, and is a native of Asia. 29. The *angulatus*, 117-70, is a native of Asia, and of a greyish colour, with black fillets. 30. The *caruleus*, 165-24, is blueish, with white scales on one side: It is a native of America. 31. The *albus*, 170-20, is entirely white, and is a native of Asia. 32. The *typhlus*, 140-53, is a native of the Indies, and of a blueish colour. 33. The *fasciatus*, 128-67, is a native of Carolina; the scales are carinated, and the colour is blackish. 34. The *melanocephalus*, 140-62, is a native of America; the body is very smooth; the colour is dusky, and the head is black. 35. The *collata*, 150-54, is very frequent in America: it is ash-coloured, interspersed with white lines. 36. The *reginæ*, 137-70, is a native of the Indies; the body is dusky, and the belly is black and white. 37. The *dollatus*, 164-43, is a native of Carolina; this is a small serpent; of a whitish colour, with black rings. 38. The *ordinatus*, 138-72, is likewise found in Carolina: It is blueish, and clouded with black spots. 39. The *Mexicanus*, 134-77, is a native of America. 40. The *aurora*, 179-37, is a native of America: it is livid, with a yellow back. 41. The *sipedon*, 144-73, is yellowish, and a native of North America. 42. The *maurus*, 152-66, is a native of Algiers: the body is yellowish above, and the belly is red. 43. The *vitatus*, 142-78, is a native of America; the edges of the scales are yellowish, and there is a white dentated fillet under the anus. 44. The *miliaris*, 162-59, is a native of the Indies: the body is yellow, with a white spot in each scale; and the belly is white. 45. The *æsculapii*, 180-43, is a native of the Indies: it has white and black belts. 46. The *rhombeatus*, 157-70, is a native of the Indies: the colour is blueish, with black spots. 47. The *cyaneus*, 119-110, is a native of America: it is of an azure colour, and the belly is green. 48. The *natrix*, 170-60, is a native of Europe: it is black, with a white spot on each side of the neck. 49. The *agilis*, 183-50, is a native of the Indies: it has yellow and white belts. 50. The *jaculatrix*, 163-77, is a native of Surinam. 51. The *alicus*, 184-60, is a native of America, and is of a greyish colour, with white belts. 52. The *monilis*,

164-82, is a native of America; the body is annulated, with three white spots on the collar. 53. The *fulvius*, 218-31, is a native of Carolina: it has 22 black rings, and as many yellow, placed alternately. 54. The *pallidus*, 156-96, is a native of the Indies, and is of a pale colour, with grey and yellow spots. 55. The *lineatus*, 169-84, is a native of Asia: it is blueish, with four linear fillets. 56. The *padera*, 198-56, is a native of the Indies: it is white, with yellowish spots. 57. The *canus*, 188-70, is a native of the Indies: it is of a hoary colour, with yellowish belts. 58. The *getulus*, 215-44, is a native of Carolina: it is of a blackish blue colour, with yellow linear belts. 59. The *sibilans*, 160-100, is a native of Asia; and is blue, with black fillets, and a white belly. 60. The *laticaudatus*, 220-42, is a native of the Indies: it is ash-coloured, with yellow belts; and the tail is obtuse and compressed. 61. The *stralis*, 150-114, is a native of Canada: the body is of a dirty yellow colour, with three blueish green fillets. 62. The *sibon*, 180-85, is a native of Africa: it is of a yellowish iron-colour, interspersed with white; and the belly is white, with yellow spots. 63. The *nebulatus*, 185-81, is a native of America: it is clouded with yellow and an ash colour, and the belly is variegated with yellow and white. 64. The *fuscus*, 149-117, is a native of Asia; it is yellow and ash-coloured, and there are yellow spots behind the eyes. 65. The *saturninus*, 147-120, is a native of the Indies: it is livid and coloured with an ash-colour, and the eyes are very large. 66. The *candidus*, 220-50, is a native of the Indies: it is white, with yellow belts. 67. The *scaber*, 228-44, is a native of the Indies: it is clouded with black and yellow, and the scales are carinated. 68. The *carinatus*, 157-115, is a native of the Indies: it is of a lead colour, and the edges of the scales are tipped with white; the belly is white, and the back is carinated. 69. The *ovivorus*, 203-73, is a native of America. 70. The *saurita*, 156-121, is a native of Carolina: it is of a greenish colour. 71. The *constrictor*, 186-92, is a native of North America: it is black and smooth; the belly is of a palish green; and the nape of the neck is white. This species is so bold, that it even attacks men, twisting about their legs, and breaking their bones: it runs very quickly; but its bite is not poisonous. 72. The *exoletus*, 147-132, is a native of the Indies. It is blueish and ash-coloured. 73. The *fitula*, 236-45, is a native of Egypt: It is greyish. 74. The *trifascialis*, 195-86, is a native of the Indies: It is of an azure colour. 75. The *guttatus*, 227-60, is a native of Carolina: It is of a livid colour, with red and black spots on the back. 76. The *lemniscatus*, 250-35, is a native of Asia: The body is very smooth, and variegated with white and black rings. 77. The *annulatus*, 190-96, is a native of America: It is white, with round yellow spots. 78. The *pelias*, 187-103, is a native of the Indies: It is yellow behind the eyes, and the rest is blackish. 79. The *tyria*, 210-83, is a native of Egypt: It is whitish, with yellow spots. 80. The *jugularis*, 195-102, is a native

tive

of Egypt: It is black, with a red neck. 81. The pathia, 209-50, is a native of Africa: It is of a leaden colour. 82. The xilivus, 155-144, is a native of Carolina: It is blue, and very smooth; and the belly is of a pish green. 83. The molurus, 248-59, is a native of the Indies: This species is very like the boa; but the scuta and scales are larger. 84. The ahaculla, 165-150, is a native of Asia and America: It is of a yellowish green colour, and the tops of the scales are black; it has likewise a black belt across the eyes. 85. The petalarius, 212-102, is a native of the Indies: It is yellow, with white belts. 86. The hajc, 207-109, is a native of Egypt: This is a large serpent, with oblique red belts, and about one half of each scale white. 87. The filiformis, 165-158, is a native of the Indies: It is black, with a white belly; and the head is thicker than the body. 88. The pullatus, 217-108, is a native of Asia: It has red belts, with white spots. 89. The hippocrepis, 282-94, is a native of America: It is of a livid colour, with yellow spots. 90. The minervæ, 238-90, is a native of the Indies: It is of an azure colour, with a yellow fillet on the back. 91. The cinereus, 200-137, is a native of the Indies: It is of an ash-colour, with a white belly. 92. The viridissimus, 217-122, is a native of Surinam: It is of a fine green colour. 93. The mucosus, 200-140, is a native of the Indies: the head is blueish. 94. The domesticus, 245-94, frequents the dwellings of Barbary: It greatly resembles the hippocrepis. 95. The cenchoa, 220-124, is a native of America: It is yellowish, with pale spots and white belts: The head is globular. 96. The cærulescens, 215-170, is a native of the Indies, and is of an azure colour. 97. The argus, is a native of Africa; but hitherto we have had no just description of it.—For the instincts, manner of living, &c. of serpents in general, see NATURAL HISTORY.

**COLUBRINUM LIGNUM, OF SNAKE-WOOD.** See STRYCHNOS.

**COLUMBA, PIGEON,** in ornithology, a genus belonging to the order of passeræ. The characters of this genus are these: The bill is straight, and descends towards the point; the nostrils are oblong, and half covered with a soft tumid membrane; and the tongue is entire, *i. e.* not cloven. There are 40 species, *viz.* 1. The œnas, or domestic pigeon, is blueish, with a greenish shining neck; on the back, towards the tail, it is white, with a blackish streak on the point of the wings and tail. It is the stock-dove or wood-pigeon of Ray, and is a bird of Europe. The pigeon lays two eggs, and hatches them every month, for eight or nine months in the year, which, in the space of four years, amounts to about 18000 descendants. They always bill before copulation: Their method of feeding their young is curious; they first macerate pease or other grain for some time in their crop, and then vomit it up into the mouths of the young ones. The male and female sit upon their eggs by turns. 2. The hispanica, with white mealy wax on the bill. It is about double the size of the common pigeon. 3. The

dasyfus, with rough feathered legs. 4. The gutturosa, or cropper, has a power of inflating its crop till it be as large as the animal's body. It is a native of Arabia Felix. 5. The cucullata has the feathers on the back-part of the head erect and reflected; and the bill is short. 6. The hispida, or rough pigeon, with the small feathers of the back and wings erected. It is a native of the East Indies. 7. The turbita, with the feathers on the breast bent backward, a short bill, and a plain vertex. 8. The laticauda, or broad-tailed pigeon, has an erect open tail consisting of many feathers. 9. The gyratrix turns itself round when flying: it is a little less than the common pigeon. 10. The galeata, with the head and prime feathers of the wings and tail of the same colour, and always different from the rest of the body. 11. The turcica, with red papillous wax. It is a bird of Arabia. 12. The tabellaria has naked eye-brows, and broad, white, fleshy wax on the bill. Although this bird be carried to a very great distance from home, it returns with vast speed; and hence the ancients employed it for the purpose of conveying back letters. 13. The montana has naked red orbits, a reddish body, and a yellow belly; the bill and feet are red. It is the mountain-partridge of Ray, and is a native of Jamaica. 14. The leucocephala, with the top of the head and the orbits red, and a blueish body. It is a native of North America. 15. The leucoptera, with naked blue orbits, and the prime wing-feathers white at the points, and the intermediate ones yellowish. It is the Indian turtle of Edwards, and is a native of Asia. 16. The guinea, with naked red orbits, a yellowish bill, triangular white spots on the wings, and the prime wing-feathers black at the points. It is a native of Africa. 17. The coronata has black orbits, a large erect crest on the head, and a blueish body. It is almost as large as a peacock, and is a native of Banda. 18. The striata, with hoary orbits, and the body variegated with black and ash-coloured belts. It is a native of the East Indies. 19. The palumbus, with the prime tail-feathers red behind, the prime wing-feathers edged with white, a white neck, and feathered legs. It is a native of Europe and Asia. 20. The cyanocephala, with a blue head, and a white belt below the eye. It is a native of America. 21. The madagascarensis, with feathered legs, a violet tail, a greenish blue body, and the beak and feet red. It is found in Madagascar. 22. The aenea, with feathered legs, greenish legs and bill, and a brass-coloured body. It is a native of the Molucca Isles. 23. The viridis, with a brass-coloured body, a violet belly, and red legs half covered with feathers. It is found at Amboina. 24. The martinica, with a violet body, a yellowish belly, and the prime wing-feathers red on the inside. It is found in Martinico. 25. The jamaicensis, with blueish prime tail-feathers terminated by a white line. It is found in Jamaica. 26. The Senegalensis, with the three outmost prime tail-feathers white, and the neck spotted with black. It is found in Senegal. 27. The nicobarica has a white tail, a black body, blue prime wing-feathers, a greenish

ish shining back, and long feathers on the neck. It is found in the island of Nicobar near Pegu. 28. The sinica is yellowish, and belted with black; the belly is reddish, the wings yellow, the prime wing-feathers black, and a black bill. It is a native of China. 29. The indica, with a purple body, green shoulders, and the top of the head bluish. It is a native of the East Indies. 30. The canadensis, with the prime wing-feathers yellow at the points, and the prime tail-feathers ash-coloured. It is a native of Canada. 31. The asra, with the exterior prime tail-feathers white at the points, and violet spots on the wing-feathers. It is a native of Senegal. 32. The turtur, with the prime tail-feathers white, a greyish back, and a flesh-coloured breast. It is a native of India. 33. The risoria is clay-coloured above, and has a black crescent on the neck. It is a native of India. 34. The postirina, with a purple body, and a yellow bill and legs. It inhabits America within the tropics. 35. The minuta is the smallest of all pigeons, is of a dusky colour, with five steel-coloured spots on the wings, and the outmost prime tail-feathers white. It is a native of America. 36. The migratoria has a wedge-shaped tail, red naked orbits, and a reddish breast. This species is very frequent in North America: They live upon the seeds of the elm, oak, wheat, &c. and they winter in Carolina. 37. The carolinensis has a wedge-shaped tail, blue orbits, and a reddish belly. It is a native of America. 38. The amboinensis has a wedge-shaped tail, a reddish body, and a greenish neck. It is found at Amboina. 39. The capensis has a wedge-shaped tail, and the prime wing-feathers red on the interior side. It is found at the Cape of Good Hope. 40. The marginata has a wedge-shaped tail, a red breast, and the points of the prime tail-feathers black and edged with white.

**COLUMBINE**, in botany. See **AQUILEGIA**.  
*Feathered COLUMBINE*. See **THALICTRUM**.

**COLUMBUS**, or *Congregation of St COLUMBUS*, a Society of regular canons, who formerly had an hundred abbeys or monasteries in the British islands.

**COLUMELLA**, in botany. See Vol. I. p. 637.

**COLUMN**, in architecture, a round pillar, made to support and adorn a building, and composed of a base, a shaft, and a capital. See **ARCHITECTURE**.

**COLUMN**, in the military art, a long deep file of troops or baggage.  
 The first and second lines of the army as they are encamped, make generally two columns on a march, filing off either from the right or left: sometimes the army marches in four, six, or eight columns, according as the ground will allow; and each column is led by a general officer.

**COLUMNÆA**, in botany, a genus of the didynamia angiospermia class. The calix is divided into five segments; the upper labium of the corolla is vaulted and entire, and gibbous at the base; the antheræ are connected; and the capsule is bilocular. There is but one species; viz. the scandens, a native of Martinico.

**COLURES**, in astronomy and geography, two great

VOL. II. No. 39, 3

circles supposed to intersect each other at right angles in the poles of the world, and to pass through the solstitial and equinoctial points of the ecliptic. See **GEOGRAPHY**, and **ASTRONOMY**.

**COLURI**, a little island in the gulph of Engia, in the Archipelago, about seven miles south of Athens: of this island Ajax was sovereign: E. long 24°, N. lat. 38°.

**COLUTEA**, **BASTARD-SENA**, in botany, a genus of the diadelphia decandria class. The pod is inflated, and opens at the top; and the calix is bilabiated. The species are three, none of them natives of Britain.

**COLYMBUS**, the **DIVER**, in ornithology, a genus belonging to the order of anseres. The bill has no teeth, is subulated, straight, and sharp-pointed; the teeth are in the fauce or throat; the nostrils are linear, and at the base of the bill; and the legs are unfit for walking. There are eleven species, viz. 1. The grylle, with palmated and three-toed feet, a red body, and the covering feathers of the wings white. It flies very low, and is a native of Greenland. 2. The troile, with palmated three-toed feet, a black body, a white breast and belly, and the secondary prime feathers of the wings white at the points. It is found within the arctic circle. 3. The septentrionalis, with palmated four-toed feet, and an iron-coloured spot under the neck. It is a native of the northern lakes of Europe. They build their nests upon the shore without art, and lay a couple eggs: they run with great quickness upon the water; and presage storms by flying and crying with a miserable tone of voice. 4. The arcticus, with palmated four-toed feet, a hoary head, and a violet neck. It frequents the northern seas and lakes. 5. The glacialis, with palmated four-toed feet, and a violet head and neck. It inhabits the northern seas. 6. The immer, with palmated four-toed feet, the upper part of the body black and undulated with white, and a white belly. It inhabits the frozen seas. 7. The crystallus, with lobated feet, a red head, a black collar, and white secondary prime wing-feathers. It is a native of Europe. 8. The auritus, with lobated feet, a black head, and the ears are crested and of an iron colour. It frequents the lakes of Europe and America. 9. The urinator, with lobated feet, a smooth head, and white spots on the wings. It is a native of the southern parts of Europe. 10. The dominicus, with lobated feet, a smooth head, and the belly very much spotted. 11. The padiceps, with lobated feet and a yellowish body. It is a native of North America.

**COLYTEA**, in botany. See **CERCIS**.

**COMA**, or **COMA-VIGIL**, a preternatural propensity to sleep, when nevertheless the patient does not sleep, or, if he does, awakes immediately without any relief. See **MEDICINE**.

**COMA SOMNOLENTUM**, is when the patient continues in a profound sleep, and, when awaked, immediately relapses, without being able to keep open his eyes. See **MEDICINE**.

**COMARUM**, in botany, a genus of plants of the icosan-dria polygynia class. The calix is divided into ten segments; the petals are five, and less than the calix,

† 3 M and

and the seeds are ovated, spongy, and persistent. There is but one species, *viz.* the palustre, a native of Europe.

**COMB**, an instrument to clean, untangle, and dress flax, wool, hair, &c.

Combs for wool are prohibited to be imported into Britain.

**COMB** is also the crest or red fleshy tuft growing upon a cock's head.

**Lady's COMB**, in botany. See **SCANDIX**.

**COMB-FISH**, in the history of shell-fish. See **OSTREA**.

**COMBAT**, in a general sense, denotes an engagement, or a difference decided by arms. See **BATTLE**.

**COMBAT**, in our ancient law, was a formal trial of some doubtful cause or quarrel by the swords or battons of two champions. This form of proceeding was very frequent not only in criminal but in civil causes; being built on a presumption, that God would never grant the victory but to him who had the best right. The last trial of this kind in England, was between Donald lord Ray, appellant, and David Ramsay, esq; defendant; when, after many formalities, the matter was referred to the king's pleasure.

**COMBATANT**, in heraldry, a term for two beasts, as lions, &c. borne in a coat of arms in a fighting posture, with their faces to each other.

**COMBINATION**, properly denotes an assemblage of several things two by two.

**COMBINATION**, in mathematics, is the variation or alteration of any number of quantities, letters, or the like, in all the different manners possible.

**COMEDY**. See **EPIC** and **DRAMATIC COMPOSITIONS**.

**COMET**, an opaque, spherical, and solid body like a planet, performing revolutions about the sun in elliptical orbits, which have the sun in one of the foci. See **ASTRONOMY**, p. 444.

**COMETARIUM**, a curious machine exhibiting an idea of the revolution of a comet about the sun. See Plate XLVIII. fig. 2.

**COMFREY**, in botany. See **SYMPHYTUM**.

**COMITIA**, in Roman antiquity, an assembly of the people, either in the comitium or campus martius, for the election of magistrates, or consulting on the important affairs of the republic.

There were certain days fixed for these assemblies, called *dies comitiales*, marked with a C in Julius Cæsar's calendar,

There were three kinds of comitia, *viz.* curiata, centuriata, and tributa, so distinguished from the manner wherein the people voted, and gave their suffrages, *viz.* by curiæ, or parishes, tribes, or centuries. The comitia curiata, owe their original to the division which Romulus made of the people into thirty curiæ, which answer in most respects to our parishes. The comitia centuriata were instituted by Servius Tullius. Comitial assemblies held for the election of consuls, were

called consular comitia. In like manner the other comitia were named from the officer to be created, whether a tribune, pontif, ædile, or the like. The power of calling these assemblies, belonged at first only to the kings: but on the establishment of the democracy, the same privilege was allowed to most of the chief magistrates, and sometimes to the pontiff.

**COMITIALIS MORBUS**, an appellation given to the epilepsy, by reason the comitia of ancient Rome were dissolved, if any person in the assembly happened to be taken with this distemper.

**COMITIUM**, in Roman antiquity, a large hall in the forum, where the comitia were ordinarily held.

**COMMA**, among grammarians, a point or character marked thus (,) serving to denote a short stop, and to divide the members of a period.

**COMMA**, in music, an interval equal to the difference of the tone major or minor, and expressed by the ratio 81 : 80.

**COMMELINA**, in botany, a genus of the triandria-monogynia class. The corolla is divided into six segments; it has three cross-like nectaria inserted by their proper filaments. The species are ten, none of them natives of Britain.

**COMMEMORATION**, in a general sense, the remembrance of any person or thing; or the doing any thing in honour of a person's memory, or in remembrance of any past event. Thus the eucharist is a commemoration of the sufferings of Jesus Christ.

**COMMENDAM**, in the ecclesiastical law, the trust or administration of the revenues of a benefice, given either to a layman, to hold, by way of *d. positum*, for six months, in order to repairs, &c. or to an ecclesiastic, or beneficed person, to perform the pastoral duties thereof, till once the benefice is provided with a regular incumbent.

**COMMENSURABLE**, among geometricians, an appellation given to such quantities as are measured by one and the same common measure.

**COMMENSURABLE NUMBERS**, whether integers or fractions, are such as can be measured or divided by some other number, without any remainder: such are 12 and 18, as being measured by 6 or 3.

**COMMENSURABLE IN POWER**, is said of right lines, when their squares are measured by one and the same space or superficies.

**COMMENSURABLE SURDS**, those that being reduced to their least terms, become true figurative quantities of their kind; and are therefore as a rational quantity to a rational one.

**COMMENTARY**, or **COMMENT**, in matters of literature, an illustration of the difficult or obscure passages of an author.

**COMMENTARY**, or **COMMENTARIES**, likewise denotes a kind of history, or memoirs of certain transactions, wherein the author had a considerable hand: such are the commentaries of Cæsar.

COMMERCE.

## C O M M E R C E.

**C**OMMERCE is an operation, by which the wealth, or work, either of individuals, or of societies, may be exchanged, by a set of men called merchants, for an equivalent, proper for supplying every want, without any interruption to industry, or any check upon consumption.

We shall begin by tracing commerce to its source, in order to reduce it to its first principles.

The most simple of all trade, is that which is carried on by bartering the necessary articles of subsistence. If we suppose the earth free to the first possessor, this person who cultivates it will first draw from it his food, and the surplus will be the object of barter: he will give this in exchange to any one who will supply his other wants. This naturally supposes both a surplus quantity of food produced by labour, and also free hands; for he who makes a trade of agriculture cannot supply himself with all other necessaries, as well as food; and he who makes a trade of supplying the farmers with such necessaries, in exchange for his surplus of food, cannot be employed in producing that food. The more the necessities of man increase, the more free hands are required to supply them; and the more free hands are required, the more surplus food must be produced by additional labour, to supply their demand.

This is the least complex kind of trade, and may be carried on to a greater or less extent, in different countries, according to the different degrees of the wants to be supplied. In a country where there is no money, nor any thing equivalent to it, the wants of mankind will be confined to few objects; to wit, the removing the inconveniencies of hunger, thirst, cold, heat, danger, and the like. A free man, who, by his industry, can procure all the comforts of a simple life, will enjoy his rest, and work no more: and, in general, all increase of work will cease, so soon as the demand for the purposes mentioned comes to be satisfied. There is a plain reason for this. When the free hands have procured, by their labour, what is withal to supply their wants, their ambition is satisfied: so soon as the husbandmen have produced the necessary surplus for relieving theirs, they work no more. Here then is a natural stop put to industry, consequently to bartering.

The next thing to be examined is, how bartering grows into trade, properly so called and understood, according to the definition given of it above; how trade comes to be extended among men; how manufactures, more ornamental than useful, come to be established; and how men come to submit to labour, in order to acquire what is not absolutely necessary for them.

This, in a free society, is chiefly owing to the introduction of money, and a taste for superfluities in those who possess it.

In ancient times, money was not wanting; but the

taste for superfluities not being in proportion to it, the specie was locked up. This was the case in Europe four hundred years ago. A new taste for superfluity has drawn, perhaps, more money into circulation, from our own treasures, than from the mines of the new world. The poor opinion we entertain of the riches of our forefathers, is founded upon the modern way of estimating wealth, by the quantity of coin in circulation, from which we conclude, that the greatest part of the specie now in our hands must have come from America.

It is more, therefore, through the taste of superfluity, than in consequence of the quantity of coin, that trade comes to be established; and it is only in consequence of trade that we see industry carry things in our days to so high a pitch of refinement and delicacy. Let us illustrate this, by comparing together the different operations of barter, sale, and commerce.

When reciprocal wants are supplied by barter, there is not the smallest occasion for money: this is the most simple of all combinations.

When wants are multiplied, bartering becomes more difficult; upon this money is introduced. This is the common price of all things: it is a proper equivalent in the hands of those who want, perfectly calculated to supply the occasions of those who, by industry, can relieve them. This operation of buying and selling is a little more complex than the former; but still we have here no idea of trade, because we have not introduced the merchant, by whose industry it is carried on.

Let this third person be brought into play, and the whole operation becomes clear. What before we called wants, is here represented by the consumer; what we called industry, by the manufacturer; what we called money, by the merchant. The merchant here represents the money, by substituting credit in its place; and as the money was invented to facilitate barter, so the merchant, with his credit, is a new refinement upon the use of money. This renders it still more effectual in performing the operations of buying and selling. This operation is trade: it relieves both parties of the whole trouble of transportation, and adjusting wants to wants, or wants to money; the merchant represents by turns both the consumer, the manufacturer, and the money. To the consumer he appears as the whole body of manufacturers; to the manufacturers as the whole body of consumers; and to the one and the other class his credit supplies the use of money. This is sufficient at present for an illustration. We now return to the simple operations of money in the hands of the two contracting parties, the buyer and the seller, in order to show how men come to submit to labour in order to acquire superfluities.

So soon as money is introduced into a country, it becomes an universal object of want to all the inhabitants.

The consequence is, that the free hands of the state, who

who before stopt working, because all their wants were provided for, having this new object of ambition before their eyes, endeavour, by refinements upon their labour, to remove the smaller inconveniences which result from a simplicity of manners. People, who formerly knew but one sort of clothing for all seasons, willingly part with a little money to procure for themselves different sorts of apparel properly adapted to summer and winter, which the ingenuity of manufacturers, and their desire of getting money, may have suggested to their invention.

Indeed these refinements seem more generally owing to the industry and invention of the manufacturers, (who by their ingenuity daily contrive means of softening or relieving inconveniencies, which mankind seldom perceive to be such, till the way of removing them is contrived), than to the taste of luxury in the rich, who, to indulge their ease, engage the poor to become industrious.

Let any man make an experiment of this nature upon himself, by entering into the first shop. He will no where so quickly discover his wants as there. Every thing he sees appears either necessary, or at least highly convenient; and he begins to wonder how he could have been so long without that which the ingenuity of the workman alone had invented, in order that from the novelty it might excite his desire; for perhaps when it is bought, he will never once think of it more, nor ever apply it to the use for which it at first appeared so necessary.

Here then is a reason why mankind labour though not in want. They become desirous of possessing the very instruments of luxury, which their avarice or ambition prompted them to invent for the use of others.

What has been said represents trade in its infancy, or rather the materials with which that great fabrick is built.

We have formed an idea of the wants of mankind multiplied even to luxury, and abundantly supplied by the employment of all the free hands set apart for that purpose. But if we suppose the workman himself disposing of his work, and purchasing with it food from the farmer, cloaths from the clothier; and, in general, seeking for the supply of every want from the hands of the person directly employed for the purpose of relieving it; this will not convey an idea of trade, according to our definition.

Trade and commerce are an abbreviation of this long process; a scheme invented and set on foot by merchants, from a principle of gain, supported and extended among men, from a principle of general utility to every individual, rich or poor, to every society, great or small.

Instead of a pin-maker exchanging his pins with fifty different persons, for whose labour he has occasion, he sells all to the merchant for money or for credit; and, as occasion offers, he purchases all his wants, either directly from those who supply them, or from other merchants who deal with manufacturers in the same way his merchant dealt with him.

Another advantage of trade is, that industrious people in one part of the country, may supply customers in another, though distant. They may establish themselves in the most commodious places for their respective busi-

ness, and help one another reciprocally, without making the distant parts of the country suffer for want of their labour. They are likewise exposed to no avocation from their work, by seeking for customers.

Trade produces many excellent advantages; it marks out to the manufacturers when their branch is under or over stocked with hands. If it is understocked, they will find more demand than they can answer: if it is overstocked, the sale will be slow.

Intelligent men, in every profession, will easily discover when these appearances are accidental, and when they proceed from the real principles of trade.

Posts, and correspondence by letters, are a consequence of trade; by the means of which merchants are regularly informed of every augmentation or diminution of industry in every branch, in every part of the country. From this knowledge they regulate the prices they offer; and as they are many, they serve as a check upon one another, from the principles of competition.

From the current prices the manufacturers are as well informed as if they kept the correspondence themselves: the statesman feels perfectly where hands are wanting, and young people destined to industry, obey, in a manner, the call of the public, and fall naturally in to supply the demand.

Two great assistances to merchants, especially in the infancy of trade, are public markets for collecting the work of small dealers, and large undertakings in the manufacturing way by private hands. By these means the merchants come at the knowledge of the quantity of work in the market, as on the other hand the manufacturers learn, by the sale of the goods, the extent of the demand for them. These two things being justly known, the price of goods is easily fixed.

Public sales serve to correct the small inconveniencies which proceed from the operations of trade. A set of manufacturers got all together into one town, and entirely taken up with their industry, are thereby as well informed of the rate of the market as if every one of them carried thither his work, and upon the arrival of the merchant, who readily takes it off their hands, he has not the least advantage over them from his knowledge of the state of demand. This man both buys and sells in what is called wholesale; and from him retailers purchase, who distribute the goods to every consumer throughout the country. These last buy from wholesale merchants in every branch, that proportion of every kind of merchandise which is suitable to the demand of their borough, city, or province.

Thus all inconveniencies are prevented, at some additional cost to the consumer, who must naturally reimburse the whole expence. The distance of the manufacturer, the obscurity of his dwelling, the caprice in selling his work, are quite removed; the retailer has all in his shop, and the public buys at a current price.

#### *How the Prices of Goods are determined by Trade.*

IN the price of goods, two things must be considered as really existing, and quite different from one another;



to wit, the real value of the commodity, and the profit upon alienation.

I. The first thing to be known of any manufacture, when it comes to be sold, is, how much of it a person can perform in a day, a week, a month, according to the nature of the work, which may require more or less time to bring it to perfection. In making such estimates, regard is to be had only to what, upon an average, a workman of the country in general may perform, without supposing him the best or the worst in his profession, or having any peculiar advantage or disadvantage as to the place where he works.

Hence the reason why some people thrive by their industry, and others not; why some manufactures flourish in one place, and not in another.

II. The second thing to be known, is the value of the workman's subsistence, and necessary expence, both for supplying his personal wants, and providing the instruments belonging to his profession, which must be taken upon an average as above; except when the nature of the work requires the presence of the workman in the place of consumption: for although some trades, and almost every manufacture, may be carried on in places at a distance, and therefore may fall under one general regulation as to prices; yet others there are which, by their nature, require the presence of the workman in the place of consumption; and in that case the prices must be regulated by circumstances relative to every particular place.

III. The third and last thing to be known, is the value of the materials, that is, the first matter employed by the workman; and if the object of his industry be the manufacture of another, the same process of inquiry must be gone through with regard to the first, as with regard to the second: and thus the most complex manufactures may be at last reduced to the greatest simplicity.

These three articles being known, the price of manufacture is determined. It cannot be lower than the amount of all the three, that is, than the real value; whatever it is higher, is the manufacturer's profit. This will ever be in proportion to demand, and therefore will fluctuate according to circumstances.

Hence appears the necessity of a great demand, in order to promote flourishing manufactures.

By the extensive dealings of merchants, and their constant application to the study of the balance of work and demand, all the above circumstances are known to them, and are made known to the industrious, who regulate their living and expence according to their certain profit.

Employ a workman in a country where there is little trade or industry, he proportions his price always to the urgency of your want, or your capacity to pay; but seldom to his own labour. Employ another in a country of trade, he will not impose upon you, unless perhaps you be a stranger, which supposes your being ignorant of the value; but employ the same workman in a work not usual in the country, consequently not demanded, consequently not regulated as to the value, he will proportion his price as in the first supposition.

We may therefore conclude from what has been said, that in a country where trade has been established, manufactures must flourish, from the ready sale, the regula-

ted price of work, and the certain profit resulting from industry. Let us next inquire into the consequences of such a situation.

*How foreign Trade opens to an industrious People, and the Consequences of it to the Merchants who set it on foot.*

THE first consequence of the situation described in the preceding section is, that wants are easily supplied, for the adequate value of the thing wanted.

The next consequence is, the opening of foreign trade under its two denominations of passive and active. Strangers and people of distant countries, finding the difficulty of having their wants supplied at home, and the ease of having them supplied from this country, immediately have recourse to it. This is passive trade. The active is when merchants, who have executed this plan at home with success, begin to transport the labour of their countrymen into other regions, which either produce, or are capable of producing such articles of consumption, proper to be manufactured, as are most demanded at home; and consequently will meet with the readiest sale, and fetch the largest profits.

Here then is the opening of foreign trade, under its two denominations of active and passive.

What then are the consequences of this new commerce to our merchants, who have left their homes in quest of gain aboard?

The first is, that, arriving in any new country, they find themselves in the same situation, with regard to the inhabitants, as the workman in the country of no trade, with regard to those who employed him; that is, they proportion the price of their goods to the eagerness of acquiring, or the capacity of paying, in the inhabitants, but never to their real value.

The first profits then, upon this trade, must be very considerable; and the demand from such a country will be *high or low, great or small*, according to the spirit, not the real wants of the people: for these in all countries must first be supplied by the inhabitants themselves, before they cease to labour.

If the people of this not-trading country be abundantly furnished with commodities useful to the traders, they will easily part with them, at first, for the instruments of luxury and ease; but the great profit of the traders will insensibly increase the demand for the productions of their new correspondents; this will have the effect of producing a competition between themselves, and thereby of throwing the demand on their side. This is perpetually a disadvantage in traffic: the most unpolished nations in the world quickly perceive the effects of it; and are taught to profit by the discovery, in spite of the address of those who are the most expert in commerce.

The traders will therefore be very fond of falling upon every method and contrivance to inspire this people with a taste of refinement and delicacy. Abundance of fine presents, consisting of every instrument of luxury and superfluity, the best adapted to the genius of the people, will be given to the prince and leading men among them. Workmen will even be employed at home to study the

taste of the strangers, and to captivate their desires by every possible means. The more eager they are of presents, the more lavish the traders will be in bestowing and diversifying them. It is an animal put up to fatten, the more he eats the sooner he is fit for slaughter. When their taste for superfluity is fully formed, when the relish for their former simplicity is sophisticated, poisoned, and obliterated, then they are surely in the fetters of the traders, and the deeper they go, the less possibility there is of their getting out. The presents then will die away, having served their purpose; and if afterwards they are found to be continued, it will probably be to support the competition against other nations, who will incline to share of the profits.

If, on the contrary, this not-trading nation does not abound with commodities useful to the traders, these will make little account of trading with them, whatever their turn may be; but, if we suppose this country inhabited by a laborious people, who, having taken a taste for refinement from the traders, apply themselves to agriculture, in order to produce articles of subsistence, they will solicit the merchants to give them part of their manufactures in exchange for those; and this trade will undoubtedly have the effect of multiplying numbers in the trading nation. But if food cannot be furnished, nor any other branch of production found out to support the correspondence, the taste for refinement will soon die away, and trade will stop in this quarter.

Had it not been for the furs in those countries adjacent to Hudson's Bay, and in Canada, the Europeans never would have thought of supplying instruments of luxury to those nations; and if the inhabitants of those regions had not taken a taste for the instruments of luxury, furnished to them by the Europeans, they never would have become so indefatigable nor so dextrous hunters. At the same time we are not to suppose, that ever these Americans would have come to Europe in quest of our manufactures. It is therefore owing to our merchants, that these nations are become in any degree fond of refinement; and this taste, in all probability, will not soon exceed the proportion of the productions of their country. From these beginnings of foreign trade it is easy to trace its increase.

One step towards this, is the establishing correspondences in foreign countries; and these are more or less necessary in proportion as the country where they are established is more or less polished or acquainted with trade. They supply the want of posts, and point out to the merchants what proportion the productions of the country bear to the demand of the inhabitants for manufactures. This communicates an idea of commerce to the not-trading nation, and they insensibly begin to fix a determined value upon their own productions, which perhaps bore no determined value at all before.

Let us trace a little the progress of this refinement in the savages, in order to shew how it has the effect of throwing the demand upon the traders, and of creating a competition among them, for the productions of the new country.

Experience shews, that, in a new discovered country, merchants constantly find some article or other of its pro-

ductions, which turns out to a great account in commerce; and we see that the longer such a trade subsists, and the more the inhabitants take a taste for European manufactures, the more their own productions rise in their value, and the less profit is made by trading with them, even in cases where the trade is carried on by companies; which is a very wise institution for one reason, that it cuts off a competition between our merchants.

This is the best means of keeping prices low in favour of the nation; however it may work a contrary effect with respect to individuals who must buy from these monopolies.

When companies are not established, and when trade is open, our merchants, by their eagerness to profit by the new trade, betray the secrets of it, they enter into competition for the purchase of the foreign produce, and this raises prices, and favours the commerce of the most ignorant savages.

*Consequences of the Introduction of a passive foreign Trade among a People who live in Simplicity and Idleness.*

WE now suppose the arrival of traders, all in one interest, with instruments of luxury and refinement, at a port in a country of great simplicity of manners, abundantly provided by nature with great advantages for commerce, and peopled by a nation capable of adopting a taste for superfluities.

The first thing the merchants do is, to expose their goods, and point out the advantages of many things, either agreeable or useful to mankind in general, such as wines, spirits, instruments of agriculture, arms, and ammunition for hunting, nets for fishing, manufactures for clothing, and the like. The advantages of these are presently perceived, and such commodities are eagerly sought after.

The natives on their side produce what they most esteem, generally something superfluous or ornamental. The traders, after examining all circumstances, determine the object of their demand, giving the least quantity possible in return for this superfluity, in order to impress the inhabitants with a high notion of the value of their own commodities; but as this parsimony may do more hurt than good to their interest, they are very generous in making presents, from the principles mentioned above.

When the exchange is completed, and the traders depart, regret is commonly mutual; the one and the other are sorry that the superfluities of the country fall short. A return is promised by the traders, and assurances are given by the natives of a better provision another time.

What are the first consequences of this revolution?

It is evident, that, in order to supply an equivalent for this new want, more hands must be set to work than formerly. And it is evident also, that this augmentation of industry will not essentially increase numbers: Why? Because the produce of the industry is, in this case, intended to be exported. But, if we can find out any additional consumption at home, even implied by  
this

this new trade, it will have the effect of augmenting numbers. An example will make this plain.

Let us suppose the superfluity of this country to be the skins of wild beasts, not proper for food; the manufacture sought for, brandy. The brandy is sold for furs. He who has furs, or he who can spare time to hunt for them, will drink brandy in proportion: but there is no reason to conclude from this simple operation, that one man more in the country must necessarily be fed, or that any augmentation of agriculture must of consequence ensue from this new traffic.

But let us throw in a circumstance which may apply an additional consumption at home, and then examine the consequences.

A poor creature who has no equivalent to offer for food, who is miserable, and ready to perish for want of subsistence, goes a hunting, and kills a wolf; he comes to a farmer with the skin, and says, You are well fed, but you have no brandy; if you will give me a loaf, I will give you this skin, which the strangers are so fond of, and they will give you brandy. But; says the farmer, I have no more bread than what is sufficient for my own family. As for that, replies the other, I will come and dig in your ground, and you and I will settle our account as to the small quantity I desire of you. The bargain is made; the poor fellow gets his loaf, and lives at least; perhaps he marries, and the farmer gets a dram. But had it not been for this dram, that is, this new want, which was purchased by the industry of this poor fellow, by what argument could he have induced the farmer to part with a loaf?

Here the sentiment of charity is excluded. This alone is a principle of multiplication; but as true it is, on the other hand, that could the poor fellow have got bread by begging; he would not probably have gone a-hunting.

Here then it appears, that the very dawning of trade, in the most unpolished countries, implies a multiplication. This is enough to point out the first step, and to connect the subject of our present inquiries with what has been already discussed in relation to other circumstances.

So soon as all the furs are disposed of, and a taste for superfluity is introduced, both the traders and the natives will be equally interested in the advancement of industry in this country. Many new objects of profit for the first will be discovered, which the proper employment of the inhabitants, in reaping the natural advantages of their soil and climate, will make effectual. The traders will therefore endeavour to set on foot many branches of industry among the savages, and the allurements of brandy, arms, and clothing; will animate these in the pursuit of them.

When once this revolution is brought about; when those who formerly lived in simplicity become industrious; manners put on a new face.

That is to say, we now find two trading nations instead of one, with this difference, however, that as hitherto we have supposed the merchants all in one interest, the compound demand, that is, the competition of the buyers, has been, and must still continue on the side of

the natives. This is a great prejudice to their interest; but as it is not supposed sufficient to check their industry, nor to restrain their consumption of the manufactures, let us here examine a little more particularly the consequences of the principle of demand in such a situation; for although we allow, that it can never change sides, yet it may admit of different modifications, and produce different effects, as we shall presently perceive.

The merchants we suppose all in one interest, consequently there can be no competition among them; consequently no check can be put upon their raising their prices, as long as the prices they demand are complied with. So soon as they are raised to the full extent of the abilities of the natives, or of their inclination to buy, the merchants have the choice of three things, which are all perfectly in their option; and the preference to be given to the one or the other, depends entirely upon themselves, and upon the circumstances we are going to point out.

First, they may support they *high* demand; that is, not lower their price; which will preserve a high estimation of the manufactures in the opinion of the inhabitants, and render the profits upon their trade the greatest possible. This part they may possibly take, if they perceive the natives doubling their diligence, in order to become able, in time, to purchase considerable cargoes at a high value; from which supposition is implied a strong disposition in the people to become luxurious, since nothing but want of ability prevents them from complying with the highest demand: but still another circumstance must concur, to engage the merchants not to lower their price. The great proportion of the goods they seek for in return, must be found in the hands of a few. This will be the case if slavery be established; for then there must be many poor, and few rich: and they are commonly the rich consumers who proportion the price they offer, rather to their desires, than to the value of the thing.

The second thing which may be done is, to open the door to a *great* demand; that is, to lower their prices. This will sink the value of the manufactures in the opinion of the inhabitants, and render profits less in proportion, although indeed, upon the voyage, the profits may be greater.

This part they will take, if they perceive the inhabitants do not incline to consume great quantities of the merchandize at a high value, either for want of abilities or inclination; and also, if the profits upon the trade depend upon a large consumption, as is the case in merchandize of a low value, and suited chiefly to the occasions of the lower sort. Such motives of expediency will be sufficient to make them neglect a *high* demand, and prefer a *great* one; and the more, when there is a likelihood that the consumption of low-priced goods in the beginning may beget a taste for others of a higher value, and thus extend in general the taste of superfluity.

A third part to be taken, is the least politic, and perhaps the most familiar. It is to profit by the competition between the buyers, and encourage the rising of demand as long as possible; when this comes to a stop, to make a kind of auction, by first bringing down the prices

to

to the level of the highest bidders, and so to descend by degrees, in proportion as demand sinks. Thus we may say with propriety, that demand commonly becomes *great*, in proportion as prices sink. By this operation, the traders will profit as much as possible, and sell off as much of their goods as the profits will permit.

But this plan, in a new discovered country, is not politic, as it both discovers a covetousness and a want of faith in the merchants, and also throws open the secrets of their trade to those who ought to be kept ignorant of them.

Let us next suppose, that the large profits of our merchants shall be discovered by others, who arrive at the same ports in a separate interest, and who enter into no combination which might prevent the natural effects of competition.

Let the state of demand among the natives be supposed the same as formerly, both as to *height* and *greatness*, in consequence of the operation of the different principles, which might have induced our merchants to follow one or other of the plans we have been describing; we must however still suppose, that they have been careful to preserve considerable profits upon every branch.

If we suppose the inhabitants to have increased in numbers, wealth, and taste for superfluity, since the last voyage, demand will be found rather on the rising hand. Upon the arrival of the merchants in competition with the former, both will offer to sale: but if both stand to the same prices, it is very natural to suppose, that the former dealers will obtain a preference; as, *ceteris paribus*, it is always an advantage to know and to be known. The last comers, therefore, have no other way left to counter-balance this advantage, but to lower their prices.

This is a new phenomenon: here the fall of prices is not voluntary as formerly; nor consented to from expediency; nor owing to a failure of demand, but to the influence of a new principle of commerce, to wit, a double competition, which we shall now examine.

#### Of Double Competition.

WHEN *competition* is much stronger on one side of the contract than on the other, it is called *simple*. This is the species of competition which is implied in the term *high demand*, or when it is said that *demand raises prices*.

*Double competition* is, when, in a certain degree, it takes place on both sides of the contract at once, or vibrates alternately from one to the other. This is what restrains prices to the adequate value of merchandize.

The great difficulty is to distinguish clearly between the principles of *demand*, and those of *competition*: here then follows the principal differences between the two, relatively to the effects they produce severally in the mercantile contract of buying and selling, which we here express shortly by the word *contract*.

*Simple demand* is what brings the quantity of a commodity to market. Many demand, who do not buy; many offer, who do not sell. This demand is called *great* or *small*; it is said to *increase*, to *augment*, to

*fall*; and is expressed by these and other synonymous terms, which mark an augmentation or diminution of quantity. In this species, two people never demand the same thing, but a part of the same thing, or things quite alike.

*Compound demand* is the principle which raises prices, and never can make them sink; because in this case more than one demands the very same thing. It is solely applicable to the buyers, in relation to the price they offer. This demand is called *high* or *low*, and is said to *rise*, to *fall*, to *mount*, to *sink*, and is expressed by these and other synonymous terms.

*Simple competition*, when between buyers, is the same as *compound* or *high demand*; but differs from it in so far, as this may equally take place among sellers, which *compound demand* cannot; and then it works a contrary effect: it makes prices *sink*, and is synonymous with *low demand*: it is this competition which overturns the balance of work and demand.

*Double competition* is what is understood to take place in almost every operation of trade; it is this which prevents their excessive rise of prices; it is this which prevents their excessive fall. While *double competition* prevails, the balance is perfect, trade and industry flourish.

The capital distinction, therefore, between the terms *demand* and *competition* is, that *demand* is constantly relative to the buyers; and when money is not the price, as in barter, then it is relative to that side upon which the greatest *competition* is found.

We therefore say, with regard to *prices*, demand is *high* or *low*. With regard to the *quantity of merchandize*, demand is *great* or *small*. With regard to *competition*, it is always called *great* or *small*, *strong* or *weak*.

*Competition* is, with equal propriety, applicable to both parties in the contract. A *competition* among buyers is a proper expression; a *competition* among sellers, who have the merchandize, is fully as easily understood, tho' it be not quite so striking, for reasons which an example will make plain.

You come to a fair, where you find a great variety of every kind of merchandize, in the possession of different merchants. These, by offering their goods to sale, constitute a tacit competition; every one of them wishes to sell in preference to another, and at the same time with the best advantage to himself.

The buyers begin, by cheaping at every shop. The first price asked marks the covetousness of the seller; the first price offered, the avarice of the buyer. From this operation competition begins to work its effects on both sides, and so becomes double. The principles which influence this operation are now to be deduced.

It is impossible to suppose the same degree of eagerness, either to buy or to sell, among several merchants; because the degree of eagerness is exactly in proportion to their view of profit; and as these must necessarily be influenced and regulated by different circumstances, that buyer, who has the best prospect of selling again with profit, obliges him, whose prospect is not so good, to content himself with less; and that seller, who has bought to the best advantage, obliges him, who has paid dearer

dearer for the merchandize, to moderate his desire of gain.

It is from these principles, that competition among buyers and sellers must take place. This is what confines the fluctuation of prices within limits which are compatible with the reasonable profits of both buyers and sellers; for we must constantly suppose the whole operation of buying and selling to be performed by merchants; the buyer cannot be supposed to give to high a price as that which he expects to receive, when he distributes to the consumers, nor can the seller be supposed to accept of a lower than that which he paid to the manufacturer. This competition is properly called double, because of the difficulty to determine upon which side it stands; the same merchant may have it in his favour upon certain articles, and against him upon others; it is continually in vibration, and the arrival of every post may less or more pull down the heavy scale.

In every transaction between merchants, the profit resulting from the sale must be exactly distinguished from the value of the merchandize. The first *may vary*, the last never *can*. It is this profit alone which can be influenced by competition; and it is for that reason we find such uniformity every where in the prices of goods of the same quality.

The competition between sellers does not appear so striking, as that between buyers; because he who offers to sale, appears only passive in the first operation; whereas the buyers present themselves one after another; they make a demand when the merchandize is refused to one at a certain price, a second either offers more, or does not offer all: but so soon as another seller finds his account in accepting the price the first had refused, then the first enters into competition, providing his profits will admit his lowering the first price, and thus competition takes place among the sellers, until the profits upon their trade prevent prices from falling lower.

In all markets this competition is varying, though insensibly, on many occasions; but in others, the vibrations are very perceptible. Sometimes it is found strongest on the side of the buyers; and in proportion as this grows, the competition between the sellers diminishes. When the competition between the former has raised prices to a certain standard, it comes to a stop; then the competition changes sides, and takes place among the sellers, eager to profit of the highest price. This makes prices fall, and according as they fall, the competition among the buyers diminishes. They still wait for the lowest period. At last it comes; and then perhaps some new circumstance, by giving the balance a kick, disappoints their hopes. If therefore it ever happens, that there is but one interest upon one side of the contract, as in the example in the former section, where we supposed the sellers united, you perceive, that the rise of the price, occasioned by the competition of the buyers, and even its coming to a stop, could not possibly have the effect of producing any competition on the other side; and therefore, if prices come afterwards to sink, the fall must have proceeded from the prudential considera-

tions of adapting the price to the faculties of those who, from the height of it, had withdrawn their demand.

From these principles of competition, the forestalling of markets is made a crime, because it diminishes the competition which ought to take place between different people, who have the same merchandize to offer to sale. The forestaller buys all up, with an intention to sell with more profit, as he has by that means taken other competitors out of the way, and appears with a single interest on one side of the contract, in the face of many competitors on the other. This person is punished by the state, because he has prevented the price of the merchandize from becoming justly proportioned to the real value; he has robbed the public, and enriched himself; and in the punishment he makes restitution. Here occur two questions to be resolved, for the sake of illustration.

Can competition among buyers possibly take place, when the provision made is more than sufficient to supply the quantity demanded? On the other hand, can competition take place among the sellers, when the quantity demanded exceeds the total provision made for it?

We think it may in both cases; because in the one and the other, there is a competition implied on one side of the contract, and the very nature of this competition implies a possibility of its coming on the other, provided separate interests be found upon both sides. But to be more particular:

1. Experience shews, that however justly the proportion between the demand and the supply may be determined in fact, it is still next to impossible to discover it exactly, and therefore the buyers can only regulate the prices they offer, by what they may reasonably expect to sell for again. The sellers, on the other hand, can only regulate the prices they expect, by what the merchandize has cost them when brought to market. We have already shewn, how, under such circumstances, the several interests of individuals affect each other, and make the balance vibrate.

2. The proportion between the supply and the demand is seldom other than *relative* among merchants, who are supposed to buy and sell, not from necessity, but from a view to profit. What we mean by *relative* is, that their demand is *great* or *small*, according to prices; there may be a great demand for grain at 35 s. *per* quarter, and no demand at all for it at 40s.; that is, among merchants.

It is essential to attend to the smallest circumstance in matters of this kind. The circumstance we mean, is the difference we find in the effect of competition, when it takes place purely among merchants on both sides of the contract, and when it happens, that either the consumers mingle themselves with the merchant buyers, or the manufacturers, that is, the furnishers, mingle themselves with the merchant-sellers. This combination we shall illustrate, by the solution of another question, and then conclude with a few reflections upon the whole.

Can there be no case formed, where the competition upon one side may subsist, without a possibility of its taking

king place on the other, although there should be separate interests upon both?

The case is hardly supposable among merchants, who buy and sell with a view to profit; but it is absolutely supposable, and that is all, when the direct consumers are the buyers; when the circumstances of one of the parties is perfectly known; and when the competition is so strong upon one side, as to prevent a possibility of its becoming double, before the whole provision is sold off, or the demand satisfied. Let us have recourse to examples.

Grain arriving in a small quantity, at a port where the inhabitants are starving, produces so great a competition among the consumers, who are the buyers, that their necessity becomes evident; all the grain is generally bought up before prices can rise so high as to come to a stop; because nothing but want of money, that is, an impossibility of complying with the prices demanded by the merchants, can restrain them: but if you suppose, even here, that prices come naturally to a stop; or that, after some time, they fall lower, from prudential considerations; then there is a possibility of a competition taking place among the sellers, from the principles above deduced. If, on the contrary, the stop is not natural, but occasioned by the interposition of the magistrate, from humanity, or the like, there will be no competition, because then the principles of commerce are suspended; the sellers are restrained on one side, and they restrain the buyers on the other. Or rather, indeed, it is the magistrate, or compassion, who in a manner fixes the price, and performs the office of both buyer and seller.

A better example still may be found, in a competition among sellers; where it may be so strong, as to render a commodity in a manner of no value at all, as in the case of an uncommon and unexpected draught of fish, in a place of small consumption, when no preparations have been made for salting them. There can be then no competition among the buyers; because the market cannot last, and they find themselves entirely masters, to give what price they please, being sure the sellers must accept of it, or lose their merchandize. In the first example, humanity commonly stops the activity of the principle of competition; in the other it is stopped by a certain degree of fair dealing, which forbids the accepting of a merchandize for nothing.

In proportion therefore as the rising of prices can stop demand, or the sinking of prices can increase it, in the same proportion will competition prevent either the rise or the fall from being carried beyond a certain length: and if such a case can be put, where the rising of prices cannot stop demand, nor the lowering of prices augment it, in such cases double competition has no effect; because these circumstances unite the most separate interests of buyers and sellers in the mercantile contract; and when upon one side there is no separate interest, there can then be no competition.

From what has been said, we may form a judgment of the various degrees of competition. A book not worth a shilling, a fish of a few pounds weight, are often sold for considerable sums. The buyers here are not merchants. When an ambassador leaves a court in a

hurry, things are sold for less than the half of their value: he is no merchant, and his situation is known. When, at a public market, there are found consumers, who make their provision; or manufacturers, who dispose of their goods for present subsistence; the merchants, who are respectively upon the opposite side of the contract to these, profit of their competition; and those who are respectively upon the same side with them, stand by with patience, until they have finished their business. Then matters come to be carried on between merchant and merchant, and then profits may rise and fall, in the proportion of quantity to demand; that is to say, if the provision is less than the demand, the competition among the demanders, or the rise of the price, will be in the compound proportion of the falling short of the commodity, and of the prospect of selling again with profit. It is this combination which regulates the competition, and keeps it within bounds. It can affect but the profits upon the transaction; the intrinsic value of the commodity stands immovable: nothing is ever sold below the real value; nothing is ever bought for more than it may probably bring. We mean, in general. Whereas, so soon as consumers and needy manufacturers mingle in the operation, all proportion is lost. The competition between them is too strong for the merchants; the balance vibrates by jerks. In such markets merchants seldom appear: the principal objects there, are the fruits and productions of the earth, and articles of the first necessity for life, not manufactures strictly so called. A poor fellow often sells, to purchase bread to eat; not to pay what he did eat while he was employed in the work he disposes of. The consumer often measures the value of what he is about to purchase, by the weight of his purse, and his desire to consume.

### *Of what is called Expence, Profit, and Loss.*

THE term *expence*, when simply expressed, without any particular relation, is always understood to be relative to money. This kind is distinguished under the three heads of *private*, *public*, and *national*.

1. *Private expence* is, what a private person, or private society, lays out, either to provide articles of consumption, or something more permanent, which may be conducive to their ease, convenience, or advantage. Thus we say, a *large domestic expence*, relative to one who spends a great income. We say, a merchant has been at *great expence* for magazines, for living, for clerks, &c. but never that he has been at any in buying goods. In the same way a manufacturer may expend for building, machines, horses, and carriages, but never for the matter he manufactures. When a thing is bought, in order to be sold again, the sum employed is called *money advanced*; when it is bought not to be sold, it may be said to be *expended*.

2. *Public expence* is, the employment of that money, which has been contributed by individuals, for the current service of the state. The contribution, or gathering it together, represents the effects of many articles of *private expence*; the laying it out when collected, is *public expence*.

### 3. *National*

3. *National expence*, is what is expended out of the country: this is what diminishes national wealth. The principal distinction to be here attended to, is between *public expence*, or the laying out of public money, and *national expence*, which is the alienating the nation's wealth in favour of strangers. Thus the greatest *public expence* imaginable, may be no national expence; because the money may remain at home. On the other hand, the smallest *public*, or even *private expence*, may be a national expence; because the money may go abroad.

*Profit and loss* is divided into *positive*, *relative*, and *compound*. *Positive profit*, implies no loss to any body; it results from an augmentation of labour, industry, or ingenuity, and has the effect of swelling or augmenting the public good.

*Positive loss*, implies no profit to any body; it is what results from the cessation of the former, or of the effects resulting from it, and may be said to diminish the public good.

*Relative profit*, is what implies a loss to some body; it marks a vibration of the balance of wealth between parties, but implies no addition to the general stock.

*Relative loss*, is what, on the contrary, implies a profit to some body; it also marks a vibration of the balance, but takes nothing from the general stock.

The *compound* is easily understood; it is that species of profit and loss which is partly *relative*, and partly *positive*.

#### *The general Consequences resulting to a trading Nation, upon the opening of an active foreign Commerce.*

A NATION which remains passive in her commerce, is at the mercy of those who are active, and must be greatly favoured, indeed, by natural advantages, or by a constant flux of gold and silver from her mines, to be able to support a correspondence, not entirely hurtful to the augmentation of her wealth.

When we look upon the wide field which here opens to our view, we are perplexed with too great a variety of objects. In one part, we see a decent and comely beginning of industry; wealth flowing gently in, to recompense ingenuity; numbers both augmenting, and every one becoming daily more useful to another; agriculture proportionally extending itself; no violent revolutions; no exorbitant profits; no insolence among the rich; no excessive misery among the poor; multitudes employed in producing; great oeconomy upon consumption; and all the instruments of luxury, daily produced by the hands of the diligent, going out of the country for the service of strangers; not remaining at home for the gratification of sensuality. At last the augmentations come insensibly to a stop. Then these rivers of wealth, which were in brisk circulation through the whole world, and which returned to this trading nation as blood returns to the heart, only to be thrown out again by new pulsations, begin to be obstructed in their course; and flowing abroad more slowly than before, come to form stagnations at home. These, impatient of restraint, soon burst out into domestic circulation. Upon this cities swell in magni-

ficence of buildings; the face of the country is adorned with palaces, and becomes covered with groves; luxury shines triumphant in every part; inequality becomes more striking to the eye; and want and misery appear more deformed, from the contrast: even fortune grows more whimsical in her inconstancy; the beggar of the other day, now rides in his coach; and he who was born in a bed of state, is seen to die in a goal, or in an almshouse. Such are the effects of great domestic circulation.

The statesman looks about with amazement; he, who was wont to consider himself as the first man in the society in every respect, perceives himself, perhaps, eclipsed by the lustre of private wealth, which avoids his grasp when he attempts to seize it. This makes his government more complex and more difficult to be carried on; he must now avail himself of art and address, as well as of power and force. By the help of cajoling and intrigues, he gets a little into debt; this lays a foundation for public credit, which, growing by degrees, and in its progress assuming many new forms, becomes, from the most tender beginnings, a most formidable monster, striking terror into those who cherished it in its infancy. Upon this, as upon a triumphant war-horse, the statesman gets a-stride; he then appears formidable a-new; his head turns giddy; he is choaked with the dust he has raised; and at the moment he is ready to fall, to his utter astonishment and surprize, he finds a strong monied interest, of his own creating, which, instead of swallowing him up as he apprehended, flies to his support. Through this he gets the better of all opposition, he establishes taxes, multiplies them, mortgages his fund of subsistence; either becomes a bankrupt, and rises again from his ashes; or if he be less audacious, he stands trembling and tottering for a while on the brink of the political precipice. From one or the other of these perilous situations, he begins to discover an endless path, which, after a multitude of windings, still returns into itself, and continues an equal course through this vast labyrinth.

It is now full time to leave off rhapsody, and return to reasoning and cool inquiry, concerning the more immediate and more general effects and revolutions produced by the opening of a foreign trade in a nation of industry.

The first and most sensible alteration will be an increase of demand for manufacturers, because by supplying the wants of strangers, the number of consumers will now be considerably augmented. What again will follow upon this, must depend upon circumstances.

If this revolution in the state of demand should prove too violent, the consequence of it will be to raise demand; if it should prove gradual, it will increase it. This distinction is well understood, and the consequence appears just: for, if the supply do not increase in proportion to the demand; a competition will ensue among the demanders; which is the common effect of such sudden revolutions. If, on the other hand, a gentle increase of demand should be accompanied with a proportional supply, the whole industrious society will grow in vigour, and in wholesome stature, without being sensible

of any great advantage or inconveniency; the change of their circumstances will even be imperceptible.

The immediate effects of the violent revolution will, in this example, be flattering to some, and disagreeable to others. Wealth will be found daily to augment, from the rising of prices, in many branches of industry. This will encourage the industrious classes, and the idle consumers at home will complain. We have already dwelt abundantly long upon the effects resulting from this to the lower classes of the people, in providing them with a certain means of subsistence. Let us now examine in what respect even the higher classes will be made likewise to feel the good effects of this general change, although at first they may suffer a temporary inconveniency from it.

Farmers, as has been observed, will have a greater difficulty in finding servants, who, instead of labouring the ground, will chuse to turn themselves to manufactures. This we have considered in the light of purging the lands of superfluous mouths; but every consequence in this great chain of politics draws other consequences after it, and as they follow one another, things put on different faces, which affect classes differently. The purging of the land is but one of the first; here follows another.

The desertion of the lands employed in a trifling agriculture will at first, no doubt, embarrass the farmers; but in a little time every thing becomes balanced in a trading nation, because *here every industrious man must advance in prosperity, in spite of all general combinations of circumstances.*

In the case before us, the relative profits upon farming must soon become greater than formerly, because of this additional expence which must affect the whole class of farmers; consequently, this additional expence, instead of turning out to be a loss to either landlord or farmer, will, after some little time, turn out to the advantage of both: because the produce of the ground, being indispensably necessary to every body, must in every article increase in its value. Thus in a short time accounts will be nearly balanced on all hands; that is to say, the same proportion of wealth will, *ceteris paribus*, continue the same among the industrious. We say among the industrious; for those who are either idle, or even negligent, will be great losers.

A proprietor of land, inattentive to the causes of his farmer's additional expence, may very imprudently suffer his rents to fall, instead of assisting him on a proper occasion, in order to make them afterwards rise the higher.

Those who live upon a determined income in money, and who are nowise employed in traffic, nor in any scheme of industry, will, by the augmentation of prices, be found in worse circumstances than before.

In a trading nation every man must turn his talents to account, or he will undoubtedly be left behind in this universal emulation, in which the most industrious, the most ingenious, and the most frugal will constantly carry off the prize.

This consideration ought to be a spur to every body. The richest men in a trading nation have no security against poverty; we mean proportional poverty; for though

they diminish nothing of their income, yet, by not increasing it in proportion to others, they lose their rank in wealth, and from the first class in which they stood they will slide insensibly down to a lower.

There is one consequence of an additional beneficial trade, which raises demand and increases wealth; but if we suppose no proportional augmentation of supply, it will prove at best but an airy dream which lasts for a moment, and when the gilded scene is passed away; numberless are the inconveniencies which are seen to follow.

We shall now point out the natural consequences of this augmentation of wealth drawn from foreign nations, when the statesman remains inattentive to increase the supply both of food and manufactures, in proportion to the augmentation of mouths, and of the demand for the produce of industry.

In such a situation profits will daily swell, and every scheme for reducing them within the bounds of moderation, will be looked upon as a hurtful and unpopular measure: be it so; but let us examine the consequences.

We have said, that the rise of demand for manufactures naturally increases the value of work: now we must add, that under such circumstances, the augmentation of riches, *in a country, either not capable of improvement as to the soil, or where precautions have not been taken for facilitating a multiplication of inhabitants, by the importation of subsistence,* will be productive of the most calamitous consequences.

On one side, this wealth will effectually diminish the mass of the food before produced; and on the other, will increase the number of useless consumers. The first of these circumstances will raise the demand for food; and the second will diminish the number of useful free hands, and consequently raise the price of manufactures: here are shortly the outlines of this progress.

The more rich and luxurious a people are, the more delicate they become in their manner of living; if they fed on bread formerly, they will now feed on meat; if they fed on meat, they will now feed on fowl. The same ground which feeds a hundred with bread, and a proportional quantity of animal food, will not maintain an equal number of delicate livers. Food must then become more scarce; demand for it rises; the rich are always the strongest in the market; they consume the food, and the poor are forced to starve. Here the wide door to modern distress opens; to wit, a hurtful competition for subsistence. Farther, when a people become rich, they think less of œconomy; a number of useless servants are hired, to become an additional dead weight on consumption; and when their starving countrymen cannot supply the extravagance of the rich to cheaply as other nations, they either import instruments of foreign luxury, or seek to enjoy them out of their own country, and thereby make restitution of their gains.

Is it not therefore evident, that if, before things come to this pass, additional subsistence be not provided by one method or other, the number of inhabitants must diminish; although riches may daily increase by a balance of additional matter, supposed to be brought into the country



in consequence of the hitherto beneficial foreign trade. This is not all. We say farther, that the beneficial trade will last for a time only. For the infallible consequence of the rise of prices at home will be, that those nations which at first consumed your manufactures, perceiving the gradual increase of their price, will begin to work for themselves; or finding out your rivals who can supply them cheaper, will open their doors to them. These again, perceiving the great advantages gained by your traders, will begin to supply the market; and since every thing must be cheaper in countries where we do not suppose the concurrence of all the circumstances mentioned above, these nations will supplant you, and be enriched in their turn.

Here comes a new revolution. Trade is come to a stop: what then becomes of all the hands which were formerly employed in supplying the foreign demands?

Were revolutions so sudden as we are obliged to represent them, all would go to wreck; in proportion as they happen by quicker or slower degrees, the inconveniencies are greater or smaller.

Prices, we have said, are made to rise by competition. If the competition of the strangers was what raised them, the distress upon the manufacturers will be in proportion to the suddenness of their deserting the market. If the competition was divided between the strangers and the home-consumers, the inconveniencies which ensue will be less; because the desertion of the strangers will be in some measure made up by an increase of home-consumption which will follow upon the fall of prices. And if, in the third case, the natives have been so imprudent, as not only to support a competition with the strangers, and thereby disgust them from coming any more to market, but even to continue the competition between themselves, the whole *loss* sustained by the revolution will be national. Wealth will cease to augment; but the inconveniencies, in place of being felt by the manufacturers, will only affect the state; those will continue in affluence, extolling the generosity of their countrymen, and despising the poverty of the strangers who had enriched them.

Domestic luxury will here prove an expedient for preserving from ruin the industrious part of a people, who in subsisting themselves had enriched their country. No change will follow in their condition; they will go on with a painful assiduity to labour, and if the consequences of it become now hurtful to one part of the state, they must at least be allowed to be essentially necessary for the support of the other.

But that luxury is no necessary concomitant of foreign trade, in a nation where the true principles of it are understood, will appear very plain, from a contrast we are now going to point out, in the example of a modern state, renowned for its commerce and frugality. The country is Holland.

A set of industrious and frugal people were assembled in a country by nature subject to many inconveniencies, the moving of which necessarily employed abundance of hands. Their situation upon the continent, the power of their former masters, and the ambition of their neighbours, obliged them to keep great bodies of troops.

These two articles added to the numbers of the community, without either enriching the state by their labour exported, or producing food for themselves or countrymen.

The scheme of a commonwealth was calculated to draw together the industrious; but it has been still more useful in subsisting them: the republican form of government being there greatly subdivided, veils authority sufficient in every part of it, to make suitable provision for their own subsistence; and the tie which unites them, regards only matters of public concern. Had the whole been governed by one sovereign, or by one council, this important matter never could have been effectuated.

It would be impossible for the most able minister that ever lived, to provide nourishment for a country so extended as France, or even as England, supposing these as fully peopled as Holland is: even although it should be admitted that a sufficient quantity of food might be found in other countries for their subsistence. The enterprise would be too great, abuses would multiply; the consequence would be, that the inhabitants would die for want. But in Holland the case is different, every little town takes care of its own inhabitants; and this care being the object of application and profit to so many persons, is accomplished with success.

When once it is laid down as a maxim in a country, that food must of necessity be got from abroad in order to feed the inhabitants at home, the corn-trade becomes considerable, and at the same time certain, regular, and permanent. This was the case in Holland: as the inhabitants were industrious, the necessary consequence has been, a very extraordinary multiplication; and at the same time such an abundance of grain, that, instead of being in want themselves, they often supply their neighbours. There are many examples of England's being supplied with grain from thence, and, which is still more extraordinary, from the re-exportation of the very produce of its own fruitful soil.

It is therefore evident, that the only way to support industry, is to provide a supply of subsistence, constantly proportional to the demand that may be made for it. This is a precaution indispensably necessary for preventing hurtful competition. This is the particular care of the Dutch: so long as it can be effectual, their state can fear no decline; but whenever they come to be distressed in the markets, upon which they depend for subsistence, they will sink into ruin. It is by mere dint of frugality, cheap and parsimonious living, that the navigation of this industrious people is supported. Constant employment, and an accumulation of almost imperceptible gains, fills their coffers with wealth, in spite of the large outgoings to which their own proper nourishment yearly forces them. The large profits upon industry in other countries, which are no proof of generosity, but a fatal effect of a scanty subsistence, is far from dazzling their eyes. They seldom are found in the list of competitors at any foreign port; if they have their cargo to dispose of, they wait with pleasure in their own vessels, consuming their own provisions, and at last accept of what others have left. It may be said, that many other circumstances concur in favour of the Dutch, besides the article of subsistence.

Without disputing this matter, it may be observed, that if a computation be made of the hands employed in providing subsistence, and of those who are severally taken up in supplying every other want, their numbers will be found nearly to balance one another in the most luxurious countries. From this we may conclude, that the article of food, among the lower classes, must bear a very high proportion to all the other articles of their consumption; and therefore a diminution upon the price of subsistence, must be of infinite consequence to manufacturers, who are obliged to buy it. From this consideration, let us judge of the consequence of such augmentations upon the price of grain as are familiar to us; 30 or 40 *per cent.* seems nothing. Now this augmentation operates upon two

thirds, at least, of the whole expence of a labouring man: let any one who lives in tolerable affluence make the application of this to himself, and examine how he would manage his affairs if, by accidents of rains or winds, his expences were to rise 30 *per cent.* without a possibility of restraining them; for this is unfortunately the case with all the lower classes. From whence it may be concluded, that the keeping food cheap, and still more the preserving it at all times at an equal standard, is the fountain of the wealth of Holland; and that any hurtful competition in this article must beget a disorder which will affect the whole of the manufacturers of a state.

## C O M

**COMMUNATORY**, an appellation given to whatever threatens punishment, or some penalty.

**COMMUNITION**, denotes the breaking, or rather grinding, a body to very small particles.

**COMMISSARY**, in the ecclesiastical law, an officer of the bishop, who exercises spiritual jurisdiction in places of a diocese so far from the episcopal see, that the chancellor cannot call the people to the bishop's principal consistory court, without giving them too much inconvenience.

**COMMISSARY-court**, in Scots law, a court originally constituted by the bishops for executing in their name an usurped jurisdiction, and was anciently called the *bishops court, curia Christianitatis, or consistorial court*. This court was new-modelled by Queen Mary at the Reformation, and continues till this day. See **SCOTS LAW**, title, *Ecclesiastical persons*.

**COMMISSARY**, in a military sense, is of three sorts.

**COMMISSARY-general of the musters**, an officer appointed to muster the army, as often as the general thinks proper, in order to know the strength of each regiment and company, to receive and inspect the muster-rolls, and to keep an exact state of the strength of the army.

**COMMISSARY-general of stores**, an officer in the artillery, who has the charge of all the stores, for which he is accountable to the office of ordnance.

**COMMISSARY-general of provisions**, an officer who has the inspection of the bread and provisions of the army.

**COMMISSION**, in common-law, the warrant or letters-patent which all persons exercising jurisdiction have to empower them to hear or determine any cause or suit: as, the commission of the judges, &c.

**COMMISSION of bankruptcy**, is the commission that issues from the lord chancellor, on a person's becoming a bankrupt within any of the statutes, directed to certain commissioners appointed to examine into it, and to secure the bankrupt's lands and effects for the satisfaction of his creditors.

**COMMISSION of lunacy** issues out of the court of chancery, to inquire whether a person represented to be a lunatic be so or not.

**COMMISSION**, in commerce. See **FACTORAGE**.

**COMMISSIONER**, a person authorised by commission,

letters-patent, or other lawful warrant, to examine any matters, or execute any public office, &c.

Besides those relating to judicial proceedings, there are

**COMMISSIONERS of the customs**. See **CUSTOMS**.

**COMMISSIONERS of excise**. See **EXCISE**.

**COMMISSIONERS of the navy**. See **NAVY**.

**Lords COMMISSIONERS of the treasury**. See **TREASURY** and **EXCHEQUER**.

**COMMITTEE**, one or more persons, to whom the consideration or ordering of a matter is referred, either by some court, or by the consent of parties, to whom it belongs.

**COMMITTEE of parliament**, a certain number of members appointed by the house, for the examination of a bill, making a report of an inquiry, process of the house, &c.

When a parliament is called, and the speaker and members have taken the oaths, there are committees appointed to sit on certain days, *viz.* the committee of privileges and elections, of religion, of trade, &c. which are standing committees.

Sometimes the whole house resolves itself into a committee; on which occasion each person has a right to speak and reply as often as he pleases, which is not the case when a house is not in a committee.

**COMMIXTION**, in Scots law, is a method of acquiring property, by mixing or blending together different substances belonging to different proprietors. If this commixtion was made without the consent of the different proprietors, and the materials cannot again be disjoined, it draws after it the property of the materials. See **SCOTS LAW**, title, *Division of rights*.

**COMMODATE**, in Scots law, is a gratuitous loan, wherein the property of the thing but continues with the lender, and only the use of it given to the borrower, who must restore the individual thing borrowed. See **SCOTS LAW**, title, *Obligations and contracts in general*.

**COMMODITY**, in a general sense, denotes all sorts of wares and merchandizes whatsoever that a person deals or trades in.

**Staple COMMODITIES**, such wares and merchandizes as are

are commonly and readily sold in a market, or exported abroad : being, for the most part, the proper produce or manufacture of the country.

**COMMODORE**, in maritime affairs, an officer of the British navy, commissioned by the lords of the admiralty, or by an admiral, to command a Squadron of men of war in chief.

**COMMON**, something that belongs to all alike, in contradistinction to proper, peculiar, &c.

**COMMON COUNCIL**. **COUNCIL**.

**COMMON LAW**, that body of rules received as law in England, before any statute was enacted in parliament to alter the same. See **LAW**.

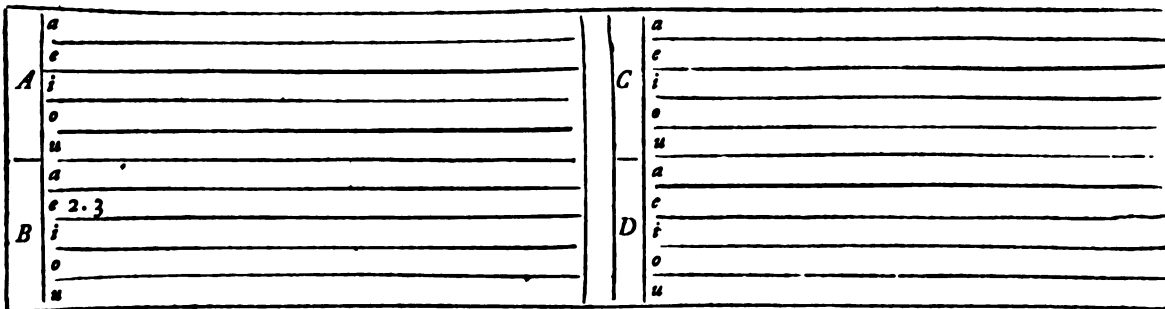
**COMMON-PLACE BOOK**, is a register of what things occur, worthy to be noted, in the course of a man's thinking or study, so disposed, as that, among a number of subjects, any one may be easily found. The advantages of making a common-place book are many: it not only makes a man read with accuracy and attention, but induces him insensibly to think for himself, provided he considers it not so much as a register of sentiments that strike him in the course of reading, but as a register of his own thoughts upon various subjects. Many valuable thoughts occur even to men of no extraordinary genius. These, without the assistance of a common place-book, are generally lost

both to himself and others. There are various methods of arranging common-place books; that of Mr Locke is as good as any that have hitherto been contrived.

The first page of the book you intend to take down their *common-place* in, is to serve as a kind of index to the whole; and to contain references to every place or matter therein: in the commodious contrivance of which index, so as it may admit of a sufficient copia or variety of materials, without any confusion, all the secret of the method consists.

In order to this, the first page, as already mentioned, or, for more room, the two first pages that front each other, are to be divided, by parallel lines, into 25 equal parts; whereof, every fifth line to be distinguished, by its colour or other circumstance. These lines are to be cut perpendicularly by others, drawn from top to bottom; and in the several spaces thereof, the several letters of the alphabet, both capital and minuscule, are to be duly wrote.

The form of the lines and divisions, both horizontal and perpendicular, with the manner of writing the letters therein, will be conceived from the following specimen; wherein, what is to be done in the book for all the letters of the alphabet, is here shewn in the first four, *A, B, C, and D.*



The index of the *common-place* book thus formed, matters are ready for the taking down any thing therein.

In order to this, consider to what head the thing you would enter is most naturally referred; and under which one would be led to look for such a thing: in this head, or word, regard is had to the initial letter, and the first vowel that follows it; which are the characteristic letters whereon all the use of the index depends.

Suppose, (*e. gr.*) I would enter down a passage that refers to the head *Beauty*; *B*, I consider, is the initial letter; and *e* the first vowel: then, looking upon the index for the partition *B*, and therein the line *e*, (which is the place for all words whose first letter is *B*, and first vowel *e*; as *Beauty*, *Benevolence*, *Bread*, *Breeding*, *Blemishes*,) and finding no numbers already down to direct me to any page of the the book where words of this characteristic have been entered, I turn forward to the first blank page I find,

which, in a fresh book, as this is supposed to be, will be page 2, and here write what I have occasion for on the head *Beauty*; beginning the head in the margin, and indenting all the other subservient lines, that the head may stand out and shew itself: this done, I enter the page where it is wrote, *viz.* 2, in the index, in the space, *Be*; from which time, the class *Be* becomes wholly in possession of the 2d and 3d pages, which are consigned to letters of this characteristic.

Had I found any page or number already entered in the space *Be*, I must have turned to the page, and have wrote my matter in what room was left therein: so, if after entering the passage on beauty, I should have occasion for *benevolence*, or the like, finding the number 2 already possessed of the space of this characteristic, I begin the passage on benevolence in the remainder of the page, which not containing the whole, I carry it on to page 3, which is also for *Be*; and add the number 3 in the index.

**COMMON PLEAS** is one of the king's courts now held constantly

constantly in Westminster hall, but in former times was moveable.

All civil causes, as well real as personal, are, or were formerly, tried in this court, according to the strict law of the land. In personal and mixed actions it has a concurrent jurisdiction with the king's bench, but has no cognizance of pleas of the crown. The actions belonging to the court of common pleas come thither by original, as arrests and outlawries; or by privilege, or attachment for or against privileged persons; or out of inferior courts, not of record, by *pone*, *recordari*, *accedas ad curiam*, writ of false judgment, &c. The chief judge of this court is called lord chief justice of the common pleas, who is assisted by three other judges: the other officers of the court are the *custos breviarum*, who is the chief clerk; three prothonotaries, and their secondaries; the clerk of the warrants, clerk of the effoins, fourteen filazers, four exigentors, a clerk of the juries, the chirographer, the clerk of the king's silver, clerk of the treasury, clerk of the seal, clerk of the outlawries, clerk of the enrolment of fines and recoveries, and clerk of the errors.

**COMMON**, in law, that soil, the use of which is common to this or that town or lordship. There is common of pasture for cattle, and also common of fishing, common of estovers, common of turbary, &c.

**COMMON PRAYER** is the liturgy in the church of England. Clergymen are to use the public form of prayers prescribed by the Book of Common Prayer; and refusing to do so, or using any other public prayers, are punishable by 1 Eliz. c. ii.

**COMMON**, in grammar, denotes the gender of nouns, which are equally applicable to both sexes: thus *parents*, a parent, is of the common gender.

**COMMON**, in geometry, is applied to an angle, line, or the like, which belongs equally to two figures.

**COMMON DIVISOR**, a quantity or number which exactly divides two or more other quantities or numbers, without leaving any remainder.

**COMMONER**, or **GENTLEMAN COMMONER**, in the universities, a student entered in a certain rank.

**COMMONS**, or **HOUSE OF COMMONS** a denomination given to the lower house of parliament. See **PARLIAMENT**.

**COMMONS**, or **COMMONALTY**, likewise signifies the whole body of the people under the degree of a baron, whether knights, gentlemen, burgesses, yeomen, &c.

**Doctors COMMONS**, See **COLLEGE of civilians**.

**Proctor of the COMMONS**. See **PROCTOR**.

**COMMONTY**, in Scots law, sometimes signifies lands belonging to two or more common proprietors; sometimes a heath or muir though it should belong in property to one, if there has been a promiscuous possession upon it by pasturage; and the act 1695 mentions *commonities* belonging in property to the king and to royal burroughs. See title, *Obligations arising from consent*.

**COMMONWEALTH**. See **REPUBLIC**.

**COMMUNICATION**, in a general sense, the act of imparting something to another.

**COMMUNICATION** is also used for the connection of one

thing with another, or the passage from one place to another: thus a gallery is a communication between two apartments.

**COMMUNICATION of idioms**, in theology, the act of imparting the attributes of one of the natures in Jesus Christ to the other.

**COMMUNICATION of motion**, the act whereby a body at rest is put into motion by a moving body; or, it is the acceleration of motion in a body already moving. See **MECHANICS**,

*Lines of COMMUNICATION*, in military matters, trenches made to continue and preserve a safe correspondence between two forts or posts; or at a siege, between two approaches, that they may relieve one another.

**COMMUNION**, in matters of religion, the being united in doctrine and discipline; in which sense of the word, different churches are said to hold communion with each other.

In the primitive christian church, every bishop was obliged, after his ordination, to send circular letters to foreign churches, to signify that he was in communion with them. The three grand communions into which the Christian church is at present divided, is that of the church of Rome, the Greek church, and the Protestant church: but originally all Christians were in communion with each other, having one common faith and discipline.

**COMMUNION** is also used for the act of communicating in the sacrament of the eucharist, or the Lord's supper. See **RELIGION**.

**COMMUNION SERVICE**, in the liturgy of the church of England, the office for the administration of the holy sacrament, extracted from several ancient liturgies, as those of St Basil, St Ambrose, &c.

By the last rubric, part of this service is appointed to be read every Sunday and holyday, after the morning prayer, even though there be no communicants.

**COMMUNITY**, a society of men living in the same place, under the same laws, the same regulations, and the same customs.

**COMMUTATION**, in law, the change of a penalty or punishment from a greater to a less; as when death is commuted for banishment, &c.

**COMORIN**, or **CAPE COMORIN**, the most southerly promontory of the hither India, lying north-west of the island of Ceylon.

**COMPACT**, in physiology, is said of bodies which are of a close, dense, and heavy texture, with few pores, and very small.

**COMPANY**, in a commercial sense, is a society of merchants, mechanics, or other traders, joined together in one common interest.

When there are only two or three joined in this manner, it is called a partnership; the term *company* being restrained to societies consisting of a considerable number of members, associated together by a charter obtained from the prince.

The mechanics of all corporations, or towns incorporated, are thus erected into companies, which have charters of privileges and large immunities.

We

We shall here give some account of the principal companies of merchants, some of which trade with joint stocks, and all of them enjoy by charter many exclusive privileges: for however injurious these companies may, at this time of day, be reckoned to the nation in general, yet it is certain, that they were the original parents of all our foreign commerce: private traders upon their own bottom being discouraged from hazarding their fortunes in foreign countries, till the methods of traffic had been settled by joint-stock companies: and from this very principle it is, that we find several nations at present endeavouring to extend their trade by the same means. The most ancient trading company, in Britain, is the Hamburgh company, originally called merchants of the staple, and afterwards merchant-adventurers: they were incorporated by king Edward IV. from which time they traded with success till the reign of queen Elizabeth, who, for a farther encouragement of their industry, not only confirmed, but enlarged their privileges. However, it ought to be observed, that this trade is now open to private merchants, upon paying a very small sum to the company. The company of this kind, next incorporated, was that of the Russia-merchants; who having improved their trade and commerce in those remote parts, were incorporated by Edward VI. greatly encouraged by queen Mary, and had their confirmation, with an enlargement of their privileges, from Elizabeth. This company is not very considerable at present; the trade of those parts being mostly carried on by private merchants, on paying the sum of 5*l.* to the company.

The Eastland-company, formerly called merchants of Elbin, were incorporated by queen Elizabeth, and by her greatly encouraged; but, like the former company, it is now become inconsiderable, the trade of Norway and Sweden being laid open by act of parliament.

The Turkey, or Levant-company, was likewise incorporated by the same princess, and its charter confirmed and enlarged by king James I. who impowered them to trade to the Levant, or eastern parts of the Mediterranean; particularly to Smyrna, Aleppo, Alexandria, Grand-Cairo, and the other parts of the Turkish dominions. But this trade is now also laid open to private merchants, upon paying a small consideration.

The next in order is the East-India company, first incorporated in the year 1600, and impowered to trade to all countries lying eastward of the cape of Good Hope. Towards the end of king William's reign, an act of parliament passed, granting all private merchants, who should raise a certain sum for the supply of the government, the privilege of trading to these parts. Accordingly, a great many subscribed, and were called the new East-India-company; which soon found it necessary to unite with the old one, and trade with one joint stock: since which time, they have been styled the united East-India-company; and are at present in a flourishing condition, and in possession of many considerable forts and factories on the coast of

Malabar, the Coromandel-coast, the bay of Bengal, &c.

The royal African-company was first erected in the year 1661, with an exclusive privilege to trade from cape Blanc, on the coast of Africa, in 20° N. lat. as far as the cape of Good Hope. But this trade is now laid open by act of parliament.

The Eastland-company, the Greenland-company, the Hudson's-bay company, the South-sea-company, have likewise their several charters and privileges for trading to the places from which they take their denominations.

These are the principal trading company's belonging to the crown of Great Britain; and of a similar nature are the Dutch East and West India companies, the French East and West India companies, &c.

Concerning these companies, it may be proper to remark, that however necessary they might be in the infancy of trade, they are now looked upon by most men in the light of monopolies: hence it is, that their privileges have from time to time been lessened, in order to establish an absolutely free and general trade; and experience hath shewn, that the trade of the nation has advanced in proportion as monopolies have been laid aside. Indeed, to carry on trade with distant countries, where forces and forts are to be maintained, a company with a joint stock seems necessary; or, at least, certain duties ought to be paid by all who trade thither, towards defraying the said expenses: for not to speak of the East-India, Hudson's bay, &c. companies, the expence of maintaining whose forts must be very considerable, even the Turkey, Hamburgh, Muscovy, and Eastland companies, which do not trade with a joint stock, are nevertheless obliged to be at considerable charges, in making presents to the grand seignior and his ministers, maintaining consuls, &c. It would therefore be injustice that any should trade to the places within their charters, without paying the same duties towards the company's charge, as the present adventurers pay; but then there appears to be no reason why any of the king's subjects should be barred from trading to those places, or forced to pay a great fine for admission, that are willing to pay the company's duties, and submit to their regulations and orders in other respects.

On the whole, as all restrictions of trade are found to be hurtful, nothing can be more evident than that no company whatsoever, whether they trade in a joint stock, or only under regulation, can be for the public good, except it may be easy for all or any of his majesty's subjects to be admitted into all or any of the said companies, at any time, and for a very inconsiderable fine.

COMPANY, in military affairs, a small body of foot, commanded by a captain, who has under him a lieutenant and ensign.

The number of centinels or private soldiers in a company, may be from 50 to 80; and a battalion consists of thirteen such companies, one of which is always grenadiers, and posted on the right: next them stand the eldest company, and on the left the second company;

the youngest one being always posted in the centre.

Companies not incorporated into regiments are called irregulars, or independent companies.

*Artillery Company.* See ARTILLERY.

*COMPANY of Ships.* a fleet of merchantmen, who make a charter party among themselves; the principal conditions whereof usually are, that certain vessels shall be acknowledged admiral, vice-admiral, and rear-admiral; that such and such signals shall be observed; that those which bear no guns, shall pay so much *per cent.* of their cargo; and in case they be attacked, that what damages are sustained, shall be reimbursed by the company in general. In the Mediterranean, such companies are called *conserves*.

*COMPARATIVE ANATOMY,* is that branch of anatomy which considers the secondary objects, or the bodies of other animals; serving for the more accurate distinctions of several parts, and supplying the defect of human subjects.

It is otherwise called the anatomy of beasts, and sometimes *zootomy*; and stands in contradistinction to human anatomy, or that branch of the art which considers the human body, the primary object of anatomy. See ANATOMY.

*COMPARATIVE DEGREE,* among grammarians, that between the positive and superlative degrees, expressing any particular quality above or beneath the level of another.

*COMPARISON,* in a general sense, the consideration of the relation between two persons or things, when opposed and set against each other, by which we judge of their agreement or difference.

Instruction is the principal, but not the only end of comparison. It may be employed with success in putting a subject in a strong point of view. A lively idea is formed of a man's courage by likening it to that of a lion; and eloquence is exalted in our imagination by comparing it to a river overflowing its bank, and involving all in its impetuous course. The same effect is produced by contrast: A man in prosperity becomes more sensible of his happiness, by comparing his condition with that of a person in want of bread. Thus comparison is subservient to poetry as well as to philosophy.

Comparisons serve two purposes: when addressed to the understanding, their purpose is to instruct; when to the heart, their purpose is to please. Various means contribute to the latter: first, the suggesting some unusual resemblance or contrast; second, the setting an object in the strongest light; third, the associating an object with others that are agreeable; fourth, the elevating an object; and, fifth, the depressing it. And that comparisons may give pleasure by these various means, will be made evident by examples, which shall be given, after premising some general observations.

Objects of different senses cannot be compared together; for such objects are totally separated from each other, and have no circumstance in common to admit either resemblance or contrast. Objects of hearing may be compared together, as also of taste, of

smell, and of touch: but the chief fund of comparison are objects of sight; because, in writing or speaking, things can only be compared in idea; and the ideas of sight are more distinct and lively than those of any other sense.

When a nation emerging out of barbarity begins to think of the fine arts, the beauties of language cannot long lie concealed; and when discovered, they are generally, by the force of novelty, carried beyond all bounds of moderation. Thus, in the earliest poems of every nation, we find metaphors and similes founded on the slightest and most distant resemblances, which, losing their grace with their novelty, wear gradually out of repute; and now, by the improvement of taste, no metaphor nor simile is admitted into any polite composition but of the most striking kind. To illustrate this observation, a specimen shall be given afterward of such metaphors as we have been describing: with respect to similes take the following specimen.

“Behold, thou art fair, my love: thy hair is as a  
“flock of goats that appear from Mount Gilead; thy  
“teeth are like a flock of sheep from the washing, e-  
“very one bearing twins: thy lips are like a thread  
“of scarlet: thy neck like the tower of David built  
“for an armoury, whereon hang a thousand shields of  
“mighty men: thy two breasts like two young roes  
“that are twins, which feed among the lilies: thy  
“eyes like the fish-pools in Heshbon, by the gate of  
“Bath-rabbin: thy nose like the tower of Lebanon,  
“looking toward Damascus.” *Song of Solomon.*  
“Thou art like snow on the heath; thy hair like  
“the mist of Cromla, when it curls on the rocks and  
“shines to the beam of the west: thy breasts are like  
“two smooth rocks seen from Branno of the streams:  
“thy arms like two white pillars in the hall of the  
“mighty Fingal.” *Fingal.*

It has no good effect to compare things by way of simile that are of the same kind; nor to contrast things of different kinds.

A numerous brigade hasten'd: as when bands  
Of pioneers with spade and pick-ax arm'd,  
Forcru the royal camp to trench a field  
Or call a rampart.

*Milton.*

The following is of things contrasted that are of different kinds.

*Queen.* What, is my Richard both in shape and  
mind  
Transform'd and weak? Hath Bolingbroke depos'd  
Thine intellect? Hath he been in thy heart?  
The lion, dying, thrusteth forth his paw,  
And wounds the earth, if nothing else, with rage  
To be o'erpower'd: and wilt thou, pupil like,  
Take thy correction mildly, kiss the rod,  
And fawn on rage with base humility?

*Richard II. act 5. sc. 1.*

This comparison has scarce any force: a man and a lion are of different species, and therefore are proper subjects for a simile; but there is no such resemblance between them in general, as to produce any strong effect by contrasting particular attributes or circumstances.

A third general observation is, That abstract terms

can

can never be the subject of comparison, otherwise than by being personified. Shakespear compares adversity to a toad, and slander to the bite of a crocodile; but in such comparisons these abstract terms must be imagined sensible beings.

To have a just notion of comparisons, they must be distinguished into two kinds; one common and familiar, as where a man is compared to a lion in courage, or to a horse in speed; the other more distant and refined, where two things that have in themselves no resemblance or opposition, are compared with respect to their effects. There is no resemblance between a flower-plot and a cheerful song; and yet they may be compared with respect to their effects, the emotions they produce in the mind being extremely similar. There is as little resemblance between fraternal concord and precious ointment; and yet observe how successfully they are compared with respect to the impressions they make.

“ Behold, how good and how pleasant it is for  
“ brethren to dwell together in unity. It is like the  
“ precious ointment upon the head, that ran down  
“ upon Aaron’s beard, and descended to the skirts of  
“ his garment.” *Psalms 133.*

For illustrating this sort of comparison, we shall add some more examples:

“ Delightful is thy presence, O Fingal! it is like  
“ the sun on Cromla, when the hunter mourns his  
“ absence for a season, and sees him between the  
“ clouds.

“ Did not Ossian hear a voice? or is it the sound  
“ of days that are no more? Often, like the even-  
“ ing-sun, comes the memory of former times on my  
“ soul.

“ His countenance is settled from war; and is calm  
“ as the evening-beam, that from the cloud of the  
“ west looks on Cona’s silent vale.” *Fingal.*

We now proceed to illustrate by particular instances the different means by which comparisons, whether of the one sort or the other, can afford pleasure; and, in the order above established, we shall begin with such instances as are agreeable by suggesting some unusual resemblance or contrast.

Sweet are the uses of Adversity,  
Which, like the toad, ugly and venomous,  
Wears yet a precious jewel in her head.

*As you like it, act 2. sc. 1.*

See, how the Morning opes her golden gates,  
And takes her farewell of the glorious sun;  
How well resembles it the prime of youth,  
Trim’d like a yonker prancing to his love.

*Second Part Henry VI. act 2. sc. 3.*

Thus they their doubtful consultations dark  
Ended, rejoicing in their matchless chief:  
As when from mountain tops, the dusky clouds  
Ascending, while the North-wind sleeps, o’erspread  
Heav’n’s cheerful face, the lowering element  
Scowls o’er the darken’d landscape, snow, and shower;  
If chance the radiant sun with farewell sweet  
Extends his ev’ning-beam, the fields revive,

The birds their notes renew, and bleating herds  
Attest their joy, that hill and valley rings.

*Paradise Lost, book 2.*

None of the foregoing similes tend to illustrate the principal subject: and therefore the chief pleasure they afford must arise from suggesting resemblances that are not obvious: for undoubtedly a beautiful subject introduced to form the simile affords a separate pleasure, which is felt in the similes mentioned, particularly in that cited from Milton.

The next effect of a comparison in the order mentioned, is to place an object in a strong point of view; which effect is remarkable in the following similes.

As when two scales are charg’d with doubtful loads,  
From side to side the trembling balance nods,  
(While some laborious matron, just and poor,  
With nice exactness weighs her woolly store),  
Till pois’d aloft, the resting beam suspends  
Each equal weight; nor this nor that descends:  
So stood the war, till Hector’s matchless might,  
With fates prevailing, turn’d the scale of fight.  
Fierce as a whirlwind up the wall he flies,  
And fires his host with loud repeated cries.

*Iliad, b. xii. 521.*

——— Out, out, brief candle!  
Life’s but a walking shadow, a poor player,  
That struts and frets his hour upon the stage,  
And then is heard no more.

*Macbeth, act 5. sc. 5.*

O thou Goddess,  
Thou divine nature! how thyself thou blazon’st  
In these two princely boys! they are as gentle  
As zephyrs blowing below the violet,  
Not wagging his sweet head; and yet as rough,  
(Their royal blood inchas’d) as the rud’st wind,  
That by the top doth take the mountain-pine,  
And make him stoop to th’ vale.

*Cymbeline, act 4. sc. 4.*

“ Why did not I pass away in secret, like the  
“ flower of the rock that lifts its fair head unseen,  
“ and strows its withered leaves on the blast?”

*Fingal.*

As words convey but a faint and obscure notion of great numbers, a poet, to give a lively notion of the object he describes with regard to number, does well to compare it to what is familiar and commonly known. Thus Homer compares the Grecian army in point of number to a swarm of bees: in another passage he compares it to that profusion of leaves and flowers which appear in the spring, or of insects in a summer’s evening: and Milton,

——— As when the potent rod  
Of Amram’s son in Egypt’s evil day  
Wav’d round the coast, up call’d a pitchy cloud  
Of locusts, warping on the eastern wind,  
That o’er the realm of impious Pharaoh hung  
Like night, and darken’d all the land of Nile:  
So numberless were those bad angels seen,  
Hov’ring on wing under the cope of hell,  
Twixt upper, nether, and surrounding fires.

*Paradise Lost, book 1.*

*Such.*

Such comparisons have, by some writers, been condemned for the lowness of the images introduced: but surely without reason; for, with regard to numbers, they put the principal subject in a strong light.

Milton has a peculiar talent in embellishing the principal subject by associating it with others that are agreeable; which is the third end of a comparison. Similes of this kind have, beside, a separate effect: they diversify the narration by new images that are not strictly necessary to the comparison: they are short episodes, which, without drawing us from the principal subject, afford great delight by their beauty and variety.

He scarce had ceas'd, when the superior fiend  
Was moving toward the shore; his pond'rous shield,  
Ethereal temper, massy, large, and round,  
Behind him cast; the broad circumference  
Hung on his shoulders like the moon, whose orb  
Through optic glass the Tuscan artist views  
At evening from the top of Fesole,  
Or in Valdarno, to descry new lands,  
Rivers, or mountains, in her spotty globe.

*Milton, b. 1.*

As when a vulture on Imaus bred,  
Whose snowy ridge the roving Tartar bounds,  
Dislodging from a region scarce of prey  
To gorge the flesh of lambs, or yearling kids,  
On hills where flocks are fed, flies toward the springs  
Of Ganges or Hydaspes, Indian streams,  
But in his way lights on the barren plains  
Of Sericana, where Chineses drive  
With sails and wind their cany waggons light:  
So on this windy sea of land, the fiend  
Walk'd up and down alone, bent on his prey.

*Milton, b. 3.*

Next of comparisons that aggrandise or elevate. These affect us more than any other sort: the reason of which will be evident from the following instances.

As when a flame the winding valley fills,  
And runs on crackling shrubs between the hills,  
Then o'er the stubble up the mountain flies,  
Fires the high woods, and blazes to the skies,  
This way and that, the spreading torrent roars;  
So sweeps the hero through the wasted shores.  
Around him wide, immense destruction pours,  
And earth is delug'd with the sanguine show'rs.

*Iliad xx. 569.*

Methinks, King Richard and myself should meet  
With no less terror than the elements  
Of fire and water, when their thund'ring shock,  
At meeting tears the cloudy cheeks of heaven.

*Richard II. act 3. sc. 5.*

“As rusheth a foamy stream from the dark shady  
“steep of Cromla, when thunder is rolling above,  
“and dark brown night rests on the hill: so fierce,  
“so vast, so terrible, rush forward the sons of Erin.  
“The chief, like a whale of Ocean followed by all  
“its billows, pours valour forth as a stream, rolling  
“its might along the shore.”

*Fingal, b. 1.*

The last article mentioned, is that of lessening or depressing a hated or disagreeable object; which is effectually done by resembling it to any thing low or despicable.

Thus Milton, in his description of the rout of the rebel-angels, happily expresses their terror and dismay in the following simile:

As a herd  
Of goats or timorous flock together throng'd,  
Drove them before him thunder-struck, pursu'd  
With terrors and with furies to the bounds  
And crystal wall of heav'n, which op'ning wide,  
Rowl'd inward, and a spacious gap disclos'd  
Into the wasteful deep; the monitrous fight  
Strook them with horror backward, but far worse  
Urg'd them behind; headlong themselves they threw  
Down from the verge of Heav'n.

*Milton, b. 6.*

By this time the different purposes of comparison, and the various impressions it makes on the mind, are sufficiently illustrated by proper examples. This was an easy work. It is more difficult to lay down rules about the propriety or impropriety of comparisons; in what circumstances they may be introduced, and in what circumstances they are out of place. It is evident, that a comparison is not proper upon every occasion: a man in his cool and sedate moments, is not disposed to poetical flights, nor to sacrifice truth and reality to the delusive operations of the imagination: far less is he so disposed, when oppressed with care, or interested in some important transaction that occupies him totally. On the other hand, it is observable, that a man, when elevated or animated by any passion, is disposed to elevate or animate all his subjects: he avoids familiar names, exalts objects by circumlocution and metaphor, and gives even life and voluntary action to inanimate beings. In this warmth of mind, the highest poetical flights are indulged, and the boldest similes and metaphors relished. But without soaring so high, the mind is frequently in a tone to relish chaste and moderate ornament; such as comparisons that set the principal object in a strong point of view, or that embellish and diversify the narration. In general, when by any animating passion, whether pleasant or painful, an impulse is given to the imagination; we are in that condition disposed to every sort of figurative expression, and in particular to comparisons. This in a great measure is evident from the comparisons already mentioned; and shall be further illustrated by other instances. Love, for example, in its infancy, rousing the imagination, prompts the heart to display itself in figurative language, and in similes:

*Troilus.* Tell me, Apollo, for thy Daphne's love,  
What Cressid is, what Pandar, and what we?  
Her bed is India, there she lies, a pearl:  
Between our Ilium, and where she resides,  
Let it be call'd the wild and wandering flood;  
Ourself the merchant, and this sailing Pandar  
Our doubtful hope, our convoy, and our bark.

*Troilus and Cressida, act 1. sc. 1.*

Again:

Come, gentle Night; come, loving black-brow'd  
Night!

Give me my Romeo; and, when he shall die,  
Take him, and cut him out in little stars,  
And he will make the face of heav'n so fine,

That



That all the world shall be in love with Night,  
And pay no worship to the garish sun.

*Romco and Juliet, act 3. sc. 4.*

But it will be a better illustration of the present head, to give examples where comparisons are improperly introduced. Similes are not the language of a man in his ordinary state of mind, dispatching his daily and usual work: for that reason, the following speech of a gardener to his servant, is extremely improper:

Go bind thou up yon dangling spricocks,  
Which, like unruly children, make their sire  
Stoop with oppression of their prodigal weight:  
Give some supportance to the bending twigs.  
Go thou, and, like an executioner,  
Cut off the heads of too-fast-growing sprays,  
That look too lofty in our commonwealth:  
All must be even in our government.

*Richard II. act 3. sc. 7.*

The fertility of Shakespear's vein betrays him frequently into this error.

Rooted grief, deep anguish, terror, remorse, despair, and all the severe dispiriting passions, are declared enemies, perhaps not to figurative language in general, but undoubtedly to the pomp and solemnity of comparison. Upon this account, the simile pronounced by young Rutland, under terror of death from an inveterate enemy, and praying mercy, is unnatural:

So looks the pent-up lion o'er the wretch  
That trembles under his devouring paws;  
And so he walks insulting o'er his prey,  
And so he comes to rend his limbs asunder.  
Ah, gentle Clifford, kill me with thy sword,  
And not with such a cruel threat'ning look.

*Third part Henry VI. act 1. sc. 5.*

A man spent and dispirited after losing a battle, is not disposed to heighten or illustrate his discourse by similes.

*York.* With this we charg'd again; but out! alas,  
We bodg'd again; as I have seen a swan  
With bootless labour swim against the tide,  
And spend her strength with over-matching waves.  
Ah! hark, the fatal followers do pursue;  
And I am faint and cannot fly their fury.  
The sands are number'd that make up my life;  
Here must I stay, and here my life must end.

*Third part Henry VI. act 1. sc. 6.*

Similes thus unseasonably introduced, are finely ridiculed in the *Rehearsal*.

"*Bayes.* Now here she must make a simile.

"*Smith.* Where's the necessity of that, Mr Bayes?

"*Bayes.* Because she's surprized; that's a general rule; you must ever make a simile when you are surprized; 'tis a new way of writing."

A comparison is not always faultless even where it is properly introduced. A comparison, like other human productions, may fall short of its end; of which defect instances are not rare even among good writers: and to complete the present subject, it will be necessary to make some observations upon such faulty comparisons. Nothing can be more erroneous than to institute a comparison too faint: a distant resemblance or contrast fa-

tigues the mind with its obscurity, instead of amusing it; and tends not to fulfil any one end of a comparison. The following similes seem to labour under this defect.

*K. Rich.* Give me the crown.—Here, cousin,  
seize the crown,

Here, on this side, my hand; on that side, thine.  
Now is this golden crown like a deep well,  
That owes two buckets, filling one another;  
The emptier ever dancing in the air,  
The other down, unseem and full of water;  
That bucket down, and full of tears, am I,  
Drinking my griefs, whilst thou mount up on high.

*Richard II. act 4. sc. 3.*

*K. John.* Oh! cousin, thou art come to set mine eye;

The tackle of my heart is crack'd and burnt;  
And all the shrouds wherewith my life should sail,  
Are turned to one thread, one little hair:  
My heart hath one poor string to stay it by,  
Which holds but till thy news be uttered.

*King John, act 5. sc. 10.*

*York.* My uncles both are slain in rescuing me:  
And all my followers to the eager foe  
Turn back, and fly like ships before the wind,  
Or lambs pursu'd by hunger-starved wolves.

*Third part Henry VI. act 1. sc. 6.*

The latter of the two similes is good: the former, because of the faintness of the resemblance, produces no good effect, and crowds the narration with an useless image.

In an epic poem, or in any elevated subject, a writer ought to avoid raising a simile upon a low image, which never fails to bring down the principal subject. In general, it is a rule, that a grand object ought never to be resembled to one that is diminutive, however delicate the resemblance may be: for it is the peculiar character of a grand object to fix the attention, and swell the mind; in which state, it is disagreeable to contract the mind to a minute object, however elegant. The resembling an object to one that is greater, has, on the contrary, a good effect, by raising or swelling the mind: for one passes with satisfaction from a small to a great object; but cannot be drawn down, without reluctance, from great to small. Hence the following similes are faulty.

Meanwhile the troops beneath Patroclus' care,  
Invade the Trojans, and commence the war.  
As wasps, provok'd by children in their play,  
Pour from their mansions by the broad highway,  
In swarms the guiltless traveller engage,  
Whet all their stings, and call forth all their rage;  
All rise in arms, and with a general cry  
Assert their waxen domes and buzzing progeny:  
Thus from the tents the fervent legion swarms,  
So loud their clamours, and so keen their arms.

*Iliad, xvi. 312.*

So burns the vengeful hornet (foul all o'er)  
Repuls'd in vain, and thirsty still of gore;  
(Hold son of air and heat) on angry wings  
Untam'd, untir'd, he turns, attacks, and stings.

Fir'd with like ardour, fierce Atrides flew,  
And sent his soul with ev'ry lance he threw.

*Iliad*, xvii. 642.

An error opposite to the former, is the introducing a resembling image, so elevated or great as to bear no proportion to the principal subject. Their remarkable disparity, being the most striking circumstance, seizes the mind, and never fails to depress the principal subject by contrast, instead of raising it by resemblance: and if the disparity be exceeding great, the simile takes on an air of burlesque; nothing being more ridiculous than to force an object out of its proper rank in nature, by equalling it with one greatly superior or greatly inferior. This will be evident from the following comparison.

Loud as a bull makes hill and valley ring,  
So roar'd the lock when it releas'd the spring.

*Odyssey*, xxi. 51.

Such a simile upon the simplest of all actions, that of opening a lock, is pure burlesque.

A writer of delicacy will avoid drawing his comparisons from any image that is nauseous, ugly, or remarkably disagreeable; for however strong the resemblance may be, more will be lost than gained by such comparison. Therefore we cannot help condemning, though with some reluctance, the following simile, or rather metaphor.

O thou fond many! with what loud applause  
Did'st thou beat heav'n with blessing Bolingbroke  
Before he was what thou would'st have him be?  
And now being trimm'd up in thine own desires,  
Thou, beastly feeder, art so full of him,  
That thou provok'st thyself to cast him up.  
And so, thou common dog, didst thou disgorge  
Thy glutton bosom of the royal Richard,  
And now thou would'st eat thy dead vomit up,  
And howl'st to find it.

*Second part Henry IV. act 1. sc. 6.*

The strongest objection that can lie against a comparison is, that it consists in words only, not in sense. Such false coin, or bastard wit, does extremely well in burlesque; but is far below the dignity of the epic, or of any serious composition:

The noble sister of Poplicola,  
The moon of Rome; chaste as the icicle  
That's curdled by the frost from purest snow,  
And hangs on Dian's temple.

*Coriolanus, act 5. sc. 3.*

There is evidently no resemblance between an icicle, and a woman, chaste or unchaste: but chastity is cold in a metaphorical sense, and an icicle is cold in a proper sense; and this verbal resemblance, in the hurry and glow of composing, has been thought a sufficient foundation for the simile. Such phantom similes are mere witticisms, which ought to have no quarter, except where purposefully introduced to provoke laughter. Lucian, in his dissertation upon history, talking of a certain author, makes the following comparison, which is verbal merely.

"This author's descriptions are so cold, that they  
"surpass the Caspian snow, and all the ice of the  
"north."

—But for their spirits and souls  
This word *rebellion* had froze them up  
As fish are in a pond.

*Second part Henry IV. act 1. sc. 3.*

Pope has several similes of the same stamp.  
And hence one master passion in the breast,  
Like Aaron's serpent swallows up the rest.

*Epist. 2. l. 131.*

And again, talking of this same ruling or master passion:  
Nature its mother, Habit is its nurse;  
Wit, spirit, faculties, but make it worse;  
Reason itself but gives it edge and pow'r;  
As heav'n's blest'd beam turns vinegar more sour.

*Ibid. l. 145.*

Where the subject is burlesque or ludicrous, such similes are far from being improper. Horace says pleasantly,

*Quamquam tu levior cortice.* L. 3. od. 9.

And Shakespear,

In breaking oaths he's stronger than Hercules.

And this leads to observe, that besides the foregoing comparisons, which are all serious, there is a species, the end and purpose of which is to excite gaiety or mirth. Take the following examples.

Falstaff, speaking to his page:

"I do here walk before thee, like a sow that hath  
"overwhelmed all her litter but one."

*Second part Henry IV. act 1. sc. 10.*

"I think he is not a pick-purse, nor a horse steal-  
"er; but for his verity in love, I do think him as  
"concave as a cover'd goblet, or a worm-eaten nut."

*As you like it, act 3. sc. 10.*

This sword a dagger had his page,  
That was but little for his age;  
And therefore waited on him so,  
As dwarfs upon knights-errant do.

*Hudibras, canto 1.*

"Books, like men, their authors, have but one  
"way of coming into the world; but there are ten  
"thousand to go out of it, and return no more."

*Tale of a Tub.*

"The most accomplished way of using books at  
"present is, to serve them as some do lords, learn  
"their titles, and then brag of their acquaintance."

*Ibid.*

"He does not consider, that sincerity in love is as  
"much out of fashion as sweet snuff; no body takes  
"it now."  
*Careless Husband.*

COMPARISON *of ideas*, that operation of the mind whereby it compares its ideas one with another, in regard of extent, degree, time, place, or any other circumstance, and is the ground of relations.

COMPARISON, in grammar, the inflection of the comparative degree.

COMPARTITION, in architecture, denotes the useful and graceful disposition of the whole ground-plot of an edifice, into rooms of office, and of reception or entertainment.

COMPARTMENT, in general, is a design composed of

of several different figures, disposed with symmetry, to adorn a parterre, a ceiling, &c.

A compartment of tiles, or bricks, is an arrangement of them, of different colours, and varnished, for the decoration of a building. Compartments, in gardening, are an assemblage of beds, plats, borders, walks, &c. disposed in the most advantageous manner that the ground will admit of. Compartments, in heraldry, are otherwise called partitions.

**COMPASS**, or *mariner's COMPASS*, an instrument whereby the ship's course is determined. See **NAVIGATION**.

*Azimuth COMPASS*. See **NAVIGATION**.

**COMPASS dials**, are small horizontal dials, fitted in brass or silver boxes, for the pocket, to shew the hour of the day, by the direction of a needle, that indicates how to place them right, by turning the dial about, till the cock or style stand directly over the needle, and point to the northward: but these can never be very exact, because of the variations of the needle itself. See **DIALING**.

**COMPASSES**, or *pair of COMPASSES*, a mathematical instrument for describing circles, measuring figures, &c.

The common compasses consist of two sharp-pointed branches, or legs, of iron, steel, brass, or other metal, joined at top by a rivet, whereon they move as on a centre.

The principal perfection of this, as of all other compasses, consists in the easy and uniform opening and shutting of their legs; one of which may be taken out, in order to make room for others.

There are now used compasses of various kinds and contrivances, accommodated to the various uses they are intended for.

**COMPEIGN**, a city of France, situated on the river Oyse, about forty-five miles north-east of Paris: E. long.  $3^{\circ}$ , N. lat.  $49^{\circ} 30'$ .

**COMPENDIUM**, in matters of literature, denotes much the same with epitome or abridgment. See **ABRIDGMENT**.

**COMPENSATION**, in a general sense, an action whereby any thing is admitted as an equivalent to another.

**COMPENSATION**. Where the same person is debtor and creditor to another, the mutual obligations, if they are for equal sums, are extinguished by compensation; if for unequal, the lesser obligation is extinguished, and the greater diminished, as far as the concurrence of debt and credit goes. See **SCOTS LAW**, title, *Extinction of obligations*.

**COMPETENCE**, or **COMPETENCY**, in law, the right or authority of a judge, for taking cognizance of any matter.

**COMPETITION**, in Scots law; In *escheats*, see title, *Casualties due to the superior*: In confirmations by the superior, in resignations, and in personal rights of lands, see title, *Of transmission of rights by confirmation*: In inhibitions, in adjudications, amongst assignees, arresters, and pinders, see title, *Inhibitions, adjudications, assignations, arrestments, and*

*poundings*: Amongst creditors of a defunct, see title, *Succession in moveables*.

**COMPITALIA**, or **COMPITALITIA**, in Roman antiquity, feasts instituted by Servius Tullius in honour of the Lares. See **LARES**.

These feasts were observed on the 12th of January, and 6th of March.

**COMPLEMENT**, in geometry, is what remains of a quadrant of a circle, or of  $90^{\circ}$ , after any certain arch has been taken away from it. Thus, if the arch taken away be  $40^{\circ}$ , its complement is  $50$ : because  $50+40=90$ . The sine of the complement of an arch is called the co-sine, and that of the tangent the co-tangent, &c.

**COMPLEX**, in a more general sense, a term synonymous with compound; though, in strictness of speech, there is some difference. See **COMPOUND**.

**COMPLEX terms**, or *ideas*, in logic, are such as are compounded of several simple ones. See **TERM**, and **IDEA**.

**COMPLEXION**, among physicians, the temperament, habitude, and natural disposition of the body, but more often the colour of the face and skin.

**COMPLEXUS**, in anatomy. See Vol. I. p. 216.

**COMPLEXUS minor**, in anatomy. See Vol. I. p. 216.

**COMPLICATION**, in general, denotes the blending, or rather interweaving, of several different things together: thus a person afflicted with several disorders at the same time, is said to labour under a complication of diseases.

**COMPOUND**, **COMPONE**, or **GOBONY**, in heraldry, is said of a bordure made up of angular parts, or chequers, of two different colours. See Plate LXV. fig. 13.

**COMPOSITE**, in general, denotes something compounded, or made up of several others united together. Thus,

**COMPOSITE numbers**, are such as can be measured exactly by a number exceeding unity; as 6 by 2 or 3, or 10 by 5, &c. so that 4 is the lowest composite number.

**COMPOSITE order**, in architecture. See Vol. I. p. 352.

**COMPOSITION**, in a general sense, the uniting or putting together several things, so as to form one whole, called a compound.

**COMPOSITION of ideas**, an act of the mind, whereby it unites several simple ideas into one conception or complex idea.

When we are provided with a sufficient stock of simple ideas, and have by habit and use rendered them familiar to our minds, they become the component parts of other ideas still more complicated, and form what we may call a second order of compound notions. This process may be continued to any degree of composition we please, mounting from one stage to another, and enlarging the number of combinations.

**COMPOSITION**, in grammar, the joining of two words together; or prefixing a particle to another word, to augment, diminish, or change its signification.

**COMPOSITION**, in logic, a method of reasoning, where-

by

by we proceed from some general self-evident truth, to other particular and singular ones.

In disposing and putting together our thoughts, there are two ways of proceeding, equally within our choice: for we may so propose the truths, relating to any part of knowledge, as they presented themselves to the mind, in the manner of investigation; carrying on the series of proofs in a reverse order, till they, at last, terminate in first principles: or beginning with these principles, we may take the contrary way, and from them deduce, by a direct train of reasoning, all the several propositions we want to establish.

This diversity, in the manner of arranging our thoughts, gives rise to the twofold division of method established among logicians; the one called analytic method, or the method of resolution, inasmuch as it traces things back to their source, and resolves knowledge into its first and original principles. This method stands in contradistinction to the method of composition; or, as it is otherwise called, the synthetic method: for here we proceed by gathering together the several scattered parts of knowledge, and combining them into one system, in such a manner, as that the understanding is enabled distinctly to follow truth through all the different stages of gradation.

COMPOSITION, in music, the art of disposing musical sounds into airs, songs, &c. either in one or more parts, to be sung by a voice, or played on instruments. See MUSIC, and SONG.

Under composition are comprehended the rules,  
1. Of melody, or the art of making a single part; that is, contriving and disposing the simple sounds, so as that their succession and progression may be agreeable to the ear. See MELODY.

2. Of harmony, or the art of disposing and concerting several single parts together, so as that they make one agreeable whole. See HARMONY.

COMPOSITION, in literature, the art of forming and arranging sentiments, and cloathing them with language suitable to the nature of the subject or discourse. We shall first give a few thoughts on original composition; and, 2dly, by way of example, unfold the nature of epic and dramatic compositions.

#### 1. On Original Composition.

The mind of a man of genius is a fertile and pleasant field; pleasant as *Elysium*, and fertile as *Tempe*; it enjoys a perpetual spring. Of that spring, *originals* are the fairest flowers: *imitations* are of quicker growth, but fainter bloom. *Imitations* are of two kinds; one of nature, one of authors: the first we call *originals*, and confine the term *imitation* to the second. We shall not enter into the curious inquiry of what is, or is not, strictly speaking, *original*, content with what all must allow, that some compositions are more so than others; and the more they are so, the better. *Originals* are, and ought to be, great favourites, for they are benefactors; they extend the republic of letters, and add a new province to its dominion: *imitators* only give us a sort of duplicates of what we had, possibly much better, before;

increasing the mere drug of books, while all that makes them valuable, *knowledge* and *genius*, are at a stand. The pen of an *original* writer, like Armida's wand, out of a barren waste calls a blooming spring: out of that blooming spring an *imitator* is a transplanter of laurels, which sometimes die on removal, always languish in a foreign soil.

But suppose an *imitator* to be most excellent (and such there are), yet still he but nobly builds on another's foundation; his debt is, at least, equal to his glory; which therefore, on the balance, cannot be very great. On the contrary, an *original*, though but indifferent (its *originality* being set aside), yet has something to boast; it is something to say with him in Horace,

*Meo sum pauper in ære;*

and to share ambition with no less than *Cæsar*, who declared he had rather be the first in a village, than the second at Rome.

Still farther: an *imitator* shares his crown, if he has one, with the chosen object of his imitation; an *original* enjoys an undivided applause. An *original* may be said to be of a *vegetable* nature; it rises spontaneously from the vital root of genius; it *grows*, it is not *made*: *imitations* are often a sort of *manufacture* wrought by those *mechanics*, *art* and *labour*, out of pre-existent materials not their own.

Again: we read *imitation* with somewhat of his languor who listens to a twice-told tale: our spirits rouse at an *original*; that is a perfect stranger, and all throng to learn what news from a foreign land: and though it comes, like an Indian prince, adorned with feathers only, having little of weight; yet of our attention it will rob the more solid, if not equally new: thus every telescope is lifted at a new-discovered star; it makes a hundred astronomers in a moment, and denies equal notice to the sun. But if an *original*, by being as excellent, as new; adds admiration to surprize, then are we at the writer's mercy; on the strong wing of his imagination, we are snatched from Britain to Italy, from climate to climate, from pleasure to pleasure; we have no home, no thought, of our own; till the magician drops his pen: and then falling down into ourselves, we awake to flat realities, lamenting the change, like the beggar who dreamt himself a prince.

It is with thoughts, as it is with words; and with both, as with men; they may grow old and die. Words tarnished, by passing through the mouths of the vulgar, are laid aside as inelegant and obsolete. So thoughts, when become too common, should lose their currency; and we should send new metal to the mint, that is, new meaning to the press. The division of tongues at Babel did not more effectually debar men from making themselves a name (as the scripture speaks) than the too great concurrence or union of tongues will do for ever. We may as well grow good by another's virtue, or fat by another's food, as famous by another's thought. The world will pay its debt of praise but once; and instead of applauding, explode a second demand, as a cheat.

If it is said, that most of the Latin classics, and all the Greek, except, perhaps, Homer, Pindar, and Anacreon,

creon, are in the number of *imitators*, yet receive our highest applause; our answer is, that they, though not *real*, are *accidental originals*; the works they imitated, few excepted, are lost: they, on their father's decease, enter as lawful heirs on their estates in fame: the fathers of our copyists are still in possession; and secured in it, in spite of Goths, and flames, by the perpetuating power of the press. Very late must a modern *imitator's* fame arrive, if it waits for their decease.

An *original* enters early on reputation: *fame*, fond of new glories, sounds her trumpet in triumph at its birth; and yet how few are awakened by it into the noble ambition of like attempts? Ambition is sometimes no vice in life; it is always a virtue in composition. High in the towering Alps is the fountain of the Po; high in fame, and in antiquity, is the fountain of an *imitator's* undertaking; but the river, and the imitation, humbly creep along the vale. So few are our *originals*, that, if all other books were to be burnt, the lettered world would resemble some metropolis in flames, where a few incombustible buildings, a fortress, temple, or tower, lift their heads, in melancholy grandeur, amid the mighty ruin. Compared with this conflagration, old Omar lighted up but a small bonfire, when he heated the baths of the barbarians, for eight months together, with the famed Alexandrian library's inestimable spoils, that no prophane book might obstruct the triumphant progress of his holy Alcoran round the globe.

But why are originals so few? not because the writer's harvest is over, the great reapers of antiquity having left nothing to be gleaned after them; nor because the human mind's teeming time is past, or because it is incapable of putting forth unprecedented births; but because illustrious examples *engross*, *prejudice*, and *intimidate*. They *engross* our attention, and so prevent a due inspection of ourselves; they *prejudice* our judgment in favour of their abilities, and so lessen the sense of our own; and they *intimidate* us with the splendor of their renown, and thus under diffidence bury our strength. Nature's impossibilities, and those of diffidence, lie wide asunder.

After all, the first ancients had not merit in being *originals*: they could not be *imitators*. Modern writers have a *choice* to make; and therefore have a merit in their power. They may soar in the regions of *liberty*, or move in the soft fetters of *easy imitation*; and *imitation* has as many plausible reasons to urge, as *pleasure* had to offer to Hercules. Hercules made the choice of an hero, and *so* became immortal.

Yet let not assertors of classic excellence imagine, that we deny the tribute it so well deserves. He that admires not ancient authors, betrays a secret he would conceal, and tells the world, that he does not understand them. Let us be as far from neglecting, as from copying, their admirable compositions: sacred be their rights, and inviolable their fame. Let our understanding feed on theirs; they afford the noblest nourishment: but let them nourish, and annihilate, our own. When we read, let our imagination kindle at their charms; when we write, let our judgment shut them out of our thoughts; treat even Homer himself, as his royal admirer was treated by the cynic; bid him stand aside, nor shade our

composition from the beams of our own genius; for nothing *original* can rise, nothing immortal, can ripen, in any other sun.

Must we, then, not imitate ancient authors? Imitate them, by all means; but imitate aright. He that imitates the divine Iliad, does not imitate Homer; but he who takes the same method, which Homer took, for arriving at a capacity of accomplishing a work so great. Tread in his steps to the sole fountain of immortality; drink where he drank, at the true *Helicon*, that is, at the breast of nature. Imitate; but imitate not the *composition*, but the *man*. For may not this paradox pass into a maxim? *viz.* "The less we copy the renowned ancients, we shall resemble them the more."

But possibly it may be replied, that we must either imitate Homer, or depart from nature. Not so: for suppose you was to change place, in time, with Homer; then, if you write naturally, you might as well charge Homer with an imitation of you. Can you be said to imitate Homer for writing *so*, as you would have written if Homer had never been? As far as a regard to nature, and sound sense, will permit a departure from your great predecessors; so far, ambitiously, depart from them; the farther from them in *similitude*, the nearer are you to them in *excellence*; you rise by it into an *original*; become a noble collateral, not an humble descendant from them. Let us build our compositions with the spirit, and in the taste of the ancients; but not with their materials: thus will they resemble the structures of Pericles at Athens, which Plutarch commends for having had an air of antiquity as soon as they were built. All eminence, and distinction, lies out of the beaten road; excursion, and deviation, are necessary to find it; and the more remote your path from the highway, the more reputable; if, like poor Gulliver, you fall not into a ditch, in your way to glory.

What glory to come near, what glory to reach, what glory (presumptuous thought!) to surpass our predecessors? And is that then in nature absolutely impossible? or is it not rather contrary to nature to fail in it? Nature herself sets the ladder, all wanting is our ambition to climb. For by the bounty of nature we are as strong as our predecessors; and by the favour of time (which is but another round in nature's scale) we stand on higher ground. As to the *first*, were they more than men? or are we less? Are not our minds cast in the same mould with those before the flood? The flood affected matter: mind escaped. As to the *second*; though we are moderns, the world is an ancient; more ancient far, than when they, whom we most admire, filled it with their fame. Have we not their beauties, as stars, to guide; their defects, as rocks, to be shunned; the judgment of ages on both, as a chart to conduct, and a sure helm to steer us in our passage to greater perfection than theirs? And shall we be stopt in our rival pretensions to fame by this just reproof?

*Stat contra, dicitque tibi tua pagina, Fur es.*

MART.

It is by a sort of noble contagion, from a general familiarity with their writings, and not by any particular sordid theft, that we can be the better for those who

went before us. Hope we, from plagiarism, any dominion in literature; as that Rome rose from a nest of thieves?

Rome was a powerful ally to many states; ancient authors are our powerful allies; but we must take heed, that they do not succour till they enslave, after the manner of Rome. Too formidable an idea of their superiority, like a spectre, would fright us out of a proper use of our wits; and dwarf our understanding, by making a giant of theirs. Too great awe for them lays genius under restraint, and denies it that free scope, that full elbow-room, which is requisite for striking its most masterly strokes. Genius is a matter-workman, learning is but an instrument, and an instrument, though most valuable, yet not always indispensable. Heaven will not admit of a partner in the accomplishment of some favourite spirits; but rejecting all human means, assumes the whole glory to itself. Have not some, though not famed for erudition, *so* written, as almost to persuade us, that they shone brighter, and soared higher, for escaping the boasted aid of that proud ally?

Nor is it strange; for what, for the most part, mean we by genius, but the power of accomplishing great things without the means generally reputed necessary to that end? A *genius* differs from a *good understanding*, as a magician from a good architect; *that* raises his structure by means invisible; *this* by the skilful use of common tools. Hence genius has ever been supposed to partake of something divine.

Learning, destitute of this superior aid, is fond, and proud of what has cost it much pains; is a great lover of rules, and boaster of famed examples. As beauties less perfect, who owe half their charms to cautious art, learning inveighs against natural unstudied graces, and small harmless inaccuracies, and sets rigid bounds to that liberty to which genius often owes its supreme glory; but the no genius its frequent ruin. For unprecribed beauties, and unexampled excellence, which are characteristics of *genius*, lie without the pale of *learning's* authorities, and laws; which pale, genius must leap to come at them: but by that leap, if genius is wanting, we break our necks; we lose that little credit, which possibly we might have enjoyed before. For rules, like crutches, are a needful aid to the lame, though an impediment to the strong. A Homer casts them away; and, like his Achilles,

*Jura negat sibi nata, nihil non arrogat,*  
by native force of mind. There is something in poetry beyond prose-reason; there are mysteries in it not to be explained, but admired; which render mere prose-men infidels to their divinity. And here may be offered a second paradox: *viz.* "Genius often then deserves most to be praised, when it is most sure to be condemned; that is, when its excellence, from mounting high, to weak eyes is quite out of sight."

If we might speak farther of learning and genius, we would compare genius to virtue, and learning to riches. As riches are most wanted where there is least virtue; so learning where there is least genius. As virtue without much riches can give happiness; so genius without much learning can give renown. As it is said in Terence,

*pecuniam negligere interdum maximum est lucrum;*  
so to neglect of learning, genius sometimes owes its greater glory. Genius, therefore, leaves but the second place, among men of letters, to the learned. It is their merit, and ambition, to throw light on the works of genius, and point out its charms. We most justly reverence their informing radius for that favour; but we must much more admire the radiant stars pointed out by them.

A star of the first magnitude among the moderns was Shakespeare; among the ancients, Pindar; who, (as Voisius tells us) boasted of his no-learning, calling himself the eagle; for his flight above it. And such geni as these may, indeed, have much reliance on their own native powers. For genius may be compared to the natural strength of the body; learning to the superinduced countrements of arms: if the first is equal to the proposed exploit, the latter rather encumbers, than assists; rather retards, than promotes, the victory. *Sacer nobis inest Deus,* says Seneca. With regard to the moral world, *conscience*, with regard to the intellectual, *genius*, is that god within. Genius can set us right in composition, without the rules of the learned; as conscience sets us right in life, without the laws of the land: *this*, singly, can make us good, as men: *that*, singly, as writers, can, sometimes, make us great.

As too great admirers of the fathers of the church have sometimes set up their authority against the true sense of scripture; so too great admirers of the classical fathers have sometimes set up their authority, or example, against reason.

*Neve minor, neu sit quinto productior actu fabula.*  
So says Horace, so says ancient example. But reason has not subscribed. We know but one book that can justify our implicit acquiescence in it: and (by the way) on that book a noble disdāin of undue deference to prior opinion has lately cast, and is still casting, a new and inestimable light.

But, superstition for our predecessors set aside, the classics are for ever our rightful and revered masters in *composition*; and our understandings bow before them. But when? When a master is wanted; which sometimes is not the case. Some are pupils of nature only, nor go farther to school. From such we reap often a double advantage; they not only rival the reputation of the great ancient authors, but also reduce the number of mean ones among the moderns. For when they enter on subjects which have been in former hands, such is their superiority, that, like a tenth wave, they overwhelm, and bury in oblivion all that went before: and thus not only enrich and adorn, but remove a load, and lessen the labour, of the letter'd world.

"But, it may be said, since *originals* can arise from genius only, and since genius is so very rare, it is scarce worth while to labour a point so much, from which we can reasonably expect so little." To show that genius is not so very rare as you imagine, we shall point out strong instances of it, in a far distant quarter from that mentioned above. The minds of the schoolmen were almost as much cloistered as their bodies; they had but little learning, and few books; yet may the most learned be struck  
with

with some astonishment at their so singular natural sagacity, and most exquisite edge of thought. Who would expect to find Pindar and Scotos, Shakespeare and Aquinas, of the same party? Both equally shew an *original*, unindebted, energy: the *vigor igneus*, and *caelestis origo*, burns in both; and leaves us in doubt whether genius is more evident in the sublime flights and beauteous flowers of poetry, or in the profound penetrations, and marvelously keen and minute distinctions, called the thorns of the schools. There might have been more able consuls called from the plough, than ever arrived at that honour: many a genius, probably, there has been, which could neither write nor read. So that genius, that supreme lustre of literature, is less rare than is generally conceived.

By the praise of genius we detract not from learning; we detract not from the value of gold, by saying that diamond has greater still. He who disregards learning, shows that he wants its aid; and he that overvalues it, shows that its aid has done him harm. Over-valued indeed it cannot be, if genius as to *composition*, is valued more. Learning, we thank; genius, we revere; that gives us pleasure, this gives us rapture; that informs, this inspires; and is itself inspired; for genius is from heaven, learning from man: *this* sets us above the low, and illiterate; *that*, above the learned, and polite. Learning is borrowed knowledge; genius is knowledge innate, and quite our own. Therefore, as Bacon observes, it may take a nobler name, and be called wisdom; in which sense of wisdom, some are born wise.

Having put in a caveat against the most fatal of errors, from the too great indulgence of genius, return we now to that too great suppression of it, which is detrimental to composition; and endeavour to rescue the writer, as well as the man. We have said, that some are born wise; but they, like those that are born rich, by neglecting the cultivation and produce of their own possessions, and by running in debt, may be beggared at last; and lose their reputations, as younger brothers estates, not by being born with less abilities than the rich heir, but at too late an hour.

Many a great man has been lost to himself, and the public, purely because great ones were born before him. Hermias, in his collections on Homer's blindness, says, that Homer requesting the gods to grant him a sight of Achilles, that hero rose, but in armour so bright, that it struck Homer blind with the blaze. Let not the blaze of even Homer's muse darken us to the discernment of our own powers; which may possibly set us above the rank of *imitators*; who, though most excellent, and even immortal, (as some of them are), yet are still but *dii minorum gentium*, nor can expect the largest share of incense, the greatest profusion of praise, on their secondary altars.

But farther still: a spirit of *imitation* hath many ill effects; we shall confine ourselves to three. *First*, It deprives the liberal and politer arts of an advantage which the mechanic enjoy: in these, men are ever endeavouring to go beyond their predecessors; in the former, to follow them. And since copies surpass not their *originals*, as streams rise not higher than their spring, rarely so high; hence, while arts mechanic are in perpet-

ual progress and increase, the liberal are in retrogradation and decay. *These* resemble pyramids, are broad at bottom, but lessen exceedingly as they rise; *those* resemble rivers, which, from a small fountain-head, are spreading ever wider and wider, as they run. Hence it is evident, that different portions of understanding are not (as some imagine) allotted to different periods of time; for we see, in the same period, understanding rising in one set of artists, and declining in another. Therefore *nature* stands absolved, and our inferiority in composition must be charged on ourselves.

Nay, so far are we from complying with a necessity which nature lays us under, that, *secondly*, by a spirit of imitation we counteract nature, and thwart her design. She brings us into the world all *originals*. No two faces, no two minds, are just alike; but all bear nature's evident mark of separation on them. Born *originals*, how comes it to pass that we die *copies*? That meddling *ape imitation*, as soon as we come to years of *indiscretion*, (if we may so speak), snatches the pen, and blots out nature's mark of separation, cancels her kind intention, destroys all mental individuality; the letter'd world no longer consists of singulars, it is a medley, a mass; and a hundred books, at bottom, are but one. Why are monkeys such masters of mimicry? why receive they such a talent at imitation? Is it not as the Spartan slaves received a license for ebriety, that their betters might be ashamed of it?

The *third* fault to be found with a spirit of *imitation* is, that with great incongruity it makes us poor and proud: makes us think little, and write much; gives us huge folios, which are little better than more reputable cushions to promote our repose. Have not some sevenfold volumes put us in mind of Ovid's sevenfold channels of the Nile at the conflagration?

#### *Ostia septem*

*Pulverulenta vacant septem sine flumine valles.*

Such leaden labours are like Lycurgus's iron money, which was so much less in value than in bulk, that it required barns for strong boxes, and a yoke of oxen to draw five hundred pounds.

But notwithstanding these disadvantages of *imitation*, imitation must be the lot (and often an honourable lot it is) of most writers. If there is a famine of *invention* in the land, like Joseph's brethren, we must travel far for food; we must visit the remote and rich ancients: but an inventive genius may safely stay at home; that, like the widow's cruse, is divinely replenished from within, and affords us a miraculous delight. Whether our own genius be such or not, we diligently should inquire, that we may not go a-begging with gold in our purse. For there is a mine in man, which must be deeply dug ere we can conjecture its contents. Another often sees that in us, which we see not ourselves; and may there not be that in us which is unseen by both? That there may, chance often discovers, either by a luckily chosen theme, or a mighty premium, or an absolute necessity of exertion, or a noble stroke of emulation from another's glory; as that on Thucydides from hearing Herodotus repeat part of his history at the Olympic games. Had there been no Herodotus, there might have been no Thucydides, and the world's

world's admiration might have begun at Livy for excellence in that province of the pen. Demosthenes had the same stimulation on hearing Callistratus; or Tully might have been the first of consummate renown at the bar.

Quite clear of the dispute concerning ancient and modern learning, we speak not of performance, but powers. The modern powers are equal to those before them; modern performance in general is deplorably short. How great are the names just mentioned? Yet who will daily affirm, that as great may not rise up in some future, or even in the present age? Reasons there are why talents may not *appear*, none why they may not *exist*, as much in one period as another. An evocation of vegetable fruits depends on rain, air, and sun; an evocation of the fruits of genius no less depends on externals. What a marvellous crop bore it in Greece and Rome? And what a marvellous sunshine did it there enjoy? What encouragement from the nature of their governments, and the spirit of their people? Virgil and Horace owed their divine talents to Heaven; their immortal works to men; thank Mæcenas and Augustus for them. Had it not been for these, the genius of those poets had lain buried in their ashes. Athens expended on her theatre, painting, sculpture, and architecture, a tax levied for the support of a war. Cæsar dropt his papers when Tully spoke; and Philip trembled at the voice of Demosthenes. And has there arisen but one Tully, one Demosthenes in so long a course of years? The powerful eloquence of them both in one stream, should never bear us down into the melancholy persuasion, that several have not been born, though they have not emerged. The sun as much exists in a cloudy day, as in a clear; it is outward, accidental circumstances that with regard to genius either in nation, or age,

*Collectas fugat nubes, solemque reducit.* VIRG.

As great, perhaps greater than those mentioned (presumptuous as it may sound) may, possibly, arise; for, who hath fathomed the mind of man? Its bounds are as unknown, as those of the creation; since the birth of which, perhaps, not one has so far exerted, as not to leave his possibilities beyond his attainments, his powers beyond his exploits. Forming our judgments altogether by what *has* been done, without knowing, or at all inquiring, what possibly *might* have been done, we naturally enough fall into too mean an opinion of the human mind. If a sketch of the divine Iliad before Homer wrote, had been given to mankind, by some superior being, or otherwise, its execution would probably have appeared beyond the power of man. Now, to surpass it, we think impossible. As the first of these opinions would evidently have been a mistake, why may not the second be so too? Both are founded on the same bottom; on our ignorance of the possible dimensions of the mind of man.

Nor are we only ignorant of the dimensions of the human mind in general, but even of our own. That a man may be scarce less ignorant of his own powers, than an oyster of its pearl, or a rock of its diamond; that he may possess dormant, unsuspected abilities, till awakened by loud calls, or stung up by striking emergencies; is evident from the sudden eruption of some men out of perfect obscurity, into public admiration, on the strong

impulse of some animating occasion; not more to the world's great surprise, than their own. Few authors of distinction but have experienced something of this nature, at the first beamings of their yet unsuspected genius on their hitherto dark composition. The writer starts at it, as at a lucid meteor in the night; is much surprised; can scarce believe it true. During this happy confusion, it may be said to him, as to Eve at the lake,

*What there thou see'st, fair creature, is thyself.*

MILTON.

Genius, in this view, is like a dear friend in our company under disguise; who, while we are lamenting his absence, drops his mask, striking us at once with equal surprise and joy. This sensation, which we speak of in a writer, might favour, and so promote, the fable of poetic inspiration. A poet of a strong imagination, and stronger vanity, on feeling it, might naturally enough realise the world's mere compliment, and think himself truly inspired. Which is not improbable; for enthusiasm of all kinds do no less.

Since it is plain, that men may be strangers to their own abilities; and by thinking meanly of them without just cause, may possibly lose a name, perhaps a name immortal; we would find some means to prevent these evils. Whatever promotes virtue, promotes something more, and carries its good influence beyond the *moral* man: to prevent these evils we borrow two golden rules from *ethics*, which are no less golden in *composition*, than in life. 1. *Know thyself*; 2. *Reverence thyself*.

1st, *Know thyself*. Of ourselves it may be said, as Martial says of a bad neighbour,

*Nil tam prope, proculque nobis.*

Therefore dive deep into thy bosom; learn the depth, extent, bias, and full sort of thy mind; contract full intimacy with the stranger within thee; excite and cherish every spark of intellectual light and heat, however smothered under former negligence, or scattered through the dull, dark mass of common thoughts; and collecting them into a body, let thy genius rise (if a genius thou hast) as the sun from chaos; and if we should then say, like an Indian, *Worship it*, (though too bold) yet should we say little more than the second rule enjoins, viz. *Reverence thyself*.

That is, let not great examples, or authorities, browbeat thy reason into too great a diffidence of thyself: thyself so reverence, as to prefer the native growth of thy own mind to the richest import from abroad; such borrowed riches make us poor. The man who thus reverences himself, will soon find the world's reverence to follow his own. His works will stand distinguished; his the sole property of them; which property alone can confer the noble title of an *author*; that is, of one who, to speak accurately, *thinks*, and *composes*; while other invaders of the press, how voluminous, and learned soever, with due respect be it spoken, only *read* and *write*.

This is the difference between those two luminaries in literature, the well-accomplished scholar, and the divinely-inspired enthusiast; the first is, as the bright morning star; the second, as the rising sun. The writer who neglects those two rules above will never stand alone; he

makæ



makes one of a group, and thinks in wretched unanimity with the throng. Incombered with the notions of others, and impoverished by their abundance, he conceives not the least embryo of new thought; opens not the least vista through the gloom of ordinary writers, into the bright walks of rare imagination, and singular design; while the true genius is crossing all public roads into fresh untrodden ground, he, up to the knees in antiquity, is treading the sacred footsteps of great examples, with the blind veneration of a bigot saluting the papal toe; comfortably hoping full absolution for the sins of his own understanding, from the powerful charm of touching his idol's infallibility.

Such meanness of mind, such prostration of our own powers, proceeds from too great admiration of others. Admiration has generally a degree of two very bad ingredients in it; of ignorance, and of fear; and does mischief in composition, and in life. Proud as the world is, there is more superiority in it given, than assumed: and its grandeurs of all kinds owe more of their elevation to the littleness of others minds, than to the greatness of their own. Were not prostrate spirits their voluntary pedestals, the figure they make among mankind would not stand so high. *Imitators* and *translators* are somewhat of the pedestal-kind, and sometimes rather raise their *original's* reputation, by showing him to be by them inimitable, than their own Homer has been translated into most languages; Ælian tells us, that the Indians, (hopeful tutors!) have taught him to speak their tongue. What expect we from them? Not Homer's Achilles, but something, which, like Patroclus, assumes his name, and, at its peril, appears in his stead; nor expect we Homer's Ulysses gloriously bursting out of his cloud into royal grandeur, but an Ulysses under disguise, and a beggar to the last. Such is that inimitable father of poetry, and oracle of all the wise, whom Lycurgus transcribed; and for an annual public recital of whose works Solon enacted a law; that it is much to be feared, that his so numerous translations are but as the published testimonials of so many nations, and ages, that this author so divine is untranslated still.

But here,

*Cynthia aurem  
Vellit,*—

VIRG.

and demands justice for his favourite, and ours. Great things he has done; but he might have done greater. What a fall is it from Homer's numbers, free as air, lofty and harmonious as the spheres, into childish shackles, and tinkling sounds! But, in his fall, he is still great;—

*Nor appears  
Less than archangel ruin'd, and the excess  
Of glory obscur'd.*—

MILT.

Had Milton never wrote, Pope had been less to blame: but when in Milton's genius, Homer, as it were, personally rose to forbid Britons doing him that ignoble wrong; it is less pardonable, by that *feminine* decoration, to put Achilles in petticoats a second time. How much nobler had it been, if his numbers had rolled on in full flow, through the various modulations of masculine melody, into those grandeurs of solemn sound, which are in-

VOL. II. No. 40.

3

dispensibly demanded by the native dignity of heroic song? How much nobler, if he had resisted the temptation, of that Gothic dæmon, which modern poetry tasting, became mortal? O how unlike the deathless, divine harmony of three great names (how justly joined!) of *Milton*, *Greece*, and *Rome*? His verse, but for his little speck of mortality, in its extreme parts, as his hero had in his heel; like him, had been invulnerable, and immortal. But, unfortunately, *that* was undipt in Helicon; as *this* in Styx. Harmony as well as eloquence is essential to poetry; and a murder of his music is putting half Homer to death. *Blank* is a term of diminution; what we mean by blank verse is, verse unfallen, uncurst; verse reclaimed, reenthroned in the true *language of the gods*; who never thundered, nor suffered their Homer to thunder in rhyme.

But supposing Pope's Iliad to have been perfect in its kind; yet it is a *translation* still; which differs as much from an *original*, as the moon from the sun.

But as nothing is more easy than to write originally wrong; originals are not here recommended, but under the strong guard of the first rule,—*Know thyself*. Lucian, who was an original, neglected not this rule, if we may judge by his reply to one who took some freedom with him. He was at first an apprentice to a statuary; and when he was reflected on as such, by being called *Prometheus*, he replied, "I am indeed the inventor of a new work, the model of which I owe to none; and, if I do not execute it well, I deserve to be torn by twelve vultures, instead of one."

Bacon says, "Men seek not to know their own stock, and abilities; but fancy their possessions to be greater, and their abilities less, than they really are." Which is in effect saying, "That we ought to exert more than we do; and that, on exertion, our probability of success is greater than we conceive."

Nor have we Bacon's opinion only, but his assistance too, in favour of originals. His mighty mind travelled round the intellectual world; and, with a more than eagle's eye, saw, and has pointed out, blank spaces, or dark spots in it, on which the human mind never shone: some of these have been enlightened since; some are benighted still.

Moreover, so boundless are the bold excursions of the human mind, that in the vast void beyond real existence, it can call forth shadowy beings, and unknown worlds, as numerous, as bright, and perhaps as lasting as the stars; such quite-original beauties we may call paradisaical,

*Natas sine femine flores.*

OVID.

When such an ample area for renowned adventure in *original* attempts lies before us, shall we be as mere leaden pipes, conveying to the present age small streams of excellence from its grand reservoir in antiquity; and those too perhaps mudded in the pass? Originals shine like comets; have no peer in their path; are rivalled by none, and the gaze of all: all other compositions (if they shine at all) shine in clusters; like the stars in the galaxy; where, like bad neighbours, all suffer from all; each particular being diminished, and almost lost in the throng.

If thoughts of this nature prevailed; if ancients and moderns were no longer considered as masters and pupils,

†

3 †

but

but as hard-matched rivals for renown; then moderns, by the longevity of their labours, might one day become ancients themselves: and old time, that best weigher of merits, to keep his balance even, might have the golden weight of an Augustan age in both his scales: or rather, our scale might descend: and that of antiquity (as a modern match for it strongly speaks) might *kick the beam*.

Why condemned Maro his admirable epic to the flames? Was it not because his discerning eye saw some length of perfection beyond it? And what he saw, may not others reach? And who bid fairer than our countrymen for that glory? Something new may be expected from Britons particularly; who seem not to be more severed from the rest of mankind by the surrounding sea, than by the current in their veins; and of whom little more appears to be required, in order to give us originals, than a consistency of character, and making their compositions of a piece with their lives. May our genius shine; and proclaim us in that noble view!

—*minimè contentos nosse Britannos.* VIRG.

And so it does; for in polite composition, in natural and mathematical knowledge, we have great originals already: Bacon, Boyle, Newton, Shakespeare, Milton, have showed us, that all the winds cannot blow the British flag farther, than an original spirit can convey the British fame; their names go round the world; and what foreign genius strikes not as they pass? Why should not their posterity embark in the same bold bottom of new enterprise, and hope the same success? Hope it they may; or we must assert, either that those originals, which we already enjoy, were written by angels, or deny that we are men. As Simonides said to Pausanias, reason should say to the writer, "Remember thou art a man." And for man not to grasp at all which is laudable within his reach, is a dishonour to human nature, and a disobedience to the divine; for as Heaven does nothing in vain, its gift of talents implies an injunction of their use.

Johnson in the serious drama, is as much an imitator as Shakespeare is an original. He was very learned, as Sampson was very strong, to his own hurt. Blind to the nature of tragedy, he pulled down all antiquity on his head, and buried himself under it; we see nothing of Johnson, nor indeed of his admired (but also murdered) ancients; for what shone in the historian is a cloud on the poet; and Catiline might have been a good play if Sallust had never written.

Dryden, destitute of Shakespeare's genius, had almost as much learning as Johnson, and, for the buskin, quite as little taste. He was a stranger to the pathos, and, by numbers, expression, sentiment, and every other dramatic cheat, strove to make amends for it; as if a saint could make amends for the want of conscience; a soldier, for the want of valour; or a vestal, of modesty. The noble nature of tragedy disclaims an equivalent; like virtue, it demands the heart; and Dryden had none to give. Let epic poets *think*, the tragedian's point is rather to *feel*; such distant things are a tragedian and a poet, that the latter indulged, destroys the former. Look on Barnwell, and Essex, and see how as to these distant characters Dryden excels, and is excel-

led. But the strongest demonstration of his no-taste for the buskin, are his tragedies fringed with rhyme; which, in epic poetry, is a fore disease; in the tragic, absolute death. To Dryden's enormity, Pope's was a light offence. As Iacmen are foes to mourning, these two authors, rich in rhyme, were no great friends to those solemn ornaments, which the noble nature of their works required.

Must rhyme then, it may be said, be banished? It is to be wished the nature of our language could bear its entire expulsion; but our lesser poetry stands in need of a toleration for it; it raises that, but sinks the great; as spangles adorn children, but expose men.

Among the brightest of the moderns, Mr Addison must take his place. Who does not approach his character with great respect? They who refuse to close with the public in his praise, refuse at their peril. But, if men will be fond of their own opinions, some hazard must be run. He had, what Dryden and Johnson wanted, a warm, and feeling heart; but, being of a grave and bashful nature, through a philosophic reserve, and a sort of moral prudery, he concealed it, where he should have let loose all his fire, and have showed the most tender sensibility of heart. At his celebrated Cato, few tears are shed, but Cato's own; which indeed are truly great, but unaffecting, except to the noble few who love their country better than themselves. The bulk of mankind want virtue enough to be touched by them. His strength of genius has reared up one glorious image, more lofty, and truly golden, than that in the plain of Dura, for cool admiration to gaze at, and warm patriotism (how rare!) to worship; while those two throbbing pulses of the drama, by which alone it is shown to live, *terror* and *pity*, neglected through the whole, leave our unmolested hearts at perfect peace. Thus the poet, like his hero, through mistaken excellence, and virtue overstrained, becomes a sort of suicide; and that which is most dramatic in the drama, dies. All his charms of poetry are but as funeral flowers which adorn, all his noble sentiments but as rich spices which embalm, the tragedy deceased.

Socrates frequented the plays of Euripides; and, what living Socrates would decline the theatre, at the representation of Cato? Tully's assassins found him in his litter, reading the *Mædea* of the Grecian poet, to prepare himself for death. Part of Cato might be read to the same end. In the weight and dignity of moral reflection, Addison resembles that poet, who was called the dramatic philosopher; and is himself, as he says of Cato, *ambitiously sententious*. But as to the singular talent so remarkable in Euripides, at melting down hearts into the tender streams of grief and pity, there the resemblance fails. His beauties sparkle, but do not warm; they sparkle as stars in a frosty night. There is, indeed, a constellation in his play; there is the philosopher, patriot, orator, and poet; but where is the tragedian? And, if that is wantings,

*Cur in theatrum Cato severè venisti?* MART.

## 2. Of epic and dramatic Compositions.

Tragedy and the epic poem differ little in substantial:

in both the same ends are proposed, *viz.* instruction and amusement; and in both the same means are employed, *viz.* imitation of human actions. They differ in the manner only of imitating: epic poetry deals in narration; tragedy represents its facts as passing in our sight: in the former, the poet introduces himself as an historian; in the latter, he presents his actors, and never himself.

This difference, regarding form only, may be thought slight: but the effects it occasions, are by no means so; for what we see, makes a stronger impression than what we learn from others. A narrative poem is a story told by another: facts and incidents passing upon the stage, come under our own observation; and are beside much enlivened by action and gesture, expressive of many sentiments beyond the reach of language.

A dramatic composition has another property, independent altogether of action; which is, that it makes a deeper impression than narration; in the former, persons express their own sentiments; in the latter, sentiments are related at second hand. For that reason, Aristotle, the father of critics, lays it down as a rule, That in an epic poem the author ought to take every opportunity to introduce his actors, and to confine the narrative part within the narrowest bounds. Homer understood perfectly the advantage of this method; and his poems are both of them in a great measure dramatic. Lucan runs to the opposite extreme; and is guilty of a still greater fault, in stuffing his *Pharsalia* with cold and languid reflections, the merit of which he assumes to himself, and deigns not to share with his personages.

Aristotle, from the nature of the fable, divides tragedy into simple and complex: but it is of greater moment, with respect to dramatic as well as epic poetry, to found a distinction upon the different ends attained by such compositions. A poem, whether dramatic or epic, that has nothing in view but to move the passions, and to exhibit pictures of virtue and vice, may be distinguished by the name of *pathetic*: but where a story is purposely contrived to illustrate some moral truth, by showing that disorderly passions naturally lead to external misfortunes, such composition may be denominated *moral*. Besides making a deeper impression than can be done by any moral discourse, it affords conviction equal to that of the most accurate reasoning. To be satisfied of this, we need but reflect, that the natural connection which vice hath with misery, and virtue with happiness, may be illustrated by stating a fact as well as by urging an argument. Let us assume, for example, the following moral truths: That discord among the chiefs renders ineffectual all common measures; and that the consequences of a slightly-founded quarrel, fostered by pride and arrogance, are not less fatal than those of the grossest injury: these truths may be inculcated, by the quarrel between Agamemnon and Achilles at the siege of Troy. In this view, probable circumstances must be invented, such as furnish an opportunity for the turbulent passions to exert themselves in action: at the same time, no accidental nor unaccountable event ought to be admitted; for the necessary or probable connection between vice and misery, is not learned from any events but what are naturally occasioned by the characters and passions of the persons re-

presented, acting in such and such circumstances. A real event of which we see not the cause, may be a lesson to us; because what hath happened may again happen: but this cannot be inferred from a story that is known to be a fiction.

Many are the good effects of such compositions. A pathetic composition, whether epic or dramatic, tends to a habit of virtue, by exciting us to do what is right, and restraining from what is wrong. Its frequent pictures of human woes produce, beside, two effects extremely salutary: they improve our sympathy, and at the same time fortify us in bearing our own misfortunes. A moral composition must obviously produce the same good effects, because by being moral it doth not cease to be pathetic: it enjoys beside an excellence peculiar to itself; for it not only improves the heart, as above mentioned, but instructs the head by the moral it contains. For our part, we cannot imagine any entertainment more suited to a rational being, than a work thus happily illustrating some moral truth; where a number of persons of different characters are engaged in an important action, some retarding, others promoting, the great catastrophe; and where there is dignity of style as well as of matter. A work of this kind has our sympathy at command, and can put in motion the whole train of the social affections: our curiosity is by turns excited and gratified; and our delight is consummated at the close, upon finding, from the characters and situations exhibited at the commencement, that every incident down to the final catastrophe is natural, and that the whole in conjunction make a regular chain of causes and effects.

Considering that an epic and a dramatic poem are the same in substance, and have the same aim or end, one would readily imagine, that subjects proper for the one must be equally proper for the other. But considering their difference as to form, there will be found reason to correct that conjecture, at least in some degree. Many subjects may indeed be treated with equal advantage in either form; but the subjects are still more numerous for which they are not equally qualified; and there are subjects proper for the one and not at all for the other. To give some slight notion of the difference, as there is no room here for enlarging upon every article, we observe, that dialogue is the best qualified for expressing sentiments, and narrative for displaying facts. Heroism, magnanimity, undaunted courage, and the whole tribe of the elevated virtues, figure best in action: tender passions, and the whole tribe of sympathetic affections, figure best in sentiment: what we feel is the most remarkable in the latter; what we perform is the most remarkable in the former. It clearly follows, that tender passions are more peculiarly the province of tragedy, grand and heroic actions of epic poetry.

The subject best fitted for tragedy is a story where a man has himself been the cause of his misfortune. - But this man must neither be deeply guilty, nor altogether innocent: the misfortune must be occasioned by a fault incident to human nature, and therefore venial. Misfortunes of this kind call forth the social affections, and warmly interest the spectator. An accidental misfortune, if not extremely singular, doth not greatly move

our

our pity: the person who suffers, being innocent, is freed from the greatest of all torments, that anguish of mind which is occasioned by remorse.

An atrocious criminal, on the other hand, who brings misfortunes upon himself, excites little pity, for a different reason: his remorse, it is true, aggravates his distress, and swells the first emotions of pity; but then our hatred of him as a criminal blending with pity, blunts its edge considerably. Misfortunes that are not innocent, nor highly criminal, partake the advantages of each extreme: they are attended with remorse to embitter the distress, which raises our pity to a great height; and the slight indignation we have at a venial fault, detracts not sensibly from our pity. For this reason, the happiest of all subjects for raising pity, is where a man of integrity falls into a great misfortune by doing an action that is innocent, but which by some singular means he conceives to be criminal: his remorse aggravates his distress; and our compassion, unrestrained by indignation, rises to its highest pitch. Pity comes thus to be the ruling passion of a pathetic tragedy; and by proper representation, may be raised to a height scarce exceeded by any thing felt in real life. A moral tragedy takes in a larger field; for, beside exercising our pity, it raises another passion, selfish indeed, but which deserves to be cherished equally with the social affections. The passion we have in view is fear or terror; for when a misfortune is the natural consequence of some wrong bias in the temper, every spectator who is conscious of such a wrong bias in his own temper, takes the alarm, and dreads his falling into the same misfortune: and it is by this emotion of fear or terror, frequently reiterated in a variety of moral tragedies, that the spectators are put upon their guard against the disorders of passion.

The commentators upon Aristotle, and other critics, have been much gravell'd about the account given of tragedy by this author: "That by means of pity and terror, it refines or purifies in us all sorts of passion." But no one who has a clear conception of the end and effects of a good tragedy, can have any difficulty about Aristotle's meaning: our pity is engaged for the persons represented; and our terror is upon our own account. Pity indeed is here made to stand for all the sympathetic emotions, because of these it is the capital. There can be no doubt, that our sympathetic emotions are refined or improved by daily exercise; and in what manner our other passions are refined by terror, we have just now said.

With respect to subjects of this kind, it may indeed be a doubtful question, whether the conclusion ought not always to be fortunate. Where a person of integrity is represented as suffering to the end under misfortunes purely accidental, we depart discontented, and with some obscure sense of injustice: for seldom is man so submissive to providence, as not to revolt against the tyranny and vexations of blind chance; he will be inclined to say, This ought not to be. We give for an example the *Romeo and Juliet* of Shakespeare, where the fatal catastrophe occasioned by Friar Laurence's coming to the monument a minute too late. We are vexed at the unlucky chance, and go away dissatisfied. Such impressions,

which ought not to be cherished, are a sufficient reason for excluding stories of that kind from the theatre. The misfortunes of a virtuous person, arising from necessary causes, or from a chain of unavoidable circumstances, will be considered in a different light: chance affords always a gloomy prospect, and in every instance gives an impression of anarchy and misrule: a regular chain, on the contrary, of causes and effects, directed by the general laws of nature, never fails to suggest the hand of Providence; to which we submit without resentment, being conscious that submission is our duty. For that reason, we are not disgusted with the distresses of Voltaire's *Mariamne*, though redoubled on her till the moment of her death, without the least fault or failing on her part: her misfortunes are owing to a cause extremely natural, and not unfrequent, the jealousy of a barbarous husband. The fate of *Desdemona* in the *Moor of Venice*, affects us in the same manner. We are not so easily reconciled to the fate of *Cordelia* in *King Lear*: the causes of her misfortune are by no means so evident, as to exclude the gloomy notion of chance. In short, a perfect character suffering under misfortunes, is qualified for being the subject of a pathetic tragedy, provided chance be excluded. Nor is a perfect character altogether inconsistent with a moral tragedy: it may successfully be introduced as an under-part, supposing the chief place to be filled with an imperfect character from which a moral can be drawn. This is the case of *Desdemona* and *Marianne* just now mentioned; and it is the case of *Monimia* and *Belvidera*, in Otway's two tragedies, the *Orphan*, and *Venice Preserved*.

Fable operates on our passions, by representing its events as passing in our sight, and by deluding us into a conviction of reality. Hence, in epic and dramatic compositions, it is of importance to employ means of every sort that may promote the delusion, such as the borrowing from history some noted event, with the addition of circumstances that may answer the author's purpose: the principal facts are known to be true; and we are disposed to extend our belief to every circumstance. But in choosing a subject that makes a figure in history, greater precaution is necessary than where the whole is a fiction. In the latter case there is full scope for invention: the author is under no restraint other than that the characters and incidents be just copies of nature. But where the story is founded on truth, no circumstances must be added, but such as connect naturally with what are known to be true; history may be supplied, but must not be contradicted: further, the subject chosen must be distant in time, or at least in place; for the familiarity of persons and events nearly connected with us, ought by all means to be avoided. Familiarity ought more especially to be avoided in an epic poem, the peculiar character of which is dignity and elevation: modern manners make but a poor figure in such a poem.

After Voltaire, no writer, it is probable, will think of rearing an epic poem upon a recent event in the history of his own country. But an event of this kind is perhaps not altogether unqualified for tragedy: it was admitted in Greece; and Shakespear has employed it successfully

cessfully in several of his pieces. One advantage it possesses above fiction, that of more readily engaging our belief, which tends above any other particular to raise our sympathy. The scene of comedy is generally laid at home: familiarity is no objection; and we are peculiarly sensible of the ridicule of our own manners.

After a proper subject is chosen, the dividing it into parts requires some art. The conclusion of a book in an epic poem, or of an act in a play, cannot be altogether arbitrary; nor be intended for so slight a purpose as to make the parts of equal length. The supposed pause at the end of every book, and the real pause at the end of every act, ought always to coincide with some pause in the action. In this respect, a dramatic or epic poem ought to resemble a sentence or period in language, divided into members that are distinguished from each other by proper pauses; or it ought to resemble a piece of music, having a full close at the end, preceded by imperfect closes that contribute to the melody. Every act in a dramatic poem ought therefore to close with some incident that makes a pause in the action; for otherwise there can be no pretext for interrupting the representation: it would be absurd to break off in the very heat of action; against which every one would exclaim: the absurdity still remains, though the action relents, if it be not actually suspended for some time. This rule is also applicable to an epic poem: though there, a deviation from the rule is less remarkable; because it is in the reader's power to hide the absurdity, by proceeding instantly to another book. The first book of the *Paradise Lost* ends without any regular close, perfect or imperfect: it breaks off abruptly, where Satan, seated on his throne, is prepared to make a speech to the convocated host of the fallen angels; and the second book begins with the speech. Milton seems to have copied the *Æneid*, of which the two first books are divided much in the same manner. Neither is there any proper pause at the end of the fifth book of the *Æneid*. There is no proper pause at the end of the seventh book of *Paradise Lost*, nor at the end of the eleventh.

This branch of the subject shall be closed with a general rule. That action being the fundamental part of every composition whether epic or dramatic, the sentiments and tone of language ought to be subservient to the action, so as in every respect to appear natural, and proper for the occasion. The application of this rule to our modern plays, would reduce the bulk of them to a skeleton.

After carrying on together epic and dramatic compositions, we proceed to handle them separately, and to mention circumstances peculiar to each, beginning with the epic kind. In a theatrical entertainment, which employs both the eye and the ear, it would be a gross absurdity to introduce upon the stage superior beings in a visible shape. There is not place for this objection in an epic poem; and Boileau, with many other critics, declares strongly for this sort of machinery in an epic poem. But waving authority, which is apt to impose upon the judgment, let us draw what light we can from reason. This matter is but indistinctly handled by critics: the poetical privilege of animating insensible objects for en-

livening a description, is very different from what is termed *machinery*, where deities, angels, devils, or other supernatural powers, are introduced as real personages, mixing in the action, and contributing to the catastrophe; and yet these two things are constantly jumbled together in the reasoning. The former is founded on a natural principle: but can the latter claim the same authority? so far from it, that nothing can be more unnatural. Its effects, at the same time, are deplorable. First, it gives an air of fiction to the whole; and prevents that impression of reality which is requisite to interest our affections, and to move our passions: this of itself is sufficient to explode machinery, whatever entertainment it may afford to readers of a fantastic taste or irregular imagination. And, next, were it possible, by disguising the fiction, to delude us into a notion of reality, an insuperable objection would still remain, which is, that the aim or end of an epic poem can never be attained in any perfection where machinery is introduced; for an evident reason, that virtuous emotions cannot be raised successfully but by the actions of those who are endued with passions and affections like our own, that is, by human actions: and as for moral instruction, it is clear, that none can be drawn from beings who act not upon the same principles with us. A fable in *Æsop's* manner is no objection to this reasoning: his lions, bulls, and goats, are truly men under disguise: they act and feel in every respect as human beings; and the moral we draw is founded on that supposition. Homer, it is true, introduces the gods into his fable: but he was authorized to take that liberty by the religion of his country; it being an article in the Grecian creed, that the gods often interpose visibly and bodily in human affairs. We must however observe, that Homer's deities do no honour to his poems: fictions that transgress the bounds of nature, seldom have a good effect: they may inflame the imagination for a moment, but will not be relished by any person of a correct taste. Let us add, that of whatever use such fictions may be to a mean genius, an able writer has much finer materials of Nature's production, for elevating his subject, and making it interesting.

The marvellous is indeed so much promoted by machinery, that it is not wonderful to find it embraced by the bulk of writers, and perhaps of readers. If indulged at all, it is generally indulged to excess. Homer introduces his deities with no greater ceremony than his mortals; and Virgil has still less moderation: a pilot spent with watching cannot fall asleep and drop into the sea by natural means: one bed cannot hold the two lovers, *Æneas* and *Dido*, without the immediate interposition of superior powers. The ridiculous in such fictions must appear, even through the thickest veil of gravity and solemnity.

Angels and devils serve equally with the Heathen deities, as materials for figurative language, perhaps better among Christians, because we believe in them, and not in the Heathen deities. But every one is sensible, as well as Boileau, that the invisible powers in our creed make a much worse figure as actors in a modern poem, than the invisible powers in the Heathen creed did in ancient times. The reason seems to be what follows. The Heathen deities, in the opinion of their votaries,

were beings elevated one step only above mankind, actuated by the same passions, and directed by the same motives; therefore not altogether improper to mix with men in an important action. In our creed, superior beings are placed at such a mighty distance from us, and are of a nature so different, that with no propriety can they appear with us upon the same stage: man is a creature so much inferior, that he loses all dignity when set in opposition.

There can be no doubt, that an historical poem admits the embellishment of allegory, as well as of metaphor, simile, or other figure. Moral truth, in particular, is finely illustrated in the allegorical manner: it amuses the fancy to find abstract terms, by a sort of magic, converted into active beings; and it is delightful to trace a general proposition in a pictured event. But allegorical beings should be confined within their own sphere, and never be admitted to mix in the principal action, nor to co-operate in retarding or advancing the catastrophe; which would have a still worse effect than invisible powers, and we are ready to assign the reason. The impression of real existence, essential to an epic poem, is inconsistent with that figurative existence which is essential to an allegory; and therefore no method can be more effectual to prevent the impression of reality, than to introduce allegorical beings co-operating with those whom we conceive to be really existing. The love-episode in the *Henriade*, insufferable by the discordant mixture of allegory with real life, is copied from that of Rinaldo and Armida in the *Jerusalemme liberata*, which hath no merit to intitle it to be copied. An allegorical object, such as Fame in the *Æneid*, and the Temple of Love in the *Henriade*, may find place in a description: but to introduce Discord as a real personage, imploring the assistance of Love as another real personage, to enervate the courage of the hero, is making these figurative beings act beyond their sphere, and creating a strange jumble of truth and fiction.

What is the true notion of an episode? or how is it to be distinguished from the principal action? Every incident that promotes or retards the catastrophe, must be a part of the principal action. This clears the nature of an episode; which may be defined, "An incident connected with the principal action, but contributing neither to advance nor retard it." The descent of *Æneas* into hell doth not advance nor retard the catastrophe; and therefore is an episode. The story of Nisus and Euryalus, producing an alteration in the affairs of the contending parties, is a part of the principal action. The family-scene in the sixth book of the *Iliad* is of the same nature: by Hector's retiring from the field of battle to visit his wife, the Grecians had liberty to breathe, and even to press upon the Trojans. Such being the nature of an episode, the unavoidable effect of it must be, to break in upon the unity of action; and therefore it ought never to be indulged, unless to unbend the mind after the fatigue of a long narration. This purpose of an episode demands the following conditions: it ought to be well connected with the principal action: it ought to be lively and interesting: it ought to be short: and a

time ought to be chosen when the principal action reels.

Next, upon the peculiarities of a dramatic poem. And the first we shall mention is a double plot; one of which must be of the nature of an episode in an epic poem; for it would distract the spectator, instead of entertaining him, if he were forced to attend, at the same time, to two capital plots equally interesting. And even supposing it an under-plot, of the nature of an episode, it seldom hath a good effect in tragedy, of which simplicity is a chief property; for an interesting subject that engages our warmest affections, occupies our whole attention, and leaves no room for any separate concern. Variety is more tolerable in comedy, which pretends only to amuse, without totally occupying the mind. But even here to make a double plot agreeable, is no slight effort of art: the under plot ought not to vary greatly in its tone from the principal; for discordant passions are unpleasant when jumbled together; which, by the way, is an insuperable objection to tragi-comedy. Upon this account, we blame the *Provoked Husband*: all the scenes that bring the family of the *Wrongheads* into action, being ludicrous and farcical, agree very ill with the principal scenes, displaying severe and bitter expostulations between lord Townly and his lady. The same objection touches not the double plot of the *Careless Husband*; the different subjects being sweetly connected, and having only so much variety as to resemble shades of colours harmoniously mixed. But this is not all. The under plot ought to be connected with that which is principal, so much at least as to employ the same persons: the under-plot ought to occupy the intervals or pauses of the principal action; and both ought to be concluded together. This is the case of the *Merry Wives of Windsor*.

Violent action ought never to be represented on the stage. While the dialogue runs on, a thousand particulars concur to delude us into an impression of reality, genuine sentiments, passionate language, and persuasive gesture: the spectator once engaged, is willing to be deceived, loses sight of himself, and without scruple enjoys the spectacle as a reality. From this absent state, he is roused by violent action: he wakes as from a pleasing dream, and gathering his senses about him, finds all to be a fiction.

The French critics join with Horace in excluding from the stage the shedding blood; but they have overlooked the most substantial objection, that above-mentioned, urging only that it is barbarous, and shocking to a polite audience. But the Greeks had no notion of such delicacy, or rather effeminacy; witness the murder of Clytemnestra by her son Orestes, passing behind the scene, as represented by Sophocles: her voice is heard calling out for mercy, bitter expostulations on his part, loud shrieks upon her being stabbed, and then a deep silence. We appeal to every person of feeling, whether this scene be not more horrible, than if the deed had been committed in sight of the spectators upon a sudden gust of passion. If Corneille, in representing the affair between Horatius and his sister upon which murder ensues behind the scene,

had

had no other view but to remove from the spectators a shocking action, he certainly was in a capital mistake: for murder in cold blood, which in some measure was the case as represented, is more shocking to a polite audience, even where the conclusive stab is not seen, than the same act performed in their presence, when it is occasioned by violent and unpremeditated passion, as suddenly repented of as committed. We heartily agree with Addison, that no part of this incident ought to have been represented, but reserved for a narrative, with every alleviating circumstance in favour of the hero. This is the only method to avoid the difficulties that unqualify this incident for representation, a deliberate murder on the one hand, and on the other a violent action performed on the stage, which must rouse the spectator from his dream of reality.

A few words upon the dialogue, which ought to be so conducted as to be a true representation of nature. Every single speech, short or long, ought to arise from what is said by the former speaker, and furnish matter for what comes after, till the end of the scene. In this view, the whole speeches, from first to last, represent so many links, all connected together in one regular chain. No author, ancient or modern, possesses the art of dialogue equal to Shakespeare. Dryden in this particular may justly be placed as his opposite: he frequently introduces three or four persons speaking upon the same subject, each throwing out his own sentiments separately, without regarding what is said by the rest; take for an example the first scene of *Aurenzebe*: sometimes he makes a number club in relating an event, not to a stranger, supposed ignorant of it, but to one another, for the sake merely of speaking: of which notable sort of dialogue, we have a specimen in the first scene of the first part of the *Conquest of Granada*. In the second part of the same tragedy, scene second, the king, *Abenamar*, and *Zulema*, make their separate observations, like so many soliloquies, upon the fluctuating temper of the mob: a dialogue so uncouth, puts one in mind of two shepherds in a pastoral, excited by a prize to pronounce verses alternately, each in praise of his own mistress.

The bandying sentiments in this manner, beside an unnatural air, has another bad effect: it stays the course of the action, because it is not productive of any consequence. In Congreve's comedies, the action is often suspended to make way for a play of wit.

No fault is more common among writers, than to prolong a speech after the impatience of the person to whom it is addressed ought to prompt him or her to break in. Consider only how the impatient actor is to behave in the mean time. To express his impatience in violent action without interrupting, would be unnatural; and yet to dissemble his impatience by appearing cool where he ought to be highly inflamed, would be no less unnatural.

Rhyme being unnatural and disgustful in dialogue, is happily banished from our theatre: the only wonder is, that it ever found admittance, especially among a people accustomed to the more manly freedom of Shakespeare's dialogue. By banishing rhyme, we have gained so much

as never once to dream that there can be any further improvement. And yet, however suitable blank verse may be to elevated characters and warm passions, it must appear improper and affected in the mouths of the lower sort. Why then should it be a rule, that every scene in tragedy must be in blank verse? Shakespeare, with great judgment, has followed a different rule; which is, to intermix prose with verse, and only to employ the latter where the importance or dignity of the subject requires it. Familiar thoughts and ordinary facts ought to be expressed in plain language; and if it appear not ridiculous to hear a footman deliver a simple message in blank verse, a veil must be drawn over the ridiculous appearance by the force of custom. In short, that variety of characters and of situations, which is the life of a play, requires not only a suitable variety in the sentiments, but also in the diction.

**COMPOSITION**, in painting, consists of two parts, invention and disposition; the first whereof is the choice of the objects which are to enter into the composition of the subject the painter intends to execute, and is either simply historical or allegorical.

**COMPOSITION**, in commerce, a contract between an insolvent debtor and his creditors, whereby the latter accept of a part of the debt in compensation for the whole, and give a general acquittance accordingly.

**COMPOSITION**, in printing, commonly termed composing, the arranging of several types, or letters, in the composing-stick, in order to form a line; and of several lines ranged in order in the galley, to make a page; and of several pages, to make a form. See **PRINTING**.

**COMPOST**, in husbandry and gardening, several sorts of soils, or earthy matter, mixed together, in order to make a manure, for assisting the natural earth in the work of vegetation, by way of amendment or improvement. See **AGRICULTURE**.

**COMPOSTELLA**, the capital of Galicia, in Spain, remarkable for the devotion paid there by pilgrims from all countries to the relics of St James.

**COMPOUND**, in a general sense, an appellation given to whatever is composed, or made up of different things: thus we say, a compound word, compound sound, compound taste, compound force, &c.

**COMPOUND-INTEREST**. See **INTEREST**.

**COMPOUND NUMBERS**, those which may be divided by some other number besides unity, without leaving any remainder: such are 18, 20, &c. the first being measured by the numbers 2, 6, or 9; and the second by the numbers 2, 4, 5, 10.

**COMPREHENSION**, in logic, the same with apprehension.

**COMPRESSION**, the act of pressing or squeezing some matter, so as to set its parts nearer to each other, and make it possess less space.

**COMPRINT**, among bookellers, signifies a surreptitious printing of another's copy, in order to gain thereby, which is expressly contrary to statute 14 Car. II.

**COMPROMISE**, a treaty, or contract, whereby two contending

- contending parties establish one or more arbitrators, to judge of and terminate their difference in an amicable way.
- COMPUNCTION**, in theology, an inward grief of mind, for having offended God.
- COMPUTATION**, in a general sense, the manner of estimating time, weights, measure, ~~monies~~, or quantities of any kind.
- CONARION**, or **CONOIDES**, a name for the pineal gland. See Vol. I. p. 286.
- CONATUS**, a term frequently used in philosophy and mathematics, defined by some to be a quantity of motion, not capable of being expressed by any time, or length; as the *conatus recedendi ab axe motus*, is the endeavour which a body, moved circularly, makes to recede, or fly off from the centre or axis of its motion. See **MECHANICS**.
- CONCATENATION**, a term chiefly used in speaking of the mutual dependence of second causes upon each other.
- CONCAVE**, an appellation used in speaking of the inner surface of hollow bodies, but more especially of spherical ones.
- CONCAVE GLASSES**, such as are ground hollow, and are usually of a spherical figure, though they may be of any other, as parabolical, &c. All objects seen through concave glasses, appear erect and diminished. See **OPTICS**.
- CONCENTRATION**, in general, signifies the bringing things nearer a center. Hence the particles of salt, in sea-water, are said to be concentrated; that is, brought nearer each other, by evaporating the watery part. See **CHEMISTRY**.
- CONCENTRIC**, in mathematics, something that has the same common center with another: it stands in opposition to excentric.
- CONCEPTION**, among physicians, &c. denotes the first formation of an embryo in the womb of its parent, who from that time becomes pregnant. See **GENERATION**.
- CONCEPTION**, in logic. See **APPREHENSION**.
- CONCEPTION**, in geography, a city of Chili, in South America, situated on the Pacific Ocean, in 79° W. long. and 37° S. lat.
- CONCEPTION** is also the capital of the province of Veragua, in Mexico, about 100 miles west of Porto Bello: W. long. 83°, and N. lat. 10°.
- CONCERT**, or **CONCERTO**, in music, a number or company of musicians, playing or singing the same piece of music or song at the same time. See **MUSIC**.
- CONCERTATO** intimates the piece of music to be composed in such a manner, as that all the parts may have their recitativos, be it for two, three, four, or more voices or instruments.
- CONCERTO GROSSI**, the grand chorus of a concert, or those places where all the several parts perform or play together.
- CONCHA**, in zoology, a synonyme of the **MYTILUS**, **SOLEA**, &c. See these articles.
- CONCHA**, in anatomy. See Vol. I. p. 297.
- CONCHOID**, in geometry, the name of a curve, given it by its inventor Nicomedes. See **FLUXIONS**.
- CONCHYLIA**, a general name for all kinds of petrified shells, as limpets, cochlea, nautili, conchæ, lepadæ, &c.
- CONCINNOUS intervals**, in music, are such as are fit for music, next to, and in combination with concords; being neither very agreeable, nor disagreeable in themselves, but having a good effect, as by their opposition they heighten the more essential principles of pleasure; or as by their mixture and combination with them, they produce a variety necessary to our being better pleased.
- CONCINNOUS system**, in music. A system is said to be concinuous, or divided concinuously, when its parts, considered as simple intervals, are concinuous; and are besides placed in such an order between the extremes, as that the succession of sounds, from one extreme to the other, may have an agreeable effect.
- CONCLAVE**, the place in which the cardinals of the Romish church meet, and are shut up, in order to the election of a pope.
- The conclave is a range of small cells, ten feet square, made of wainscot: these are numbered, and drawn for by lot. They stand in a line along the galleries and hall of the Vatican, with a small space between each. Every cell has the arms of the cardinal over it. The conclave is not fixed to any one determinate place, for the constitutions of the church allow the cardinals to make choice of such a place for the conclave as they think most convenient; yet it is generally held in the Vatican.
- The conclave is very strictly guarded by troops: neither the cardinals, nor any person shut up in the conclave, are spoke to, but at the hours allowed of, and then in Italian or Latin; even the provisions for the conclave are examined, that no letters be conveyed by that means from the ministers of foreign powers, or other persons who may have an interest in the election of the pontiff.
- CONCLAVE** is also used for the assembly, or meeting, of the cardinals shut up, for the election of a pope.
- CONCLUSION**, in logic, the consequence or judgment, drawn from what was asserted in the premises; or the previous judgments in reasoning, gained from combining the extreme ideas between themselves.
- CONCOCTION**, in medicine, the change which the food undergoes in the stomach, &c. to become chyle. See **CHYLE**.
- CONCOMITANT**, something that accompanies or goes along with another.
- CONCORD**, in grammar, that part of construction called syntax, in which the words of a sentence agree; that is, in which nouns are put in the same gender, number, and case; and verbs in the same number and person with nouns and pronouns.
- CONCORD**, in music, the relation of two sounds that are always agreeable to the ear, whether applied in succession or consonance. See **MUSIC**.
- CONCORDANCE**, a sort of dictionary of the Bible, explaining



explaining the words thereof in alphabetical order, with the several books, chapters, and verses quoted, in which they are contained.

**CONCORDIA**, in geography, a town of the dutchy of Mantua in Italy, about fifteen miles south east of the city of Mantua: E. long.  $11^{\circ} 20'$ , and N. lat.  $45^{\circ}$ .

**CONCRETE**, in the school-philosophy, an assemblage or compound.

**CONCRETE**, in natural philosophy and chemistry, signifies a body made up of different principles, or any mixed body: thus soap is a factitious concrete, or a body mixed together by art; and antimony is a natural concrete, or a mixed body, compounded in the bowels of the earth.

**CONCRETION**, the uniting together several small particles of a natural body into sensible masses, or concretes, whereby it becomes so and so figured and determined, and is endued with such and such properties.

**CONCRETION** is also the act whereby soft bodies are rendered hard; or an insensible motion of the particles of a fluid or a soft body, whereby they come to a consistence. It is indifferently used for induration, condensation, congelation, and coagulation.

**CONCUBINAGE**, denotes sometimes a criminal or prohibited commerce between the sexes; in which sense it comprehends adultery, incest, and simple fornication: but, in a more limited sense, it signifies the cohabitation of a man and a woman in the way of marriage, without having passed the ceremony thereof.

**CONCUBINE**, a woman whom a man takes to cohabit with in the manner of a wife, without being authorised thereto by a legal marriage.

**CONCUPISCENCE**, according to divines, an irregular appetite, or lust after carnal things, inherent in the nature of man ever since the fall.

**CONDAMIN**, in botany. See **CINCHONA**.

**CONDE**, a town of the French Netherlands, in the province of Hainault, situated on the river Scheld, about twelve miles west of Mons: E. long.  $3^{\circ} 40'$ , N. lat.  $50^{\circ} 35'$ .

**CONDENSATION**, the act whereby a body is rendered more dense, compact, and heavy.

**CONDENSER**, a pneumatic engine, or syringe, whereby an uncommon quantity of air may be crowded into a given space; so that sometimes ten atmospheres, or ten times as much air as there is at the same time, in the same space, without the engine, may be thrown in by means of it, and its egress prevented by valves properly disposed. See **PNEUMATICS**.

**CONDITION**, in the civil law, a clause of obligation stipulated as an article of a treaty or contract; or in a donation of testament, legacy, &c. in which last case a donee does not lose his donative, if it be charged with any dishonest or impossible conditions.

**CONDITIONALS**, something not absolute but subject to conditions.

**CONDOM**, the capital of the Condomois, in the province of Gascony, in France, about sixty miles south-east of Bourdeaux. It is a bishop's see, and situated in  $20'$  E. long. and  $44^{\circ} 5'$  N. lat.

**CONDORMIENTES**, in church history, religious sectaries, who hold their name from lying all together, men and women, young and old. They arose in the thirteenth century near Cologne, where they are said to have worshipped an image of Lucifer, and to have received answers and oracles from him.

**CONDUCTOR**, in surgery, an instrument which serves to conduct the knife in the operation of cutting for the stone, and in laying up sinuses and fistulas. See **SURGERY**.

**CONDUIT**, a canal or pipe for the conveyance of water, or other fluid.

There are several subterraneous conduits through which the waters pass that form springs. Artificial conduits for water are made of lead, stone, cast-iron, potter's earth, timber, &c.

**CONDYLOMA**, in medicine, a tubercle or callous eminence which arises in the folds of the anus, or rather a swelling or hardening of the wrinkles of that part.

**CONDYLUS**, a name given by anatomists to a knot in any of the joints, formed by the epiphysis of a bone.

**CONE**, in geometry, a solid figure, having a circle for its base, and its top terminated in a point or vertex. See **CONIC SECTIONS**.

**CONE of rays**, in optics, includes all the several rays which fall from any radiant point on the surface of a glass. See **OPTICS**.

**CONESSI**, a sort of bark of a tree which grows on the Coromandel coast in the East-Indies. It is recommended in a letter to Dr Monro, in the Medical Essays, as a specific in diarrhœas. It is to be pounded into a fine powder, and made into an electuary with syrup of oranges; and the bark should be fresh, and the electuary new made every day, or second day, otherwise it loses its austere but grateful bitterness on the palate, and its proper effects on the intestines.

**CONFECTION**, in pharmacy, signifies in general any thing prepared with sugar: in particular, it imports something preserved, especially dry substances. It also signifies a liquid or soft electuary, of which there are various sorts directed in dispensatories.

**CONFECTS**, a denomination given to fruits, flowers, herbs, roots, &c. when boiled or prepared with sugar or honey, to dispose them to keep, and render them more agreeable to the taste.

**CONFERVA**, in botany, a genus of the cryptogamia alge class, consisting of oblong, capillary filaments; without any joints. There are twenty-one species.

**CONFESSION**, in a legal sense, an acknowledgment of some truth, though in prejudice of the person that makes the declaration.

**CONFESSION**, among divines, the verbal acknowledgement which a Christian makes of his sins.

Among the Jews it was a custom, on the annual feast of expiation, for the high-priest to make confession of sins to God in the name of the whole people: besides this general confession, the Jews were enjoined, if their sins were a breach of the first table of the law, to make confession of them to God; but violations offered the second table, were to be acknowledged to their brethren. The confessions of the primitive Christians

stians were all voluntary, and not imposed on them by any laws of the church; yet private confession was not only allowed, but encouraged.

The Romish church requires confession not only as a duty, but has advanced it to the dignity of a sacrament: this confession is made to the priest, and is private and auricular; and the priest is not to reveal them under pain of the highest punishment.

**CONFESSIO** *of faith*, a list of the several articles of belief in any church.

**CONFESSIO****NAL**, or **CONFESSIO****NARY**, a place in churches, under the great altar, where the bodies of deceased saints, martyrs, and confessors, were deposited.

**CONFESSOR**, in the Romish church, a priest who is empowered to receive the confession of penitents, and to give them absolution.

**CONFIGURATION**, the outward figure which bounds bodies, and gives them their external appearance; being that which, in a great measure, constitutes the specific difference between bodies.

**CONFIRMATION** *by a superior*. See **SCOTS LAW**, title, *Transmission of rights by confirmation*.

**CONFIRMATION** *of a testament*. See **SCOTS LAW**, title, *Succession in moveables*.

**CONFIRMATION**, in theology, the ceremony of laying on of hands, for the conveyance of the Holy Ghost.

The antiquity of this ceremony is, by all ancient writers, carried as high as the apostles, and founded upon their example and practice. In the primitive church, it used to be given to Christians immediately after baptism, if the bishop happened to be present at the solemnity. Among the Greeks, and throughout the East, it still accompanies baptism: but the Romanists make it a distinct independent sacrament. Seven years is the stated time for confirmation: however, they are sometimes confirmed before, and sometimes after that age. The person to be confirmed has a god-father and god mother appointed him, as in baptism. The order of confirmation in the church of England, does not determine the precise age of the persons to be confirmed.

**CONFISCATION**, in law, the adjudication of goods or effects to the public treasury; as the bodies and effects of criminals, traitors, &c.

**CONFLAGRATION**, the general burning of a city, or other considerable place.

This word is commonly applied to that grand period or catastrophe of our world, when the face of nature is to be changed by fire, as formerly it was by water.

**CONFLUENT**, among physicians, &c. an appellation given to that kind of small-pox wherein the pustules run into each other. See **MEDICINE**.

**CONFORMATION**, the particular consistence and texture of the parts of any body, and their disposition to compose a whole.

**CONFORMATION**, in medicine, that make and construction of the human body, which is peculiar to every individual.

**CONFORMITY**, among schoolmen, the relation of agreement between one thing and another; as that be-

tween any thing and the division thereof, the object and the understanding, &c.

**CONFUSION**, in Scots law, is a method of extinguishing and suspending obligations. See **SCOTS LAW**, title, *Extinction of obligations*.

**CONGE' d'lire**, in ecclesiastical polity, the king's permission royal to a dean and chapter in the time of a vacancy, to chuse a bishop; or to an abbey, or priory, of his own foundation, to chuse their abbot or prior.

The king of England, as sovereign patron of all archbishoprics, bishoprics, and other ecclesiastical benefices, had of ancient time free appointment of all ecclesiastical dignities, whensoever they chanced to be void; investing them first *per baculum & annulum*, and afterwards by his letters-patent; and in course of time he made the election over to others, under certain forms and limitations, as that they should at every vacation, before they chuse, demand the king's congé d'lire, and after the election crave his royal assent, &c.

**CONGE'**, in architecture, a mould in form of a quarter round or a cavetto, which serves to separate two members from one another, such as that which joins the shaft of the column to the cincture, called also apophyge.

**CONGES** are also rings or ferrels formerly used in the extremities of wooden pillars, to keep them from splitting, afterwards imitated in stone-work.

**CONGELATION**, freezing, or such a change produced by cold in a fluid body, that it quits its former state, and becomes congealed. See **FREEZING**.

**CONGER**, in zoology. See **MURÆNA**.

**CONGERIES**, a constellation or aggregate of several particles or bodies united into one mass.

**CONGIUS**, a liquid measure of the ancient Romans, containing the eighth part of the amphora, or the fourth of the urna, or six sextarii. The congius in English measure contains 2,070 676 solid inches; that is, seven pints, 4,942 solid inches.

**CONGLOBATE gland**, in anatomy. See Vol. I. p. 263.

**CONGLOMERATE gland**, in anatomy. See Vol. I. p. 265. *bottom*.

**CONGLUTINATION**, the gluing or fastening any two bodies together by the intromission of a third, whose parts are unctuous and tenacious, in the nature of glue. See **GLUE**.

**CONGO**, a large country on the western coast of Africa, between 10° and 20° E. long. and between the equator and 18° S. lat. comprehending the countries of Loango, Angola, and Benguela. It is bounded by the kingdom of Benin on the north; by Mataman, a part of Caffraria, on the south; and by the Atlantic ocean, on the west; and is sometimes called the lower Guinea.

**CONGREGATION**, an assembly of several ecclesiastics united, so as to constitute one body; as an assembly of cardinals, in the constitution of the pope's court, met for the dispatch of some particular business.

These assemblies, being sixteen in number, are distributed

distributed into several chambers, after the manner of our offices and courts: the first whereof is the pope's congregation, whose business it is to prepare the most difficult beneficiary matters to be afterward debated in the consistory: the second is the congregation of the holy office, or the inquisition: the third is the congregation *de propaganda fide*: the fourth is the congregation for explaining the council of Trent: the fifth is the congregation of the index, deputed to examine into pernicious and heretical books: the sixth is the congregation of immunities, established to obviate the difficulties that arise in the judgments of such suits as are carried on against churchmen: the seventh is the congregation of bishops and regulars: the eighth is the congregation for the examination of bishops, &c. It is also used for a company or society of religious, canonized out of any order, so as to make a subdivision of the order itself; as the congregation of Cluny, &c. among the Benedictines. It is likewise used for assemblies of pious persons, in manner of fraternities.

**CONGREGATIONALISTS**, in church-history, a sect of protestants who reject all church-government, except that of a single congregation.

**CONGRESS**, in political affairs, an assembly of commissioners, envoys, deputies, &c. from several courts meeting to concert matters for their common good.

**CONGRESS**, in a judicial sense, the trial made by appointment of a judge, before surgeons and matrons, in order to prove whether or no a man be impotent, before sentence is passed for the dissolution of a marriage, solicited upon such a complaint.

**CONGRUITY**, a suitableness or relation of agreement between things.

The terms *congruity* and *propriety* are not applicable to any single object: they imply a plurality, and obviously signify a particular relation between different objects. Thus we say currently, that a decent garb is suitable or proper for a judge, modest behaviour for a young woman, and a lofty style for an epic poem: and, on the other hand, that it is unsuitable or incongruous to see a little woman sunk in an overgrown farthingale, a coat richly embroidered covering coarse and dirty linen, a mean subject in an elevated style, an elevated subject in a mean style, a first minister darning his wife's stocking, or a reverend prelate in lawn sleeves dancing a hornpipe.

The perception we have of this relation, which seems peculiar to man, cannot proceed from any other cause, but from a *sense* of congruity or propriety; for, supposing us destitute of that sense, the terms would be to us unintelligible.

It is a matter of experience, that congruity or propriety, where-ever perceived, is agreeable; and that incongruity or impropriety, where-ever perceived, is disagreeable. The only difficulty is, to ascertain what are the particular objects that in conjunction suggest these relations; for there are many objects that do not: the sea, for example, viewed in conjunction with a picture, or a man viewed in conjunction with a mountain, suggest not either congruity or incongrui-

ty. It seems natural to infer, what will be found true by induction, that we never perceive congruity nor incongruity but among things that are connected together by some relation; such as a man and his actions, a principal and its accessories, a subject and its ornaments. We are indeed so framed by nature, as among things so connected, to require a certain suitableness or correspondence, termed *congruity* or *propriety*; and to be displeased when we find the opposite relation of *incongruity* or *impropriety*.

If things connected be the subject of congruity, it is reasonable beforehand to expect, that a degree of congruity should be required proportioned to the degree of the connection. And upon examination we find this to hold in fact: where the relation is intimate, as between a cause and its effect, a whole and its parts, we require the strictest congruity; but where the relation is slight, or accidental, as among things jumbled together in the same place, we require little or no congruity: the strictest propriety is required in behaviour and manner of living; because a man is connected with these by the relation of cause and effect: the relation between an edifice and the ground it stands upon, is of the most intimate kind, and therefore the situation of a great house ought to be lofty; its relation to neighbouring hills, rivers, plains, being that of propinquity only, demands but a small share of congruity: among members of the same club, the congruity ought to be considerable, as well as among things placed for show in the same niche: among passengers in a stage-coach, we require very little congruity; and less still at a public spectacle.

Congruity is so nearly allied to beauty, as commonly to be held a species of it; and yet they differ so essentially, as never to coincide: beauty, like colour, is placed upon a single subject; congruity upon a plurality: further, a thing beautiful in itself, may, with relation to other things, produce the strongest sense of incongruity.

Congruity and propriety are commonly reckoned synonymous terms; but they are distinguishable; and the precise meaning of each must be ascertained. Congruity is the genus, of which propriety is a species; for we call nothing *propriety*, but that congruity or suitableness, which ought to subsist between sensible beings and their thoughts, words, and actions.

In order to give a full view of these secondary relations, we shall trace them through some of the most considerable primary relations. The relation of a part to the whole, being extremely intimate, demands the utmost degree of congruity; even the slightest deviation is disgusting.

Examples of congruity and incongruity are furnished in plenty by the relation between a subject and its ornaments. A literary performance intended merely for amusement, is susceptible of much ornament, as well as a music room, or a play-house; for in gaiety, the mind hath a peculiar relish for show and decoration. The most gorgeous apparel, however improper in tragedy, is not unsuitable to opera-actors: the truth is, an opera, in its present form, is a mighty fine thing; but as it deviates from nature in its capital circumstances, we look not for nature

nor.

nor propriety in those which are accessory. On the other hand, a serious and important subject admits not much ornament; nor a subject that of itself is extremely beautiful: and a subject that fills the mind with its loftiness and grandeur, appears best in a dress altogether plain.

To a person of a mean appearance, gorgeous apparel is unsuitable; which, besides the incongruity, has a bad effect; for by contrast it shows the meanness of appearance in the strongest light. Sweetness of look and manner, requires simplicity of dress joined with the greatest elegance. A stately and majestic air requires sumptuous apparel, which ought not to be gaudy, nor crowded with little ornaments. A woman of consummate beauty can bear to be highly adorned, and yet shows best in a plain dress:

————— For loveliness  
Needs not the foreign aid of ornament,  
But is when unadorn'd, adorn'd the most.

*Thomson's Autumn, 208.*

Congruity regulates not only the quantity of ornament, but also the kind. The ornaments that embellish a dancing-room ought to be all of them gay. No picture is proper for a church, but what has religion for its subject. All the ornaments upon a shield ought to relate to war; and Virgil, with great judgment, confines the carvings upon the shield of Æneas to the military history of the Romans: but this beauty is overlooked by Homer; for the bulk of the sculpture upon the shield of Achilles, is of the arts of peace in general, and of joy and festivity in particular: the author of Telemachus betrays the same inattention, in describing the shield of that young hero.

In judging of propriety with regard to ornaments, we must attend, not only to the nature of the subject that is to be adorned, but also to the circumstances in which it is placed: the ornaments that are proper for a ball, will appear not altogether so decent at public worship; and the same person ought to dress differently for a marriage-feast and for a burial.

Nothing is more intimately related to a man, than his sentiments, words, and actions; and therefore we require here the strictest conformity. When we find what we thus require, we have a lively sense of propriety: when we find the contrary, our sense of impropriety is not less lively. Hence the universal distaste of affectation, which consists in making a shew of greater delicacy and refinement than is suited either to the character or circumstances of the person.

Congruity and propriety, where-ever perceived, appear agreeable; and every agreeable object produceth in the mind a pleasant emotion: incongruity and impropriety, on the other hand, are disagreeable; and of course produce painful emotions. These emotions, whether pleasant or painful, sometimes vanish without any consequence; but more frequently occasion other emotions, which we proceed to exemplify.

When any slight incongruity is perceived, in an accidental combination of persons or things, as of passengers in a stage-coach, or of individuals dining at an ordinary; the painful emotion of incongruity, after a momentary existence, vanisheth without producing any effect. But

this is not the case of propriety and impropriety: voluntary acts, whether words or deeds, are imputed to the author; when proper, we reward him with our esteem; when improper, we punish him with our contempt. Let us suppose, for example, a generous action suited to the character of the author, which raises in him and in every spectator the pleasant emotion of propriety: this emotion generates in the author both self-esteem and joy; the former when he considers his relation to the action, and the latter when he considers the good opinion that others will entertain of him: the same emotion of propriety produceth in the spectators esteem for the author of the action; and when they think of themselves, it also produceth, by means of contrast, an emotion of humility. To discover the effects of an unsuitable action, we must invert each of these circumstances: the painful emotion of impropriety generates in the author of the action both humility and shame; the former when he considers his relation to the action, and the latter when he considers what others will think of him; the same emotion of impropriety produceth in the spectators contempt for the author of the action; and it also produceth, by means of contrast, when they think of themselves, an emotion of self-esteem. Here then are many different emotions, derived from the same action considered in different views by different persons; a machine provided with many springs, and not a little complicated. Propriety of action, it would seem, is a chief favourite of nature, when such care and solicitude is bestowed upon it. It is not left to our own choice; but, like justice, is required at our hands; and, like justice, is enforced by natural rewards and punishments: a man cannot, with impunity, do any thing unbecoming or improper; he suffers the chastisement of contempt inflicted by others, and of shame inflicted by himself. An apparatus so complicated, and so singular, ought to rouse our attention: for nature doth nothing in vain; and we may conclude with great certainty, that this curious branch of the human constitution is intended for some valuable purpose.

A gross impropriety is punished with contempt and indignation, which are vented against the offender by corresponding external expressions: nor is even the slightest impropriety suffered to pass without some degree of contempt. But there are improprieties, of the slighter kind, that provoke laughter; of which we have examples without end, in the blunders and absurdities of our own species: such improprieties receive a different punishment, as will appear by what follows. The emotions of contempt and of laughter occasioned by an impropriety of this kind, uniting intimately in the mind of the spectator, are expressed externally by a peculiar sort of laugh, termed a *laugh of derision* or *scorn*. An impropriety that thus moves not only contempt but laughter, is distinguished by the epithet of *ridiculous*; and a laugh of derision or scorn is the punishment provided for it by nature. Nor ought it to escape observation, that we are so fond of inflicting this punishment, as sometimes to exert it even against creatures of an inferior species: witness a turkeycock swelling with pride, and strutting with displayed feathers; a ridiculous object, which in a gay mood is apt to provoke a laugh of derision.

We

We must not expect, that these different improprieties are separated by distinct boundaries : for of improprieties, from the slightest to the most gross, from the most risible to the most serious, there are degrees without end. Hence it is, that in viewing some unbecoming actions, too risible for anger, and too serious for derision, the spectator feels a sort of mixt emotion, partaking both of derision and of anger ; which accounts for an expression, common with respect to the impropriety of some actions, That we know not whether to laugh or be angry.

It cannot fail to be observed, that in the case of a risible impropriety, which is always slight, the contempt we have for the offender is extremely faint, though derision, its gratification, is extremely pleasant. This disproportion between a passion and its gratification, seems not conformable to the analogy of nature. In looking about for a solution, we must reflect upon what is laid down above, that an improper action not only moves our contempt for the author, but also, by means of contrast, swells the good opinion we have of ourselves. This contributes, more than any other article, to the pleasure we have in ridiculing follies and absurdities ; and accordingly, it is well known, that they who put the greatest value upon themselves are the most prone to laugh at others. Pride, which is a vivid passion, pleasant in itself, and not less so in its gratification, would singly be sufficient to account for the pleasure of ridicule, without borrowing any aid from contempt. Hence appears the reason of a noted observation, That we are the most disposed to ridicule the blunders and absurdities of others, when we are in high spirits ; for in high spirits, self-conceit displays itself with more than ordinary vigour.

With regard to the final causes of congruity and impropriety ; one, regarding congruity, is pretty obvious, that the sense of congruity, as one principle of the fine arts, contributes in a remarkable degree to our entertainment. Congruity, indeed, with respect to quantity, coincides with proportion : when the parts of a building are nicely adjusted to each other, it may be said indifferently, that it is agreeable by the congruity of its parts, or by the proportion of its parts. But propriety, which regards voluntary agents only, can never be the same with proportion : a very long nose is disproportioned, but cannot be termed *improper*. In some instances, it is true, impropriety coincides with disproportion in the same subject, but never in the same respect ; for example, a very little man buckled to a long toledo : considering the man and the sword with respect to size, we perceive a disproportion ; considering the sword as the choice of the man, we perceive an impropriety.

The sense of impropriety with respect to mistakes, blunders, and absurdities, is happily contrived for the good of mankind. In the spectators, it is productive of mirth and laughter, excellent recreation in an interval from business. But this is a trifle in respect of what follows. It is painful to be the subject of ridicule ; and to punish with ridicule the man who is guilty of an absurdity, tends to put him more upon his guard in time coming. Thus even the most innocent blunder is not committed with impunity ; because, were errors licensed where they

do no hurt, inattention would grow into a habit, and be the occasion of much hurt.

The final cause of propriety as to moral duties, is of all the most illustrious. To have a just notion of it, the moral duties that respect others must be distinguished from those that respect ourselves. Fidelity, gratitude, and the forbearing injury, are examples of the first sort ; temperance, modesty, firmness of mind, are examples of the other : the former are made duties by the sense of justice ; the latter by the sense of propriety. Here is a final cause of the sense of propriety, that must rouse our attention. It is undoubtedly the interest of every man, to suit his behaviour to the dignity of his nature, and to the station allotted him by Providence ; for such rational conduct contributes in every respect to happiness, by preserving health, by procuring plenty, by gaining the esteem of others, and, which of all is the greatest blessing, by gaining a justly-founded self-esteem. But in a matter so essential to our well-being, even self-interest is not relied on : the powerful authority of duty is superadded to the motive of interest. The God of nature, in all things essential to our happiness, hath observed one uniform method : to keep us steady in our conduct, he hath fortified us with natural laws and principles, which prevent many aberrations, that would daily happen were we totally surrendered to so fallible a guide as is human reason. Propriety cannot rightly be considered in another light, than as the natural law that regulates our conduct with respect to ourselves ; as justice is the natural law that regulates our conduct with respect to others. We call propriety a law, not less than justice ; because both are equally rules of conduct that ought to be obeyed : propriety includes this obligation ; for to say an action is proper, is, in other words, to say, that it *ought* to be performed ; and to say it is improper, is, in other words, to say that it *ought* to be forborn. It is this very character of *ought* and *should* that makes justice a law to us ; and the same character is applicable to propriety, though perhaps more faintly than to justice : but the difference is in degree only, not in kind ; and we ought, without hesitation or reluctance, to submit equally to the government of both.

But it must, in the next place, be observed, that to the sense of propriety, as well as of justice, are annexed the sanctions of rewards and punishments ; which evidently prove the one to be a law as well as the other. The satisfaction a man hath in doing his duty, joined with the esteem and good will of others, is the reward that belongs to both equally. The punishments also, though not the same, are nearly allied ; and differ in degree more than in quality. Disobedience to the law of justice, is punished with remorse ; disobedience to the law of propriety, with shame, which is remorse in a lower degree. Every transgression of the law of justice raises indignation in the beholder ; and so doth every flagrant transgression of the law of propriety. Slighter improprieties receive a milder punishment : they are always rebuked with some degree of contempt, and frequently with derision. In general, it is true, that the rewards and punishments annexed to the sense of propriety, are

slighter in degree than those annexed to the sense of justice: which is wisely ordered, because duty to others is still more essential to society, than duty to ourselves; for society could not subsist a moment, were individuals not

protected from the headstrong and turbulent passion of their neighbours.

CONI, a strong town of Piedmont in Italy, situated upon the river Stura, thirty two miles south of Turin, in  $7^{\circ} 30'$  E. long. and  $44^{\circ} 25'$  N. lat.

## C O N I C S E C T I O N S.

**C**ONIC SECTIONS are curve lines formed by the intersections of a cone and plane.

If a cone be cut by a plane through the vertex, the section will be a triangle ABC, Plate LXVII fig. 1.

If a cone be cut by a plane parallel to its base, the section will be a circle. If it be cut by a plane DEF, fig. 1. in such a direction, that the side AC of a triangle passing through the vertex, and having its base BC perpendicular to EF, may be parallel to DP, the section is a parabola; if it be cut by a plane DR, fig. 2. meeting AC, the section is an ellipse; and if it be cut by a plane DMO, fig. 3. which would meet AC extended beyond A, it is an hyperbola.

If any line HG, fig. 1. be drawn in a parabola perpendicular to DP, the square of HG will be to the square of EP, as DG to DP; for let LHK be a section parallel to the base, and therefore a circle, the rectangle LGK, will be equal, to the square of HG, and the rectangle BPC equal to the square of EP; therefore these squares will be to each other as their rectangles; that is, as BP to LG, that is DP to DG.

### Description of Conic Sections on a Plane.

#### P A R A B O L A.

"Let AB, fig. 4. be any right line, and C any point without it, and DKF a ruler, which let be placed in same plane in which the right line and point are, in such a manner that one side of it, as DK, be applied to the right line AB, and the other side KF coincide with the point C; and at F, the extremity of the side KF, let be fixed one end of the thread FNC, whose length is equal to KF, and the other extremity of it at the point C, and let part of the thread, as FG, be brought close to the side KF by a small pin G; then let the square DKF be moved from B towards A, so that all the while its side DK be applied close to the line BA, and in the mean time the thread being extended will always be applied to the side KF, being stopt from going from it by means of the small pin; and by the motion of the small pin N there will be described a certain curve, which is called a *semi parabola*.

"And if the square be brought to its first given position, and in the same manner be moved along the line AB, from B towards H, the other semi-parabola will be described."

The line AB is called the directrix; C, the focus; any line perpendicular to AB, a diameter; the point where it meets the curve, its vertex; and four times the di-

stance of the vertex from the directrix, its latus rectum, or parameter.

#### E L L I P S E.

"If any two points, as A and B, fig. 5. be taken in any plane, and in them are fixed the extremities of a thread, whose length is greater than the distance between the points, and the thread extended by means of a small pin C, and if the pin be moved round from any point until it returns to the place from whence it began to move, the thread being extended during the whole time of the revolution, the figure which the small pin by this revolution describes is called an *Ellipse*."

The points AB are called the foci; D, the centre; EF, the transverse axis; GH, the lesser axis; and any other line passing through D, a diameter.

#### H Y P E R B O L A.

"If to the point A, fig. 6. in any plane, one end of the rule AB be placed, in such a manner, that about that point, as a center, it may freely move; and if to the other end B, of the rule AB, be fixed the extremity of the thread BDC, whose length is smaller than the rule AB, and the other end of the thread being fixed in the point C, coinciding with the side of the rule AB, which is in the same plane with the given point A; and let part of the thread, as BD, be brought close to the side of the rule AB, by means of a small pin D; then let the rule be moved about the point A, from C towards T, the thread all the while being extended, and the remaining part coinciding with the side of the rule being stopt from going from it by means of the small pin, and by the motion of the small pin D, a certain figure is described which is called the *semi-hyperbola*."

The other semi-hyperbola is described in the same way, and the opposite HKF, by fixing the ruler to C, and the thread to A, and describing it in the same manner. A and C are called foci; the point G, which bisects AC, the center; KE, the transverse axis; a line drawn through the center meeting the hyperbolas, a transverse diameter; a line drawn through the center, perpendicular to the transverse axis, and cut off by the circle MN, whose center is E, and radius equal to CG, is called the second axis.

If a line be drawn through the vertex E, equal and parallel to the second axis GP and GO be joined, they are called asymptotes. Any line drawn through the center, not meeting the hyperbolas, and equal in length to the

part

part of a tangent parallel to it, and intercepted betwixt the asymptotes, is called a second diameter.

An ordinate to any section is a line bisected by a diameter and the abscissa, the part of the diameter cut off by the ordinate.

Conjugate diameters in the ellipse and hyperbola are such as mutually bisect lines parallel to the other; and a third proportional to two conjugate diameters is called the latus rectum of that diameter, which is the first in the proportion.

In the parabola, the lines drawn from any point to the focus are equal to perpendiculars to the directrix; being both equal to the part of the thread separated from the ruler.

In the ellipse, the two lines drawn from any point in the curve to the foci are equal to each other, being equal to the length of the thread; they are also equal to the transverse axis. In the hyperbola the difference of the lines drawn from any point to the foci is equal, being equal to the difference of the lengths of the ruler and thread, and is equal to the transverse axis.

From these fundamental properties all the others are derived.

The ellipse returns into itself. The parabola and hyperbola may be extended without limit.

Every line perpendicular to the directrix of a parabola meets it in one point, and falls afterwards within it; and every line drawn from the focus meets it in one point, and falls afterwards without it. And every line that passes through a parabola, not perpendicular to the directrix, will meet it again, but only once.

Every line passing through the center of an ellipse is bisected by it; the transverse axis is the greatest of all these lines; the lesser axis the least; and these nearer the transverse axis greater than those more remote.

In the hyperbola, every line passing through the center is bisected by the opposite hyperbola, and the transverse axis is the least of all these lines; also the second axis is the least of all the second diameters. Every line drawn from the center within the angle contained by the asymptotes, meets it once, and falls afterwards within it; and every line drawn through the center without that angle never meets it; and a line which cuts one of the asymptotes, and cuts the other extended beyond the center, will meet both the opposite hyperbolas in one point.

If a line  $GM$ , fig. 4. be drawn from a point in a parabola perpendicular to the axis, it will be an ordinate to the axis, and its square will be equal to the rectangle under the abscissa  $MI$  and latus rectum; for, because  $GMC$  is a right angle,  $GM^2$  is equal to the difference of  $GC^2$  and  $CM^2$ ; but  $GC$  is equal to  $GE$ , which is equal to  $MB$ ; therefore  $GM^2$  is equal to  $BM^2 - CM^2$ ; which, because  $CI$  and  $IB$  are equal, is (9 *Enc.* 2.) equal to four times the rectangle under  $MI$  and  $IB$ , or equal to the rectangle under  $MI$  and the *latus rectum*.

Hence it follows, that if different ordinates be drawn to the axis, their squares being each equal to the rectangle under the abscissa and latus rectum, will be to each other in the proportion of the abscissas, which is the same property as was shewn before to take place in the

parabola cut from the cone, and proves those curves to be the same.

This property is extended also to the ordinates of other diameters, whose squares are equal to the rectangle under the abscissas and parameters of their respective diameters.

In the ellipse, the square of the ordinate is to the rectangle under the segments of the diameter, as the square of the diameter parallel to the ordinate to the square of the diameter to which it is drawn, or as the first diameter to its latus rectum; that is,  $LK^2$  (fig. 5.) is to  $EKF$  as  $EF^2$  to  $GH^2$ .

In the hyperbola, the square of the ordinate is to the rectangle contained under the segments of the diameters betwixt its vertices, as the square of the diameter parallel to the ordinate to the square of the diameter to which it is drawn, or as the first diameter to its *latus rectum*; that is,  $SX^2$  is to  $EKK$  as  $MN^2$  to  $KE^2$ .

Or if an ordinate be drawn to a second diameter, its square will be to the sum of the squares of the second diameter, and of the line intercepted betwixt the ordinate and centre, in the same proportion; that is,  $RZ^2$  (fig. 6.) is to  $ZG^2$  added to  $GM^2$ , as  $KE^2$  to  $MN^2$ . These are the most important properties of the conic sections: and, by means of these, it is demonstrated, that the figures are the same described on a plane as cut from the cone; which we have demonstrated in the case of the parabola.

### Equations of the Conic Sections

ARE derived from the above properties. The equation of any curve, is an algebraic expression, which denotes the relation betwixt the ordinate and abscissa; the abscissa being equal to  $x$ , and the ordinate equal to  $y$ .

If  $p$  be the parameter of a parabola, then  $y^2 = px$ ; which is an equation for all parabolas.

If  $a$  be the diameter of an ellipse,  $p$  its parameter; then  $y^2 : ax - xx :: p : a$ ; and  $y^2 = \frac{p}{a} \times ax - xx$ ; an equation for all ellipses.

If  $a$  be a transverse diameter of a hyperbola,  $p$  its parameter; then  $y^2 : ax + xx :: p : a$ , and  $y^2 = \frac{p}{a} \times ax + xx$ .

If  $a$  be a second diameter of an hyperbola, then  $y^2 = aa + xx :: p : a$ ; and  $y^2 = \frac{p}{a} \times aa + xx$ ; which are equations for all hyperbolas.

As all these equations are expressed by the second powers of  $x$  and  $y$ , all conic sections are curves of the second order; and conversely, the locus of every quadratic equation is a conic section, and is a parabola, ellipse, or hyperbola, according as the form of the equation corresponds with the above ones, or with some other deduced from lines drawn in a different manner with respect to the section.

### General Properties of Conic Sections.

A TANGENT to a parabola bisects the angle contained by the lines drawn to the focus and directrix; in an ellipse

ellipse and hyperbola; it bisects the angle contained by the lines drawn to the foci.

In all the sections, lines parallel to the tangent are ordinates to the diameter passing through the point of contact; and in the ellipse and hyperbola, the diameters parallel to the tangent, and those passing through the points of contact, are mutually conjugate to each other. If an ordinate be drawn from a point to a diameter and a tangent from the same point which meets the diameter produced; in the parabola the part of the diameter betwixt the ordinate and tangent will be bisected in the vertex; and in the ellipse and hyperbola, the semi-diameter will be a mean proportion betwixt the segments of the diameter betwixt the center and ordinate, and betwixt the centre and tangent.

The parallelogram formed by tangents drawn through the vertices of any conjugate diameters, in the same ellipse or hyperbola, will be equal to each other.

#### *Properties peculiar to the Hyperbola.*

As the hyperbola has some curious properties arising from its asymptotes, which appear at first view almost incredible, we shall briefly demonstrate them.

1. The hyperbola and its asymptotes never meet: if not, let them meet in S, fig. 6.; then by the property of the curve the rectangle KXE is to  $SX^2$  as  $GE^2$  to  $GM^2$  or  $EP^2$ ; that is, as  $GX^2$  to  $SX^2$ ; wherefore, KXE will be equal to the square of GX; but the rectangle KXE, together with the square of GE, is also equal to the square of GX; which is absurd.

2. If a line be drawn through a hyperbola parallel to its second axis, the rectangle, by the segments of that line, betwixt the point in the hyperbola and the asymptotes, will be equal to the square of the second axis.

For, if SZ, fig. 6. be drawn perpendicular to the second axis, by the property of the curve, the square of MG, that is, the square of PE, is to the square of GE, as the squares of ZG and the square of MG together, to the square of SZ or GX: and the squares of RX and GX are in the same proportion, because the triangles RXG, PEG are equiangular; therefore the squares ZG and MG are equal to the square of RX; from which taking the equal squares of SX and ZG, there remains the rectangle RSV, equal to the square of MG.

3. Hence, if right lines be drawn parallel to the second axis, cutting an hyperbola and its asymptotes, the rectangles contained betwixt the hyperbola and points where the lines cut the asymptotes will be equal to each other; for they are severally equal to the square of the second axis.

4. If from any points,  $d$  and S, in a hyperbola, there be drawn lines parallel to the asymptotes  $da$  SQ and  $Sb$   $dc$ , the rectangle under  $da$  and  $dc$  will be equal to the rectangle under QS and  $Sb$ ; also the parallelograms  $da$ ,  $Gc$ , and SQG $b$ , which are equiangular, and consequently proportional to the rectangles, are equal.

For draw YW RV parallel to the second axis, the rectangle Y $d$ W is equal to the rectangle RSV; wherefore, WD is to SV as RS is to  $d$ Y. But because

the triangles RQS, AYD, and GSV  $cd$ W, are equiangular, W $d$  is to SV as  $cd$  to  $Sb$ , and RS is to DY as SQ to  $da$ ; wherefore,  $dc$  is to  $Sb$  as SQ to  $da$ : and the rectangle  $dc$ ,  $da$ , is equal to the rectangle QS,  $Sb$ .

5. The asymptotes always approach nearer the hyperbola.

For, because the rectangle under SQ and  $Sb$ , or QG, is equal to the rectangle under  $da$  and  $dc$ , or AG, and QG is greater than  $a$ G; therefore  $ad$  is greater than QS.

6. The asymptotes come nearer the hyperbola than any assignable distance.

Let X be any small line. Take any point, as  $d$ , in the hyperbola, and draw  $da$ ,  $dc$ , parallel to the asymptotes; and as X is to  $da$ , so let  $a$ G be to GQ. Draw QS parallel to  $ad$ , meeting the hyperbola in S, then QS will be equal to X. For the rectangle SQG will be equal to the rectangle  $da$ G; and consequently SQ is to  $da$  as AG to GQ.

If any point be taken in the asymptote below Q, it can easily be shown that its distance is less than the line X.

#### *Areas contained by Conic Sections.*

THE area of a parabola is equal to  $\frac{2}{3}$  the area of a circumscribed parallelogram.

The area of an ellipse is equal to the area of a circle whose diameter is a mean proportional betwixt its greater and lesser axes.

If two lines,  $ad$  and QS, be drawn parallel to one of the asymptotes of an hyperbola, the space  $a$ QS $d$ , bounded by these parallel lines, the asymptotes and the hyperbola will be equal to the logarithm of  $a$ Q, whose module is  $ad$ , supposing  $a$ G equal to unity.

#### *Curvature of Conic Sections.*

THE curvature of any conic section, at the vertices of its axis, is equal to the curvature of a circle whose diameter is equal to the parameter of its axis.

If a tangent be drawn from any other point of a conic section, the curvature of the section in that point will be equal to the curvature of a circle to which the same line is a tangent, and which cuts off from the diameter of the section, drawn through the point, a part equal to its parameter.

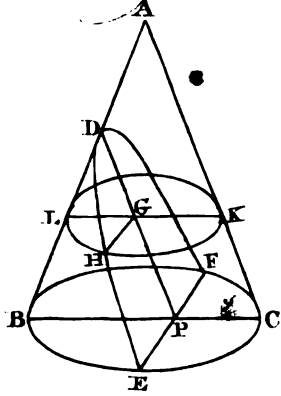
#### *Uses of Conic Sections.*

ANY body, projected from the surface of the earth, describes a parabola, to which the direction wherein it is projected is a tangent; and the distance of the directrix is equal to the height from which a body must fall to acquire the velocity wherewith it is projected: hence the properties of the parabola are the foundation of gunnery.

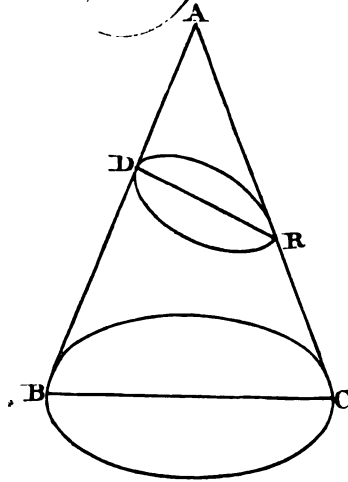
All bodies acted on by a central force, which decreases as the square of the distances increases, and impressed with any projectile motion, making any angle with the direction of the central force, must describe conic sections, having the central force in one of the foci, and will



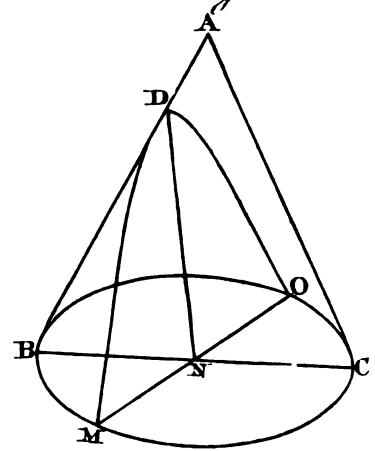
*Fig. 1.*



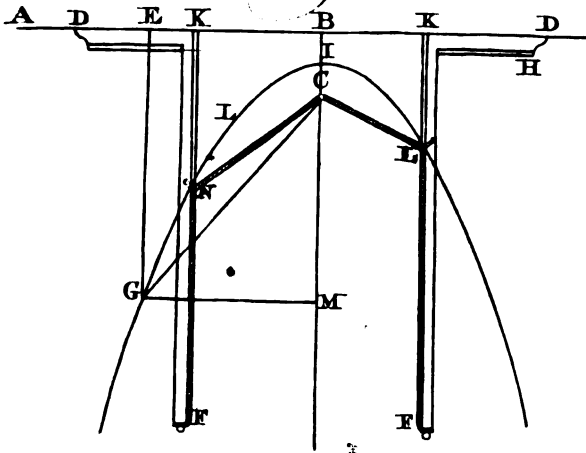
*Fig. 2.*



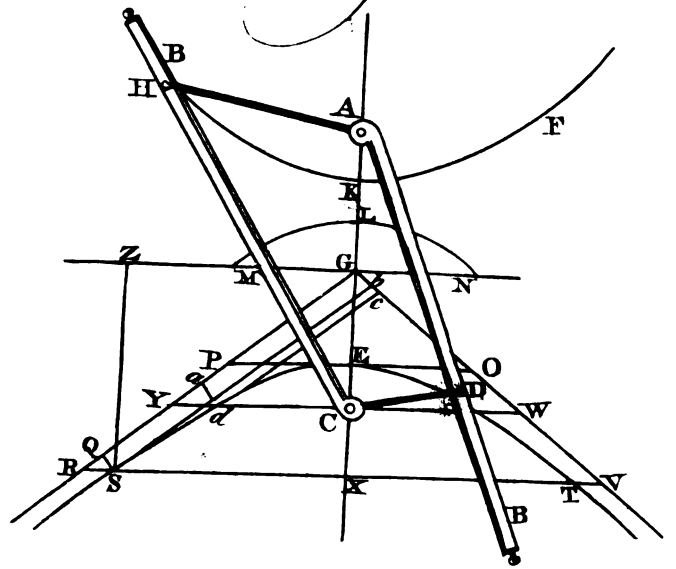
*Fig. 3.*



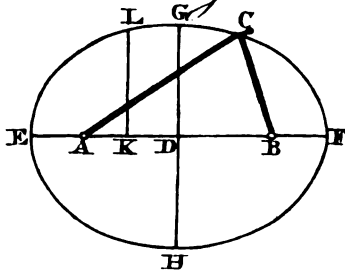
*Fig. 4.*



*Fig. 6.*



*Fig. 5.*



*A. B. Sc.*



will describe parabolas, ellipses, and hyperbolas, according to the proportion betwixt the central and projectile force. This is proved by direct demonstration.

The great principle of gravitation acts in this manner; and all the heavenly bodies describe conic sections having the sun in one of the foci; the orbits of the planets are ellipses, whose transverse and lesser diameters are nearly equal; it is uncertain whether the comets describe ellipses with very unequal axes, and so return after a great number of years; or whether they describe parabolas and hyperbolas, in which case they will never return.

*Uses of Conic Sections in the Solution of Geometrical Problems.*

MANY problems can be solved by conic sections that cannot be solved by right lines and circles. The following theorems, which follow from the simpler properties of the sections, will give a specimen of this.

A point equally distant from a given point and a given line, is situated in a given parabola.

A point, the sum of whose distances from two given points is given, is situated in a given ellipse.

A point, the difference of whose distances from two given points is given, is situated in a given hyperbola.

C O N

CONICHTHYODONTES, or PLECTRONITÆ, in natural history, one of the three names the fossil teeth of fishes are known by.

CONFEROUS TREES, such as bear hard, dry seed-vessels, of a conical figure, consisting of several woody parts, being mostly scaly, adhering closely together, and separating when ripe.

Of this sort is the cedar of Lebanon, fir, &c.

CONINGSECK, the capital of a county of the same name, in the circle of Swabia, in Germany, about twenty miles north of Constance: E. long 9° 23', N. lat. 47° 50'.

CONJOINT DEGREES, in music, two notes which follow each other immediately in the order of the scale, as *ut* and *re*.

CONJOINT TETRACHORDS, two tetrachords, or fourths, where the same chord is the highest of one, and the lowest of the other.

CONISSALÆ, in natural history, a class of fossils, naturally and essentially compounded, not inflammable, nor soluble in water, found in detached masses, and formed of crystalline matter debased by earth.

Of this class there are two orders, and of each of these only one genus. *Conissalæ* of the first order are found in form of a naturally regular and uniform powder, all the genuine particles of which are nearly of one determinate shape, appearing regularly concreted, and not fragments of others once larger. *Conissalæ* of the second order are found in form of a rude, irregular, and shapeless powder, the particles of which are never of any determinate particular figure, but seem broken fragments of some once larger masses.

To the former genus belong the different kinds of sand; and to the latter, the *saburræ*, or gritts.

CONJUGATE DIAMETER, or *axis of an ellipse*, the shortest of the two diameters, or that bisecting the transverse axis.

CONJUGATE HYPERBOLAS. See CONICSECTIONS.

CONJUGATION, in grammar, a regular distribution of the several inflexions of verbs in their different voices, moods, tenses, numbers and persons, so as to distinguish them from one another.

The Latins have four conjugations, distinguished by the terminations of the infinitive *äre*, *äre*, *äre*, and *ire*.

C O N

The English have scarce any natural inflexions, deriving all their variations from additional particles, pronouns, &c. whence there is scarce any such thing as strict conjugations in that language.

CONIUM, in botany, a genus of the pentandria digynia class of plants. The fruit is globular, crested on each side, and has five striæ or streaks. There are three species, only one of which, *viz.* the *coniium maculatum*, or hemlock, is a native of Britain. Within these few years past Dr Stork published a treatise recommending the extract of hemlock to be given internally, in several doses, as a kind of specific for cancers, the king's-evil, and all kinds of schirrous tumours. On the faith of this single physician, the whole medical practitioners in Europe dosed their patients who laboured under diseases of the above kinds with hemlock, which is unquestionably a rank poison, if taken to any extent. After two or three years practice, it was at length discovered that the hemlock was not possessed of those extraordinary virtues which Dr Stork had attributed to it; and of course its reputation began to sink, and now, like many other great medicines, has had its day, and is gradually wearing out of practice.

CONJUNCT *rights*. See SCOTS LAW, title, *Succession in heritable rights*.

CONJUNCT, or CONFIDENT persons. See SCOTS LAW, title, *Allions*.

CONJUNCTION, in astronomy, the meeting of two stars or planets, in the same degree of the zodiac.

CONJUNCTION, in grammar, an undecidable word, or particle, which serves to join words and sentences together, and thereby shews their relation or dependence one upon another.

CONJUNCTIVA, in anatomy. See Vol. I. p. 291.

CONNAUGHT, the most westerly province of Ireland.

CONNARUS, in botany, a genus of the monodelphia decandria class. It has but one stylus; the stigma is simple; and the capsule has two valves, and contains one seed. There is but one species, *viz.* the *monocarpus*, a native of India.

CONNECTICUT, a British colony of North America, bounded by the Massachusetts colony on the north-east; by the sea, on the south; and by New York, on the west;

west; being about 100 miles in length, and 80 in breadth.

**CONNECTION**, or **CONNEXION**, the relation or dependence of one thing upon another.

**CONNECTION**, or **CONTINUITY**, in the drama, consists in the joining of the several scenes together.

The connection is said to be observed, when the scenes of an act succeed one another immediately, and are so joined as that the stage is never left empty.

**CONNOISSEUR**, a French word much used of late in English, to signify a person well versed in any thing: whence it is used for a critic, or a person who is a thorough judge of any subject.

**CONNOR**, a city of Ireland, in the county of Antrim, and province of Ulster, situated about six miles north of Antrim, in 6° 30' W. long. and 54° 50' N. lat.

**CONOCARPODENDRON**, in botany. See **PROTEA**.

**CONOCARPUS**, the **BUTTON-TREE**, in botany, a genus of the pentandria monogynia class. The corolla consists of four petals; the seeds are naked, solitary, and below the flower; and the flowers are aggregated. There are three species, all natives of the Indies.

**CONOID**, in geometry, a solid body, generated by the revolution of a conic section about its axis. See **CONIC SECTIONS**.

**CONOIDES**, in anatomy, a gland found in the third ventricle of the brain, called *pinealis*, from its resemblance to a pine-apple.

**CONQUEST**. See **SCOTS LAW**, title, *Succession in heritable rights*.

**CONSANGUINITY**, the relation subsisting between persons of the same blood, or who are sprung from the same root.

**CONSANGUINITY** and **AFFINITY**, degrees of, forbidden in marriage; see **SCOTS LAW**, title, *Marriage*. Consanguinity or affinity, an objection against a judge; see title, *Jurisdiction and judges*: Against a witness; see title, *Probation*.

**CONSCIENCE**, a secret testimony of the soul, whereby it gives its approbation to things that are naturally good, and condemns those that are evil. See **MORALS**.

**CONSCRIPT**, in Roman antiquity, an appellation given to the senators of Rome, who were called conscript-fathers on account of their names being entered all in one register.

**CONSECRATION**, the act of devoting any thing to the service and worship of God.

In England, churches have been always consecrated with particular ceremonies, the form of which was left to the discretion of the bishop.

**CONSENT**, in a general sense, denotes much the same with assent. See **ASSENT**.

**CONSENT of parts**, in the animal œconomy. See **SYMPATHY**.

**CONSEQUENCE**, in logic, the conclusion, or what results from reason or argument.

**CONSERVATOR**, an officer ordained for the security and preservation of the privileges of some cities and

communities. having a commission to judge of and determine the differences among them.

**CONSERVATORY**, a term sometimes used for a green house, or ice-house.

**CONSERVE**, in pharmacy, a form of medicine, contrived to preserve the flowers, herbs, roots, pills, or fruits, of several simples, as near as possible to what they are when fresh gathered.

Conerves are made by beating up the thing to be preserved, with sugar, *viz.* a triple quantity thereof to those that are most moist, and a double quantity to those that are least so.

**CONSIGNATION** of money. See **SCOTS LAW**, title, *Obligations and contracts in general*: Of redemption-money; see title, *Redeemable rights*.

**CONSISTENCE**, in physics, that state of a body wherein its component particles are so connected or entangled among themselves, as not to separate or recede from each other. It differs from continuity in this, that it implies a regard to motion or rest, which continuity does not, it being sufficient to denominate a thing continuous that its parts are contiguous to each other.

**CONSISTORIAL**, or **COMMISSARY COURT**. See **SCOTS LAW**, title, *Ecclesiastical persons*.

**CONSISTORY**, at Rome, is an ecclesiastical assembly held in the presence of the pope, for the reception of princes or their ambassadors, for the canonization of saints, for the promotion of cardinals, and other important affairs.

**CONSOLE**, in architecture, an ornament cut upon the key of an arch, which has a projection, and, on occasion; serves to support little corniches, figures, busts, and vases. See **ARCHITECTURE**.

**CONSOLIDA**, in botany. See **AJUGA**.

**CONSOLIDATION**, in medicine, the action of uniting broken bones, or the lips of wounds, by means of conglutinating medicines.

**CONSONANCE**, in music, is ordinarily used in the same sense with concord, *viz.* for the union or agreement of two sounds produced at the same time, the one grave and the other acute; which mingling in the air in a certain proportion, occasion an accord agreeable to the ear. See **MUSIC**.

**CONSONANT**, a letter that cannot be sounded without some single or double vowel before or after it, as b, c, d, &c.

**CONSPIRACY**, in law, signifies an agreement between two or more, falsely to indict, or procure to be indicted, an innocent person, of felony.

**CONSPIRATORS** are, by statute, defined to be such as bind themselves by oath, covenant, or other alliance, to assist one another falsely and maliciously to indict persons, or falsely to maintain pleas.

Conspirators in treason are those that plot against the king and the government.

**CONSTABLE**, Lord High Constable, an ancient officer of the crowns both of England and France, whose authority was so very extensive, that the office has been laid aside in both kingdoms, except upon particular occasions,

cations, such as the king's coronation. The constable of France had his person privileged, and, during the king's minority, was named next to the princes of the blood. The army obeyed him next the king: he managed all that belonged to war, either for punishment of delinquents, distribution of booty, surrender of places, &c. The jurisdiction and functions of this office are now in the marshals of France.

The function of the constable of England consisted in the care of the common peace of the land, in deeds of arms and matters of war. By a law of Richard II. the constable of England has the determination of things concerning wars and blazonry of arms, which cannot be discussed by the common law. The first constable was created by the Conqueror: the office continued hereditary till the thirteenth of Henry VIII. when it was laid aside, as being so powerful as to become troublesome to the king. We have also constables denominated from particular places, as constable of the Tower, of Dover castle, of Windsor castle, of the castle of Caernarvon, and many other of the castles of Wales, whose office is the same with that of the castellani, or governors of castles.

**CONSTABLE of Scotland.** See SCOTS LAW, title, *Of inferior judges.*

**CONSTABLES to justices of the peace,** in Scots law, are the proper officers for executing their orders. They have powers to suppress tumults, and to apprehend delinquents and those who can give no good account of themselves, and carry them to the next justice.

**CONSTANCE,** a city of Swabia, in Germany, situated on the western shore of a lake to which it gives name, in  $9^{\circ} 12'$  E. lon. and  $47^{\circ} 37'$  N. lat.

It is the see of a bishop, who is a prince of the German empire.

**CONSTANTINA,** the capital of a province of the same name, in the kingdom of Algiers, in Africa: E. long.  $7^{\circ}$ , and N. lat.  $35^{\circ} 30'$ .

**CONSTANTINOPLE,** the metropolis of the Turkish empire, called by the Turks themselves Stamboul, and by many Europeans the Port, being one of the best harbours in Europe: E. long.  $29^{\circ} 15'$ , and N. lat.  $41^{\circ} 30'$ .

It is built on the western shore of the Bosphorus, in the form of a triangle; the seraglio, or palace, occupying that angle which runs out between the Propontis and harbour; and underneath the palace are the gardens, which extend to the water-side.

**CONSTELLATION,** in astronomy. See Vol. I. p. 486.

**CONSTIPATION,** in medicine, a hardness of the belly, with great costiveness.

**CONSTITUENT PART,** in physiology, an essential part in the composition of any thing, differing little from what is otherwise called element or principle.

**CONSTITUTION,** in matters of policy, signifies the form of government established in any country or kingdom.

**CONSTITUTION** also denotes an ordinance, decision, regulation, or law, made by authority of any superior, ecclesiastical or civil.

**Apostolical CONSTITUTIONS,** a collection of regulations attributed to the apostles, and supposed to have been collected by St Clement, whose name they likewise bear.

It is the general opinion, however, that they are spurious, and that St Clement had no hand in them. They appeared first in the IVth age, but have been much changed and corrupted since that time. They are divided into eight books, consisting of a great number of rules and precepts, relating to the duties of Christians, and particularly the ceremonies and discipline of the church. Mr Whiston, in opposition to the general opinion, asserts them to be a part of the sacred writings, dictated by the apostles in their meetings, and wrote down from their own mouth by St Clement, and intended as a supplement to the New Testament, or rather as a system of Christian faith and polity. The reason why the Constitutions are suspected by the orthodox, and, perhaps, the reason also why their genuineness is defended by Mr Whiston, is, that they seem to favour Arianism.

**CONSTITUTION,** in a physical sense, signifies the particular temperature of the body.

**CONSTRUCTOR,** an appellation given to several muscles on account of their constringing or closing some of the orifices of the body. See ANATOMY.

**CONSTRUCTION of equations,** in Algebra. See ALGEBRA.

**CONSTRUCTION,** in grammar, the connecting the words of a sentence according to the rules of the language.

**CONSUALIA,** in Roman antiquity, a festival instituted by Romulus, who, at the time of the rape of the Sabine virgins, found an altar under ground dedicated to the god Confus, that is, Neptune. They were introduced with a magnificent cavalcade; and during the celebration, the horses and asses were crowned with flowers, and a mule was sacrificed to that god.

**CONSUBSTANTIATION,** a tenet of the Lutheran church with regard to the manner of the change made in the bread and wine in the eucharist.

The divines of that profession maintain, that after consecration, the body and blood of our Saviour are substantially present, together with the substance of the bread and wine, which is called consubstantiation, or impanation.

**CONSUL,** the chief magistrate of the Roman commonwealth. They were two in number, chosen every year in the Campus Martius, by the people assembled in the comitia centuriata. In the first times of the commonwealth, no man could pretend to this dignity, but such as were of a patrician family; but afterwards the people obtained, that one of the consuls should be chosen from among them. A consul was commonly chosen at forty-three years of age, but this was not always observed: besides, it was requisite he should have exercised other offices, as that of quaestor, aedile, and praetor: and yet this condition was no better observed than the first; for Pompey had never been praetor nor quaestor when he obtained the consulship. Their authority and power was of very great extent, so long as the commonwealth subsisted. They were

the

- the head of the senate: they commanded the armies, and were supreme judges of the differences between the citizens; but as they had made some abuse of this power, it was allowed by the Valerian law for the party aggrieved to appeal from their tribunal to the people, especially in cases where the life of a citizen was concerned. Under the emperors, consul was little more than an honourable title, and at last it became absolutely extinct in the time of Justinian. From the establishment of the republic to the consulate of Basil, that is, from the year of Rome 244, to the year of Rome 1294, the years are accounted by the consuls; but after that period, the time was computed by the years of the emperors reigns and the indictions.
- CONSUL**, at present, is an officer established by virtue of a commission from the king and other princes, in all foreign countries of any considerable trade, to facilitate and dispatch business, and protect the merchants of the nation. The consuls are to keep up a correspondence with the ministers of England residing in the courts whereon their consulate depends. They are to support the commerce and the interest of the nation; to dispose of the sums given and the presents made to the lords and principals of places, to obtain their protection, and prevent the insults of the natives on the merchants of the nation.
- CONSUMMATION**, the end or completion of the work. Thus we say, the consummation of all things, meaning the world.
- CONSUMPTION**, in medicine, a word of very extensive signification, implies all disorders that bring any decay or waste upon the constitution; but is most used for the phthisis pulmonalis. See **MEDICINE**.
- CONTACT**, is when one line, plane, or body, is made to touch another, and the parts that do thus touch, are called the points or places of contact.
- CONTAGION**, in physic, the communicating a disease from one body to another. In some diseases it is only effected by an immediate contact or touch, as the venom of the pox; in others, it is conveyed by infected cloaths, as the itch; and in others, it is transmitted through the air at a considerable distance, by means of steams or effluvia expiring from the sick, as in the plague and other pestilential disorders, in which case the air is said to be contagious.
- CONTEMPLATION**, an act of the mind, whereby it applies itself to consider and reflect upon the works of God, nature, &c.
- CONTEMPORARY**, a person or thing that existed in the same age with another. Thus, Socrates, Plato, and Aristophanes, were contemporaries.
- CONTENT**, in geometry, the area or quantity of matter or space included in certain bounds. See **GEOMETRY**.
- CONTESSA**, a port-town of Turkey, in Europe, in the province of Macedonia, situated on a bay of the Archipelago, about 200 miles west of Constantinople: E. long. 25°, and N. lat. 41°.
- CONTEXT**, among divines and critics, that part of scripture or of a writing that precedes and follows the **text**.
- CONTI**, a town of Picardy in France, about fifteen miles south-west of Amiens: E. long. 2° 20', N. lat. 49° 40'.
- CONTIGUITY**, in geometry, is when the surface of one body touches that of another.
- CONTINENT**, in general, an appellation given to things continued without interruption; in which sense we say, continent fever, &c.
- CONTINENT**, in geography, a great extent of land not interrupted by seas, in contradistinction to island and peninsula, &c. See **GEOGRAPHY**.
- CONTINGENT**, something casual or unusual. Hence future contingent, denotes a conditional event which may or may not happen, according as circumstances fall out.
- CONTINGENTS** are sometimes used by mathematicians in the same sense as tangent. See **TANGENT**.
- CONTINUED proportion**, in arithmetic, is that where the consequent of the first ratio is the same with the antecedent of the second; as 4 : 8 :: 8 : 16, in contradistinction to discrete proportion.
- CONTINUITY**, is defined by some schoolmen the immediate cohesion of parts in the same quantum; by others, a mode of body, whereby its extremities become one; and by others, a state of body resulting from the mutual implication of its parts. There are two kinds of continuity, mathematical and physical. The first is merely imaginary, since it supposes real or physical parts where there are none.
- Physical continuity is that state of two or more particles, in which their parts are so mutually implicated as to constitute one uninterrupted quantity or continuum.
- CONTINUO**, in music, signifies the thorough bass, as basso continuo is the continual or thorough bass, which is sometimes marked in music books by the letters B. C.
- CONTORSION**, in medicine, has many significations. 1. It denotes the iliac passion. 2. An incomplete dislocation, when a bone is in part, but not entirely, forced from its articulation. 3. A dislocation of the vertebrae of the back side-ways, or a crookedness of these vertebrae. And, 4. A disorder of the head, in which it is drawn towards one side, either by a spasmodic contraction of the muscles on the same side, or a palsy of the antagonist muscles on the other.
- CONTOUR**, in painting, the out-line, or that which defines a figure.
- A great part of the skill of the painter lies in managing the contours well. Contour, with the Italian painters, signifies the lineaments of the face.
- CONTOURNE**, in heraldry, is used when a beast is represented standing or running with its face to the sinister side of the escutcheon, they being always supposed to look to the right, if not otherwise expressed.
- CONTOURNIATED**, a term among antiquaries applied to medals, the edges of which appear as if turned in a lath. This sort of work seems to have had its origin in Greece, and to have been designed to perpetuate the memories of great men, particularly those who had bore away the prize at the solemn games. Such are

are those remaining of Homer, Solon, Euclid, Pythagoras, Socrates, and several athletes.

**CONTRABAND**, in commerce, a prohibited commodity, or merchandise bought or sold, imported or exported, in prejudice to the laws and ordinances of a state, or the public prohibitions of the sovereign. Contraband goods are not only liable to confiscation themselves, but also subject all other allowed merchandise found with them in the same box, bale or parcel, together with the horses, waggons, &c. which conduct them. There are contrabands likewise, which, besides the forfeiture of the goods, are attended with several penalties and disabilities.

**CONTRACT**, in a general sense, a mutual consent of two or more parties, who voluntarily promise and oblige themselves to do something, pay a certain sum, or the like. All donations, exchanges, leases, &c. are so many different contracts.

**CONTRACTILE force**, that property or power inherent in certain bodies, whereby, when extended, they are enabled to draw themselves up again to their former dimensions.

**CONTRACTION**, in grammar, is the reducing of two syllables into one, as *can't* for *cannot*, *should'st* for *shouldest*, &c.

**CONTRACTION**, in physics, the diminishing the extent or dimensions of a body, or the causing its parts to approach nearer to each other, in which sense it stands opposed to dilatation or expansion.

**CONTRA-FISSURE**, in surgery, a kind of fracture, or fissure, in the cranium, which sometimes happens on the side opposite to that which received the blow; or, at least, at some distance from it. See **SURGERY**.

**CONTRARIETY**, an opposition between two things, which imports their being contrary to one another; and consists in this, that one of the terms implies a negation of the other, either mediately or immediately; so that contrariety may be said to be the contrast, or opposition of two things, one of which imports the absence of the other, as love and hatred.

**CONTRARY**, a positive opposite, which, subsisting by turns in the same subject with its opposite, is as remote from it as possible, expells it, and is mutually expelled by it. Blackness and whiteness, cold and heat, are such contraries.

**CONTRAST**. See **RESEMBLANCE**.

**CONTRATE-wheel**, in watch-work, that next to the crown, the teeth and hoop whereof lie contrary to those of the other wheels, from whence it takes its name. See **WATCH-MAKING**.

**CONTRAVALLATION**, or *the line* **CONTRAVALLATION**, in fortification, a trench guarded with a parapet, and usually cut round about a place by the besiegers, to secure themselves on that side, and to stop the sallies of the garrison. See **FORTIFICATION**.

**CONTRAVENTION**, in law, a man's failing to discharge his word, obligation, duty, or the laws or customs of the place.

**CONTRAYERVA**, in botany. See **DORSTENIA**.

**CONTRE**, in heraldry, an appellation given to several bearings, on account of their cutting the shield con-

trary and opposite ways: thus we meet with *contre-bend*, *contre-chevron*, *contre-palé*, &c. when there are two ordinaries of the same nature opposite to each other, so as colour may be opposed to metal, and metal to colour. See **COUNTER**.

**CONTRITION**, in theology, a sorrow for our sins, resulting from the reflexion of having offended God, from the sole consideration of his goodness, without any regard to the punishment due to the trespass, and attended with a sincere resolution of reforming them.

**CONTROL** is properly a double register kept of acts, issues, &c. of the officers or commissioners in the revenue, army, &c. in order to perceive the true state thereof, and to certify the truth, and the due keeping of the acts subject to the entegisterment.

**CONTROLLER**, an officer appointed to control or oversee the accounts of other officers, and, on occasion, to certify whether or no things have been controlled or examined.

In Britain we have several officers of this name, as controller of the king's house, controller of the navy, controller of the customs, controller of the mint, &c.

**CONTROLLER of the hanaper**, an officer that attends the lord chancellor daily, in term and in seal-time, to take all things sealed in leathern bags from the clerks of the hanaper, and to make the number and effect thereof, and enter them in a book, with all the duties belonging to the king and other officers for the same, and so charge the clerk of the hanaper with them.

**CONTROLLER of the pipe**, an officer of the exchequer, that makes out a summons twice every year, to levy the farms and debts of the pipe. See **PIPE**, and **EX-CHEQUER**.

**CONTROLLERS of the pells**, two officers of the exchequer, who are the chamberlain's clerks, and keep a control of the pell of receipts, and goings out.

**CONTUSION**, in medicine and surgery, any hurt of the body that is inflicted by a blunt instrument. See **SURGERY**.

**CONVALLARIA**, or *LILLY of the VALLEY*, in botany, a genus of the hexandria monogynia class. The corolla is divided into six segments; and the berry is spotted, and has three cells. The species are eight, three of which are natives of Britain, *viz.* the majalis, or may-lily; the multiflora, or solomon's-seal; and the polygonatum, or sweet-smelling solomon's-seal.

**CONVENT**, in church-history. See **MONASTERY**.

**CONVENTICLE**, a private assembly or meeting, for the exercise of religion. The word was first attributed as an appellation of reproach to the religious assemblies of Wickliffe, in this nation, in the reigns of Edward III. and Richard II. There were several statutes made in former reigns, for the suppression of conventicles; but, by 1 William and Mary, it is ordered, that dissenters may assemble for the performance of religious worship, provided their doors be not locked, barred, or bolted.

**CONVENTION**, a treaty, contract, or agreement between two or more parties.

**CONVENTION** is also a name given to an extraordinary assembly of parliament, or the estates of the realm, held

- without the king's writ; as was the convention of estates, who, upon the retreat of king James II. came to a conclusion that he had abdicated the throne, and that the right of succession devolved to king William and queen Mary; whereupon their assembly expired as a convention, and was converted into a parliament.
- CONVERGING**, or **CONVERGENT lines**, in geometry, are such as continually approach nearer one another, or whose distances become still less and less. These are opposed to divergent lines, the distances of which become continually greater: those lines which converge one way, diverge the other.
- CONVERGING rays**, in optics, those rays that, issuing from divers points of an object, incline towards another, till, at last, they meet and cross, and then become diverging rays. See **OPTICS**.
- CONVERSE**, in mathematics. One proposition is called the converse of another, when, after a conclusion is drawn from something supposed in the converse proposition, that conclusion is supposed; and then, that which in the other was supposed, is now drawn as a conclusion from it: thus, when two sides of a triangle are equal, the angles under these sides are equal; and, on the converse, if these angles are equal, the two sides are equal.
- CONVERSION**, in a moral sense, implies a repentance for a temper and conduct unworthy our nature, and unbecoming our obligations to its Author, and a resolution to act a wiser and a better part for the future.
- CONVERSION**, in war, a military motion whereby the front of a battalion is turned where the flank was, in case the battalion is attacked in the flank.
- CONVERSION of equations**, in algebra. See Vol. I. p. 104.
- CONVEX**, an appellation given to the exterior surface of gibbous or globular bodies, in opposition to the hollow inner surface of such bodies, which is called concave: thus we say, a convex frieze, lens, mirror, superficies, &c.
- CONVEXITY**, that configuration or shape of a body, on account of which it is denominated convex.
- CONVEYANCE**, in law, a deed or instrument that passes land, &c. from one person to another.
- CONVICT**, in common law, a person that is found guilty of an offence by the verdict of a jury.
- CONVICTION**, in theology, expresses the first degree of repentance, wherein the sinner becomes sensible of his guilt, of the evil nature of sin, and of the danger of his own ways.
- CONVOCAION**, an assembly of the clergy of England, by their representatives, to consult of ecclesiastical matters. It is held during the session of parliament, and consists of an upper and a lower house. In the upper sit the bishops, and in the lower the inferior clergy, who are represented by their proctors, consisting of all the deans and archdeacons, of one proctor for every chapter, and two for the clergy of every diocese, in all one hundred and forty-three divines, viz. twenty-two deans, fifty-three archdeacons, twenty-four prebendaries, and forty-four proctors of the diocesan clergy. The lower house chooses its prolocutor, whose business it is to take care that the members attend, to collect their debates and votes, and to carry their resolutions to the upper house. The convocation is summoned by the king's writ, directed to the archbishop of each province, requiring him to summon all bishops, deans, archdeacons, &c.
- The power of the convocation is limited by a statute of Henry VIII. They are not to make any canons or ecclesiastical laws, without the king's licence; nor, when permitted to make any, can they put them in execution, but under several restrictions. They have the examining and censuring all heretical and schismatical books and persons, &c. but there lies an appeal to the king in chancery, or to his delegates. The clergy in convocation, and their servants, have the same privileges as members of parliament.
- CONVOLUTION**, a winding motion, proper to the trunks of some plants, as the convolvulus, or bind-weed; the clasps of vines, bryony, &c.
- CONVOLVULUS**, or **BIND-WEED**, in botany, a genus of the pentandria monogynia class. The corolla is bell-shaped, and plaited; it has two stigmata; and the capsule is bilocular, each cell containing two seeds. There are forty-three species, only three of which are natives of Britain, viz. the arvensis, or small bind-weed; the sepium, or great bind-weed; and the soldanella, or sea bind-weed.
- CONVOY**, in marine affairs, one or more ships of war, employed to accompany and protect merchant ships, and prevent their being insulted by pirates, or the enemies of the state in time of war.
- CONVOY**, in military matters, a body of men that guard any supply of men, money, ammunition, or provisions, conveyed by land into a town, army, or the like, in time of war.
- CONVULSION**, in medicine, a preternatural and violent contraction of the membranous and muscular parts of the body. See **MEDICINE**.
- CONWAY**, a market-town of Carnarvonshire in North Wales, situated near the mouth of a river of the same name, fifteen miles west of St. Asaph: W. long.  $3^{\circ} 50'$ , and N. lat.  $53^{\circ} 20'$ .
- CONYZA**, or **FLEA-BANE**, in botany, a genus of the syngenesia polygamia superflua class. The receptacle is naked; the pappus is simple; the calix is roundish and imbricated; and the rays of the corolla are divided into three segments. There are nineteen species, only one of which is a native of Britain, viz. the squarrosa, or plowman's spikenard.
- CONZA**, a town of the kingdom of Naples in Italy, situated on the farther Principate, on the river Offanto, fifty miles south-east of the city of Naples: E. long.  $16^{\circ}$ , N. lat.  $41^{\circ}$ . It is the see of an archbishop.
- COOPER**, in geography, the name of a river in Carolina in North America.
- COOPER**, on board a ship, he that looks to the casks, and all other vessels for beer, water, or any other liquor. He has a mate under him.
- CO-ORDINATE**, something of equal order, rank, or degree with another. See **ORDER**.

COPAIBA



**COPAIBA**, or *balsam of COPAIBA*, a liquid resinous juice, flowing from incisions made in the trunk of the *fera*, a large tree which grows in the Spanish West Indies, and is used as a corroborating and detergent medicine.

**COPAL**, in the materia medica, a resin obtained from several sorts of large trees in New Spain. It is brought to us in irregular lumps; but it has never come into use as a medicine, and is rarely to be met with in the shops.

**COPENHAGEN**, the capital of the kingdom of Denmark, situated on the eastern shore of the island of Zealand, upon a fine bay of the Baltic sea, not far from the strait called the Sound: E. long. 13°, and N. lat. 55° 30'.

**COPERNICAN**, in general, something belonging to Copernicus. Hence,

**COPERNICAN system** or *hypothesis*, that system of the world, wherein the sun is supposed to rest in the centre, and the planets, with the earth, to move in ellipses round him. See Vol. I. p. 434.

**COPERNICUS**, the name of an astronomical instrument, invented by Mr Whiston, to exhibit the motion and phenomena of the planets, both primary and secondary. It is built upon the Copernican system, and for that reason called by his name.

**COPHTS**, **COPHTI**, or **COPTS**, a name given to such of the Christians of Egypt as are of the sect of Jacobites.

The Cophts have a patriarch, who is styled the patriarch of Alexandria, having eleven or twelve bishops under him, but no archbishop. The rest of the clergy, whether secular or regular, are of the order of St Anthony, St Paul, and St Macarius, each of whom have their monasteries. The Cophts have seven sacraments, *viz.* baptism, the eucharist, confirmation, ordination, faith, fasting, and prayer.

**COPHTIC**, or **COPTIC language**, is that spoke by the Cophts, being the ancient language of the Egyptians, intermixed with the Greek, and the characters of it being those of the Greek.

The ancient Coptic is now a dead language, to be met with no where but in books, and those only translations of the scriptures, and of ecclesiastical offices, or others that have a relation thereto; the language now used over all the country being that of the Arabic.

**COPPEL**, **COPPEL**, or **CUPPEL**, a chemical vessel made of earth, pretty thick, and of the form of a platter or dish.

**COPPELLING**, or **CUPPELLING**, in chemistry, is the putting metallic substances into a coppel, or covered vessel, made of bone ashes, and set in a naked fire, to try what gold or silver they will afford. See p. 114.

**COPPER** constitutes a distinct genus of metals, being next to iron in specific gravity, but lighter than gold, silver, or lead. See p. 80.

**COPPERAS**, a name given to the factitious green vitriol. See **CHEMISTRY**.

The English copperas is made at Deptford, in the following manner, from pyrite. See **PYRITE**.

A heap of these stones, two or three foot thick, is laid in a bed well rammed; where being turned once in six months, in five or six years, by the action of the air and rain, they begin to dissolve, and yield a liquor which is received in pits, and thence conveyed into a cistern, in a boiling-house. The liquor at length being pumped out of the cistern into a leaden boiler, and a quantity of iron added thereto, in two or three days the boiling is compleated; care having been taken all along to supply it with fresh quantities of iron, and to restore the boiling, whenever it seems to abate. When boiled sufficiently, it is drawn off into a cooler, with sticks across, where it is left 14 or 15 days to shoot. The uses of copperas are numerous. It is the chief ingredient in the dying of wool, cloths, and hats, black; in making ink; in tanning and dressing leather, &c. and from hence is prepared oil of vitriol, and a kind of Spanish brown for painters. In medicine it is rarely prescribed under the name of copperas, but it is a true salt of iron, and often prescribed under that name, and used instead of the genuine preparation; our chemists in general giving themselves no further trouble about the making of that salt, than to dissolve and purify the common copperas, and shoot it again into crystals.

**COPPICE**, or **COPSE**, a little wood, consisting of under-woods, or such as may be raised either by sowing or planting.

**COPULATION**, the act of generation, or the congress of the male and female, otherwise called coition. See **GENERATION**.

**COPY-HOLD**, a tenure for which a tenant has nothing to shew but the copy of the rolls made by the steward of the lords court.

It is called a base tenure, because the tenant holds the land at the will of the lord. However, it is not simply at the will of the lord, but according to the custom of the manor by which such estate is descensible, and the tenants heirs may inherit it; and a copyholder, so long as he does his services, and does not break the custom, cannot be ejected by the lord; and if he be, he shall have trespass against him.

**COPY-HOLDER**, one who is admitted tenant of lands or tenements within a manor, which time out of mind, by use and custom of the manor, have been demisable and demised to such as will take them in fee simple or fee-tail, for life, years, or at will, according to the custom of the manor by copy of court-roll; but is generally where the tenant has such estate either in fee or for three lives.

**COQUIMBO**, a port-town of Chili, in South America, situated at the mouth of a river of the same name, which discharges itself into the pacific ocean: W. long 75° 10', and N. lat. 30°.

**COR CAROLI**, in astronomy, an extrastellated star in the northern hemisphere, situated between the coma berenices, and ursa major, so called by Dr Halley in honour of king Charles.

**COR HYDRÆ**, a fixed star of the first magnitude, in the constellation of hydra.

Con.

- COR LEONIS**, or **REGULUS**, in astronomy, a fixed star of the first magnitude in the constellation leo.
- CORACO-BRACHIALIS**, in anatomy. See Vol. I. p. 196.
- CORACOIDES**, in anatomy. See Vol. I. p. 177.
- CORACOMANTES**, in antiquity, persons who foretold events from their observations on crows.
- CORACO-RADIALIS**, in anatomy. See Vol. I. p. 197.
- CORALLINA**, or **CORAL**, in zoology, a genus belonging to the order of vermes zoophyta. The trunk is radicated, jointed, and calcareous. The species are eight, distinguished by the form of their branches, and are found in the ocean adhering to stones, bones, shells, &c. The corals were formerly believed to be vegetable substances hardened by the air; but are generally believed to be composed of a congeries of animals, which are even endued with the faculty of moving spontaneously. Linnæus's order of zoophyta is composed of animals of this kind; as the spongia, fertularia, &c. See **NATURAL HISTORY**.
- CORALLODENDRON**, in botany. See **ERYTHRINA**.
- CORAL fishery**. Red coral is found in the Mediterranean, on the shores of Provence, from Cape de la Couronne to that of St Tropez; about the isles of Majorca and Minorca; on the south of Sicily; on the coasts of Africa; and, lastly, in the Ethiopic ocean, about cape Negro. The divers say, that the little branches are found only in the caverns whose situation is parallel to the earth's surface, and open to the south. The manner of fishing being nearly the same wherever coral is found, it will suffice to instance the method used at the bastion of France, under the direction of the company established at Marseilles for that fishery. Seven or eight men go in a boat commanded by the patron or proprietor, and when the net is thrown by the caster, the rest work the vessel, and help to draw the net in. The net is composed of two rafters of wood tied cross-wise, with leads fixed to them: to these they fasten a quantity of hemp twisted loosely round, and intermingled with some large netting. This instrument is let down where they think there is coral, and pulled up again, when the coral is strongly intangled in the hemp and netting. For this purpose, six boats are sometimes required; and if in hauling in, the rope happens to break, the fishermen run the hazard of being lost. Before the fishers go to see, they agree for the price of the coral, which is sometimes more, sometimes less a pound; and they engage, on pain of corporal punishment, that neither they nor their crew shall embezzle any, but deliver the whole to the proprietors. When the fishery is ended, which amounts one year with another to twenty-five quintals for each boat, it is divided into thirteen parts, of which the proprietor hath four, the casters two, and the other six men one each; the thirteenth belongs to the company for payment of the boat furnished them.
- CORAN**, or **ALCORAN**. See **ALCORAN**.
- CORAX**, in ornithology, the trivial name of a species of corvus. See **CORVUS**.
- CORBAN**, a scripture term of an offering which had life, in opposition to the minchab which had no life.
- CORBAN** is also a ceremony which the Mahometans perform at the foot of mount Ararat, in Arabia, near Mecca. It consists in killing a great number of sheep, and distributing them among the poor.
- CORBEILS**, in fortification. See **BASKET**.
- CORBEL**, in architecture, a representation of a basket, sometimes seen on the heads of the caryatides.
- CORBY**, a town of Germany; thirty miles east of Paderborn, in Westphalia: East long. 9° 20', N. lat. 51° 40'.
- CORCHORUS**, **JEW-SALLAD**, in botany, a genus of the polyandria monogynia class. The corolla consists of five petals; the calix is deciduous, and consists of five leaves; and the capsule has many cells and valves. The species are six, none of them natives of Britain.
- CORD of wood**, a certain quantity of wood for burning, so called because formerly measured with a cord. The dimensions of a statute cord of wood are eight feet long, four feet high, and four feet broad.
- CORD-WOOD**, is new wood, and such as, when brought by water, comes on board a vessel, in opposition to that which is floated.
- CORDAGE**, a term used, in general, for all sorts of cord, whether small, middling, or great. See **ROPE**.
- CORDATED**, an appellation frequently given by naturalists to things somewhat resembling a heart.
- CORDED**, in heraldry. A cross corded some authors take for a cross wound or wrenched about with cords. See **CABLED-CROSS**.
- Others, with more probability, take it for a cross made of two pieces of cord.
- CORDELERAS**, mountains of south America, otherwise called Andes. See **ANDES**.
- CORDELIER**, in church-history, a Franciscan or religious of the order of St Francis.
- CORDIA**, in botany, a genus of the pentandria monogynia class. The corolla is tunnel-shaped, and has but one petal; the stylus is dichotomous; and the fruit is a bilocular drupa. The species are five, none of them natives of Britain.
- CORDIAL**, in medicine, whatever raises the spirits, and gives them a sudden strength and cheerfulness, as wine, spirits, the effluvia of flowers, fruit, and many other substances.
- CORDON**, in fortification, a row of stones, made round on the outside, and set between the wall of the fortrefs which lies aslope, and the parapet which stands perpendicular, after such a manner, that this difference may not be offensive to the eye: whence the cordons serve only as an ornament, ranging round about the place, being only used in fortification of stone-work. For in those made with earth, the void space is filled up with pointed stakes.
- CORDOUA**, **CORDOVA**, a city of Andalusia, in Spain, situated

situated on the river Guadalquivir, seventy-two miles north-east of Seville, and seventy-five north of Malaga: W. long.  $4^{\circ} 45'$ , and N. lat.  $37^{\circ} 45'$ .

**COREA**, an island or peninsula on the north-east coast of China, between  $36^{\circ}$  and  $42^{\circ}$  N. lat.

**CORDWAINERS** a term whereby shoemakers are denominated in statutes. By a statute of Jac. I. the master and wardens of the cordwainers company, &c. are to appoint searchers and triers of leather; and no leather is to be sold before searched, sealed, &c.

**CORDYLINA**, in botany. See **YUCCA**.

**CORDYLUS**, the trivial name of a species of **Lacerta**. See **LACERTA**.

**COREGONUS**, in ichthyology, a synonyme of a species of **Salmo**. See **SALMO**.

**COREIA**, in antiquity, a festival in honour of Proserpine.

**COREOPSIS**, in botany, a genus of the syngenesia polygamia frustranea class. The receptacle is paleaceous, the pappus has two double horns; the calix is erect, and consists of many leaves. There are eleven species, none of them natives of Britain.

**CORFE-CASTLE**, a borough-town of Dorsetshire, about twelve miles east of Dorchester, near the sea: W. long.  $2^{\circ} 10'$ , and N. lat.  $50^{\circ} 36'$ . It sends two members to Parliament.

**CORFU**, an island subject to the Venetians, situated in the Mediterranean, near the entrance of the gulph of Venice.

**CORFU** is also the capital of the above island: E. long.  $20^{\circ} 40'$ , and N. lat.  $39^{\circ} 40'$ .

**CORIA**, a city of Estremadura, in Spain, thirty-five miles north of Alcantara: W. long.  $6^{\circ} 40'$ , and N. lat.  $39^{\circ} 55'$ . It is a bishop's see.

**CORIANDRUM**, in botany, a genus of the pentandria digynia class. The corolla is radiated; the involucreum universale consists of one leaf, and the partiale is dimidiated; and the fruit is spherical. The species are two, only one of which, viz. the fativum, or coriander, is a native of Britain. The seeds are used as a stomachic.

**CORIARIA**, **MYRTLE-SUMACH**, in botany, a genus of the diccia decandria class. The calix of both male and female consists of five leaves, and the corolla of each has five petals. The antheræ are divided into two parts: The female has five styli, and five seeds. The species are two, none of them natives of Britain.

**CORINDUM**, in botany. See **CARDIOSPERMUM**.

**CORINTH**, a city of European Turkey, situated near the isthmus into the Morea, about fifty miles west of Athens, in  $23^{\circ}$  E. long. and  $37^{\circ} 30'$  N. lat.

**CORINTHIAN ORDER**, in architecture. See Vol. I. p. 352.

**CORIS**, in botany, a genus of the pentandria monogynia class. The corolla has but one irregular leaf; the calix is prickly, and the capsule has five valves. There is but one species, a native of Montpellier.

**CORISPERMUM**, in botany, a genus of the monandria digynia class of plants, whose corolla consists of

two compressed, crooked, pointed petals, equal in size, and placed opposite one another: its fruit is a roundish capsule, compressed, bilocular, and having a furrowed edge; the seeds are of an oblong figure, and stand single. There are two species, none of them natives of Britain.

**CORK**, or **CORK-TREE**, in botany. See **QUERCUS**.

**CORK**, or **CORKING of a saddle**, the pieces to which the bolsters are made fast; so called as having formerly been made of cork.

**CORK**, in geography, the capital of a county of the same name, in Ireland, and province of Munster, situated on the river Lee, about fifty miles south of Limerick: W. long.  $8^{\circ} 25'$ , and N. lat.  $51^{\circ} 40'$ .

**CORMANDEL-COAST**, comprehends the eastern coast of the hither India, bounded by Golconda on the north, the bay of Bengal on the east, Madura on the south, and Bishnagar on the west: it lies between  $10^{\circ}$  and  $20^{\circ}$  N. lat.

**CORMORANT**, in ornithology. See **TANTALUS**.

**CORN**, in country affairs, the grain or seeds of plants, separated from the spica, or ear, and used for making bread.

There are several species of corn, such as wheat, rye and barley, millet and rice, oats, maize and lentils, pease, and a number of other kinds, each of which has its usefulness and propriety. Corn is very different from fruits, with respect to the manner of its preservation; and is capable of being preserved in public granaries, for pressing occasions, and of being kept for several centuries.

The first method is to let it remain in the spike; the only expedient for conveying it to the islands and provinces of America. The inhabitants of those countries save it in the ear, and raise it to maturity by that precaution: but this method of preserving it, is attended with several inconveniencies among us; corn is apt to rot or sprout, if any the least moisture is in the heap; the rats likewise infest it, and our want of straw also obliges us to separate the grain from the ear. The second is to turn and winnow it frequently; or to pour it through a trough or mill-hopper, from one floor to another; being thus moved and aired every fifteen days, for the first six months, it will require less labour for the future, if lodged in a dry place: but if, through neglect, mites should be allowed to slide into the heap, they will soon reduce the corn to a heap of dust: this must be avoided by moving the corn anew, and rubbing the places adjacent with oils and herbs, whose strong odour may chase them away; for which garlic and dwarf-elder are very effectual: they may likewise be exposed to the open sun; which immediately kills them. When the corn has been preserved from all impurities for the space of two years, and has exhaled all its fires, it may be kept for fifty or even a hundred years, by lodging it in pits, covered with strong planks, closely joined together: but the safer way is to cover the heap with quick-lime, which should be dissolved by sprinkling it over with a small quantity of water; this causes the grains to shoot to

the depth of two or three fingers, and incloses them with an incrustation, through which neither air nor insects can penetrate.

Corn not exceeding the under mentioned prices have the following bounties *per* quarter, *viz.*

	Price <i>per</i> qr.			Bounty <i>per</i> qr.		
	l.	s.	d.	s.	d.	
Wheat	2	8		5	0	
Rye	1	12		3	6	
Barley and Malt	1	4		2	6	
Oat-meal	0	15		2	6	

In France corn of the growth of the kingdom is reckoned a contraband commodity.

**CORN-MILL**, a water-engine for grinding of corn. See **MECHANICS**.

**CORN**, in medicine and surgery, a hard tubercle like a flat wart, growing in several parts of the feet, especially upon the joints of the toes. See **MEDICINE**.

**CORNACHINE-powder**, the same with what is sometimes called the earl of Warwick's powder, and *pulvis de tribus*. It is prepared thus: Take four ounces of scammony; calcined hartshorn prepared, three ounces; grind them together into a powder. It is given as a purge.

**CORNAGE**, an ancient tenure, the service whereof was to blow a horn when any invasion of the Scots was perceived.

This tenure was very frequent in the northern counties near the Prêts wall.

**CORNEA tunica**, in anatomy. See Vol. I. p. 289.

**CORNEL-trees**, in botany. See **CORNUS**.

**CORNELIAN**. See **CARNELIAN**.

**CORNER**, in a general sense, the same with angle. See **ANGLE**.

**CORNET**, in the military art of the ancients, an instrument much in the nature of a trumpet, which when it only sounded, the ensigns were to march along, without the soldiers; whereas, when the trumpet only sounded, the soldiers were to move without the ensigns. The cornets and buccinæ sounded the charge and retreat, and the cornets and trumpets sounded during the course of the battle.

**CORNET**, in the military art of the moderns, the third commission-officer in a troop of horse or dragoons.

This is a very honourable post: he commands in the lieutenant's absence; his principal duty being to carry the standard, near the middle of the first rank of the Squadron.

**CORNEUS**. the name by which Linnæus calls a kind of tin-ore, found in black columns, with irregular sides, and terminating in prisms.

**CORNICHE**, **CORNISH**, or **CORNICE**, in architecture. See **ARCHITECTURE**.

**CORNICHE** is also used, in general, for all little projections in masonry or joinery, even where there are no columns, as the cornice of a chimney, beaufet, &c.

**CORNICHE-ring**, of a piece of ordnance, is that next from the muzzle-ring, backward.

**CORNICULARIUS**, in Roman antiquity, an officer of

the army, appointed to assist the military tribune in quality of lieutenant.

**CORNIX**, in ornithology, the trivial name of a species of corvus. See **CORVUS**.

**CORNU**. See **HORN**.

**CORNU ammonis**, in natural history, fossil shells, called also serpent-stones, or snake-stones.

They are found of all sizes, from the breadth of a sixpence, to more than two feet in diameter; some of them rounded, others greatly compressed, and lodged in different strata of stones and clays; some again are smooth, and others ridged in different manners, their striae and ridges being either straight, irregularly crooked, or undulated.

**CORNU cervi**. See **HARTSHORN**.

**CORNUCOPIA**, or **HORN OF PLENTY**, among painters, &c. is represented under the figure of a large horn, out of which issue fruits, flowers, &c. Upon medals the cornucopia is given to all deities, genii, and heroes, to mark the felicity and abundance of all the wealth procured by the goodness of the former, or the care and valour of the latter.

**CORNUCOPILÆ**, in botany, a genus of the triandria digynia class. The involucreum consists of one tunnel-shaped crenated leaf, containing many flowers; and the calices are double-valved. There is but one species, *viz.* the cuculiatum, a native of Smyrna.

**CORNUS**, or **CORNEL-TREE**, in botany, a genus of the tetrandria monogynia class. The involucreum consists mostly of four leaves; the petals are four, and above the fruit, which is a bilocular gluma. There are five species, none of them natives of Britain.

**CORNUTIA**, in botany, a genus of the didynamia angiospermia class. The calix has five teeth; the stamina are longer than the corolla; the stylus is very long; and the berry contains but one seed.

**CORNWAL**, the most westerly county of England, which gives the title of duke to the prince of Wales. It sends forty-four members to parliament.

**COROLLA**, among botanists, the most conspicuous part of a flower, surrounding the organs of generation, and composed of one or more flower-leaves, most commonly called petals, to distinguish them from the leaves of the plant; according as there is one, two, or three of these petals, the corolla is said to be monopetalous, dipetalous, tripetalous, &c.

**COROLLARY** is a consequence drawn from something already advanced or demonstrated.

**COROLLULA**, a term used by botanists, to express the little partial flowers, which together make up the compound ones.

**CORONA**, among anatomists, denotes that edge of the glans penis where the preputium begins. See **ANATOMY**.

**CORONA**, among botanists. See **PAPPUS**.

**CORONA borealis**, the **NORTHERN CROWN**, in astronomy. See Vol. I. p. 486.

**CORONA imperialis**, in zoology, a synonyme of a species of conus. See **CONUS**.

**CORONA imperialis**, in botany. See **FRIILLARIA**.

**CORONA**

**CORONA folis**, in botany. See **HELIANTHUS**.

**CORONÆ jus**. See **JUS**.

**CORONAL**, in anatomy. See Vol. I. p. 152.

**CORONALE os**, in anatomy, the same with the os frontis. See Vol. I. p. 152.

**CORONARIA**, in botany. See **AGROSTEMA**.

**CORONARY vessels**, in anatomy. See **ANATOMY**, Part III. and IV.

**CORONEOLA**, in botany. See **LYSIMACHIA**.

**CORONER**, an ancient officer of this kingdom, so called because he is wholly employed for the king and crown.

The office of coroners especially concerns the pleas of the crown; and they are conservators of the peace in the county where elected, being usually two for each county. Their authority is judicial and ministerial: judicial, where a person comes to a violent death; to take and enter appeals of murder, pronounce judgment on outlawries, &c. and to inquire into the lands, goods, and escape of murders, treasure trove, wreck of the sea, deodands, &c. The ministerial power is when coroners execute the king's writs, on exception taken to the sheriff, as being party in a suit, of kin to either of the parties, or on the default of the sheriff, &c. The authority of the coroner does not terminate on the demise of the king, as that of judges, &c. does, who act by the king's commission. On default of sheriffs, coroners are to impanel juries, and to return issues on juries not appearing, &c.

**CORONET**. See **CROWN**.

**CORONET**, or **CRONET** of a horse, the lowest part of the poll, which runs round the coffin, and is distinguished by the hair joining and covering the upper part of the hoof.

**CORONILLA**, in botany, a genus of the diadelphia decandria class. The calix is bilabiate, and the vexillum is hardly longer than the alæ. There are 11 species, none of them natives of Britain.

**CORONOPUS**, in botany. See **PLANTAGO**.

**CORPORA cavernosa**, in anatomy. See Vol. I. p. 272.

**CORPORA olivaria**, in anatomy. See Vol. I. p. 287.

**CORPORA pyramidalia**, in anatomy. See Vol. I. p. 287.

**CORPORA striata**, in anatomy. See Vol. I. p. 286.

**CORPORAL**, an inferior officer under a serjeant, in a company of foot, who has charge over one of the divisions, places and relieves sentinels, and keeps good order in the corps de garde: he also receives the word from the inferior rounds, which passes by his corps de garde. This officer carries a sulce, and is commonly an old soldier: there are generally three corporals in each company.

**CORPORAL of a ship**, an officer who has the charge of setting and relieving the watches and centries, and who sees that the soldiers and sailors keep their arms neat and clean: he teaches them how to use their arms, and has a mate under him.

**CORPORATION**, a body politic, or incorporate, so called, because the persons or members are joined into one body, and are qualified to take and grant, &c.

Corporations are either spiritual or temporal: spiritual, as bishops, deans, archdeacons, parsons, vicars, &c. Temporal, as mayor, commonalty, bailiff, burgesses, &c. And some corporations are of a mixed nature, composed of spiritual and temporal persons, such as heads of colleges and hospitals, &c. All corporations are said to be ecclesiastical or lay: ecclesiastical are either regular, as abbeys, priories, chapters, &c. or secular, as bishoprics, deaneries, archdeacons, &c. lay, as those of cities, towns, companies, or communities of commerce, &c.

**CORPOREAL**, those qualities which denominate a body. See **QUALITY**, **BODY**, and **INCORPOREAL**.

**CORPULENCY**, in medicine, the state of a person too much loaded with flesh or fat.

**CORPUS callosum**, in anatomy. See Vol. I. p. 285.

**CORPUS cavernosum**, in anatomy. See Vol. I. p. 272.

**CORPUS reticulare**. See **RETICULARE**.

**CORPUS Christi**, a festival of the church, kept on the next Thursday after Trinity-sunday, instituted in honour of the eucharist; to which also one of the colleges in Oxford is dedicated.

**CORPUSCLE**, in physics, a minute particle, or physical atom, being such as a natural body is made up of. By this word is not meant the elementary particles, nor the hypostatical principles of chemists; but such particles, whether of a simple or compound nature, whose parts will not be dissolved nor dissipated by ordinary degrees of heat.

**CORPUSCULAR philosophy**, that way of philosophizing which endeavours to explain things, and to account for the phenomena of nature by the motion, figure, rest, position, &c. of the corpuscles, or the minute particles of matter.

Mr Boyle sums up the chief principles of the corpuscular hypothesis, which now flourishes under the mechanical philosophy, in these particulars:

1. They suppose that there is but one catholic or universal matter, which is an extended, impenetrable, and divisible substance, common to all bodies, and capable of all forms.
2. That this matter, in order to form the vast variety of natural bodies, must have motion in some or all its assignable parts; and that this motion was given to matter by God the Creator of all things, and has all manner of directions and tendencies.
3. Matter must also be actually divided into parts, and each of these primitive particles, fragments, or atoms of matter, must have its proper magnitude or size, as also its peculiar figure or shape.
4. They suppose also, that these differently sized and shaped particles may have as different orders and positions, whereof great variety may arise in the composition of bodies.

**CORRECTION**, in printing, the pointing out or discovering the faults in a printed sheet, in order to be amended by the compositor before it be printed off. See **PRINTING**.

**CORRECTOR**, in general, denotes something that mends the faults or bad qualities of others.

**CORRECTOR of the staple**, a clerk belonging to the staple, whose business is to write down and record the bargains that merchants make there.

**CORRECTOR,**

- CORRECTOR**, in medicine and pharmacy, an ingredient in a compoſition, which guards againſt or abates the force of another.
- CORRELATIVE**, ſomething oppoſed to another in a certain relation. Thus, father and ſon are correlatives. Light and darkneſs, motion and reſt, are correlative and oppoſite terms.
- CORRIGIOLA**, in botany. See **ILLECEBRUM**.
- CORROBORANTS**, or **CORROBORATIVE medicines**. See **STRENGTHENERS**.
- CORROSION**, in a general ſenſe, the action of gnawing away, by degrees, the continuity of the parts of bodies.
- CORROSION**, in chemistry, an action of bodies, by means of proper menſtrua, that produces new combinations, and a change of their form, without converting them to fluidity. See **CHEMISTRY**.
- CORRUGATOR**, in anatomy. See Vol I. p. 291.
- CORROSIVES**, in ſurgery, are medicines which corrode whatever part of the body they are applied to: ſuch are burnt alum, white precipitate of mercury, white vitriol, red precipitate of mercury, butter of antimony, lapis infernalis, &c.
- CORRUPTION**, the deſtruction, extinction, or, at leaſt, ceſſation for a time, of the proper mode of exiſtence of any natural body. See **PUTREFACTION**.
- CORRUPTION of blood**, in law, an infection accruing to a man's ſtate, attainted of felony and treaſon, and to his iſſue; for as he loſes all to the prince, &c. his iſſue cannot be heirs to him, or to any other ancestor by him: and if he were noble, his heirs are rendered ignoble.
- CORSA**, in architecture. See **PLAT-band**.
- CORSAIR**, a pirate, or perſon who ſcours the ſea for plunder, with an armed veſſel, without commiſſion from any prince or power. A corſair differs from a privateer, in that the latter acts under a commiſſion, and only attacks the veſſels of thoſe at war with the ſtate whence he had his commiſſion.
- CORSELET**, a little cuirafs; or, according to others, an armour or coat made to cover the whole body, anciently worn by the pike-men, uſually placed in the front and flanks of the battle, for the better reſiſting the enemy's aſſaults, and guarding the ſoldiers placed behind them.
- CORSICA**, an iſland in the Mediterranean, between 8° and 10° E. long. and between 41° and 43° N. lat. about one hundred miles ſouth of Genoa, and ſubject to that republic; though the natives for many years diſputed their right. This iſland is now in the hands of the French, after a glorious ſtruggle for liberty under general Paoli.
- CORTEX**, or **CORTEX Peruvianus**. See **CINCHONA**.
- CORTEX cerebri**. See Vol. p. 285.
- CORTONA**, a city of Tufcany, in Italy, about thirty-five miles ſouth-eaſt of Sienna: E. long. 13°, and N. lat. 43° 15'.
- CORTUSA**, in botany, a genus of the pentandria monogynia claſs. The corolla is rotated, with an open limbus; and the caſpule has two valves. There are two ſpecies, none of them natives of Britain.
- CORUNNA**, or **GROYNE**, a port-town of Galicia in Spain, ſituated on a fine bay of the Atlantic ocean, about thirty-two miles north of Compoſtella: W. long. 9°, and N. lat. 43°.
- CORUS**, in Jewiſh antiquity. See **HOMER**.
- CORUS**, in our old writers, denotes eight buſhels, or a quarter.
- CORUS** is alſo a wind, ſo called by the Jews, riſing in the ſummer in the weſt; and is that at preſent called the north eaſt-wind.
- CORUSCATION**, a glittering, or gleam of light iſſuing from any thing. It is chiefly uſed for a flaſh of lightning darting from the clouds in time of thunder.
- CORVUS**, the **RAVEN**, or **CROW-kind**, in ornithology, a genus of birds, of the order of picæ, the diſtinguiſhing characteristics of which are theſe: The beak is convex and cultrated; the noſtrils are covered with brittle feathers; the tongue is forked and cartilaginous; and the feet are of the walking kind. The ſpecies are nineteen, viz. 1. The hottentottus, is of a greeniſh black colour, with long myſtaches, and an equal tail. It is found at the Cape of Good Hope. 2. The corax, or raven of Engliſh authors, is black, with a blueiſh back, and a roundiſh tail. It is a native of Europe, and feeds upon carrion: it is much given to theft, and may be taught to utter articulate ſounds. 3. The corone, or carrion-crow, is of a black blueiſh colour, with the prime wing-feathers ſharp, and a round tail: it lives upon carrion and fruits, and is a native of Europe. 4. The frugilegus, or rook, is black, with an aſh-coloured forehead, and a roundiſh tail. The rooks aſſemble in flocks, and infeſt the corn-fields: many of them ſleep together in the ſame tree, by which means they are eaſily taken. 5. The cornix, or roylton-crow, is aſh-coloured, with the throat, wings, and tail black. It feeds upon worms, ſnails, frogs, caterpillars, &c. 6. The monedula, or jack-daw, is of a duſky colour, with a hoary hind-head; and the wings, tail, and forehead black. It is a native of Europe. They flock together in winter, ſleep, and build their neſts in old turrets and walls. 7. The glandularius, or jay, has blueiſh wings, with tranſverſe black and white lines; and the body is variegated with an iron-colour. It is a native of Europe, and feeds upon nuts, corn, and ſometimes ſmall birds. 8. The criſtatus, or blue-creſted jay, has the covert feathers of the wings marked with tranſverſe black lines, a blueiſh body, and a black collar. It is a native of North America. 9. The cayanus, is of a violet colour above, and white below, with a black front and throat, and the point of the tail white: the feathers of the hind head are erect and rigid. It is a native of Cayenne. 10. The caryocatactes, is brown, and ſpotted with white; the wings and tail are black; the prime tail-feathers are white at the points, but the intermediate ones have a worn appearance. It is a native of Europe, and feeds upon nuts. 11. The baliacallus is of a greeniſh black colour, with a forked tail.

It

It is found on the Philippine isles. 12. The *aser*, is of a violet blackish colour, and has a wedge-like tail. It is a native of Africa. 13. The *pica*, or magpye, is variegated with black and white, and its tail is shaped like a wedge. They build their nests in trees in a very artificial manner; the outside consists of thorns both above and below, leaving only a hole for their entrance. They lay five or six eggs, which are pale and spotted: they feed upon small birds, &c. and carefully lay up superfluous food till they become hungry again. They may be learned to talk pretty distinctly. 14. The *fenegalenis*, is of a blackish violet colour, with black legs, and a wedge-shaped tail. It is a native of Senegal. 15. The *brachyurus*, is green below, with yellow lines on the head, and white spots on the wings. It is found in the Molucca isles. 16. The *canadenis*, is of a dusky colour, with a yellow forehead, and white below: it has a roundish tail, and is a native of Canada. 17. The *pyrrhocorax*, is blackish, with a yellow beak, and black legs. 18. The *graculus*, is of a blackish violet colour, with a yellow back and legs. 19. The *eremita*, is greenish, with a yellowish head, a small crest on the back part of the head, and a red beak and legs. The three last are natives of Switzerland.

**CORVUS**, the RAVEN, in astronomy. See Vol. I. p. 487.

**CORVUS**, in Roman antiquity, a military engine, or rather gallery, moveable at pleasure by means of pulleys, chiefly used in boarding the enemy's ships; to cover the men.

**CORYBANTES**, in antiquity, priests of the goddess Cybele, who, inspired with a sacred fury, danced up and down, tossing their heads, and beating on cymbals or brazen drums. They inhabited mount Ida, in the island of Crete, where they nourished the infant Jupiter, keeping a continual rattling with their cymbals, that his father Saturn, who had resolved to devour all his male offspring, might not hear the child's cries.

**CORYBANTICA**, in Grecian antiquity, a festival kept in honour of the Corybantes.

**CORYCOMACHIA**, among the ancients, was a sort of exercise in which they pushed forwards a ball, suspended from the ceiling, and at its return either caught it with their hands, or suffered it to meet their body. Oribasius informs us it was recommended for extenuating too gross bodies.

**CORYDALIS**, in botany. See FUMARIA.

**CORYLUS**, the HAZEL, in botany, a genus of the monoecia polyandria class. The calix of the male consists of one trifid leaf, and contains but one flower; it has no corolla, but eight stamens: the calix of the female consists of two lacerated leaves; it has no corolla; the styli are two; and the nut is oval. There are two species, *viz.* the *avellana*, a native of Britain; and the *colurna*, a native of Bizantium.

**CORYMBIUM**, in botany, a genus of plants belonging to the syngenesia monogynia class. The calix consists of two leaves shaped like a prism, and containing one flower; the corolla has but one regular petal; and

the fruit contains one downy seed. There is but one species, a native of Africa.

**CORYMBUS**, in botany. See Vol. I. p. 637.

**CORYPHA**, in botany, a genus belonging to the order of palmæ flabellifoliæ. The corolla consists of three petals; it has six stamens, and one pistillum; and the fruit is a drupa containing one seed. There is but one species, a native of India.

**CORYPHÆNA**, in ichthyology, a genus belonging to the order of thoracici. The head is declined and truncated; the branchiostegæ membrane has six rays; and the back fin runs the whole length of the back. There are twelve species, most of them found in foreign seas.

**CORYZA**, in medicine, a catarrh of the nose. See CATARRH.

**CORZOLA**, or **CURSCOLA**, an island in the gulf of Venice, divided from Ragusa in Dalmatia, by a narrow strait: E. long. 18°, and N. lat. 42° 35'.

**COS**, the WHET-STONE, in natural history, a genus of vitrescent stones, consisting of fragments of an indeterminate figure, sub-opaque, and granulated.

Of this genus there are several species, some consisting of rougher, and others of smoother, or even of altogether impalpable particles; and used not only for whet-stones, but also for mill-stones, and other the like purposes.

**CO-SECANT**, in geometry, the secant of an arch which is the complement of another to 90°. See GEOMETRY.

**COSENZA**, the capital of the hither Calabria, in the kingdom of Naples: E. long. 16° 35', N. lat. 39° 15'. It is an archbishop's see.

**CO-SINE**, in trigonometry, the sine of an arch, which is the complement of another to 90°. See GEOMETRY.

**COSMETIC**, in physic, any medicine or preparation which renders the skin soft and white, or helps to beautify and improve the complexion; as lip-salves, cold creams, cerufs, &c.

**COSMICAL**, a term in astronomy, expressing one of the poetical risings of a star: thus a star is said to rise cosmically, when it rises with the sun, or with that point of the ecliptic in which the sun is at that time: and the cosmical setting is when a star sets in the west at the same time that the sun rises in the east.

**COSMOGRAPHY**, a description of the several parts of the visible world; or the art of delineating the several bodies according to their magnitudes, motions, relations, &c.

Cosmography consists of two parts, astronomy and geography. See ASTRONOMY, and GEOGRAPHY.

**COSSACKS**, people inhabiting the banks of the rivers Neiper and Don, near the Black-sea and frontiers of Turkey. Their country is commonly called the Ukraine, and is mostly subject to Russia.

**COSSET**, among farmers, a colt, calf, lamb, &c. brought up by hand, without the dam.

**COSTAL**, an appellation given by anatomists to several parts belonging to the sides: thus we meet with costal muscles, vertebræ, &c.

**COSTA-RICA**, a province of Mexico, bounded by the North sea on the north-east, and by the Pacific ocean on the south-west. Its chief town is New-Carthage.

**COSTARUM depressores**, in anatomy. See Vol. I. p. 215.

**COSTIVENESS**, in medicine, a preternatural detention of the *scæces*, with an unusual dryness and hardness thereof, and thence a suppression of their evacuation. See **MEDICINE**.

**COSTMARY**, the English name of a species of tanzy. See **TANACETUM**.

**COSTRANGULA**, in botany. See **SCROPHULARIA**.

**COSTUME**, a term among painters: thus a painter must observe the costume; that is, he must make every person and thing sustain its proper character, and not only observe the story, but the circumstances, the scene of action, the country or place, and make the habits, arms, manners, proportions, and the like, to correspond.

**COSTUS**, in botany, a genus of the monandria monogynia class. The interior part of the corolla is inflated and ringent; the inferior lip being trifid. There is but one species, *viz.* the arabicus, a native of both the Indies. The root of the *costus* is said to attenuate acid humours, and to promote expectoration, perspiration, and urine; but is now rarely to be met with in the shops.

**CO-TANGENT**, the tangent of an arch, which is the complement of another to 90°. See **GEOMETRY**.

**COTHURNIX**, in ornithology. See **TETRAO**.

**COTICE**, or **COTISE**, in heraldry, is the fourth part of the bend; and with us seldom if ever borne but in couples, with a bend between them. See **BEND**.

The bend thus bordered, is said to be cotised; as, he bears sable, on a bend cotised argent, three cinquefoils. See Plate LXV. fig. 11.

**COTINUS**, in botany, the trivial name of a species of *rhus*. See **RHUS**.

**COTONASTER**, in botany. See **CRATÆGUS**.

**COTRONA**, a town of the further Calabria, in the kingdom of Naples, situated on the Mediterranean, about fifteen miles south-east of St Severino: E. long. 17° 40', and N. lat. 38° 50'. It is the see of a bishop.

**COTTON**, in commerce, a soft downy substance found on the bombax, or cotton tree. See **BOMBAX**.

Cotton is separated from the seeds of the plant by a mill, and then spun and prepared for all sorts of fine works, as stockings, waistcoats, quilts, tapestry, curtains, &c. With it they likewise make muslin, and sometimes it is mixed with wool, sometimes with silk, and even with gold itself.

The finest sort comes from Bengal and the coast of Coromandel.

Cotton makes a very considerable article in commerce, and is distinguished into cotton-wool, and cotton thread. The first is brought mostly from Cyprus, St John d'Acre, and Smyrna: the most esteemed is white, long, and soft. Those who buy it in bales should see that it has not been wet, moisture being very prejudicial to it. The price of the finest is usually

from six to seven piallers the quintal of forty four ocos.

Of cotton thread, that of Damas, called cotton d'ounce, and that of Jerusalem, called bazas, are the most esteemed; as also that of the Antilles islands. It is to be chosen white, fine, very dry, and evenly spun. The other cotton-threads are the half bazas, the rames, the beledin, and gondezal; the payas and montafiri, the geneguins, the baquins, the joffelassars, of which there are two sorts. Those of India, known by the name of Tutucorin, Java, Bengal, and Surat, are of four or five sorts, distinguished by the letters A, B, C, &c. They are sold in bags, with a deduction of one pound and a half on each of those of Tutucorin, which are the dearest, and two pounds on each bag of the other sorts. For those of Fielebass, Smyrna, Aleppo, and Jerusalem, the deduction at Amsterdam is eight in the hundred for the tare, and two in the hundred for weight, and on the value one per cent. for prompt payment.

Cotton of Siam, is a kind of silky cotton in the Antilles, so called because the grain was brought from Siam. It is of an extraordinary fineness, even surpassing silk in softness. They make hose of it there preferable to silk ones, for their lustre and beauty. They sell from ten to twelve and fifteen crowns a pair, but there are very few made, unless for curiosity.

*The manner of picking COTTON, as practis'd in the Antilles.* The bags are made of coarse cloth, of which they take three ells and a half each: the breadth is one ell three inches. When the bag has been well soaked in water, they hang it up, extending the mouth of it to cross pieces of timber nailed to posts fixed in the ground seven or eight feet high. He who packs it goes into the bag, which is six feet nine inches deep, or thereabouts, and presses down the cotton, which another hands him, with hands and feet; observing to tread it equally every where, and putting in but little at a time. The best time of packing is in rainy moist weather, provided the cotton be under cover. The bag should contain from 300 to 320 pounds. The tare abated in the Antilles is three in the hundred. Cotton being a production applicable to a great variety of manufactures, it cannot be too much cultivated in our own plantations that will admit of it.

Cotton wool, not of the British plantations, pays on importation  $3\frac{3}{4}$ d. the pound, and draws back on exportation  $\frac{67\frac{1}{2}}{100}$ d. Cotton yarn the pound, not of the

East Indies, pays  $2\frac{8\frac{1}{2}}{100}$ d. and draws back  $2\frac{58\frac{1}{2}}{100}$ d.

Cotton yarn the pound of the East Indies pays  $4\frac{1\frac{1}{2}}{100}$ d. and draws back  $4\frac{7\frac{1}{2}}{100}$ d.

*Lavender COTTON.* See **SANTOLINA**.

*Philosophic COTTON*, a name given to the flowers of zinc, on account of their white colour, and resemblance to cotton.

*COTTON WELD.* See **GNAPHALIUM**.

**COTTUS**, in ichthyology, a genus belonging to the order of thonsci. The head is broader than the body, and the gill-membrane has six rays. There are six



- fix species, viz. the cataphractus, quadricornis, grunniens, scaber, scorpius, and gobio.
- COTULA**, in botany, a genus of the syngentia polygamia superflua class. The receptacle is naked; the pappus is marginated; and the corollulæ of the disk are divided into four segments; the species are six, none of them natives of Britain.
- COTULA**, or **COTYLA**, in antiquity, a liquid measure among the Greeks, equal to the hemina of the Romans, containing half a sextary, or four acetabula: hence it appears that it contained ten ounces of wine, and nine of oil.
- COTURNIX**, in ornithology. See **TETRAO**.
- COTYLEDON**, in botany, a genus of the decandria pentagynia class. The calix is divided into five segments; the corolla consists of one petal; there are five nectariferous scales at the base of the germen; and it has five capsules. The species are eight, only one of which is a native of Britain, viz. the umbilicus, or navel-wort.
- COTYLEDONES**, in anatomy, are certain glandular bodies, adhering to the chorion of some animals.
- COUGH**, in medicine. See **MEDICINE**.
- COUGH**, in painting, a term used for each lay or impression of colour, either in oil or water, wherewith the painter covers his canvas, wall, wainscot, or other matter to be painted.
- COUGH-GRASS**, in botany. See **TRITICUM**.
- COUCHANT**, in heraldry, is understood of a lion, or other beast, when lying down, but with his head raised, which distinguishes the posture of couchant from dormant, wherein he is supposed quite stretched out and asleep. See Plate LXV. fig. 9.
- COUCHE**, in heraldry, denotes any thing lying along: thus, chevron couché, is a chevron lying sideways, with the two ends on each side of the shield, which should properly rest on the base.
- COVERING of a cataract**, in surgery. See **SURGERY**.
- COVENANT**, a contract or agreement, made between two or more persons, to perform something.
- COVENTRY**, a city and bishop's see in Warwickshire, situated 80 miles north west of London, and 10 miles north of Warwick: W. long. 1° 26', and N. lat. 52° 25'.
- COVENTRY-BELLS**, in botany. See **CAMPANULA**.
- COVERDEN**, a town of the united provinces, situated in that of Overijssel, near the confines of Westphalia: E. long. 6° 45', and N. lat. 52° 50'.
- CO-VERSED SINE**, in geometry, the remaining part of the diameter of a circle, after the versed sine is taken from it. See **GEOMETRY**.
- COVERT WAY**, or **CORRIDOR**, in fortification, a space of ground, level with the field on the edge of the ditch, three or four fathoms broad, ranging quite round the half moons, and other works toward the country. It has a parapet raised on a level, together with its banquetts and glacis. See **FORTIFICATION**.
- COVERTURE**, in law, is applied to the state and condition of a married woman, who is under the power of her husband, and therefore called  *femme covert* .
- COVING**, in building, is when houses are built projecting over the ground plot, and the turned projecture arched with timber, lathed and plaistered.
- COULTER**, in husbandry, an iron-instrument, fixed in the beam of a plough, and serving to cut the edge of each furrow. See **AGRICULTURE**.
- COUNCIL**, or **COUNSEL**, in a general sense, an assembly of divers considerable persons to concert measures relating to the state.
- Aulic COUNCIL**. See **AULIC**.
- Cabinet COUNCIL**. See **PRIVY-COUNCIL**.
- Common COUNCIL**, in the city of London, is a court wherein are made all bye-laws which bind the citizens. It consists, like the parliament, of two houses; an upper, composed of the lord mayor and aldermen; and a lower, of a number of common-council-men, chosen by the several wards, as representatives of the body of the citizens.
- Privy COUNCIL**, the *primum mobile* of the civil government of Great Britain, bearing part of that great weight in the government which otherwise would be too heavy upon the king.
- It is composed of eminent persons, the number of whom is at the sovereign's pleasure, who are bound by oath to advise the king to the best of their judgment, with all the fidelity and secrecy that becomes their station. The king may declare to, or conceal from, his privy-council whatever he thinks fit; and has a select council out of their number, commonly called the *cabinet council*, with whom his majesty determines such matters as are most important, and requires the utmost secrecy.
- Privy-counsellors, though but gentlemen, have precedence of all the knights and younger sons of barons and viscounts, and are styled right honourable.
- COUNCIL of war**, an assembly of the principal officers of an army or fleet, occasionally called by the general or admiral to concert measures for their conduct with regard to sieges, retreats, engagements, &c.
- COUNCIL**, in church history, an assembly of prelates and doctors, met for the regulating matters relating to the doctrine or discipline of the church.
- National COUNCIL**; is an assembly of prelates of a nation under their primate or patriarch.
- Oecumenical or general COUNCIL**, is an assembly which represents the whole body of the universal church, The Romanists reckon eighteen of them; Bullinger, in his treatise de Conciliis, six; Dr Prideaux, seven; and bishop Beveridge has increased the number to eight, which, he says, are all the general councils which have ever been held since the time of the first Christian emperor. They are as follows: 1. The council of Nice, held in the reign of Constantine the Great, on account of the heresy of Arius. 2. The council of Constantinople, called under the reign and by the command of Theodosius the Great, for much the same end that the former council was summoned. 3. The council of Ephesus, convened by Theodosius the younger, at the suit of Nestorius. 4. The council of Calcedon, held in the reign of Marcianus, which approved of the Eutychian heresy. 5. The second council of Constantinople, assembled by the emperor Justinian.

Justinian, condemned the three chapters taken out of the book of Theodorus of Mopsuestia, having first decided that it was lawful to anathematize the dead. Some authors tell us, that they likewise condemned the several errors of Origen about the Trinity, the plurality of worlds, and pre-existence of souls. 6. The third council of Constantinople, held by the command of Constantinus Pogonatus the emperor, in which they received the definitions of the five first general councils, and particularly that against Origen and Theodorus of Mopsuestia. 7. The second Nicene council. 8. The fourth council of Constantinople, assembled when Lewis II. was emperor of the west. The regulations which they made are contained in twenty-seven canons, the heads of which are set down by M. du Pin, to whom the reader is referred.

**COUNSELLOR**, in general, a person who advises another: thus we say, a counsellor at law, a privy counsellor, &c.

**COUNSELLOR at law**, a person retained by a client to plead his cause in a public court of judicature.

**COUNT**, a nobleman who possesses a domain erected into a county. The dignity is a medium between that of a duke and a baron.

Counts were originally lords of the court, or of the emperor's retinue, and had their name comites *a comitando*.

**COUNT-WHEEL**, in the striking part of a clock, a wheel which moves round once in twelve or twenty-four hours. It is sometimes called the locking wheel.

**COUNTER**, a term which enters into the composition of diverse words of our language, and generally implies opposition; but when applied to deeds, means an exact copy kept of the contrary party, and sometimes signed by both parties.

**COUNTER ALLEY**, in gardening. See ALLEY.

**COUNTER APPROACHES**, in fortification, lines and trenches made by the besieged in order to attack the works of the besiegers, or to hinder their approaches.

**COUNTER BARRY**, or **CONTRE BARRE'**, in heraldry, is the same as our bendy sinister *per bend* counter-changed. See BARRY.

**COUNTER BATTERY**, is a battery raised to play upon another to dismount the guns.

**COUNTER-CHANGED**, in heraldry, is when any field or charge is divided or parted by any line or lines of partition, consisting all interchangeably of the same tinctures. See plate LXV. fig. 12.

**COUNTER-CHARGE**, a reciprocal charge or recrimination brought against an accuser.

**COUNTER-CHEVRONED**, a shield chevrony, parted by one or more partition lines.

**COUNTER-COMPOSED**, in heraldry, is when the figure is compounded of two panes, as in Plate LXV. fig. 13.

**COUNTER-DRAWING**, in painting, is the copying a design, or painting, by means of a fine linen-cloth, an oiled paper, or other transparent matter, where the strokes appearing through are followed with a pencil, with or without colour. Sometimes it is done on glass, and with frames or nets divided into squares

with silk or with thread, and also by means of instruments invented for the purpose, as the parallclo-gram.

**COUNTER-ERMINE**, in heraldry, is the contrary of ermine, being a black field with white spots. See Plate LXV. fig. 14.

**COUNTERFEITS**, in law, are persons that obtain any money or goods by counterfeit letters or false tokens, who being convicted before justices of assize or of the peace, &c. are to suffer such punishment as shall be thought fit to be inflicted under death, as imprisonment, pillory, &c.

**COUNTER-FACED**, or **CONTER-FACE'**, in heraldry, is the same that we call barry *per pale* counter-changed; but then the number of panes into which the field is divided is always specified. See BARRY.

**COUNTER-FOIL**, or **COUNTER-STOCK**, in the exchequer, that part of a tally which is kept by an officer of the court.

**COUNTER-FORTS**, spurs or buttresses serving as props to a wall subject to bulge or be thrown down.

**COUNTER-FUGUE**, in music, is when the fugues go contrary to one another. See FUGUE.

**COUNTER GUARD**, in fortification, is a work raised before the point of a bastion, consisting of two long faces parallel to the faces of the bastion, making a salient angle: they are sometimes of other shapes, or otherwise situated.

**COUNTER-LIGHT**, or **CONTER-JOUR**, a light opposite to any thing, which makes it appear to disadvantage. A single counter-light is sufficient to take away all the beauty of a fine painting.

**COUNTER-march**, in military affairs, a change of the face or wings of a battalion, by which means those that were in the front come to be in the rear.

It also signifies returning, or marching back again.

**COUNTER-MINE**, in war, a well and gallery drove and sunk till it meet the enemy's mine, to prevent its effect.

**COUNTER-PALED**, *contre pale*, in heraldry, is when the escutcheon is divided into twelve pales parted *per fesse*, the two colours being counter-changed; so that the upper are of one colour, and the lower of another.

**COUNTER-PART**, in music, denotes one part to be applied to another. Thus the bass is said to be a counter-part to the treble.

**COUNTER-PASSANT**, is when two lions are in a coat of arms, and the one seems to go quite the contrary way from the other.

**COUNTER-POINT**, in music, the art of composing harmony, or of disposing several parts in such a manner as to make an agreeable whole or a concert.

**COUNTER POINTED**, *contre pointé*, in heraldry, is when two chevrons in one escutcheon meet in the points, the one rising as usual from the base, and the other inverted falling from the chief; so that they are counter to one another in the points. They may also be counter-pointed when they are founded upon the sides of the shield, and the points meet that way, called counter-pointed in fesse.

COUNTER-

- COUNTER-POTENT**, *contre-potencé*, in heraldry, is reckoned a fur as well as vair and ermine, but composed of such pieces as represent the tops of crutches, called in French *potences*, and in old English *potents*.
- COUNTER-PROOF**, in rolling-press printing, a print taken off from another fresh printed; which by being passed through the press, gives the figure of the former, but inverted. To counter-prove, is also to pass a design in black lead, or red chalk, through the press, after having moistened with a sponge both that and the paper on which the counter-proof is to be taken.
- COUNTER-QUARTERED**, *contre-ecartelé*, in heraldry, denotes the escutcheon, after being quartered, to have each quarter again divided into two.
- COUNTER-SALIENT**, is when two beasts are borne in a coat leaping from each other directly the contrary way.
- COUNTER-SCARP**, in fortification, is properly the exterior talus or slope of the ditch; but it is often taken for the covered way and the glacis. In this sense we say, the enemy have lodged themselves on the counter-scarp.
- Angle of the COUNTER-SCARP*, is that made by the two sides of the counter-scarp meeting before the middle of the curtain.
- COUNTER-SIGNING**, the signing the writing of a superior in quality of secretary. Thus charters are signed by the king, and counter-signed by a secretary of state or lord chancellor.
- COUNTER-SWALLOW-TAIL**, in fortification, an outwork in form of a single tenaille, wider at the gorge than the head.
- COUNTER-TENOR**, called by the French *haut-contre*, one of the middle parts of music opposite to the tenor. See **TENOR**.
- COUNTER-TIME**, in the menage, is the defence or resistance of a horse that interrupts his cadence, and the measure of his menage, occasioned either by a bad horseman, or by the malice of the horse.
- COUNTER** is also the name of a counting-board in a shop, and of a piece of metal with a stamp on it, used in playing at cards.
- Counter of a horse*, that part of a horse's forehead which lies between the shoulders and under the neck.
- COUNTERS in a ship**, are two. 1. The hollow arching from the gallery to the lower part of the straight piece of the stern, is called the upper counter. 2. The lower counter is between the transom and the lower part of the gallery.
- COUNTER** is also the name of two prisons in the city of London, *viz.* the Poultry and Woodstreet.
- COUNTING**. See **ACCOUNTING**.
- COUNTY**, in geography, originally signified the territory of a count or earl, but now it is used in the same sense with shire. See **SHIRE**.
- COUNTY-COURT**, a court of justice, held every month in each county, by the sheriff or his deputy.
- COUPED**, in heraldry, is used to express the head, or any limb, of an animal, cut off from the trunk, smooth; distinguishing it from that which is called *erased*, that is, forcibly torn off, and therefore is ragged and uneven.
- COUPED** is also used to signify such crosses, bars, bends, chevrons, &c. as do not touch the sides of the escutcheons, but are, as it were, cut off from them.
- COUPER**, the name of two towns of Scotland, the one situated about twelve miles north-east of Perth, in the shire of Angus, W. long. 3°, and N. lat. 56°. 30'; and the other in the county of Fife, about ten miles west of St Andrews: W. long. 2° 40', and N. lat. 56° 20'.
- COUPLE-CLOSS**, in heraldry, the fourth part of a chevron, never borne but in pairs, except there be a chevron between them, faith Guillim, though Bloom gives an instance to the contrary.
- COUPLET**, a division of a hymn, ode, song, &c. wherein an equal number, or equal measure of verses is found in each part; which divisions, in odes, are called strophes.
- COURBARIL**, in botany. See **HYMENEA**.
- COURIER**, a messenger sent post, or express, to carry dispatches.
- COURLAND**, a dutchy situated between 21° and 26° of E. long. and between 56° 30', and 57° 30' N. lat. It is bounded by the river Dwina, which divides it from Livonia, on the north; by Lithuania, on the east; by Samogitia, on the south; and by the Baltic sea on the west; being 130 miles long, and 30 broad.
- COURSING**, among sportsmen, is of three sorts, *viz.* at the deer, at the hare, and at the fox. These coursings are with greyhounds; for the deer there are two sorts of coursings, the one with the paddock, the other either in the forest or purlieu. See **PADDOCK**, &c.
- In coursing the hare, the best way is to find one fitting, and when she is first started, to give her ground, or law, which is generally twelve-score yards. In coursing a fox, you are to stand close, and on a clear wind.
- COURT**, in a law sense, the place where judges distribute justice, or exercise jurisdiction: also the assembly of judges, jury, &c. in that place.
- Courts are divided into superior and inferior, and into courts of record and base courts: again, courts are either such as are held in the king's name, as all the ordinary courts; or where the precepts are issued in the name of the judge, as the admiral's court.
- The superior courts are those of the king's-bench, the common-pleas, the exchequer, and the court of chancery. See **KING'S-BENCH**, **COMMON-PLEAS**, **EXCHEQUER**, and **CHANCERY**.
- A court of record is that which has a power to hold plea, according to the course of the common law, of real, personal, and mixt actions; where the debt or damage is forty shillings, or above, as the court of King's-Bench, &c.
- Court of admiralty*. See **ADMIRALTY**.
- Court of arches*. See **ARCHES**.
- COURT-BARON**, a court that every lord of a manor has within his own precincts. This court must be held

by prescription, and is of two kinds, *viz.* by common law, and by custom: the former is where the barons or freeholders, being suitors, are the judges; the other is that where the lord, or his steward, is the judge.

**COURT of chivalry, or the marshal's COURT**, that whereof the judges are the lord high constable, and the earl marshal of England.

This court is the fountain of martial law; and the earl marshal is not only one of the judges, but is to see execution done.

**COURT of conscience**, a court in the cities of London, Westminster, and some other places, that determines matters in all cases where the debt or damage is under forty shillings.

**COURT of delegates**, a court where delegates are appointed by the king's commission, under the great seal, upon an appeal to him from the sentence of an archbishop, &c. in ecclesiastical causes; or of the court of admiralty, in any marine cause.

**COURT of hustings**, a court of record held at Guildhall, for the city of London, before the lord mayor and aldermen, sheriffs and recorder, where all pleas, real, personal, and mixt, are determined; where all lands, tenements, &c. within the said city, or its bounds, are pleadable in two hustings; the one called the hustings of plea of lands, and the other the hustings of common pleas. The court of hustings is the highest court within the city, in which writs of exigent may be taken out, and outlawries awarded, wherein judgment is given by the recorder.

There are also other courts called wardmotes, or meeting of the wards; and courts of holymote, or assemblies of the guilds and fraternities.

**COURT-LEET**, a court ordained for the punishment of offences under high treason against the crown.

**COURT-MARTIAL**, a court appointed for the punishing offences in officers, soldiers, and sailors, the powers of which are regulated by the mutiny-bill.

**COURT of requests**, was a court of equity, of the same nature with the chancery, but inferior to it.

**COURTESY, or CURTESY of England**, a certain tenure whereby a man marrying an heiress seized of lands of fee simple, or fee tail general, or seized as heir of the tail special, and getteth a child by her that cometh alive into the world, though both it and his wife die forthwith; yet, if she were in possession, he shall keep the land during his life, and is called *tenant per legem Angliæ*, or tenant by the courtesy of England; because this privilege is not allowed in any country except Scotland, where it is called *curialitas Scotiae*.

**COURTISAN**, a woman who prostitutes herself for hire, especially to people of superior rank.

**COURTRAY**, a town of the Austrian Netherlands, situated on the river Lys, about twenty-three miles south-west of Ghent, and fourteen east of Ypres: E. long. 3° 10', and N. lat. 50° 48'.

**COUSIN**, a term of relation between the children of brothers and sisters, who in the first generation are called cousin-germans, in the second generation second cousins, &c. If sprung from the relations of the

father's side, they are denominated paternal cousins; if on the mother's, maternal.

**COUSU**, in heraldry, signifies a piece of another colour or metal placed on the ordinary, as if it were sewed on, as the word imports. This is generally of colour upon colour, or metal upon metal, contrary to the general rule of heraldry.

**COVERT**, in heraldry, denotes something like a piece of hauging, or a pavillion falling over the top of a chief or other ordinary, so as not to hide, but only to be a covering to it.

**COW**, in zoology. See BOS.

**Sea-Cow**, in zoology. See TRICHECUS.

**COW-ITCH**, in botany. See PHASEOLUS.

**COW'S-LIP**, in botany. See PRIMULA.

**COW'S-LIP of Jerusalem** See PULMONARIA.

**COWARD**, in heraldry, a term given to a lion borne in an escutcheon with his tail doubled or turned in between his legs.

**COWES**, a town and harbour on the northern coast of the isle of Wight, situated about eight miles south of Plymouth: W. long. 1° 25', and N. lat. 50° 45'.

**COWL, or COUL**, a habit worn by the Bernardines and Benedictines, of which there are two kinds; one white, very large, worn in ceremonies; the other black, worn on ordinary occasions, in the streets, &c.

**Friar's COWL**, in botany. See ARISARUM.

**COXWOLD**, a market-town in the north riding of Yorkshire, about fourteen miles north of the city of York: W. long. 50', and N. lat. 54° 20'.

**COZUMEL**, an island near the western coast of Yucatan, where Cortez landed and refreshed his troops, before entering upon the conquest of Mexico: W. long. 89°, and N. lat. 13°.

**CRAB**, in zoology. See CANCER.

**CRAB'S CLAWS**, in the materia medica, are the tips of the claws of the common crab broken off at the verge of the black part, so much of the extremity of the claws only being allowed to be used in medicine as is tinged with this colour. The blackness, however, is only superficial; they are of a greyish white within, and when levigated furnish a tolerable white powder.

Crab's claws are of the number of the alkaline absorbents, but they are superior to the generality of them in some degree, as they are found on a chemical analysis to contain a volatile urinous salt.

**CRAB'S EYES**, in pharmacy, are a strong concretion in the head of the cray-fish. They are rounded on one side, and depressed and sinuated on the other, considerably heavy, moderately hard, and without smell. We have them from Holland, Muscovy, Poland, Denmark, Sweden, and many other places.

Crab's eyes are much used both in the shop-medicines and extemporaneous prescriptions, being accounted not only absorbent and drying, but also discutive and diuretic.

**CRAB**, an engine of wood, with three claws, placed on the ground like a capstan, and used at launching or heaving ships into the dock.

**CRABRO,**

- CRABRO**, in zoology. See **TENTHREDO**.
- CRACOA**, in botany. See **VICIA**.
- CRACKER**, in ornithology. See **ANAS**.
- CRACOW**, by some accounted the capital city of Poland, is situated in the province of little Poland, and palatinate of Cracow, in a fine plain near the banks of the Vistula. It has an university, and is the see of a bishop, and the seat of the supreme courts of justice: it stands about 140 miles south-west of Warsaw, in 19° 30' of E. long. and 50° N. lat.
- CRADLE**, a well known machine in which infants are rocked to sleep.
- It denotes also that part of the stock of a cross bow where the bullet is put.
- CRADLE**, in surgery, a case in which a broken leg is laid after being set.
- CRADLE**, among shipwrights, a timber frame made along the outside of a ship by the bilge, for the convenience of launching her with ease and safety.
- CRAFT**, in the sea-language, signifies all manner of nets, lines, hooks, &c. used in fishing. Hence all such little vessels as ketches, boats, and smacks, &c. used in the fishing trade, are called small craft.
- CRAIL**, or **CAREIL**, a parliament town of Scotland, situated on the sea-coast of the county of Fife, about seven miles south-east of St Andrews: W. long. 2° 20' and N. lat. 56° 17'.
- CRAMBE**, *wild SEA-CABBAGE*, in botany, a genus of the tetradynamia siliquosa class. The four long filaments are forked at the points, and the antheræ are fixed upon one of them; the berry is dry, globular, and deciduous. The species are three, only one of which, *viz.* the *maritima*, or sea-colewort, is a native of Britain.
- CRAMP**, in medicine, a convulsive contraction of a muscular part of the body.
- CRAMP FISH**. See **TORPEDO**.
- CRAMP IRON**, or **CRAMPS**, a piece of iron bent at each end, which serves to fasten together pieces of wood, stones, or other things.
- CRAMPER**, in ichthyology. See **CYPRINUS**.
- CRAMPONÉ'E**, in heraldry, an epithet given to a cross which has at each end a cramp or square piece coming from it; that from the arm in chief towards the sinister angle, that from the arm on that side downwards, that from the arm in base towards the dexter side, and that from the dexter arm upwards. See Plate LXVI. fig. 5.
- CRANAGE**, the liberty of using a crane at a wharf, and also the money paid for drawing up wares out of a ship, &c. with a crane.
- CRANE**, in ornithology. See **ARDEA**.
- CRANE**, in mechanics, a machine used in building and commerce for raising large stones and other weights. See **MECHANICS**.
- CRANE'S BILL**, among surgeons, a kind of forceps, so called from its figure.
- CRANE'S BILL**, in botany. See **GERANIUM**.
- CRANE-FLY**, in zoology. See **TIPULA**.
- CRANGANOR**, a Dutch factory on the Malabar-coast, in the hither India, about thirty miles north of Cochin: E. long. 75° 5', and N. lat. 10°.
- CRANIOLARIA**, in botany, a genus of the didynamia angiospermia class. The perianthium consists of four leaves, and the spathe of one; and the tube of the corolla is very long. There are two species, none of them natives of Britain.
- CRANIUM**, in anatomy. See Vol. I. p. 151.
- CRANNY**, in glass-making, an iron-instrument, where-with the necks of glasses are formed.
- CRAPE**, in commerce, a kind of stuff, made in the manner of gauze, with raw silk, gummed and twisted on the mill.
- CRAPULA**, among physicians. See **SURFEIT**.
- CRISIS**, among physicians, is used to signify such a due mixture of qualities in a human body, as constitutes a state of health.
- CRASSAMENTUM**, in physic, the thick red or fibrous part of the blood, otherwise called *cruur*, in contradistinction to the serum or aqueous part.
- CRASSULA**, in botany, a genus of the pentandria pentagynia class. The calix consists of five leaves, and the corolla of five petals; there are five nectariferous glands at the base of the germen; and it has five cap-sules. There are 17 species, none of them natives of Britain.
- CRATÆGUS**, in botany, a genus of the icofandria digynia class. The calix has five segments, and the corolla five petals; the berry is below the flower, and contains two seeds. There are nine species, three of which are natives of Britain, *viz.* the *aria*, or white bean-tree; the *torminalis*, service-tree, or sorb; and the *oxyacantha*, white-thorn, or hawthorn.
- CRATCHES**, in the menage, a swelling on the pastern, under the fet lock, and sometimes under the hoof; for which reason it is distinguished into the *finew cratches*, which affect the finew, and those upon the *croneet*, called *quitter-bones*.
- CRATER**, in astronomy. See Vol. I. p. 487.
- CRATEVA**, in botany, a genus of the polyandria monogynia class.
- CRATO**, a town of Aentejo, in Portugal, situated about seven miles south of Portalegre: W. long. 8° 2' and N. lat. 38° 50'.
- CRAVEN**, in geography, a division of the west riding of Yorkshire, situated on the river Aire.
- CRAX**, in ornithology, a genus of birds, belonging to the order of gallinæ. The base of the beak of each mandible is covered with wax; and the feathers of the head are curled. There are five species, *viz.* 1. The *alecator*, or Indian hen of Sloane, is about the size of a common hen: It is black, with a white belly. A yellow wax covers about one half of each mandible: The tongue is entire; the temples are bare, and black; the tail is roundish, and consists of 14 prime feathers; and it has no spur. It is found in the warm parts of America. 2. The *rubra*, or Peruvian hen, is red, with a blueish head: It is a native of Peru. 3. The *mitu*, or Brazilian pheasant, is black, with a dusky belly, and red wax: It is a native of Guinea and Bra-  
zil.

- zil. 4. The globicera, has a yellow protuberance between the nostrils, and is of a blueish black colour: It is likewise a native of Brazil. 5. The pauxi, or Mexican pheasant of Brissonius, is of a blueish colour, with blue wax, and the tip of the tail and belly white: It is a native of Mexico.
- CRAYON**, a name for all coloured stones, earths, or other minerals used in designing or painting in pastel. Crayons may be made of any colour, and adapted for the faces of men, women, landscapes, clouds, sunbeams, buildings, and shadows, in the following manner: Take plaster of Paris, or alabaster calcined, and of the colour of which you intend to make your crayons, a sufficient quantity: grind them first asunder, and then together, and with a little water make them into a paste: then roll them with your hand upon the grinding stone into long pieces, and let them dry moderately in the air: when they are to be used, scrape them to a point like a common pencil.
- CREAM**, the fat part of the milk that swims upon the surface.
- CREAM of tartar**. See **CHEMISTRY**.
- CREAT**, in the menage, an usher to a riding-master; or, a gentleman bred in the academy, with intent to make himself capable of teaching the art of riding the great horse.
- CREATION**, the producing something out of nothing, which strictly and properly is the effect of the power of God alone, all other creations being only transformations, or change of shape.
- CREDENTIALS**, letters of recommendation, and power, especially such as are given to ambassadors, or public ministers, by the prince or state that sends them to foreign courts.
- CREDIBILITY**, a species of evidence, less indeed than absolute certainty or demonstration, but greater than mere possibility: it is nearly allied to probability, and seems to be a mean between possibility and demonstration.
- CREDIT**, in commerce, a mutual trust or loan of merchandize, or money, on the reputation of the probity and sufficiency of a dealer. See **COMMERCE**.
- CREDITON**, a market-town in Devonshire, considerable for a good woolen manufactory: it is situated about nine miles north-west of Exeter, in  $3^{\circ} 50'$  W. long. and  $50^{\circ} 50'$  N. lat.
- CREDITOR**, a person to whom any sum of money is due, either by obligation, promise, or otherwise.
- CREED**, a brief summary of the articles of a Christian's belief.
- The most ancient form of creeds is that which goes under the name of the apostolic creed; besides this, there are several other ancient forms and scattered remains of creeds to be met with in the primitive records of the church. The first is a form of apostolical doctrine, collected by Origen; the second is a fragment of a creed preserved by Tertullian; the third remains of a creed, is in the works of Cyprian; the fourth, a creed composed by Gregory Thaumaturgus, for the use of his own church; the fifth, the creed of Lucian the martyr; the sixth, the creed of the apo-
- stolical constitutions. Besides these scattered remains of the ancient creeds, there are extant some perfect forms, as those of Jerusalem, Cæsarea, Antioch, &c.
- The most universal creeds are, the apostolical, the Athanasian, and the Nicene creeds.
- CREEK**, the part of a haven where any thing is landed from the sea.
- CREEPER**, in ornithology. See **CERTHIA**.
- CREMA**, a city and bishop's see of Italy, capital of a district of the Milanese, called from it Cremasco: it stands almost in the middle between Milan and Mantua, in  $10^{\circ} 15'$  E. long. and  $45^{\circ} 20'$  N. lat.
- CREMASTER**, in anatomy. See Vol. I. p. 272.
- CREMONA**, a city of Italy, and capital of a district of the Milanese, called from it the Cremonese, is situated forty-five miles south-east of Milan, in  $10^{\circ} 30'$  E. long. and  $45^{\circ}$  N. lat.
- CRENATED**, in botany. See Vol. I. p. 640.
- CRENCLES**, in a ship, small ropes, spliced into the bolt-ropes of the sails of the main-mast and fore-mast. They are fastened to the bow-line bridles; and are also to hold by, when a bonnet is shaken off.
- CRENELLE**, or **IMBATTLED**, in heraldry, is used when any honourable ordinary is drawn, like the battlements on a wall to defend men from the enemies shot. See Plate LXVI. fig. 6.
- CRENOPHYLAX**, in antiquity, a magistrate at Athens, who had the inspection of fountains.
- CRUPANCE**, in the menage, a chop, or crutch, in a horse's leg, given by the sponges of the shoes of one of the hinder feet crossing and striking against the other hinder foot. This crutch degenerates into an ulcer.
- CREPIS**, in botany, a genus of the Syngenesia polygamia æqualis class. The receptacle is naked; the calix is calcinated, with deciduous scales; and the pappus is plumose, and furnished with a stipes. The species are fourteen, three of which are natives of Britain, viz. the testarum, or smooth succory hawk-weed; the biennis, or rough succory hawk-weed; and the scetida, or stinking hawk-weed.
- CREPUNDIA**, in antiquity, a term used to express such things as were exposed along with children, as rings, jewels, &c. serving as tokens whereby they afterwards might be known.
- CRESCENT**, the new moon, which, as it begins to recede from the sun, shews a little rim of light, terminating in points, called horns, that are still encreasing, till it is in opposition to the sun, at which time it is full moon, or quite round.
- CRESCENT**, in heraldry, a bearing in form of a new moon. See Plate LXV. fig. 10.
- It is used either as an honourable bearing, or as the difference to distinguish between elder and younger families; this being generally assigned to the second son, and those that descend from him. The figure of the crescent is the Turkish symbol, with its points looking towards the top of the chief, which is its most ordinary representation, called crescent montant. Crescents are said to be adossed, when their backs are turned towards each other; a crescent is said to be inverted, when

- when its points look towards the bottom; turned crescents have their points looking to the dexter side of the shield; cornuted crescents, to the sinister side; and affronted crescents, contrary to the adossed, have their points turned to each other.
- CRESCENT**, a term among farriers. Thus a horse is said to have crescents when that part of the coffin-bone, which is most advanced, falls down and presses the sole outwards, and the middle of her hoof above shrinks, and becomes flat, by reason of the hollowness beneath it.
- CRESCENTIA**, in botany, a genus of the didymia angiospermia class. The calix is split into two equal parts; the corolla is gibbous; and the berry is unilocular, and contains many seeds. There is but one species, a native of Jamaica.
- CRESS**, or **CRASSES**, in botany. See **SISYMBRIUM**. *Indian Cress*. See **TROPÆOLUM**.
- CRESSY**, a port-town of Picardy in France, about forty-four miles south of Calais; and twenty-seven north-west of Abbeville, remarkable on account of the victory obtained there over the French, by Edward III. of England, in the year 1346: E. long. 2°, N. lat. 50° 20'.
- CREST**, in armoury, the top-part of the armour, for the head, mounting over the helmet, in manner of a comb, or tuft of a cock, deriving its name from *crissa*, a cock's comb.
- The crest was for the most part made of feathers, or the hair of horses tails or mains. The soldiers took great pride in adorning them.
- CREST**, in heraldry, the uppermost part of an armoury, or that part of the cask or helmet next to the mantle. Guillim says, the crest, or cognizance, claims the highest place, being seated on the most eminent part of the helmet; yet so as to admit of an interposition of some escrol, wreath, chapeau, crown, &c.
- The crest is esteemed a greater mark of nobility than the armory; being borne at tournaments, to which none were admitted till such time as they had given proof of their nobility: sometimes it serves to distinguish the several branches of a family; and it has served, on occasion, as a distinguishing badge of factions: sometimes the crest is taken for the device; but more usually is formed of some piece of the arms. Families that exchange arms do not change their crest.
- CREST**, among carvers, an imagery, or carved work, to adorn the head or top of any thing, like our modern corniche.
- CREST-fallen**, a fault of an horse, when the upper part of his neck, called the crest, hangs to one side: this they cure by placing it upright, clipping away the spare skin, and applying plasters to keep it in a proper position.
- CRESTED**, something furnished with a crest. See **CREST**.
- CRETA**, or **CHALK**, in natural history. See **CHALK**.
- CREUX**, a French term used among artists, and literally signifies a hollow cavity or pit, out of which something has been scooped or dug: whence it is used
- to signify that kind of sculpture, where the lines and figures are cut and formed within the face or plan of the plate or matter engraved; and thus it stands in opposition to *relievo*, where the lines and figures are embossed, and rise prominent above the face of the matter engraved on.
- CREW**, the company of sailors belonging to a ship, boat, or other vessel.
- CREX**, in ornithology. See **RALLUS**.
- CRIBBAGE**, a game at cards, to be learnt only by practice.
- CRIBRATION**, in pharmacy, the passing any substance through a sieve, or search, in order to separate the finer particles from the grosser.
- CRIBROSUM** *os*, in anatomy, called also *os ethmoides*. See Vol. I. p. 157.
- CRICETUS**, in zoology. See **MUS**.
- CRICK**, among farriers, is when a horse cannot turn his neck any manner of way, but holds it fore right, insomuch that he cannot take his meat from the ground without great pain.
- CRICKET**, in zoology. See **GRYLLUS**. *Male CRICKET*. See **GRYLLOTALPA**.
- CRICKLADE**, a borough-town of Wiltshire, situated on the river Isis, about twenty-six miles south-west of Oxford: W. long. 1° 55', and N. lat. 51° 35'.
- CRICO-ARYTANOIDÆUS**, in anatomy. See Vol. I. p. 300.
- CRICOIDES**, in anatomy. See Vol. I. p. 300.
- CRICO-THYROIDÆUS**, in anatomy. See Vol. I. p. 300.
- CRIM**, or **CRIM-TARTARY**, a peninsula in the Black sea, between 33° and 37° E. long. and between 44° and 46° N. lat. It is joined to Little Tartary by a narrow isthmus.
- CRIME**, the transgression of a law, either natural or divine, civil or ecclesiastical.
- CRIMSON**, one of the seven red colours of the dyers. See **DYING**.
- CRINONES**, among physicians, small worms that breed in the skin, called also *dracunculi*.
- CRINUM**, in botany, a genus of the hexandria monogynia class. The corolla is tunnel-shaped, and consists of one leaf, divided into six segments; and the permen is at the bottom of the corolla. There are four species, none of them natives of Britain.
- CRISIS**, in medicine, is used in different senses, both by the ancient and modern physicians. With some it means frequently no more than the excretion of any noxious substance from the body. Others take the word for a secretion of the noxious humours made in a fever. Others use it for the critical motion itself; and Galen defines a crisis in fevers, a sudden and instantaneous change, either for the better or the worse, productive of recovery or death.
- CRISTÆ**, in surgery, a term for certain excrescences about the anus and pudenda. See Vol. I. p. 157.
- CRISTA GALLI**, in anatomy. See Vol. I. p. 157.
- CRISTA GALLI**, or **COCK'S COMB**. See **RHINANTHUS**.
- CRISTA PAVONIS**, in botany. See **POINCIANA**.
- CRITERIUM**,

**CRITERIUM**, a standard by which propositions and opinions are compared, in order to discover their truth or falsehood.

**CRITHE**, in surgery, commonly called the sty, is a tubercle that grows in different parts of the eye lids.

**CRITHMUM**, in botany, a genus of the pentandria digynia class. The fruit is oval and compressed. There are two species, one of which, viz. the maritimum, or sampire, is a native of Britain; the leaves are said to be stomachic, aperient, and diuretic.

**CRITICAL days and symptoms**, among physicians, are certain days and symptoms in the course of acute diseases, which indicate the patient's state, and determine him either to recover or grow worse. See **MEDICINE**.

**CRITICISM**, the art of judging with propriety concerning any object or combination of objects. But, in a more limited sense, the science of criticism is confined to the fine arts. The principles of the fine arts are best unfolded by studying the sensitive part of our nature, and by learning what objects are naturally agreeable, and what are naturally disagreeable. The man who aspires to be a critic in these arts, must pierce still deeper: he must clearly perceive what objects are lofty, what low, what are proper or improper, what are manly, and what are mean or trivial. Hence a foundation for judging of taste, and for reasoning upon it: where it is conformable to principles, we can pronounce with certainty, that it is correct; otherwise, that it is incorrect, and perhaps whimsical. Thus the fine arts, like morals, become a rational science; and, like morals, may be cultivated to a high degree of refinement.

Manifold are the advantages of criticism, when thus studied as a rational science. In the first place, a thorough acquaintance with the principles of the fine arts, redoubles the entertainment these arts afford. To the man who resigns himself entirely to sentiment or feeling, without interposing any sort of judgment, poetry, music, painting, are mere pastime; in the prime of life, indeed, they are delightful, being supported by the force of novelty, and the heat of imagination; but they lose their relish gradually with their novelty; and are generally neglected in the maturity of life, which disposes to more serious and more important occupations. To those who deal in criticism as a regular science, governed by just principles, and giving scope to judgment as well as to fancy, the fine arts are a favourite entertainment; and in old age maintain that relish which they produce in the morning of life.

In the next place, a philosophical inquiry into the principles of the fine arts, inures the reflecting mind to the most enticing sort of logic: the practice of reasoning upon subjects so agreeable tends to a habit; and a habit strengthening the reasoning faculties, prepares the mind for entering into subjects more difficult and abstract. To have, in this respect, a just conception of the importance of criticism, we need but reflect upon the common method of education; which, after some years spent in acquiring languages, hurries

us, without the least preparatory discipline, into the most profound philosophy: a more effectual method to alienate the tender mind from abstract science, is beyond the reach of invention; and accordingly, with respect to such speculations, the bulk of our youth contract a sort of hobgoblin terror, which is seldom, if ever subdued. Those who apply to the arts, are trained in a very different manner: they are led, step by step, from the easier parts of the operation, to what are more difficult; and are not permitted to make a new motion, till they be perfected in those which regularly precede it. The science of criticism appears then to be a middle link, connecting the different parts of education into a regular chain. This science furnisheth an inviting opportunity to exercise the judgment: we delight to reason upon subjects that are equally pleasant and familiar; we proceed gradually from the simpler to the more involved cases; and in a due course of discipline, custom, which improves all our faculties, bestows acuteness upon those of reason, sufficient to unravel all the intricacies of philosophy.

Nor ought it to be overlooked, that the reasonings employed upon the fine arts are of the same kind with those which regulate our conduct. Mathematical and metaphysical reasonings have no tendency to improve social intercourse; nor are they applicable to the common affairs of life: but a just taste in the fine arts, derived from rational principles, furnishes elegant subjects for conversation, and prepares us finely for acting in the social state with dignity and propriety.

The science of rational criticism tends to improve the heart not less than the understanding. It tends, in the first place, to moderate the selfish affections: by sweetening and harmonizing the temper, it is a strong antidote to the turbulence of passion and violence of pursuit: it procures to a man so much mental enjoyment, that in order to be occupied, he is not tempted in youth to precipitate into hunting, gaming, drinking; nor in middle-age, to deliver himself over to ambition; nor in old-age, to avarice. Pride and envy, two disgustful passions, find in the constitution no enemy more formidable than a delicate and discerning taste: the man upon whom nature and culture have bestowed this blessing, feels great delight in the virtuous dispositions and actions of others: he loves to cherish them, and to publish them to the world: faults and failings, it is true, are to him not less obvious; but these he avoids, or removes out of sight, because they give him pain. On the other hand, a man void of taste, upon whom the most striking beauties make but a faint impression, has no joy but in gratifying his pride or envy by the discovery of errors and blemishes. In a word, there may be other passions, which, for a season, disturb the peace of society more than those mentioned; but no other passion is so unwearied an antagonist to the sweets of social intercourse: those passions, tending assiduously to their gratification, put a man perpetually in opposition to others; and dispose him more to relish bad than good qualities, even in a companion. How different that disposition of mind, where every

virtue



virtue in a companion or neighbour, is, by refinement of taste, set in its strongest light; and defects or blemishes, natural to all, are suppressed, or kept out of view!

In the next place, delicacy of taste tends not less to invigorate the social affections, than to moderate those that are selfish. To be convinced of this tendency, we need only reflect, that delicacy of taste necessarily heightens our sensibility of pain and pleasure, and of course our sympathy, which is the capital branch of every social passion. Sympathy in particular invites a communication of joys and sorrows, hopes and fears: such exercise, soothing and satisfactory in itself, is necessarily productive of mutual good-will and affection.

One other advantage of rational criticism is referred to the last place, being of all the most important; which is, that it is a great support to morality. No occupation attaches a man more to his duty than that of cultivating a taste in the fine arts: a just relish of what is beautiful, proper, elegant, and ornamental, in writing or painting, in architecture or gardening, is a fine preparation for the same just relish of these qualities in character and behaviour. To the man who has acquired a taste so acute and accomplished, every action wrong or improper, must be highly disgustful: if, in any instance, the overbearing power of passion sway him from his duty, he returns to it upon the first reflection, with redoubled resolution never to be swayed a second time: he has now an additional motive to virtue, a conviction derived from experience, that happiness depends on regularity and order, and that a disregard to justice or propriety never fails to be punished with shame and remorse.

For the rules of criticism, applicable to the fine arts, and derived from human nature, see ARCHITECTURE, BEAUTY, CONGRUITY, COMPARISON, GRANDEUR, &c.

**CROATIA**, a frontier province of Germany, bounded by Sclavonia on the north and east, by Bosnia on the south, and by Carniola on the west. It is subject to the house of Austria.

**CROCCEUS**, or **HOAMEO**, a large river of China, which, after a course of two thousand miles, falls into the bay of Nankin: it is sometimes called the Yellow river, on account of the slime of this colour with which its waters are tinged.

**CROCINUM**, among physicians, denotes the oil of saffron, said to be of a heating quality, and to procure sleep.

**CROCODES**, an appellation given to pastils or troches, whereof crocus, or saffron, is the principal ingredient.

**CROCODILE**, in zoology. See **LACERTA**.

**CROCUS**, or **SAFFRON**, in botany, a genus of the triandria monogynia class. The corolla is divided into six equal parts; and it has three erect stigmata. There is but one species, a native of Britain. The anthers, or cloves, picked off and pressed together into cakes, goes by the name of saffron, which is an elegant and

useful aromatic, and is deservedly accounted one of the highest cordials.

**CROCUS**, in chemistry, denotes any metal calcined to a red or deep yellow colour. See **CHEMISTRY**.

**CROCUS METALLORUM**, an emetic preparation of antimony and nitre. See **CHEMISTRY**.

**CROFT**, a little close adjoining to a dwelling-house, and enclosed for pasture or arable land, or any other particular use.

**CROISADE**, **CRUSADE**, or **CRUZADO**, a name given to the expeditions of the Christians against the infidels, for the conquest of Palestine; so called, because those who engaged in the undertaking wore a cross on their cloaths, and bore one on their standard.

This expedition was also called the holy war, to which people flocked in great numbers out of pure devotion, the pope's bulls and the preaching of the priests of those days making it a point of conscience. The several nations engaged in the holy war were distinguished by the different colours of their crosses: the English wore white, the French red, the Flemish green, the Germans black, and the Italians yellow. From this enterprise several orders of knighthood took their rise. They reckon eight croisades for the conquest of the holy land; the first begun in the year 1095, at the solicitation of the Greek emperor and the patriarch of Jerusalem.

**CROISES**, or **CROIZES**, in English antiquity, pilgrims bound for the holy land, or such as had been there; so called from a badge they wore in imitation of a cross. The knights of St John of Jerusalem, created for the defence and protection of pilgrims, were particularly called croisets.

**CROISIERS**, a religious order founded in honour of the invention or discovery of the cross by the empress Helena.

They are dispersed in several parts of Europe, particularly in the Low Countries, France, and Bohemia, those in Italy being at present suppressed. These religious follow the rule of St Augustine. They had in England the name of crouched friars.

**CROMARTY**, the capital of the shire of Cromarty, in Scotland, with an excellent and safe harbour capable of containing the greatest fleets: W. long. 5° 40', and N. lat. 57° 54'.

**CRONENBURG**, a fortress of Denmark, situated in the island of Zealand, at the entrance of the Sound, where the Danes take toll of ships bound for the Baltic: E. long. 12° 5', and N. lat. 56°.

**CRONSLOT**, or **CROWN-CASTLE**, a castle and harbour in a little island of the same name, at the mouth of the river Neva, and entrance of the gulf of Finland, in Russia, about twelve miles west of Peterburgh: E. long. 30°, and N. lat. 60°. Here is a station for the Russian men of war, and a yard for building and refitting them.

**CRONSTAT**, a town of Transylvania, situated near the frontiers of Moldavia, about fifty miles north-east of Hermanstat, and subject to the house of Austria: E. long. 25°, and N. lat. 47'.

**CROPPER**,

**CROPPER**, in ornithology. See **COLUMBA**.

**CROSIER**, or **CROZIER**, a shepherd's crook; a symbol of pastoral authority, consisting of a gold or silver staff, crooked at the top, carried occasionally before bishops and abbots, and held in the hand when they give the solemn benedictions. The custom of bearing a pastoral staff before bishops is very ancient. Regular abbots are allowed to officiate with a mitre and crosier. Among the Greeks none but a patriarch had a right to the crosier.

**CROSIER**, in astronomy, four stars in the southern hemisphere, in the form of a cross, serving those who sail in south latitudes to find the antarctic pole.

**CROSLET**, in heraldry, is when a cross is crossed again at a small distance from each of the ends. Upton says it is not so often borne by itself in arms, as other crosses are, but often in diminutives, that is, in small crosslets scattered about the field. See Plate LXVI. fig. 7.

**CROSS**, in antiquity, a species of punishment, or rather the instrument wherewith it was inflicted, consisting of two pieces of wood crossing each other.

This punishment was only inflicted on malefactors and slaves, and thence called *servile supplicium*. The most usual method was to nail the criminal's hands and feet to this machine, in an erect posture; though there are instances of criminals so nailed with their head downward.

*Invention of the Cross*, a festival observed on May 3, by the Latin church, in memory of the empress Helena's (the mother of Constantine) finding the true cross of Christ on mount Calvary, where she caused erect a church for the preservation of it.

*Exaltation of the Cross*, a grand festival solemnized on September 14, in commemoration of Heraclius's restoring to mount Calvary the true cross, that had been carried off by Cosroes king of Persia, upon taking the city of Jerusalem.

*Order of the Cross*, an order of ladies instituted in 1668, by the empress Eleanora de Gonzagua, wife of the emperor Leopold, on occasion of the miraculous recovery of a little golden cross, wherein were inclosed two pieces of the true cross, out of the ashes of a part of the palace that had been burnt down: though the fire burnt the case wherein it was inclosed, and melted the crystal, it appears that the wood had not received the least damage.

**CROSS**, in heraldry, an ordinary composed of fourfold lines, whereof two are perpendicular, and the other two transverse; for so we must conceive of them, though they are not drawn throughout, but meet, by couples, in four right angles, near about the fesse-point of the escutcheon. The content of a cross is not always the same; for when it is not charged, it has only the fifth part of the field; but if it be charged, then it must contain the third part thereof.

This bearing was bestowed on such as had performed, or at least undertaken some service for Christ and the Christian profession; and is therefore held by several authors the most honourable charge in all heraldry. What brought it into such frequent use was

the ancient expeditions into the holy land, the cross being the ensigns of that war.

In these wars, the Scots carried St Andrew's cross; the French, a cross argent; the English, a cross or; the Germans, sable; the Italians, azure; the Spaniards, gules.

**CROSS-BAR-SHOT**, a bullet with an iron-bar passing through it, and standing six or eight inches out at both sides: it is used at sea, for destroying the enemy's rigging.

**CROSS-BILL**, in ornithology. See **LOXIA**.

**CROSS-WORT**, in botany. See **VALANTIA**.

**CROSSELET**, a little or diminutive cross, used in heraldry, where the shield is frequently seen covered with crosslets; also fesses and other honourable ordinaries, charged or accompanied with crosslets. Crosses frequently terminate in crosslets. See Plate LXVI. fig. 7.

**CROTALARIA**, in botany, a genus of the diadelphia decandria class. The pod is swollen, inflated, and pedicellated. There are eleven species, none of them natives of Britain.

**CROTALOPHORUS**, in zoology. See **CROTALUS**.

**CROTALUS**, or **RATTLE-SNAKE**, in zoology, a genus belonging to the order of amphibia serpentes, the characters of which are these: The belly is furnished with scuta, and the tail has both scuta and scales; but the principal characteristic of this genus, is the rattle at the end of the tail. The rattles consist of several articulated crustaceous, or rather horny bags, which make a considerable rattling noise when the creature moves, and serves to warn people of their approach. There are five species, and the bite of every one of them is so highly poisonous, that it generally kills in a short time. 1. The horridus, or American rattle-snake, has 167 scuta, and 23 scutellæ. It is generally of an orange, tawny, or blackish colour on the back, and the belly is ash coloured: they are from four to six inches in length; some are as thick as a man's leg: Dr Tyfon dissected one which was four feet five inches long, and the body six and a half inches in diameter. They devour birds, squirrels, hares, &c. 2. The miliaris has 13 scuta, and 31 scutellæ. It is ash-coloured, interspersed with black spots, and is a native of Carolina. 3. The dryinas has 165 scuta, and 30 scutellæ. It is whitish, with a few yellow spots, and is a native of America. 4. The durissus has 172 scuta, and 21 scutellæ. It is variegated with white and yellow colours, and is likewise found in America. 5. The mutus has 217 scuta, and 34 scutellæ. It has a chain of rhomboidal black spots on the back, a black line behind the eyes, and is a native of Surinam.

**CROTCHET**, in music, one of the notes or characters of time, marked thus ♯, equal to half a minim, and double of a quaver.

**CROTCHETS** are also marks or characters, serving to inclose a word or sentence which is distinguished from the rest, being generally in this form [ ], or this ( ).

**CROTON**, in botany, a genus of plants of the monoe-cia polyandria class. The calix of the male is cylindrical,

drical, and has five teeth; the corolla has five petals; and the stamina are from 10 to 15. The calix of the female consists of many leaves; it has no corolla; but has three bifid styli; and the capsule has three cells, and contains one seed. There are 21 species, none of them natives of Britain.

**CROTOY**, a town of France, situated in the province of Picardy, at the mouth of the river Somme: E. long. 1° 20', and N. lat. 50° 15'.

**CROUP** of a horse. in the menage, the extremity of the reins above the hips.

**CROUPADE**, in the menage, a leap, in which the horse pulls up his hind legs, as if he drew them up to his belly.

**CROW**, or **CARRION-CROW**, in ornithology. See **CORVUS**.

*Key-son* **CROW**. See **CORVUS**.

**Crow**, in mechanics, a kind of iron lever, with a claw at one end, and a sharp point at the other; used for heaving or purchasing great weights.

**Crow's BILL**, among surgeons, a kind of forceps, for drawing bullets and other foreign bodies out of wounds.

**Crow-FLOWERS**, in botany. See **LYCHNIS**.

**Crow's FEET**, in the military art, machines of iron, having four points, each about three or four inches long, so made, that whatever way they fall, there is still a point up: they are thrown upon breaches, or in passes where the enemy's cavalry are to march, proving very troublesome by running into the horse's feet and laming them.

**Crow's FEET**, in a ship, small lines or ropes, sometimes eight or ten, reeved through the deadmen's eyes; and scarce of any other use than to make a shew of small rigging. They are usually placed at the bottom of the back-stays of the fore-top-mast, mizen-top-mast, and gallant-top-mast.

**Crow's FOOT**, in botany. See **RANUNCULUS**.

**CROWLAND**, a market-town of Lincolnshire: W. long. 10', and N. lat. 52° 40'.

**CROWN**, an ornament worn on the head by kings, sovereign princes, and noblemen, as a mark of their dignity.

In scripture there is frequent mention of crowns, and the use of them seems to have been very common among the Hebrews. The high priest wore a crown, which was a fillet of gold placed upon the forehead, and tied with a ribbon of hyacinth colour, or azure blue. It seems also as if private priests, and even common Israelites, wore also a sort of crown, since God commands Ezekiel not to take off his crown, nor assume the marks of one in mourning. This crown was no more than a ribbon or fillet, with which the Jews and several people in the east girt their heads. And indeed the first crowns were no more than a bandelet drawn round the head, and tied behind, as we still see it represented on medals round the heads of Jupiter, the Ptolemies, and kings of Syria. Afterwards they consisted of two bandelets: by degrees they took branches of trees of divers kinds; at length they added flowers, inasmuch that Claudius Saturni-

nus says, there was not any plant whereof crowns had not been made. The woods and groves were searched to find different crowns for the several deities; and they were used not only on the statues and images of the gods, by the priests in sacrificing, and by kings and emperors, but also on altars, temples, doors of houses, sacred vessels, victims, ships, &c.

The Roman emperors had four kinds of crowns, still seen on medals, viz. a crown of laurel, a radial or radiating crown, a crown adorned with pearls and precious stones, and the fourth a kind of bonnet or cap, something like the mortar.

The Romans had also various kinds of crowns, which they distributed as rewards of military achievements; as, 1. The oval crown, made of myrtle, and bestowed upon generals, who were entitled to the honours of the lesser triumph, called ovation. 2. The naval or rostral crown, composed of a circle of gold, with ornaments representing beaks of ships, and given to the captain who first grappled, or the soldier who first boarded, an enemy's ship. 3. The crown called in Latin *vallis*, or *castrensis*, a circle of gold raised with jewels or palifades; the reward of him who first forced the enemy's entrenchments. 4. The mural crown, a circle of cold indented and embattled; given to him who first mounted the wall of a besieged place, and there lodged a standard. 5. The civic crown, made of the branch of a green oak, and given him who had saved the life of a citizen. 6. The triumphal crown, consisting at first of wreaths of laurel, but afterwards made of gold; proper to such generals as had the honour of a triumph. 7. The crown called *obdionalis*, or *graminea*, made of grass growing on the place; the reward of a general who had delivered a Roman army from a siege. 8. The crown of laurel, given by the Greeks to their athletes; and by the Romans to those who had negotiated or confirmed a peace with an enemy: this was the least honourable of all. We meet also with the *corona aurea*, often bestowed on soldiers, without any other additional term; the radial crown, given to princes at their translation among the gods; athletic crowns, and crowns of laurel, destined to crown victims at the public games, poets, orators, &c. All these crowns were marks of nobility to the wearers; and upon competitions with rivals for rank and dignities, often determined the preference in their favour. See Plate LXVI. fig. 8. n<sup>o</sup>. 1. 2. 3. &c.

*The Imperial Crown* is a bonnet or tiara, with a semi-circle of gold, supporting a globe with a cross at top. See Plate LXVI. fig. 9. n<sup>o</sup>. 1.

*The British Crown* is adorned with four crosses, between which there are four fleurs de lis: it is covered with four diadems, which meet at a little globe supporting a cross. *Ibid.* n<sup>o</sup>. 2.

*The French Crown*, is a circle of eight fleurs de lis, encompassed with six diadems, bearing at top a double fleurs de lis, which is the crest of France. *Ibid.* n<sup>o</sup>. 3.

*The Spanish Crown* is adorned with large indented leaves, and covered with diadems terminating in a globe, surmounted with a cross. *Ibid.* n<sup>o</sup>. 4.

- The crowns of almost all other kings are adorned with large leaves, bordered with four, six, or eight diadems, with a globe and cross at top.
- The Papal Crown** is composed of a tiara, and a triple crown encompassing it, with two pendants like the bishop's mitres. These crowns represent the pretended triple capacity of the pope, as high priest, supreme judge, and sole legislator of Christians. *Ibid.* n<sup>o</sup>. 5.
- An electoral Crown**, or coronet, is a scarlet cap turned up with ermine, and closed with a semicircle of gold, all covered with pearls, with a globe at top, surmounted with a golden cross. *Ibid.* n<sup>o</sup>. 6.
- Crowns of British princes of the blood.** 1. The prince of Wales's crown consists alternately of crosses and fleurs de lis, with one arch, in the middle of which is a ball and cross, as in the royal diadem. 2. That of all the younger sons and brothers of the king, consists likewise of crosses and fleurs de lis alternately, but without any arch, or being surmounted with a globe and cross at top. 3. That of the other princes of the blood consists alternately of crosses and leaves, like those in the coronet of dukes, &c. *Ibid.* fig. 10. n<sup>o</sup>. 1. 2. 3.
- Crowns of noblemen** are, a duke's, composed of leaves of smilage, or parsley: that of a marquis, of flowers and pearls placed alternately: an earl's has no flowers about the circle, like the duke and marquis, but only points rising, and a pearl on every one of them: a viscount has neither flowers nor points raised above the circle, like the other superior degrees, but only pearls placed on the circle itself without any limited number: a baron's has only six pearls on the golden border, not raised, to distinguish him from the earl's; and the number of them limited, to shew he is inferior to the viscount. *Ibid.* fig. 11. n<sup>o</sup>. 1. 2. &c.
- Crown**, in commerce, a general name for coins both foreign and domestic, which are of, or very near, the value of five shillings sterling.
- Crown Office**, an office belonging to the king's Bench court, of which the king's coroner or attorney is commonly master. In this office, the attorney general and clerk of the crown severally exhibit informations for crimes and misdemeanors at common law, as in the case of batteries, conspiracies, libelling, &c. on which the offender is liable to pay a fine to the king.
- Crown-glass**, denotes the finest sort of window-glass. See **GLASS**.
- Crown-wheel of a watch**, the upper wheel next the balance, which by its motion drives the balance, and in royal pendulums is called the swing-wheel.
- Crown imperial**, in botany. See **Fritillaria**.
- Croydon**, a market-town in Surrey, about ten miles south of London.
- Crucial incision**, in surgery, an incision made in form of a cross.
- Crucianella**, in botany, a genus of the tetrandria monogynia class. The corolla consists of one turnnel-shaped petal, with a filiform tube; the calix has three leaves; and the seeds are two, situate between the calix and corolla. The species are five, none of them natives of Britain.
- CRUCIATA**, in botany. See **VALENTIA**.
- CRUCIBLE**, a chemical vessel made of earth, and so tempered and backed as to endure the greatest fire. They are used to melt metals, and to flux minerals, ores, &c.
- The figure of a crucible is commonly that of an obtuse conoid, with its base at the top, and obtuse apex at the bottom; whence this conical figure may be varied, till it comes to the hollow segment of a sphere.
- The crucibles most generally used are those of Hesse and Austria.
- CRUCIFIX**, a cross upon which the body of Christ is fastened in effigy, used by the Roman-catholics to excite in their minds a strong idea of our Saviour's passion.
- They esteem it an essential circumstance of the religious worship performed at the altar; and on Good Friday they perform the ceremony of adoring it, which is done in these words, *O. crux ave, spes unica; Hail, thou cross, our only hope.* The officiating priest uncovers the crucifix, elevates it with both his hands, and says, *Ecce lignum crucis: Behold the wood of the cross.* The people answer, *in quo salus mundi perdidit; on which the Saviour of the world suffered death.* Then the whole congregation bow with great reverence, and devoutly kiss the holy wood.
- CRUCIFIXION**, a capital punishment by nailing the criminal to a cross. See **Cross**.
- CRUCIFORM**, in general, something disposed cross-wise; but more especially used by botanists, for flowers consisting of four petals disposed in the form of a cross.
- CRUDE**, an epithet given to something that has not passed the fire, or had a proper degree of coction.
- CRUDITY**, among physicians, is applied to undigested substances in the stomach; to humours in the body which are unconcocted, and not prepared for expulsion; and to the excrements.
- CRUISE**, in the sea-language, signifies to sail back and fore within a certain space of the sea, as well to annoy the enemy, as to protect our own trading vessels.
- CRUMENTATA**, among zoologists, animals furnished with a pouch, or bag, wherein to receive their young in time of danger.
- CRUOR**, sometimes signifies the blood in general; sometimes only the venous blood; and sometimes extravasated, or coagulated blood.
- CRUPPER**, in the menage, the buttocks of a horse, the rump; also a thong of leather put under a horse's tail, and drawn up by thongs to the buckle behind the saddle, so as to keep him from casting the saddle forwards on his neck.
- CRURA CLITORIDIS**, in anatomy. See Vol. I. p. 276.
- CRURA MEDULLÆ OBLONGATÆ**. See Vol. I. p. 287.
- CRURÆUS**, or **CRUREUS MUSCULUS**, in anatomy. See Vol. I. p. 207.
- CRURAL**, in anatomy, an epithet given to the artery which conveys the blood to the crura, or legs, and to the

the vein by which this blood returns towards the heart. See ANATOMY, Part III. IV.

CRUS, in anatomy, all that part of the body contained between the buttocks and the toes. See ANATOMY, Part I.

CRUSCA, an Italian term signifying bran, is in use amongst us to denote that celebrated academy called *della crusca*, established at Florence, for purifying and perfecting the Tuscan language.

CRUSTA VILLOSA, in anatomy. See Vol. I. p. 258.

CRUSTA LACTEA, in medicine, the same with achor, being scabby eruptions with which the heads of children are often troubled. See MEDICINE.

CRUSTACEOUS, an appellation given to animals covered with shells made up of several pieces, in contradistinction to those consisting of a single piece.

CRUX, or St CROIX, one of the Caribbee-islands, situated about sixty miles south east of Porto-Rico, and subject to France: W. long.  $64^{\circ}$ , and N. lat.  $17^{\circ} 30'$ .

CRUSADO, in commerce, a Portuguese coin, struck under Alphonus V. about the year 1457, at the time when pope Calixtus sent thither the bull for a croisade against the infidels.

This coin has a cross on one side, and the arms of Portugal on the other.

CRYMÔDES, among physicians, a kind of fever attended with a shivering cold and inflammation of the internal parts of the body.

CRYPTOGAMIA, in botany. See the *Scheme*, p. 635. and Plate LIII. fig. 24. also p. 636.

CRYPTOGRAPHY, the art of writing in cipher, or with sympathetic ink. See CIPHER and INK.

CRYSTAL, the name of a very large class of fossils; hard, pellucid, and naturally colourless; of regularly angular figures, composed of simple, not filamentous plates; not flexible nor elastic, giving fire with steel; not fermenting in acid menstrua, and calcining in a strong fire.

The orders of pure crystal are three; the first is perfect columnar crystals, with double pyramids, composed of eighteen planes, in an hexangular column, terminated by an hexangular pyramid at each end: the second order is that of perfect crystals, with double pyramids, without a column, composed either of twelve or of sixteen planes, in two hexangular pyramids, joined closely, base to base, without the intervention of any column: the third order is that of imperfect crystals, with single pyramids, composed either of twelve or ten planes, in an hexangular or pentangular column, affixed irregularly, at one end, to some solid body, and terminated, at the other, by an hexangular or pentangular pyramid.

These are all the general forms into which crystal, when pure, is found concentered: but under these there are almost infinite varieties in the number of angles, and the length, thickness, and other accidents of the columns and pyramids.

When crystal is blended with metalline particles at the time of its formation, it assumes a variety of figures wholly different from these, constituting a fourth order, under the name of metalline crystals: when that

metal is lead, the crystal assumes the form of a cube; when it is tin, of a quadrilateral pyramid, with a broad base; when iron, the crystal is found concentered in rhomboidal crystals: these crystals are very common about mines; but the common spars, which are liable to be influenced in the same manner by the metals, and to appear in the very same form, are to be carefully distinguished from them. There is one very easy test for this purpose, which is, that all spars are subject to be dissolved by aqua fortis, and effervesce violently only on its touching it: but it has no such effects on crystal.

The pebble crystal is common enough in all parts of the world; but that which is formed of hexangular columns, affixed to a solid base at one end, and terminated by a hexangular column at the other, is infinitely more so: this is what we call sprig or rock crystal, and is the species described by most authors under the name of crystal of the shops, or that kept for medicinal use.

It is to be chosen the clearest, purest, and most transparent that can be had: it should be proved to be no spar, by means of aquafortis, or by drawing a point of it along a pane of glass, which it cuts in the manner of a diamond. It is found in vast abundance in many parts of England and Ireland; and in Germany it is yet more frequent. It is found about Bristol of amethystine tinge; in Silesia and Bohemia it is stained to the colour of the ruby, sapphire, emerald, and topaz, in which case jewellers make great advantage of it, selling it under the name of accidental sapphire, &c.

CRYSTAL is also used for a facitious body, cast in glass-houses, called crystal-glass; being, in fact, no more than glass carried, in the composition and manufacture, to a greater perfection than the common glass.

The best kind of glass-crystal is that called Venice crystal, made at Moran, near Venice. See GLASS.

CRYSTALS, in chemistry, salts or other matters shot, or congealed, in the manner of crystal. See CHEMISTRY.

CRYSTALLINE HUMOUR, in anatomy. See Vol. I. p. 289.

CRYSTALLIZATION, in chemistry. See CHEMISTRY.

CRYSTALLOMANCY, in antiquity, a kind of divination, performed by means of a mirror, wherein the figures of the things required are said to have been represented.

CUB, a bear's whelp. Among hunters, a fox and martern of the first year, are called cubs. See URSUS.

CUBA, an island of North America, situated in the Atlantic ocean, between  $74^{\circ}$  and  $87^{\circ}$  of W. long. and between  $20^{\circ}$  and  $23^{\circ}$  N. lat. being eight hundred miles and upwards in length from east to west, and generally about seventy miles broad. It lies about fifty miles west of Hispaniola, and seventy-five north of Jamaica.

CUBAGUA, an American island, situated between the island of Margareta and Terra Firma, and subject to Spain: W. long.  $64^{\circ}$ , and N. lat.  $10^{\circ} 15'$ .

CUBE,

- CUBE**, in geometry, a solid body, consisting of six equal square sides. See *GEOMETRY*.
- CUBEBS**, in the materia medica, a small dried fruit, resembling a grain of pepper, but often somewhat longer, brought into Europe from the island of Java. In aromatic warmth and pungency, they are far inferior to pepper.
- CUBIC**, or **CUBICAL EQUATION**, in algebra. See *ALGEBRA*.
- CUBIT**, in the mensuration of the ancients, a long measure, equal to the length of a man's arm, from the elbow to the tip of the fingers.  
Dr Arbuthnot makes the English cubit equal to 18 inches; the Roman cubit equal to 1 foot 5, 406 inches; and the cubit of the scripture equal to 1 foot, 9, 888 inches.
- CUCKOW**, in ornithology. See *CUCULUS*.
- CUCKOW-SPIT**, the same with froth-spit. See *FROTH-SPIT*.
- CUCKOW-SPIT-INSECT**. See *CICADA*.
- CUCUBALUS**, in botany, a genus of the decandria trigynia class. The calix is inflated; the corolla has five petals with unguis; and the capsule has three cells. There are 13 species, five of which are natives of Britain, *viz.* the bacciferus, or berry-bearing chickweed; the beken, or white corn campion; the viscosus, or Dover campion; the olites, or Spanish catchfly; and the acaulis, or moss campion.
- CUCULUS**, the Cuckow, in ornithology, a genus belonging to the order of picæ. The bill is somewhat cylindrical; the edges of the nostrils are a little prominent; the tongue is arrow-shaped, plain, and not divided, and the toes are of the climbing kind, *i. e.* two before and two behind. It is about the size of a pigeon. The cuckow is a migrating bird; it comes to Britain about the end of April, hatches its young, and disappears about St John's day. The cuckow neither builds a nest, nor sits upon its eggs; but takes possession of a nest built by small birds of the sparrow kind, in which it generally lays but one egg, which is hatched by the small bird along with its own eggs; during the time of hatching, the cuckow sits upon hedges or trees, and almost constantly sings. If the cuckow's egg be first hatched, she immediately throws out and destroys the eggs of the small bird; but if the small bird's eggs be first hatched, the cuckow allows the young to live till its own egg is hatched, and then destroys the young belonging to the small bird. The small bird feeds and brings up the young cuckow with as much care and attention as if it were its own, till it be able to procure its own food, when, some say, it ungratefully kills and eats its nurse. The cuckow feeds upon caterpillars and small birds; but is never transformed into a hawk, as is vulgarly supposed. It is a native of Europe. Linnæus enumerates no less than 22 species, which inhabit different parts of the globe, and are chiefly distinguished by the shape of the tail and variations in colour.
- CUCUMBER**, in botany. See *CUCUMIS*.
- CUCUMIS**, or **CUCUMBER**, in botany, a genus of the monoecia syngenesia class. The calix of the male has five teeth; the corolla is divided into five segments; and the filaments are three: The calix and corolla of the female are the same with those of the male; the pistillum is trifid; and the seeds of the apple are short and slender. There are 11 species, none of them natives of Britain.
- CUCURBIT**, in chemistry. See *CHEMISTRY*, Vol. II. p. 109.
- CUCURBITA**, the **GOURD**, in botany, a genus of the monoecia syngenesia class. The calix has five teeth; the corolla is divided into five segments; and the filaments are three: The calix and corolla of the female are the same with those of the male; the pistillum is quinquefid; and the seeds of the apple are turned at the edges. The species are five, none of them natives of Britain.
- CUD** sometimes means the inside of the throat in beasts, and sometimes the food that they keep there and chew over again: from whence, *to chew the cud*, signifies, to ponder, think, or ruminate upon a thing.
- CUDWEED**, in botany. See *GNAPHALIUM*.
- CUENCA**, a city and bishop's see of New Castile, in Spain, about eighty-five miles east of Madrid: W. long. 2° 40', and N. lat. 40° 12'.
- CUIRASSIÈ**, a piece of defensive armour, made of iron plate, well hammered, serving to cover the body, from the neck to the girdle, both before and behind. Whence,
- CUIRASSIERS**, cavalry armed with cuirasses, as most of the Germans are: the French have a regiment of cuirassiers; but we have had none in the British army since the revolution.
- CULDEES**, in church-history, a sort of monkish priests, formerly inhabiting Scotland and Ireland. Being remarkable for the religious exercises of preaching and praying, they were called, by way of eminence, *cultores Dei*; from whence is derived the word culdees. They made choice of one of their own fraternity to be their spiritual head, who was afterwards called the Scots bishop.
- CULEUS**, in Roman antiquity, the largest measure of capacity for things liquid, containing twenty amphoræ, or forty urnæ. It contained one hundred forty-three gallons, three pints, English wine-measure; and was 11.095 solid inches.
- CULEX**, in zoology, a genus of insects belonging to the order of diptera: The mouth is armed with setaceous prickles inclosed in a flexile sheath. There are seven species, principally distinguished by their colour.
- CULIACAN**, the capital of a province of the same name in Mexico, opposite to the southern end of California: W. long. 113°, and N. lat. 24°.
- CULLIAGE**, a barbarous and immoral practice, whereby the lords of manors anciently assumed a right to the first night of their vassals brides.
- CULLEN**, a parliament town in Scotland, situated on the sea-coast of Banfshire: W. long. 2° 12', and N. lat. 57° 38'.
- CULM**, or **CULMUS**, among botanists. See Vol. I. p. 641.

**CULMINATION**, in astronomy, the passage of any heavenly body over the meridian, or its greatest altitude for that day.

**CULMORE**, a town of Ireland, in the county of Londonderry, and province of Ulster, about five miles north of Londonderry: W. long.  $7^{\circ} 40'$ , and N. lat.  $55^{\circ}$ .

**CULMUS**. See **CULM**.

**CULPRIT**, a formal reply of a proper officer in court, in behalf of the king, after a criminal has pleaded not guilty, affirming him to be guilty, without which the issue to be tried is not joined.

The term culprit is a contraction of the Latin *culpabilis*, and the French *prist*; importing that he is ready to prove the criminal guilty.

**CULROSS**, a parliament town of Scotland, situated on the river Forth, about twenty three miles north-west of Edinburgh: W. long.  $3^{\circ} 34'$ , and N. lat.  $56^{\circ} 8'$ .

**CULVERIN**, in the military art, a large cannon, or piece of artillery; for the kinds, weight, and proportions of which, see **CANNON**.

**CULVERTAILED**, among ship-wrights, signifies the fastening, or letting, of one timber into another, so that they cannot slip out, as the carlings into the beams of a ship.

**CUMBERLAND**, one of the most northerly counties of England, separated from Scotland by the frith and river of Solway. It gives the title of duke to his royal highness William duke of Cumberland, &c.

**CUMINOIDES**, in botany. See **LAGOECIA**.

**CUMINUM**, in botany, a genus of the pentandria digynia class. The fruit is oval and striated; it has four umbellulæ, and the involucre consists of four segments. There is but one species, a native of Egypt. The seeds are carminative and stomachic.

**CUNEIFORM**, in general, an appellation given to whatever resembles a wedge.

**CUNEIFORM BONE**, in anatomy. See Vol. I. p. 180.

**CUNEUS**, the wedge, in mechanics. See **MECHANICS**.

**CUNICULUS**, in zoology. See **LEPUS**.

**CUNILA**, in botany, a genus of the diandria monogynia class; of which there are three species, none of them natives of Britain.

**CUNNINGHAM**, one of the four bailiwicks of Scotland, and one of the three into which the shire of Aire is subdivided. It lies north-east of Kyle. Its chief town is Irwin.

**CUP**, among botanists, the same with calyx. See **CALYX**.

**CUPANIA**, in botany, a genus of the pentandria monogynia class. The calix consists of three leaves; the stylus is trifid; the capsule has three valves; and the seeds are six. There is but one species, a native of America.

**CUPOLA**, in architecture, a spherical vault; or the round top of the dome of a church, in form of a cup inverted.

**CUPPEL**, or **COPEL**, in chemistry. See **COPEL**.

**CUPPING**, in surgery, the operation of applying cup-

ping-glasses for the discharge of blood, and other humours, by the skin. See **SURGERY**.

**CUPRESSUS**, the **CYPRESS-TREE**, a genus of the monoecia monodelphia class. The calix of the male is a scale of the amentum; it has no corolla; and the antheræ have no filaments: The calix of the female is a strobilus, and the squama contains a single flower; it has no corolla; the stylus is a concave point; and the nut is angular. The species are four, none of them natives of Britain.

**CUPRUM**, or **COPPER**. See **CHEMISTRY**, Vol II. p. 80.

**CURASSOW**, or **CURACAO**, one of the lesser Antilla-islands, subject to the Dutch, and situated in  $68^{\circ} 35'$  W. long. and  $12^{\circ} 30'$  N. lat.

**CURATE**, properly signifies the parson or vicar of a parish, who has the charge or cure of the parishoners souls. See **CURE**.

**CURATE**, also signifies a person substituted by the incumbent, to serve his cure in his stead.

**CURATOR**, among civilians, a person regularly appointed to manage the affairs of minors, or persons mad, deaf, dumb, &c. See **LAW**.

**CURB**, in the menage, a chain of iron, made fast to the upper part of the branches of the bridle, in a hole called the eye, and running over the horse's beard. It consists of these three parts; the hook, fixed to the eye of the branch; the chain of SS's, or links; and the two rings, or mailes. Large curbs, provided they be round, are always most gentle: but care is to be taken, that it rest in its proper place, a little above the beard, otherwise the bit-mouth will not have the effect that may be expected from it.

English watering bits have no curbs; the Turkish bits, called genettes, have a ring that serves instead of a curb. See **GENETTES**.

**CURCULIO**, in zoology, a genus of insects belonging to the order of coleoptera. The feelers are subclavated, and rest upon the snout, which is prominent and horny. There are no less than ninety-five species, principally distinguished by their colour.

**CURCUMA**, or **TURMERIC**, in botany, a genus of the monandria monogynia class. It has four barren stamina, and only the fifth is fertile. There are two species, both natives of India. See Vol. I. p. 633.

**CURDISTAN**, a province of Persia, having Turcomania, or Armenia, on the north, and Eyraca-Arabia, or Chaldea, on the south.

**CURDLING**, the coagulating any fluid body, especially milk.

It is said, that at Florence they curdle their milk for the making of cheese with artichoke-flowers, instead of the rennet used among us for that purpose.

**CURFEW**, or **COURFEW**, a signal given in cities taken in war, &c. to the inhabitants to go to bed. Pasquin says, it was so called, as being intended to advertise the people to secure themselves from the robberies and debaucheries of the night.

The most eminent curfew in England was that established by William the Conqueror, who appointed,

- under severe penalties, that, at the ringing of a bell at eight o'clock in the evening, every one should put out their lights and fires, and go to bed: whence, to this day, a bell rung about that time is called a curfew-bell.
- CURIA**, in Roman antiquity, a certain division, or portion of a tribe. Romulus divided the people into thirty curiæ, or wards, whercof there were ten in every tribe, that each might keep the ceremonies of their feasts and sacrifices in the temple, or holy place, appointed for every curia. The priest of the curia was called curio.
- CURIA**, in the English law, generally signifies a court; and has been taken for the customary tenants, who do their suit and service at the court of the lord. See **COURT**.
- CURING**, a term used for the preserving fish, flesh, and other animal substances, by means of certain additions of things, to prevent putrefaction. One great method of doing this, is by smoking the bodies with the smoke of wood, or rubbing them with salt, nitre, &c.
- CURLEW**, in ornithology. See **SCOLOPAX**.
- CURNOCK**, a measure of corn, containing four bushels, or half a quarter.
- CURRANS**, or **CURRANTS**, the fruit of a species of grossularia. See **GROSSULARIA**.
- The white and red sort are mostly used; for the black, and chiefly the leaves, upon first coming out, are in use to flavour English spirits, and counterfeit French brandy. Currants greatly assuage drought, cool and fortify the stomach, and help digestion.
- CURRANTS** also signify a smaller kind of grapes brought principally from Zant and Cephalonia. They are gathered off the bushes, and laid to dry in the sun, and so put up in large butts. They are opening and pectoral, but are more used in the kitchen, than in medicine.
- Currants, the hundred weight pay on exportation 1 l. 2 s. 1  $\frac{1}{2}$  d. and draw back on exportation 1 l. os. 7  $\frac{1}{2}$  d. If imported in Venetian ships, they pay the 112 lb. 1 l. 3 s. 7  $\frac{1}{2}$  d. and draw back 1 l. 1 s. 8  $\frac{1}{2}$  d. In other foreign bottoms they pay 1 l. 7 s. 4  $\frac{1}{2}$  d. and draw back 1 l. 5 s. 6  $\frac{1}{2}$  d.
- CURRENT**, in hydrography, a stream or flux of water in any direction. In the sea, they are either natural, occasioned by the diurnal motion of the earth round its axis, or accidental, caused by the waters being driven against promontories, or into gulfs and streights, where, wanting room to spread, they are driven back, and thus disturb the ordinary flux of the sea. Dr Halley makes it highly probable that in the Downs, there are under-currents, by which as much water is carried out as is brought in by the upper-currents.
- CURRENTS**, in navigation, are certain settings of the stream, by which ships are compelled to alter their course or velocity, or both, and submit to the motion impressed upon them by the current. See **NAVIGATION**.
- CURRIERS**, those who dress and colour leather after it comes from the tan yard. See **TANNING**.
- CURRUCU**, in ornithology. See **MOTACILLA**.
- CURRYING**, the method of preparing leather with oil, tallow, &c. See **TANNING**.
- CURTATE distance**, in astronomy, the distance of a planet from the sun to that point where a perpendicular let fall from the planet meets with the ecliptic.
- CURTATION**, in astronomy, is the interval between a planet's distance from the sun, and the curtate distance.
- CURTIN**, **CURTAIN**, or **COURTIN**, in fortification, is that part of the rampart of a place which is betwixt the flanks of two bastions, bordered with a parapet five feet high, behind which the soldiers stand to fire upon the covered way and into the moat.
- CURVATOR coccygis**, in anatomy. See Vol. I. p. 220.
- CURVATURE of a line**, is the peculiar manner of its bending or flexure by which it becomes a curve of such and such peculiar properties.
- CURVE**, in geometry, a line which running on continually in all directions, may be cut by one right line in more points than one. See **CONIC SECTIONS**, and **FLUCTIONS**.
- CURVET**, or **CORVET**, in the menage, an air in which the horse's legs are raised higher than in the demi-volt; being a kind of leap up, and a little forwards, wherein the horse raises both his fore-legs at once, equally advanced, (when he is going straight forward, and not in a circle), and as his fore-legs are falling, he immediately raises his hind-legs, equally advanced, and not one before the other: so that all his four legs are in the air at once; and as he sets them down, he marks but twice with them.
- CURVILINEAR**, or **CURVILINEAL**, is said of figures bounded by curves, or crooked lines.
- CURVIROSTRA**, in ornithology. See **LOXIA**.
- CURULE chair**, in Roman antiquity, a chair adorned with ivory, wherein the great magistrates of Rome had a right to sit and be carried.
- The curule magistrates were the ædiles, the prætors, censors, and consuls. This chair was fitted in a kind of chariot, whence it had its name. The senators who had borne the offices of ædiles, prætors, &c. were carried to the senate-house in this chair, as were also those who triumphed, and such as went to administer justice, &c. See **ÆDILES**, &c.
- CURZOLA**, an island in the gulf of Venice, upon the coast of Dalmatia, about twelve miles from the island of Lessina.
- CUSCO**, the capital city of Peru, during the reigns of the Incas: it is still a fine city, and the see of a bishop, and stands about 350 miles east of Lima, in 70° W. long. and 13° S. lat.
- CUSCUTA**, or **DODDER**, a genus of the tetrandria digynia class. The calix consists of four segments; the corolla has but one petal; and the capsule is bilocular. There are two species, one of which is a native of Britain, viz. the Europæa, dodder, hell-weed, or devil's guts.
- CUSPIDATED**, in botany, are such plants whose leaves are pointed like a spear.

CUSTOM,



**CUSTOM**, a very comprehensive term, denoting the manners, ceremonies and fashions of a people, which having turned into a habit, and passed into use, obtains the force of laws; in which sense it implies such usages, as, though voluntary at first, are yet, by practice, become necessary.

Custom is hence, both by lawyers and civilians, defined *lex non scripta*, a law, or right, not written, established by long usage, and the consent of our ancestors: in which sense it stands opposed to the *lex scripta*, or the written law.

**CUSTOMS**, in commerce, the tribute or toll, paid by merchants to the king, for goods exported or imported: they are otherwise called duties. See **DUTY**.

**CUSTOM HOUSE**, an office established by the king's authority in the maritime cities, or port-towns, for the receipt and management of the customs and duties of importation and exportation, imposed on merchandises, and regulated by books of rates.

**CUSTOS brevium**, the principal clerk belonging to the court of common pleas, whose business it is to receive and keep all the writs made returnable in that court, filing every return by itself; and, at the end of each term, to receive of the prothonotaries all the records of the nisi prius, called the postas.

**CUSTOS rotulorum**, an officer who has the custody of the rolls and records of the sessions of peace, and also of the commission of the peace itself.

He usually is some person of quality, and always a justice of the peace, of the quorum, in the county where he is appointed.

**CUSTOS spiritualium**, he that exercises the spiritual jurisdiction of a diocese, during the vacancy of any see, which, by the canon law, belongs to the dean and chapter; but at present, in England, to the archbishop of the province, by prescription.

**CUSTOS temporalium** was the person to whom a vacant see or abbey was given by the king, as supreme lord. His office was, as steward of the goods and profits, to give an account to the escheator, who did the like to the exchequer.

**CUTAMBULI**, certain worms, either under the skin, or upon it, which, by their creeping, cause an uneasy sensation. It is also applied to wandering scorbutic pains.

**CUT-A-FEATHER**, in the sea language. If a ship has too broad a bow, it is common to say, *she will not cut a feather*; that is, she will not pass through the water so swift, as to make it foam or froth.

**CUTANEOUS**, in general, an appellation given to whatever belongs to the cutis or skin.

**CUTICLE**, in anatomy. See Vol. I. p. 285.

**CUTICULAR**, the same with cutaneous.

**CUTIS**, the SKIN, in anatomy. See Vol. I. p. 254.

**CUTTER of the tallies**, an officer of the exchequer, whose business is to provide wood for the tallies, to cut or notch the sum paid upon them; and then to cast them into court, to be written upon. See **TALLY**.

**CUTTLE-FISH**. See **SEPIA**.

**CUZT**, the most eastern province of the kingdom of Fez, in Africa.

**CYANUS**, in botany. See **CENTAURIA**.

**CYATHUS**, in Roman antiquity, a liquid measure, containing four ligulas, or half a pint English wine-measure, being  $469\frac{2}{3}$  solid inches.

**CYCLAMEN**, or **SOW-BREAD**, in botany, a genus of the pentandria monogynia class. The corolla is rotated and reflected; the tube is very short, with a prominent faux; and the berry is covered with a capsule. There are two species, none of them natives of Britain. The root is a powerful aperient and abstergent.

**CYCLE**. See Vol. I. p. 491.

**CYCLE of the moon**. See Vol. I. p. 491.

**CYCLE of the Roman indiction**. See Vol. I. p. 491.

**CYCLISCUS**, in surgery, an instrument in the form of a half moon, used in scraping the skull, in case of fractures of that part.

**CYCLOID**, a curve on which the doctrine of pendulums and time-measuring instruments in a great measure depend; Mr Huygens demonstrated, that from whatever point or height a heavy body, oscillating on a fixed centre, begins to descend, while it continues to move in a cycloid, the time of its falls or oscillations will be equal to each other. It is likewise demonstrable, that it is the curve of quickest descent, *i. e.* a body falling in it, from any given point above, to another not exactly under it, will come to this point in a less time than in any other curve passing through those two points.

**CYCLOMETRY**, a term sometimes used for the mensuration of circles.

**CYCLOPÆDIA**, or **ENCYCLOPÆDIA**, denotes the circle or compass of arts and sciences. A cyclopædia, say the authors of the French Encyclopædia, ought to explain, as much as possible, the order and connection of human knowledge. See **DICTIONARY**.

**CYCLOPTERUS**, the **LUMP-FISH**, in ichthyology, a genus belonging to the order of amphibia nantes. The head is obtuse, and furnished with saw-teeth; there are four rays in the gills; and the belly-fins are connected together in an orbicular form. There are three species.

**CYDER**, an excellent drink made of the juice of apples. It conduces greatly to the goodness of the cyder, to let the apples lie a week or two in heaps, before they are pressed. After straining the liquor through a sieve, let it stand a day or two in an open tun, covered only with a cloth, or boards to keep out the dust, that the more gross parts may subside. Then draw it off in pails into vessels, wherein it is intended to be kept, observing to leave an eighth part of them empty. Set these vessels in your coldest cellars, with the bung open, or covered only with a loose cover, both that the volatile steams may have free vent, and that the must may be kept cool, otherwise it is apt to ferment too much. Having fermented in this manner for fifteen or twenty days, the vessel may be stopped up close; and, in two or three months time, the cyder will be fit for drinking. But if you expect cyder in perfection, so as to flower in the glass, it must be giued as they call it, and drawn off into bottles, after it has been a short time in the cask: this is done by pouring into each ves-

181.

fel a pint of the infusion of sixty or seventy grains of the most transparent ising-glass, or fish-glass, in a little white-wine and river or rain water, stirred well together, after being strained through a linen cloth. When this viscous substance is put into the cask, it spreads itself over the surface like a net, and carries all the dregs to the bottom with it.

Ginger added to cyder, not only corrects its windiness, but makes it more brisk; and a few drops of currant-juice, besides tinging, adds a pleasant quickness to it. Honey, or sugar, mixed with some spices, and added to flat cyder, will very much revive it.

Some commend boiling of cyder-juice, which should be done as soon as it is pressed, scumming it continually, and observing to let it boil no longer than till it acquires the colour of small beer: when cold, put it into a cask, leaving a small vent; and when it begins to bubble up out of the vent, bottle it for use.

CYDONIA, in botany. See CRATEVA.

CYGNUS, in ornithology. See ANAS.

CYGNUS, in astronomy. See Vol. I. p. 486.

CYLINDER, in geometry, a solid body, supposed to be generated by the rotation of a parallelogram.

*Rolling, or loaded* CYLINDER. See MECHANICS.

CYLINDROID, in geometry, a solid body, approaching to the figure of a cylinder, but differing from it in some respect, as having the bases elliptical, but parallel and equal.

CYLINDRUS, in natural history. See VOLUTA.

CYMA, in botany, the tender stalks which herbs send forth in the beginning of the spring, particularly those of the cabbage-kind.

CYMATIUM, in architecture, a member or moulding, of the cornice, the profile of which is waved, that is, concave at top, and convex at bottom. See ARCHITECTURE.

CYMBAL, a musical instrument in use among the ancients. The cymbal was round, made of brass, like our kettle-drums, and, as some think, in their form, but smaller, and of different use.

CYMBALARIA, in botany. See ANTIRRHINUM.

CYMBARIA, in botany, a genus of the didynamia angiospermia class of plants. The calix is divided into many parts; and the capsule is unilocular. There is but one species.

CYNÆDUS, in ichthyology. See SPARUS.

CYNANCHE, among physicians, denotes an inflammation of the larynx.

CYNANCHUM, in botany, a genus of the pentandria digynia class. The nectarium is cylindrical, and has five teeth. There are five species, none of them natives of Britain.

CYNANTHROPIA, in medicine, the distemper occasioned by the bite of a mad dog. See MEDICINE.

CYNAPIUM, in botany. See ETHUSA.

CYNARA, the ARTICHOAK, in botany, a genus of the syngenesia polygamia æqualis class. The calix is dilated and imbricated, with fleshy scales sharp at the points. There are four species, none of them natives of Britain. The use of the artichoke as a food is well known.

CYNICS, a sect of ancient philosophers, who valued themselves upon their contempt of riches and state, arts and sciences, and every thing, in short, except virtue or morality.

The cynic philosophers owe their origin and institution to Antisthenes of Athens, a disciple of Socrates, who, being asked of what use his philosophy had been to him, replied, "It enables me to live with myself." Diogenes was the most famous of his disciples, in whose life the system of this philosophy appears in its greatest perfection: he led a most wretched life, a tub having served him for a lodging, which he rolled before him where ever he went; yet he was, nevertheless, not the more humble on account of his ragged cloak, bag, and tub; for, one day, entering Plato's house, at a time that there was a splendid entertainment there for several persons of distinction, he jumped up upon a very rich couch, in all his dirt, saying, "I trample on the pride of Plato." "Yes (replied Plato,) but with great pride, Diogenes." He had the utmost contempt for all the human race, for he walked the streets of Athens, at noon-day, with a lighted lantern in his hand, telling the people, "He was in search of a man." Amongst many excellent maxims of morality, he held some very pernicious opinions; for he used to say, that the uninterrupted good fortune of Harpalus, who generally passed for a thief and a robber, was a testimony against the gods. He regarded chastity and modesty as weaknesses; hence Laertius observes of him, that he did every thing openly, whether it belonged to Ceres or Venus, though he adds that Diogenes only ran to an excess of impudence to put others out of conceit with it: but impudence was the characteristic of these philosophers, who argued, that what was right to be done, might be done at all times, and in all places. The chief principle of this sect, in common with the stoics, was, that we should follow nature; but they differed from the stoics in their explanation of that maxim, the cynics being of opinion that a man followed nature, that gratified his natural motions and appetites; while the stoics understood right reason, by the word nature.

CYNIC SPASM, a kind of convulsion, wherein the patient imitates the howlings of dogs.

CYNIPS, in zoology, a genus of insects belonging to the order of hymenoptera. The mouth consists of two jaws, without any proboscis; and the sting in the tail is spiral, and generally hid. There are nineteen species, distinguished by their colour, and the plants they inhabit.

CYNOCEPHALUS, in zoology, the trivial name of a species of simia. See SIMIA.

CYNOGLOSSUM, in botany, a genus of the pentandria monogynia class. The corolla is tunnel-shaped; the seeds are depressed, and the stylus is fixed to the interior side of them. There are eight species, only one of which is a native of Britain, viz. the officinale, or hound's-tongue; the root is said to be pectoral and narcotic.

CYNOMETRA, in botany, a genus of the decandria monogynia class. The calix consists of four segments, the

the opposite ones being broader ; and the legumen is fleshy, lunated, and contains but one seed. There are two species, both natives of India.

**CYNOMORIUM**, in botany, a genus of the monoecia monandria class. The calix of the female is an imbricated amentum, and neither male nor female has a corolla ; the female has one stylus, and one round seed. There is but one species, a native of Jamaica.

**CYNOSURUS**, in botany, a genus of the triandria digynia class. The calix is a double valve, and includes many flowers. There are ten species, four of which are natives of Britain, viz. the cristatus, or crested dog-tail grass ; the echinatus, or rough dog-tail grass ; the cæruleus, or blue dog-tail grass ; and the paniceus, or bearded dog-tail grass.

**CYPERUS**, in botany, a genus of the triandria monogynia class. The gluma is paleaceous and imbricated ; it has no corolla, and but one naked seed. There are twenty species, only one of which is a native of Britain, viz. the longus, sweet cyperus, or English galangale ; the root is carminative and attenuant.

**CYPHOMA**, **CYPHOS**, or **CYPHOSIS**, an incurvation of the spine, forming a crookedness in the back.

**CYPRÆA**, in zoology, a genus of insects belonging to the order of vermes testacea. It is an animal of the limax or snail-kind ; the shell is one involuted, subovated, obtuse, smooth valve. The aperture on each side is linear, longitudinal, and teathed. There are forty-four species, distinguished by the form of their shells.

**CYPRESS**. See **CUPRESSUS**.

**CYPRINUS**, in ichthyology, a genus of fishes belonging to the order of abdominales. The mouth is toothless ; there are three rays in the gills ; the body is smooth, and white ; and the belly-fins have frequently nine rays. There are thirty-one species, principally distinguished by the number of rays in the vent-fin.

**CYPRIPEDIUM**, in botany, a genus of the gynandria diandria class. The nectarium is ventricose, inflated, and hollow. There are two species, one of them, viz. the calceolus, or ladies-slipper, a native of Britain.

**CYPRUS**, an island situated in the most easterly part of the Levant, or Mediterranean sea, between 33° and

36° E. long. and between 34° and 30° N. lat.

*Knights of CYPRUS*, an order instituted by Guy de Lusignan, titular king of Jerusalem, to whom Richard I. of England, after conquering this island, made over his right.

**CYRENAICS**, a sect of ancient philosophers, so called from their founder, Aristippus of Cyrene, a disciple of Socrates.

The great principle of their doctrine was, that the supreme good of man in this life is pleasure ; whereby they not only meant a privation of pain, and a tranquillity of mind, but an assemblage of all mental and sensual pleasures, particularly the last.

**CYST**, the bag, or tunic, including all incysted tumors, as the scirrhus, atheroma, steotoma, meliceris, &c.

**CYSTIC**, a name given to two arteries and two veins. See Vol. I. p. 245.

**CYSTIC DUCT**. See Vol. I. p. 265.

**CYTISUS**, in botany, a genus of the diadelphia decandria class. The calix is bilabiated ; and the legumen is attenuated at the base. There are eleven species, none of them natives of Britain.

**CZACKATHURN**, a town of Germany, in the dutchy of Stiria, and circle of Aultria, situated near the conflux of the rivers Muer and Save, about fifty miles south-east of Gratz : E. long. 17°, and N. lat. 46° 50'.

**CZAR**, a title of honour assumed by the great dukes, or, as they are now styled, emperors of Russia.

Beckman makes no doubt but they took this title, by corruption, from Cæsar, emperor ; and accordingly they bear an eagle, as the symbol of their empire, and the word CÆSAR in their arms.

**CZASLAW**, a town of Bohemia, about thirty-five miles south-east of Prague : E. long. 15° 8', and N. lat. 49° 50'.

**CZERNIGOF**, the capital of the province of Czernigof, in Russia, near the frontiers of Poland : E. long. 31°, 30', and N. lat. 52° 30'.

**CZONGRODT**, a town of Hungary, situated on the river Thieffe, about thirty miles north of Segedin : E. long. 20° 45', and N. lat. 46° 36'.



D

**DAB**, in ichthyology, the English name of a species of pleuronectes. See **PLEURONECTES**.

**DACA**, a city of the province of Bengal, in the East-Indies, situated on a branch of the river Ganges : E. long. 89° and N. lat. 23° 30'.

**DA CAPO**, in music, signifies from the head or beginning ; intimating, that the air is to be begun again, and ended with the first part.

**DACE**, the English name of a species of cyprinus. See **CYPRINUS**.

**DACOLITHUS**, in ichthyology. See **COBITIS**.

**DACTYL**, in poetry, a metrical foot consisting of a long and two short syllables, as *carmina, evident, excellence*.

The dactyl and spondee are the only feet or measures used in hexameter verses. See **HEXAMETER**.

**DACTYLIS**, in botany, a genus of the triandria digynia class of plants. The calix consists of two obtuse valves, the one being somewhat larger than the other. The species are two, viz. the cynosuroides,

- or smooth cock's-foot grafs; and the glomeratus, or rough cock's-foot grafs; both natives of Britain.
- DACTYLUS**, in zoology. See **PHOLAS**.
- DADUCHI**, in antiquity, priests of the goddesses Ceres, so called, because at the feasts and sacrifices of that goddess, they ran about the temple, carrying a lighted torch, which they delivered from hand to hand, till it had passed through them all. This they did in memory of Ceres's searching for her daughter Proserpine, by the light of a torch, which she kindled in mount *Ætna*.
- DÆMON**, a name given by the ancients to certain spirits, or genii, which appeared to men, either to do them service, or to hurt them. The Platonists distinguish between gods, dæmons, and heroes. The gods are those whom Cicero calls *Dii majorum gentium*. The dæmons are those whom we call angels. Christians, by the word dæmon, understand only evil spirits, or devils.
- DÆMONIAC**, a word applied to a person supposed to be possessed with an evil spirit, or dæmon. See **DÆMON**.
- DÆMONIACS**, in church-history, a branch of the anabaptists, whose distinguishing tenet is, that the devils shall be saved at the end of the world.
- DAGO**, or **DAGERWORT**, the capital of an island of the same name in the Baltic, near the coast of Livonia, subject to Russia: E. long. 21° 30', and N. lat. 58° 45'.
- DAHGESTAN**, a country of Asia, bounded by Circassia on the north, by the Caspian sea on the East, by Chirvein a province of Persia on the south, and by Georgia on the west. Its chief towns are Tarku and Derbent, both situated on the Caspian sea.
- DAHOME**, a kingdom of Africa, on the Guinea coast.
- DAISY**. See **BELLIS**.
- Great DAISY*. See **LEUCANTHEMUM**.
- Ox-eye DAISY*. See **BUPHTHALMUM**.
- DALEA**, in botany. See **PSORALEA**.
- DALEBURGH**, the capital of the province of Dalia, in Sweden, situated on the western side of the Wener-lake, fifty miles north-east of Gottenburg; E. long. 13°, and N. lat. 59°.
- DALECARLIA**, a province of Sweden, abounding with iron and copper mines.
- DALECHAMPIA**, in botany, a genus of the monœcia monodelphia class. It has no corolla either in the male or female; and the seeds are roundish and solitary. There is but one species, *viz.* the scandens, a native of America.
- DALKEITH**, a town of Scotland, in the county of Lothian, six miles south-east of Edinburgh: W. long. 2° 40', and N. lat. 55° 50'.
- DALIA**, a province of Sweden, bounded on the north by Dalecarlia, on the east by Wermeland and the Wener-lake, on the south by Gothland, and on the west by Nerway.
- DALMATIA**, a frontier province of Europe, mostly subject to the Turks, but some towns on the sea-coast to the Venetians: it is bounded by Bosnia on the north, by Servia on the east, by Albania on the south,
- and by Morlachia and the gulph of Venice on the west.
- DAMA**, in zoology. See **CERVUS**.
- DAMAGE**, in law, is generally understood of a hurt, or hindrance attending a person's estate.
- DAMALA**, a sea-port town of the Morea in Greece, at the entry of the gulph of Engæa.
- DAMAN**, a port-town of the hither India, in the province of Guzurat or Cambay, situated on the west coast, about eighty miles south of Surat, in 72° 20' E. long. and 20° N. lat. It is subject to the Portuguese.
- DAMASCUS**, or **SCHAM**, the capital city of the south part of Syria, situated ninety miles north-east of Jerusalem, in a pleasant, extensive, and fruitful plain; E. long. 37° 20', and N. lat. 33° 15'.
- DAMASK**, a silk-stuff, with a raised pattern, so as that the right side of the damask is that which hath the flowers raised or fattined.
- DAMASKEENING**, or **DAMASKING**, the art or operation of beautifying iron, steel, &c. by making incisions therein, and filling them up with gold and silver wire; chiefly used for adorning sword-blades, guards and gripes, locks of pistols, &c.
- DAMASONIUM**, in botany. See **ALISONA**.
- DAMBEA**, the capital of Abyssinia, or Ethiopia, situated at the head of a lake, to which it gives name: E. long. 34°, and N. lat. 15°.
- DAMELOPRE**, a kind of bilander, used in Holland for conveying merchandize from one canal to another; being very commodious for passing under the bridges.
- DAMIANISTS**, in church-history, a branch of the ancient acephali-severitæ. They agreed with the catholics in admitting the IVth council, but disowned any distinctions of persons in the Godhead; and professed one single nature, incapable of any difference; and yet they called God, the Father, Son, and Holy Ghost.
- DAMIETTA**, a port-town of Egypt, situated on the eastern mouth of the river Nile, four miles from the sea, and 100 miles north of Grand Cairo; E. long. 32°, and N. lat. 31°.
- DAMNATA TERRA**, among chemists, the same with *caput mortuum*. See **CAPUT**.
- DAMPS**, in natural history, noxious steams and exhalations, frequently found in mines, pits, wells, and other subterraneous places. See **PNEUMATICS**.
- DAMSEL**, from the French *damoisel*, or *damoiseau*, an appellation anciently given to all young people of either sex, that were of noble or genteel extraction, as the sons and daughters of princes, knights, and barons: thus we read of Damsel Pepin, Damsel Louisle Gros, Damsel Richard prince of Wales.
- From the sons of kings this appellation first passed to those of great lords and barons, and at length to those of gentlemen, who were not yet knights.
- At present, damsel is applied to all maids or girls, not yet married, provided they be not of the vulgar.
- DANAE**, in antiquity, a coin somewhat more than an obolus, used to be put into the mouths of the dead, to pay their passage over the river Acheron.

DANCE,

**DANCE**, an agreeable motion of the body, adjusted by art to the measures or tune of instruments, or of the voice.

Athenæus concludes, that in the early ages of antiquity, they accounted dancing an exercise becoming persons of honour and wisdom; and that, as such, it had been esteemed by the greatest men in all ages. Thus, Homer calls Merion a fine dancer; and says, that the graceful mein and great agility which he had acquired by that exercise, distinguished him above the rest in the armies of either Greeks or Trojans. Dancing was in very great esteem among the Greeks, even the Lacedæmonians encouraged it: but, at Rome, we find the custom was quite otherwise; for there, to use the words of Cicero, no man dances unless he is mad or drunk: Cicero reproaches Gabinus with having danced: and we read, that Domitian excluded several members from the senate for having danced.

Dancing in general, was by the ancients divided into cubillic, spherillic, and orchestric: the cubillic dance was performed with certain wrestlings and contortions of the body; the spherillic with a sort of ball, or bowl play; but the orchestric was most usual, and what indeed was dancing properly so called.

Dancing is usually an effect and indication of joy; though Mr Pallearat assures us, that there are nations in South America, who dance to shew their sorrow. It has been in use among all nations, civilized and barbarous; though held in esteem among some, and in contempt among others. It has often been, and still is, sometimes made an act of religion. Thus David danced before the ark to honour God, and expresses his excess of joy for its return into Sion. Among the pagans it made a part of the worship paid to the gods, it being usual to dance round the altars and statues; and at Rome, the salii, who were priests of Mars, danced through the streets in honour of that God. The poets made the gods themselves dance. The Christians are not free from this superstition; for in popish countries certain festivals, particularly those of the sacrament, and passion of our Lord, are celebrated with dancing.

**DANCETTE**, in heraldry, is when the outline of any bordure, or ordinary, is indented very largely, the largeness of the indentures being the only thing that distinguishes it from indented.

**DANDELION**, in botany. See **LEONTODON**.

**DANEGELT**, a tax or tribute on every hide of land, imposed on our ancestors the Saxons by the Danes, on their frequent invasions, as the arbitrary terms of peace and departure.

**DARNAMAS**, the name of the best sort of cotton that comes from Smyrna, so called from a plain near that city.

**DANTELE**, in heraldry. See **DANCETTE**.

**DANTIA**, in botany. See **ISNARDIA**.

**DANTZICK**, the capital of regal Prussia, in the kingdom of Poland, situated on the western shore of the river Wesel, or Vistula, which a little below falls into the Baltic sea: E. long. 19°, and N. lat. 54°. It

is an excellent harbour, and has the best foreign trade within the Baltic.

**DANUBE**, one of the largest rivers in Europe, which, taking its rise in the Black Forest in Swabia, runs eastward through Bavaria, Austria, Hungary, and Turkey in Europe; discharging itself by several channels into the Pontus Euxinus, or Black Sea.

**DAPHNE**, in botany, a genus of the octandria monogynia class. It has no calix; the corolla consists of four segments; and the berry contains but one seed. There are 11 species, two of which are natives of Britain, viz. the laureola, or spurge laurel; and the mezerium, or spurge olive. The laureola is a strong cathartic.

**DAPPLE BAY**, in the menage: when bay horses have marks of a dark bay, they are called dapple-bays.

**DAPPLE-BLACK**; when a black horse has got spots or marks, more black or shining than the rest of his skin, he is called a dapple-black.

**DARAPTI**, among logicians, one of the modes of syllogisms of the third figure, whose premises are universal affirmatives, and the conclusion is a particular affirmative: thus,

DAR- Every body is divisible;

AP- Every body is a substance;

TI, Therefore, some substance is divisible.

**DARBY**, the capital of Darbyshire, situated on the river Darwent: W. long. 1° 25', and N. lat. 53°.

**DARDANELLS**, two castles at the entrance of the Hellespont, where all ships going to Constantinople are examined: E. long. 27°, and N. lat. 40° 5'.

**DARIEN**, a province of Terra Firma, in South America, being the narrow isthmus which joins North and South America.

**DARII**, in logic, one of the modes of syllogism of the first figure, wherein the major proposition is an universal affirmative, and the minor and conclusion particular affirmatives: thus,

DA- Every thing that is moved, is moved by another;

RI- Some body is moved;

I, Therefore, some body is moved by another.

**DARKING**, a market-town of Surrey, situated ten miles east of Guilford: W. long. 20', and N. lat. 51° 18'.

**DARLINGTON**, a market-town of the county of Durham, situated twenty miles south of the city of Durham: W. long. 1° 15', and N. lat. 54° 30'.

**DARMSTAT**, the capital of Hesse-Darmstadt, in the circle of the upper Rhine in Germany, situated on a river of the same name, fourteen miles south of Frankfurt, and thirteen south-east of Mentz: E. long. 8° 25', and N. lat. 49° 45'.

**DARNEL**, in botany. See **LOLIUM**.

**DARTFORD**, a market-town of Kent, in the Dover road, fourteen miles south east of London: E. long. 16', and N. lat. 51° 25'.

**DARTMOUTH**, a borough and port town of Devonshire, situated on the English channel, twenty-six miles south-

fourth of Exeter, which sends two members to parliament: W. long.  $4^{\circ}$ , and N. lat.  $50^{\circ} 25'$ .

**DARWENT**, a river, which, rising in the Peak of Derbyshire, runs from north to south through that county, and falls into the Trent.

**DASYPUS**, the **ARMADILLO**, in zoology, a genus of quadrupeds belonging to the order of bruta. The *dasypus* has neither fore-teeth nor dog-teeth; it is covered with a hard boney shell, intersected with distinct moveable zones or belts: This shell covers the head, the neck, the back, the flanks, and extends even to the extremity of the tail; the only parts to which it does not extend, are the throat, the breast, and the belly, which are covered with a whitish skin of a coarse grain, resembling that of a hen after the feathers are pulled off. The shell does not consist of one entire piece, like that of the tortoise, but is divided into separate belts connected to each other by membranes, which enable the animal to move it, and even to roll itself up like a hedge-hog. The number of these belts does not depend on the age of the animal, as some have imagined, but is uniformly the same at all times, and serves to distinguish the different species. All the species of this animal were originally natives of America: they were entirely unknown to the ancients; and modern travellers mention them as peculiar to Mexico, Brasil, and the southern parts of America; though some indeed have confounded them with two species of manis, or shell-lizard, which are found in the East Indies: Others report that they are natives of Africa, because some of them have been transported from Brasil to the coast of Guinea, where a few have since been propagated: but they were never heard of in Europe, Asia, or Africa, till after the discovery of America.— They are all endowed with the faculty of extending and contracting their bodies, and of rolling themselves up like a ball, but not into so compleat a sphere as the hedge-hog. They are very inoffensive animals, excepting when they get into gardens, where they devour the melons, potatoes, and other roots. They walk quickly; but can hardly be said to run or leap; so that they seldom escape the pursuit either of men or dogs. But nature has not left them altogether defenceless. They dig deep holes in the earth; and seldom go very far from their subterraneous habitations: Upon any alarm, they immediately go into their holes; but, when at too great a distance, they require but a few moments to make one. The hunters can hardly catch them by the tail before they sink their body in the ground, where they stick so close, that the tail frequently comes away and leaves the body in the earth; which obliges the hunters, when they want to take them alive and immutated, to dilate the sides of the hole. When they are taken, and find that there is no resource, they instantly roll themselves up, and will not extend their bodies, unless they are held near a fire. When in deep holes, there is no other method of making them come out, but by forcing in smoke or water. They keep in their holes through the day, and seldom go abroad in quest of subsistence but in the night. The hunters usually chase them with small dogs, which easily come up with them. When

the dogs are near, the creatures instantly roll themselves up, and in this condition the hunters carry them off. However, if they be near a precipice, they often escape both the dogs and hunters: they roll themselves up, and tumble down like a ball, without breaking their shell, or receiving any injury. The *dasypus* is a very fruitful animal; the female generally brings forth four young ones every month; which is the reason why the species is so numerous, notwithstanding they are so much sought after on account of the sweetness of their flesh. The Indians likewise make baskets, boxes, &c. of the shells which cover their heads.

Linnæus enumerates six species of *dasypus*, principally distinguished by the number of their moveable belts.

1. The *novemcinctus*, or *dasypus*, with nine moveable belts, (see Plate LXVIII. fig. 1.) The head is long and narrow; the muzzle extends a good way beyond the under lip; the mouth is large; the eyes are small, and placed on the sides of the head; the ears are long, and placed near each other; the tail is long and conical, and terminates in a sharp point. It has five toes on the hind-feet, and only four on the fore-feet; the claws are long, and of a yellowish colour. The length of the body, from the point of the muzzle, to the origin of the tail, is about eleven inches; and the length of the tail, about nine and a half.

2. The *unicinctus*, or *dasypus*, with eighteen moveable belts: the other species have two large immovable pieces of shell, one on the shoulders, and another on the buttocks: this species has but one, which is on the shoulders, from that to the tail consisting entirely of moveable belts. The length of the body, from the point of the muzzle, to the origin of the tail, is about nine inches, and the tail about five.

3. The *tricinctus*, or *dasypus*, with three moveable belts. The head is oblong, and covered with an entire piece of shell; the ears are short and roundish; it has five toes on all the feet, and the two middle claws of the fore-feet are remarkably larger than the rest; the tail is short, being about two inches in length; and the body is about one foot long.

4. The *quadricinctus*, or *dasypus*, with four moveable belts: Linnæus is mistaken with regard to the trivial name and specific character of this animal; it ought to be called the *sexcinctus*, or *dasypus*, with six moveable belts; for, according to Brissonius, Bouffon, and most other natural historians, none of the species of this genus have four moveable belts. It has five toes on every foot.

5. The *septemcinctus*, or *dasypus*, with seven moveable belts: Here Linnæus is in another error of the same kind; for this animal has eight moveable belts. It has four toes on the fore-feet, and five on the hind-feet.

6. The *dasypus* with 12 moveable belts. This is the largest species, being about two feet in length.

**DATA**, among mathematicians, a term for such things or quantities as are given or known, in order to find other things thereby that are unknown. Euclid uses the word *data* (of which he hath a particular tract) for

for such spaces, lines, and angles as are given in magnitude, or to which we can assign others equal.

**DATE**, in law, is the description of the day, month, year of our Lord, and year of the reign of the king, in which a deed or other writing was made.

**DATE**, the fruit of the phoenix, or great palm-tree. See **PHOENIX**.

**DATISI**, in logic, a mode of syllogisms in the third figure, wherein the major is an universal affirmative, and the minor and conclusion particular affirmative propositions. For example,

DA- All who serve God are kings;

TI- Some who serve God are poor;

SI. Therefore, some who are poor are kings.

**DATIVE**, among grammarians, the third case in the declension of nouns, expressing the relation of a thing to whose profit or loss some other thing is referred. It is called dative, because usually governed by a verb, implying something to be given to some person. In English, the dative is expressed by the signs *to* or *for*.

**DATURA**, the **THORN-APPLE**, in botany, a genus of the pentandria monogynia class. The corolla is plaited and tunnel-shaped; the calix is tubulous, angular, and deciduous; and the capsule consists of four valves. There are six species, all natives of warm climates. The thorn-apple is a narcotic poison: It has lately been recommended in cases of madness by Dr Stork, but without answering any useful purpose.

**DAUCUS**, the **CARROT**, in botany, a genus of plants belonging to the pentandria digynia class. The corollæ are subradiated, and all hermaphrodite; and the seeds are rough and hairy. There are five species, only one of which, *viz.* the carota, wild-carrot, or bird's-nest, is a native of Britain. The seeds are said to be diuretic and carminative.

**DAVENTRY**, a market town of Northamptonshire, situated about ten miles north of Northampton: W. long.  $1^{\circ} 15'$ , and N. lat.  $52^{\circ} 12'$ .

**DAVIDISTS**, in church-history, a sect of Christian heretics in the XVIIth century; so called from David George, their leader, who began by giving out that he was the Messiah, and was sent into the world in order to people the kingdom of heaven, which was quite empty of inhabitants, for want of virtuous and good men: he rejected marriage, and denied the resurrection.

**DAVIDS**, or **ST DAVID'S**, a city and bishop's see of Pembrokehire, situated near the Irish channel, about twenty miles north west of Pembroke: W. long.  $5^{\circ} 20'$ , and N. lat.  $52^{\circ}$ .

**ST DAVID'S** is also the name of a town and fort situated on the coast of Coromandel, in the hither India, about eighty miles south of Fort St George: E. long.  $79^{\circ} 40'$ , and N. lat.  $11^{\circ} 45'$ .

**DAVIS'S STRAITS** run north-west from Cape Farewell, in  $60^{\circ}$  N. lat. to Baffin's bay, in  $80^{\circ}$  N. lat. separating Greenland from North America.

**DAVIT**, in a ship, that short piece of timber with a notch at one end, wherein, by a strap, hangs the fish-block.

The use of this block is to help up the fluke of the  
Vol. II. No. 43. 3

anchor, and to fasten it at the ship's bow or loof. The davit is shiftable from one side of the ship to the other, as there is occasion.

**DAUPHIN**, a title given to the eldest son of France, and heir presumptive of the crown, on account of the province of Dauphiny, which, in 1343, was given to Philip of Valois, on this condition, by Humbert dauphin of the Viennois.

**DAUPHIN-FORT**, a fort built by the French, on the eastern coast of the island of Madagascar, E. long.  $48^{\circ}$ , and S. lat.  $24^{\circ}$ .

**DAUPHINE**, or **DAUPHINY**, a province of France, bounded by Burgundy on the north, by Piedmont on the east, by Provence on the south, and by the river Rhone, which separates it from Languedoc and the Lyonois, on the west.

**DAY**. See Vol. I. p. 491.

**DAYS of grace**, are those granted by the court at the prayer of the defendant, or plaintiff, in whose delay it is.

**DAYS of grace**, in commerce, are a customary number of days allowed for the payment of a bill of exchange, &c. after the same becomes due.

Three days of grace are allowed in Britain; ten in France and Dantzic; eight at Naples; six at Venice, Amsterdam, Rotterdam, and Antwerp; four at Frankfurt; five at Leipzig; twelve at Hamburg; six in Portugal; fourteen in Spain; thirty in Genoa, &c.

**DAY'S MAN**, in the north of England, an arbitrator or person chosen to determine an affair in dispute.

**INTERCALARY DAYS**. See Vol. I. p. 489.

**DEACON**, one of the three sacred orders of the Christian church.

As to the office of deacons, the most common and ordinary was to be attendant on the bishops and presbyters in the service of the altar, to take care of the holy table and all the ornaments and utensils belonging to it; and, in the next place, to receive the offerings of the people, and to present them to the priest; at the same time reciting the names of those that offered. In some churches, though not in all, the deacons read the gospel both before and at the communion-service; but their most peculiar office was to assist the bishop and presbyters in the administration of the eucharist, at which their business was to distribute the elements to the people who were present, and carry them to those who were absent. That they were never allowed to consecrate them at the altar, appears from the testimonies of Hilary, Jerom, and the author of the constitutions. They were permitted, however, to administer solely the sacrament of baptism in some cases. Another part of the office of deacons, was to be a sort of monitors and directors to the people in the exercise of their public devotions in the church; for which purpose they made use of certain known forms of words, to give notice when each part of the service began. Whence they are sometimes called [*eirkerukes*,] the holy cryers of the church.

Deacons had, by licence and authority from the bishop, a power to preach, to reconcile penitents and grant them absolution, and to represent their bishops

in general councils. Their office out of the church was to take care of the necessitous, such as orphans, widows, prisoners, and all the poor and sick who had any title to be maintained out of the public revenues of the church; to inquire into the morals and conversation of the people, and to make their report thereof to the bishop. Whence, on account of the variety of business, it was usual to have several deacons in the same church.

In the Romish church, it is the deacons office to incense the officiating priest or prelate; to lay the corporal on the altar; to receive the paten or cup from the subdeacon, and present them to the person officiating; to incense the choir; to receive the pax from the officiating prelate, and carry it to the subdeacon; and at the pontifical mass, when the bishop gives the blessing, to put the mitre on his head, and to take off the archbishop's pall, and lay it on the altar. In England, the form of ordaining deacons, declares that it is their office to assist the priest in the distribution of the holy communion; in which, agreeably to the practice of the ancient church, they are confined to the administering the wine to the communicants. A deacon, with us, is not capable of any ecclesiastical promotion, yet he may be a chaplain to a family, curate to a beneficed clergyman, or lecturer to a parish church. He may be ordained at twenty-three years of age, *anno corrente*; but it is expressly provided, that the bishop shall not ordain the same person a priest and deacon in the same day. Deacons, according to St Paul, should be chaste, sincere, and blameless; neither great drinkers, nor given to filthy lucre; they should hold the mystery of the faith in a pure conscience, and should be well approved before they are admitted to the ministry.

**DEACONESS**, a female deacon, an order of women, who had their distinct offices and services in the primitive church. This office appears as ancient as the apostolical age; for St Paul calls Phebe a servant of the church of Cenchrea. The original word is [*diakonos*], answerable to the Latin word *ministra*. Tertullian calls them *viduæ*, widows, because they were commonly chosen out of the widows of the church; and, for the same reason, Epiphanius, when the council of Laodicea, calls them [*presbutidas*], elderly women, because none but such were ordinarily taken into this office. For, indeed, by some ancient laws, these four qualifications were required in every one that was to be admitted into this order. 1. That she should be a widow. 2. That she should be a widow that had born children. 3. A widow that was but once married. 4. One of a considerable age, forty, fifty, or sixty years old. Though all these rules admitted of exceptions. Concerning their ordination, whether it was always performed by imposition of hands, the learned are much divided in their sentiments. Baronius and Valerius think they were not, and make no other account of them than as mere lay-persons. But the author of the constitutions, speaking of their ordination, requires the bishop to use imposition of hands, with a form of prayer which is there recited. We

are not, however, to imagine, that this ordination gave them any power to execute any part of the sacerdotal office. They were only to perform some inferior services of the church, and those chiefly relating to the women for whose sakes they were ordained. One part of their office was to assist the minister at the baptizing of women, to undress them for immersion, and to dress them again, that the whole ceremony might be performed with all the decency becoming so sacred an action. Another part of their office was to be private catechists to the women-catechumens who were preparing for baptism. They were likewise to visit and attend women that were sick and in distress; to minister to the martyrs and confessors in prison; to attend the womens gate in the church; and, lastly, to assign all women their places in the church, regulate their behaviour, and preside over the rest of the widows, whence in some canons they are styled [*prokathemenai*] governesses. This order, which since the tenth or twelfth century has been wholly laid aside, was not abolished every where at once, but continued in the Greek church longer than in the Latin, and in some of the Latin churches longer than in others.

**DEAD-MAN'S HEAD**, in geography, a cape or promontory near Tregony in Cornwall, between St Mawes and Fowey.

**DEAD-MENS-EYES**, in the sea-language, a kind of blocks with many holes in them, but no streevers, whereby the shrouds are fastened to the chains: the crow feet reeve also through these holes; and, in some ships, the main-stays are set tight in them; but then they have only one hole, through which the lanyards are passed several times.

**DEAD-NETTLE**. See **LAMIUM**.

**DEAD-RECKONING**, in navigation, the calculation made of a ship's place by means of the compass and log; the first serving to point out the course she sails on, and the other the distance run. See **NAVIGATION**.

**DEAD'S PART**, in Scots law, that proportion of the funds of a marriage, which, upon the dissolution of it, goes to the executor of the deceased husband or wife, as the defunct or dead's part. See **SCOTS LAW**, title 28.

**DEAD-SEA**, in geography, a lake of Judea, into which the river Jordan discharges itself; being about seventy miles long, and twenty broad.

**DEAD-TOPS**, a disease incident to young trees, and cured by cutting off the dead parts close to the next good twig or shoot, and claying them over as in grafting.

**DEAD-WATER**, at sea, the eddy-water just astern of a ship, so called, because it does not pass away so swift as the water running by her sides does. They say that a ship makes much dead-water, when she has a great eddy following her stern.

**DEADLY CARROT**. See **THAPSIA**.

**DEADLY NIGHTSHADE**. See **ATROPA**.

**DEADS**, among miners, denotes the earth or other fusile substances which inclose the ore on every side. Hence, *breaking up the deads*, is the removing these substances for the conveniency of carrying on their work.

**DEAFNESS**,



**DEAFNESS**, the state of a person who either wants the sense of hearing, or has it greatly impaired. See **DUMB**.

**DEAL**, a thin kind of fir-planks, of great use in carpentry: they are formed by sawing the trunk of a tree into a great many longitudinal divisions, of more or less thickness, according to the purposes they are intended to serve.

Deals are rendered much harder, by throwing them into salt water as soon as they are sawed, keeping them there three or four days, and afterwards drying them in the air or sun; but neither this nor any other method yet known, will preserve them from shrinking.

Deals called Burgendorp deals, the hundred containing six score, pay on importation 3 l. 8 s. 8  $\frac{1}{2}$  d. and draw back 3 l. 3 s. the rate 12 l. Meabro deals, six score, pay 1 l. 2 s. 10  $\frac{1}{2}$  d. and draw back 1 l. 1 s. the rate 4 l. Norway deals, six score, pay 1 l. 8 s. 7  $\frac{1}{2}$  d. and draw back 1 l. 6 s. 3 d. the rate 5 l. Spruce deals, six score, pay 4 l. 5 s. 10  $\frac{1}{2}$  d. and draw back 3 l. 18 s. 9 d. the rate 15 l. Deals from Russia, and all other countries not particularly rated, exceeding twenty feet in length, pay 4 l. 5 s. 10  $\frac{1}{2}$  d. and draw back 3 l. 18 s. 9 d. the rate 15 l. Deals from Sweden, or any other country, of twenty feet in length or under, not otherwise rated, the 120, pay 1 l. 8 s. 7  $\frac{1}{2}$  d. and draw back 1 l. 6 s. 3 d. the rate 5 l.

**DEAL**, in geography, a port-town of the county of Kent, between which and the Goodwin-sands, the shipping usually rides in the Downs, in going out or coming home: it is about sixty-seven miles eastward of London: E. long. 1° 30', and N. lat. 51° 16'.

**DEAN**, an ecclesiastical dignitary in cathedral and collegiate churches, and head of the chapter.

**DEAN and CHAPTER**, are the bishop's council to assist him in the affairs of religion, and to assent to every grant which the bishop shall make to bind his successors. As a deanry is a spiritual dignity, a man cannot be a dean and prebendary of the same church.

**DEAN of guild**, in Scots law, a magistrate of a royal borough, who has the cognizance of mercantile causes, and the inspection of buildings within borough. See **SCOTS LAW**, title 4.

**DEATH** is generally considered as the separation of the soul and body; in which sense it stands opposed to life, which consists in the union thereof.

*The law of DEATH-BED*, in Scots law, the privilege which that law allows to an heir of reducing all deeds respecting the heretable estate of his predecessor, granted by him while on death-bed, in prejudice of the lawful heir. All deeds are liable to reduction *ex capite lesiti*, that are granted by a person within sixty days of his death, if he had then contracted the disease of which he died, and had not afterwards recovered, so as to have gone to kirk or market unsupported. See **SCOTS LAW**, title 27.

**DEBENHAM**, a market-town of Suffolk, about twenty miles east of Bury: E. long. 1° 20', and N. lat. 52° 20'.

**DEBENTURE**, a term of trade used at the custom-house for a kind of certificate signed by the officers of

the customs, which intitles a merchant exporting goods to the receipt of a bounty or draw-back. All merchandises that are designed to be taken on board for that voyage being entered and shipped, and the ship being regularly cleared out, and sailed out of port on her intended voyage, debentures may be made out from the exporter's entries, in order to obtain the drawbacks, allowances, bounties, or premiums; which debentures for foreign goods are to be paid within one month after demand. And in making out these debentures, it must be observed, that every piece of vellum, parchment, or paper, containing any debenture for drawing back customs or duties, must, before writing, be stamped, and pay a duty of 3 d.

The forms of debentures vary, according to the merchandise exported. In the execution of debentures for tobacco, it must be particularly observed, 1. That debentures for the same quantity, may be made in one or more parchments. 2. That the exporter's oath must be printed, specifying whether he acts for himself or by commission. If exported to any other foreign ports than Ireland, the word *Ireland* must be added to the oath after Great Britain. 4. That as no tobacco may be consumed on board ships of war in Europe, but what has paid full duties, and been manufactured in Great Britain, no drawback is to be allowed for tobacco exported in any man of war. 5. That the eight pounds *per* hoghead of 350 pounds, or more, allowed for draught at importation, must not be deducted on exportation. 6. That debentures for tobacco exported to Ireland, must not be paid till a certificate be produced, testifying the landing thereof. 7. That no persons may swear to the exportation, but such as are permitted to swear to debentures for other goods. In debentures for all other foreign goods, no person may be admitted to swear to the exportation, but the true exporter, either as a proprietor, or who being employed by commission, is concerned in the direction of the voyage. All kinds of debentures before delivered or paid to the exporters, are entered into a separate book kept for that purpose by the collector and comptroller of the customs.

**DEBITA fundi**, in Scots Law. A debt is said to be a *debitum fundi*, when it is recoverable either by a personal action against the debtor himself, or by a real action against his lands.

**DEBITA fructuum**, in Scots law. Funds are *debita fructuum* not *fundi*; so are not recoverable out of the lands themselves, but out of the fruits of the lands out of which they are payable. See **SCOTS LAW**, title 17.

**DEBILITY**, among physicians, a relaxation of the solids, occasioning oftentimes weaknesses and faintings.

**DEBRECHEN**, a town of Upper Hungary, about seventy-seven miles east of Buda: E. long. 21° 10' N. lat. 47° 45'.

**DEBRUIZED**, in heraldry, a term peculiar to the English, by which is intimated the grievous restraint of any animal, debarred of its natural freedom, by any of the ordinaries being laid over it.

**DEBT**, in law, any thing due to another, whether it be money,

- money, goods, or services; or the action brought for recovering the same.
- DEBTOR**, a person who owes any thing to another; in contradistinction to creditor, which is he to whom the debt is owing.
- DEBTOR**, in merchants accounts. See **BOOK-KEEPING**.
- DECAGON**, in geometry, a plane figure with ten sides and ten angles.
- DECALOGUE**, the ten precepts or commandments delivered by God to Moses, after engraving them on two tables of stone.
- The Jews, by way of excellence, call these commandments the *ten words*, from whence they had afterwards the name of decalogue: but it is to be observed, that they joined the first and second into one, and divided the last into two: they understand that against stealing, to relate to the stealing of men, or kidnapping; alledging, that the stealing one anothers goods or property, is forbidden in the last commandment.
- The emperor Julian objected to the decalogue, that the precepts it contained (those only excepted which concern the worship of false gods, and the observation of the sabbath) were already so familiar to all nations, and so universally received, that they were unworthy, for that very reason, to be delivered, by so great a legislator, to so peculiar a people. The church of Rome has struck the second commandment quite out of the decalogue, and to make their number complete, hath split the tenth into two. The reason of which may be easily conceived.
- DECAN**, a province of the Hither India, bounded by the province of Cambaya, or Guzurat, on the north; by Golconda and Berar, on the east; by Visapour, on the south; and by the Indian ocean on the west.
- DECANDRIA**, in the Linnæan system of botany. See **BOTANY**, the *Scheme*, p. 635. and Plate LIII. fig. 10.
- DECANTATION**, among chemists, &c. the gently pouring off a liquor from its fæces, by inclining the lip or canthus of the vessel; whence the name.
- DECANUS**, in Roman antiquity, an officer who presided over other ten officers, and was head of the *contubernium*, or serjeant of a file of soldiers.
- DECAPROTI**, *decemprimi*, in Roman antiquity, officers for gathering the tributes and taxes.
- The decaproti were also obliged to pay for the dead, or to answer to the emperor for the quota parts of such as died, out of their own estates.
- DECASTYLE**, in the ancient architecture, a building with an ordnance of ten columns in front, as the temple of Jupiter Olympius was.
- DECEIT**, in law, a subtle trick, or device, to which may be added all manner of craft and collusion, or underhand practice, used to defraud another, by any means whatever.
- DECEMBER**, the last month of the year, consisting of thirty-one days, and so called as being the tenth month in the Roman year, which commenced with March.
- DECEMPEDA**, in antiquity, a rule or rod divided into ten feet, each of which was subdivided into inches, and these into digits, used in measuring of land, and by architects, in giving the proper dimensions and proportions to the parts of their buildings.
- DECENVIRI**, in Roman antiquity, ten magistrates chosen annually at Rome, to govern the commonwealth instead of consuls, with an absolute power to draw up and make laws for the people.
- One of the decenviri had all the ensigns and honours of the function, and the rest had the like in their turn, during the year of their decemvirate. In them was vested all the legislative authority ever enjoyed by the kings, or, after them, by the consuls. It was the decenviri drew up the laws of the Twelve Tables, thence called *leges decemvirales*, which were the whole of the Roman law, for a considerable time.
- DECENNALIA**, ancient Roman festivals celebrated by the emperors, every tenth year of their reign, with sacrifices, games, and largesses for the people. The emperor Augustus first instituted these solemnities, in which he was imitated by his successors.
- DECIDUOUS**, an appellation chiefly used in respect of plants: thus, the calix or cup of a flower is said to be deciduous, when it falls along with the flower-petals; and, on the contrary, it is called permanent, when it remains after they are fallen. Again, deciduous leaves are those which fall in autumn, in contradistinction to those of the ever-greens, which remain all the winter.
- DECIL**, in astronomy, an aspect or position of two planets, when they are distant from each other a tenth part of the zodiac.
- DECIMAL ARITHMETIC**, the art of computing by decimal fractions.
- DECIMAL FRACTION**, in arithmetic. See Vol. I. p. 395.
- DECIMATION**, a punishment insisted by the Romans, on such soldiers as quitted their post, or behaved themselves cowardly in the field. The names of all the guilty were put into an urn or helmet, and as many were drawn out as made the tenth part of the whole number, and these were put to the sword, and the others saved.
- DECIPHERING**, the art of finding the alphabet of a cypher. See **CYPHER**.
- Every language has, besides the form of its characters, something peculiar in the place, order, combination, frequency, and number of the letters; to all which particular regard is to be had in deciphering. In all languages, however, the following rules ought to be observed: 1. One word is to be compared with another, that their resemblance and difference may be known. 2. No word can be without a vowel. 3. A word of one letter is always a vowel, or a consonant with an apostrophe. 4. The vowels recur much more frequently than the consonants. 5. Double vowels may be at the beginning of a word, but not double consonants. 6. Double characters at the beginning of a word are always vowels. 7. Short words of two or three letters have two or three, or one or two consonants. 8. The vowels are therefore most easily learned from the short words which are to be first considered by the decipherer. 9. If double characters are preceded by a single letter, the letter is a vowel. 10. In languages abounding with diphthongs

one vowel is of ten joined with another. 11. The letter that precedes or follows double consonants is, if a consonant, always one of the liquids, *l, m, n, r*, 12. If two different characters occur, of which the latter is often conjoined with various letters, and the former is never found either by itself, or followed by any other letter, those two are *qu*. 13. These letters *qu* are always followed by a vowel. 14. One vowel recurs more frequently than another, as do the consonants, according to the language, &c.

**DECISE**, a town of the Orleanois, in France, situated on the river Loire, about fifteen miles south-east of Nevers: E. lon.  $3^{\circ} 32'$ , and N. lat.  $46^{\circ} 40'$

**DECK** of a ship is a planked floor from stem to stern, upon which the guns lie, and where the men walk to and fro.

Great ships have three decks, first, second, and third, beginning to count from the lowermost.

Half deck reaches from the main-mast to the stem of the ship.

Quarter-deck is that aloft the steerage, reaching to the round house.

Flush deck is that which lies even in a right-line fore and aft, from stem to stern. A rope-deck is that made of cordages, interwoven and stretched over a vessel, through which it is easy to annoy an enemy who comes to board her. They are little used but by small vessels, to defend them against privateers.

**DECKENDORF**, a town of Bavaria, in Germany, situated on the Danube, about thirty-seven miles south-east of Ratisbon: E. long.  $13^{\circ}$ , and N. lat.  $48^{\circ} 45'$ .

**DECLAMATION**, a speech made in public, in the tone and manner of an oration, uniting the expression of action to the propriety of pronunciation, in order to give the sentiment its full impression upon the mind.

**DECLARATORY action**, in Scots law, is that by which a pursuer only craves, that some right or privilege shall be declared to belong to him, without demanding the payment or performance of any thing from the defender. See SCOTS LAW, title, 30.

**DECLENSION**, in grammar, an inflexion of nouns according to their divers cases, as nominative, genitive, dative, &c. It is a different thing in the modern languages, which have not properly any cases, from what it is in the ancient Greek and Latin. With respect to languages, when the nouns admit of changes, either in the beginning, the middle, or ending; declension is properly the expression of all those changes in a certain order, and by certain degrees called cases. With regard to languages, where the nouns do not admit of changes in the same number, declension is the expression of the different states a noun is in, and the different relations it has; which difference of relations is marked by particles, and called articles, as *a, the, of, to, from, by, &c.*

**DECLINATION**, in astronomy, the distance of any celestial object from the equinoctial, either northward or southward. It is either true or apparent, according

as the real or apparent place of the object is considered. See ASTRONOMY.

**DECLINATION of a wall or plane for dials.** See DIALLING.

**DECLINATOR, or DECLINATORY**, an instrument contrived for taking the declinations, inclinations, and reclinations of planes.

**DECLINATURE of judges**, in Scots law, declining the jurisdiction of a judge, or refusing to acquiesce in his judgment from any legal obligation to the judge himself, the incompetency of his jurisdiction to the nature of the action, or upon the privilege of the objector or decliner. See SCOTS LAW, title 2.

**DECLIVITY** denotes the reverse of acclivity. See ACCLIVITY.

**DECOCTION**, in pharmacy, the boiling simples, or other drugs, in order to extract their virtues for some medicinal purpose. The general subjects of decoction are animals and vegetables, and sometimes minerals, as antimony and quicksilver. The liquors which serve to boil them, are water, wine, vinegar, milk, and whey.

**DECOMPOSITION**, in chemistry, the reduction of a body into its principles or component parts. See CHEMISTRY.

**DECORATION**, in architecture, is used for whatever adorns a building, either withoutside or within.

**DECORUM**, in architecture, is the suitableness of a building, and the several parts and ornaments thereof, to the station and occasion.

**DECOUPLE'**, in heraldry, the same as uncoupled: thus a chevron decouplé, is a chevron wanting so much of it towards the point, that the two ends stand at a distance from one another, being parted and uncoupled.

**DECOURS**, in heraldry. See DECREMENT.

**DECOY**, a place made for catching wild-fowl. Hence, **DECOY-DUCK** is a duck that flies abroad, and lights into company with wild ones, which by her allurements she draws into the decoy.

**DECREE**, an order made by a superior power, for the regulation of an inferior.

**DECREE**, in the civil law, is a determination that the emperor pronounces upon hearing a particular cause between plaintiff and defendant.

**DECREE, or DECRET**, in Scots law, the decisive sentence or judgment of a court of law.

**DECREET-ARBITRAL**, in Scots law, the sentence or judgment of one to whom parties voluntarily submit the determination of any question betwixt them. See SCOTS LAW, title 32.

**DECREMENT**, in heraldry, signifies the wane of the moon from the full to the new. The moon in this state is called moon decreescent, or in decours; and when borne in coat-armour, faces to the left side of the escutcheon, as the does to the right side when in the increment. See CRESCENT.

**DECREPITATION**, in chemistry, the act of catching salt over the fire, till it cease to crackle. See CHEMISTRY.

- It is also applied to the crackling of the salts during the operation.
- DECRETAL**, in the canon-law, a letter of a pope, determining some point or question in the ecclesiastical law. The decretals compose the second part of canon law. The first genuine one acknowledged by all the learned as such, is the letter of pope Siricius, written in the year 385, to Himerus bishop of Tarragona in Spain, concerning some disorders which had crept into the churches of Spain.
- DECUMANI DENTES**, in heraldry. See **DANCETTE**.
- DECUPLE PROPORTION**, that of ten to one.
- DECURIO**, in Roman antiquity, a commander of ten men in the army, or the chief of a decury.
- DECURRENT LEAF**. See **BOTANY**, p. 641.
- DECURY**, ten persons ranged under one chief, or leader, called the decurio.
- The Roman cavalry was divided into decuries, which were subdivisions of a century, each century containing ten decuries.
- DECUSSION**, a term in geometry, optics, and anatomy, signifying the crossing of any two lines, rays, or nerves, when they meet in a point, and then go on separately from one another.
- DECUSSORIUM**, a surgeon's instrument, which, by pressing gently on the dura mater, causes an evacuation of the pus collected between the cranium and the before mentioned membrane, through the perforation made by the trepan.
- DEDDINGTON**, a market town of Oxfordshire, about fifteen miles north of Oxford: W. long.  $1^{\circ} 20'$ , and N. lat.  $51^{\circ} 55'$ .
- DEDHAM**, a market-town in Essex, about thirty-five miles north-east of Chelmsford: E. long.  $1^{\circ} 10'$ , and N. lat.  $52^{\circ} 5'$ .
- DEDICATION**, a solemn devoting or setting apart any person or thing to the service of God and the purposes of religion.
- Feast of DEDICATION*, an anniversary festival among the Jews, in memory of Judas Maccabæus, who repaired and dedicated anew the temple and altar, which had been plundered and profaned by Antiochus Epiphanes. It was observed on the twenty-fifth of Cisleu, and continued eight days.
- DEE**, the name of several rivers, as that on which Chester stands, that whereon Aberdeen stands, &c.
- DEED**, in Scots laws, any settlement, disposition, contract, or other legal writing.
- DEED**, an instrument written on paper or parchment, comprehending some contract, bargain or agreement between the parties thereto, in relation to the matter therein contained.
- DEEMSTERS**, or **DEMSTERS**. All controversies in the Isle of Man are decided without process, writings, or any charges, by certain judges, chosen yearly from among themselves, called deemsters; there being two of them for each division of the island: they sit judges in all courts, either for life or property; and with the advice of twenty-four keys, declare what is law, in uncommon emergencies.
- DEEPING**, a market-town of Lincolnshire, about thirty-five miles south of Lincoln: W. long.  $20^{\circ}$ , and N. lat.  $52^{\circ} 35'$ .
- DEER**, in zoology. See **CERVUS**.
- DEFAMATION**, the speaking slanderous words of another; for which the slanderer is punishable, according to the nature of his offence, either by action upon the case at common law, or by statute, or in the ecclesiastical court.
- DEFAULT**, in law, is generally taken for non-appearance in court, at a day assigned; but imports any omission of that which we ought to do, for which judgment may be given against the defaulter.
- DEFEASANCE**. See **DEFEISANCE**.
- DEFECATE**, or **DEFÆCATE**, in chemistry, a term applied to a body freed and purged from fæces and impurities.
- DEFEISANCE**, in law, a condition relating to some certain deed, which being performed, the deed is defeated and rendered void, as if it had never been made.
- DEFENCE**, in fortification, all sorts of works that cover and defend the opposite posts, as flanks, casements, parapets, and faussebrays. See **FORTIFICATION**.
- Line of DEFENCE*, a supposed line drawn from the angle of the curtain, or from any other part in the curtain, to the flanked angle of the opposite bastion. See **FORTIFICATION**.
- DEFENDER of the faith**, a peculiar title, belonging to the king of Great Britain, as Catholic does to the king of Spain, Christian to the king of France, &c.
- This title was first given by pope Leo X. to king Henry VIII. for writing against Luther.
- DEFERENT**, in anatomy, a term applied to certain vessels in the body, that serve for the conveyance of humours from one part to another. See **ANATOMY**.
- DEFERENT**, in the Ptolemaic astronomy, a circle invented to account for the eccentricity, perigee, and apogee of the planets.
- DEFERENTIA VASA**. See Vol. I. p. 273.
- DEFILE**, in fortification, a strait narrow passage, thro' which a company of horse or foot can pass only in file, by making a small front.
- DEFINITE**, in grammar, is applied to an article that has a precise determinate signification; such as the article *the* in English, *le* and *la* in French, &c. which fix and ascertain the noun they belong to, to some particular, as *the king*, *le roy*; whereas in the quality of *king*, *de roy*, the articles *of* and *de* mark nothing precise, and are therefore indefinite.
- DEFINITION**, an idea of any science, subject, &c. conveyed in a few words.
- DEFINITIVE**, a term applied to whatever terminates a process, question, &c. in opposition to provisional and interlocutory.
- DEFLAGRATION**, in chemistry, the kindling or setting fire to a salt or mineral, &c. either alone, or mixed for that purpose with a sulphureous one in order to purify it. See **CHEMISTRY**.
- DEFLECTION of the rays of light**. See **OPTICS**.
- DEFLUXION**, in medicine, the falling of humours from a superior to an inferior part of the body.
- DEFORCEMENT**,

**DEFORCEMENT**, in Scots law, the opposing or resisting the officers of the law in the execution of their office. See **SCOTS LAW**, titles 25 and 33.

**DEFORMITY**, the want of that uniformity necessary to constitute the beauty of an object. See **BEAUTY**.

**DEGENERATION**, or **DEGENERATING**, in general, denotes the growing worse, or losing some valuable qualities whereof a thing was formerly possessed.

**DEGLUTITION**, in medicine, the act of swallowing the food, performed by means of the tongue driving the aliment into the œsophagus, which, by the contraction of the sphincter, protrudes the contents downwards.

**DEGRADATION**, the act of depriving a person for ever of a dignity or degree of honour, and taking away the title, badge, and privileges of it.

**DEGRADATION**, in painting, expresses the lessening the appearance of distant objects in a landscape, in the same manner as they would appear to an eye placed at that distance from them.

**DEGRADED CROSS**, in heraldry, a cross divided into steps at each end, diminishing as they ascend towards the centre, called by the French *perronnée*. See Plate LXVIII. fig. 6.

**DEGREE**, in geometry, a division of a circle, including a three hundred and sixtieth part of its circumference. See **ASTRONOMY**, and **GEOGRAPHY**.

**DEGREE of latitude**. See **GEOGRAPHY**.

**DEGREE of longitude**. See **GEOGRAPHY**.

**DEGREES**, in music, are the little intervals whereof the concords or harmonical intervals are composed.

**DEGREE**, in universities, denotes a quality conferred on the students or members thereof as a testimony of their proficiency in the arts or sciences, and intitling them to certain privileges.

**DEJECTION**, in medicine, the act of ejecting or evacuating the excrements. It is also applied to the excrements themselves thus evacuated, in which sense it is of the same import with stool.

**DEIFICATION**, in antiquity. See **APOTHEOSIS**.

**DEISM**, the system of religion acknowledged by the deists.

**DEISTS**, in the modern sense of the word, are those persons in Christian countries, who, acknowledging all the obligations and duties of natural religion, disbelieve the Christian scheme, or revealed religion. They are so called from their belief in God alone, in opposition to Christians. The learned Dr Clarke taking the denomination in the most extensive signification, distinguishes deists into four sorts. 1. Such as pretend to believe the existence of an eternal, infinite, independent, intelligent Being; and who teach, that this supreme Being made the world, though they fancy he does not at all concern himself in the management of it. 2. Those who believe not only the being, but also the providence of God with respect to the natural world; but who, not allowing any difference between moral good and evil, deny that God takes any notice of the morally good or evil actions of men; these things depending, as they imagine, on the arbitrary constitutions of human laws. 3. Those who having right apprehensions concerning the natural attributes of

God, and his all governing providence, and some notion of his moral perfections also; yet, being prejudiced against the notion of the immortality of the human soul, believe that men perish entirely at death, and that one generation shall perpetually succeed another, without any future restoration or renovation of things. 4. Such as believe the existence of a supreme Being, together with his providence in the government of the world, as also the obligations of natural religion; but so far only as these things are discoverable by the light of nature alone, without believing any divine revelation. These last are the only true deists; but as the principles of these men would naturally lead them to embrace the Christian revelation, the learned author concludes there is now no consistent scheme of deism in the world.

**DEITY**, a term frequently used in a synonymous sense with God.

**DELEGATES**, commissioners appointed by the king under the great seal to hear and determine appeals from the ecclesiastical court.

**DELEGATION**, a commission extraordinary given by a judge to take cognizance of and determine some cause which ordinarily does not come before him.

**DELEGATION**, in Scots law, a method of extinguishing obligations by the creditor's discharging his former debtor upon another becoming bound in his place.

**DELETERIOUS**, an appellation given to things of a destructive or poisonous nature. See **POISON**.

**DELF**, in heraldry, is by some supposed to represent a square rod or turf, and to be so called from delving, or digging. A delf tenne is due to him that revokes his own challenge, or any way goes from his word; and to such this is given as an abatement to the honour of their arms, and is always placed in the middle of the escutcheon. However, if two or more delfs are found in an escutcheon, they are not then to be looked upon as signs of an abatement, but of honour. Also, if it be of metal, or charged upon, it then becomes a charge of perfect bearing.

**DELFT**, a city of the United Netherlands, in the province of Holland, eight miles north-east of Rotterdam, and thirty south-west of Amsterdam: E. long. 4° 5', and N. lat. 52° 6'.

**DELIA**, in antiquity, feasts celebrated by the Athenians in honour of Apollo, surnamed Delius.

**DELIA** was also a quinquennial festival in the island of Delos, instituted by Theseus at his return from Crete, in honour of Venus, whose statue, given him by Ariadne, he erected on that place, having by her assistance met with success in his expedition.

**DELIBAMENTA**, in antiquity, a libation to the infernal gods, always offered by pouring downwards. See **LIBATION**.

*Jus* **DELIBERANDI**, in Scots law, an apparent heir is allowed a year after his predecessor's death, called *annus deliberandi*, to deliberate whether he will enter and represent him or not, during which time he cannot be pursued for the debts of his predecessor. See **SCOTS LAW**, title 27.

**DELIBERATIVE**,

**DELIBERATIVE**, an appellation given to a kind or branch of rhetoric, employed in proving a thing, or convincing an assembly thereof, in order to persuade them to put it in execution.

To have a deliberative voice in the assembly, is when a person has a right to give his advice and his vote therein. In councils, the bishops have deliberative voices; those beneath them have only consultative voices.

**DELICT**, in Scots law, signifies such small offences or breaches of the peace as are punishable only by fine or short imprisonment. See **SCOTS LAW**, title 33.

**DELIMA**, in botany, a genus of the polyandria monogynia class. It has no corolla; the calix consists of five leaves; and the berry contains two seeds. There is but one species, a native of Ceylon.

**DELINEATION**. See **DESIGNING**.

**DELINQUENT**, a guilty person, or one who has committed some fault or offence, for which he is punishable.

**DELIQUIUM**, or **ANIMI DELIQUIUM**. See **LIPOTHYMIA**.

**DELIQUIUM**, in chemistry, signifies the solution of any body, when exposed to a cool and damp place, by the humidity it attracts from the air.

**DELIRIUM**, in medicine, the production of ideas not answerable to external causes, from an internal indispotion of the brain. See **MEDICINE**.

**DELIVERY**, or **CHILD-BIRTH**. See **MIDWIFERY**.

**DELLY**, the capital of a province of the same name, and at present of all the Hither India: E. long. 79°, and N. lat. 28.

**DELOS**, the principal of the Cyclades islands, in the Archipelago: E. long. 25° 50', and N. lat. 37° 26'.

**DELPHINIUM**, or **LARK'S-SPUR**, in botany, a genus of the polyandria trigynia class. It has no calix; the corolla consists of five petals; and the nectarium is bifid, and horned behind. There are seven species, only one of which, viz. the consolida, or wild lark's-spur, is a native of Britain.

**DELPHINUS**, or **DOLPHIN**, in ichthyology, a genus belonging to the order of cete; the characters of which are these: they have teeth in each jaw; and a fistula or pipe in the head. There are three species, viz. 1. The phocæna, with a conical body, a broad back, and an obtuse snout. The colour of the back is a blackish blue, and the belly is white. The fistula, or pipe, through which they breathe and spout up the water, is betwixt the eyes: it has forty-six teeth in each jaw: it is found in the Baltic and different parts of the European ocean. The skin is smooth and soft. The external orifice of the fistula resembles the letter C: it has two strong pectoral fins, and a cartilaginous fin on the back. The tail is bifid. The penis of the male is not covered with a præputium, it lies concealed within the body, but is easily protruded when occasion requires. In the female, the cervix of the vulva is about nine inches long, and situate betwixt the navel and anus. They copulate in the summer; bring forth one at a birth; they nourish their

young with milk; and they live about thirty years. They live several days out of the water, provided they be not wounded. See **PLATE LXVIII. fig. 2.** It is about four feet long, and two and a half thick. 2. The delphus, or dolphin of the ancients, is of an oblong cylindrical shape, and the snout is sharp and tapering; the teeth are subulated. It likewise frequents the European ocean. 3. The orca, or lesser whale of Ray, has the upper part of the snout waved, and broad serrated teeth. The inferior jaw is much longer than the superior one.

**DELPHINUS**, in astronomy, a constellation of the northern hemisphere. See **ASTRONOMY**.

**DELSBERG**, or **DESBERG**, a town of Switzerland, about seventeen miles south-west of Basle.

**DELTOIDES**, in anatomy. See **VOL. I. p. 195.**

**DELUGE**, an inundation or overflowing of the earth, either wholly or in part, by water.

We have several deluges recorded in history, as that of Ogyges, which overflowed almost all Attica; and that of Deucalion, which drowned all Thessaly in Greece: but the most memorable was that called the universal deluge, or Noah's flood, which overflowed and destroyed the whole earth, and out of which only Noah, and those with him in the ark, escaped. See **ARK**.

Many attempts have been made to account for the deluge by means of natural causes: but these attempts have only tended to discredit philosophy, and to render their authors ridiculous.

**DEMAIN**, or **DEMESNE**, in its common acceptation, is used for the lands round a manor-house, occupied by the lord.

**DEMAIN**, or **DEMESNE**, in law, is commonly understood to be the lord's chief manor-place, with the lands thereto belonging, which he and his ancestors have time out of mind kept in their own manual occupation.

**DEMEMBRE'**, in heraldry, is said of dismembered animals, or those with their limbs cut off.

**DEMEMBRATION**, in Scots law, signifies either the crime of depriving another of any member of his body, or the punishment of a crime by cutting off any member of the criminal's body. See **SCOTS LAW**, title 33.

**DEMER**, a river in the Austrian Netherlands, on which the city of Mechlin stands.

**DEMESNE**. See **DEMAIN**.

**DEMETRIA**, a festival celebrated by the Greeks in honour of Ceres, wherein it was usual for the devotees to lash themselves.

**DEMETRIOWITZ**, a city of the dutchy of Smolensko, in the Russian empire, situated upon the river Ugra, in 37° E. long. and 52° 30' N. lat.

**DEMI**, a word used in composition with other words to signify half.

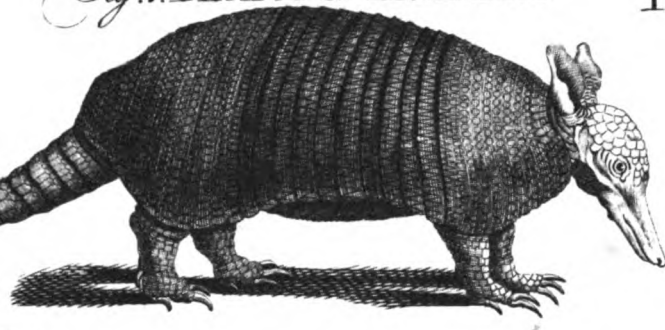
**DEMI-CULVERIN**, a piece of ordnance usually 4½ inches bore, 2700 pound weight, ten feet long, and carrying point blank 175 paces.

**DEMI-CULVERIN of the least size**, is 4¼ inches bore,

6.  
DE GRADED



Fig. 1. DASYPUS or ARMADILLO



7.  
DISPLAYED



Fig 2

DELPHINIS or DOLPHIN

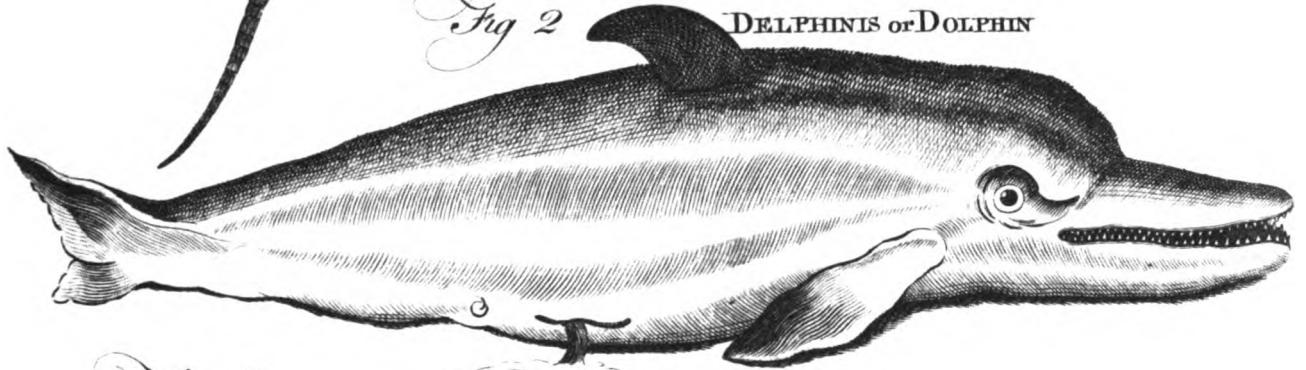
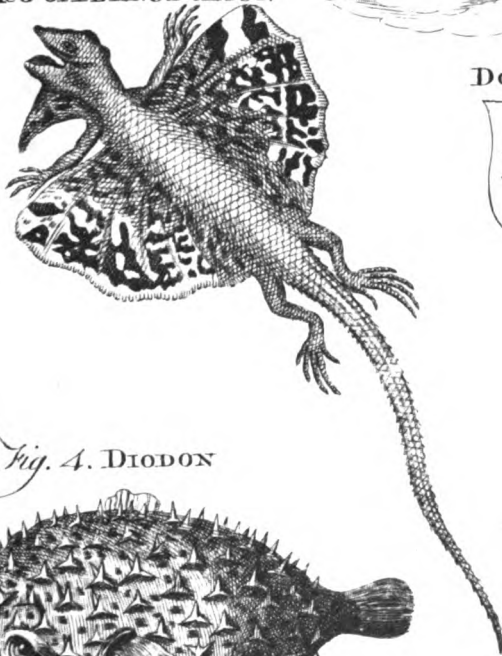


Fig. 5.

DRACO or FLYING DRAGON



8.  
DOUBLE FICHE

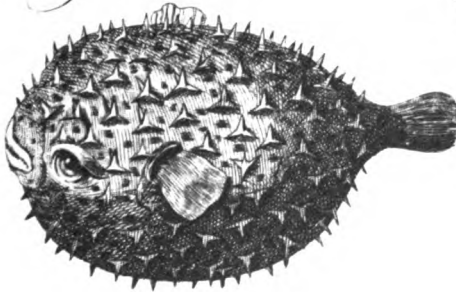


Fig. 3.

DIDELPHIS or OPOSSUM



Fig. 4. DIODON



A. Bell. Sc.<sup>t</sup>





- 10 feet long, and 2000 pounds weight. It carries a ball of 4 inches diameter, and of 9 pounds weight, and its level range is 174 paces.
- DEMI-CULVERIN** of the largest sort, is  $4\frac{1}{2}$  inches bore,  $10\frac{1}{2}$  feet long, and weighs 3000 pounds weight. It carries a ball  $4\frac{1}{2}$  inches diameter, weighing 12 pounds 11 ounces, point blank 178 paces.
- DEMI-GORGE**, in fortification, is that part of the polygon which remains after the flank is raised, and goes from the curtain to the angle of the polygon. It is half of the vacant space or entrance into a bastion.
- DEMI-QUAVER**, a note in music, two of which are equal to a quaver.
- DEMI-SEMI-QUAVER**, in music, the shortest note, two of them being equal to a semi-quaver.
- DEMOCRACY**, the same with a popular government, wherein the supreme power is lodged in the hands of the people: such were Rome and Athens of old; but as to our modern republics, Basil only excepted, their government comes nearer to aristocracy than democracy.
- DEMONSTRABLE**, a term used in the schools, to signify that a thing may be clearly proved. Thus it is demonstrable that the three angles of a triangle are equal to two right ones.
- DEMONSTRATION**, in logic, a series of syllogisms, all whose premises are either definitions, self-evident truths, or propositions already established. See **LOGIC**.
- DEMONSTRATIVE**, in grammar, a term given to such pronouns as serve to indicate or point out a thing. Of this number are *hic, hæc, hoc*, among the Latins; and *this, that, these, those*, in English.
- DEMULCENTS**, among physicians, medicines good against acrimonious humours. Such are the roots of marsh-mallows, of white lilies, of liquorice, and of viper grass, the five emollient herbs, &c.
- DEMURRAGE**, in commerce, an allowance made to the master of a ship by the merchants, for staying in a port longer than the time first appointed for his departure.
- DEMURRER**, in law, a stop put to any action upon some point of difficulty which must be determined by the court, before any further proceedings can be had in the suit.
- DEN**, a syllable which added to the names of places shews them to be situated in valleys or near woods, as Tenterden.
- DENARIUS**, in Roman antiquity, the chief silver coin among the Romans, worth in our money about sevenpence three farthings. As a weight, it was the seventh part of a Roman ounce.
- DENARIUS** is also used in our law-books for an English penny.
- DENBY**, the capital of Denbyshire, in North Wales: W. long.  $3^{\circ} 30'$ , and N. lat.  $53^{\circ} 15'$ . It sends only one member to parliament.
- DENDERMOND**, a fortified town of Flanders, situated at the confluence of the rivers Scheld and Dender, twelve miles east of Ghent: E. long.  $3^{\circ} 50'$ , and N. lat.  $51^{\circ} 10'$ .
- DENDRACHATES**, in natural history, the name used by the ancients for an extremely elegant and beautiful species of agate, the ground of which is whitish, variegated with veins of a brighter white. These veins are beautifully disposed in a number of various figures, but generally in many concentric irregular circles, drawn round one or more points. It is common also, in various parts of this stone, to find very beautiful delineations of trees, mosses, sea-plants, and the like, so elegantly expressed, that many have erroneously taken them for real plants included in the substance of the stone; whence the name dendrachates.
- DENDRANATOMY**, a term used by some for a description of the various parts of trees, as root, trunk, branch, bark, wood, pith, flower, fruit, &c. See **AGRICULTURE**, Part I.
- DENDROPHORIA**, in antiquity, the carrying of boughs or branches of trees, a religious ceremony so called, because certain priests called from thence dendrophori, tree-bearers, marched in procession, carrying the branches of trees in their hands in honour of some god, as Bacchus, Cerebe, Sylvanus, &c. The college of the dendrophori is often mentioned in ancient marbles; and we frequently see in basso relievo the bacchanals represented as men carrying little shrubs or branches of trees.
- DENEB**, an Arabic term signifying tail, used by astronomers to denote several fixed stars. Thus deneb eleet, signifies the bright star in the lion's tail. Deneb adigege, that in the swan's tail, &c.
- DENIER**, a small French copper-coin, of which twelve make a sol.
- There were two kinds of deniers, the one tournois, the other parisif, whereof the latter was worth a fourth part more than the former.
- DENIZEN**, in law, an alien made a subject by the king's letters patent, otherwise called donatison, because his legitimation proceeds *ex donatione regis*, from the king's gift.
- DENMARK**, a kingdom situated between  $8^{\circ}$  and  $13^{\circ}$  of E. long. and between  $54^{\circ}$  and  $58^{\circ}$  of N. lat.: it comprehends the peninsula of Jutland, and the islands of Zeland, Funen, &c. To the king of Denmark likewise belong Norway, Iceland, and the dutchy of Holstein.
- DENNIS**, or St DENNIS, a town of France four miles north of Paris, where the kings of France are interred.
- DENOMINATOR**, in arithmetic, a term used in speaking of fractions. See **ARITHMETICK**, p. 387.
- DENS CANIS**, or DOG'S-TOOTH, in botany. See **ERYTHRONIUM**.
- DENS LEONIS**. See **LEONTODON**.
- DENSITY** of bodies, is that property directly opposite to rarity, whereby they contain such a quantity of matter under such a bulk.
- Accordingly, a body is said to have double or triple the density of another body, when their bulk being equal, the quantity of matter is in the one double or triple the quantity of matter in the other.
- DENSITY** of the air. See **PNEUMATICS**.

- DENTALIUM**, in natural history, a shell-fish belonging to the order of *vermes testacea*. The shell consists of one tubulous strait valve, open at both ends. There are eight species, distinguished by the angles, striæ, &c. of their shells.
- DENTARIA**, or **TOOTHWORT**, in botany, a genus of the tetradynamia siliquosa class. The siliqua or pod bursts open by elastic valves; the stigma is emarginated; and the calix is connivent. There are three species, only one of which, *viz.* the *bulbifera*, or *coralwort*, is a native of Britain.
- DENTATED LEAF**. See **BOTANY**, p. 640.
- DENTEX**, in ichthyology. See **SPARUS**.
- DENTILES**, or **DENTILS**, in architecture, an ornament in corniches bearing some resemblance to teeth, particularly used in the Ionic and Corinthian orders. See **ARCHITECTURE**, p. 352.
- DENTIFRICE**, in medicine, a remedy for rubbing the teeth, and purging them from sordes; and for cleansing and absterging the gums, when replete with humours. There are dentifrices of various kinds and forms; some in form of a powder composed of corals, pumice-stone, salt, allum, egg-shells, crabs-claws, hartshorn, &c. others in form of an electuary, consisting of the same powders mixt up with honey; others are in form of a liquor drawn by distillations from drying herbs, and astringent medicines, &c.
- DENTILLARIA**. See **PLUMBAGO**.
- DENTISCALPRA**, in surgery, an instrument for scouring yellow, livid, or black teeth; to which being applied, near the gums, it scrapes off the foul morbid crust.
- DENTITION**, the breeding or cutting the teeth in children. See **MEDICINE**.
- DENUNCIATION**, a solemn publication or promulgation of any thing.
- All vessels of enemies are lawful prizes, after denunciation or proclamation of war. The design of the denunciation of excommunicated persons, is that the sentence may be the more fully executed by the person's being more known.
- DENUNCIATION** at the horn, in Scots law, is that form by which a debtor, after the expiry of a charge to make payment upon letters of horning, is denounced rebel to the king for disobedience. No caption for apprehending and imprisoning the debtor can be obtained upon an expired charge of horning till he is first denounced rebel, and the horning with the executions of charge and denunciation registered. As to the other legal effects of denunciation, see **SCOTS LAW**, title 12.
- DEOBSTRUENTS**, in pharmacy, such medicines as open obstructions. See **DETERGENT**.
- DEODAND**, in our customs, implies a thing devoted or consecrated to God, for the pacification of his wrath, in case of any misfortune; as a person's coming to a violent end, without the fault of any reasonable creature; as if a horse should strike his keeper, and so kill him. In this case, the horse is to be a deodand; that is, he is to be sold, and the price distributed to the poor, as an expiation of that dreadful event.
- DEPONENT**, in Latin grammar, a term applied to verbs which have active significations, but passive terminations or conjugations, and want one of their participles passive.
- DEPONENT**, in the law of Scotland, a person who makes a deposition. See **DEPOSITION**.
- DEPOPULATION**, the act of diminishing the number of people in any country, whether by war or bad politics.
- DEPORTATION**, a sort of banishment used by the Romans, whereby some island or other place was allotted to a criminal for the place of his abode, with a prohibition not to stir out of the same on pain of death.
- DEPOSIT**, among civilians, something that is committed to the custody of a person, to be kept without any reward, and to be returned again on demand.
- DEPOSITARY**, in law, a person intrusted as keeper or guardian of a deposit.
- DEPOSITION**, in Scots law, is a contract by which one commits the custody or possession of any thing to another, to be kept for behoof of the owner, and returned on demand, or at any period specified in the contract. The owner is called the depositor, and the person to whose custody the thing is committed the depositary. See **SCOTS LAW**, title 20.
- DEPOSITION**, in law, the testimony given in court by a witness upon oath.
- DEPRECATION**, in rhetoric, a figure whereby the orator invokes the aid and assistance of some one; or prays for some great evil or punishment to befall him who speaks falsely, either himself or his adversary.
- DEPRECATORY**, or **DEPRECATIVE**, in theology, a term applied to the manner of performing some ceremonies in the form of prayer.
- The form of absolution is deprecative in the Greek church, being conceived in these terms, *May God absolve you*: whereas it is in the declarative form in the Latin church, and in some of the reformed churches, *I absolve you*.
- DEPRESSION of the pole**. See **ASTRONOMY**, and **GEOGRAPHY**.
- DEPRESSOR**, or **DEPRIMENS**, in anatomy, a name applied to several muscles, because they depress the parts they are fastened to.
- DEPRIVATION**, in the canon-law, the deposing a bishop, parson, vicar, &c. from his office and preferment.
- DEPTFORD**, a town three miles east of London, on the southern banks of the Thames; chiefly considerable for its fine docks for building ships, and the king's yard.
- DEPURATION**. See **CLARIFICATION**.
- DEPURATORY FEVER**, a name given by Sydenham to a fever which prevailed much in the years 1661, 1662, 1663, and 1664. He called it depuratory, because he observed, that nature regulated all the symptoms in such a manner, as to fit the febrile matter, prepared by proper concoction, for expulsion in a certain time, either by a copious sweat, or a freer perspiration.
- DEPUTATION**, a mission of select persons out of a company

company or body, to a prince or assembly, to treat of matters in their name.

**DEPUTY**, a person sent upon some business, by some community.

**DEPUTY** is also one that exercises an office in another's right; and the forfeiture or misdemeanor of such deputy shall cause the person whom he represents to lose his office.

**DEPUTATUS**, among the ancients, a name applied to persons employed in making of armour: and likewise to brisk active people, whose business was to take care of the wounded in engagements, and carry them off the field.

**DERBENT**, a city of Dagistan, on the western coast of the Caspian sea: E. long.  $51^{\circ}$ , and  $41^{\circ} 15'$  N. lat.

**DEREHAM**, a market-town of Norfolk, about fifteen miles west of Norwich: E. long.  $1^{\circ}$ , and N. lat.  $52^{\circ} 40'$ .

**DERIVATIVE**, in grammar, a word which is derived from another called its primitive. See **PRIMITIVE**.

Thus, *manhood* is derived from *man*, *deity* from *Deus*, and *lawyer* from *law*.

**DERMESTES**, in zoology, a genus of insects belonging to the order of coleoptera. The antennæ are clavated, with three of the joints thicker than the rest; the breast is convex; and the head is inflected below the breast. There are thirty species, distinguished by their colour, &c.

**DERNIER RESSORT**. See **RESSORT**.

**DEROGATORY**, a clause importing derogation. A derogatory clause in a testament, is a certain sentence, cipher, or secret character, which the testator inserts in his will, and of which he reserves the knowledge to himself alone, adding a condition, that no will he may make hereafter is to be reckoned valid, if this derogatory clause is not inserted expressly, and word for word. It is a precaution invented by lawyers against latter-wills extorted by violence, or obtained by suggestion.

**DERPT**, a town of Livonia, situated on the river Eimbec: E. long.  $28^{\circ} 10'$ , and N. lat.  $58^{\circ} 10'$ .

**DERVIS**, a name given to all Mahomedan monks, though of various orders. The most noted among them are the Bektashi, the Mevelevi, the Kadri, and the Seyah. The Bektashi, who are allowed to marry and live in cities and towns, are obliged, by the rules of their order, to visit remote lands, and to salute every one they meet with *gazel*, or love-songs, and with *esma*, or the invocation of the names of God, and humbly to wish him prosperity, which they do by repeating the word *eivallah*, a solemn exclamation of the wrestlers, by which the conquered yields the palm to the conqueror. The Mevelevi, so called from Mevelava their founder, are used to turn round for two or three hours together, with such swiftness that you cannot see their faces; they are great lovers of music: in their monasteries they profess great humility and poverty, and when visited make no distinction of persons; they first bring their guests coffee to drink; and if the

ways have been dirty, they wash their feet and sandals.

The Kadri, with a peculiar superstition, emaciate their bodies; they go quite naked, except their thighs, and often join hands and dance, sometimes a whole day, repeating with great vehemence, *hu! hu! hu!* (one of the names of God) till, like madmen, they fall on the ground, foaming at the mouth, and running down with sweat: the prime vizir Kupruli Achmed Pasha, thinking this sect unbecoming the Mahomedan religion, ordered it to be suppressed; but, after his death, it revived, and is at present more numerous than ever, especially at Constantinople. The Seyah are wanderers, and though they have monasteries, yet they often spend their whole life in travelling; when they are sent out, their superiors impose upon them such a quantity of money or provisions, forbidding them to come back till they have procured it, and sent it to the monastery; wherefore when a Seyah comes into a town, he cries aloud in the market-place, *Ya allah senden*, &c. *O God! give me, I pray, five thousand crowns, or a thousand measures of rice*. Many of these dervises travel over the whole Mahomedan world, entertaining the people where-ever they come, with agreeable relations of all the curiosities they have met with. There are dervises in Egypt, who live with their families, and exercise their trades, of which kind are the dancing dervises at Damascus. They are all distinguished among themselves by the different forms and colours of their habits; those of Persia wear blue; the solitaries and wanderers wear only rags of different colours; others carry on their heads a plume made of the feathers of a cock; and those of Egypt wear an octagonal badge of a greenish white alabaster at their girdles, and a high stiff cap, without any thing round it.

**DERWENT**, a river, which, taking its rise in the north riding of Yorkshire, runs south, and falls into the Ouse.

**DERWENT-WATER**, a river of Gumberland, which falls into the Irish sea below Cocker-mouth.

**DESART**, a large extent of country entirely barren, and producing nothing. In this sense some are sandy deserts, as those of Lop, Xamo, Arabia, and several others in Asia; in Africa, those of Lybia and Zara: others are stony, as the desert of Pharan in Arabia Petrea.

*The* **DESART**, absolutely so called, is that part of Arabia, south of the Holy Land, where the children of Israel wandered forty years.

**DESCANT**, in music, the art of composing in several parts. See **MUSIC**.

**DESCENDENTS**, in Scots law. The issue of a common parent *in infinitum* are called his descendents.

**DESCENSION**, in astronomy, is either right or oblique.

*Right* **DESCENSION** is an arch of the equinoctial, intercepted between the next equinoctial point and the intersection of the meridian, passing through the centre of the object, at its setting, in a right sphere.

*Oblique* **DESCENSION**, an arch of the equinoctial, intercepted

- tercepted between the next equinoctial point and the horizon, passing through the centre of the object, at its setting, in an oblique sphere.
- DESCENT**, in general, is the tendency of a body from a higher to a lower place; thus all bodies, unless otherwise determined by a force superior to their gravity, descend towards the centre of the earth. See **MECHANICS**.
- DESCENT**, or **DISCENT**, in law, an order or method whereby lands or tenements are derived to any man from his ancestors.
- DESCENT**, in genealogy, the order of succession of descendants in a line or family; or their distance from a common progenitor: thus we say, one descent, two descents, &c.
- DESCENT**, in heraldry, is used to express the coming down of any thing from above; as, a lion en descent, is a lion with his head towards the base points, and his heels towards one of the corners of the chief, as if he were leaping down from some high place.
- DESCRIPTION**, is such a strong and beautiful representation of a thing, as gives the reader a distinct view and satisfactory notion of it. See **NARRATION and Description**.
- DESEADA**, or **DESIDERADA**, one of the Caribbee-islands, subject to France, lying eastward of Guadeloupe. See **CARIBBEE**.
- DESERTER**, in a military sense, a soldier who, by running away from his regiment or company, abandons the service.
- A deserter is, by the articles of war, punishable by death, and, after conviction, is hanged at the head of the regiment he formerly belonged to, with his crime writ on his breast.
- DESERTION**, in Scots Law, when one of the married persons deserts or forsakes the other. Wilful desertion for four years together is a ground of divorce. See **SCOTS LAW**, title 6.
- DESHACHE'**, in heraldry, is where a beast has its limbs separated from its body, so that they still remain on the escutcheon, with only a small separation from their natural places.
- DESIDERATUM** is used to signify the desirable perfections in any art or science: thus, it is a desideratum with the blacksmith, to render iron fusible by a gentle heat, and yet preserve it hard enough for ordinary uses; with the glassman, and looking-glass maker, to render glass malleable; with the clock-maker, to bring pendulums to be useful where there are irregular motions, &c.
- DESIGN**, in a general sense, the plan, order, representation, or construction of a building, book, painting, &c.
- DESIGN**, in the manufactories, expresses the figures which the workman enriches his stuff, or silk, and which he copies after some painter, or eminent draughtsman, as in diaper, damask, and other flowered silk and tapestry, and the like.
- In undertaking of such kinds of figured stuffs, it is necessary, says Mons. Savary, that, before the first stroke of the shuttle, the whole design be represented

on the threads of the warp; we do not mean in colours, but with an infinite number of little pack-threads, which, being disposed so as to raise the threads of the warp, let the workmen see, from time to time, what kind of silk is to be put in the eye of the shuttle for woof. This method of preparing the work is called reading the design, and reading the figure, which is performed in the following manner: a paper is provided, considerably broader than the stuff, and of a length proportionate to what is intended to be represented thereon. This they divide lengthwise, by as many black lines as there are intended threads in the warp; and cross these lines, by others drawn breadthwise, which, with the former, make little equal squares: on the paper thus squared, the draughtsman designs his figures, and heightens them with colours, as he sees fit. When the design is finished, a workman reads it, while another lays it on the simblot.

To read the design, is to tell the person who manages the loom, the number of squares, or threads, comprised in the space he is reading, intimating at the same time, whether it is ground or figure. To put what is read on the simblot, is to fasten little strings to the several packthreads, which are to raise the threads named; and thus they continue to do till the whole design is read.

Every piece being composed of several repetitions of the same design, when the whole design is drawn, the drawer, to re-begin the design afresh, has nothing to do but to raise the little strings, with slip-knots, to the top of the simblot, which he had let down to the bottom: this he is to repeat as often as is necessary till the whole be manufactured.

The ribbon-weavers have likewise a design, but far more simple than that now described. It is drawn on paper with lines and squares, representing the threads of the warp and woof. But instead of lines, whereof the figures of the former consist, these are constituted of points only, or dots, placed in certain of the little squares, formed by the intersection of the lines. These points mark the threads of the warp that are to be raised, and the spaces left blank denote the threads that are to keep their situation: the rest is managed as in the former.

**DESIGN** is also used, in painting, for the first idea of a large work, drawn roughly, and in little, with an intention to be executed and finished in large.

Design, in painting, is the simple contour, or outlines of the figures intended to be represented, or the lines that terminate and circumscribe them: such design is sometimes drawn in crayons, or ink, without any shadows at all; sometimes it is hatched, that is, the shadows are expressed by sensible outlines, usually drawn across each other with the pen, crayon, or graver. Sometimes, again, the shadows are done with the crayon rubbed so as that there do not appear any lines: at other times, the grains or strokes of the crayon appear, as not being rubbed: sometimes the design is washed, that is, the shadows are done with a pencil in Indian ink, or some other liquor; and sometimes

times the design is coloured, that is, colours are laid on much like those intended for the grand work.

The essential requisites of a design are correctness, good taste, elegance, character, diversity, expression, and perspective. Correctness depends on the justness of the proportions, and knowledge of anatomy. Taste is a certain manner of correctness peculiar to one's self, derived either from nature, masters, or studies, or all of them united. Elegance gives a delicacy that not only strikes persons of judgment, but communicates an agreeableness that pleases universally. The character is what is peculiar to each thing, wherein there must be diversity, inasmuch that every thing has its peculiar character to distinguish it. The expression is the representation of an object, according to the circumstances it is supposed to be in. Perspective is the representation of the parts of a painting or a figure, according to the situation they are in with regard to the point of sight. The design or draught, is a part of the greatest import and extent in painting. It is acquired chiefly by genius and application, rules being of less avail here than in any other branches of the art, as colouring, &c. The principal rules that regard design are, that novices accustom themselves to copy good originals at first sight; not to use squares in drawing, lest they stint and confine their judgment; to design well from life, before they practise perspective; to learn to adjust the size of their figures to the visual angle, and the distance of the eye from the model or object; to mark out all the parts of their design before they begin to shade; to make their contours in great pieces, without taking notice of the little muscles, and other breaks; to make themselves masters of the rules of perspective; to observe the perpendicular, parallel, and distance of every stroke; to compare and oppose the parts that meet and traverse the perpendicular, so as to form a kind of square in the mind, which is the great and almost the only rule of designing justly; to have a regard not only to the model, but to the parts already designed, there being no such thing as designing with strict justness, but by comparing and proportioning every part to the first. All the other rules relate to perspective. See PERSPECTIVE.

**DESION**, the Macedonian name of the month called by the Athenians *anthestherion*.

**DESISE**, a town of France, situated on the river Loire, fifteen miles south-east of Nevers: E. long.  $3^{\circ} 32'$ , N. lat.  $46^{\circ} 48'$ .

**DESPOTICAL**, in general, denotes any thing that is uncontrouled and absolute; but is particularly used for an arbitrary government, where the power of the prince is unlimited, and his will a law to his subjects: such are those of Turkey, Persia, and most of the eastern governments; and even those of Europe, if we except the republics, our own, and the Swedish government.

**DESPOUILLE**, in heraldry, the whole case, skin, or slough of a beast, with the head, feet, tail, and all appurtenances, so that being filled and stuffed it looks like the entire creature.

**DESSAW**, a city of upper Saxony, in Germany, situated on the river Elbe, sixty miles north west of Dres-

den, and subject to the prince of Anhalt Dessaw: E. long.  $12^{\circ} 40'$ , N. lat.  $51^{\circ} 50'$ .

**DESSERT**, or **DESART**, a service of fruits and sweetmeats, usually served up last to table.

**DESSICCATIVE**, or **DESICCATIVE**, in pharmacy, an epithet applied to such topical medicines as dry up the humours flowing to a wound or ulcer.

**DESTINIES**, in mythology. See **PARCÆ**.

**DESTINY**, among philosophers and divines. See **FATE**.

**DESTRUCTION**, in general, an alteration of any thing from its natural state to one contrary to nature; whereby it is deemed the same with corruption. See **CORRUPTION**.

A chemical destruction, or corruption, is nothing but a resolution of the whole naturally mixt body into its parts.

**DESUDATION**, in medicine, a profuse and inordinate sweat, succeeded by an eruption of pustules, called *sudamina*, or heat pimples.

**DETACHMENT**, in military affairs, a certain number of soldiers drawn out from several regiments or companies equally, to be employed as the general thinks proper, whether on an attack, at a siege, or in parties to scour the country.

**DETERGENTS**, in pharmacy, such medicines as are not only softening and adhesive, but also, by a peculiar activity, conjoined with a suitable configuration of parts, are apt to abrade and carry along with them such particles as they lay hold on in their passage.

**DETERIORATION**, the impairing or rendering a thing worse: it is just the reverse of melioration. See **MELIORATION**.

**DETERMINATION**, in mechanics, signifies much the same with the tendency or direction of a body in motion. See **MECHANICS**.

**DETERMINATION**, among school-divines, is an act of divine power, limiting the agency of second causes, in every instance, to what the Deity predestinated concerning them. See **PREDESTINATION**.

**DETERSIVES**, in pharmacy. See **DETERGENTS**.

**DETHMOLD**, a town of Westphalia, in Germany, fifteen miles north of Paderborn: E. long.  $8^{\circ} 35'$ , N. lat.  $52^{\circ}$ .

**DETINUE**, in law, a writ or action that lies against one who has got goods or other things delivered to him to keep, and afterwards refuses to deliver them.

**DETONATION**, in chemistry, the noise and explosion which any substance makes upon the application of fire to it. It is also called *fulmination*. See **CHEMISTRY**.

**DETRANCHE**, in heraldry, a line bendwise, proceeding always from the dexter side, but not from the very angle, diagonally athwart the shield.

**DETTINGEN**, a village of Germany, about nine miles east of Hanau, in the circle of the upper Rhine: E. long.  $8^{\circ} 45'$ , and N. lat.  $50^{\circ} 8'$ .

**DEVA**, a port-town of Spain, situated on the bay of Biscay, forty miles east of Bilboa: W. long.  $2^{\circ} 10'$ , and N. lat.  $43^{\circ} 20'$ .

**DEVENTER**, a city of the united Provinces, and province of Overysseel, about eight miles north of Zutphen: E. long.  $6^{\circ}$ , and N. lat.  $52^{\circ} 20'$ .

**DEVICE**, among painters. See **DEVISE**.

**DEVIL**, an evil angel, one of those celestial spirits cast down from heaven for pretending to equal himself with God. The Ethiopians paint the devil white, to be even with the Europeans who paint him black. There is no mention of the word devil in the Old Testament, but only of the word Satan and Belial: nor do we meet with it in any heathen authors, in the sense it is taken among Christians, that is, as a creature revolted from God. Their theology went no farther than to evil genii, or dæmons.

Some of the American idolaters have a notion of two collateral independent beings, one of whom is good, and the other evil; which last they imagine has the direction and superintendance of this earth, for which reason they chiefly worship him: whence those that give us an account of the religion of these savages give out, with some impropriety, that they worship the devil. The Chaldeans, in like manner, believed both a good principle and an evil one, which last they imagined was an enemy to mankind.

Isaiah, speaking, according to some commentators, of the fall of the devil, calls him Lucifer, from his former elevation and state of glory: but others explain this passage of Isaiah in reference to the king of Babylon, who had been precipitated from his throne and glory. The Arabians call Lucifer, Eblis, which some think is only a diminutive or corruption of the word Diabolus.

**DEVIL-IN-A-BUSH**, in botany. See **NIGELLA**.

**DEVIL'S BIT**. See **SCABIOSA**.

**DEVINCTION**, in antiquity, a kind of love-charm, described by Virgil in his eighth eclogue: it consisted in tying certain knots, and repeating a formula of words.

**DEVISE**, or **DEVICE**, in heraldry, painting, and sculpture, any emblem used to represent a certain family, person, action, or quality; with a suitable motto, applied in a figurative sense. See **MOTTO**.

**DEVISE**, in law, the act whereby a person bequeaths his lands or tenements to another by his last will and testament.

**DEVISES**, a borough town in Wiltshire, eighteen miles north-west of Salisbury: W. long.  $2^{\circ} 6'$ , and N. lat.  $51^{\circ} 25'$ . It sends two members to parliament.

**DEUNX**, in Roman antiquity, eleven ounces, or  $\frac{7}{8}$  parts of the libra. See **LIBRA**.

**DEVOLUTION**, in law, a right acquired by succession from one to another.

**DEVONSHIRE**, a county in the west of England, bounded by the Bristol channel, on the north; by Somersetshire and Dorsetshire, on the east; by the English channel, on the south; and by Cornwall, on the west. From this county the noble family of Cavendish take the title of duke.

**DEVOTION**, a sincere ardent worship of the deity. See **PRAYER**, **ADORATION**, **WORSHIP**, &c.

**DEUTERONOMY**, a canonical book of the Old Testament, and the last of the pentateuch of Moses. See **BIBLE**.

**DEUTEROPOTMI**, in Grecian antiquity, a designation given to such of the Athenians as had been thought dead, and, after the celebration of the funeral rites, unexpectedly recovered. It was unlawful for the deu-

teropotmi to enter into the temple of the Eumenides, or to be admitted to the holy rites, till after they were purified, by being let through the lap of a woman's gown, that they might seem to be new born.

**DEUTEROSIS**, the Greek name by which the Jews called their Mischnah, or second law. See **MISCHNAH**.

**DEUX PONTS**, a city of Germany, in the palatinate of the Rhine, sixty miles north-east of Nancy: E. long.  $7^{\circ} 15'$ , and N. lat.  $49^{\circ} 25'$ .

**DEW**, a dense moist vapour, falling on the earth in form of a misting rain, while the sun is below the horizon. See **PNEUMATICS**.

**DEW-BORN**, in country affairs, a distemper in cattle, being a swelling in the body, as much as the skin can hold, so that some beasts are in danger of burbling. This distemper proceeds from the greediness of a beast to feed, when put into a rank pasture: but commonly when the grass is full of water. In this case the beast should be stirred up and down, and made to purge well: but the proper cure is bleeding in the tail; then take a grated nutmeg, with an egg, and breaking the top of the shell, put out so much of the white as you may have room to slip the nutmeg into the shell; mix them together, and then let shell and all be put down the beast's throat; that done, walk him up and down, and he will soon mend.

**DEXTANS**, in Roman antiquity, ten ounces, or  $\frac{7}{8}$  of their libra. See **LIBRA**.

**DEXTER**, in heraldry, an appellation given to whatever belongs to the right side of a shield, or coat of arms: thus we say, bend-dexter, dexter point, &c. See **BEND**, **POINT**, &c.

**DEXTROCHERE**, or **DESTROCHERE**, in heraldry, is applied to the right arm painted in a shield, sometimes naked, sometimes clothed, or adorned with a bracelet; and sometimes armed, or holding some moveable, or member used in the arms.

**DEY**, in matters of government, the sovereign prince of Algiers, answering to the bay of Tunis. See **BEY**.

**DEYNSE**, a town of Flanders, nine miles south west of Ghent: E. long.  $3^{\circ} 30'$ , N. lat.  $51^{\circ}$ .

**DIABETES**, in physic, an excessive discharge of urine, which comes away crude, and exceeds the quantity of liquids drank. See **MEDICINE**.

**DIABOLUS**. See **DEVIL**.

**DIABOLUS MARINUS**. See **RAIA**.

**DIABOLUS METELLORUM**, a title given by chemists to jupiter or tin, because, when incorporated with other metals, it renders them incapable of reduction, or at least very difficult to undergo that operation.

**DIABROSIS**, in medicine. See **ANABROSIS**.

**DIACARYON**, in pharmacy. See **DIANUCUM**.

**DIACAUSTIC CURVE**, a species of the caustic curves formed by refraction.

**DIACHYLON**, in pharmacy, an emollient digestive plaister, composed of mucilages or viscid juices drawn from certain plants.

**DIACODIUM**, in pharmacy, a syrup prepared from poppy heads. It is also called the syrupus de meconio. As it is of consequence that all the circumstances in the directions

directions for compounding this medicine, be exactly followed, we here give the method of preparing it from the London Dispensatory. Take of the heads of dried white poppies without their seeds, three pounds and a half; of water, six gallons. Slice the heads, and boil them in the water, often stirring them that they may not burn, till about a third only of the liquor is left, which will be almost all imbibed by the poppy heads: then take all from the fire, and press the liquor strongly out from the heads; in the next place, boil the liquor by itself, to about two quarts, and strain it while hot, first through a sieve, and then through a thin flannel: set it by for a night, that what fæces have passed the strainers, may subside; next morning pour off the clear liquor, and boil it with six pounds of double refined sugar, till the whole comes to the weight of nine pounds, or a little more, that it may become a syrup of a just consistence. This syrup partakes of all the virtues of the poppy.

**DIACOUSTICS**, called also **DIAPHONICS**, the consideration of the properties of refracted sound, as it passes through different mediums.

**DIADELPHIA**, in the Linnæan system of botany. See Vol. I. p. 635.

**DIADEM**, in antiquity, a head-band, or fillet, worn by kings as a badge of their royalty. It was made of silk, thread, or wool, and tied round the temples and forehead, the ends being tied behind, and let fall on the neck. It was usually white, and quite plain, though sometimes embroidered with gold, and set with pearls and precious stones. In latter times, it came to be twilled round crowns, laurels, &c. and even appears to have been worn on divers parts of the body. See **CROWN**.

**DIADÉM**, in heraldry, is applied to certain circles, or rims, serving to inclose the crowns of sovereign princes, and to bear the globe and cross, or the flower de luces for their crest. The crowns of sovereigns are bound, some with a greater, and some with a less number of diadems. The bandage about the heads of moors on shields is also called diadem, in blazoning.

**DIÆRESIS**, in surgery, an operation serving to divide and separate the part when the continuity is a hindrance to the cure.

**DIÆRESIS**, in medicine, is the consuming of the vessels of an animal body, when from some corroding cause certain passages are made, which naturally ought not to have been; or certain natural passages are dilated beyond their ordinary dimensions, so that the humours which ought to have been contained in the vessels extravasate or run out.

**DIÆRESIS**, in grammar, the division of one syllable into two, which is usually noted by two points over a letter, as *aulai* instead of *aulæ*, *dissolvienda* for *dissolvenda*.

**DIÆTETÆ**, in Grecian antiquity, a kind of judges, of which there were two sorts, the *cleroti* and *diallaacterii*. The former were public arbitrators, chosen by lot to determine all causes exceeding ten drachms, within their own tribe, and from their sentence an appeal lay to the superior courts.

The *diallaacterii*, on the contrary, were private arbitrators from whose sentence there lay no appeal, and accordingly they always took an oath to administer justice without partiality.

**DIAGLYPHICE**, the art of cutting or engraving figures on metals, such as seals, intaglias, matrices of letters, &c. or coins for medals.

**DIAGNOSTIC**, in medicine, a term given to those signs which indicate the present state of a disease, its nature and cause.

**DIAGONAL**, in geometry, a right line drawn across a quadrilateral figure, from one angle to another, by some called the diameter, and by others the diametral of the figure. See **GEOMETRY**.

**DIAGRAM**, in geometry, a scheme for explaining and demonstrating the properties of any figure, whether triangle, square, circle, &c. See **GEOMETRY**.

**DIAGRAM**, among ancient musicians. See **SCALE**.

**DIAHEXAPLA**, or **DIAHEXAPTE**, among farriers, a compound medicine, so called from its containing six ingredients, *viz.* birthwort and gentian roots, juniper-berries, bay-berries, myrrh, and ivory shavings. It is commended for colds, consumptions, purfiness, and many other disorders in horses.

**DIAL**. A dial is a plane, upon which lines are described in such a manner, that the shadow of a wire, or of the upper edge of another plane, erected perpendicularly on the former, may shew the true time of the day.

The edge of the plane by which the time of the day is found, is called the stile of the dial, which must be parallel to the earth's axis; and the line on which the said plane is erected, is called the substile.

The angle included between the substile and stile, is called the elevation, or height of the stile.

Those dials whose planes are parallel to the plane of the horizon, are called horizontal dials; and those dials whose planes are perpendicular to the plane of the horizon, are called vertical, or erect dials.

Those erect dials, whose planes directly front the north or south, are called direct north or south dials; and all other erect dials are called decliners, because their planes are turned away from the north or south.

Those dials whose planes are neither parallel nor perpendicular to the plane of the horizon, are called inclining, or reclining dials, according as their planes make acute or obtuse angles with the horizon; and if their planes are also turned aside from facing the south or north, they are called declining-inclining, or declining-reclining dials.

The intersection of the plane of the dial, with that of the meridian, passing through the stile, is called the meridian of the dial, or the hour-line of XII.

Those meridians, whose planes pass through the stile, and make angles of 15, 30, 45, 60, 75, and 90 degrees with the meridian of the place (which marks the hour-line of XII.) are called hour circles; and their intersections with the plane of the dial are called hour-lines.

In all declining dials, the substile makes an angle with

with the hour-line of XII; and this angle is called the distance of the substile from the meridian.

The declining plane's difference of longitude, is the angle formed at the intersection of the stile and plane of the dial, by two meridians; one of which passes through the hour-line of XII. and the other through the substile.

This much being premised concerning dials in general, we shall now proceed to explain the different methods of their construction.

If the whole earth  $aPc\rho$ , (Plate LXIX. fig. 1.) were it transparent, and hollow, like a sphere of glass, and had its equator divided into 24 equal parts by so many meridian semicircles,  $a, b, c, d, e, f, g$ , &c. one of which is the geographical meridian of any given place, as London (which is supposed to be at the point  $a$ ;) and if the hours of XII were marked at the equator, both upon that meridian and the opposite one, and all the rest of the hours in order on the rest of the meridians, those meridians would be the hour-circles of London: then, if the sphere had an opaque axis, as  $PE\rho$ , terminating in the poles  $P$  and  $\rho$ , the shadow of the axis would fall upon every particular meridian and hour, when the sun came to the plane of the opposite meridian, and would consequently shew the time at London, and at all other places on the meridian of London.

If this sphere was cut through the middle by a solid plane  $ABCD$ , in the rational horizon of London, one half of the axis  $EP$  would be above the plane, and the other half below it; and if straight lines were drawn from the centre of the plane, to those points where its circumference is cut by the hour-circles of the sphere, those lines would be the hour-lines of a horizontal dial for London: for the shadow of the axis would fall upon each particular hour-line of the dial, when it fell upon the like hour-circle of the sphere.

If the plane which cuts the sphere be upright, as  $AFCG$ , fig. 2. touching the given place (London) at  $F$ , and directly facing the meridian of London, it will then become the plane of an erect direct south dial: and if right lines be drawn from its center  $E$ , to those points of its circumference where the hour-circles of the sphere cut it, these will be the hour-lines of a vertical or direct south dial for London, to which the hours are to be set as in the figure (contrary to those on a horizontal dial), and the lower half  $E\rho$  of the axis will cast a shadow on the hour of the day in this dial, at the same time that it would fall upon the like hour-circle of the sphere, if the dial-plane was not in the way.

If the plane (still facing the meridian) be made to incline, or recline, any given number of degrees, the hour-circles of the sphere will still cut the edge of the plane in those points to which the hour-lines must be drawn straight from the center; and the axis of the sphere will cast a shadow on these lines at the respective hours. The like will still hold, if the plane be made to decline by any given number of degrees from the meridian toward the east or west: provided the declination be less than 90 degrees, or the reclination be less than the co-latitude of the place: and the axis of the sphere will be a gnomon, or stile, for the dial. But it cannot be a gnomon, when

the declination is quite 90 degrees, nor when the reclination is equal to the co-latitude; because in these two cases, the axis has no elevation above the plane of the dial.

And thus it appears, that the plane of every dial represents the plane of some great circle upon the earth; and the gnomon the earth's axis, whether it be a small wire, as in the above figures, or the edge of a thin plate, as in the common horizontal dials.

The whole earth, as to its bulk, is but a point, if compared to its distance from the sun: and therefore, if a small sphere of glass be placed upon any part of the earth's surface, so that its axis be parallel to the axis of the earth, and the sphere have such lines upon it, and such planes within it, as above described; it will shew the hours of the day as truly as if it were placed at the earth's center, and the shell of the earth were as transparent as glass.

But because it is impossible to have a hollow sphere of glass perfectly true, blown round a solid plane; or if it was, we could not get at the plane within the glass to set it in any given position; we make use of a wire-sphere to explain the principles of dialing, by joining 24 semicircles together at the poles, and putting a thin flat plate of brass within it.

A common globe, of 12 inches diameter, has generally 24 meridian semicircles drawn upon it. If such a globe be elevated to the latitude of any given place, and turned about until one of these meridians cut the horizon in the north point, where the hour of XII is supposed to be marked, the rest of the meridians will cut the horizon at the respective distances of all the other hours from XII. Then if these points of distance be marked on the horizon, and the globe be taken out of the horizon, and a flat board or plate be put into its place, even with the surface of the horizon; and if straight lines be drawn from the center of the board, to those points of distance on the horizon which were cut by the 24 meridian semicircles, these lines will be the hour-lines of a horizontal dial for that latitude, the edge of whose gnomon must be in the very same situation that the axis of the globe was, before it was taken out of the horizon: that is, the gnomon must make an angle with the plain of the dial, equal to the latitude of the place for which the dial is made.

If the pole of the globe be elevated to the co-latitude of the given place, and any meridian be brought to the north point of the horizon, the rest of the meridians will cut the horizon in the respective distances of all the hours from XII, for a direct south dial, whose gnomon must be an angle with the plane of the dial, equal to the co-latitude of the place; and the hours must be set the contrary way on this dial to what they are on the horizontal.

But if your globe have more than 24 meridian semicircles upon it, you must take the following method for making *horizontal* and *south dials*.

Elevate the pole to the latitude of your place, and turn the globe until any particular meridian (suppose the first) comes to the north point of the horizon, and the opposite meridian will cut the horizon in the south. Then, set the hour-index to the uppermost XII on its circle;



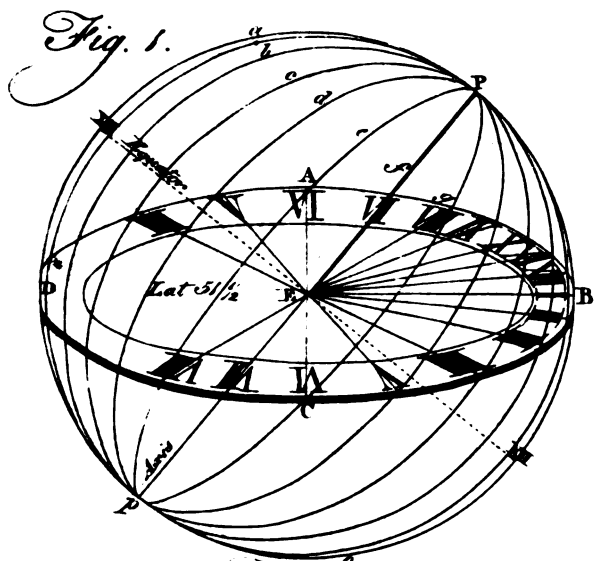


Fig. 3.

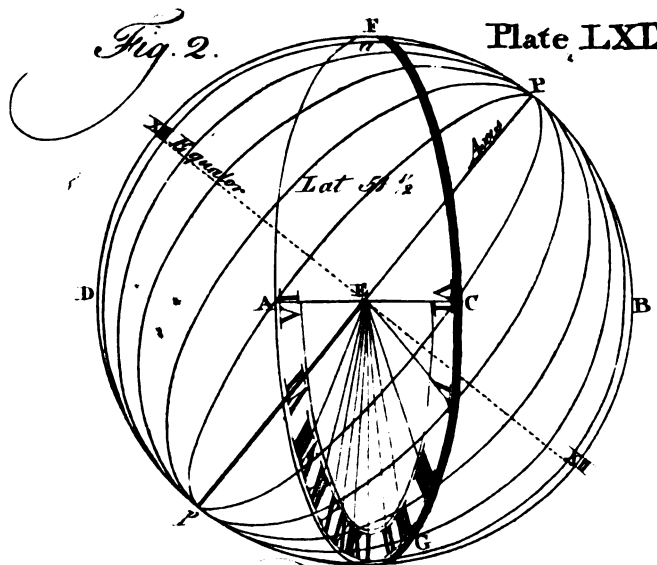


Fig. 4.

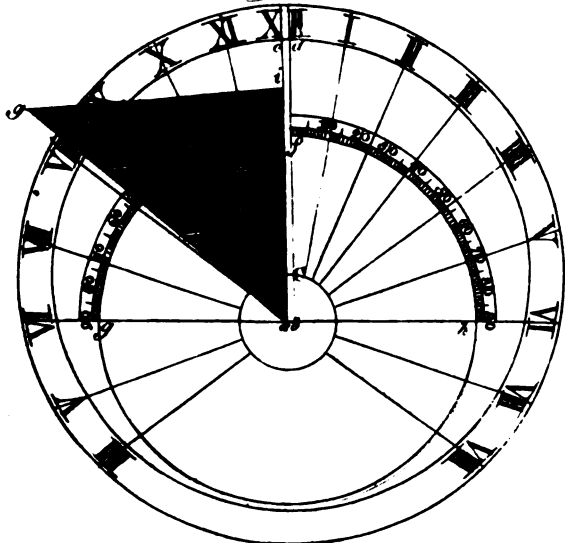


Fig. 5.

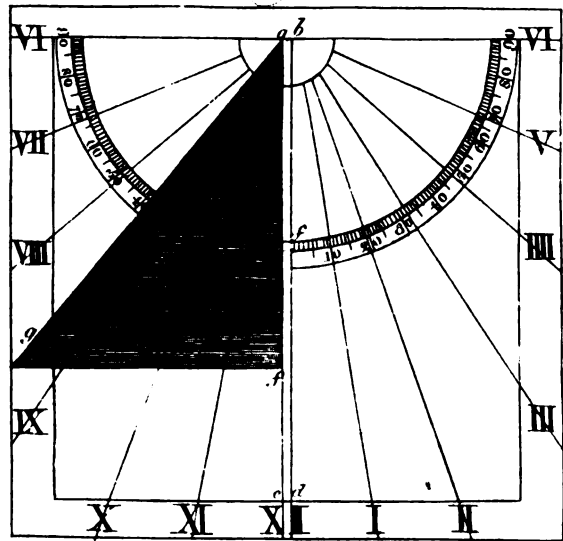
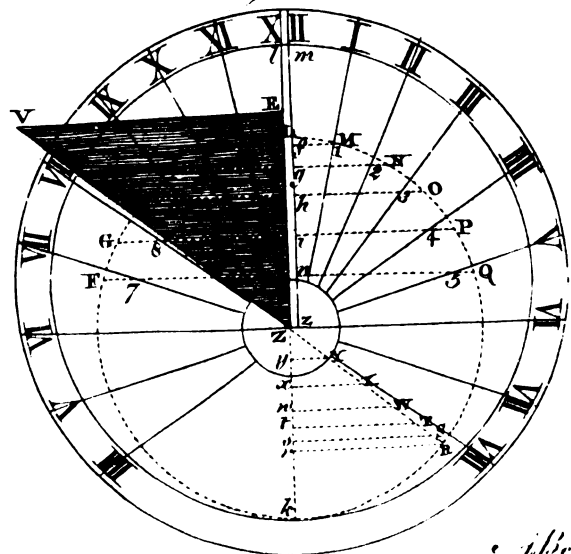
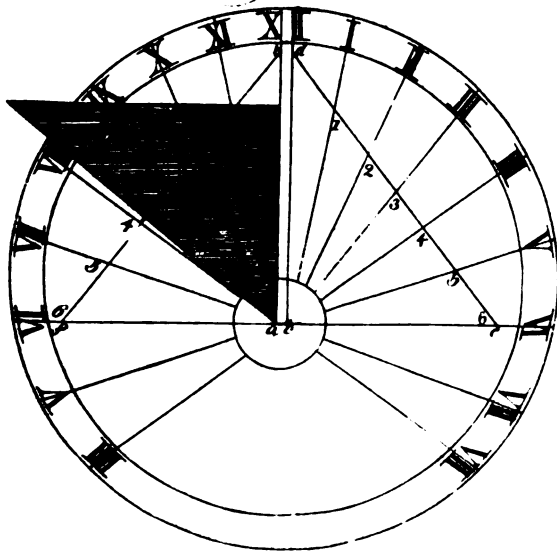


Fig. 6.



*J. Bell's design.*



circle; which done, turn the globe westward until 15 degrees of the equator pass under the brazen meridian, and then the hour-index will be at I (for the sun moves 15 degrees every hour) and the first meridian will cut the horizon in the number of degrees from the north point, that I is distant from XII. Turn on, until other 15 degrees of the equator pass under the brazen meridian, and the hour-index will then be at II, and the first meridian will cut the horizon in the number of degrees that II is distant from XII: and so, by making 15 degrees of the equator pass under the brazen meridian for every hour, the first meridian of the globe will cut the horizon in the distances of all the hours from XII to VI, which is distant just 90 degrees; and then you need go no farther, for the distances of XI, X, IX, VIII, VII, and VI, in the forenoon, are the same from XII, as the distances of I, II, III, IIII, V, and VI, in the afternoon: and these hour-lines continued through the center, will give the opposite hour-lines on the other half of the dial.

Thus, to make a horizontal dial for the latitude of London, which is  $51\frac{1}{2}$  degrees north, elevate the north pole of the globe  $51\frac{1}{2}$  degrees above the north point of the horizon, and then turn the globe, until the first meridian (which is that of London on the English terrestrial globe) cuts the north point of the horizon, and set the hour-index to XII at noon.

Then turning the globe westward until the index points successively to I, II, III, IIII, V, and VI, in the afternoon, or until 15, 30, 45, 60, 75, and 90 degrees of the equator pass under the brazen meridian, you will find that the first meridian of the globe cuts the horizon in the following numbers of degrees from the north towards the east, *viz.*  $11\frac{3}{4}$ ,  $24\frac{1}{2}$ ,  $38\frac{1}{2}$ ,  $53\frac{1}{2}$ ,  $71\frac{1}{2}$ , and 90; which are the respective distances of the above hours from XII upon the plane of the horizon.

To transfer these, and the rest of the hours, to a horizontal plane, draw the parallel right lines  $a c$  and  $d b$ , (Plate LXIX, fig. 3.) upon that plane, as far from each other as is equal to the intended thickness of the gnomon or stile of the dial, and the space included between them will be the meridian or twelve o'clock line on the dial. Cross this meridian at right angles with the six o'clock line  $g b$ , and setting one foot of your compasses in the intersection  $a$ , as a center, describe the quadrant  $g e$  with any convenient radius or opening of the compasses: then, setting one foot in the intersection  $b$ , as a center, with the same radius describe the quadrant  $f h$ , and divide each quadrant into 90 equal parts or degrees, as in the figure.

Because the hour-lines are less distant from each other about noon, than in any other part of the dial, it is best to have the centers of these quadrants at a little distance from the center of the dial-plane, on the side opposite to XII, in order to enlarge the hour-distances thereabouts, under the same angles on the plane. Thus, the center of the plane is at  $C$ , but the centers of the quadrants are at  $a$  and  $b$ .

Lay a ruler over the point  $b$  (and keeping it there for the center of all the afternoon hours in the quadrant  $f b$ ) draw the hour-line of I through  $11\frac{3}{4}$  degrees in the quadrant; the hour-line of II, through  $24\frac{1}{2}$  degrees; of

III, through  $38\frac{1}{2}$  degrees; IIII, through  $53\frac{1}{2}$ ; and V, through  $71\frac{1}{2}$ ; and because the sun rises about four in the morning, on the longest days at London, continue the hour-lines of IIII and V in the afternoon through the center  $b$  to the opposite side of the dial.—This done, lay the ruler to the center  $a$  of the quadrant  $e g$ , and through the like divisions or degrees of that quadrant, *viz.*  $11\frac{3}{4}$ ,  $24\frac{1}{2}$ ,  $38\frac{1}{2}$ ,  $53\frac{1}{2}$ , and  $71\frac{1}{2}$ , draw the forenoon hour-lines of XI, X, IX, VIII, and VII; and because the sun sets not before eight in the evening on the longest days, continue the hour-lines of VII and VIII in the forenoon, through the center  $a$ , to VII and VIII in the afternoon; and all the hour lines will be finished on this dial; to which the hours may be set, as in the figure.

Lastly, through  $51\frac{1}{2}$  degrees of either quadrant, and from its center, draw the right line  $a g$  for the hypotenuse or axis of the gnomon  $a g i$ ; and from  $g$ , let fall the perpendicular  $g i$ , upon the meridian line  $a i$ , and there will be a triangle made, whose sides are  $a g$ ,  $g i$ , and  $i a$ . If a plate similar to this triangle be made as thick as the distance between the lines  $a c$  and  $b d$ , and set upright between them, touching at  $a$  and  $b$ , its hypotenuse  $a g$  will be parallel to the axis of the world, when the dial is truly set; and will cast a shadow on the hour of the day.

*N. B.* The trouble of dividing the two quadrants may be saved, if you have a scale with a line of chords upon it, such as that on the top of Plate LXX.: for if you extend the compasses from 0 to 60 degrees of the line of chords, and with that extent, as a radius, describe the two quadrants upon their respective centers, the above distances may be taken with the compasses upon the line, and set off upon the quadrants.

*To make an erect direct south dial,* Plate LXIX, fig. 4. Elevate the pole to the co-latitude of your place, and proceed in all respects as above taught for the horizontal dial, from VI in the morning to VI in the afternoon, and the hours must be reverted, as in the figure; and the hypotenuse  $a g$  of the gnomon  $a g f$ , must make an angle with the dial-plane equal to the co-latitude of the place. As the sun can shine no longer on this dial than from six in the morning until six in the evening, there is no occasion for having any more than twelve hours upon it.

*To make an erect dial, declining from the south towards the east or west.* Elevate the pole to the latitude of your place, and screw the quadrant of altitude to the zenith. Then, if your dial declines towards the east (which we shall suppose it to do at present) count in the horizon the degrees of declination, from the east point towards the north, and bring the lower end of the quadrant to that degree of declination at which the reckoning ends. This done, bring any particular meridian of your globe (as suppose the first meridian) directly under the graduated edge of the upper part of the brazen meridian, and set the hour index to XII at noon. Then, keeping the quadrant of altitude at the degree of declination in the horizon, turn the globe eastward on its axis, and observe the degrees cut by the first meridian in the quadrant of altitude (counted from the zenith) as the hour index comes to

to XI, X, IX, &c. in the forenoon, or as 15, 30, 45, &c. degrees of the equator pass under the brazen meridian at these hours respectively; and the degrees then cut in the quadrant by the first meridian, are the respective distances of the forenoon hours from XII on the plane of the dial.—Then, for the afternoon hours, turn the quadrant of altitude round the zenith until it comes to the degree in the horizon opposite to that where it was placed before: namely, as far from the west point of the horizon towards the south, as it was set at first from the east point towards the north; and turn the globe westward on its axis, until the first meridian comes to the brazen meridian again, and the hour-index to XII: then, continue to turn the globe westward, and as the index points to the afternoon hours I, II, III, &c. or as 15, 30, 45, &c. degrees of the equator pass under the brazen meridian, the first meridian will cut the quadrant of altitude in the respective number of degrees from the zenith that each of these hours is from XII on the dial.—And note, that when the first meridian goes off the quadrant at the horizon in the forenoon, the hour-index shews the time when the sun will come upon this dial: and when it goes off the quadrant in the afternoon, the index will point to the time when the sun goes off the dial.

Having thus found all the hour-distances from XII, lay them down upon your dial plane, either by dividing a femicircle into two quadrants of 90 degrees each (beginning at the hour-line of XII) or by the line of chords, as above directed.

In all declining dials, the line on which the stile or gnomon stands (commonly called the *substile-line*) makes an angle with the twelve o'clock line, and falls among the forenoon hour-lines, if the dial declines towards the east; and among the afternoon hour-lines, when the dial declines towards the west; that is, to the left hand from the twelve o'clock line in the former case, and to the right hand from it in the latter.

To find the distance of the substile from the twelve o'clock line; if your dial declines from the south toward the east, count the degrees of that declination in the horizon from the east point toward the north, and bring the lower end of the quadrant of altitude to that degree of declination where the reckoning ends: then, turn the globe until the first meridian cuts the horizon in the like number of degrees, counted from the south point toward the east; and the quadrant and first meridian will then cross one another at right angles, and the number of degrees of the quadrant, which are intercepted between the first meridian and the zenith, is equal to the distance of the substile line from the twelve o'clock line; and the number of degrees of the first meridian, which are intercepted between the quadrant and the north pole, is equal to the elevation of the stile above the plane of the dial.

If the dial declines westward from the south, count that declination from the east point of the horizon towards the south, and bring the quadrant of altitude to the degree in the horizon at which the reckoning ends; both for finding the forenoon hours, and distance of the substile from the meridian: and for the afternoon hours, bring the quadrant to the opposite degree in the horizon, namely, as far from the west towards the north, and then proceed in all respects as above.

Thus, we have finished our declining dial; and in so doing, we made four dials, *viz.*

1. A north dial, declining eastward by the same number of degrees. 2. A north dial, declining the same number west. 3. A south dial, declining east. And, 4. a south dial declining west. Only, placing the proper number of hours, and the stile or gnomon respectively, upon each plane. For (as above mentioned) in the south-west plane, the substilar-line falls among the afternoon hours; and in the south-east, of the same declination, among the forenoon hours, at equal distances from XII. and so, in all the morning hours on the west decliner, will be like the afternoon hours on the east decliner: the south-east decliner will produce the north-west decliner; and the south-west decliner, the north east decliner, by only extending the hour-lines, stile and substile, quite through the center: the axis of the stile (or edge that casts the shadow on the hour of the day) being in all dials whatever parallel to the axis of the world, and consequently pointing towards the north pole of the heaven in north latitudes, and toward the south pole in south latitudes.

But because every one who would like to make a dial, may perhaps not be provided with a globe to assist him, and may probably not understand the method of doing it by logarithmic calculation; we shall shew how to perform it by the plain dialling lines, or scale of latitudes and hours; such as those on the top of Plate LXX. and which may be had on scales commonly sold by the mathematical instrument makers.

This is the easiest of all mechanical methods, and by much the best, when the lines are truly divided: and not only the half hours and quarters may be laid down by all of them, but every fifth minute by most, and every single minute by those where the line of hours is a foot in length.

Having drawn your double meridian line *ab, cd*, (Plate LXIX. fig. 5.) on the plane intended for a horizontal dial, and crossed it at right angles by the six o'clock line *fe* (as in fig. 31.) take the latitude of your place with the compasses, in the scale of latitudes, and set that extent from *c* to *e*, and from *a* to *f*, on the six o'clock line: then, taking the whole six hours between the points of the compasses in the scale of hours, with that extent set one foot in the point *c*, and let the other foot fall where it will upon the meridian line *cd*, as at *d*. Do the same from *f* to *b*, and draw the right lines *ed* and *fb*, each of which will be equal in length to the whole scale of hours. This done, setting one foot of the compasses in the beginning of the scale at XII, and extending the other to each hour on the scale, lay off these extents from *d* to *e* for the afternoon hours, and from *b* to *f* for those of the forenoon: this will divide the lines *de* and *bf* in the same manner as the hour-scale is divided at 1, 2, 3, 4, and 6; on which the quarters may also be laid down, if required. Then, laying a ruler on the point *c*, draw the first five hours in the afternoon, from that point, through the dots at the numeral figures 1, 2, 3, 4, 5, on the line *de*; and continue the lines of III and V through the center *c* to the other side of the dial, for the like hours of the morning: which done, lay the ruler on the point *a*, and draw the last five hours in the forenoon through the dots 5, 4, 3,

2, 1, on the line  $fb$ ; continuing the hour-lines of VII and VIII through the center  $a$  to the other side of the dial, for the like hours of the evening; and set the hours to their respective lines, as in the figure. Lastly, make the gnomon the same way as taught above for the horizontal dial, and the whole will be finished.

To make an erect south dial, take the co-latitude of your place from the scale of latitudes, and then proceed in all respects for the hour-lines, as in the horizontal dial; only reversing the hours, as in fig. 4. and making the angle of the stile's height equal to the co-latitude.

But lest the young dialist should have neither globe nor wooden scale, we shall now shew him how he may make a dial without any of these helps. Only, if he has not a line of chords, he must divide a quadrant into 90 equal parts or degrees for taking the proper angle of the stile's elevation; which is easily done.

With any opening of the compasses, as  $ZL$ , describe the two semicircles  $LFk$  and  $LQk$ , upon the centers  $Z$  and  $z$ , where the six o'clock line crosses the double meridian line, and divide each semicircle into 12 equal parts, beginning at  $L$  (though, strictly speaking, only the quadrants from  $L$  to the six o'clock line need be divided;) then connect the divisions which are equidistant from  $L$ , by the parallel lines  $KM$ ,  $IN$ ,  $HO$ ,  $GP$ , and  $FQ$ . Draw  $VZ$  for the hypotenuse of the stile, making the angle  $VZE$  equal to the latitude of your place; and continue the line  $VZ$  to  $R$ . Draw the line  $Rr$  parallel to the six o'clock line, and set off the distance  $aK$  from  $Z$  to  $Y$ , the distance  $bI$  from  $Z$  to  $X$ ,  $cH$  from  $Z$  to  $W$ ,  $dG$  from  $Z$  to  $T$ , and  $eF$  from  $Z$  to  $S$ . Then draw the lines  $Ss$ ,  $Tt$ ,  $Ww$ ,  $Xx$ , and  $Yy$ , each parallel to  $Rr$ . Set off the distance  $yT$  from  $a$  to  $11$ , and from  $s$  to  $1$ ; the distance  $xx$  from  $b$  to  $10$ , and from  $g$  to  $2$ ;  $wW$  from  $c$  to  $9$ , and from  $h$  to  $3$ ;  $tT$  from  $d$  to  $8$ , and from  $i$  to  $4$ ;  $sS$  from  $e$  to  $7$ , and from  $n$  to  $5$ . Then laying a ruler to the center  $Z$ , draw the forenoon hour-lines through the points  $11$ ,  $10$ ,  $9$ ,  $8$ ,  $7$ ; and laying it to the center  $z$ , draw the afternoon lines through the points  $1$ ,  $2$ ,  $3$ ,  $4$ ,  $5$ ; continuing the forenoon lines of VII and VIII through the center  $Z$ , to the opposite side of the dial, for the like afternoon hours; and the afternoon lines IIII and V through the center  $z$ , to the opposite side, for the like morning hours. Set the hours to these lines as in the figure, and then erect the stile or gnomon, and the horizontal dial will be finished.

To construct a south dial, draw the line  $VZ$ , making an angle with the meridian  $ZL$  equal to the co-latitude of your place; and proceed in all respects as in the above horizontal dial for the same latitude, reversing the hours as in fig. 4. and making the elevation of the gnomon equal to the co-latitude.

Perhaps it may not be unacceptable to explain the method of constructing the dialing lines, and some others; which is as follows.

With any opening of the compasses, (Plate LXX. fig. 1.) as  $EA$ , according to the intended length of the scale, describe the circle  $ADCB$ , and cross it at right angles by the diameters  $CEA$  and  $DEB$ . Divide the quadrant  $AB$  first into 9 equal parts, and then each part into 10; so shall the quadrant be divided into 90 equal parts or de-

grees. Draw the right line  $AFB$  for the chord of this quadrant, and setting one foot of the compasses in the point  $A$ , extend the other to the several divisions of the quadrant, and transfer these divisions to the line  $AFB$  by the arcs 10, 10, 20, &c. and this will be a line of chords, divided into 90 unequal parts; which, if transferred from the line back again to the quadrant, will divide it equally. It is plain by the figure, that the distance from  $A$  to 60 in the line of chords, is just equal to  $AE$ , the radius of the circle from which that line is made; for if the arc 60, 60 be continued, of which  $A$  is the center, it goes exactly through the center  $E$  of the arc  $AB$ .

And therefore, in laying down any number of degrees on a circle, by the line of chords, you must first open the compasses so, as to take in just 60 degrees upon that line, as from  $A$  to 60: and then, with that extent, as a radius, describe a circle, which will be exactly of the same size with that from which the line was divided: which done, set one foot of the compasses in the beginning of the chord line, as at  $A$ , and extend the other to the number of degrees you want upon the line; which extent, applied to the circle, will include the like number of degrees upon it.

Divide the quadrant  $CD$  into 90 equal parts, and from each point of division draw right lines, as  $i$ ,  $k$ ,  $l$ , &c. to the line  $CE$ ; all perpendicular to that line, and parallel to  $DE$ , which will divide  $EC$  into a line of sines; and although these are seldom put among the dialing lines on a scale, yet they assist in drawing the line of latitudes. For if a ruler be laid upon the point  $D$ , and over each division in the line of sines, it will divide the quadrant  $CB$  into 90 unequal parts, as  $Ba$ ,  $Bb$ , &c. shewn by the right line  $10a$ ,  $20b$ ,  $30c$ , &c. drawn along the edge of the ruler. If the right line  $BC$  be drawn, subtending this quadrant, and the nearest distances  $Ba$ ,  $Bb$ ,  $Bc$ , &c. be taken in the compasses from  $B$ , and set upon this line in the same manner as directed for the line of chords, it will make a line of latitudes  $BC$ , equal in length to the line of chords  $AB$ , and of an equal number of divisions, but very unequal as to their lengths.

Draw the right line  $DGA$ , subtending the quadrant  $DA$ ; and parallel to it, draw the right line  $rs$ , touching the quadrant  $DA$  at the numeral figure 3. Divide this quadrant into six equal parts, as 1, 2, 3, &c. and through these points of division draw right lines from the centre  $E$  to the line  $rs$ , which will divide it at the points where the six hours are to be placed, as in the figure. If every sixth part of the quadrant be subdivided into four equal parts, right lines drawn from the centre through these points of division, and continued to the line  $rs$ , will divide each hour upon it into quarters.

In Fig. 2. Plate LXX. we have the representation of a portable dial, which may be easily drawn on a card, and carried in a pocket-book. The lines  $ad$ ,  $ab$ , and  $bc$  of the gnomon must be cut quite through the card; and as the end  $ab$  of the gnomon is raised occasionally above the plane of the dial, it turns upon the uncut line  $cd$  as on a hinge. The line dotted  $AB$  must be slit quite through the card, and the thread  $C$  must be put through the slit, and have a knot tied behind, to keep it from being easily drawn out. On the other end of this thread

thread is a small plummet *D*, and on the middle of it a small bead for shewing the hour of the day.

To rectify this dial, set the thread in the slit right against the day of the month, and stretch the thread from the day of the month over the angular point where the curve-lines meet at XII; then shift the bead to that point on the thread, and the dial will be rectified.

To find the hour of the day, raise the gnomon (no matter how much or how little) and hold the edge of the dial next the gnomon towards the sun, so as the uppermost edge of the shadow of the gnomon may just cover the shadow-line; and the bead then playing freely on the face of the dial, by the weight of the plummet, will shew the time of the day among the hour-lines, as it is forenoon or afternoon.

To find the time of sun-rising and setting, move the thread among the hour-lines, until it either covers some one of them, or lies parallel betwixt any two; and then it will cut the time of sun-rising among the forenoon hours, and of sun-setting among the afternoon hours, for that day of the year to which the thread is set in the scale of months.

To find the sun's declination, stretch the thread from the day of the month over the angular point at XII, and it will cut the sun's declination, as it is north or south, for that day, in the proper scale.

To find on what days the sun enters the signs: when the bead, as above rectified, moves along any of the curve-lines which have the signs of the zodiac marked upon them, the sun enters those signs on the days pointed out by the thread in the scale of months.

The construction of this dial is very easy, especially if the reader compares it all along with fig. 3. as he reads the following explanation of that figure.

Draw the occult line, (Plate LXX. fig. 9.) *AB* parallel to the top of the card, and cross it at right angles with the six o'clock line *ECD*; then upon *C*, as a centre, with the radius *CA*, describe the semicircle *AEL*, and divide it into 12 equal parts (beginning at *A*) as *A*, *A*, &c. and from these points of division draw the hour-lines *r*, *s*, *t*, *u*, *v*, *E*, *w*, and *x*, all parallel to the six o'clock line *EG*. If each part of the semicircle be subdivided into four equal parts, they will give the half-hour lines and quarters, as in fig. 2. Draw the right-line *ASD*, making the angle *SAB* equal to the latitude of your place. Upon the centre *A* describe the arch *RST*, and set off upon it the arcs *SR* and *ST*, each equal to  $23\frac{1}{2}$  degrees, for the sun's greatest declination; and divide them into  $23\frac{1}{2}$  equal parts, as in fig. 2. Through the intersection *D* of the lines *ECD* and *AD*, draw the right line *FDG* at right angles to *AD*. Lay a ruler to the points *A* and *R*, and draw the line *ARF* through  $23\frac{1}{2}$  degrees of south declination in the arc *SR*; and then laying the ruler to the points *A* and *T*, draw the line *ATG* through  $23\frac{1}{2}$  degrees of north declination in the arc *ST*: so shall the lines *ARF* and *ATG* cut the line *FDG* in the proper length for the scale of months. Upon the centre *D*, with the radius *DE*, describe the semicircle *FoG*; which divide into six equal parts, *Fm*, *mn*, *no*, &c. and from these points of division draw the right lines *mh*, *ni*, *pk*, and *ql*, each parallel to

*oD*. Then setting one foot of the compasses in the point *F*, extend the other to *A*, and describe the arc *AzH* for the tropic of  $\Psi$ : with the same extent, setting one foot in *G*, describe the arc *AEO* for the tropic of  $\Phi$ . Next setting one foot in the point *b*, and extending the other to *A*, describe the arc *ACI* for the beginnings of the signs  $\Upsilon$  and  $\uparrow$ ; and with the same extent, setting one foot in the point *i*, describe the arc *AN* for the beginnings of the signs  $\Upsilon$  and  $\Omega$ . Set one foot in the point *i*, and having extended the other to *A*, describe the arc *AK* for the beginnings of the signs  $\chi$  and  $\mathfrak{M}$ ; and with the same extent, set one foot in *k*, and describe the arc *HM* for the beginnings of the signs  $\vartheta$  and  $\mathfrak{M}$ . Then setting one foot in the point *D*, and extending the other to *A*, describe the curve *AL* for the beginnings of  $\Psi$  and  $\Omega$ ; and the signs will be finished. This done, lay a ruler from the point *A* over the sun's declination in the arch *RST*; and where the ruler cuts the line *FDG*, make marks; and place the days of the months right against these marks, in the manner shewn by fig. 2. Lastly, draw the shadow-line *PQ* parallel to the occult line *AB*; make the gnomon, and set the hours to their respective lines, as in fig. 2. and the dial will be finished.

There are several kinds of dials, which are called *universal*, because they serve for all latitudes. Of these, the best is Mr Pardie's, (Plate LXX. fig. 4.) which consists of three principal parts; the first whereof is called the horizontal plane (*A*), because in practice it must be parallel to the horizon. In this plane is fixed an upright pin, which enters into the edge of the second part *BD*, called the meridional plane; which is made of two pieces, the lowest whereof (*B*) is called the quadrant, because it contains a quarter of a circle, divided into 90 degrees; and it is only into this part, near *B*, that the pin enters. The other piece is a semicircle (*D*) adjusted to the quadrant, and turning in it by a groove, for raising or depressing the diameter (*EF*) of the semicircle, which diameter is called the axis of the instrument. The third piece is a circle (*G*), divided on both sides into 24 equal parts, which are the hours. This circle is put upon the meridional plane so, that the axis (*EF*) may be perpendicular to the circle, and the point *C* be the common centre of the circle, semicircle, and quadrant. The straight edge of the semicircle is chamfered on both sides to a sharp edge, which passes through the centre of the circle. On one side of the chamfered part, the first six months of the year are laid down, according to the sun's declination for their respective days, and on the other other side the last six months. And against the days on which the sun enters the signs, there are straight lines drawn upon the semicircle, with the characters of the signs marked upon them. There is a black line drawn along the middle of the upright edge of the quadrant, over which hangs a thread (*H*), with its plummet (*I*), for levelling the instrument. *N. B.* From the twenty-third of September to the twentieth of March, the upper surface of the circle must touch both the centre *C* of the semicircle, and the line of  $\Psi$  and  $\Omega$ ; and from the twentieth of March to the twenty-third of September, the lower surface of the circle must touch that centre and line.

To

To find the time of the day by this dial. Having set it on a level place in sun-shine, and adjusted it by the leveling screws *k* and *l*, until the plumb-line hangs over the black line upon the edge of the quadrant, and parallel to the said edge; move the semicircle in the quadrant, until the line of  $\varphi$  and  $\underline{\alpha}$  (where the circle touches) comes to the latitude of your place in the quadrant: then turn the whole meridional plane *BD*, with its circle *G*, upon the horizontal plane *A*, until the edge of the shadow of the circle falls precisely on the day of the month in the semicircle; and then, the meridional plane will be due north and south, the axis *EF* will be parallel to the axis of the world, and will cast a shadow upon the true time of the day, among the hours on the circle.

*N. B.* As, when the instrument is thus rectified, the quadrant and semicircle are in the plane of the meridian, so the circle is then in the plane of the equinoctial. Therefore, as the sun is above the equinoctial in summer (in northern latitudes) and below it in winter; the axis of the semicircle will cast a shadow on the hour of the day, on the upper surface of the circle, from the twentieth of March to the twenty-third of September: and from the twenty-third of September to the twentieth of March, the hour of the day will be determined by the shadow of the semicircle, upon the lower surface of the circle. In the former case, the shadow of the circle falls upon the day of the month, on the lower part of the diameter of the semicircle; and in the latter case, on the upper part.

The method of laying down the months and signs upon the semicircle is as follows. Draw the right line *ACB*, equal to the diameter of the semicircle *ADB*, and cross it in the middle at right angles with the line *ECD*, equal in length to *ADB*; then *EC* will be the radius of the circle *FCG*, which is the same as that of the semicircle. Upon *E*, as a centre, describe the circle *FCG*, on which set off the arcs *Cb* and *Ci*, each equal to  $23\frac{1}{2}$  degrees, and divide them accordingly into that number, for the sun's declination. Then, laying the edge of a ruler over the centre *E*, and also over the sun's declination for every fifth day of each month (as in the card dial) mark the points on the diameter *AB* of the semicircle from *a* to *g*, which are cut by the ruler; and there place the days of the months accordingly, answering to the sun's declination. This done, setting one foot of the compasses in *C*, and extending the other to *a* or *g*, describe the semicircle *abcdesfg*; which divide into six equal parts, and through the points of division draw right lines, parallel to *CD*, for the beginning of the lines (of which one half are on one side of the semicircle, and the other half on the other) and set the characters of the signs to their proper lines, as in the figure.

Having shewn how to make sun-dials by the assistance of a good globe, or of a dialing-scale, we shall now proceed to the method of constructing dials arithmetically; which will be more agreeable to those who have learned the elements of trigonometry, because globes and scales can never be so accurate as the logarithms in finding the angular distances of the hours. Yet, as a globe may be

found exact enough for some other requisites in dialing, we shall take it in occasionally.

The construction of sun-dials on all planes whatever, may be included in one general rule: intelligible, if that of a horizontal dial for any given latitude be well understood. For there is no plane, however obliquely situated with respect to any given place, but what is parallel to the horizon of some other place; and therefore, if we can find that other place by a problem on the terrestrial globe, or by a trigonometrical calculation, and construct a horizontal dial for it; that dial, applied to the plane where it is to serve, will be a true dial for that place.—Thus, an erect direct south dial in  $51\frac{1}{2}$  degrees north latitude, would be a horizontal dial on the same meridian, 90 degrees southward of  $51\frac{1}{2}$  degrees north latitude; which falls in with  $38\frac{1}{2}$  degrees of south latitude. But if the upright plane declines from facing the south at the given place, it would still be a horizontal plane 90 degrees from that place, but for a different longitude, which would alter the reckoning of the hours accordingly.

### C A S E I.

1. LET us suppose, that an upright plane at London declines 36 degrees westward from facing the south; and that it is required to find a place on the globe, to whose horizon the said plane is parallel; and also the difference of longitude between London and that place.

Rectify the globe to the latitude of London, and bring London to the zenith under the brass meridian, then that point of the globe which lies in the horizon at the given degree of inclination (counted westward from the south point of the horizon) is the place at which the above-mentioned plane would be horizontal.—Now, to find the latitude and longitude of that place, keep your eye upon the place, and turn the globe eastward, until it comes under the graduated edge of the brass meridian; then, the degrees of the brass meridian that stands directly over the place, is its latitude; and the number of degrees in the equator, which are intercepted between the meridian of London and the brass meridian, is the place's difference of longitude.

Thus, as the latitude of London is  $51\frac{1}{2}$  degrees north, and the declination of the place is 36 degrees west; elevate the north pole  $51\frac{1}{2}$  degrees above the horizon, and turn the globe until London comes to the zenith, or under the graduated edge of the meridian; then count 36 degrees on the horizon westward from the south point, and make a mark on that place of the globe over which the reckoning ends, and bringing the mark under the graduated edge of the brass meridian, it will be found to be under  $30\frac{1}{2}$  degrees in south latitude: keeping it there, count in the equator the number of degrees between the meridian of London and the brass meridian (which now becomes the meridian of the required place) and you will find it to be  $42\frac{1}{2}$ . Therefore an upright plane at London, declining 36 degrees westward from the south, would be a horizontal plane at that place, whose latitude is  $30\frac{1}{2}$  degrees south of the equator, and longitude  $42\frac{1}{2}$  degrees west of the meridian of London.

Which difference of longitude being converted into time, is 2 hours 51 minutes.

The vertical dial declining westward 36 degrees at London, is therefore to be drawn in all respects as a horizontal dial for south latitude 30½ degrees; save only, that the reckoning of the hours is to anticipate the reckoning on the horizontal dial, by 2 hours 51 minutes: for so much sooner will the sun come to the meridian of London, than to the meridian of any place whose longitude is 42½ degrees west from London.

2. But to be more exact than the globe will shew us, we shall use a little trigonometry.

Let *NESW* (Plate LXX. fig. 6.) be the horizon of London, whose zenith is *Z*, and *P* the north pole of the sphere; and let *Zb* be the position of a vertical plane at *Z*, declining westward from *S* (the south) by an angle of 36 degrees; on which plane an erect dial for London at *Z* is to be described. Make the semidiameter *ZD* perpendicular to *Zb*, and it will cut the horizon in *D*, 36 degrees west of the south *S*. Then a plane, in the tangent *HD*, touching the sphere in *D*, will be parallel to the plane *Zb*; and the axis of the sphere will be equally inclined to both these planes.

Let *WQE* be the equinoctial, whose elevation above the horizon of *Z* (London) is 38½ degrees; and *PRD* be the meridian of the place *D*, cutting the equinoctial in *R*. Then it is evident, that the arc *RD* is the latitude of the place *D* (where the plane *Zb* would be horizontal) and the arc *RQ* is the difference of longitude of the planes *Zb* and *DH*.

In the spherical triangle *WDR*, the arc *WD* is given, for it is the complement of the plane's declination from *S* to south; which complement is 54° (viz. 90°—36°) the angle at *R*, in which the meridian of the place *D* cuts the equator, is a right angle; and the angle *RWD* measures the elevation of the equinoctial above the horizon of *Z*, namely, 38½ degrees. Say therefore, as radius is to the co-sine of the plane's declination from the south, so is the co-sine of the latitude of *Z* to the sine of *RD* the latitude of *D*: which is of a different denomination from the latitude of *Z*, because *Z* and *D* are on different sides of the equator.

As radius . . . . . 10.00000  
 To co-sine 36° 0' = *RQ* 9.90796  
 So co-sine 51° 30' = *QZ* 9.79415

To sine 30° 14' = *DR* (9.70211) = the lat. of *D*, whose horizon is parallel to the vertical plane *Zb* at *Z*.

*N. B.* When radius is made the first term, it may be omitted, and then, by subtracting it mentally from the sum of the other two, the operation will be shortened. Thus, in the present case,

To the logarithmic sine of *WR* = \* 54° 0' 9.90796  
 Add the logarithmic sine of *RD* = † 38° 30' 9.79415  
 Their sum — radius . . . . . 9.70211

\* The co-sine of 36. 0. or of *RQ*.  
 † The co-sine of 51. 30. or of *QZ*.

give the same solution as above. And we shall keep to this method in the following part of this article.

To find the difference of longitude of the places *D* and *Z*, say, as radius is to the co-sine of 38½ degrees, the height of the equinoctial at *Z*, so is the co-tangent of 36 degrees, the plane's declination, to the co-tangent of the difference of longitudes. Thus,

To the logarithmic sine of \* 51° 30' 9.89354  
 Add the logarithmic tang. of † 54° 0' 10.13874

Their sum — radius . . . . . 10.013228  
 is the nearest tangent of 47° 8' = *WR*; which is the co-tangent of 42° 52' = *RQ*, the difference of longitude sought. Which difference, being reduced to time, is two hours 51½ minutes.

3. And thus having found the exact latitude and longitude of the place *D*, to whose horizon the vertical plane at *Z* is parallel, we shall proceed to the construction of a horizontal dial for the place *D*, whose latitude is 30° 14' south; but anticipating the time at *D* by 2 hours 51 minutes (neglecting the ½ minute in practice) because *D* is so far westward in longitude from the meridian of London; and this will be a true vertical dial at London, declining westward 36 degrees.

Assume any right line *CSL*, (Plate LXX fig. 7.) for the substile of the dial, and make the angle *KCP* equal to the latitude of the place (viz. 30° 14') To whose horizon the plane of the dial is parallel; then *CRP* will be the axis of the stile, or edge that casts the shadow on the hours of the day, in the dial. This done, draw the conjoining line *EQ*, cutting the substilar line at right angles in *K*; and from *K* make *KR* perpendicular to the axis *CRP*. Then *KG* (= *KR*) being made radius, that is, equal to the chord of 60° or tangent of 45° on a good sector, take 42° 52' (the difference of longitude of the places *Z* and *D*) from the tangents, and having set it from *K* to *M*, draw *CM* for the hour-line of XII. Take *KN*, equal to the tangent of an angle less by 15° degrees than *KM*; that is, the tangent 27° 52'; and through the point *N* draw *CN* for the hour-line of I. The tangent of 12° 52' (which is 15° less than 27° 52') set off the same way, will give a point between *K* and *N*, through which the hour-line of II is to be drawn. The tangent of 2° 8' (the difference between 45° and 42° 52') placed on the other side of *CL*, will determine the point through which the hour-line of III is to be drawn: to which 2° 8', if the tangent of 15° be added, it will make 17° 8'; and this set off from *K* towards *Q* on the line *EQ*, will give a point for the hour-line of IIII: and so of the rest.—The forenoon hour lines are drawn the same way, by the continual addition of the tangents 15°, 30°, 45°, &c. to 42° 52' (=the tangent of *KM*) for the hours of XI, X, IX, &c. as far as necessary; that is, until there be five hours on each side of the substile. The sixth hour, accounted from that hour or part of the hour on which the substile falls, will be always in a line perpendicular to the substile, and drawn through the center *C*.

\* The co-sine of 38. 30. or of *WDR*.  
 † The co-tangent of 36. 0. or of *DW*.



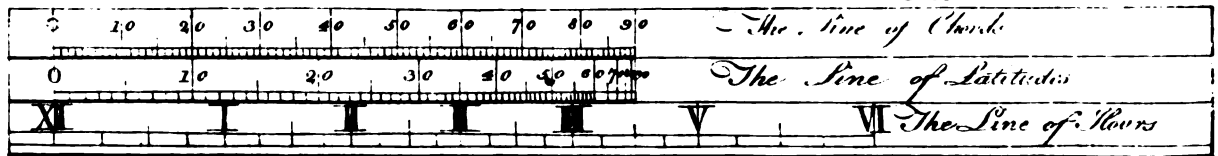
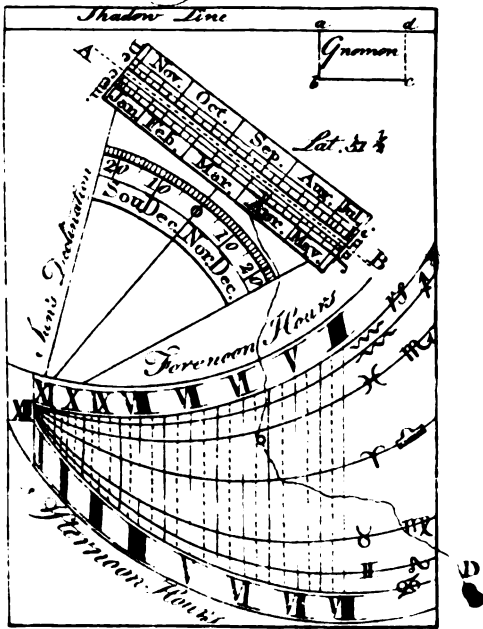


Fig. 2.





4. In all erect dials, *CM*, the hour-line of XII, is perpendicular to the horizon of the place for which the dial is to serve: for that line is the intersection of a vertical plane with the plane of the meridian of the place, both which are perpendicular to the plane of the horizon: and any line *NO*, or *ho*, perpendicular to *CM*, will be a horizontal line on the plane of the dial, along which line the hours may be numbered; and *CM* being set perpendicular to the horizon, the dial will have its true position.

5. If the plane of the dial had declined by an equal angle toward the east, its description would have differed only in this, that the hour-line of XII would have fallen on the other side of the substile *GL*, and the line *HO* would have a subcontrary position to what it has in this figure.

6. And these two dials, with the upper points of their stiles turned toward the north pole, will serve for other two planes parallel to them; the one declining from the north toward the east, and the other from the north toward the west, by the same quantity of angle. The like holds true of all dials in general, whatever be their declination and obliquity of their planes to the horizon.

C A S E II.

7. If the plane of the dial not only declines, but also reclines, or inclines. Suppose its declination from fronting the south *S*, (Plate LXXI. fig. 1.) be equal to the arc *SD* on the horizon; and its reclination be equal to the arc *Dd* of the vertical circle *DZ*: then it is plain, that if the quadrant of altitude *ZdD* on the globe cuts the point *D* in the horizon, and the reclination is counted upon the quadrant from *D* to *d*; the intersection of the hour circle *PRd*, with the equinoctial *WQF*, will determine *Rd*, the latitude of the place *d*, whose horizon is parallel to the given plane at *Z*; and *RQ* will be the difference in longitude of the planes at *d* and *Z*.

Trigonometrically thus: let a great circle pass through the three points *W*, *d*, *E*; and in the triangle *Wdd*, right-angled at *D*, the sides *WD* and *Dd* are given; and thence the angle *DWd* is found, and so is the hypotenuse *Wd*. Again, the difference, or the sum, of *DWd* and *DWR*, the elevation of the equinoctial above the horizon of *Z*, gives the angle *dWR*; and the hypotenuse of the triangle *WRd* was just now found; whence the sides *Rd* and *WR* are found, the former being the latitude of the place *d*, and the latter the complement of *RQ*, the difference of longitude sought.

Thus, if the latitude of the place *Z* be  $52^{\circ} 10'$  north; the declination *SD* of the plane *Zh* (which would be horizontal at *d*) be  $36^{\circ}$ , and the reclination be  $15^{\circ}$ , or equal to the arc *Dd*; the south latitude of the place *d*, that is, the arc *Rd*, will be  $15^{\circ} 9'$ ; and *RQ*, the difference of longitude,  $36^{\circ} 2'$ . From these data, therefore, let the dial (fig. 2.) be described, as in the former example.

\* That is, of  $15, 30, 45, 60, 75^{\circ}$ , for the hours of I, II, III, IIII, V in the afternoon; and XI, X, IX, VIII, VII in the afternoon. † In all horizontal dials, and erect north or south dials, the substile and meridian are the same; but in all declining dials, the substile line makes an angle with the meridian. ‡ In which case, the radius *CK* is supposed to be divided into 1000000 equal parts.

9. There are several other things requisite in the practice of dialing; the chief of which shall be given in the form of arithmetical rules, simple and easy to those who have learned the elements of trigonometry. For in practical arts of this kind, arithmetick should be used as far as it can go; and scales never trusted to, except in the final construction, where they are absolutely necessary in laying down the calculated hour-distances on the plain of the dial.

RULE I. To find the angles which the hour-lines on any dial make with the substile.

To the logarithmic sine of the given latitude, or of the stile's elevation above the plane of the dial, add the logarithmic tangent of the hour \* distance from the meridian, or from the † substile; and the sum minus radius will be the logarithmic tangent of the angle sought.

For, in fig. 7. Plate LXX. *KC* is to *KM* in the ratio compounded of the ratio of *KC* to *KG* (= *KR*) and of *KG* to *KM*; which, making *CK* the radius 10,000000, or 10,0000, or 10, or 1, are the ratio of 10,000000, or of 10,0000, or of 10, or of 1, to *KG*  $\times$  *KM*.

Thus, in a horizontal dial, for latitude  $51^{\circ} 30'$ , to find the angular distance of XI in the forenoon, or I in the afternoon, from XII.

To the logarithmic sine of  $51^{\circ} 30'$  9.89354 ‡  
Add the logarithmic tang. of  $15^{\circ} 0'$  9.42595

The sum — radius is - - - - - 9.32159 = the logarithmic tangent of  $11^{\circ} 50'$ , or of the angle which the hour-line of XI or I makes with the hour of XII.

And by computing in this manner, with the sine of the latitude, and the tangents of  $30, 45, 60,$  and  $75^{\circ}$ , for the hours of II, III, IIII, and V in the afternoon; or of X, IX, VIII, and VII in the forenoon; you will find their angular distances from XII to be  $24^{\circ} 18', 38^{\circ} 3', 53^{\circ} 35'$  and  $71^{\circ} 6'$ ; which are all that there is occasion to compute for. — And these distances may be set off from XII by a line of chords; or rather, by taking 1000 from a scale of equal parts, and setting that extent as a radius from *C* to XII; and then, taking 209 of the same parts (which, in the tables, are the natural tangent of  $11^{\circ} 50'$ ) and setting them from XII to XI and to I, on the line *bo*, which is perpendicular to *CXII*: and so for the rest of the hour-lines, which, in the table of natural tangents, against the above distances, are 451, 782, 1355, and 2920, of such equal parts from XII, as the radius *CXII* contains 1000. And lastly, set off 1257 (the natural tangent of  $51^{\circ} 30'$ ) for the angle of the stile's height, which is equal to the latitude of the place.

RULE II. The latitude of the place, the sun's declination, and his hour-distance from the meridian, being given; to find (1.) his altitude; (2.) his azimuth.

1. I. et

1. Let  $d$ , (Plate LXXI. fig. 1.) be the sun's place,  $dR$ , his declination; and in the triangle  $PZd$ ,  $Pd$  the sum, or the difference, of  $dR$ , and the quadrant  $PR$ , being given by the supposition, as also the complement of the latitude  $PZ$ , and the angle  $dPZ$ , which measures the horary distance of  $d$  from the meridian; we shall (by Case 4. of Keill's oblique spheric Trigonometry) find the base  $Zd$ , which is the sun's distance from the zenith, or the complement of his altitude.

And (2.) As sine  $Zd$ : sine  $Pd$  ::  $dPZ$  :  $dZP$ , or of its supplement  $DZS$ , the azimuthal distance from the south.

Or, the practical rule may be as follows.

Write  $A$  for the sign of the sun's altitude,  $L$  and  $l$  for the sine and co-sine of the latitude,  $D$  and  $d$  for the sine and co-sine of the sun's declination, and  $H$  for the sine of the horary distance from VI.

Then the relation of  $H$  to  $A$  will have three varieties.

1. When the declination is toward the elevated pole, and the hour of the day is between XII and VI; it is

$$A = LD + Hld, \text{ and } H = \frac{A - LD}{ld}$$

2. When the hour is after VI, it is  $A = LD - Hld$  and  $\frac{LD + A}{ld}$

3. When the declination is toward the depressed pole, we have  $A = Hld - LD$ , and  $H = \frac{A + LD}{ld}$

Which theorems will be found useful, and expeditious enough for solving those problems in geography and dialing, which depend on the relation of the sun's altitude to the hour of the day.

E X A M P L E I.

Suppose the latitude of the place to be  $51\frac{1}{2}$  degrees north: the time five hours distant from XII, that is, an hour after VI in the morning, or before VI in the evening; and the sun's declination  $20^\circ$  north. *Required the sun's altitude?*

Then to log.  $L = \log. \sin. 51^\circ 30'$  1.89354\*  
 add log.  $D = \log. \sin. 20^\circ 0'$  1.53405

Their sum 1.42759 gives

$LD =$  logarithm of 0.267664, in the natural sines.

And, to log.  $H = \log. \sin. \dagger 15^\circ 0'$  1.41300

add  $\left\{ \begin{array}{l} \log. l = \log. \sin. \ddagger 38^\circ 0' \\ \log. d = \log. \sin. * 70^\circ 0' \end{array} \right.$  1.79415

1.97300

Their sum 1.18015 gives

$Hld =$  logarithm of 0.151408, in the natural sines.

And these two numbers (0.267664 and 0.151408) make 0.419072 =  $A$ ; which, in the table, is the nearest natural sine of  $24^\circ 47'$ , the sun's altitude sought.

The same hour-distance being assumed on the other side of VI, then  $LD - Hld$  is 0.116256, the sine of  $6^\circ$

\* Here we consider the radius as unity, and not 10,00000, by which, instead of the index 9, we have—1, as above; which is of no farther use, than making the work a little easier.  
 † The distance of one hour from VI.  
 ‡ The co-latitude of the place.  
 \* The co-declination of the sun.

$40\frac{1}{2}$ ; which is the sun's altitude at V in the morning, or VII in the evening, when his north declination is  $20^\circ$ .

But when the declination is  $20^\circ$  south (or towards the depressed pole) the difference  $Hld - LD$  becomes negative, and thereby shews that, an hour before VI in the morning, or past VI in the evening, the sun's center is  $6^\circ 40\frac{1}{2}$  below the horizon.

E X A M P L E II.

From the same data to find the sun's azimuth.

If  $H$ ,  $L$  and  $D$  are given, then (by par. 2. of Rule II.) from  $H$  having found the altitude and its complement  $Zd$ ; and the arc  $Pd$  (the distance from the pole) being given; say, As the co-sine of the altitude is to the sine of the distance from the pole, so is the sine of the hour-distance from the meridian to the sine of the azimuth distance from the meridian.

Let the latitude be  $51^\circ 30'$  north, the declination  $15^\circ 9'$  south, and the time II h. 24. m. in the afternoon, when the sun begins to illuminate a vertical wall, and it is required to find the position of the wall.

Then, by the foregoing theorems, the complement of the altitude will be  $81^\circ 32\frac{1}{2}'$ , and  $Pd$  the distance from the pole being  $109^\circ 5'$ , and the horary distance from the meridian, or the angle  $dPZ$ ,  $36^\circ$ .

To log. sin.  $74^\circ 51'$  - - - - 1.98464  
 Add log. sin.  $36^\circ 0'$  - - - - 1.76922

And from the sum - - - - 1.75386

Take the log. sin.  $81^\circ 32\frac{1}{2}'$  - - - 1.99525

Remains 1.75861 = log. sin.

$35^\circ$ , the azimuth distance sought.

When the altitude is given, find from thence the hour, and proceed as above.

This praxis is of singular use on many occasions; in finding the declination of vertical planes more exactly than in the common way, especially if the transits of the sun's center is observed by applying a ruler with sights, either plain or telescopic, to the wall or plane, whose declination is required.—In drawing a meridian line, and finding the magnetic variation.—In finding the bearings of places in terrestrial surveys; the transits of the sun over any place, or his horizontal distance from it being observed, together with the altitude and hour.—And thence determining small differences of longitude.—In observing the variation at sea, &c.

*Of the double horizontal dial; and the Babylonian and Italian dials.*

To the *gnomonic* projection, there is sometimes added a *stereographic* projection of the hour-circles, and the parallels of the sun's declination, on the same horizontal plane; the upright side of the gnomon being sloped into an edge, standing perpendicularly over the center of the projection: so that the dial, being in its due position, the shadow

Fig. 1.

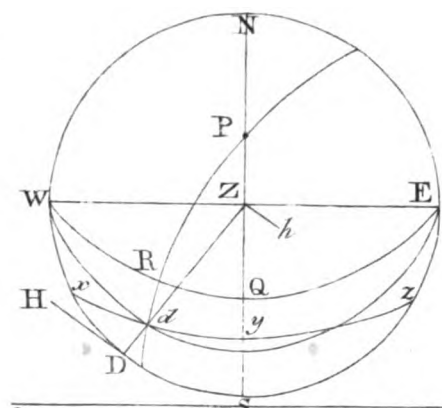


Fig. 2.

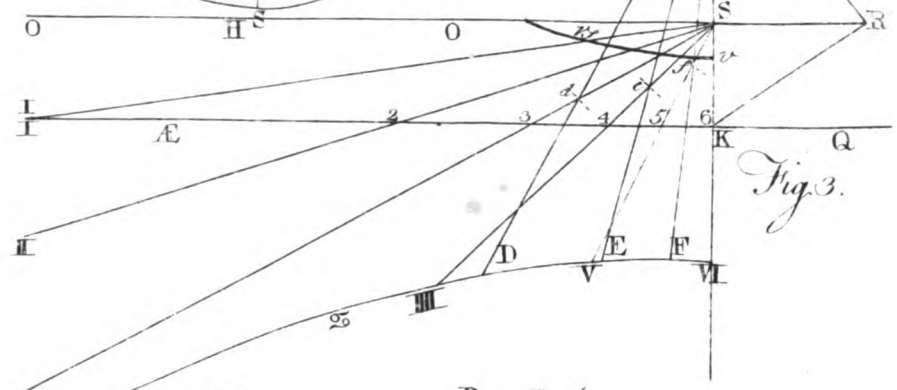
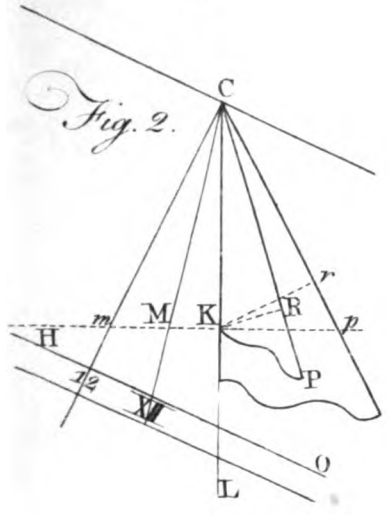
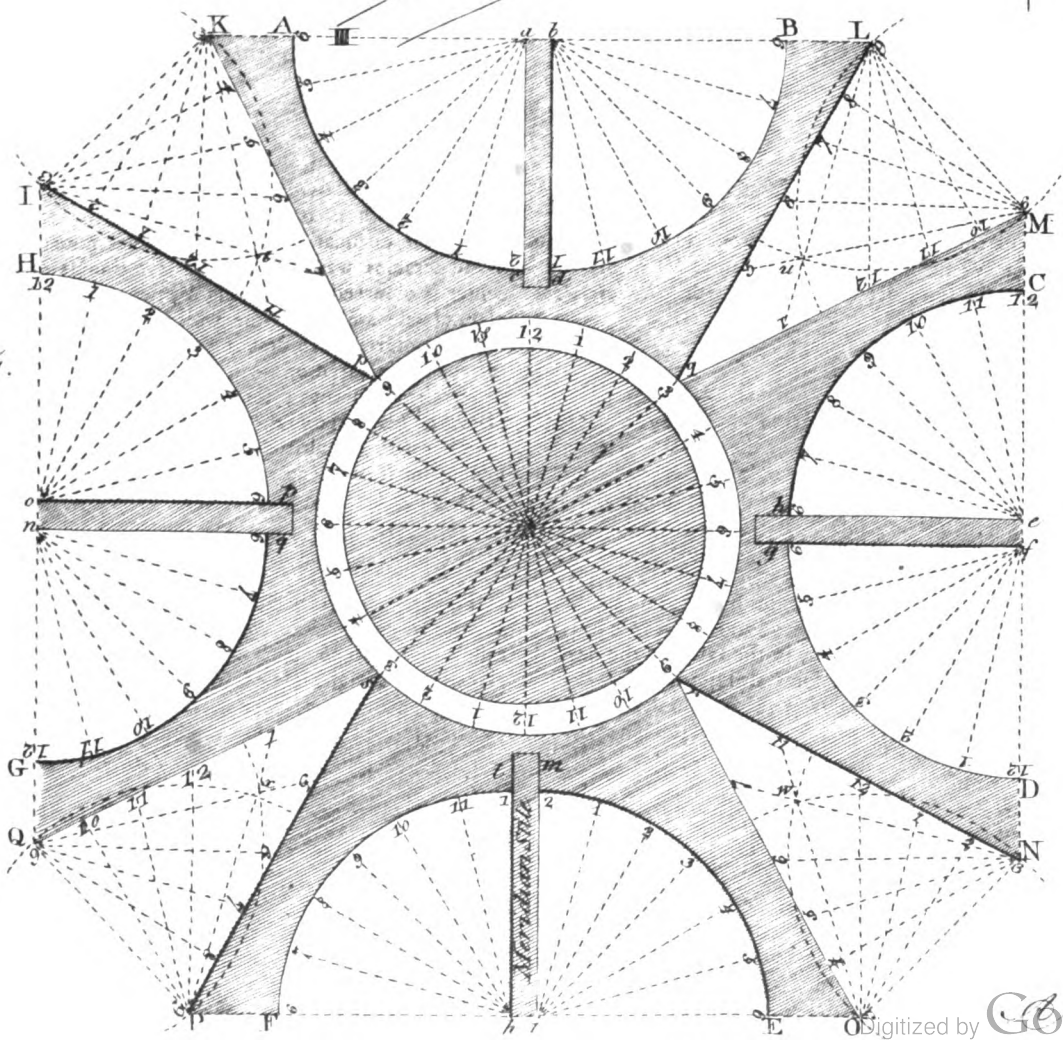


Fig. 3.

Fig. 4.





shadow of *that* perpendicular edge is a vertical circle passing through the sun, in the stereographic projection.

The months being duly marked on this dial, the sun's declination, and the length of the day at any time, are had by inspection (as also his altitude, by means of a scale of tangents.) But its chief property is, that it may be placed true, whenever the sun shines, without the help of any other instrument.

Let  $d$  (Plate LXXI. fig. 1.) be the sun's place in the stereographic projection,  $x d y z$  the parallel of the sun's declination.  $Z d$  a vertical circle through the sun's center,  $P d$  the hour-circle; and it is evident, that the diameter  $NS$  of this projection being placed duly north and south, these three circles will pass through the point  $d$ . And therefore, to give the dial its due position, we have only to turn its gnomon toward the sun, on a horizontal plane, until the hour on the common gnomonic projection coincides with that marked by the hour-circle  $P d$ , which passes through the intersection of the shadow  $Z d$  with the circle of the sun's present declination.

The *Babylonian* and *Italian* dials reckon the hours, not from the meridian, as with us, but from the sun's rising and setting. Thus, in *Italy*, an hour before sun-set is reckoned the 23d hour; two hours before sun-set, the 22d hour; and so of the rest. And the shadow that marks them on the hour-lines, is *that* of the point of a stile. This occasions a perpetual variation between their dials and clocks, which they must correct from time to time, before it arises to any sensible quantity, by setting their clocks so much faster or slower. And in *Italy*, they begin their day, and regulate their clocks, not from sun-set, but from about mid-twilight, when the *Ave Maria* is said; which corrects the difference that would otherwise be between the clock and the dial.

The improvements which have been made in all sorts of instruments and machines for measuring time, have rendered such dials of little account. Yet, as the theory of them is ingenious, and they are really, in some respects, the best contrived of any for vulgar use, a general idea of their description may not be unacceptable.

Let fig. 5. represent an erect south wall, on which a *Babylonian dial* is to be drawn, shewing the hours from sun-rising; the latitude of the place, whose horizon is parallel to the wall, being equal to the angle  $\angle ACR$ . Make, as for a common dial,  $KG = KR$  (which is perpendicular to  $CR$ ) the radius of the equinoctial  $AEQ$ , and draw  $RS$  perpendicular to  $CK$  for the stile of the dial; the shadow of whose point  $R$  is to mark the hours, when  $SR$  is set upright on the plane of the dial.

Then it is evident, that, in the contingent line  $AEQ$ , the spaces  $K 1, K 2, K 3, \&c.$  being taken equal to the tangents of the hour-distances from the meridian, to the radius  $KG$ , one, two, three,  $\&c.$  hours after sun-rising, on the equinoctial day; the shadow of the point  $R$  will be found, at these times, respectively in the points, 1, 2, 3,  $\&c.$

Draw, for the like hours after sun-rising, when the sun is in the tropic of Capricorn  $WV$ , the like common lines  $CD, CE, CF, \&c.$  and at these hours the shadow of the point  $R$  will be found in those lines respectively. Find the sun's altitudes above the plane of the dial at these

hours, and with their co-tangents  $Sd, Se, Sf, \&c.$  to radius  $SR$ , describe arcs intersecting the hour-lines in the points  $d, e, f, \&c.$  so shall the right lines 1  $d, 2 e, 3 f, \&c.$  be the lines of I, II, III,  $\&c.$  hours after sun-rising.

The construction is the same in every other case, due regard being had to the difference of longitude of the place at which the dial would be horizontal, and the place for which it is to serve: And likewise, taking care to draw no lines but what are necessary; which may be done partly by the rules already given for determining the time that the sun shines on any plane; and partly from this, that on the tropical days, the hyperbola described by the shadow of the point  $R$  limits the extent of all the hour-lines.

*Of the right placing of dials, and having a true meridian line for the regulating of clocks and watches.*

The plane on which the dial is to rest being duly prepared, and every thing necessary for fixing it, you may find the hour tolerably exact by a large equinoctial ring-dial, and set your watch to it. And then the dial may be fixed by the watch at your leisure.

If you would be more exact, take the sun's altitude by a good quadrant, noting the precise time of observation by a clock or watch. Then compute the time for the altitude observed, and set the watch to agree with that time, according to the sun. A *Hadley's* quadrant is very convenient for this purpose; for, by it you may take the angle between the sun and his image reflected from a basin of water; the half of which angle, subtracting the refraction, is the altitude required. This is best done in summer, and the nearer the sun is to the prime vertical (the east or west azimuth) when the observation is made, so much the better.

Or, in summer, take two equal altitudes of the sun in the same day; one any time between 7 and 10 in the morning, the other between 2 and 5 in the afternoon; noting the moments of these two observations by a clock or watch: and if the watch shews the observations to be at equal distances from noon, it agrees exactly with the sun: if not, the watch must be corrected by half the difference of the forenoon and afternoon intervals; and then the dial may be set true by the watch.

Thus, for example, suppose you had taken the sun's altitude when it was 20 minutes past VIII in the morning by the watch; and found, by observing in the afternoon, that the sun had the same altitude 10 minutes before III; then it is plain, that the watch was 5 minutes too fast for the sun: for 5 minutes after XII is the middle time between VIII h. 20 m. in the morning, and III h. 50 m. in the afternoon; and therefore, to make the watch agree with the sun, it must be set back five minutes.

A good *meridian line*, for regulating clocks or watches, may be had by the following method.

Make a round hole, almost a quarter of an inch diameter, in a thin plate of metal; and fix the plate in the top of a south window, in such a manner, that it may recline from the zenith at an angle equal to the co-latitude of your place, as nearly as you can guess: for then

the plate will face the sun directly at noon on the equinoctial days. Let the sun shine freely through the hole into the room; and hang a plumb-line to the ceiling of the room, at least five or six feet from the window, in such a place as that the sun's rays, transmitted through the hole, may fall upon the line when it is noon by the clock; and having marked the said place on the ceiling, take away the line.

Having adjusted a sliding bar to a dove-tail groove, in a piece of wood about 18 inches long, and fixed a hook into the middle of the bar, nail the wood to the above-mentioned place on the ceiling, parallel to the side of the room in which the window is; the groove and bar being towards the floor. Then, hang the plumb-line upon the hook in the bar, the weight or plummet reaching almost to the floor; and the whole will be prepared for farther and proper adjustment.

This done, find the true solar time by either of the two last methods, and thereby regulate your clock. Then, at the moment of next noon by the clock, when the sun shines, move the sliding-bar in the groove, until the shadow of the plumb-line bisects the image of the sun (made by his rays transmitted through the hole) on the floor, wall, or on a white screen placed on the north side of the line; the plummet or weight at the end of the line hanging freely in a pail of water placed below it on the floor.—But because this may not be quite correct for the first time, on account that the plummet will not settle immediately, even in water; it may be farther corrected on the following days, by the above method, with the sun and clock; and so brought to a very great exactness.

*N. B.* The rays transmitted through the hole, will cast but a faint image of the sun, even on a white screen, unless the room be so darkened that no sunshine may be allowed to enter, but what comes through the small hole in the plate. And always, for some time before the observation is made, the plummet ought to be immersed in a jar of water, where it may hang freely; by which means the line will soon become steady, which otherwise would be apt to continue swinging.

*An universal dial, shewing the hours of the day by a terrestrial globe, and by the shadows of several gnomons, at the same time: together with all the places of the earth which are then enlightened by the sun; and those to which the sun is then rising, or on the meridian, or setting.*

This dial (see Plate LXXII.) is made of a thick square piece of wood, or hollow metal. The sides are cut into semicircular hollows, in which the hours are placed; the stile of each hollow coming out from the bottom thereof, as far as the ends of the hollows project. The corners are cut out into angles, in the insides of which the hours are also marked; and the edge of the end of each side of the angle serves as a stile for casting a shadow on the hours marked on the other side.

In the middle of the uppermost side, or plane, there is an equinoctial dial; in the centre whereof an upright wire is fixed, for casting a shadow on the hours of that dial, and supporting a small terrestrial globe on its top.

The whole dial stands on a pillar, in the middle of a

round horizontal board, in which there is a compass and magnetic needle, for placing the meridian stile toward the south. The pillar has a joint with a quadrant upon it, divided into 90 degrees (supposed to be hid from sight under the dial in the figure) for setting it to the latitude of any given place; the same way as already described in the dial on the cross.

The equator of the globe is divided into 24 equal parts, and the hours are laid down upon it at these parts. The time of the day may be known by these hours, when the sun shines upon the globe.

To rectify and use this dial, set it on a level table, or sole of the window, where the sun shines, placing the meridian stile due south, by means of the needle; which will be, when the needle points as far from the north fleur-de-lis toward the west, as it declines westward, at your place. Then bend the pillar in the joint, till the black line on the pillar comes to the latitude of your place in the quadrant.

The machine being thus rectified, the plane of its dial-part will be parallel to the equator, the wire or axis that supports the globe will be parallel to the earth's axis, and the north pole of the globe will point toward the north pole of the heavens.

The same hour will then be shewn in several of the hollows, by the ends of the shadows of their respective stiles: the axis of the globe will cast a shadow on the same hour of the day, in the equinoctial dial, in the centre of which it is placed, from the 20th of March to the 23d of September; and, if the meridian of your place on the globe be set even with the meridian stile, all the parts of the globe that the sun shines upon, will answer to those places of the real earth which are then enlightened by the sun. The places where the shade is just coming upon the globe, answer to all those places of the earth to which the sun is then setting; as the places where it is going off, and the light coming on, answer to all the places of the earth where the sun is then rising. And lastly, if the hour of VI be marked on the equator in the meridian of your place (as it is marked on the meridian of London in the figure) the division of the light and shade on the globe will shew the time of the day.

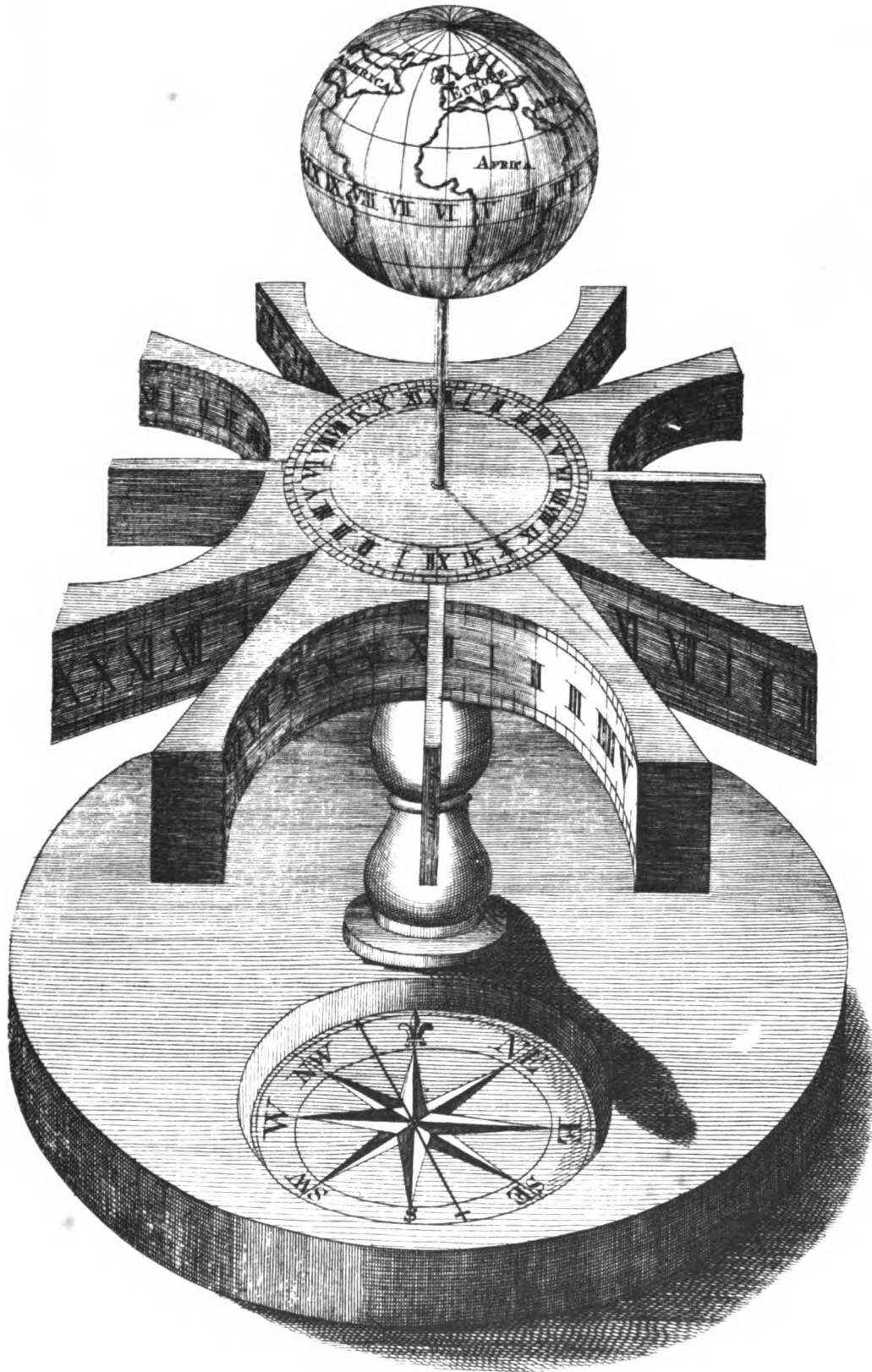
The northern stile of the dial (opposite to the southern or meridian one) is hid from sight in the figure, by the axis of the globe. The hours in the hollow to which that stile belongs, are also supposed to be hid by the oblique view of the figure: but they are the same as the hours in the front-hollow. Those also in the right and left hand semicircular hollows are mostly hid from sight; and so also are all those on the sides next the eye of the four acute angles.

The construction of this dial is as follows: (See Plate LXXI. fig. 4.)

On a thick square piece of wood, or metal, draw the lines *ac* and *bd*, as far from each other as you intend for the thickness of the stile *abcd*; and in the same manner, draw the like thickness of the other three stiles, *efgh*, *iklm*, and *nopq*, all standing outright as from the centre.

With any convenient opening of the compasses, as *aA* (so as to leave proper strength of stuff when *KI* is equal







to  $aA$ ) set one foot in  $a$ , as a centre, and with the other foot describe the quadrantal arc  $Ac$ . Then, without altering the compasses, set one foot in  $b$  as a centre, and with the other foot describe the quadrant  $dB$ . All the other quadrants in the figure must be described in the same manner, and with the same opening of the compasses, on their centres  $e, f; i, k; \text{ and } n, o$ : and each quadrant divided into six equal parts, for so many hours, as in the figure; each of which parts must be subdivided into 4, for the half hours and quarters.

At equal distances from each corner, draw the right lines  $Ip$  and  $Kp$ ,  $Lq$  and  $Mq$ ,  $Nr$  and  $Or$ ,  $P_s$  and  $Q_s$ ; to form the four angular hollows  $IpK$ ,  $LqM$ ,  $NrO$ , and  $P_sQ_s$ ; making the distances between the tips of these hollows, as  $IK$ ,  $LM$ ,  $NO$ , and  $P_sQ_s$ , each equal to the radius of the quadrants; and leaving sufficient room within the angular points  $pqr$  and  $s$ , for the equinoctial dial in the middle.

To divide the insides of these angles properly, for the hour-spaces thereon; take the following method.

Set one foot of the compasses in the point  $I$ , as a centre, and open the other to  $K$ ; and with that opening describe the arc  $Kt$ : then, without altering the compasses, set one foot in  $K$ , and with the other foot describe the arc  $It$ . Divide each of these arcs, from  $I$  and  $K$  to their intersection at  $t$ , into four equal parts; and from their centres  $I$  and  $K$ , through the points of division, draw the right lines  $I_3, I_4, I_5, I_6, I_7$ ; and  $K_2, K_1, K_{12}, K_{11}$ ; and they will meet the sides  $Kp$  and  $Ip$  of the angle  $IpK$  where the hours thereon must be placed. And these hour-spaces in the arcs must be subdivided into four equal parts, for the half-hours and quarters.—Do the like for the other three angles, and draw the dotted lines, and set the hours in the insides where those lines meet them, as in the figure: and the like hour-lines will be parallel to each other in all the quadrants and in all the angles.

Mark points for all these hours on the upper side; and cut out all the angular hollows, and the quadrantal ones quite through the places where their four gnomons must stand; and lay down the hours on their insides, as in Plate LXXII. and then set in their gnomons, which must be as broad as the dial is thick; and this breadth and thickness must be large enough to keep the shadows of the gnomons from ever falling quite out at the sides of the hollows, even when the sun's declination is at the greatest.

Lastly, draw the equinoctial dial in the middle, all the hours of which are equidistant from each other: and the dial will be finished.

As the sun goes round, the broad end of the shadow of the stile  $abcd$  will shew the hours in the quadrant  $Ac$ , from sun-rise till VI in the morning; the shadow from the end  $M$  will shew the hours on the side  $Lq$  from V to IX in the morning; the shadow of the stile  $efsb$  in the quadrant  $Dq$  (in the the long days) will show the hours from sun-rise till VI in the morning; and the shadow of the end  $N$  will shew the morning hours, on the side  $Or$ , from III to VII.

Just as the shadow of the northern stile  $abcd$  goes off the quadrant  $Ac$ , the shadow of the southern stile  $iklu$

begins to fall within the quadrant  $Fl$ , at VI in the morning; and shews the time, in that quadrant, from VI till XII at noon; and from noon till VI in the evening in the quadrant  $mE$ . And the shadow of the end  $O$ , shews the time from XI in the forenoon till III in the afternoon, on the side  $rN$ ; as the shadow of the end  $P$  shews the time from IX in the morning till I o'clock in the afternoon, on the side  $Q_s$ .

At noon, when the shadow of the eastern stile  $efgb$  goes off the quadrant  $bC$  (in which it shewed the time from VI in the morning till noon, as it did in the quadrant  $gD$  from sun rise till VI in the morning) the shadow of the western stile  $nopq$  begins to enter the quadrant  $Hp$ ; and shews the hours thereon from XII at noon till VI in the evening; and after that till sun set, in the quadrant  $qG$ : and the end  $Q$  casts a shadow on the side  $P_s$  from V in the evening till IX at night, if the sun be not set before that time.

The shadow of the end  $I$  shews the time on the side  $Kp$  from III till VII in the afternoon; and the shadow of the stile  $abcd$  shews the time from VI in the evening till the sun sets.

The shadow of the upright central wire, that supports the globe at top, shews the time of the day, in the middle or equinoctial dial, all the summer half year, when the sun is on the north side of the equator.

**DIALECT**, an appellation given to the language of a province, in so far as it differs from that of the whole kingdom. The term, however, is more particularly used in speaking of the ancient Greek, whereof there were four dialects, the Attic, Ionic, Æolic, and Doric, each of which was a perfect language in its kind, that took place in certain countries, and had peculiar beauties.

**DIALOGISM**, in rhetoric, is used for the soliloquy of persons deliberating with themselves. See **SOLILOQUY**.

**DIALOGUE**, in matters of literature, a conversation between two or more persons, either by writing or by word of mouth.

Dialogue appears to be the most ancient form of writing, and is greatly recommended by several authors. The archbishop of Cambray, at the head of his pastoral instruction, gives an account of the advantages of dialogue.

**DIALTHÆA**, in pharmacy, an unguent much used as a resolvent, so called from *althæa*, or marsh-mallows, which is the principal ingredient in it. See **ALTHÆA**.

**DIALYSIS**, in grammar, a mark or character, consisting of two points,  $\cdot\cdot$ , placed over two vowels of a word, in order to separate them, because otherwise they would make a diphthong, as *Mosaic*, &c. See **DIXRESIS**.

**DIAMETER**, in geometry, a right line passing through the center of a circle, and terminated at each side by the circumference thereof. See **GEOMETRY**.

**DIAMOND**, in natural history, a genus of precious stones, of a fine pellucid substance, of great hardness, never fouled by any admixture of earthy or any other coarse matter, susceptible of elegant tinges from metal-

lue

line particles, giving fire with steel, not fermenting with acid menstruums, scarcely calcinable by any degree of fire, and of one simple and permanent appearance in all lights.

This is the most valuable and hardest of all gems; and though found of different shapes, and sometimes accidentally tinged to several colours, yet ever carries the same distinguishing characters, and is very evidently in all those states the same body. It is, when pure, perfectly clear and pellucid as the purest water, and is eminently distinguished from all other substances, by its vivid splendor, and the brightness of its reflections. It is extremely various in shape and size, being found in the greatest quantity very small, and the larger ones extremely seldom met with; the largest diamond certainly known ever to have been found is that in the possession of the Great Mogul, which weighs 279 carats, and is computed to be worth 779,244 l.

The diamond has certainly one proper and determinate figure, into which it naturally mult concrete, when in a state of rest and impeded by no other accident in its formation: the true figure then is an equilateral octohedron; and where-ever it has concentered in a perfect manner, and without any interrupting accidents, it has always formed itself into this figure; and often in this its several surfaces are as bright as if polished by art: but, as in common salt, though its figure be pyramidal, yet very easy accidents can determine it into cubes and parallelopipeds; so the diamond has often, in the state of formation, been thrown into two other figures, both also seeming regular ones; the one a prismatic columnar one of six angles somewhat emulating the figure of crystal, the other an oblong quadrilateral column with two truncated ends: these seem the only regular figures of this gem; but besides these, it is every day found in numberless other mishapen forms, often roundish, emulating the shape of pebbles, but full of small flat planes or faces; frequently oblong, very often flat, and as often tapering, either from one end to the other, or else from the middle to both ends. A diamond bears the force of the strongest fire, except the concentrated solar rays, without hurt; and even that infinitely fiercest of all fires does it no injury, unless directed to its weaker parts.

It is a common thing for diamonds to be too thick or deep for the extent of their surface, and there is a certain proportion of depth, beyond which the gem should not be allowed: in this case two diamonds are often made, by the regularly dividing one: this, when the mass is of an angular figure, is done by cutting it through with a wire, wetted with oil, and covered with diamond-powder; but in the flat or more common mass, it is done much more expeditiously by finding the grain of the stone, and introducing the point of a fine flat chissel between them. This is not the only use of the splitting; for when a diamond has a flaw or blemish in it, which greatly debases its value, the plates may be separated at a proper breadth, and the flaw removed; in which case the thinner crust, struck off, is of value in proportion to its size, and the remainder, being now freed from its flaw, is of

much more value than it was at first. The places whence we have the diamonds are the East-Indies, in the island of Borneo, and in the kingdoms of Visapour, Golconda, Bengal; and the Brazils in the West-Indies. They are not unfrequently found yellowish, blueish, and reddish, but more rarely greenish.

*Valuation of DIAMONDS*, among jewellers, is thus calculated: they suppose the value of a rough diamond to be 2 l. per carat; then to find the value of those of greater weight, they multiply the square of their weight by 2, and this last product is the value of the diamonds in their rough state: thus, the value of a rough diamond weighing 4 carats, is equal  $4 \times 4 \times 2 = 16 \times 2 = 32$  l. and so in other cases. Again, to find the value of wrought diamonds, they suppose half their weight lost in the manufacturing them, and therefore multiply the square of double their weight by 2; thus the value of a wrought diamond, weighing 3 carats, is equal  $6 \times 6 \times 2 = 36 \times 2 = 72$  l.

*Rose-DIAMOND* is that quite flat underneath, with its upper part cut in divers little faces, usually triangles, the uppermost of which terminate in a point.

*Table-DIAMOND* is that which has a large square face at top, encompassed with four lesser.

*Brilliant DIAMOND* is that cut in faces both at top and bottom; and whose table, or principal face at top, is flat.

*DIAMOND*, in the glass-trade, an instrument used for squaring the large plates or pieces; and, among glaziers, for cutting their glass.

These sort of diamonds are differently fitted up; that used for large pieces, as looking-glasses, &c. is set in an iron ferril, about two inches long, and a quarter of an inch in diameter; the cavity of the ferril being filled up with lead, to keep the diamond firm: there is also a handle of box, or ebony, fitted to the ferril, for holding it by.

*DIAMOND*, in heraldry, a term used for expressing the black colour in the achievements of peerage.

Guillim does not approve of blazoning the coats of peers by precious stones instead of metals and colours; but the English practice allows it. Morgan says the diamond is an emblem of fortitude.

*DIANÆ ARBOR*, or *ARBOR LUNÆ*, in chemistry, the beautiful crystallizations of silver, dissolved in aqua fortis, to which some quicksilver is added: and so called from their resembling the trunk, branches, leaves, &c. of a tree. See *CHEMISTRY*.

*DIANDRIA*, in the Linnæan system of botany. See *BOTANY*, p. 635.

*DIANO*, a town of the Genoese, about three miles from the sea. The country about produces great numbers of olives.

*DIANTHERA*, in botany, a genus of the diandria monogynia class. The corolla is ringent; and the capsule has two elastic valves. There are two species, both natives of America.

*DIANTHUS*, in botany, a genus of the decandria digynia class. The calix is cylindrical, and consists of one leaf, with four scales at the base; the corolla consists of five clawed petals; and the capsule is cylindrical, and

- and has but one call. There are seventeen species, five of which are natives of Britain, *viz.* the armeria, or Deptford pink; the proflifer, or linewort; the deltoïdes, or maiden pink; the glaucus, or mountain pink; and the arenarius, or stone pink.
- DIAPASON**, in music, a musical interval, by which most authors, who have wrote upon the theory of music, use to express the octave of the Greeks. See OCTAVE.
- DIAPASON**, among the musical-instrument makers, a kind of rule or scale, whereby they adjust the pipes of their organs, and cut the holes in their flutes, hautboys, &c. in due proportion, for performing the tones, semitones, and concords just.
- DAPASON DIAEX**, in music, a kind of compound concord, whereof there are two sorts; the greater, which is in the proportion of 10:3; and the lesser, in that of 16:5.
- DIAPASON DIAPENTE**, in music, a compound consonance in a triple ratio, as 3:9. This interval, says Martianus Capella, consists of nine tones and a semitone, nineteen semitones, and thirty eight dieses. It is a symphony made when the voice proceeds from the first to the twelfth sound.
- DIAPASON DIATESSARON**, in music, a compound concord, founded on the proportion of 8:3. To this interval Martianus Capella allows eight tones and a semitone, seventeen semitones, and thirty-four dieses.
- This is when the voice proceeds from its first to its eleventh sound. The moderns would rather call it the eleventh.
- DIAPASON DITONE**, in music, a compound concord, whose terms are as 10:4, or 5:2.
- DIAPASON SEMIDITONE**, in music, a compound concord, whose terms are in the proportion of 12:5.
- DIAPEDESIS**, in medicine, a transfusion of the fluids through the sides of the vessels that contain them, occasioned by the blood's becoming too much attenuated, or the pores becoming too patent.
- DIAPENSIA**, in botany, a genus of the pentandriamonomogynia class. The calix consists of five leaves, imbricated with three smaller ones; the stamina arise from the tube of the corolla; and the capsule has three cells; there are three species, none of them natives of Britain.
- DIAPENTE**, in the ancient music, an interval marking the second of the concords; and with the diatessaron, an octave. This is what in the modern music is called a fifth.
- DIAPHANOUS**, an appellation given to all transparent bodies, or such as transmit the rays of light. See OPTICS.
- DIAPHOENICUM**, in pharmacy, a sort of medicine or electuary chiefly made of dates. It purges serosities, and excites the menses. It is also used in dropsies, lethargies, apoplexies, and palsies.
- DIAPHORESIS**, in medicine, an elimination of the humours in any part of the body through the pores of the skin. See PERSPIRATION.
- DIAPHORETICS**, among physicians, all medicines which promote perspiration.
- DIAPHHRAGM**, in anatomy. See Vol. I. p. 213.
- DIAPORESIS**, in rhetoric, a figure of oratory, expressing the uncertainty of the speaker how he shall proceed in his discourse.
- DIARBECK**, or **DIARBECK**, the capital of a province of the same name, answering to the ancient Mesopotamia: it is situated on the river Tigris, near its source, in 42° E. long. and 37° 20' N lat.
- DIARRHOEA**, or **LOOSENESS**, in medicine, is a frequent and copious evacuation of liquid excrement, by stool. See MEDICINE.
- DIARTHROSIS**, in anatomy. See Vol. I. p. 148.
- DIARY**, among traders, denotes a day-book containing the proceedings of one day.
- DIACHISM**, among musicians, denotes the difference between the comma and enharmonic diesis, commonly called the lesser comma.
- DIASCORDIUM**, in pharmacy, a celebrated composition, so called from scordium, one of its ingredients. It is otherwise termed *confectio fracastorii*, and is thus directed by the college.
- Take of cinnamon and cassia-wood, of each half an ounce; of true scordium, one ounce; of Cretan dittany, tormentil, bistort, galbanum, and gum-arabic, of each half an ounce; of storax, four drams and an half; of opium, and seeds of sorrel, of each one dram and an half; of gentian, half an ounce; of American bole, one ounce and an half; of Lemnian sealed earth, half an ounce; of long pepper and ginger, of each two drams; of clarified honey, two pounds and an half; of sugar of roses, one pound; of generous canary, eight ounces; make into an electuary. It is excellent in all kinds of fluxes, and a great strengthener both of the stomach and bowels.
- DIASEBESTEN**, in pharmacy, a soft purgative electuary, whereof sebestens are the principal ingredients. The other ingredients are prunes, tamarinds, juices of iris, anguria and mercurialis, penidies, simple diaprurnum, violet seeds, and diagrydium. It is good in remitting and continued fevers, &c.
- DIASENNA**, in pharmacy, the name of a medicine in which fenna is the principal ingredient.
- The other ingredients are sugar-candy, cinnamon, lapis lazuli, silk, cloves, galanga-minor, black pepper, nardus indica, seed of basilicum, flowers of cloves, cardamoms, saffron, ginger, zedoary, &c.
- This electuary is taken against melancholy and spleen, and against diseases arising from an atrabilis.
- DIASTOLE**, among physicians, signifies the dilatation of the heart, auricles and arteries; and stands opposed to the systole, or contraction of the same parts. See CIRCULATION.
- DIASTOLE**, in grammar, a figure of prosody, whereby a syllable naturally short is made long: such is the first syllable of Priamides, in the following verse of Virgil.
- Atque hic Priamides! nihil tibi, amice, reliquum.*
- DIASYRMUS**, in rhetoric, a kind of hyperbole, being an exaggeration of some low ridiculous thing.
- DIATESSARON**, among ancient musicians, a concord, or harmonical interval, composed of a greater tone, a

less tone, and one greater semi-tone: its proportion in numbers is as 4 : 3.

**DIATESSARON**, in pharmacy, the name of a composition so called, from the four ingredients it comprehends: it is prepared thus.

Take of gentian root, bay-berries, myrrh, and roots of birthwort, of each two ounces; of honey, two pounds; mix them into an electuary. This, with the addition of the shavings of ivory, two ounces, is entitled diapente, or a composition of five ingredients.

**DIATONIC**, an epithet given to music, as it proceeds by tones and semi-tones, both ascending and descending. See **MUSIC**.

**DIATRAGACANTH**, in pharmacy, a name applied to certain powders, whereof gum tragacanth is the principal ingredient; of which there are two kinds, the cold and the hot: the cold is directed thus: take of gum tragacanth, two ounces; of gum arabic, an ounce and two drams; of starch, half an ounce; of liquorice, and the seeds of melons and white poppies, of each two drams; of sugar candy, three ounces; mix them into a powder. This is frequently prescribed in febrile heats, in choleric constitutions, in distempers of the breast, in stranguries, heat of urine, and the pungency of venereal gleets.

Powder of hot diatrageanth is composed of gum tragacanth, cinnamon, hyssop, almonds, linseed, fenugreek, liquorice, and ginger. It is good against asthma, to promote expectoration, strengthen the stomach, and assist digestion.

**DIAUGOPHRAGMIA**, in natural history, a genus of fossils of the order of septaria, whose partitions, or septa, consist of spar with an admixture of crystal. Of this genus there are three species. 1. A red kind, with brownish yellow partitions. 2. A brownish yellow kind, with whitish partitions. 3. A bluish-white kind, with straw-coloured partitions.

**DICE**, among gamblers, certain cubical pieces of bone or ivory, marked with dots on each of their faces, from one to six, according to the number of faces.

Sharpers have several ways of falsifying dice. 1. By sticking a hog's bristle in them, so as to make them run high or low, as they please. 2. By drilling and loading them with quicksilver; which cheat is found out by holding them gently by two diagonal corners; for if false, the heavy sides will turn always down. 3. By filling and rounding them. But all these ways fall far short of the art of the dice-makers; some of whom are so dextrous this way, that your sharpening gamblers will give any money for them.

Dice formerly paid 5 s. every pair imported, with an additional duty of 4 s. 9  $\frac{1}{2}$  d. for every 20 s. value upon oath; but are now prohibited to be imported.

**DICHOTOMY**, a term used by astronomers for that phasis, or appearance of the moon, wherein she is bisected, or shews just half her disk. In this situation the moon is said to be in a quadrate aspect, or to be in her quadrature.

**DICHOTOMY**, in botany. See **BOTANY**, p. 641.

**DICHOTOPHYLLUM**, in botany. See **CERATOPHYLLUM**.

**DICKER**, in old writers, denotes the quantity of ten hides of skins, whereof twenty made a last: also ten pair of gloves, ten bars of iron, and the like, are sometimes expressed by the term dicker.

**DICTAMUS**, **DITTANY**, in botany, a genus of the decandria monogynia class. The calix consists of five leaves, and the corolla of five open petals; the filaments have many glandular points; and the five capsules are united. There is but one species, *viz.* the oblus, a native of Italy. The root is said to be alexipharmic, but is not regarded in practice.

**DICTATOR**, in the policy of the ancient Romans, a magistrate invested with sovereign and even arbitrary power.

He had power of life and death; also to raise and disband troops, make war or peace, and that without the consent either of the senate or people, or being accountable for his proceedings. He was elected by one of the consuls in the night-time, on the frontiers of the commonwealth, and nowhere else; and the ordinary duration of his office was only for six months, during which time all other magistracies ceased, the tribuneship excepted. Whenever he appeared in public, he was attended by twenty-four lictors, or double the number allowed a consul. However, notwithstanding all this power, he could not go out of Italy, or even ride on horseback during a march, without leave from the people.

This office was accounted the safeguard of the commonwealth for four hundred years together, till Sylla and Cæsar, by assuming the title of perpetual dictators, converted it into tyranny, and rendered the very name odious.

**DIC TION**, the phrase, elocution, or style of a writer or speaker. See **COMPOSITION**.

**DICTIONARY**, in its original acceptation, is the arranging all the words of a language according to the order of the alphabet, and annexing a definition or explanation to each word. When arts and sciences began to be improved and extended, the multiplicity of technical terms rendered it necessary to compile dictionaries either of science in general, or of particular sciences, according to the views of the compiler. For further particulars concerning dictionaries of this kind, see the *Preface*.

**DICTIONARY of the English language**. The only attempt which has hitherto been made towards forming a regular dictionary of the English language, is that of the learned Dr Samuel Johnson. But although it is executed in a masterly manner, yet as it cannot be expected that an undertaking of this nature could be brought to perfection by one man, we shall venture to suggest a few circumstances which, if duly attended to, may perhaps be of some utility.

The design of every dictionary of language, is to explain in the most accurate manner, the meaning of every word, and to show the various ways in which it can be combined with others, in as far as this tends to alter its meaning. The dictionary which does this

this in the most accurate manner, is the most complete. Therefore the principal study of a lexicographer ought to be, to discover a method which will be best adapted for that purpose. Dr Johnson, with great labour, has collected the various meanings of every word, and quoted the authorities: But, would it not have been an improvement if he had given an accurate definition of the precise meaning of every word; pointed out the way in which it ought to be employed with the greatest propriety; shewed the various deviations from that original meaning, which custom had so far established as to render allowable; and fixed the precise limits beyond which it could not be employed without becoming a vicious expression? With this view, it would have been necessary to exhibit the nice distinctions that take place between words which are nearly synonymous. Without this, many words can only be defined in such a manner, as that they must be considered as exactly synonymous. We omit giving any quotations from Johnson to point out these defects; but shall content ourselves with giving a few examples, to shew how, according to our idea, a dictionary of the English language ought to be compiled.

**IMMEDIATELY.** *adv. of time.*

1. Instantly, without delay. Always employed to denote future time, and never past. Thus, we may say, *I will come immediately*; but not, *I am immediately come from such a place*. See **PRESENTLY**.
2. Without the intervention of any cause or event; as opposed to mediately.

**PRESENTLY.** *adj. of time.*

1. Instantly, without delay. Exactly synonymous with *immediately*; being never with propriety employed to denote any thing but future time.
2. Formerly it was employed to express present time: Thus, *The house presently possessed by such a one*, was often used; but this is now become a vicious expression, and we ought to say, *The house possessed at present*. It differs from *immediately*, in this, that even in the most corrupt phrases it never can denote past time.

**FORM.** *subst* The external appearance of any object when considered only with respect to shape or figure. This term therefore, in the literal sense, can only be applied to the objects of the sight and touch; and is nearly synonymous with figure; but they differ in some respects. *Form* may be employed to denote more rude and unfinished shapes; *figure*, those which are more perfect and regular. *Form* can never be employed without denoting matter; whereas *figure* may be employed in the abstract: Thus, we say a square or triangular *figure*; but not a square or triangular *form*. And in the same manner we say, the *figure* of a house: but we must denote the substance which forms that figure, if we use the word *form*; as, *a cloud of the form of a house*, &c. See **FIGURE**.

2. In contrast to irregularity, or confusion. As beauty cannot exist without order, it is by a figure of speech employed to denote beauty, order, &c.
3. As *form* regards only the external appearance of

bodies, without regard to their internal qualities, it is, by a figure of speech, employed in contrast to these qualities, to denote empty shew, without essential qualities. In this sense it is often taken when applied to religious ceremonies, &c.

4. As *form* is employed to denote the external appearance of bodies; so, in a figurative sense, it is applied to reasoning, denoting the particular mode or manner in which this is conducted; as, *the form of a syllogism*, &c.
5. In the same manner it is employed to denote the particular mode of procedure established in courts of law; as, *the forms of law, religion*, &c.
6. *Form* is sometimes, although improperly, used to denote the different circumstances of the same body; as, *water in a fluid or a solid form*. But as this phrase regards the internal qualities rather than the external figure, it is improper, and ought to be, *water in a fluid, or a solid state*.
7. But when bodies of different kinds are compared with one another, this term may be employed to denote other circumstances than shape or figure; for we may say, *a juice exuding from a tree in the form of wax or resin*; although, in this case, the consistence, colour, &c. and not the external arrangement of parts, constitutes the resemblance.
8. From the regular appearance of a number of persons arranged in one long seat, such persons so arranged are sometimes called a *form*; as, *a form of students*, &c. And,
9. By an easy transition, the seat itself has also acquired that name.

**GREAT.** *adj.* A relative term, denoting largeness of quantity, number, &c. serving to augment the value of those terms with which it is combined, and opposed to *small* or *little*. The principal circumstances in which this term can be employed, are the following:

1. When merely inanimate objects are considered with regard to quantity, *great* is with propriety employed, to denote that the quantity is considerable; as, *a great mountain, a great house*, &c. and it is here contrasted with *small*. When *great* is thus employed, we have no other word that is exactly synonymous.
2. When inanimate objects are considered with regard to their extent, this term is sometimes employed, although with less propriety; as, *a great plain, a great field*, &c. and in this sense it is nearly synonymous with *large*; and they are often used indiscriminately, but with some difference of meaning: for, as *large* is a term chiefly employed to denote extent of superficies, and as *great* more particularly regards the quantity of matter; therefore, when *large* is applied to any object which is not merely superficial, it denotes that it is the extent of surface that is there meant to be considered, without regard to the other dimensions; whereas when the term *great* is employed, it has a reference to the whole contents. If, therefore, we say, *a large house*, or *a large river*, we express that the house, the river, have

have a surface of great extent, without having any necessary connection with the size in other respects. But if we say, *a great house*, or *a great river*, it at once denotes that they have not only a large surface, but are also of great size in every respect.

3. *Great*, when applied to the human species, never denotes the size or largeness of body, but is applied solely to the qualities of the mind. Thus, when we say, that *Socrates was a great man*, we do not mean that he was a man of great size, but that he was a man who excelled in the endowments of the mind. The terms which denote largeness of size in the human body are, *big*, *bulky*, *huge*, &c.
4. *Great* is sometimes applied to the human species, as denoting high rank. In this case it is oftener used in the plural number than otherwise. Thus we say simply, *the great*, meaning the whole body of men in high station, as opposed to *mean*. It should seldom be employed in this sense, as it tends to confound dignity of rank with elevation of mind.
5. As this is a general term of augmentation, it may be joined with all nouns which denote *quantity*, *quality*, *number*, *excellence*, or *defects*; or such as imply *praise*, *blame*, *anger*, *contempt*, or any other affection of the mind.
6. It is employed to denote every step of ascending or descending consanguinity; as, *great-grandfather*, *great-grandson*, &c.

**HIGH.** *adj.* Exalted in a perpendicular direction at a distance from the surface of the earth. Opposed to *low*.

1. *High* is a term altogether indefinite, and is employed to express the degree of elevation of any inanimate body. Thus, we say, *a high mountain*, *a high house*, *steeple*, *tower*, *pillar*, &c. nor is there any other word that can here be considered as synonymous; *lofty* being employed only to denote a very eminent degree of elevation.
2. To express the perpendicular elevation of vegetables, either *high* or *tall* may be employed, as being in this case nearly synonymous, we may therefore say, *a high* or *tall tree*, *a high* or *tall mast*, &c. but with this difference between these two expressions, that *tall* can be more properly applied to those that are much elevated and of small dimensions; and *high*, to such as are more bulky, and of greater size.
3. The perpendicular height of man can never be expressed by the word *high*; *tall* being here the proper expression. And although *high* is sometimes used to express the height of other animals, yet it seems to be an improper expression. See **TALL**.
4. *High*, when applied to the human species, always refers to the mind; and denotes *haughtiness*, *statureliness*, *pride*, &c.; and, when combined with the expressions of any energy of the mind, it denotes that in a higher degree. In this sense, it is opposed to *meanness*, *abjectness*, and *humility*.
5. As this is an indefinite term, tending to denote any thing that is elevated above us, it may be combined with almost every noun which admits of this

elevation. And as objects high above us are always out of our reach, it is in a metaphorical sense used to denote any thing that seems to be above the ordinary condition of mankind; or those qualities or endowments of mind that are not easily acquired; as, *dignity* or *elevation of sentiment*, *dignity of rank*, *acuteness in reasoning on difficult subjects*; *pride*, *haughtiness*, or any other quality which seems beyond the ordinary level of mankind; *dear-ness of price*, &c.

6. In the same manner we employ this term to time; which having a metaphorical resemblance to a river, flowing on with an unceasing current through all successive ages, any thing of remote antiquity is denoted by the term *high*.
7. Likewise those degrees of latitude far removed from the line, where the pole becomes more elevated.
8. And to some particular crimes, as being attended with peculiar degrees of guilt; as, *high treason*.

**TALL.** *adj.* Something elevated to a considerable degree in a perpendicular direction. Opposed to *low*.

1. This term is chiefly employed to express the height of man, and other animals; and is applied to denote the height of the body only, without having any reference to the mind. When applied to man, no other word can be substituted in its stead: when applied to other animals, *high* is sometimes considered as nearly synonymous. See **HIGH**.
  2. It is likewise employed to denote the perpendicular height of vegetables; and in this case it is nearly synonymous with *high*. See **HIGH**.
  3. It can in no case be employed to express the height of merely inanimate objects; as we can never say a *tall steeple*, *tower*, or *pillar*, but a *high steeple*, &c. For the distinctions in these cases, see **HIGH**.
- LONG.** *adj.* A relative term, denoting the distance between the extremes of any body, which is extended more in one of its geometrical dimensions than another. Opposed to *short*.

1. This term may be applied to all inanimate objects, of whatever kind, whose dimensions in one way exceeds the other, and when not in an erect posture, whatever be the other circumstances attending them; whether it relates to superficies alone, or to solid bodies; whether these be bounded or open, straight or crooked, flexible or rigid, or in any other circumstances whatever; thus we say *a long* or *short line*, *a long* or *short ridge*, *street*, *ditch*, *rope*, *chain*, *staff*, &c. But it is to be observed, that although *long* is, in the strict sense only, opposed to *short*; yet as it expresses the extension of matter in one of its geometrical proportions, it is often contrasted by those words which express the other proportions when we mean only to describe the several proportions; as, *a table long and broad*: and as these several dimensions are expressed by different words, according to the various forms, modifications, and circumstances, in which bodies are found; therefore it is in this sense contrasted by a great diversity of terms; as, *a long*  
and



and *broad*, or *wide*, *narrow*, or *strait street* or *lane*, a *long and thick*, or *small rope*, *chain*, *staff*, &c. For the distinctions in these cases, see **BROAD**, **WIDE**, &c.

2. Objects necessarily fixed in an erect position can never have this term applied to them; and therefore we cannot say a *long*, but a *high tower* or *steeple*. And for the same reason, while trees are growing and fixed in an erect position, we cannot apply this term to them; but when they are felled and laid upon the ground, it is quite proper and necessary. Thus, we do not say a *long*, but a *tall or high tree*, while it is growing; but we say a *long*, not a *tall log of wood*: and in the same manner we say a *tall mast*, when it is fixed in the ship; but a *long mast*, while it lies upon the beach. See **TALL** and **HIGH**.
3. Those vegetables which are of a tender pliant nature, or so weak as not to be able to retain a fixed position, being considered as of a middle nature between erect and prostrate bodies, admit of either of the terms *long*, *tall*, or *high*; as, a *long or tall rush* or *willow wand*, or a *long, tall, or high stalk of corn*. See **HIGH** and **TALL**.
4. The parts of vegetables, when considered as distinct from the whole, even when growing and erect, assume the term *long*: for we do not say a *tall*, but a *long shoot of a tree*; and a *tree with a long stem*, in preference to a *tree with a high stem*.
5. For the same reason, a *staff*, and *pole*, even when fixed in a perpendicular direction, assume the word *long*, in preference to *tall* or *high*.
6. With regard to animals, the general rule is applied, without any exceptions; *tall*, and not *long*, being employed to denote the height of the human body, when in an erect posture; and *long* and not *tall*, to denote its length when in an incumbent situation. *Long*, applied to all other animals which do not walk erect, always denotes their greatest length in a horizontal position from head to tail.
7. In a figurative sense, it denotes, with regard to time, any thing at a great distance from us.
8. As also, any thing that takes up much time before it is finished; as, a *long discourse*, a *protracted note in music*, &c.

**BROAD**. *adj.* The distance between the two nearest sides of any body, whose geometrical dimensions are larger in one direction than in another; and has a reference to superficies only, and never to the solid contents. Opposed to *narrow*.

1. *Broad*, in the strictest acceptation, is applied to denote those bodies only whose sides are altogether open and unconfined; as, a *broad table*, a *broad wheel*, &c. and in these cases it is invariably contrasted by the word *narrow*; nor is there any other word which in these cases can be considered as synonymous with it, or used in its stead.
2. When any object is in some sort bounded on the sides, although not quite closed up, as a road, street, ditch, &c. either *broad* or *wide* may be employed, but with some difference of signification; *broad* be-

ing most properly used for those that are more open, and *wide* to those which are more confined; nor can this term be ever applied to such objects as are close bounded all around, as a house, church, &c. *wide* being here employed. For the more accurate distinctions in these cases, see the article **WIDE**.

**WIDE**. *adj.* A term employed to denote relative extent in certain circumstances. Opposed to *narrow* and *strait*.

1. This term is in its proper sense applied only to denote the space contained within any body closed all round on every side, as a house, gait, &c. and differs from *broad* in this, that it never relates to the superficies of solid objects, but is employed to express the capaciousness of any body which containeth vacant space; nor can capaciousness in this sense be expressed by any other word but *wide*.
2. As many bodies may be considered either with respect to their capaciousness, or superficial extent; in all these cases, either the term *broad* or *wide* may be used; as, a *broad* or *wide street* or *ditch*, &c. but with a greater or less degree of propriety, according to the circumstances of the object, or the idea we wish to convey. In a street where the houses are low, and the boundaries open, or in a ditch of small depth and large superficies, as this largeness of superficies bears the principal proportion, *broad* would be more proper; but if the houses are of great height, or the ditch of great depth, and capaciousness is the principal property that affects the mind, we would naturally say a *wide street* or *ditch*; and the same may be said of all similar cases: but there are some cases in which both these terms are applied, with a greater difference of meaning; thus we say, a *broad*, or a *wide gate*; but as the gate is employed to denote either the aperture in the wall, or the matter which closes that aperture, these terms are each of them used to denote that particular quality to which they are generally applied: and as the opening itself can never be considered as a superficies, the term *wide*, in this case, denotes the distance between the sides of the aperture; while, on the contrary, *broad* denotes the extent of matter fitted to close that aperture; nor can these two terms in any case be substituted for one another.
3. As a figurative expression, it is used as a cant phrase for a mistake; as, *you are wide of the mark*; that is, not near the truth.

**NARROW**. *adj.* A relative term, denoting a proportional smallness of distance between the sides of the superficies of plain bodies. Opposed to *broad*.

1. As this is only applied to superficies, it is exactly contrasted by *broad*; and is applied in all cases where the term *broad* can be used, (see **BROAD**); and in no other case but as a contrast to it, except the following.
2. It sometimes is employed to describe the smallness of space circumscribed between certain boundaries, as opposed to *wide*, and nearly synonymous with

*strait*; as we say *a wide or a narrow house, church, &c.* For the necessary distinctions here, see the article STRAIT.

3. In a figurative sense it denotes *parsimony, poverty, confined sentiments, &c.*

STRAIT. *adj.* A relative term, denoting the extent of space in certain circumstances. Opposed to *wide*, see WIDE.

1. This term is employed, in its proper sense, to denote only space, as contained between surrounding bodies in such circumstances as to denote some degree of confinement; and is exactly opposed to *wide*; as, *a wide or a strait gate, &c.* See WIDE.

2. So necessary is it that the idea of confinement should be connected with this word, that in all those cases where the space contained is large, as in a church or house, we cannot express a smaller proportional width by this term. And as we have no other word to express space in these circumstances, we have been obliged to force the word *narrow* from its natural signification, and make it express this. See NARROW.

3. In some particular cases *narrow* or *strait* may be employed to the same object; as, *a narrow or a strait lane*: but here *strait* is never employed but where an idea of confinement is suggested, and where it is exactly contrasted to *wide*; nor can *narrow* be employed but in such circumstances where *broad* would be a perfect contrast to it. Therefore these two terms may be always employed in the same circumstances as those which contrast them may be. For an account of which, see WIDE.

3. The term *strait* is likewise in a peculiar manner used to denote the smallness of the internal diameter of those small bodies which are fitted to receive or contain others as, any kind of bag, tube, body-cloaths, mortises, and others of the same kind; and in all these cases this term may be employed to denote the smallness of their lesser diameter, and never the term *narrow*. But in certain circumstances the word *tight* may be substituted for it. See TIGHT.

4. *Strait*, in a figurative sense, denotes any sort of confinement of sentiment or disposition.

TIGHT. *adj.* A term employed in certain circumstances to denote the internal capacity of particular bodies. Nearly synonymous with *strait*.

This term is confined entirely to denote the smallness of the internal dimensions of such objects as are formed to cover or to receive or contain other solid bodies, and can be employed in no other case. And although it agrees with *strait*, in always denoting confinement, and by being applicable to the same species of objects, yet it differs in the the following respects: 1. If there be any difference of the diameter of the objects to which the term *strait* can be employed, it always has reference to the smaller; yet *tight* may be employed to any sort of confinement, whether it regards the length or breadth. 2. *Strait* can be applied to all bodies of capacity when of small diameter, without any sort of reference to the nature of the substance which it may

be capable of containing. For we can say *a strait bag, a strait sleeve, a strait mortise, a strait gate, &c.* whereas *tight* can only be applied to any body when it is considered as having reference to another body which is intended to be contained in it and is pinched for want of room. Thus, we say, *the sleeve of a coat is too tight for the arm, the mortise is too tight for the tenon, &c.* but we cannot say, *the bag, or the gate is too tight*, because these are fitted to receive any sort of objects. And hence it happens, that, in many cases, the dimensions of the same body may be expressed by *tight* or *strait* when considered in different circumstances. Thus, we may say, *this sleeve is too strait*, when we look at a coat when lying on the table, and consider its proportions; but it is not till we have tried it upon the arm that it is intended to cover, that we call it *tight*. And we may say, *a gate is too strait, or too tight*; but in the first case we consider it as being too confined for admitting objects to pass through it, and in the last as being too confined with respect to the leaves that are to shut the aperture, not allowing them space to move with freedom.

These examples may serve to give some idea of the plan of an English dictionary composed upon philosophical principles: But, besides the circumstances above enumerated, there are many others which would require particular attention in the execution of a work of this kind. In the English language, a great variety of terms occur, which denote matter under certain general forms or circumstances, without regarding the minute diversities that may take place; as the word *cloth*, which denotes matter as manufactured into a particular form, including under it all the variety of stuffs manufactured in that particular way, of whatever materials, colours, texture, or fineness they may be. The same may be said of *wood, iron, yarn*, and a great variety of terms of the same nature, some of which cannot assume any plural; while others admit of it in all cases; and others admit or refuse it according to the different circumstances in which they are considered. In a dictionary, therefore, all this variety of cases ought to be clearly and distinctly pointed out under each particular article: this is the more necessary, as some of these words have others formed from them, which might be readily mistaken for their plurals, although they have a very different signification; as *cloaths* which does not denote any number of pieces or different kinds of *cloth*, but *wearing apparel*. The following example will illustrate this head.

WOOD. *sub.* A solid substance of which the trunks and branches of trees consist.

1. This term is allowed to denote the solid parts of vegetables of all kinds, in whatever form or circumstances they are found. Nor does this term admit of plural with propriety, unless in the circumstances after mentioned: for we say, *many different kinds of wood*, in preference to *many kinds of woods*; or, we say, *oak, ash, or elm wood*; not *woods*.

2. But where we want to contrast *wood* of one quality,

lity or country with that of another, it admits of a plural; for we say, *white woods are in general lighter than red*; or *West-Indian woods are in general of greater specific gravity than the European woods*: But unless where the colour, or some quality which distinguishes it from growing wood, is mentioned, this plural ought as much as possible to be avoided, as it always suggests an idea of growing wood.

3. *Wood* likewise denotes a number of trees growing near one another; being nearly synonymous with *forest*: See FOREST. In this sense it always admits of a plural; as, *Ye woods and wilds whose solitary gloom, &c.*

A dictionary cannot be reckoned complete without explaining obsolete words; and if the terms of the several provincial provincial dialects were likewise given, it would be of great utility: nor would this take much time; because a number of these words need no other explanation than to mark along with them the words which had come in their place, when there happened to be one perfectly synonymous: and in these cases where the same idea could not be expressed in modern language without a periphrasis, it would be of use to explain them distinctly; so that, when a writer found himself at a loss for a term, and obliged to search for one beyond the bounds of our own language, he might take one of these, when he found that it was expressive and energetic, in preference to another drawn from a foreign language. This would at least have one good effect: it would make our language more fixed and stable; not to say more accurate and precise, than by borrowing from foreign languages. The following examples may serve to give some idea of the manner of treating this part of the work.

*MOE*, or *MO*. *adj.* An obsolete term still employed in the Scotch dialect, and by them pronounced *mae*: denoting a greater number, and nearly synonymous with *more*; but it differs in this respect, that, in the Scotch dialect, *mae* and *mair* (English, *more*) are each employed in their distinct sphere, without encroaching upon one another; *mae* being employed to denote number, but never quantity or quality; and *mair*, to denote quantity and quality, but never number: thus they say *mae*, not *mair* apples, *men*, &c. and they say *mair*, not *mae* cloth, *earth*, *courage*, &c. See MAIR. Both of these terms are supplied by the word *more*; which, in the English language, is applied indiscriminately to denote quantity, quality, and number. See MORE.

*THIR*. *pron.* Obsolete; still employed in the Scotch dialect: the plural of *this*; and contrasted to *these*, in the same manner as *that* is to *this*.

As there is no word in the English language equivalent to this, we thus shew the manner in which it is employed. In the English language we say, *that stone or house, pointing at one at a distance, is larger or more commodious than this stone or this house*, which is supposed to be at hand. In the same manner, in the Scotch dialect, they say, *these* (or as it is pronounced, *thae*) *stones are whiter than thir*

*stones*; denoting, that the former are at a distance, and the latter at hand. And, in the same manner, it is invariably applied to denote any present object in the plural number, as opposed to *these*; as *these* or *thir* apples, as at hand or at a distance; *these* or *thir* trees, &c.; but never in the singular number, as it is always *this* or *that* tree, *house*, &c.

As the English language is so exceedingly irregular in the pronunciation, the same letter in the same situation often assuming sounds totally different in different words, it is impossible to establish any general rules on this subject, which do not admit of many exceptions: therefore, a dictionary is the best means of ascertaining and pointing out the proper pronunciation of words. For, if the writer first pointed out all the different sounds that the same letter could ever be made to express, and assigned to every particular sound which each letter could be made to assume, a particular mark, which was appropriated to denote that particular sound of the letter whenever it occurred; by placing these particular marks above the letters in the dictionary, the sound of each letter would be pointed out in all cases with the utmost certainty. It would be impossible for us to illustrate this by examples, without first ascertaining all the sounds of each letter; which would lead us into a discussion too long for this place; and this is at present the more unnecessary, as the public have been long in expectation of a dictionary, by a very able hand, in which this particular will be attended to.

We shall only further observe, that, besides having the accented syllable of every word properly distinguished in a dictionary to assist in the pronunciation, the English language requires another essential improvement, *viz.* the use of accents to distinguish the meaning of words and phrases; which, although it is not so properly confined to a lexicographer, yet it is not quite without his sphere. Thus the word *as* admits of two very different sounds, as well as different significations; as in this example, "Cicero was nearly *as* eloquent *as* Demosthenes:" in which the first *as* is pronounced *afs*, and the last is pronounced *az*. Now, it often happens, that, in reading, the particular way in which it ought to be understood is not pointed out by the context, till after the word itself is pronounced, which has an equal chance at least of being pronounced wrong; whereas, if it were always accented when employed in the one sense, and not in the other, it would free the reader from this perplexity. There are other cases in which the use of proper accents in writing would be of great consequence; as at the beginning of a sentence, when it was put as a question, or used ironically, &c. the want of which every one must have observed. But as this does not so properly belong to the lexicographer as the grammarian, we shall here take no further notice of it.

The above examples, we hope, will be sufficient to give the reader some idea of the plan that we would propose; and enable him to determine, whether or not a dictionary, executed upon this plan, would convey to his mind a more perfect knowledge of the English language, than those dictionaries that have been hitherto published.

These

These examples were given rather with a view to shew the manner in which a work of this kind might be conducted, than as perfect and unexceptionable explanations of the several articles there enumerated; and therefore we did not think it necessary to produce any authorities, although we are sensible that they would be necessary in a work of this kind.

**DIDACTIC**, in the schools, signifies the manner of speaking, or writing, adapted to teach or explain the nature of things.

**DIDAPPEK**, in ornithology, See **COLYMBUS**.

**DIDELPHIS**, in zoology, a genus of quadrupeds belonging to the order of fera, the characters of which are these: they have ten foreteeth in the upper-jaw, and eight in the under one; the dog-teeth are long; the tongue is somewhat ciliated; and they have a pocket, formed by a duplicature of the skin of the belly, in which the dugs are included. There are five species, *viz.* 1. The marsupialis, with eight dugs inclosed in the abdominal pocket. He is about sixteen inches long from the snout to the root of the tail, which is about twelve inches long: he has five toes on the fore-feet, with crooked claws and five toes on the hind-feet, only four of them furnished with claws; the fifth, which is a kind of thumb, is at a distance from the others, and has no claw; the tail is bare from a little below the root: The ears and legs are likewise bare; the eyes are small, prominent, of a black colour, and very lively. The body is of a greyish colour, with some small tufts of black and white hairs upon the back and sides. Under the belly of the female there is a large bag or pocket, formed by a remarkable duplicature of the skin, in which the dugs are contained. This pocket the animal can shut or open at pleasure, by means of a couple of muscles and two bones which are placed before the os pubis, and are peculiar to the didelphis. The interior side of this pocket is full of small glands, which secrete a yellowish stinking substance, which diffuses its odour through the whole body of the animal: but this substance, when dried, loses its disagreeable odour, and acquires a smell like that of musk.—This animal is originally a native of South America. Most authors affirm that they bring forth five or six young ones at a time. As soon as they are brought forth, they creep into the pocket of the mother, where the dugs are situate, and continue there sucking till they be able to run about. When alarmed or frightened, they run into the mother's pocket, and she makes off with them in this situation. The didelphis is an animal of slow motion; a man can easily out run him; but then, he takes to a tree, which he mounts with great facility, and conceals himself among the leaves, or suspends himself by twirling his tail round a branch. Although a carnivorous animal, he is fond of the sugar cane, potatoe, &c. See Plate LXVIII fig. 5.

The second species is the philander, with four dugs, pendulous ears, and a tail bushy at the base. 3. The opossum, with two dugs, and a less bushy tail. 4. The murina, with six dugs. 5. The dothi-

gera, with the tail bushy at the base, and longer than the body. The females of this species carry their young on their backs, the young having their tails twisted about the tail of the mother. The above four are natives of America.

**DIDUS**, in ornithology, a genus belonging to the order of gallinæ. The bill is contracted in the middle by two transverse rugæ; each mandible is inflected at the point; and the face is bare behind the eyes. The body is blackish and cloudy; the tail is very short; and the upper part of the bill is red. It is a native of India, and is incapable of flying, because the wings are not furnished with feathers sufficient for that purpose.

**DIDYNAMIA**, in the Linnæan system of botany. See **OTANY**, p. 635.

**DIE**, in geography, a town of France, in the province of Dauphiny, situated on the river Drome, twenty-two miles south of Grenoble: E. long. 5° 20', N. lat. 44° 50'.

**DIEGEM**, a town of the Austrian Netherlands, in the province of Brabant, about three miles north of Brussels: E. long. 4° 20', and N. lat. 51°.

**DIEPE**, a port-town of France, situated on the British channel, about thirty miles north of Rouen, and opposite to port Rye in England: E. long. 1° 15', and N. lat. 49° 55'.

**DIEPHOLT**, a city of Westphalia in Germany, situated at the north end of the Dummer-lake, thirty-five miles south of Bremen: E. long. 8°, N. lat. 53°.

It is subject to the king of Great Britain, as elector of Hanover.

**DIERVILLA**, in botany. See **LANICERA**.

**DIES MARCHIÆ**, was the day of congress, or meeting of the English and Scotch, annually appointed to be held on the marches, or borders, in order to adjust all differences between them.

**DIESIS**, in music, is the division of a tone less than a semi-tone; or an interval consisting of a less or imperfect semi-tone.

Diesis is the smallest and softest change or inflexion of the voice imaginable: it is called a faint, expressed thus X, by a St Andrew's cross, or saltier.

**DIET**, in medicine, according to some, comprehends the whole regimen, or rule of life, with regard to the six non-naturals, air, meats and drinks, sleep and watching, motion and rest, passions of the mind, retentions and excretions.

The more accurate writers, however, restrain the term of diet to what regards eating and drinking, or solid aliments and drinks. See **MEDICINE**.

**DIET-DRINKS**, a form in physic, including all the medicated wines, ales, and wheys, used in chronic cases. They require a course or continuation to answer any intention of moment.

**DIET of appearance**, in Scots law, the day to which a defender is cited to appear in court, and every other day to which the court shall afterwards adjourn the consideration of the question.

**DIET**, or **DYET**, in matters of policy, is used for the general

general assembly of the states, or circles of the empire of Germany, and of Poland, to deliberate and concert measures proper to be taken for the good of the public.

The general diet of the empire is usually held at Ratisbon: it consists of the emperor, the nine electors, and the ecclesiastical princes; viz. the archbishops, bishops, abbots, and abbesses; the secular princes, who are dukes, marquises, counts, viscounts, or barons; and the representatives of the imperial cities. It meets on the emperor's summons, and any of the princes may send their deputies thither in their stead. The diet makes laws, raises taxes, determines differences between the several princes and states, and can relieve the subjects from the oppressions of their sovereigns.

The diet of Poland, or the assembly of the states, consists of the senate and deputies, or representative of every palatinate or county and city, and meet usually every two years, and oftener upon extraordinary occasions, if summoned by the king, or, in his absence, by the archbishop of Gnesna. The general diet of Poland sits but six weeks, and often breaks up in a tumult much sooner: for one dissenting voice prevents their passing any laws, or coming to any resolutions on what is proposed to them from the throne. Switzerland has also a general diet, which is usually held every year at Baden, and represents the whole Helvetic body: it seldom lasts longer than a month. Besides this general diet, there are diets of the protestant cantons, and diets of the catholic ones; the first assemble at Araw, and are convoked by the canton of Zurich; the second at Lucern, convoked by the canton of that name.

**DIETETIC**, denotes something belonging to diet, but particularly that part of physic which treats of this subject.

**DIETS**, a town in the circle of the Upper Rhine in Germany, situated on the river Lohn, twenty miles north of Mentz, and subject to the house of Nassau-Orange: E. long. 7° 40', and N. lat. 50° 28'.

**DIEU ET MON DROIT**, i. e. *God and my right*, the motto of the royal arms of England, first assumed by king Richard I. to intimate that he did not hold his empire in vassalage of any mortal.

It was afterwards taken up by Edward III. and was continued without interruption to the time of the late king William, who used the motto *Je main-tien-dray*, though the former was still retained upon the great seal. After him queen Anne used the motto *Semper eadem*, which had been before used, by queen Elizabeth; but ever since queen Anne, *Dieu et mon droit* continues to be the royal motto.

**DIEXAHEDRIA**, in natural history, a genus of pellucid and crystalliform spars, composed of two pyramids, joined base to base, without any intermediate column: the diexahedria are dodecahedral, or composed of two hexangular pyramids.

**DIFFUSE**, an epithet applied to such writings as are wrote in a prolix manner. Among historians, Sallust

is reckoned sententious, and Livy diffuse. Thus also among the orators, Demosthenes is close and concise; Cicero, on the other hand, is diffuse.

**DIFFUSION**, the dispersion of the subtle effluvia of bodies into a kind of atmosphere all round them. Thus the light diffused by the rays of the sun, issues all round from that amazing body of fire.

**DIGASTRICUS**, in anatomy. See Vol. I. p. 222.  
**DIGEST**, in matters of literature, a collection of the decisions of the Roman lawyers properly digested, or arranged under distinct heads, by order of the emperor Justinian. It constitutes the first part or volume of the civil law.

**DIGESTION**, in medicine, is the dissolution of the aliments into such minute parts as are fit to enter the lacteal vessels, and circulate with the mass of blood.

Various are the systems and hypotheses framed by physicians and philosophers to account for digestion. Some contend, that it is done by a kind of elixation of the solid and grosser parts of the food in the liquid by the heat of the stomach, and of the adjacent parts, the liver, spleen, &c. Others will have it done by attrition, as if the stomach, by those repeated motions, which are the effects of respiration, rubbed off the minuter particles from the grosser matters, and agitating the rest against each other, attenuated and dissolved them.

Others think the bilious juice, others the spirits, chiefly concerned in digestion.

Others will have the food dissolved by a menstruum; but then they are greatly divided as to the nature and origin of this menstruum; some supposing it an acid furnished by the glands of the stomach; others, a nitro-aerial spirit, which, by penetrating the mass of food, breaks the connexion of the most solid parts: and others, a saline juice, which divides and volatilizes the parts of the food. Others, again, suppose digestion to be performed by means of a ferment or leaven, which mixing with the aliment, excites an intestine motion in the parts thereof, by which means the parts are attenuated and dissolved. But these likewise differ in their opinion of this ferment; some taking it to be the remains of the food last digested, which, by its continuance in the stomach, has contracted an acid quality and become a ferment: others take the principles of fermentation to be contained in the aliment itself, which when inclosed in the stomach, heated there, and put in motion, enters on its office of fermentation: others suppose the matter of the ferment supplied by the glands of the stomach; and lastly, others contend for the saliva, and make that the ferment serving principally for the digestion of the food.

Some suppose digestion owing to gentle heat and motion. By this heat and motion, say they, the texture of the nourishment is changed in the bodies of animals; and then the constituent solid parts are indued with peculiar attractive powers of certain magnitudes, by which they draw, out of the fluids moving through them, like parts in certain quantities, and thereby preserve their forms and just magnitudes.

- And, to mention no more, Boerhaave ascribes digestion to the joint action of several of the above-mentioned causes, aided by the expansion of the air contained in the aliments.
- Want of DIGESTION*, a disease attended with pain, and a sense of weight, with eructations and copious flatulences from corrupt humours in the stomach.
- DIGESTIVE**, in medicine, such remedies as strengthen and increase the tone of the stomach, and assist in the digestion of foods. To this class belong all stomachics and strengtheners, or corroborants.
- DIGIT**, in astronomy, the twelfth part of the diameter of the sun or moon, is used to express the quantity of an eclipse. Thus an eclipse is said to be of six digits, when six of these parts are hid.
- DIGITS**, or **MONADES**, in arithmetic, signify any integer under 10; as 1, 2, 3, 4, 5, 6, 7, 8, 9.
- DIGIT** is also a measure taken from the breadth of the finger. It is properly  $\frac{1}{4}$  of an inch, and contains the measure of four barley-corns laid breadth-wise.
- DIGITALIS**, or **FOX-GLOVE**, in botany, a genus of the didynamia angiospermia class. The calix is divided into five segments; the corolla is bell-shaped, ventricose, and has five divisions; and the capsule is oval, and has two cells. There are six species, only one of which, *viz.* the purpurea, or purple fox-glove, is a native of Britain. The leaves are said to be emetic and vulnerary, but are little used.
- DIGITATED**, among botanists. See Vol. I. p. 640.
- DIGITUS**, in anatomy. See Vol. I. p. 181.
- DIGLYPH**, in architecture, a kind of imperfect triglyph, console, or the like, with two channels or engravings, either circular or angular.
- DIGNE**, a city and bishop's see of Provence in France, fifty-five miles north of Toulon: E. long.  $6^{\circ} 5'$ , and N. lat.  $44^{\circ} 6'$ .
- DIGNITARY**, in the canon law, a person who holds a dignity, that is, a benefice which gives him some pre-eminence over mere priests and canons. Such is a bishop, dean, arch-deacon, prebendary, &c.
- DIGNITY**, as applied to the titles of noblemen, signifies honour and authority.
- DIJON**, the capital of the province of Burgundy, in France, situated on the river Ouche, 140 miles south-east of Paris: E. long.  $5^{\circ} 5'$ , and N. lat.  $47^{\circ} 15'$ .
- DILATATION**, in physics, a motion of the parts of any body, by which it is so expanded as to occupy a greater space. This expansive motion depends upon the elastic power of the body, whence it appears that dilatation is different from rarefaction, this last being produced by the means of heat. See **MECHANICS**.
- DILATATOIRES**, in anatomy, a name given to several muscles in the human body. See **ANATOMY**, Part II.
- DILEMMA**, in logic, an argument consisting of two or more propositions, which divides the whole into all its parts, or members, by a disjunctive proposition, and then infers something concerning each part, which is finally referred to concerning the whole. See **LOGIC**.
- DILIGENCE**, in Scots law, signifies either that care and attention which parties are bound to give, in implementing certain contracts or trusts, and which varies according to the nature of the contract; as to which, see **SCOTS LAW**, title 7. 20. and 28.: Or it signifies certain forms of law, whereby the creditor endeavours to operate his payment, either by affecting the person or estate of the debtor; see title 18.
- DILL**, in botany. See **ANETHUM**.
- DILLEMBURG**, a city of the circle of the Upper Rhine in Germany, about forty miles north of Frankfurt, and subject to the house of Nassau: E. long.  $8^{\circ} 8'$ , and N. lat.  $50^{\circ} 45'$ .
- DILLENGEN**, a city of Swabia, in Germany, situated on the Danube, about twenty miles north-east of Ulm: E. long.  $10^{\circ} 20'$ , and N. lat.  $48^{\circ} 40'$ .
- DILLENIA**, in botany, a genus of the polyandria polygynia class. The calix consists of five leaves, and the corolla of five petals; and the capsule contains many seeds. There is but one species, a native of Malabar.
- DILUTE**. To dilute a body is to render it liquid; or, if it were liquid before, to render it more so, by the addition of a thinner thereto. These things thus added, are called diluents, or dilutors.
- DIMENSION**, in geometry, is either length, breadth, or thickness; hence, a line hath one dimension, *viz.* length; a superficies two, *viz.* length and breadth; and a body, or solid, has three, *viz.* length, breadth, and thickness.
- DIMINUTIVE**, in grammar, a word formed from some other, to soften or diminish the force of it, or to signify a thing is little in its kind. Thus, cellule is a diminutive of cell, globule of globe, hillock of hill.
- DIMORPHOTHECA**, in botany. See **CALENDULA**.
- DINANT**, a town of Germany in the bishopric of Liege, situated on the river Maese, about twelve miles south of Namur: E. long.  $4^{\circ} 50'$ , and N. lat.  $50^{\circ} 18'$ .
- DINGWEL**, or **DINGWAL**, a parliament-town of Scotland, situated at the west end of the Cromarty-bay, in the county of Ross: W. long.  $4^{\circ} 15'$ , and N. lat.  $57^{\circ} 56'$ . It classes with Dornock, Wick, and Kirkwall.
- DINKELSPIEL**, a city of Swabia, about forty miles north of Ulm, E. long.  $10^{\circ} 12'$ , and N. lat.  $49^{\circ}$ .
- DIocese**, denotes a particular district, or division, under the direction and government of a bishop.
- DIOCTAHEDRIA**, in natural history, a genus of pellucid and crystalliform spars, composed of two octangular pyramids, joined base to base, without any intermediate column. Of these some have long pyramids, others short and sharp-pointed ones, and others short and obtuse pointed ones; the two former species being found in the hartz-forest, and the last in the mines of Cornwall.
- DIODIA**, in botany, a genus of the tetrandria monogynia class. The corolla consists of one tunnel-shaped petal; and the capsule has two cells, containing as many seeds. There is but one species, a native of Virginia.
- DIODON**, in ichthyology, a genus belonging to the order of amphibia nantes. The jaws are bony, stretched out, and undivided; the aperture or mouth is a transverse

transverse line. The body is every way beset with sharp moveable prickles. It has no belly-fins. There are two species, viz. 1. The atringa, which is spherical, and has triangular prickles. It is a native of India. 2. The trylitrix, which is oblong, with cylindrical prickles, and is a native of the Cape of Good Hope.

**DIOMEDEA**, in ornithology, a genus belonging to the order of anseres. The bill is strait; the superior mandible is crooked at the point, and the lower one is truncated; the nostrils are oval, open, a little prominent, and placed on the sides. There are two species, viz. 1. The exulans, has pennated wings, and three toes on each foot. It is the abbatros of Edwards, and is found in the ocean betwixt the tropics, and at the Cape of Good Hope. It flies pretty high, feeds upon flying fish, and is about the size of a pelican. 2. The demersa, has no quill-feathers on the wings; and the feet have four toes, connected together by a membrane. It is the black penguin of Edwards, about the size of a goose, and is found at the Cape of Good Hope.

**DIONYSIA**, in Grecian antiquity, solemnities in honour of Bacchus, sometimes called by the general name of orgia; and by the Romans bacchanalia, and liberalia. See **BACCHANALIA**.

**DIOECIA**, in the Linnæan system of botany. See Vol. I. p. 635.

**DIOMEDIS AVIS**, in ornithology. See **PROCELLARIA**.

**DIOPTRICS**, the science of refractive vision. See **OPTICS**.

**DIOSCOREA**, in botany, a genus of the dioecia hexandria class. The calix both of the male and female consists of six segments, and they have no corolla. The female has three styli; the capsule is compressed, has three cells, and contains two membranaceous seeds. There are eight species, none of them natives of Britain.

**DIOSMA**, in botany, a genus of the pentandria monogynia class. The corolla has five petals; and the nectarium is shaped like a crown, is divided into five segments, and situate above the germen; it has five united capsules; and the seeds are furnished with calyptrae. There are nine species, none of them natives of Britain.

**DIOSPYROS**, in botany, a genus of the polygamia dioecia class. The calix of the hermaphrodite has four segments, and the corolla is uncolated, and has four segments; it has eight stamina, and a quadrifid stylus; and the berry contains eight seeds. The calix, &c. of the male are the same with the above. There are two species, none of them natives of Britain.

**DIOTOTHECA**, in botany. See **MORINA**.

**DIPHTHONG**, in grammar, a double vowel, or the mixture of two vowels pronounced together, so as to make one syllable. See **GRAMMAR**.

**DIPHYES**, among natural historians, an appellation given to stones resembling the male and female parts of generation in mankind.

**DIPLOE**, in anatomy, the soft medullium, or medul-

lary substance, which lies between the two laminae of the bones of the cranium. See **ANATOMY**, Part I.

**DIPLOMA**, an instrument or licence given by colleges, societies, &c. to a clergyman to exercise the ministerial function, or to a physician to practise the profession, &c. after passing examination, or admitting him to a degree.

**DIPLOMA**, in chemistry, &c. a double vessel. To boil in diplomate, is to set one vessel, containing the ingredients intended to be acted upon, in another larger vessel full of water, and to this last the fire is to be applied.

**DIPONDIUS**, in the scripture-language, is used by St Luke to signify a certain coin, which was of very little value: our translation of the passage is, *Are not two sparrows sold for two farthings?* In St Matthew, who relates the same thing, we read, *Are not two sparrows sold for a farthing?*

**DIPPING**, among miners, signifies the interruption, or breaking off, of the veins of ore; an accident that gives them a great deal of trouble before they can discover the ore again.

**DIPSACUS**, or **TEASEL**, in botany, a genus of the tetrandria monogynia class. The common calix consists of many leaves, and the proper one is above the fruit; and the receptacle is paleaceous. There are three species, all natives of Britain, viz. the sulonium, or manured teasel; the sylvestris, or wild teasel; and the pilosus, or small wild teasel.

**DIPSAS**, in zoology. See **COLUBER**.

**DIPTOTES**, in grammar, are such nouns as have only two cases, as *suppetia*, *suppetias*, &c.

**DIPTYCHS**, in antiquity, a public register, in which were written the names of the consuls and other magistrates among the heathens; and among the Christians, they were a sort of tablets, on one of which were written the names of the deceased, and on the other those of the living patriarchs, bishops, &c. or those who had done any service to the church, for whom prayers were offered, the deacon reading the names at mass.

**DIRECTION**, in mechanics, signifies the line or path of a body's motion, along which it endeavours to proceed, according to the force impressed upon it. See **MECHANICS**.

**DIRECTOR**, in commercial polity, a person who has the management of the affairs of a trading company: thus we say, the directors of the India company, South-sea-company, &c. See **COMPANY**.

The directors are considerable proprietors in the stocks of their respective companies, being chosen by plurality of votes from among the body of proprietors. The Dutch East-India company have sixty such directors; that of France, twenty one; the British East-India company has twenty-four, including the chairman, who may be re-elected for four years successively. These last have salaries of 150l. a-year each, and the chairman 200l. They meet at least once a week, and commonly oftener, being summoned as occasion requires.

**DIRECTOR**, in surgery, a grooved probe, to direct the edge

- edge of the knife or scissors, in opening sinuses, or fistulæ, that by this means the adjacent vessels, nerves, and tendons may remain unhurt. See SURGERY.
- DIRIGENT**, or **DIRECTRIX**, a term in geometry, signifying the line of motion, along which the describent line or surface is carried in the genesis of any plane or solid figure.
- DIS**, an inseparable article prefixed to divers words, the effect whereof is either to give them a signification contrary to what the simple words have, as *disoblige*, *disobey*, &c. or to signify a separation, detachment, &c. as *disposing*, *distributing*.
- DISC**, in antiquity, a quoit made of stone, iron, or copper, five or six fingers broad, and more than a foot long, inclining to an oval figure, which they hurled in form of a bowl, to a vast distance, by the help of a leathern thong tied round the person's hand who threw it, and put through a hole in the middle. Homer has made Ajax and Ulysses great artists at this sport.
- DISC**, in astronomy, the body and face of the sun and moon, such as it appears to us on the earth; or the body or face of the earth, such as it appears to a spectator in the moon.
- DISC**, in optics, is the width of the aperture of telescopic glasses, whatever their form be, whether plain, convex, concave, &c.
- DISCERNING**, or **DISCERNMENT**, among logicians, a faculty of the mind, whereby it distinguishes between ideas.
- DISCIPLE**, one who learns any thing from another: thus, the followers of any teacher, philosopher, &c. are called disciples. In the Christian sense, they were followers of Jesus Christ, in general; but in a more restrained sense, the disciples denote those alone who were the immediate followers and attendants on his person, of which there were seventy or seventy-two. The names *disciple* and *apostle* are often synonymously used in the gospel-history; but sometimes the apostles are distinguished from disciples, as persons selected out of the number of disciples, to be the principal ministers of his religion; of these there were only twelve. The Latins kept the festival of the seventy or seventy-two disciples on July 15th, and the Greeks on January 4th.
- DISCIPLINE**, in a general sense, denotes instruction and government; as military discipline, ecclesiastical discipline, &c.
- DISCLAMATION**, in Scots law, is that casualty whereby a vassal forfeited his feu to his superior, by disowning or disclaiming him as such without sufficient reason. See SCOTS LAW, title 12.
- DISCORD**, in music, the relation of two sounds which are always and of themselves disagreeable, whether applied in succession or consonance.
- DISCOUNT**, in commerce, a term among traders, merchants, and bankers. It is used by the two former on occasion of their buying commodities on the usual time of credit, with a condition that the seller shall allow the buyer a certain discount at the rate of so much *per cent. per annum*, for the time for which the credit is generally given, upon condition that the buyer pays ready money for such commodities, instead of taking the time of credit.
- DISCRETE**, or **DISJUNCT PROPORTION**, is when the ratio of two or more pairs of numbers or quantities is the same, but there is not the same proportion between all the four numbers. Thus if the numbers 3 : 6 :: 8 : 16 be considered, the ratio between 3 : 6, is the same as that between 8 : 16, and therefore the numbers are proportional; but it is only discretely or disjunctly, for 3 is not to 6 as 6 to 8; that is, the proportion is broken off between 8 and 3, and is not continued as in the following continual proportionals, 3 : 6 :: 12 : 24.
- DISCUS**, in antiquity. See **DISC**.
- DISCUSSION**, in matters of literature, signifies the clear treating or handling of any particular point, or problem, so as to shake off the difficulties with which it is embarrassed: thus we say, such a point was well discussed, when it was well treated of and cleared up.
- DISCUTIENTS**, in medicine, are such remedies, as, by their subtilty, dissolve a stagnating or coagulated fluid, and dissipate the same without an external solution of continuity.
- DISDIAPASON**, or **BISDIAPASON**, in music, a compound concord, described by F. Parran, in the quadruple ratio of 4 : 1, or 8 : 2.
- DISDIAPASON-DIAPENTE**, a concord in a sextuple ratio of 1 : 6.
- DISDIAPASON-SEMI-DIAPENTE**, a compound concord in the proportion of 16 : 3.
- DISDIAPASON-DITONE**, a compound consonance in the proportion of 10 : 2.
- DISDIAPASON-SEMI-DITONE**, a compound concord in the proportion of 24 : 5.
- DISEASE**, in medicine, that state of a living body, wherein it is deprived of the exercise of any of its functions, whether vital, natural, or animal. See **MEDICINE**.
- DISFRANCHISING**, among civilians, signifies the depriving a person of the rights and privileges of a free citizen or subject.
- DISJUNCTIVE**, something that separates or disjoins. Thus, *or*, *neither*, &c. which in connecting a discourse yet separates the parts of it, are called disjunctive conjunctions.
- DISLOCATION**, in surgery. See **LUXATION**.
- DISMA**, a town of Japan, separated from Nanquesacque, only by a narrow canal. The Dutch have a very fine magazine there.
- DISPENSARY**, or **DISPENSATORY**, denotes a book containing the method of preparing the various kinds of medicines used in pharmacy. Such are those of Bauderon, Quercetan, Zwelfer, Charas, Bates, Mesue, Salmon, Lemery, Quincy, &c. but the latest and most esteemed are the Edinburgh and London Dispensatories.
- DISPENSARY**, or **DISPENSATORY**, is likewise a magazine or office for selling medicines at prime cost to the poor.

DIS-



**DISPENSATION**, in law, the granting a license of doing some certain action that otherwise is not permitted.

**DISPLAYED**, in heraldry, is understood of the position of an eagle, or any other bird, when it is erect, with its wings expanded or spread forth. See Plate LXVIII fig. 8.

**DISPONDEE**, in the Greek and Latin poetry, a double spondee or foot, consisting of four long syllables, as māēcēnātēs cōnclūdētēs.

**DISPOSITION**, in Scots law, is that deed or writing which contains the sale or grant of any subject: when applied to heritable subjects, it in some cases gets the name of charter, which differs from a disposition in nothing else than a few immaterial forms. See **CHARTER**.

**DISPOSITION**, in rhetoric, the placing words in such an order as contributes most to the beauty and sometimes even to the strength of a discourse.

**DISQUISITION**, a serious and exact examination into the circumstances of any affair, in order to discourse clearly about it.

**DISS**, a market-town of Norfolk, on the river Waveney, sixteen miles south of Norwich.

**DISSECTION**, in anatomy, the cutting up a body, with a view of examining the structure and use of the parts. See **ANATOMY**.

**DISSEISIN**, in law, an unlawful dispossessing a person of his lands or tenements.

**DISSENTERS**, separatists from the service and worship of any established church.

**DISSIPATION**, in physics, an insensible loss or consumption of the minute parts of the body; or, that flux whereby they fly off, and are lost.

*Circle of DISSIPATION*, in optics, is used for that circular space upon the retina, which is taken up by one of the extreme pencils or rays issuing from an object. See **OPTICS**.

**DISSOLVENT**, in general, whatever dissolves or reduces a solid body into such minute parts as to be sustained in a fluid. See **CHEMISTRY**.

**DISSONANCE**, in music. See **DISCORD**.

**DISSYLLABLE**, among grammarians, a word consisting only of two syllables: such are nature, science, &c.

**DISTAFF**, an instrument about which flax is tied in order to be spun.

**DISTANCE**, in general, an interval between two things, either with regard to time or place.

*Accessible DISTANCES*, in geometry, are such as may be measured by the chain, &c. See **GEOMETRY**.

*Inaccessible DISTANCES*, are such as cannot be measured by the chain, &c. by reason of some river, or the like, which obstructs our passing from one object to another. See **GEOMETRY**.

**DISTASTE** properly signifies an aversion or dislike to certain foods; and may be either constitutional, or owing to some disorder of the stomach.

**DISTEMPER**, among physicians, the same with disease. See **DISEASE**.

**DISTEMPER**, in painting, a term used for the working up of colours with something besides water or oil. If the colours are prepared with water, that kind of painting is called limning; and if with oil, it is called painting in oil, and simply painting. If the colours are mixed with size, whites of eggs, or any such proper glutinous or unctuous matter, and not with oil, then they say it is done in distemper.

**DISTENSION**, in general, signifies the stretching or extending a thing to its full length or breadth.

**DISTICH**, a couplet of verses making a complete sense. Thus hexameter and pentameter verses are disposed in distichs.

**DISTICHIASIS**, in surgery, a disease of the eye-lids, when under the ordinary eye-lashes there grows another extraordinary row of hair, which frequently eradicates the former, and pricking the membrane of the eye, excites pain, and brings on a defluxion.

**DISTILLATION**, in chemistry, the act of drawing off the spiritous, aqueous, oleaginous, or saline parts of a mixed body from the grosser and more terrestrial parts by means of fire, and collecting and condensing them again by cold. The end of distillation is of two kinds: the first, and by far the most general, is for the separation of some acquired bodies from others with which they were mixed, as in the case of vinous and volatile spirits, and essential oils: the other is for the quicker and more effectual combination of such bodies, whose mixture is assisted by a boiling heat, as in the case of spir. nitr. dulc. See **CHEMISTRY**.

*The method of distilling malt-wash, or a fermented mixture of meal and malt, for spirit.* Fill two thirds of a still, first moistened by the steam of boiling water, with malt-wash; immediately clap on the head, and lute it down; there will soon run a spirituous inflammable liquor. Thus is obtained what the malt-distillers call a malt low-wine; what comes over after the spirit falls off from being proof, is called faints. This experiment may be rendered general, with slight variation; for if any wine, beer, or fermented liquor from sugar, treacle, or fruits, &c. be thus treated, it affords a spirit differing only according to the nature of the subject; but none of them will afford the least inflammable spirit without a previous fermentation. The requisite cautions for success are, 1. That the fermentation be well performed, 2. That it be gently distilled, with a soft well regulated fire. 3. That the grosser oil, apt to rise along with the spirit, be let out by flannel under the nose of the worm. These cautions observed, the low-wines will be pure and vinous.

*The method of distilling the lower wines into proof spirits for sale.* The lower wines of the last process, distilled in a bath-heat, give a higher rectified spirit than before, which being let down with fair water to a certain size or standard, called proof, is what the malt-distillers understand by proof-goods, or their rectified malt-spirit.

The inconveniencies of this art, on account of the many large vessels required, which increase the labour and price of the commodity, might perhaps be remedied by the introduction of a new art, subservient to the malt-distillers, and confined to the boiling down the malt-wort to a rob; wherefore it were to be wished, that those who were skilled in this branch of distillation

lation would try whether a spirit superior to that of treacle may not be procured from the rob of malt, prudently prepared and fermented. See CHEMISTRY.

- DISTINCT BASE**, in optics, is that distance from the pole of a convex glass, in which objects beheld through it appear distinct and well described; so that it is the same with the focus. See OPTICS.
- DISTINCTION**, in logic, is an assemblage of two or more words, whereby disparate things, or their conceptions, are denoted.
- DISTORTION**, in medicine, a contraction of one side of the mouth, occasioned by a convulsion of the muscles of one side of the face: and it is likewise used to denote any part of an animal body when it is ill placed or ill favoured.
- DISTRESS**, in Scots law. When a person makes payment of a debt not voluntarily, but in obedience to legal diligence, he is said to have paid in distress.
- DISTRIBUTION**, in printing, the taking a form asunder, separating the letters, and disposing them in the cases again, each in its proper box. See PRINTING.
- DISTRICT**, in geography, a part of a province, distinguished by peculiar magistrates, or certain privileges, in which sense it is synonymous with hundred. See HUNDRED.
- DISTRINGAS**, in law, a writ commanding the sheriff, or other officer, that he distrain a person for debt to the king, &c. or for his appearance at a certain day.
- DISTRINGAS JURATORES**, a writ directed to the sheriff, whereby he is commanded to distrain upon a jury to appear, and to return issues on their lands, &c. for non-appearance. This writ of distringas juratores issues for the sheriff to have their bodies in court, &c. at the return of the writ.
- DITHYRAMBUS**, in ancient poetry, a hymn in honour of Bacchus, full of transport and poetical rage.
- DITONE**, in music, an interval comprehending two tones. The proportion of the sounds that form the ditone is 4 : 5, and that of the semiditone is 5 : 6.
- DITRIHEDRIA**, in mineralogy, a genus of spars with twice three sides, or six planes, being formed of two trigonal pyramids joined base to base, without any intermediate column. See SPAR.
- The species of ditrihedria are distinguished by the different figures of these pyramids.
- DITTANY**, in botany. See DICTAMNUS.
- DITTO**, usually written D<sup>o</sup>, in books of accounts, an Italian word, signifying *the aforementioned*.
- DIVAL**, in heraldry, the herb nightshade, used by such as blazon by flowers and herbs, instead of colours and metals, for sable, or black.
- DIVALLIA**. See ANGERONALIA.
- DIU**, a little island and town on the coast of Guzurat, in the hither India, and subject to Portugal: E. long. 69°, N. lat. 21° 15'.
- DIU** is also a town of Bulgaria, upon the Danube.
- DIVAN**, a council-chamber, or court of justice, among the eastern nations, particularly the Turks.
- DIVAN-BEGHI**, the superintendent of justice in Persia,

whose place is the last of the six ministers of the second rank, who are all under the athemadauler, or first minister. To this tribunal of the divan-beghi he appeals from sentences passed by the governors: he has a fixed stipend of 50,000 crowns for administering justice: all the serjeants, ushers, &c. of the court, are in his service: he takes cognizance of the criminal causes of the chams, governors, and other great lords of Persia, when accused of any fault. There are divan-beghis not only at court and in the capital, but also in the provinces and other cities of the empire. The alcoran is the sole rule of his administration of justice, which also he interprets at pleasure. He takes no cognizance of civil causes, but all differences arising between the officers of the king's household, and between foreign ministers, are determined by him.

- DIVANDUROW**, the name of seven islands which lie a league north of the Maldives, and twenty-four from the coast of Malabar, almost opposite to Cananor.
- DIVER**, in ornithology. See COLYMBUS.
- DIVERGENT**, or **DIVERGING LINES**, in geometry, are those which constantly recede from each other.
- DIVERGENT RAYS**, in optics, are those which going from a point of the visible object, are dispersed, and continually depart one from another, in proportion as they are removed from the object: in which sense it is opposed to convergent. See OPTICS.
- DIVERSION**, in military affairs, is, when an enemy is attacked in one place where they are weak and unprovided, in order to draw off their forces from another place where they have made or intend to make an irruption. Thus the Romans had no other way in their power of driving Hanibal out of Italy, but by making a diversion in attacking Carthage.
- DIVESTING**, or **DIVESTITURE**, in law, is used for the act of surrendering one's effects.
- DIVIDEND**, in arithmetic, the number proposed to be divided into equal parts. See ARITHMETIC.
- DIVIDEND of stocks**, is a share or proportion of the interest of stocks erected on public funds, as the south-sea, &c. divided among and paid to the adventurers half yearly.
- DIVINATION**, the knowledge of things obscure, or future, which cannot be attained by any natural means.
- It was a received opinion among the heathens, that the gods were wont to converse familiarly with some men, whom they endowed with extraordinary powers, and admitted to the knowledge of their councils and designs. Plato, Aristotle, Plutarch, Cicero, and others, divide divination into two sorts or species, *viz.* natural and artificial. The former was so called, because not attained by any rules or precepts of art, but infused or inspired into the diviner, without his taking any further care about it, than to purify and prepare himself for the reception of the divine afflatus. Of this kind were all those who delivered oracles, and foretold future events by inspiration, without observing external signs or accidents. The second species of divination was called artificial, because it was not obtained by immediate inspiration, but was the effect of experience and observation.

- observation. Such was southfaying, as depending upon human art and invention, which however was supposed not to be altogether destitute of divine direction and concurrence, and such was divination by lots. Of this sort there were various kinds, as by sacrifices, entrails, flame, cakes, flour, wine, water, augury, birds, lots, verses, omens, &c.
- DIVINE**, something relating to God.
- DIVING**, the art of descending under water, to considerable depths, and abiding there a competent time; the uses of which are considerable, particularly in fishing for pearls, corals, sponges, wrecks of ships, &c. See **PNEUMATICS**.
- DIVINITY**, properly signifies the nature, quality, and essence of God.
- DIVINITY** is also used in the same sense with theology.
- DIVISIBILITY**, that property by which the particles of matter in all bodies are capable of separation or disunion from each other. See **MECHANICS**.
- DIVISION**, in general, is the separating a thing into two or more parts.
- DIVISION**, in arithmetic. See Vol. I. p. 376.
- DIVISION**, in algebra. See Vol. I. p. 82.
- DIVISOR**, in arithmetic. See Vol. I. p. 376.
- DIUL**, a port-town of Asia, situated on the Indian ocean, westward of the river Indus, and sixty miles west of the city of Tatta: E. long. 67°, and N. lat. 25° 15'.
- DIVORCE**, is the legal dissolution of a marriage which can be obtained at the suit of the injured party, upon the grounds of adultery or wilful desertion proved against the other. See **SCOTS LAW**, title 6.
- DIURESIS**, in medicine, an excretion of urine: whence,
- DIURETICS**, in pharmacy, such simples as increase the discharge of urine; or which are supposed to have a power of removing obstructions in the urinary passages.
- DIURNAL**, in astronomy, something relating to the day; in opposition to nocturnal, which regards the night.
- DIZIER**, or **St Dizier**, a city of Champaign in France, situated on the river Marne, about forty-five miles north-east of Troyes: E. long. 5°, and N. lat. 48° 32'.
- DIZOSTOS**, in botany. See **EUPHORBIA**.
- DIZZINESS**, in medicine, See **VERTIGO**.
- DO**, in music, a note of the Italian scale, corresponding to *ut* of the common gamut. See **MUSIC**.
- DOB-CHICK**, in ornithology. See **COLYMBUS**.
- DOBLAC**, a town of the Tyrollese, in Germany, situated at the foot of the Alps, about two miles north of the frontiers of the state of Venice.
- DOCIMASIA**, in Greek antiquity, a probation of the magistrates and persons employed in public business at Athens. It was performed publicly in the forum, where they were obliged to give account of themselves and their past life before certain judges. Among several questions proposed to them, we find the following, whether they had been dutiful to their parents, had served in the wars, and had a competent estate.
- DOCK**, in botany. See **LAPATHUM**.
- DOCK**, in maritime affairs, is a pit, great pond, or creek, by the side of an harbour, made convenient either for the building or repairing of ships.
- DOCK-YARDS**, in ship-building, are magazines of all sorts of naval stores. The principal ones in England are those of Chatham, Portsmouth, Plymouth, Woolwich, Deptford, and Sheerness. In time of peace, ships of war are laid up in these docks; those of the first-rates mostly at Chatham, where, and at other yards, they receive from time to time such repairs as are necessary. These yards are generally supplied from the northern crowns with hemp, pitch, tar, rosin, &c. but as for masts, particularly those of the larger size, they are brought from New England.
- DOCTOR**, a person who has passed all the degrees of a faculty, and is empowered to teach or practise the same: thus we say, doctor in divinity, doctor in physic, doctor of laws.
- The title of doctor seems to have been created in the XIIth century, instead of *master*, and established with the other scholastic degrees of bachelors and licentiates, by Peter Lombard and Gilbert Porreus, then the chief divines of the university of Paris. Gratian did the same thing, at the same time, in the university of Bologna.
- DOCTOR of the law**, a title of honour among the Jews. The investiture, if we may so say, of this order was performed by putting a key and table book in their hands, which is what some authors imagine our Saviour had in view, Luke xi. 52. when speaking of the doctors of the law, he says, "Wo unto you, doctors of the law, for you have taken away the key of knowledge: you entered not in yourselves, and them that were entering you hindered."
- DOCTORS-COMMONS**. See **COLLEGE of civilians**.
- DOCUMENT**, in law, some written monument produced in proof of any thing asserted.
- DODARTIA**, in botany, a genus of the didynamia angiospermia class. The calix has five teeth; the inferior labium is much less than the superior; and the capsule is roundish, and has two cells. There are two species, none of them natives of Britain.
- DODDER**, in botany. See **CUSCUTA**.
- DODECAGON**, in geometry, a regular polygon consisting of twelve equal sides and angles.
- DODECAHEDRON**, in geometry, one of the platonic bodies, or regular solids, contained under twelve equal and regular pentagons.
- DODECANDRIA**, in the Linnæan system of botany. See Vol. I. p. 635.
- DODO**, in ornithology. See **DIDUS**.
- DODONÆA**, in botany. See **PTELEA**.
- DODRANS**, in antiquity, three fourths of the as. See **As**.
- DOESBURG**, a town of the United Netherlands, in the province of Guelderland, situated on the river Yssel, about nine miles south of Zutphen: E. long. 6°, and N. lat. 52°.
- DOG**, in zoology. See **CANIS**.
- DOG'S BANE**, in botany. See **APOCYNUM**.

**DOG-DAYS.** See **CANICULAR.**

**DOG'S FENNEL,** in botany. See **COTULA.**

**DOG'S MERCURY,** in botany. See **MERCURIALIS.**

**DOG'S ROSE.** See **ROSA.**

**DOG'S STONES,** in botany. See **ORCHIS.**

**DOG'S TAIL,** in botany. See **CYNOSURUS.**

**DOG'S TONGUE,** in botany. See **CYNOGLOSSUM.**

**DOG'S TOOTH,** in botany. See **ERYTHRONIUM.**

**DOGE,** the chief magistrate in the republics of Venice and Genoa.

This dignity is elective in both places; at Venice it continues for life; at Genoa, it is only for two years. His title is Serenity: he is chief of the council, and mouth of the republic, he being to answer for her. The Venetians do not go into mourning at his death, being only the phantom of majesty, as all the authority is vested in the republic; the doge only lends his name to the senate; the power is diffused through the whole body; though answers to foreign ambassadors, &c. are made in the name of the doge. The money is struck in his name, but does not bear his arms. All the magistrates rise and salute him when he comes into the council: but he rises to none but foreign ambassadors. He must not stir out of Venice, without leave of the counsellors, &c.

**DOGGERS,** a name used for fishing vessels; whence, in some of our old statutes, we meet with dogger-men, denoting the fishermen of those vessels.

**DOGMA,** a principle, maxim, tenet, or settled opinion, particularly with regard to matters of faith and philosophy.

**DOGMATICAL,** something belonging to a doctrine or opinion. A dogmatical philosopher is one who asserts things positively; in opposition to a sceptic, who doubts of every thing.

**DOGMATISTS,** a sect of ancient physicians, of which Hippocrates was the first author. They are also called *logici*, logicians, from their using the rules of logic in subjects of their profession. They laid down definitions and divisions reducing diseases to certain genera, and those genera to species, and furnishing remedies for them all; supposing principles, drawing conclusions, and applying those principles and conclusions to particular diseases under consideration: in which sense the dogmatists stand contradistinguished from empirics and methodists. They reject all medicinal virtues that they think not reducible to manifest qualities: but Galen hath long ago observed of such men, that they must either deny plain matter of fact, or assign but very poor reasons and causes of many effects they pretend to explain.

**DOLE,** in our ancient customs, signified a part or portion, most commonly of a meadow, where several persons have shares. It also still signifies a distribution or dealing of alms, or a liberal gift made by a great man to the people.

**DOLF,** in Scots law, signifies a malevolent intention. It is essential in all crimes that it be committed intentionally, or by an act of the will; hence the rule, *Crimen doli contrahitur.* See **SCOTS LAW**, title 35.

**DOLICHOS,** in botany, a genus of the diadelphia decandria class of plants, the corolla of which is papilionaceous; the vexillum is roundish, large, emarginated, and wholly reflected; the fruit is a large, acuminate, oblong pod, composed of two valves, and containing two cells; the seeds are numerous, elliptical, and frequently compressed. There are twenty-five species, none of them natives of Britain.

**DOLLAR,** a silver coin current in several parts of Germany and Holland. There are various species of dollars, as the rix-dollar, the semi-dollar, the quarter-dollar, &c.

**DOLPHIN,** in ichthyology. See **DELPHINUS.**

**DOM,** or **DON,** a title of honour, invented and chiefly used by the Spaniards, signifying, sir, or lord.

This title, it seems, was first given to Pelayo, in the beginning of the VIIIth century. In Portugal no person can assume the title of don, without the permission of the king, since it is looked upon as a mark of honour and nobility.

**DOMAIN,** the inheritance, estate, or possession of any one. See **DEMESNE.**

**DOVE,** in architecture, a spherical roof, or a roof of a spherical form, raised over the middle of a building, as a church, hall, pavilion, vestibule, stair-case, &c. by way of crowning.

**DOVE,** or **DOOM,** signifies also a sentence, judgment, or decree.

**DOMESDAY,** or **DOOMSDAY-BOOK,** a very ancient record made in the time of William the Conqueror, which now remains in the exchequer, and consists of two volumes, a greater and a less; the greater contains a survey of all the lands in most of the counties in England, and the less comprehends some counties that were then surveyed. The book of domesday was begun by five justices, assigned for that purpose in each county, in the year 1081, and finished in 1086. It was of that authority, that the conqueror himself submitted, in some cases wherein he was concerned, to be determined by it. Camden calls this book the tax-book of king William; and it was farther called *Magna rolla.*

There is likewise a third book of Domesday, made by command of the conqueror; and also a fourth, being an abridgment of the other books.

**DOMESTIC,** any man who acts under another, serving to compose his family; in which he lives, or is supposed to live, as a chaplain, secretary, &c. Sometimes domestic is applied to the wife and children, but very seldom to servants, such as footmen, lacquies, porters, &c.

**DOMICILE,** in Scots law, is the dwelling place where a person lives with an intention to remain. See **SCOTS LAW**, title 2.

**DOMIFYING,** in astrology, the dividing or distributing the heavens into twelve houses, in order to erect a theme, or horoscope, by means of six great circles, called circles of position.

There are various ways of domifying: that of regiomontanus, which is the most common, makes the circles

circles of position pass through the intersections of the meridian and the horizon: others make them pass through the poles of the zodiac.

**DOMINATION**, in theology, the fourth order of angels, or blessed spirits, in the hierarchy, reckoning from the seraphim.

**DOMINGO**, or **ST DOMINGO**, the capital of the island of Hispaniola, the see of an archbishop, and the most ancient royal audience in America: W. long. 70°, N. lat. 18° 20'.

**DOMINICA**, one of the Caribbee-islands, subject to Britain: W. long. 61° 20', N. lat. 16°.

**DOMINICAL LETTER**. See **ASTRONOMY**, p. 495.

**DOMINICANS**, an order of religious, called in France Jacobins, and in England Black friars, or preaching-friars. This order founded by St Dominic, a native of Spain, was approved of by Innocent III. in 1215, and confirmed by a bull of Honorius III. in 1216. The design of their institution was to preach the gospel, convert heretics, defend the faith, and propagate Christianity. They embraced the rule of St Augustine, to which they added statutes and constitutions, which had formerly been observed either by the Carthusian or Præmonstratenses. The principal articles enjoined perpetual silence, abstinence from flesh at all times, wearing of woollen, rigorous poverty, and several other austerities. This order has spread into all the parts of the world. It has produced a great number of martyrs, confessors, bishops; and they reckon three popes, sixty cardinals, 150 archbishops, and 800 bishops of their order, besides the masters of the sacred palace, who have always been Dominicans. They are inquisitors in many places:

**DOMINION**, in the civil law, signifies the power to use or dispose of a thing as we please.

**DOMINIUM *eminens***, in Scots law, that power which the state or sovereign has over private property, by which the proprietor may be compelled to sell it for an adequate price where public utility requires. See **SCOTS LAW**, title 8.

**DOMINIUM *directum***, in Scots law, the right which a superior retains in the lands, notwithstanding the feudal grant to his vassal. See **SCOTS LAW**, title 12.

**DOMINIUM *utile***, in Scots law, the right which the vassal acquires in the lands by the feudal grant from his superior. See **SCOTS LAW**, title 13.

**DON**, the name of two rivers; one very large, which, after dividing Asia from Europe, falls into the Palus Meotis; the other in the county of Aberdeen in Scotland.

**DONATION**, in Scots law, signifies a voluntary gift. Donation betwixt husband and wife; see **SCOTS LAW**, title 6—When revocable; Not presumed *in dubio*;—Donations *mortis causa*: See title 22.

**DONATISTS**, Christian schismatics in Africa, who took their name from their leader Donatus. A secret hatred against Cæcilian, elected bishop of Carthage about the year 311, excited Donatus to form this sect. He accused Cæcilian of having delivered up the sacred books to the Pagans, and pretended that his election

was void, and all his adherents heretics. He taught that baptism administered by heretics was null, that every church but the African was become prostituted, and that he was to be the restorer of religion. Some accuse the Donatists of Arianism. Constantius and Honorius made laws for their banishment, and Theodosius and Honorius condemned them to grievous punishments.

**DONATIVE**, a gratuity, or present made to any person.

Donative among the Romans was properly a gift made to the soldiers, as *congiarium* was that made to the people.

**DONATORY**, in Scots law, that person to whom the king bestows his right to any forfeiture that has fallen to the crown.

**DONAWERT**, a city of Bavaria in Germany, forty miles north-west of Ulm: E. long. 10° 40', N. lat. 48° 40'.

**DONAX**, a genus of insects belonging to the order of vermes testacea. It is an animal of the oyster kind; and the shell has two valves, with a very obtuse margin in the fore-part. There are ten species, principally distinguished by the figure of their shells.

**DONCASTER** a market-town of Yorkshire, thirty miles south of York. See **YORK**.

**DONOR**, in law, the person who gives lands or tenements to another in tail, &c. as he to whom such lands, &c. are given is the donee.

**DONZY**, a town of France in the Orleannois: E. long. 3° 16', N. lat. 47° 17'.

**DOOR**, in architecture. See **ARCHITECTURE**, p. 356.

**DORCHESTER**, the capital of Dorsetshire, situated on the river Frome, six miles north of Weymouth: W. long. 2° 35', and N. lat 50° 40'. It gives the title of marquis to the noble family of Pierpoint, dukes of Kingston, and sends two members to parliament.

**DORDONNE**, a river of France, which runs through the province of Guienne, and falls into the Garonne, twelve miles below Bourdeaux.

**DOREE**, or **JOHN DOREE**, in ichthyology. See **ZEUS**.

**DORIA**, in botany. See **SOLIDAGO**.

**DORIC**, in general, any thing belonging to the Dorians, an ancient people of Greece, inhabiting near mount Parnassus.

**DORIC ORDER** in architecture. See Vol. I. p. 351.

**DORIC DIALECT**, one of the five dialects, or manners of speaking which were principally in use among the Greeks.

It was first used by the Lacedæmonians, particularly those of Argos; afterwards it passed into Epirus, Lybia, Sicily, and the islands of Rhodes, Crete, &c.

**DORIC MODE**, in music, the first of the authentic modes of the ancients; its character is to be severe, tempered with gravity and joy; and is proper upon religious occasions, as also to be used in war. It begins *D, la, sol, re*. Plato admires the music of the doric mode, and judges it proper to preserve good manners, as be-

- ing masculine; and on this account allows it in his commonwealth. The ancients had likewise their sub-doric or hypodoric mode, which was one of the plagal modes. Its character was to be very grave and solemn: it began with *re*, a fourth lower than the doric.
- DORMANT**, in heraldry, is used for the posture of a lion, or any other beast, lying along in a sleeping attitude, with the head on the fore-paws; by which it is distinguished from the couchant, where though the beast be lying, yet he holds up his head.
- DORMER**, in architecture, signifies a window made in the roof of an house, or above the entablature, being raised upon the rafters.
- DORMITORY**, a gallery in convents or religious houses, divided into several cells, in which the religious sleep or lodge.
- DORONICIS AFFINIS**; in botany. See **GERBERA**.
- DORONICUM**, **LEOPARD'S BANE**, in botany, a genus of the syngenesia polygamia superflua class. The receptacle is naked; the pappus is simple; the scales of the calix are equal, and longer than the disc; and the seeds in the radius are naked, and have no pappus. There are three species, none of them natives of Britain.
- DORPT**, or **DORPAT**, a city of Livonia, about fifty miles south of Narva: E. long. 27° 25', and N. lat. 58°.
- DORSAL**, an appellation given to whatever belongs to the back. See **DORSUM**.
- DORSAL MUSCLES**. See **ANAT. PART. II.**
- DORSIFEROUS PLANTS**, among botanists, such as are of the capillary kind, without stalks, and which bear their seeds on the back-side of their leaves.
- DORSTENIA**, in botany, a genus of the tetrandria monogynia class. The common receptacle consists of one fleshy leaf, in which the solitary seeds are contained. There are four species, none of them natives of Britain.
- DORSUM**, **BACK**, in anatomy, comprehends all the posterior part of the trunk of the body, from the neck to the buttocks. See **ANATOMY**.
- DORT**, a city of the United Provinces, situated in that of Holland, on an island in the river Maese, about ten miles east of Rotterdam: E. long. 4° 40', and N. lat. 51° 47'.
- DORTMONT**, a city of Westphalia in Germany, about thirty miles north-east of Dusseldorp: E. long 6° 50', and N. lat. 51° 25'. It is an imperial city, and constitutes a sovereign state.
- DORTMANNIA**, in botany. See **LOBELIA**.
- DORYCNIUM**, in botany. See **CONVOLVULUS**.
- DORYPHORI**, in antiquity, an appellation given to the life guard men of the Roman emperors.
- DOSITHEANS**, in church-history, a sect among the Hebrews, being one of the branches of the Samaritans. See **SAMARITANS**.
- They obtained from eating any creature that had life, and were so superstitious in keeping the sabbath, that they remained in the same place and posture wherein that day surpris'd them, without stirring till the next day. They married but once, and a great number ne-
- ver married. Dositheus, their founder, being dissatisfied among the Jews, retired to the Samaritans, who were reputed heretics, and invented another sect; and to make it more authentic, he went into a cave, where, by too long abstinence, he killed himself. The name of Dositheans was also given to some of the disciples of Simon Magus.
- DOTTEREL**, in ornithology. See **CHARADRIUS**.
- DOUAY**, a fortified city of the French Netherlands, situated on the river Scrape, about fifteen miles south of Lisle: E. lon. 3°, and N. lat. 50° 25'.
- DOUBLE FICHU**, or **FICHÉ'**, in heraldry, the denomination of a cross, when the extremity has two points, in contradistinction to fiché, where the extremity is sharpened away to one point. See **PLATE LXVIII. fig. 8.**
- DOUBLETS**, a game on dice within tables: the men, which are only fifteen, being placed thus; upon the six, cinque, and quater points, there stand three men a-piece; and upon the trey, duce, and ace, only two. He that throws highest hath the benefit of throwing first, and what he throws he lays down, and so doth the other: what the one throws, and hath not, the other lays down for him, but on his own account; and thus they do till all the men are down, and then they bear. He that is down first bears first, and will doubtless win the game, if the other throws not doublets to overtake him; which he is sure to do, since he advances or bears as many as the doublets make, *viz.* eight for two fours.
- DOUBLING**, in the military art, is the putting two ranks or files of soldiers into one. Thus, when the word of command is, *double your ranks*, the second, fourth, and sixth ranks march into the first, third, and fifth, so that the six ranks are reduced to three, and the intervals between the ranks become double what they were before.
- DOUBLING**, among hunters, who say that a hare doubles, when she keeps in plain fields, and winds about to deceive the hounds.
- DOUBLING**, in the menage, a term used of a horse, who is said to double his reins, when he leaps several times together, to throw his rider: thus we say, the ramingue doubles his reins, and makes pontlevis.
- DOUBLING a cape or point**, in navigation, signifies the coming up with it, passing by it, and leaving it behind the ship.
- DOUBLINGS**, in heraldry, the linings of robes and mantles of state, or of the mantlings in achievements.
- DOUBLON**, or **DUBLOON**, a Spanish and Portuguese coin, being the double of a pistole. See **PISTOLE**.
- DOUBTING**, the act of withholding our assent from any proposition, on suspicion that we are not thoroughly apprised of the merits thereof; or from not being able peremptorily to decide between the reasons for and against it.
- DOUCINE**, in architecture, a moulding concave above and convex below, serving commonly as a cymatium to a delicate cornice. It is likewise called *gula*.
- DOVE**, in ornithology. See **COLUMBA**.
- Dove**, in geography, the name of a river dividing Derbyshire

byshire from Staffordshire : also of a town of the Orleans, in France, about twenty miles south-east of Angers.

**DOVE-TAILING**, in carpentry, is the manner of fastening boards together by letting one piece into another, in the form of the tail of a dove. The dove-tail is the strongest of the assemblages or jointings, because the tenon, or piece of wood which is put into the other, goes widening to the extreme, so that it cannot be drawn out again, by reason the extreme or tip is bigger than the hole.

**DOVER**, a borough and port-town of Kent, situated on a rock, opposite to Calais in France, with a strong castle: E. long. 25', and N. lat. 51° 10'.

Dover gives the title of duke to the dukes of Queenbury, a branch of the noble family of Douglas; and sends two members to parliament, styled barons of the cinque ports, whereof Dover is the chief.

**DOUGLAS**, a port-town, and the best harbour in the Isle of Man: W. long. 4° 25', and N. lat. 54° 7'.

**DOWAGER**, a widow endowed, is a title applied to the widows of princes, dukes, earls, and persons of high rank only.

**DOWER**, that portion which the law allows a widow out of the lands of her husband, after his decease.

**DOWN**, in geography, the capital of a county of the same name in the province of Ulster, in Ireland: W. long. 5° 50', and N. lat. 54° 23'.

**DOWNETON**, or **DUNKTON**, a borough-town of Wiltshire, five miles south of Salisbury. It sends two members to parliament.

**DOWNHAM**, a market-town of Norfolk, ten miles south of Lynn, famous for its good butter; there being a thousand, and sometimes two thousand sirkins bought here every Monday, and sent up the river Ouse to Cambridge, from whence it is conveyed to London, in the Cambridge waggons.

**DOWNS**, a famous road near Deal, in Kent, where both the outward and homeward bound ships frequently make some stay; and squadrons of men of war rendezvous in time of war.

It affords excellent anchorage, and is defended by the castles of Deal, Dover, and Sandwich.

**DOWRY**, the money or fortune which the wife brings her husband in marriage: It is otherwise called *maritagium*, marriage-goods, and differs from dower.

**DOXOLOGY**, an hymn used in praise of the Almighty, distinguished by the title of greater and lesser.

The lesser doxology was anciently only a single sentence, without response, running in these words, *Glory be to the Father, and to the Son, and to the Holy Ghost, world without end. amen.* Part of the latter clause, *As it was in the beginning, is now, and ever shall be*, was inserted some time after the first composition. Some read this ancient hymn, *Glory be to the Father, and to the Son with the Holy Ghost.* Others, *Glory be to the Father in or by the Son, and by the Holy Ghost.* This difference of expression occasioned no disputes in the church, till the rise of the Arian heresy; but when the followers of Arius began to make

use of the latter as a distinguishing character of their party, it was entirely laid aside by the catholics, and the use of it was enough to bring any one under suspicion of heterodoxy. The doxology was used at the close of every solemn office. The western church repeated it at the end of every psalm, and the eastern church at the end of the last psalm. Many of their prayers were also concluded with it, particularly the solemn thanksgiving, or consecration prayer at the eucharist. It was also the ordinary conclusion of their sermons.

The greater doxology, or angelic hymn, was likewise of great note in the ancient church. It began with these words, which the angels sung at our Saviour's birth, *Glory be to God on high, &c.* It was chiefly used in communion service, and in mens private devotions. Both the doxologies have a place in the church of England, the former being repeated after every psalm, and the latter used in the communion service.

**DRABA**, in botany, a genus of the tetradynamia siliculosa class. The pod is entire and somewhat oval, with plain valves, and a parallel dissepimentum; it has no stylus. There are six species, three of them natives of Britain, viz. the verna, or common whitlow-grass; the muralis, or speedwell-leaved whitlow-grass; and the incana, or wreathen-podded whitlow-grass.

**DRABS**, in the salt-works, a kind of wooden boxes for holding the salt when taken out of the boiling pan, the bottoms of which are made shelving or inclining forwards, that the briny moisture of the salt may drain off.

**DRACHM**, a Grecian coin of the value of seven pence three-farthings.

**DRACO**, the **DRAGON**, in zoology, a genus belonging to the order of amphibia reptilia. The characters of which are these: It has four legs, a cylindrical tail, and two membranaceous wings, radiated like the fins of a fish, by which he is enabled to fly, but not to any great distance at a time. There are two species, 1. The volans, or flying dragon, with the wings entirely distinct from the fore-legs; it is found in Africa and the East Indies. 2. The præpos, with the wings fixed to the fore-legs; it is a native of America. They are both harmless creatures, and feed upon flies, ants, and small insects.

**DRACO VOLANS**, in meteorology, a fiery exhalation, frequent in marshy and cold countries.

It is most common in summer, and though principally seen playing near the banks of rivers, or in boggy places, yet sometimes mounts up to a considerable height in the air, to the no small terror of the amazed beholders; its appearance being that of an oblong, sometimes roundish, fiery body, with a long tail. It is entirely harmless, frequently sticking to the hands and cloaths of people without injuring them in the least.

**DRACO**, in astronomy, a constellation of the northern hemisphere. See **ASTRONOMY**, p 486.

**DRACOCEPHALUM**, **DRAGON'S HEAD**, in botany, a genus of the didynamia gymnospermia class. The

faux

- faux of the corolla is inflated, and the superior labium is concave. There are 13 species, none of them natives of Britain.
- DRACONTIC MONTH**, the time of one revolution of the moon, from her ascending node, called caput draconis, to her return thither.
- DRACONTIUM**, **DRAGONS**, in botany, a genus of the gymandria polyandria class. The spathe is shaped like a boat; the spadix is covered; it has no calix; the corolla consists of five petals; and the berry contains many seeds. There are five species, all natives of the Indies.
- DRACUNCULI**, in medicine, small long worms, which breed in the muscular parts of the arms and legs, called Guinea worms. See **MEDICINE**.
- DRACUNCULUS**, in botany. See **ARUM**.
- DRACUNCULUS**, in ichthyology. See **CALLIONYMUS**.
- DRAGOMAN**, **DRAGMAN**, or **DRUGGERMAN**, a name given in the Levant to the interpreters kept by the ambassadors of Christian nations, residing at the Porte, to assist them in treating of their master's affairs.
- DRAGON**, in zoology. See **DRACO**.
- DRAGON'S BLOOD**, in pharmacy, a resin brought from the East-Indies, either in oval drops, wrapped up in flag leaves, or in large masses composed of smaller tears. The fine dragon's blood of either sort breaks smooth, free from any visible impurities, of a dark red colour, which changes upon being powdered into an elegant bright crimson. It dissolves in pure spirit, and tinges a large quantity of the menstruum of a deep red colour; it is also soluble in oils. It is usually looked upon as a gentle astringent, and is sometimes prescribed against femoral gleets, the fluor albus, and other fluxes.
- DRAGON-FLY**. See **LIBELLA**.
- DRAGON-SHELL**. See **PATELLA**.
- DRAGONS**, in botany. See **DRACONTIUM**.
- DRAGONNE'E**, in heraldry; a lion dragonnée is where the upper half resembles a lion, the other half going off like the hinder part of a dragon. The same may be said of any other beast as well as a lion.
- DRAGOON**, in military affairs, a musqueteer, mounted on horseback, who sometimes fights or marches on foot, as occasion requires.
- Dragoons are divided into brigades, as the cavalry, and each regiment into troops; each troop having a captain, lieutenant, cornet, quarter-master, two serjeants, three corporals, and two drums. Some regiments have hautboys: they are very useful on any expedition that requires dispatch, for they can keep pace with the cavalry, and do the duty of infantry: they encamp generally on the wings of the army, or at the passes leading to the camp; and sometimes they are brought to cover the general's quarters: they do duty on the generals of horse and dragoons, and march in the front and rear of the army.
- DRAGS**, in the sea-language, are whatever hangs over the ship in the sea, as shirts, coats, or the like; and boats, when towed, or whatever else that, after this manner, may hinder the ship's way when she sails, are called drags.
- DRAINS**, a name given, in the fen countries, to certain large cuts or ditches of twenty, thirty, nay sometimes forty foot wide, carried through the marshy ground to some river or other place capable of discharging the water they carry out of the fen-lands. See **AGRICULTURE**.
- DRAKE**, in ornithology, the male of the duck-kind. See **ANAS**.
- DRAMA**, a poem containing some certain action, and representing a true picture of human life, for the delight and improvement of mankind.
- The principal species of the drama are two, comedy and tragedy. Some others there are of less note, as pastoral, satire, tragi-comedy, opera, &c. See **COMPOSITION**.
- DRAMATIC**, an epithet given to pieces written for the stage. See **COMPOSITION**.
- DRANK**, among farmers, a term used to denote wild oats, which never fail to infest worn-out lands; so that when plowed lands run to these weeds and thistles, the farmer knows it is high time to fallow them, or else to sow them with hay-seed, and make pasture of them.
- DRAPERY**, in sculpture and painting, signifies the representation of the clothing of human figures, and also hangings, tapestry, curtains, and most other things that are not carnations or landscapes. See **PAINTING**.
- DRAUGHT**, in trade, called also **CLOFF** or **CLOUCH**, is a small allowance on weighable goods, made by the king to the importer, or by the seller to the buyer, that the weight may hold out when the goods are weighed again.
- The king allows 1 lb draught for goods weighing no less than 1 Cwt. 2 lb for goods weighing between 1 and 2 Cwt. 3 lb for goods weighing between 2 and 3 Cwt. 4 lb from 3 to 10 cwt. 7 lb from 10 to 18 Cwt. 9 lb from 18 to 30, or upwards.
- DRAUGHT HOOKS**, are large hooks of iron, fixed on the cheeks of a cannon-carriage, two on each side, one near the trunnion hole, and the other at the train, distinguished by the name of fore and hind draught-hooks. Large guns have draught-hooks near the middle trunnion, to which are fixed the chains that serve to keep the shafts of the limbers on a march. The fore and hind hooks are used for drawing a gun backwards or forwards, by men with strong ropes, called draught-ropes, fixed to these hooks.
- DRAUGHT-HORSE**, in farming, a sort of coarse-made horse, destined for the service of a cart or plough. See **EQUUS**.
- DRAW**, in the sea-language. A ship is said to draw so much water, according to the number of feet she sinks into it; so that if a ship sink into the water eighteen feet perpendicularly, she is said to draw eighteen feet water; and according as she draws more or less, she is said to be of more or less draught.
- DRAW-BACK**, in commerce, certain duties, either of the customs or of the excise, allowed upon the exportation of some of our own manufactures; or upon certain foreign merchandise, that have paid duty on importation.

The



The oaths of the merchants importing and exporting are required to obtain the drawback of foreign goods, affirming the truth of the officer's certificate of the entry, and the due payment of the duties: and these may be made by the agent or husband of any corporation or company, or by the known servant of any merchant usually employed in making his entries and paying his customs. In regard to foreign goods entered outward, if less quantity or value be fraudulently shipped out than is expressed in the exporter's certificate, the goods therein mentioned, or their value, are forfeited, and no drawback to be allowed for the same. Foreign goods exported by certificate, in order to obtain the drawback, not shipped or exported, or re-landed in Great Britain, unless in case of distress, to save them from perishing, are to lose the benefit of the drawback, and are forfeited, or their value, with the vessels, horses, carriages, &c. employed in the re-landing thereof; and the persons employed in the re-landing them, or by whose privity they are re-landed, or into whose hands they shall knowingly come, are to forfeit double the amount of the drawback. Officers of the customs conniving at, or assisting in any fraud relating to certificate-goods, besides other penalties, are to forfeit their office, and to suffer six months imprisonment, without bail or mainprize; as are also masters, or persons belonging to the ships employed therein. Bonds given for the exportation of certificate-goods to Ireland, must not be delivered up, nor drawback allowed for any goods, till a certificate under the hands and seals of the collector or comptroller, &c. of the customs be produced, testifying the landing.

The computation of what is to be drawn back upon the exportation of foreign goods, may be seen under their respective heads.

**DRAW-BRIDGE**, a bridge made after the manner of a floor, to draw up, or let down, as occasion serves, before the gate of a town or castle.

**DRAWING**, in general, denotes the action of pulling out, or haling along: thus, we read of tooth-drawing, wire-drawing, &c.

**DRAWING**, the art of representing the appearances of objects by imitation, or copying without the assistance of mathematical rules.

The general precepts for drawing are as follow:

1. Begin with plain geometrical figures, as lines, angles, triangles, polygons, arches, circles, ovals, cones, cylinders, and the like, being the foundation of all other proportions. The circle is of use in the several orbicular forms, as the sun, moon, globes, &c. the oval, in giving a just proportion to the face and mouth; and the square confines a picture you are to copy, &c. the triangle is of use in drawing a side or half face; angles and arches, in perspective; and the polygon, in ground-plots, fortifications, &c. the cone, in spires, steeples, tops of towers, &c. the cylinder, in columns, pillars, pilasters, &c. See PERSPECTIVE.

2. Having brought your hand to be fit and ready in general proportions, accustom yourself to give every object its due shade, according to its concavity or

convexity, and to elevate or depress the same, as the object appears either nearer or farther off the light.

3. The second practice of drawing, consists in forming fruits, as apples, pears, cherries, &c. with their leaves; the imitation of flowers, as roses, tulips, carnations, &c. herbs, trees, &c. of different kinds.

4. The third, in the imitation of beasts, fowls, fishes, &c.

5. The fourth practice of drawing consists in the imitation of the body of man, with all its lineaments, as head, nose, eyes, ears, cheeks, arms, and shadows, all exactly proportioned both to the whole and to one another.

6. The fifth is in the drapery, in the imitation of cloathing, and artificially setting off the outward coverings, habit, and ornaments of the body, either of cloth, stuff, silk, or linen, in their natural and proper folds.

7. In drawing of all the forms before-mentioned, it is requisite to be first perfect in the laying down the exact proportions; secondly, in the general or outward lines, before you proceed to shadowing, or trimming the work within.

8. In mixed and uncertain forms, where the circle, square, &c. will be of no use, but only in the idea thereof in your own fancy, as horses, oxen, and the like, you must do it by judgment, and so gain the true proportions by assiduous practice: thus having the shape of the thing in your mind, first draw it rudely with a coal; then, with more exactness, with a lead or pencil; then peruse it well, and mend it in those parts you have erred in, according to the idea you carry in your mind. When it is mended by your own judgment, compare it with some good pattern of the same kind, and amend it by that.

9. Having good copies to draw after, learn to reduce them to other proportions, either larger or smaller; and this by frequent practice.

10. Let a perfection in drawing be attained by diligent exercise, and the instruction of a good master, before there be any attempts as to colouring and painting; for the former being attained, the rest will be easily understood, and gained by frequent practice.

*Particular observations with regard to DRAWING, are as follows.*

1. If you draw after a print or picture, place it in such a light, that the gloss of the colours may not interrupt your light, and that the light and your eye may equally and obliquely fall upon the piece, which should be placed at such a distance, that, upon opening your eye, you may view it at once: the larger the picture is, the greater distance off it should be placed: it should also be right before you, and a little reclining.

2. Draw your out-lines at first very faint, and with a coal; and let them be drawn agreeable to the pattern, before you begin to shadow any part of it. When you have drawn one feature, it should, in some measure, be a direction for you to draw the other, by observing the distance from that to the next feature; making a small mark at the place with your coal, then draw it, and so to the next, till you have drawn the whole figure.

3. Then observe the middle of the picture you would copy, and touch upon the paper with the point of your coal: afterwards, observe the more conspicuous and uppermost figures, if there are more than one, which you are to touch lightly in their proper places: thus, running over the whole draught, you will see, as it were, the skeleton of the piece to draw.

4. Having made out these sketches, view them diligently, if they answer your pattern or not; for the gestures of the life ought to shew themselves eminently in the first and rudest draughts thereof: correct and mend whatever you perceive amiss, adding and diminishing as it varies from the pattern; by which method it will be brought nearer and nearer to the life.

5. Observe the distance of one limb, joint, or muscle, from another, and the same in all other accidents of the figure, their length, breadth, turnings, &c. shadow next to the light very faintly; and where you see bold and free touches, be not timorous in expressing the same. In drawing a head by the life, or otherwise, take care to place the features exactly right upon the cross-lines, whether it be a full face, or three-quarter face. In fore-shortening you must make the cross-lines to fly upwards, where they look upwards; but where the aspect is downwards, they must be made downwards, in a circular manner. Having drawn the out-lines true, with a coal, you are to proceed to trace the same lines again with a pen, Indian ink, &c. drawing them with more exactness, and by imitating all the hatches with their exact distances one from another, their crossings, turnings and windings, with more boldness and freedom perfect your design.

6. In drawing after a naked body, all the muscles are not to be so plainly expressed as in anatomical figures: but that side whose parts are most apparent, and of signification in the performance of any action, must be made to appear more or less, according to the force of that action.

7. In drawing young persons, the muscles must not appear manifestly so hard as in older and full-grown persons: the same is to be observed as to fat and fleshy persons, and such as are very delicate and beautiful; and in women, scarce any muscles at all are to be expressed, or but very little, unless it be in some very terrible action, and then too they are to be represented very faintly; the like is also to be observed as to little children.

8. The motion of the whole body must be considered in drawing of the muscles; as in the rising and falling of the arms, the muscles of the breast do appear more or less; the hips do the like according as they are bent outward or inward; and it is the same chiefly in the shoulders, sides, and neck, according to the several actions of the body.

9. The proportion of the figure ought to be multiplied by degrees. in proportion of one to two, three, four, &c. for herein the chief skill consists: the diameter of the biggest place, between the knee and the foot, is double to the least; and the largest part of the thigh, triple.

**DRAY**, a kind of cart used by brewers, for carrying barrels of beer, or ale; also a sledge drawn without wheels.

**DRAY**, among sportsmen, denotes squirrel-nests, built in the tops of trees.

**DRYATON**, a market-town of Shropshire, fourteen miles north-east of Shrewsbury.

**DREDGE**, or **DREG**, among farmers, denotes oats and barley mingled together.

**DREDGERS**, the term used in the admiralty-court for the oilter-fishers.

**DREIN**, in the military art, a trench made to draw the water out of a moat, which is afterwards filled with hurdles and earth, or with fascines or bundles of rushes and planks, to facilitate the passage over the mud. See **TRENCH**.

**DRENCH**, among farriers, a physical potion for horses. The ingredients for this purpose are to be beat coarsely, and either mingled with a decoction, or with wine. Then let all infuse about a quarter of an hour, and give it to the horse with a horn, after he has been tied up two hours to the rack.

**DRESDEN**, the capital of Upper Saxony, in Germany, situated on the river Elbe, sixty-five miles north-west of Prague, and eighty-five fourth of Berlin: E. long.  $13^{\circ} 36'$ , N. lat.  $51^{\circ}$ .

It is one of the largest and strongest towns in Germany, and is the usual residence of the elector of Saxony.

**DREUX**, a town of Orleans, in France, seventeen miles north of Chartres, and thirty-five west of Paris.

**DRIFT**, a term used at sea. Thus, any thing that floats upon the water, is said to run a-drift.

**DRIFT-SAIL**, a sail used under water, veered out right a-head by sheets, as other sails are. It serves to keep the ship's head right upon the sea in a storm, and to hinder her driving too fast in a current.

**DRILL**, in mechanics, a small instrument for making such holes as punches will not conveniently serve for. Drills are of various sizes, and are chiefly used by smiths and turners.

**DRILL**, or **DRILL-BOX**, a name given to an instrument for sowing land in the new method of horse-hoeing husbandry. See **ARICULTURE**.

**DRINK**, a part of our ordinary food in a liquid form, serving to dilute and moisten the dry meat.

The drinks in different countries are different. The common drink in England is either water, malt-liquor, wine, or mixtures of these.

The first drinks of mankind were certainly water and milk, but the love of luxury and debauchery soon introduced the art of preparing intoxicating and inebriating drinks out of vegetables. The vine gave the first of these liquors; after this, wheat, barley, millet, oats, rice, apples, pears, and pomegranates; and after those the juices drained from the pine, sycamore, and mapple, were brought to this use: in latter times, roots, berries, and the pith of the sugar-cane, have been employed for the same purposes.

**DRIVERS**, among sportsmen, a machine for driving pheasant-powts, consisting of good strong ozier-wands, such

such as the basket-makers use; these are to be set in a handle, and twisted or bound with small oziers in two or three places.

With this instrument, the sportsman drives whole eyes of young powns into his nets. See the next article.

**DRIVING**, among sportsmen, a method of taking pheasant-powns. It is thus: the sportsman finds out the haunts of these birds; and having fixed his nets there, he calls them together by a pheasant-call, imitating the voice of the dam: after this he makes a noise with his driver, which will make them run a little way forward in a cluster; and this he is to repeat till he has made sure of them, which an expert sportsman never fails to do, by driving them into his nets.

**DRIVING**, in metallurgy, is said of silver, when in the operation of refining, the lead being burnt away, the remaining copper rises upon its surface in red fiery bubbles.

**DRIVING**, in the sea-language, is said of a ship when an anchor being let fall will not hold her fast, nor prevent her sailing away with the tide or wind. The best help in this case is to let fall more anchors, or to veer out more cable; for the more cable she has out, the safer she rides. When a ship is a-hull, or a-try, they say she drives to leeward.

**DROGHEDA**, a port-town of Ireland, twenty-three miles north of Dublin.

**DROGMAN**. See **DRAGOMAN**.

**DROITWICH**, a borough six miles north of Worcester, which sends two members to parliament.

**DROMEDARY**. See **CAMELUS**.

**DRONE**, in the history of insects. See **APIS**.

**DRONE-FLY**, a two-winged insect, extremely like the common drone-bee, whence also the name.

**DROPS**, in meteorology, small spherical bodies which the particles of fluids spontaneously form themselves into when let fall from any height.

**DROPS**, in medicine, a liquid remedy, the dose of which is estimated by a certain number of drops.

**DROPSY**, in medicine, an unnatural collection of watry humours in any part of the body. See **MEDICINE**.

**DROP-WORT**, in botany. See **FILIPENDULA**.

**Water DROP-WORT**, in botany. See **OENANTHE**.

**DROSERA**, **SUN-DEW**, in botany, a genus of the pentandria pentagynia class of plants, with a funnel-fashioned flower, consisting of five obtusely-ovated petals: the fruit is an unilocular subovate capsule, containing a great many very small seeds.

**DROWNING**, the act of suffocating, or being suffocated, by water.

Naturalists and physicians furnish us with divers well attested instances of surprising recoveries of persons drowned. It is certain from repeated dissections made on persons drowned, that they generally have less water in their stomachs than if they had voluntarily drunk a considerable quantity: whence it does not seem expedient to hang the drowned person by the heels, a position that must prove uneasy as soon as the humours of the body should resume their ordinary motion. In order to know whether the person has swallowed too

much water or not, and to make him vomit it up if he has, it is proper to put him in a tun, open at both ends, which is to be rolled in different directions: or the bearded end of a feather should be introduced into the œsophagus. After taking off the cloaths of the drowned person, we ought, with the utmost expedition, to shelter him from the impressions of the cold air, and begin to warm him, by wrapping him up with cloaths and coverings: to do this more effectually, he is afterwards to be put into a pretty warm bed, applying also to his body hot napkins and cloths. A hot scorching sun, to which drowned persons have been exposed, and hot baths, have produced the same happy effects.

The great intention to be pursued is, to put the solid parts of the machine in action, that thus they may restore the motion of the fluids: in order to this, the drowned person should be agitated in various directions, in a bed, in the arms of persons of sufficient strength.

Spirituous liquors should be poured into his mouth, or warm urine; and some persons prescribe a decoction of pepper and vinegar, as a gargarism: we must also attempt to irritate the internal fibres of the nose, either by volatile spirits, and by the liquors used in apoplectic cases; or by tickling the nerves of the nostrils with a bearded feather; or by blowing, through a quill, snuff, or some other more powerful sternutatory. One of the means frequently used with success, is to blow warm air, by means of a pipe, into their mouths; or to introduce it by a pair of bellows; or, by injecting warm clysters, to irritate the intestines: the smoke of tobacco conveyed into the intestines, by means of a tobacco pipe, is much recommended. Venesection is by no means to be neglected; and perhaps most successfully in the jugular vein.

**DRUG**, a general term for goods of the druggist and grocery kinds, especially for those used in medicine and dying.

**DRUGGET**, in commerce, a stuff sometimes all wool, and sometimes half wool half thread, sometimes corded, but usually plain.

Those that have the woof of wool, and the warp of thread, are called threaded-druggets; and those wrought with the shuttle on a loom of four marches, as the serges of Moui, Beauvois, and other like stuffs corded, are called corded druggets. As to the plain, they are wrought on a loom of two marches, with the shuttle, in the same manner as cloth, camlets, and other like stuffs not corded.

**DRUIDS**, the priests or ministers of religion of the ancient Britons and Gauls. The druids were chosen out of the best families; and were held, both by the honours of their birth, and their office, in the greatest veneration. They are said to have understood astrology, geometry, natural history, politics, and geography: they had the administration of all sacred things, were the interpreters of religion, and the judges of all affairs indifferently.

Whoever refused obedience to them, was declared impious and accursed: they held the immortality of the

- the soul, and the transmigration of souls. They are divided by some into several classes, as the *vaceni*, *bardi*, *bubagis*, *semothii*. They had a chief, or arch-druid, in every nation: he was a sort of high-priest, having an absolute authority over the rest, and was succeeded by the most considerable among his survivors. The youth used to be instructed by them, retiring with them to caves and desolate forests, where they were sometimes kept twenty years. They preserved the memory and actions of great men by their verses; but are said to have sacrificed men to Mercury. *Cæsar* imagined that the druids came from Britain into Gaul, but several among the modern writers are of a different opinion.
- DRUM**, is a martial musical instrument in form of a cylinder, hollow within, and covered at the two ends with vellum, which is stretched or slackened at pleasure by the means of small cords or sliding knots: It is beat upon with sticks. Some drums are made of brass, but they are commonly of wood.
- Kettle Drums**, are two sorts of large basons of copper or brass, rounded in the bottom, and covered with vellum, or goat-skin, which is kept fast by a circle of iron, and several holes fastened to the body of the drum, and a like number screws to screw up and down. They are much used among the horse, as also in operas, oratorios, concerts, &c.
- DRUM**, or **DRUMMER**, he that beats the drum; of whom each company of foot has one, and sometimes two. Every regiment has a drum-major, who has the command over the other drums. They are distinguished from the soldiers, by cloaths of a different fashion: their post, when a battalion is drawn up, is on the flanks, and on a march it is betwixt the divisions.
- DRUM of the ear**, in anatomy. See Vol. I. p. 299.
- DRUMLANERK**, a town of Scotland, fifteen miles north of Dumfries.
- DRUNKENNESS**, a well known disorder in the brain, occasioned by drinking too freely of spirituous liquors. Drunkenness appears in different shapes, in different constitutions: some it makes gay, some sullen, and some furious.
- DRUPE**, among botanists. See Vol. I. p. 637.
- DRUSENHEIM**, a town of Alsace, in Germany, four miles south-east of Hagenau.
- DRYADÆA**, in botany. See **DRYAS**.
- DRYADS**, in the heathen theology, a sort of deities, or nymphs, which the ancients thought inhabited groves and woods. They differed from the *Hamadryades*, these latter being attached to some particular tree, with which they were born, and with which they died; whereas the *Dryades* were goddesses of trees and woods in general.
- DRYAS**, in botany, a genus of the *icosandria polygynia* class. The calix consists of eight segments, and the corolla of eight petals; and the seeds are tailed and hairy. There are two species, both natives of Britain, *viz.* the *pentapetala*, or cinquefoil avens; and the *octopetala*, or mountain avens.
- DUBLIN**, the capital of the province of Leinster, and of all Ireland, situated at the mouth of the river *Liffey*, sixty miles west of Holyhead in Wales: W. lon. 6° 25', N. lat. 53° 16'.
- It is a large and beautiful city, pleasantly situated; having a view of the sea on one side, and of a fine country on the other. It is the seat of the courts of justice, and an archbishop's see; and has a noble college, which is an university of itself.
- DUCAL**, in general, something belonging to a duke. See **DUKE**.
- DUCAT**, a coin current in Germany and other countries abroad, of different values.
- DUCATOON**, a silver coin, likewise frequent in several parts of Europe.
- DUCENARIUS**, in Roman antiquity, a military office, who had the command of two hundred men.
- DUCK**, in ornithology. See **ANAS**.
- DUCKER**. See **COLYMBUS**.
- DUCKING**, plunging in water, a diversion anciently practised among the Goths, by way of exercise; but among the *Celtæ*, Franks, and ancient Germans, it was a sort of punishment for persons of scandalous lives.
- They were shut up, naked to the shift, in an iron cage, fastened to the yard of a shallop, and ducked several times.
- DUCKING at the main-yard**, among seamen, is a way of punishing offenders on board a ship; and is performed by binding the malefactor, by a rope, to the end of the yard, from whence he is violently let down into the sea, once, twice, or three times, according to his offence: and if the offence be very great, he is drawn underneath the keel of the ship, which they call *keel-haling*.
- DUCKUP**, at sea, is a term used by the steer's-man, when the main-sail, fore-sail, or sprit-sail, hinders his seeing to steer by a land-mark: upon which he calls out, *Duckup the clew-lines of these sails*, that is, hale the sails out of the way. Also when a shot is made by a chace-piece, if the clew of the sprit-sail hinders the sight, they call out, *Duckup*, &c.
- DUCT**, in general, denotes any tube or canal. It is a term much used by anatomists.
- Air-DUCT**, among ichthyologists, a canal reaching from the air-bladder in fishes to their stomach.
- DUCTILITY**, in physics, a property of certain bodies, whereby they are capable of being expanded, or stretched forth, by means of a hammer, press, &c. See **CHEMISTRY**, and **MECHANICS**.
- DUDERSTAT**, a town of Upper Saxony, thirty-five miles north-east of Cassel.
- DUEL**, a single combat, at a time and place appointed, in consequence of a challenge. This custom came originally from the northern nations, among whom it was usual to decide all their controversies by arms. Both the accuser and the accused gave pledges to the judges on their respective behalf; and the custom prevailed so far amongst the Germans, Danes, and Franks, that none were excused from it but women, sick people, cripples, and such as were under twenty-one years of age, or above sixty. Even ecclesiastics, priests, and monks, were obliged to find champions

to fight in their stead. The punishment of the vanquished was either death, by hanging or beheading; or, mutilation of members, according to the circumstances of the case. Duels were at first admitted not only on criminal occasions, but on some civil ones for the maintenance of rights to estates, and the like: in latter times, however, before they were intirely abolished, they were restrained to these four cases. 1. That the crime should be capital. 2. That it should be certain the crime was perpetrated. 3. The accused must, by common fame, be supposed guilty. And, 4. The matter not capable of proof by witnesses. At present it is used for a single combat on some private quarrel, and must be premeditated, otherwise it is called a rencounter. If a person be killed in a duel, both the principals and seconds are guilty of murder, whether the seconds engage or not. It is also a very high offence to challenge a person, either by word or letter, or to be the messenger of a challenge. The severe edicts made by Lewis XIV. against duels have, in a great measure, put a stop to the custom in France.

**DUELLING**, in Scots law. See title 33.

**DUERO**, or **DURO**, a large river, which, rising in Old Castile in Spain, runs from east to west, crosses the province of Leon, and, after dividing Portugal from Spain by a southerly course, turns westward, crosses Portugal, and falls into the Atlantic Ocean at Porto-Port.

**DUKE** is either the title of a sovereign prince, as the duke of Savoy, Parma, &c. the grand duke of Tuscany, Muscovy, &c. or it is the title of honour and nobility next below princes. The commanders of armies in time of war, the governors of provinces and wardens of marches in times of peace, were called *duces* under the later emperors. The Goths and Vandals divided all Gaul into dutchies and counties, the governors of which they sometimes call *duces*, and sometimes *comites*. In France, under the second race of kings, though they retained the name and form of ducal government, there were scarce any dukes except those of Burgundy, Aquitain, and France. In England, among the Saxons, the commanders of armies, &c. were called dukes, *duces*, without any addition, till Edward III. made his son, the Black Prince, duke of Cornwall; after whom there were more made in the same manner, the title descending to their posterity. Duke then, at present, is a mere title of dignity, without giving any domain, territory, or jurisdiction over the place from whence the title is taken. A duke is created by patent, cincture of sword, mantle of state, imposition of a cap and coronet of gold on his head, and a verge of gold put into his hand. His title is Grace; and, in the style of the heralds, Most high, potent, high-born, and noble prince.

**DULCIFYING**, in chemistry, is the sweetening any matter impregnated with salts, by frequently washing it in pure water.

**DULL**, in the menage. The marks of a dull horse, called by the French *marquis de ladre*, are white spots round the eye and on the tip of the nose, upon

any general colour whatsoever. Though the vulgar take these spots for signs of stupidity, it is certain they are great marks of the goodness of a horse; and the horses that have them are very sensible and quick upon the spur.

**DULWICH**, a village near London, remarkable for its mineral waters, which are said to contain a bitter cathartic salt, but no iron.

**DUMBLAIN**, a town of Scotland, about five miles north of Stirling.

**DUMBNESS**, the privation of the faculty of speech. The most general, or rather the sole cause of dumbness, is the want of the sense of hearing. The use of language is originally acquired by imitating articulate sounds. From this source of intelligence, deaf people are intirely excluded: they cannot acquire articulate sounds by the ear: unless, therefore, articulation be communicated to them by some other medium, these unhappy people must forever be deprived of the use of language; and as language is the principal source of knowledge, whoever has the misfortune to want the sense of hearing, must remain in a state little superior to that of the brute creation. Deafness has in all ages been considered as such a total obstruction to speech, or written language, that an attempt to teach the deaf to speak or read has been uniformly regarded as impracticable, till Dr Wallis and some others have of late shewn, that although deaf people cannot learn to speak or read by the direction of the ear, there are other sources of imitation, by which the same effect may be produced. The organs of hearing and of speech have little or no connection. Persons deprived of the former generally possess the latter in such perfection, that nothing further is necessary, in order to make them articulate, than to teach them how to use these organs. This indeed is no easy task; but experience shews that it is practicable. Mr THOMAS BRAIDWOOD, of Edinburgh, is perhaps the first who ever brought this surprising art to any degree of perfection. For these some years past, he has taught many people born deaf, to speak distinctly, to read, to write, to understand figures, the principles of religion and morality, &c. This, at first sight, may appear to be altogether incredible; but the fact is certain. Mr Braidwood has, at present, ten or a dozen of deaf pupils, some of them above twenty years of age, all making a rapid and amazing progress in those useful branches of education.

Mr Braidwood's principal difficulty, after he had discovered this art, was to make people believe in the practicability of it. He advertised in the public papers; he exhibited his pupils to many noblemen and gentlemen; still he found the generality of mankind unwilling to believe him. A remarkable instance of this incredulity occurred some years ago. A gentleman in England sent a deaf girl of his to Mr Braidwood's care. A year or two afterwards, Mr Braidwood wrote to the father, that his daughter could speak, read, and write distinctly. The father returned an answer, begging Mr Braidwood's excuse, as he could not believe it; however, he desired a friend of his, who was occa-

casually going to Edinburgh, to call at Mr Braidwood, and inquire into the truth of what he had wrote him: he did so; conversed with Mr Braidwood, saw the young lady, heard her read, speak, and answer any questions he put to her. On his return, he told the father the surprising progress his child had made; but still the father thought the whole an imposition: the girl herself wrote to her father, but he looked upon the letter as a forgery. About this time the father died, and the mother sent an uncle and cousin of the deaf lady's from Shrewsbury, in order to be satisfied of the truth. When they arrived, Mr Braidwood told the girl her uncle and cousin were in the parlour, and desired her to go and ask them how they did, and how her mother and other friends did. The friends were astonished, and could hardly credit their own ears and eyes.

We have conversed with Mr Braidwood, concerning the nature and method of teaching this wonderful art: he seems to be very desirous of communicating and transmitting his discovery to posterity: but says, and, from the nature of the thing, we believe it to be true, that he cannot communicate it so fully in writing as to enable any other person to teach it. The first thing in the method is, to teach the pupil to pronounce the simple sounds of the vowels and consonants. We have even seen him performing this operation; but are unable to give a clear idea of it. He pronounces the sound of *a* slowly, pointing out the figure of the letter at the same time; makes his pupil observe the motion of his mouth and throat; he then puts his finger into the pupil's mouth, depresses or elevates the tongue, and makes him keep the parts in that position; then he lays hold of the outside of the wind-pipe, and gives it some kind of squeeze, which it is impossible to describe: all the while he is pronouncing *a*, the pupil is anxiously imitating him, but at first seems not to understand what he would have him to do. In this manner he proceeds, till the pupil has learned to pronounce the sounds of the letters. He goes on in the same manner to join a vowel and a consonant, till at length the pupil is enabled both to speak and read.

It is altogether in vain for us to attempt to say any more concerning the mode of operation. Mr Braidwood undertakes every deaf person, who is not at the same time foolish or idiotical. The greatest misfortune is, that this art is confined to a single man, and that his pupils must live in the house with him for some years. The expence necessarily attending education of this kind, excludes all but people in opulent circumstances from deriving any advantage from it. Mr Braidwood says, that the only way for preserving the art, and communicating it to a number, is to take people in the way of apprentices: this he is unable to do at his own expence. What a pity, that such a curious and useful art should live and die with a single man! There are many souls mortified in this kingdom, both by government and private persons, for less important purposes, than the preservation and ex-

tenion of the art of raising a great number of our fellow-creatures from the rank of brutes, to that of reasonable beings, and useful members of society.

**DUMFERMLINE**, a parliament-town of Scotland, situated in the county of Fife, fifteen miles north-west of Edinburgh: W. long.  $30^{\circ} 20'$ , and N. lat.  $56^{\circ} 15'$ . Here was formerly a magnificent abbey and palace of the kings of Scotland, in which the princess Elizabeth, daughter of king James VI. and mother of the princess Sophia, from whom the present royal family are descended, was born.

**DUMFRIES**, the capital of a county of the same name, in Scotland, lying northwards of the Solway frith: W. long.  $3^{\circ} 20'$ , and N. lat.  $54^{\circ} 45'$ .

**DUNBAR**, a parliament and port-town of Scotland, about twenty-five miles east of Edinburgh.

**DUNBARTON**, the capital of a county of the same name in Scotland, called by some Lenox: it is a parliament town, situated at the confluence of the rivers Clyde and Leven; sixteen miles north-west of Glasgow.

**DUNCANNON**, a town of the county of Wexford, in Ireland, six miles east of Waterford.

**DUNDALK**, a port-town of Ireland, eighteen miles north of Drogheda.

**DUNDEE**, a large parliament-town of Angus, in Scotland, situated on the north side of the frith of Tay, fourteen miles north-west of St Andrews: W. lon.  $2^{\circ} 42'$ , and N. lat.  $56^{\circ} 32'$ .

**DUNG**, in husbandry, is of several sorts, as that of horses, cows, sheep, hogs, pigeons, geese, hens, &c. See **AGRICULTURE**.

**DUNGANNON**, a town of Ireland, eleven miles north of Armaugh.

**DUNGING** of lands. See **AGRICULTURE**.

**DUNKELD**, a town of Perthshire in Scotland, formerly a bishop's see, situated about twelve miles north of Perth.

**DUNG MEERS**, in husbandry, places where soils and dungs are mixed and digested together. For this purpose it is usual to dig a pit sufficient to hold the stock of soil the husbandman is capable of making; and to prepare it at the bottom with stone and clay, that it may hold water, or the moisture of the dung; and besides, it should be so situated that the sinks and drips of the houses and barns may run into it. Into this pit they cast refuse fodder, litter, dung, weeds, &c. where they lie and rot together, till the farmer have occasion for it.

**DUNKIRK**, a port-town of the French Netherlands: E. lon.  $2^{\circ} 28'$ , and N. lat.  $51^{\circ}$ .

**DUNNEGAL**, the capital of a county of the same name in Ireland, situated on a bay, to which it likewise gives name: W. lon.  $8^{\circ} 22'$ , and N. lat.  $54^{\circ} 35'$ .

**DUNNINGTON**, a market-town of Lincolnshire, about twenty-three miles south-east of Lincoln.

**DUNS**, a market-town of Scotland, twelve miles west of Berwick upon Tweed.

**DUNSTABLE**, a market-town, fifteen miles south of Bedford, and thirty north-west of London.

DUN-

**DUNWICH**, a borough of Suffolk, forty miles east of Bury. It sends two members to parliament.

**DUO**, in music, a song or composition to be performed in two parts only, one sung, the other played on an instrument, or by two voices.

**Duo** is also when two voices sing different parts, as accompanied with a third, which is a thorough base. It is seldom that unisons and octaves are used in duos, except at the beginning and end.

**DUODECIMA**, in music, is the twelfth or the fifth doubled. See **FIFTH**.

**DUODENUM**, in anatomy. See Vol. I. p. 259.

**DUPLE**, among mathematicians, denotes the ratio of 2 to 1. Thus the ratio of 8 to 4 is duple, or as 2 to 1.

**Sub-DUPLE RATIO** is just the reverse of the former, or as 1 to 2. Such is 4 to 8, or 6 to 12.

**DUPLICATE**, among lawyers, denotes a copy of any deed, writing, or account. It is also used for the second letters patent, granted by the lord chancellor in a case wherein he had before done the same. Also a second letter written and sent to the same party and purpose as a former, for fear of the first's miscarrying, is called a duplicate:

**DUPLICATE PROPORTION, OR RATIO.** See **ALGEBRA** and **ARITHMETIC**.

**DUPLICATION**, in general, signifies the doubling of any thing, or multiplying of it by 2: also the folding of any thing back again on itself.

**DUPLICATURE**, among anatomists, a term used to denote the folds of any membrane, or vessel: thus we say, the duplicatures of the intestines, peritonæum, &c.

**DUPONDUS**, in antiquity, the weight of two pounds: also a piece of money equal to two asses in value.

**DURA MATER**, in anatomy. See Vol. I. p. 284.

**DURANCE**, a river of France, which falls into the Rhone, a little below Avignon.

**DURANTA**, in botany, a genus of the didynamia angiospermia class. The calix is above the fruit, and divided into five segments; and the berry contains four seeds. There are two species, both natives of America.

**DURATION**, an idea which we get by attending to the fleeting and perpetually perishing part of succession; the idea of succession being acquired by reflecting on that train of ideas which constantly follow one another in our minds, as long as we are awake. The simple modes of duration are any different lengths of it whereof we have distinct ideas, as hours, days, years, time, eternity, &c.

**DURATION**, as marked by certain periods and measures, is what we most properly call time. See **TIME**.

**DURATION of action**, according to Aristotle, is confined to a natural day in tragedy; but the epopea, according to the same critic, has no fixed time.

**DURESSE**, in law, is where a person is wrongfully imprisoned, or restrained of his liberty, contrary to law; or is threatened to be killed, wounded,

or beaten, till he executes a bond, or other writing.

**DURHAM**, a city and county, in the north of England, situated on the river Were, fourteen miles south of Newcastle: W. lon.  $1^{\circ} 12'$ , and N. lat.  $54^{\circ} 50'$ . It is the see of a bishop, and sends two members to parliament.

**DUSSELDORP**, a city of Germany, situated on the eastern shore of the Rhine, twenty miles north of Cologne: E. lon.  $6^{\circ} 20'$ , and N. lat.  $51^{\circ} 15'$ .

**DUTCHY**, in geography, an appellation given to the dominions of a duke.

**DUTCHY-COURT**, a court of the dutchy chamber of Lancaster, held at Westminster, before the chancellor of the same, for matters concerning the lands and franchises of that dutchy.

**DUTY**, in general, denotes any thing that one is obliged to perform.

**DUTY**, in polity and commerce, signifies the impost laid on merchandizes, at importation or exportation, commonly called the duties of customs; also the taxes of excise, stamp-duties, &c. See **CUSTOMS**, **EXCISE**, &c.

The principles on which all duties and customs should be laid on foreign merchandizes, which are imported into these kingdoms, are such as tend to cement a mutual friendship and traffic between one nation and another; and therefore due care should be taken in the laying of them, that they may answer so good an end, and be reciprocal in both countries: they should be so laid as to make the exports of this nation at least equal to our imports from those nations wherewith we trade, so that a balance in money should not be issued out of Great Britain, to pay for the goods and merchandizes of other countries: to the end that no greater number of our landholders and manufacturers should be deprived of their revenues arising from the product of the lands, and the labour of the people, by foreign importations, than are maintained by exportations to such countries. These are the national principles on which all our treaties of commerce with other countries are to be grounded.

**DUTY**, in the military art, is the exercise of those functions that belong to a soldier; with this distinction, that mounting guards and the like, where there is no enemy directly to be engaged, is called duty; but their marching to meet and fight an enemy is called going on service.

**DUUMVIRATE**, the office or dignity of the duumviri. See the next article.

The duumvirate lasted till the year of Rome 399, when it was changed into a decemvirate.

**DUUMVIRI**, in Roman antiquity, a general appellation given to magistrates, commissioners, and officers, where two were joined together in the same functions.

**DUUMVIRI CAPITALIS** were the judges in criminal causes: from their sentence it was lawful to appeal to the people, who only had the power of condemning a citizen to death. These judges were taken from the body

of

of the decuriones; they had great power and authority, were members of the public council, and had two lictors to walk before them.

**DUUMVIRI MUNICIPALES**, were two magistrates in some cities of the empire, answering to what the consuls were at Rome: they were chosen out of the body of the decuriones; their office lasted commonly five years, upon which account they were frequently termed *quinquennales magistratus*. Their jurisdiction was of great extent: they had officers walking before them, carrying a small switch in their hands; and some of them assumed the privilege of having lictors, carrying axes and the fasces, or bundles of rods, before them.

**DUUMVIRI NAVALES** were the commissaries of the fleet, first created at the request of M. Decius, tribune of the people, in the time of the war with the Samnites. The duty of their office consisted in giving orders for the fitting of ships, and giving their commissions to the marine officers, &c.

**DUUMVIRI SACRORUM** were magistrates created by Tarquinius Superbus, for the performance of the sacrifice, and keeping of the sybils books. They were chosen from among the patricians, and held their office for life: they were exempted from serving in the wars, and from the offices imposed on the other citizens, and without them the oracles of the sybils could not be consulted.

**DUYVELAND**, or **DIVELAND**, one of the islands of Zealand, in the United Provinces, lying eastward of Schonen, from which it is only separated by a narrow channel.

**DWAL**, in heraldry, the herb nightshade used by such as blazon with flowers and herbs, instead of metals and colours, for sable or black.

**DWARF**, in general, an appellation given to things greatly inferior in size to that which is usual in their several kinds: thus there are dwarfs of the human species, dwarf-dogs, dwarf-trees, &c.

The Romans were so passionately fond of dwarfs, that they often used artificial methods to prevent the growth of boys designed for dwarfs, by inclosing them in boxes, or by the use of tight bandages. In Italy, even at present, they wash young puppies every day with astringent liquors, in order to prevent their growth by hardening the parts.

**DWINA**, the name of two large rivers, one of which rises in Lithuania, and, dividing Livonia from Courland, falls into the Baltic sea a little below Riga: the other gives name to the province of Dwina, in Russia, discharging itself into the White sea, a little below Archangel.

**DYE**, in architecture, any square body, as the trunk or notched part of a pedestal: or it is the middle of the pedestal, or that part included between the base and the cornice, so called because it is often made in the form of a cube or dye. See **ARCHITECTURE**.

**DYER**, a person who professes the art of dyeing all manner of colours. See **DYEING**.

**DYER'S WEED**, in botany. See **RESEDA**.

**DYEING**, the art of giving a lasting colour to silks,

cloths, and other substances, whereby their beauty is much improved, and value enhanced.

This art depends chiefly on three things, *viz.* 1. Disposing the surface of the stuffs to receive and retain the colours; which is performed by washing them in different lyes, digesting, beating them, &c. in which human urine putrified, a sharp salt of ashes, divers soaps, and galls of animals, are of principal use; by means whereof the viscous gluten of the silk-worms naturally adhering to their threads, is washed and cleaned from them, and thus they become fitted gradually to imbibe the colours. By these also the greasy foulness adhering to wool and flax is scoured off.

2. To grind the colours, as that they may enter the body duly prepared, and preserve their brightness undiminished.

3. The third consists in having beautiful colours.

According to Sir W. Petty's account of what is done in particular trades by the art of dyeing, 1. There is a whitening of wax, and several sorts of linen and cotton cloths, by the sun, air, and reciprocal effusions of water. 2. Colouring of wood and leather, by lime, salt and liquors, as in stoves, canes, and marble leathers. 3. Colouring of paper, *viz.* the marbled paper, by distempering the colours with ox-gall, and applying them upon a stiff gummed liquor. 4. Colouring, or rather discolouring, the colours of silks, tiffanies, &c. by brimstone. 5. Colouring of several iron and copper-works into black with oil. 6. Colouring of leather into gold-colour, or rather silver-leaves into gold by varnishes, and in other cases by urine and sulphur. 7. Dyeing of marble and alabaster, with heat and coloured oils. 8. Colouring silver into the brass-colour, with brimstone or urine. 9. Colouring the barrels and locks of guns into blue and purple, with the temper of small-coal heat. 10. Colouring of glass (made of sands, flints, &c.) as also of crystals and earthen ware, with the rusts and solutions of metals. 11. The colouring of live hair, as in Poland, horse and man's hair: as also the colouring of furs. 12. Enameling and annealing. 13. Applying colours, as in the printing of books and pictures, and as in making of playing cards, being each of them performed in a different way. 14. Gilding and tinning with mercury, block-tin, sal armoniac. 15. Colouring of metals, as copper with calamy, into brass, and with zinc or spelter into a golden colour, or into a silver one with arsenic; and of iron into a resemblance of copper with Hungarian vitriol. 16. Making painters colours by preparing of earth, chalk, and slates; as in umber, ochre, cullen-earth, &c. as also out of calces of lead, as ceruse and minium; by sublimes of mercury and brimstone, as in vermilion; by tinging whole earths variously, as in verdeter, and some of the lakes; by concrete juices, or *fæculæ*, as in gambogium, indigo, pinks, sap-green, and lakes; as also by rusts, as in verdigrease, &c. 17. The applying these colours by the adhesion of ox-gall, as in the marbled paper aforesaid; or by gum-water, as by limning; or by clammy drying oils, such as the oils of lintseed, nuts, &c. 18. The watering of tabbies. 19. The colouring of wool, linen, cotton, silk, hair, feathers, horn, leather, and the threads



threads and webs of them with woods, roots, herbs, seeds, leaves, salts, limes, lixiviums, waters, heats, fermentations, macerations, and other great variety of management: an account of all which is a short history of dyeing.

*The materials used in the art of DYEING*, are iron and steel, or what is produced from them in all true blacks, called Spanish blacks, though not in Flanders blacks, *viz.* they use copperas, steel-slings, and slippe; they also use pewter for Bow-dye scarlet, *viz.* they dissolve bars of pewter in aquafortis; litharge is also used by some, though acknowledged by few to add weight to dyed silk. Antimony is much used to the same purpose. Arsenic is used in crimson upon pretence of giving lustre, although those who pretend not to be wanting in giving lustre to their silks disown its use. Verdigreale is also used by linen-dyers in their yellow and greenish colours; though, of itself, it strikes no deeper colour than that of a pale straw. Of mineral salts used in dyeing, the chief is alum; the true use whereof seems to be in regard to the fixation of colours. The next mineral salt is saltpetre, not used by ancient dyers, and but by few of the modern: nor is it yet used but to brighten colours, by back-boiling of them, for which argol is more commonly used: lime is much used in working blue vats.

Of the animal tribes are used cochineal, urine of labouring men kept till it be stale and stinking, honey, yolks of eggs, and ox-gall; the use of the urine is to scour, and help the fermenting and heating of woad; and is used also in blue-vats instead of lime: it dischargeth the yellow, and therefore is used to spend woad withal.

Dyers use two sorts of water, *viz.* river and well-water; the last, which is harsh, they use in reds and other colours wanting restridency, and in dyeing materials of the slacker contextures, as in callicoe, fustian, and the several species of cotton-works; but is not good for blues, and makes yellows and greens look rusty. River-water is more fat and oily, and is therefore used in most cases, and must be had in great quantities for washing and rinsing their cloths after dyeing. Water is called by dyers white liquor; but a mixture of one part bran, and five of river-water, boiled an hour and put into leaden cisterns to settle, is what they call liquor absolutely.

Gums have been used by dyers about silk, *viz.* gum arabic, tragacanth, mastic, dragon's blood. These tend little to the tincture, any more than gum in writing-ink, which only gives it a consistence; so gum may give the silk a glossiness; and, lastly, to increase the weight.

The three peculiar ingredients for black are copperas, slings of steel, and slippe: the restraining binding materials are alder-bark, pomegranate-peels, walnut-rinds and roots, oaken-sapling bark, and saw-dust of the same, crab-tree bark, galls, and sumac.

The salts are alum, salt-petre, sal armoniac, pot-ashes, and stone-lime; among which urine may be enumerated as a liquid salt.

The liquors are well and river water, urine, aquavi-

tz, vinegar, lemon juice, aquafortis, honey, and molasses.

Ingredients of another class are bran, wheaten-flour, yokes of eggs, leaven, cummin seed, fenugreek seed, agaric, and fenna.

The snectics, or absterfives, are fuller's earth, soap, linseed-oil, and ox-gall.

The metals and minerals are pewter, verdigreale, antimony, litharge, and arsenic.

The colourings are of three sorts, *viz.* blue, yellow, and red; of which logwood, old fustic, indigo, and madder, are the chief.

*General observations upon DYEING.*

1. All materials which of themselves do give colour are either red, yellow, or blue; so that out of them, and the primitive fundamental colour white, all that great variety which we see in dyed stuffs doth arise.

2. That few of the colouring materials, as cochineal, foot, wood-wax, woad, &c. are in their outward and first appearance of the same colour, which by the slightest distempers and solutions in the weakest menstrua, they dye upon cloth, silk, &c.

3. That many of them will not yield their colours without much grinding, steeping, boiling and fermenting, or corrosion by powerful menstrua, as redwood, weld, woad, arnotto, &c.

4. That many of them will of themselves give no colouring at all, as copperas or galls, or with much disadvantage, unless the cloth or other stuff to be dyed be as it were first covered, or incrustated with some other matter, though colourless beforehand, as madder, weld, brazil, with alum.

5. That some of them, by the help of other colourless ingredients, do strike different colours from what they would of themselves, as cochineal, brazil, &c.

6. That some colours, as madder, indigo, and woad, by reiterated tinctures, will at last become black.

7. That although green be the most frequent and the most common of natural colours, yet there is no simple ingredient now used alone to dye green with upon any material; sap-green being the nearest, which is used by country people.

8. There is no black thing in use which dyes black, though both the coal and foot of most things burnt or scorched be of that colour, and the blacker, by how much the matter before being burnt was whiter, as in ivory black.

9. The tincture of some dyeing stuffs will fade even with lying, or with the air, or will stain with water only, but very much with urine, vinegar, &c.

10. Some of the dyeing materials are used to bind and strengthen a colour; some to brighten it; some to give lustre to the stuff; some to discharge and take off the colour, either in whole or in part; and some out of fraud, to made the material dyed, if costly, heavier.

11. That some dyeing ingredients, or drugs, by the coarseness of their bodies, make the thread of the dyed stuff seem coarser; and some, by shrinking them, smaller; and some, by smoothing them, finer.

12. Many of the same colours are dyed upon several stuffs with several materials, as red-wood is used in cloth, not in silks; arnetto in silks, not in cloth, and may be dyed at several prices.

13. That scouring and washing of stuffs to be dyed, is done with special materials, as sometimes with ox-galls, sometimes with fullers-earth, and sometimes soap; this latter being, in some cases, pernicious, where pot-ashes will stain, or alter the colour.

14. Where great quantities of stuffs are to be dyed together, or where they are to be done with any speed, and where the pieces are very long, broad, thick, or otherwise, they are to be differently handled, both in respect to the vessels and ingredients.

15. In some colours and stuffs the tingent liquor must be boiling, in other cases blood-warm, and in some it may be cold.

16. Some tingent liquors are fitted for use by long keeping, and in some the virtues wear away by the keeping.

17. Some colours or stuffs are best dyed by reiterated dippings in the same liquor, some by continuing longer, and others a lesser time therein.

18. In some cases, the matter of the vessel wherein the liquors are heated, and the tincture prepared, must be regarded, as the kettles must be pewter for Bow-dye.

19. There is little reckoning made how much liquor is used in proportion to the dyeing drugs, it being rather adjusted to the bulk of the stuffs, as the vessels are to their breadth; the quantity of dyeing drugs being proportioned both to the colour, higher or lower, and to the stuffs; as likewise the salts are to the dyeing drugs. Concerning the weight that colours give to silk, (in which it is most taken notice of, being sold by weight, and a commodity of great price) it is observed, that one pound of raw silk loseth four ounces by washing out the gums and the natural fordes; that the same scoured silk may be raised to above thirty ounces from the remaining twelve, if it be dyed black with some materials.

Of a thing very useful in dyeing, especially of black, nothing increases weight so much as galls, by which black silks are restored to as much weight as they lost by washing out their gum: nor is it counted extraordinary that blacks should gain about four or six ounces in the dyeing upon each pound. Next to the galls, old fustic increases the weight about  $1\frac{1}{2}$  in 12; madder, about one ounce; weld, half an ounce. The blue vats in deep blues of the fifth stall, give no considerable weight; neither doth logwood, cochineal, nor even copperas, where galls are not: slippe adds much to the weight, and giveth a deeper black than copperas itself, which is a good excuse for the dyers that use it.

#### DYEING of wooll and woollen manufactures.

For black in woollen manufactures, it is begun with a strong decoction of woad and indigo, that communicate a deep blue; after which the stuffs being boiled with alum and tartar, or pot-ash, are to be

maddered with common madder, then dyed black with Aleppo galls, copperas, and sumac, and finished by back-boiling in weld. Woolis for tapestry are only to be woaded, and then put in black. For scarlet, wooll and woollen manufactures are dyed with kermes and cochineal, with which may also be used agaric and arsenic. Crimson scarlet is dyed with cochineal, mastic, aquafortis, sal armoniac, sublimite, and spirit of wine. Violet scarlet, purple, amaranth, and pansy-scarlets, are given with woad, cochineal, indigo, braziletto, brazil, and orchal. Common reds are given with pure madder, without any other ingredient. Crimson reds, carnations, flame and peach-colours, are given, according to their several hues, with cochineal, mastic, without madder, or the like. Crimson red is prepared with Roman alum, with cochineal. Orange aurora, brick-colour, and onion-peel colour, are dyed with woad and madder, mixed according to their several shades. For blues, the dark are dyed with a strong tincture of woad; the brighter with the same liquor, as it weakens in working. Dark browns, minims, and tan colours, are given with woad, weaker in decoction than for black, with alum and pot-ashes, after which they are maddered higher than black: for tan-colours, a little cochineal is added. Pearl-colours are given with galls and copperas; some are begun with walnut-tree roots, and finished with the former; though to make them more useful, they generally dip them in a weak tincture of cochineal. Greens are begun with woad, and finished with weld. Pale-yellows, lemon-colour, and sulphur colour, are given with weld alone. Olive colours of all degrees are first put in green, and taken down with foot, more or less, according to the shade that is required. Feulemott, hair-colour, musk, and cinnamon colour, are dyed with weld and madder. Nacaret, or bright orange, is given with weld and goats-hair boiled with pot-ashes.

DYEING of silks, is begun by boiling them in soap, &c. then scouring and washing them in water, and steeping them in cold alum-water. For crimson, they are scoured a second time, before they are put into the cochineal-vat. Red crimson is given with pure cochineal, mastic, adding galls, turmeric, arsenic, and tartar, all mixed in a copper of fair water, almost boiling: with these the silk is to be boiled an hour and a half, after which it is allowed to stand in the liquor till next day. Violet crimson is given with pure cochineal, arsenic, tartar, and galls; but the galls in less proportion than in the former: when taken out, it is washed and put in a vat of indigo. Cinnamon crimson is begun like the violet, but finished by back-boiling; if too bright, with copperas; and if dark, with a dip of indigo. Light blues are given in a bath of indigo. Sky-blues are begun with orchal, and finished with indigo. For citron colours, the silk is first alumed, then welded with indigo. Pale yellows, after aluming, are dyed in weld alone. Pale and brown aurora's, after aluming are welded strongly, then taken down with rocou and dissolved with pot-ashes. Flame-colour is begun with rocou, then alumed, and afterwards dipped

ped in a vat or two of brazil. Carnation and rose colours are first alumed, then dipt in brazil. Cinnamon colour, after aluming, is dipt in brazil and braziletto. Lead colour is given with fustic, or with weld, braziletto, galls and copperas. Black silks of the coarser sort, are begun by scouring them with soap, as for other colours; after which they are washed out, wrung, and boiled an hour in old galls, where they are suffered to stand a day or two: then they are washed again with fair water, wrung, and put into another vat of new galls: afterwards washed again, and wrung, and finished in a vat of black. Fine black silks are only put once into galls of the new and fine sort, that has only boiled an hour: then the silks are washed, wrung out, and dipped thrice in black, and afterwards taken down by back-boiling with soap.

The dyeing of thread is begun by scouring it in a lye of good ashes: afterwards it is wrung, rinsed out in river water, and wrung again. A bright blue is given with braziletto and indigo: bright green is first dyed blue, then back-boiled with braziletto and verdeter, and lastly woaded. A dark green is given like the former, only darkening more before woading. Lemon and pale yellow is given with weld mixed with rocou. Orange isabella, with fustic, weld, and rocou. Red; both bright and dark, with flame-colour, &c. are given with brazil, either alone, or with a mixture of rocou. Violet, dry-rose, and amaranth, are given with brazil, taken down with indigo. Feulemort and olive colour are given with galls and copperas, taken down with weld, rocou, or fustic. Black is given with galls and copperas, taken down and finished with braziletto wood.

**DYNASTY**, among ancient historians, signifies a race or succession of kings of the same line or family: such were the dynasties of Egypt.

The Egyptians reckon thirty dynasties within the space of 36525 years; but the generality of chronologers look upon them as fabulous. And it is very certain, that these dynasties are not continually successive, but collateral.

**DYSCRACY**, among physicians denotes an ill habit or state of the humours, as in the scurvy, jaundice, &c.

**DYSENTERY**, in medicine, a diarrhoea or flux, wherein the stools are mixed with blood, and the bowels miserably tormented with gripes. See **MEDICINE**.

**DYSERT**, a parliament-town of Scotland, in the county of Fife, situated on the northern shore of the frith of Forth, about eleven miles north of Edinburgh.

**DYSOREXY**, among physicians, denotes a want of appetite, proceeding from a weakly stomach.

**DYSPEPSY**, a difficulty of digestion.

**DYSPNOEA**, a difficulty of breathing, usually called asthma.

**DYSURY**, in medicine, a difficulty of making urine, attended with a sensation of heat and pain. See **MEDICINE**.

**DYTISCUS**, **WATER-BEETLE**, in zoology, a genus of insects of the order of the coleoptera; the antennæ of which are slender and setaceous, and the hind feet are hairy, and formed for swimming. There are twenty-three species, distinguished by their antennæ, the colour of the elytra, &c.

**DYVOUR'S HABIT**, in Scots law, a party-coloured habit which fraudulent bankrupts, or bankrupts who have been dealers in illicit trades, are directed to wear, as a mark of ignominy, upon their being liberated from prison on a cessior bonorum. See **SCOTS LAW**, title 32.



## E

### E A G

**EAGLE**, in ornithology. See **FALCO**.

**EAGLE**, in heraldry, is accounted one of the most noble bearings in armoury, and, according to the learned in this science, ought to be given to none but such as greatly excel in the virtues of generosity and courage, or for having done singular services to their sovereigns; in which cases they may be allowed a whole eagle, or an eagle naissant, or only the head or other parts thereof, as may be most agreeable to their exploits.

**EAGLE**, in astronomy. Vol. I. p. 487.

**EAGLE-OWL**. See **BUBO**.

**EAGLE-STONE**. See **ÆTITES**.

**Black EAGLE**, an order of knighthood, instituted by the

### E A R

elector of Brandenburg, in 1701, on his being crowned king of Prussia.

The knights of this order wear an orange-coloured ribband suspending a black eagle.

**White EAGLE**, a like order in Poland, instituted in 1325, by Uladislaus V. on occasion of the marriage of his son Calimir to the daughter of the great duke of Lithuania.

The knights of this order wear a chain of gold, suspending a silver eagle crowned.

**EAGLET**, a diminutive of eagle, properly signifying a young eagle. In heraldry, when there are several eagles on the same escutcheon, they are termed eaglets.

**E.A.R.**,

**EAR**, in anatomy. See Vol. I. p. 295.

**EAR-WIG**, in zoology. See **FORFICULA**.

**EARING**, in the sea language, is that part of the bolt-rope which at the four corners of the sail is left open, in the shape of a ring. The two uppermost parts are put over the ends of the yard-arms, and so the sail is made fast to the yard; and into the lowermost earings, the sheets and tacks are seized or bent at the clew.

**EARL**, a British title of nobility, next below a marquis, and above a viscount. Earls were anciently called *comites*, because they were wont *comitari regem*, to wait upon the king for council and advice. The Germans call them graves, as landgrave, margrave, palsgrave, rheingrave; the Saxons ealdormen, unless that title might be more properly applied to our dukes; the Danes, eolras; and the English, earls. The title, originally, died with the man. William the conqueror first made it hereditary, giving it in fee to his nobles, and allotting them for the support of their state the third penny out of the sheriff's court, issuing out of all pleas of the shire whence they had their title. But now the matter is quite otherwise; for whereas heretofore *comes* and *comitatus* were correlatives, and there was no comes or earl but had a county or shire for his earldom, of later years the number of earls increasing, and no more counties being left, divers have made choice of some eminent part of a county, as Lindsey, Holland, Cleveland, &c. some of a lesser part, as Stafford, &c. others have chosen for their title some eminent town, as Marlborough, Exeter, Bristol, &c. and some have taken for their title the name of a small village; their own seat or park, as Godolphin, Clarendon, &c. An earl is created by cincture of sword, mantle of state put upon him by the king himself, a cap and a coronet put upon his head, and a charter in his hand. All the earls of England are denominated from some shire, town or place, except three; two of whom, *viz.* earl Rivers, and earl Paulet, take their denomination from illustrious families: the third is not only honorary, as all the rest, but also officary, as the earl-marshal of England.

**EARL-marshal of England**, is a great officer who had anciently several courts under his jurisdiction, as the court of chivalry, and the court of honour. Under him is also the herald's office or college of arms. He hath some pre-eminence in the court of Marshalsea, where he may sit in judgment against those who offend within the verge of the king's court. This office is of great antiquity in England, and anciently of greater power than now; and has been for several ages hereditary in the most noble family of Howard.

**EARNEST**, in Scots law, a piece of money sometimes given by a buyer, in evidence that the sale or contract is completed. See tit. 22.

**EARTH**, a fossile, or terrestrial matter, whereof our globe partly consists. See Vol. I. p. 67.

**EARTH**, in astronomy and geography, one of the primary planets, being this terraqueous globe whereon we inhabit. See **ASTRONOMY** and **GEOGRAPHY**.

**EARTHQUAKE**, in natural history, a violent agitati-

on or trembling of some considerable part of the earth generally attended with a terrible noise like thunder, and sometimes with an eruption of fire, water, wind, &c. See **PNEUMATICS**.

**EASEL-PIECES**, a denomination given by painters to such pieces as are contained in frames, in contradistinction from those painted on cieling, &c.

**EASEMENT**, in law, a privilege or convenience which one neighbour has of another, whether by charter or prescription, without profit: such are a way through his lands, a sink, or the like. These, in many cases, may be claimed.

**EASING**, in the sea-language, signifies the slackening a rope, or the like: thus, to ease the bow-line or sheet, is to let them go slacker; to ease the helm, is to let the ship go more large, more before the wind, or more larboard.

**EASLOW**, a borough of Cornwall, twenty-two miles south of Launceston, which sends two members to parliament.

**EAST**, one of the four cardinal points of the world; being that point of the horizon, where the sun is seen to rise when in the equinoctial.

**EASTER**, a festival of the christian church, observed in memory of our Saviour's resurrection.

The Greeks call it *pascha*, the Latins *pascha*, an Hebrew word signifying *passage*, applied to the Jewish feast of the passover. It is called easter in the English, from the goddess Eostre, worshipped by the Saxons with peculiar ceremonies in the month of April.

The Asiatic churches kept their easter upon the very same day the Jews observed their passover; and others, on the first Sunday after the first full moon in the new year. This controversy was determined in the council of Nice, when it was ordained that easter should be kept upon one and the same day, which should always be a Sunday, in all christian Churches in the world. For the method of finding easter by calculation, see Vol. I. p. 492.

**EASTERN**, an appellation given to whatever relates to the east: thus we say, eastern amplitude, eastern church, &c.

**EATON**, a town of Buckinghamshire, situated on the north side of the Thames, opposite to Windsor, and famous for its collegial school, founded by king Henry VI. being a seminary for king's college Cambridge, the fellows of which are all from this school.

**EAVES**; in architecture, the margin or edge of the roof of an house; being the lowest tiles, slates, or the like, that hang over the walls, to throw off water to a distance from the wall

**EBBING of the tides**. See Vol. I. p. 473.

**EBDOMARIUS**, in ecclesiastical writers, an officer formerly appointed weekly to superintend the performance of divine service in cathedrals, and prescribe the duties of each person attending in the choir, as to reading, singing, praying, &c.

**EBENUS**, the **EBONY-TREE**, in botany, a genus of the diadelphia decandria class. The calix has a number of small hairy teeth, as long as the corolla; the corolla

corolla has hardly any wings; and the pod is hairy, and contains but one seed. There is but one species, a native of Crete.

**EBIONITES**, in church-history, heretics of the first century, so called from their leader Ebion.

They held the same errors with the Nazarenes, united the ceremony of the Mosaic institution with the precepts of the gospel, observed both the Jewish sabbath and Christian Sunday, and in celebrating the eucharist made use of unleavened bread. They abstained from the flesh of animals, and even from milk. In relation to Jesus Christ, some of them held, that he was born like other men, of Joseph and Mary, and acquired sanctification only by his good works. Others of them allowed, that he was born of a virgin, but denied that he was the Word of God, or had any existence before his human generation. They said, he was indeed the only true Prophet; but yet a mere man, who, by his virtue, had arrived at being called Christ, and the Son of God. They also supposed, that Christ and the devil were two principles, which God had opposed to each other. Of the New Testament they only received the gospel of St Matthew, which they called the gospel according to the Hebrews.

**EBRO**, anciently **IBERUS**, a large river of Spain, which taking its rise in Old Castile, runs through Biscay and Arragon, passes by Saragosa, and, continuing its course through Catalonia, discharges itself with great rapidity into the Mediterranean, about twenty miles below the city of Tortosa.

**EBULLITION**. See **BOILING**.

**EBULUS**, in botany. See **SYMBUCUS**.

**ECBOLIUM**, in botany. See **ADHATODA**.

**ECCHYMOSIS**, in surgery, an extravasation of the blood from a vein in the arm betwixt the flesh and skin.

**ECCLESIASTES**, a canonical book of the Old Testament, the design of which is to shew the vanity of all sublunary things.

It was composed by Solomon, who enumerates the several objects on which men place their happiness, and then shews the insufficiency of all worldly enjoyments.

The Talmudists make king Hezekiah to be the author of it; Grotius ascribes it to Zorobabel, and others to Isaiah; but the generality of commentators believe this book to be the produce of Solomon's repentance, after having experienced all the follies and pleasures of life.

**ECCLESIASTICAL**, an appellation given to whatever belongs to the church: thus we say, ecclesiastical polity, jurisdiction, history, &c.

**ECCLESIASTICUS**, an apocryphal book, generally bound up with the scriptures, so called, from its being read in the church, *ecclesia*, as a book of piety and instruction, but not of infallible authority.

The author of this book was a Jew, called Jesus the son of Sirach. The Greeks call it the wisdom of the son of Sirach.

**ECCOPE**, in surgery. See **AMPUTATION**.

**ECCOPROTICS**, in pharmacy. See **CATHARTICS**, and **EVACUANTS**.

**ECHAPE**, in the menage, a horse begot between a stallion and a mare of different breeds and countries.

**ECHAPER**, in the menage, a gallicism used in the academies, implying to give a horse head, or to put on at full speed.

**ECHENEIS**, in ichthyology, a genus belonging to the order of thoracici. The head is fat, naked, depressed, and marked with a number of transverse ridges: it has ten rays in the branchiostegic membrane; and the body is naked. There are two species, *viz.* 1. the remora, with a forked tail, and eighteen strige on the head. It is found in the Indian ocean. 2. The pycrates, with an undivided tail, and twenty-four strige on the head. It is likewise a native of the Indian ocean.

**ECHEVIN**, in the French and Dutch polity, a magistrate elected by the inhabitants of a city or town, to take care of their common concerns, and the decoration and cleanliness of the city.

At Paris, there is a prévôt, and four echevins; in other towns, a mayor and echevins. At Amsterdam, there are nine echevins; and, at Rotterdam, seven.

In France, the echevins take cognizance of rénts, taxes, and the navigation of rivers, &c. In Holland, they judge of civil and criminal causes; and if the criminal confesses himself guilty, they can see their sentence executed without appeal.

**ECHINATE**, or **ECHINATED**, an appellation given to whatever is prickly, thereby resembling the hedgehog.

**ECHINITES**, in natural history, the name by which authors call the fossil centronia, frequently found in our chalk-pits. See **CENTRONIA**.

**ECHINOPHORA**, in botany, a genus of the pentandria digynia class. The fruit has sunk peduncles. There are two species, one of which, *viz.* the spinosa, or prickly samphire, is a native of Britain.

**ECHINOPS**, **GLOVE-TWISTLE**, in botany, a genus of the syngenesia polygamia segregata class. The proper calix is erect, imbricated, and contains but a single flower. There are three species, none of them natives of Britain.

**ECHINUS**, in zoology, a genus of insects belonging to the order of vermes mollusca. The body is roundish, covered with a bony crust, and often beset with moveable prickles; and the mouth is below, and consists of five valves. There are seventeen species, all natives of the sea.

**ECHINUS**, in architecture, a member or ornament near the bottom of the Ionic, Corinthian, and composite capitals.

**ECHIUM**, **VIPER'S BUGLOSS**, in botany, a genus of the pentandria monogynia class. The corolla is irregular, with a naked faux. There are seven species, three of which are natives of Britain, *viz.* the vulgare, or viper's bugloss; the anglicum, or English viper's bugloss; and the italicum, or wall-viper's bugloss.

**ECHIO**, a sound reverberated or reflected to the ear from some solid body. See **PNEUMATICS**.

**ECHO**, in architecture, a term applied to certain kinds

of vaults and arches, most commonly of elliptical and parabolical figures, used to redouble sounds, and produce artificial echos.

**ECHOMETER**, among musicians, a kind of scale or rule, with several lines thereon, serving to measure the duration and length of sounds, and to find their intervals and ratios.

**ECLECTICS**, ancient philosophers, who, without attaching themselves to any particular sect, selected whatever appeared to them the best and most rational, from each.

Potamon of Alexandria was the first of the eclectics: he lived in the reigns of Augustus and Tiberius; and being tired with the scepticism of the Pyrrhonians, he resolved upon a scheme that would allow him to believe something, but without being so implicit as to swallow any entire hypothesis.

**ECLECTOS**. See **LINCTUS**.

**ECLIPSE**, in astronomy, the deprivation of the light of the sun, or of some heavenly body, by the interposition of another heavenly body between our sight and it. See Vol. I. p. 476.

**ECLIPTIC**, in astronomy, a great circle of the sphere, supposed to be drawn through the middle of the zodiac, making an angle with the equinoctial of about  $23^{\circ} 30'$ , which is the sun's greatest declination; or, more strictly speaking, it is that path or way among the fixed stars, that the earth appears to describe to an eye placed in the sun. See **ASTRONOMY**, and **GEOGRAPHY**.

**ECLOGUE**. in poetry, a kind of pastoral composition, or a small elegant poem, in a natural simple style.

The models in this sort of poetry are Theocritus and Virgil.

**ECOUTE**, in the menage, a pace or motion of a horse, when he rides well upon the hands and the heels, is compactly put upon his haunches, and hears or listens to the heels or spurs, and continues duly balanced between the heels, without throwing to either side. This happens when a horse has a fine sense of the aids of the hand and heel.

**ECPHRACTICS**. in medicine, remedies which attenuate and remove obstructions. See **ATTENUANTS**, and **DEOBSRUENTS**.

**ECPIESMA**, in surgery, a sort of fracture of the cranium, when the bones are much shattered, and, pressing inwardly, affect the membranes of the brain.

**ECPIESMA**, in pharmacy, signifies the mass remaining after the juices of vegetables have been pressed out: and, in this sense is the same as magma. It sometimes further imports the juice pressed out.

**ECPIESMUS**, in the ancient writers of medicine, a word used to express a distemperature of the eye, consisting in a very great prominence of the entire globe of the eye, which is, as it were, thrust out of its socket or orbit, by a great flux of humours, or an inflammation.

**ECPUCTICA**, in pharmacy. See **INCRASSANTS**.

**ECTHESIS**, in church-history, a confession of faith, in the form of an edict, published in the year 639, by the emperor Heraclius, with a view to pacify the troubles

occasioned by the Eutychian heresy in the eastern church. However, the same prince revoked it, on being informed that pope Severinus had condemned it, as favouring the Monothelites; declaring at the same time, that Sergius, patriarch of Constantinople, was the author of it.

**ECTHILIPSIS**, among Latin grammarians a figure of prosody whereby the *m* at the end of a word, when the following word begins with a vowel, is elided, or cut off, together with the vowel preceding it, for the sake of the measure of the verse: thus they read *mult' ille*, for *multum ille*.

**ECTROPIUM**, in surgery, is when the eye-lids are inverted, or retracted so as to shew their internal or red surface, and cannot sufficiently cover the eye.

**ECTYLOICS**, in pharmacy, remedies proper for consuming callosities.

**ECU**, or **ESCU**, a French crown, for the value of which, see **MONEY**.

**EDDISH**, or **EADISH**, the latter pasture, or grass that comes after mowing or reaping; otherwise called *ca-grass*, or *earth*, and *etch*.

**EDDY TIDE**, or **EDDY WATER**, among seamen, is where the water runs back contrary to the tide; or that which hinders the free passage of the stream, and so causes it to return again.

**EDDY-WIND** is that which returns, or is beat back from a sail mountain, or any thing that may hinder its passage.

**EDESSA**. See **ORFA**.

**EDICT**, in matters of polity, an order or instrument, signed and sealed by a prince, to serve as a law to his subjects. We find frequent mention of the edicts of the prætor, the ordinances of that officer in the Roman law. In the French law, the edicts are of several kinds; some importing a new law or regulation; others, the erection of new offices; establishments of duties, rents, &c. and sometimes articles of pacification. In France, edicts are much the same as a proclamation is with us; but with this difference, that the former have the authority of a law in themselves, from the power which issues them forth, whereas the latter are only declarations of a law, to which they refer, and have no power in themselves.

**EDINBURGH**, the capital city of the kingdom of Scotland, situated W. long.  $3^{\circ}$ , and N. lat.  $56^{\circ}$ .

We shall not spend time in fruitless inquiries into the antiquity of this city, or the etymology of its name; both of which seem to be fabulous and uncertain. It is conjectured by some to have owed its origin and name to Edwin king of Northumberland, about the year 600: is taken notice of by authors in the 854 as a small and inconsiderable village, and only about the middle of the 14th century as the capital of Scotland.

Edinburgh is situated upon a steep hill rising from east to west, and terminating in a high and inaccessible rock, upon which the castle stands. At the east end, or lower extremity of this hill, stands the abbey of Holyrood-house, or king's palace, distant from the castle upwards of a mile; and betwixt which, along the top of the ridge, and almost in a straight line, runs the high-street of Edinburgh. On each side, and parallel

parallel to this ridge or hill, is another ridge of ground lower than that in the middle, and which does not extend so far to the east; that on the south being intercepted by Salisbury-rocks, and Arthur's-seat, a hill of about 650 feet of perpendicular height; and that on the north by the Calton-hill, considerably lower than Arthur's-seat: so that the situation of this city is most singular and romantic; the east or lower part of the town lying between two high hills; and the west or higher part rising up towards a third hill, little inferior in height to the highest of the other two, upon which, as has been observed, the castle is built, and overlooks the town.

The buildings of the town terminate at the distance of about 200 yards from the castle-gate; which space affords a most delightful as well as convenient and healthful walk to the inhabitants. The prospect from this spot is perhaps the finest any where to be met with, for extent, beauty, and variety.

In the valley or hollow between the mid and south ridge, and nearly parallel to the high-street, is another street called the Cowgate; and the town has now extended itself over most part of that south ridge also. Betwixt the mid and north ridge was a loch, which, till of very late, terminated the town on that side. From the high street towards the loch on the north, and Cowgate on the south, run narrow cross streets or lanes, called wynds and lasses, which grow steeper and steeper the farther west or nearer the castle; so that, were it not for the closeness and great height of the buildings, this city, from its situation and plan, might naturally be expected to be the best aired as well as the cleanliest in Europe. The first, notwithstanding these disadvantages, it enjoys in an eminent degree; but we cannot compliment it upon the latter, notwithstanding every possible means has been used by the magistrates for that purpose.

The steepness of the ascent makes the access to the high street from the north and south very difficult; and has no doubt greatly retarded the enlargement of this city. To remedy this inconvenience on the north, and with a view to extend the town on that quarter, a most elegant bridge is presently throwing over the north loch, which will join the north ridge to the middle of the high-street, by so easy an ascent as one in sixteen; and in pursuance of this design a plan of a new town to the north is fixed upon, and is actually carrying into execution with surprising rapidity, and with an elegance and taste that does honour to this country.

The principal public buildings in Edinburgh may be reduced to four *viz.* St Giles's church, the palace of Holyrood-house, Herriot's hospital, and the Royal Infirmary.—St Giles's church is the most ancient church in Edinburgh, in so much that it is not known when or by whom it was founded. It stands on the south-side of the high street, about a quarter of a mile below the castle. It is a very large, irregular, and heavy building, except the steeple, which rises with a square stalk from the middle of the structure, and terminates in the form of an imperial crown,

and is reckoned the finest in Britain for elegance and symmetry.

The abbey of Holyrood-house was erected by David I. *anno* 1128, in memory, as is said, of his deliverance from the horns of an enraged hart, by the interposition of heaven in the form of a cross. It was first made a royal palace by James V. about the year 1528, who built the north wing of the present front, which evidently appears older than the rest. It was completed in the present form by Charles II. in the year 1673; and is justly reckoned a most magnificent and elegant building.

Herriot's hospital was founded, July 1. 1628, by the magistrates of Edinburgh, in virtue of a donation of L. 43 608 : 11 : 3, bequeathed to them by George Herriot, goldsmith and jeweller to James VI. "for the maintenance, relief, bringing up, and education of so many poor fatherless boys, steemens sons of the town of Edinburgh," as the above sum should be sufficient for. This hospital contains at present about a hundred and forty boys, who are well educated and taken care of. It has, notwithstanding the large sum laid out in building the house, a great annual revenue; which, as it consists mostly of lands, must always keep pace with the nominal value of money. This hospital is finely situated on the west end of the south ridge, almost opposite to the castle; and is perhaps the most magnificent building of that kind in Britain.

The Royal Infirmary was founded in August 1739, by the magistrates of Edinburgh, in virtue of a charter from the crown, for the reception of poor diseased persons; and by conduct in the management of its funds, which arose mostly from the public contributions, and were but very scanty, has proved an inestimable blessing to this country. This hospital stands near the east end of the south ridge; and is thought by some to be rather too magnificent, considering the purpose for which it is designed, and the narrowness of the original funds.

Edinburgh, as not being properly a sea-port town, has never been remarkable for trade. The chief advantages it enjoys arise from the supreme courts of justice, which are there held; and from its college, which has become famous over Europe, particularly for physic.

**EDITOR.** a person of learning, who has the care of an impression of any work, particularly that of an ancient author: thus Erasmus was a great editor; the Louvain doctors, Scaliger, Petavius, F. Sirmond, bishop Walton, Mr Hearn, Mr Ruddiman, &c. are likewise famous editors.

**EDUCATION,** the instructing children, and youth in general, in such branches of knowledge and polite exercises, as are suitable to their genius and station.

Education is a very extensive subject, that has employed the thoughts and pens of the greatest men: Locke, the archbishop of Cambray, Tanaquil Faber, M. Crousaz, Rollin, and Kouffcau, may be consulted on this head.

The principal aim of parents should be, to know what sphere of life their children are designed to act

in;

in; what education is really suitable to them; what will be the consequence of neglecting that; and what chance a superior education will give them, for their advancement in the world. Their chief study should be to give their children such a degree of knowledge, as will qualify them to fill some certain post or station in life: in short, to fit them for an employment suited to their condition and capacity, such as will make them happy in themselves and useful to society.

**EDULCORATION**, in chemistry, the separating, by a washing or solution in water, the salt that anybody may be impregnated with, or those that may be left adhering to a body after any operation. See **CHEMISTRY**.

**EEL**, in ichthyology, a species of *muræna*. See **MURÆNA**.

**EEL-SPEAR**, a forked instrument with three or four jagged teeth, used for catching of eels: that with the four teeth is best, which they strike into the mud at the bottom of the river, and if it strike against any eels it never fails to bring them up.

**EFFARE**, or **EFFRAYE**, in heraldry, a term applied to a beast rearing on its hind-legs, as if it were frightened or provoked.

**EFFECT**, in a general sense, is that which results from, or is produced by, any cause. See **CAUSE**.

**EFFECTS**, in commerce, law, &c. the goods possessed by any person, whether moveable or immoveable.

**EFFERDING**, a town of Upper Austria, about ten miles west of Lintz.

**EFFERVESCENCE**, in a general sense, signifies a slight degree of ebullition in liquors exposed to a due degree of heat: but the chemists apply it to that intestine motion excited in various fluids, either by the mixture of fluids with others of a different nature; or by dropping salts or powders of various kinds into fluids. See **POWDERS**.

**EFFIGY**, the portrait, figure, or exact representation of a person.

**EFFLORESCENCE**, among physicians, the same with exanthema. See **EXANTHEMA**.

**EFFLUVIUM**, in physiology, a term much used by philosophers and physicians, to express the minute particles which exhale from most, if not all, terrestrial bodies in form of insensible vapours.

**EFFUSION**, in a general sense, the pouring out of any thing liquid, and that with some violence.

**EFT**, in zoology, the English name of the common lizard. See **LACERTUS**.

**EGERMOND**, a market-town of Cumberland, ten miles south of Cockermouth.

**EGG**, in physiology, a body formed in certain females, in which is contained an embryo, or fœtus of the same species, under a cortical surface or shell. The exterior part of an egg is the shell, which in a hen, for instance, is a white, thin, and friable cortex, including all the other parts. The shell becomes more brittle by being exposed to a dry heat. It is lined every where with a very thin but a pretty tough membrane, which dividing at, or very near, the obtuse end of the egg, forms a small bag, where only air is contain-

ed. In new laid eggs this folliculus appears very little, but becomes larger when the egg is kept.

Within this are contained the albumen or white, and the vitellus or yolk; each of which have their different virtues.

The albumen is a cold, viscuous, white liquor in the egg, different in consistence in its different parts. It is observed, that there are two distinct albumens, each of which are inclosed in its proper membrane; of these, one is very thin and liquid, and the other more dense and viscuous, and of a somewhat whiter colour; but, in old and stale eggs, after some days incubation, inclining to a yellow. As this second albumen covers the yolk on all sides, so it is itself surrounded by the other external liquid. The albumen of a fecundated egg, is as sweet and free from corruption, during all the time of incubation, as it is in new-laid eggs; as is also the vitellus. As the eggs of hens consist of two liquors separated one from another, and distinguished by two branches of umbilical veins, one of which goes to the vitellus, and the other to the albumen; so it is very probable that they are of different natures, and consequently appointed for different purposes.

When the vitellus grows warm with incubation, it becomes more humid, and like melting wax, or fat; whence it takes up more space; for as the fœtus increases, the albumen insensibly wastes away, and condenses: the vitellus, on the contrary, seems to lose little or nothing of its bulk when the fœtus is perfected, and only appears more liquid and humid when the abdomen of the fœtus begins to be formed.

The chick in the egg is first nourished by the albumen; and when this is consumed, by the vitellus, as with milk. If we compare the chalazæ to the extremities of an axis passing through the vitellus, which is of a spherical form, this sphere will be composed of two unequal portions, its axis not passing through its centre; consequently, since it is heavier than the white, its smaller portion must always be uppermost in all positions of the egg.

The yellowish white round spot, called cicatricula, is placed on the middle of the smaller portion of the yolk; and therefore, from what has been said in the last paragraph, must always appear on the superior part of the vitellus.

Not long before the exclusion of the chick, the whole yolk is taken into its abdomen; and the shell, at the obtuse end of the egg, frequently appears cracked some time before the exclusion of the chick. The chick is sometimes observed to perforate the shell with its beak. After exclusion, the yolk is gradually wasted, being conveyed into the small guts by a small duct.

Eggs differ very much according to the birds that lay them, according to their colour, form, bigness, age, and the different way of dressing them: those most used in food are hens eggs: of these, such as are new-laid are best.

As to the preservation of eggs, it is observed that the



the egg is always quite full when it is first laid by the hen, but from that time it gradually becomes less and less so, to its decay; and however compact and close its shell may appear, it is nevertheless perforated with a multitude of small holes, though too minute for the discernment of our eyes, the effect of which is a daily decrease of matter within the egg, from the time of its being laid; and the perspiration is much quicker in hot weather than in cold.

To preserve the egg fresh, there needs no more than to preserve it full, and stop its transpiration; the method of doing which is, by stopping up those pores with matter which is not soluble in watery fluids; and on this principle it is, that all kinds of varnish, prepared with spirit of wine, will preserve eggs fresh for a long time, if they are carefully rubbed all over the shell: tallow, or mutton fat, is also good for this purpose, for such as are rubbed over with this will keep as long as those coated over with varnish.

*Artificial method of hatching eggs.* See HATCHING.

EGLANTINE, in botany. See ROSA.

EGRA, a city of Bohemia, situated on a river of the same name, about seventy-five miles west of Prague: E. long. 12° 22', N. lat. 50° 10'.

EGYPT, an extensive country of Africa, lying between 30° and 36° of east longitude, and between 21° and 31° of north latitude; and bounded by the Mediterranean on the north; by the Red-sea and Isthmus of Suez, which divide it from Arabia, on the east; by Abyssinia or Ethiopia, on the south; and by the deserts of Barca and Nubia, on the west; being six hundred miles in length from north to south, and from one hundred to two hundred in breadth from east to west. Egypt is subject to the grand signior, and governed by a bashaw, or viceroy. It owes its fertility to the annual overflowing of the Nile, which it begins to do in the months of May and June, and is usually at its height in September, from which time the waters decrease till May or June again. By this supply of water, Egypt is rendered so fruitful, as to serve Constantinople and other places with corn, as it did Rome and Italy of old. They only harrow their grain into the mud, on the retiring of the water, and in March following usually have a plentiful harvest; and the lands, not sown, yield good crops of grass for the use of the cattle. According to Mr. Sandys, no country in the world is better furnished with grain, flesh, fish, sugar, fruits, melons, roots, and other garden stuff, than the lower Egypt.

EGYPTEN, a town of Courlapd, seventy miles south-east of Mittau.

EGYPTIANS, or GYPSIES, in Scots law, a band of robbers originally from Egypt, which infested Scotland about the end of the 16th century.

EJACULATOR, a muscle of the penis. See Vol. I. p. 170.

EICHGERNAC, a town of Luxemburg, seven miles north-west of Treves.

EJECTA, a term used, by lawyers, for a woman de-flowered, or cast from the virtuous.

EJECTION, in the animal oeconomy, evacuation, or

the discharging any thing through some of the emunctories, as by stool, vomit, &c.

EJECTION, in Scots law, is the turning out the possessor of any heritable subject by force; and is either *legal* or *illegal*.—Legal ejection is where a person having no title to possess, is turned out by the authority of law: See REMOVING. Illegal ejection, is one person's violently turning another out of possession without lawful authority. See LAW, title 29.

EIENHOVEN, a town of Dutch Brabant, fifteen miles south of Boisleduc.

EIFIELD, or ELFIELD, a town of lower Saxony, six miles north-west of Mentz.

EIGHT, or PIECE OF EIGHT. See MONEY.

EIMBECK, a town of lower Saxony, belonging to the elector of Hanover, twenty-five miles south of Hildesheim.

EISLEBEA, a town of Upper Saxony, five miles east of Mansfield, remarkable for being the birth-place of Luther.

ELÆAGNUS, DUTCH MYRTLE, in botany, a genus of the tetrandria-monogynia class. It has no corolla; the calix is bell-shaped above the fruit, and has four segments; and the drupa is bell-shaped, and below the calix. There are three species, none of them natives of Britain.

ELÆOTHESIUM, in antiquity, the anointing room, or place where those who were to wrestle, or had bathed, anointed themselves. See GYMNASIUM.

ELAPHEBOLIUM, in Grecian antiquity, the ninth month of the Athenian year, answering to the latter part of February and beginning of March. It consisted of thirty days, and took its name from the festival elaphebolia, kept in this month, in honour of Diana the huntress; on which occasion, a cake made in the form of a deer, was offered to her.

ELASMIS, in natural history, a genus of talcs, composed of small plates in form of spangles; and either single, and not farther fissile; or, if complex, only fissile to a certain degree, and that in somewhat thick lamina.

Of these talcs there are several varieties, some with large and others with small spangles, which differ also in colour and other peculiarities.

ELASTIC, in natural philosophy, an appellation given to all bodies endowed with the property of elasticity. See the next article.

ELASTICITY, or ELASTIC FORCE, that property of bodies wherewith they restore themselves to their former figure, after any external pressure. See MECHANICS.

ELATER, in zoology, a genus of insects belonging to the order of coleoptera. The feelers are setaceous. There are 38 species, distinguished by their colour, &c.

ELATERIUM, in pharmacy, imports, in general, any purging medicine; but is particularly applied to those which operate with violence.

ELATINÉ, in botany, a genus of the octandria-tetragynia class. The calix consists of four leaves, and the corolla of four petals; the capsule has four cells and

four depressed valves. There are two species, one of which, *viz.* the *almalstrum* or water-wort, is a native of Britain.

**ELBE**, a large river in Germany, which, rising on the confines of Silesia, runs through Bohemia, Saxony, and Brandenburg; and afterwards dividing the dutchy of Lunenburg from that of Mecklenburg, as also the dutchy of Bremen from Holstein, it falls into the German ocean, about seventy miles below Hamburg.

It is navigable for great ships higher than any river in Europe.

**ELBOW**, in anatomy, the juncture of the cubitus and radius; or the outer angle made by the flexure or bend of the arm. See **ANATOMY**.

**ELCESAITES**, in church-history, ancient heretics, who made their appearance in the reign of the emperor Trajan, and took their name from their leader Elcesai. The elcesaites kept a mean between the Jews, Christians, and Pagans; they worshipped but one God, observed the Jewish sabbath, circumcision, and the other ceremonies of the law. They rejected the pentateuch, and the prophets; nor had they more respect for the writings of the apostles, particularly those of St. Paul.

**ELDERS** or **SENIORS**, in Jewish history, were persons the most considerable for age, experience, and wisdom. Of this sort were the seventy men whom Moses associated to himself in the government of his people; such, likewise, afterwards were those who held the first rank in the synagogue, as presidents.

In the first assemblies of the primitive Christians, those who held the first place were called elders. The word presbyter, often used in the New Testament, is of the same signification: hence the first councils of Christians were called presbyteria, or councils of elders.

**ELDER** is also a denomination still preserved in the presbyterian discipline. See **PRESBYTERIAN**.

**ELDER**, or **ALDER**, in botany. See **ALNUS**.

**ELECAMPANE**, in botany. See **INULA**.

**ELECT**, among ecclesiastical writers, those whom God has chosen, or predestinated to be saved.

**ELECTION**, the choice that is made of a person, or thing, in preference of any other; as in the election of an emperor, of a pope, of a bishop, of members of parliament, &c.

**ELECTION**, in theology, signifies the choice which God makes of angels and men for the objects of his grace and mercy. See **GRACE**, and **PREDESTINATION**.

**ELECTOR**, a person who has a right to elect or chuse another to an office, honour, &c.

Electors are particularly, and by way of eminence, applied to those princes of Germany in whom lies the right of electing the emperor: being all sovereign princes, and the principal members of the empire.

The electoral college, consisting of all the electors of the empire, is the most illustrious and august body in Europe. Bellarmine and Baronius attribute the institution of it to pope Gregory V. and the emperor Otto III. in the tenth century; of which opinion are

the generality of historians, and particularly the canonists: however, the number of electors was unfixed, at least, till the thirteenth century. In 1356 Charles IV. by the golden bull, fixed the number of electors to seven; three ecclesiastical, *viz.* the archbishops of Mentz, Treves, and Cologne; and four secular, *viz.* the king of Bohemia, count Palatine of the Rhine, duke of Saxony, and marquis of Brandenburg. In 1648 this order was changed, the duke of Bavaria being put in the place of the count Palatine, who having accepted the crown of Bohemia was outlawed by the emperor; but being at length restored, an eighth electorate was erected for the duke of Bavaria. In 1692, a ninth electorate was created, by the emperor Leopold, in favour of the duke of Hanover, of the house of Brunwic Lunenburg.

There is this difference between the secular and ecclesiastical electors, that the first have an active and passive voice, that is, may chuse and be chosen; the last, an active only. The three archbishops are to be thirty years old, before they can be advanced to the dignity; the seculars, eighteen, before they can perform the office themselves. These last have each their vicars, who officiate in their absence.

Besides the power of chusing an emperor, the electors have also that of capitulating with, and deposing him; so that, if there be one suffrage wanting, a protest may be entered against the proceedings. By the right of capitulation, they attribute to themselves great privileges, as making of war, coining, and taking care of the public interest and security of the states; and the emperor promises, upon oath, to receive the empire upon these conditions.

The electors have precedence of all other princes of the empire, even of cardinals and kings; and are addressed under the title of electoral highness.

Their several functions are as follow: the elector of Mentz is chancellor of Germany, convokes the states, and gives his vote before any of the rest. The elector of Cologne is grand chancellor of Italy, and consecrates the emperor. The elector of Treves is chancellor of the Gauls, and confers imposition of hands upon the emperor. The count Palatine of the Rhine is great treasurer of the empire, and presents the emperor with a globe at his coronation. The elector of Bavaria is great master of the imperial palace, and carries the golden apple. The marquis of Brandenburg is grand chamberlain, and puts the ring on the emperor's finger. The elector of Saxony is grand marshal, and gives the sword to the emperor. The king of Bohemia is grand butler, and puts Charlemaign's crown on the emperor's head. Lastly, the elector of Hanover, now king of Great Britain, is arch-treasurer, though first erected under the title of standard-bearer of the empire.

**ELECTORATE**, a term used as well to signify the dignity of, as the territories belonging to, any of the electors of Germany; such are Bavaria, Saxony, &c.

ELEC-

# ELECTRICITY.

**T**HE word ELECTRICITY signifies, in general, the effects of a very subtile fluid matter, different in its properties from every other fluid we are acquainted with. This fluid is capable of uniting with almost every body, but unites more readily with some particular bodies than with others: its motion is amazingly quick, is regulated by peculiar laws, and produces a vast variety of singular phenomena, the principal of which shall be enumerated in this article.

As we are entirely ignorant of the nature of the electrical fluid, it is impossible to define it but by its principal properties: that of repelling and attracting light bodies, is one of the most remarkable. The ancients were only acquainted with this property in amber. William Gilbert, a native of Colchester, and physician at London, in his treatise *De Magnete*, in the year 1600, was the first person who discovered, that sulphur, wax, resinous substances, glass, and precious stones, when dried and rubbed a little, were endowed with the same property of attracting and repelling straws and other light substances. Sir Francis Bacon, in his physiological remains, gives a catalogue of electrical bodies; but it differs in nothing worth mentioning from that of Gilbert. Mr Boyle, about the year 1670, made some addition to the catalogue of electric substances; but all his experiments on this subject relate only to a few circumstances attending the simple property of electric attraction: he had never seen the electric light, and little imagined what astonishing effects would be afterwards produced by this wonderful power.

Cotemporary with Mr Boyle was Otto Guericke, burgo-master of Magdeburg, and inventor of the air-pump, who was likewise one of the first improvers of electricity. He made his experiments with a globe of sulphur, which he mounted on an axis, and whirled it in a wooden frame, rubbing it at the same time with his hand. He first discovered, that a body once attracted by an excited electric was repelled by it, and not attracted again till it had been touched by some other body: that bodies immersed in electric atmospheres are themselves electrified: that threads suspended within a small distance of his excited globe, were often repelled by his finger brought near them: that a feather, repelled by the globe, always turned the same face towards it, like the moon with respect to the earth: and that the excitation of his globe produced both light and sound, though in a very inconsiderable degree. A much finer electric light was afterwards observed by Dr Wall, and an account of it was published in the Philosophical Transactions: Dr Wall likewise compares the light and the crackling of his excited amber to thunder and lightening.

Sir Isaac Newton, in 1675, was the first who discovered that excited glass attracted light bodies on the side opposite to that on which it was rubbed.

After Gilbert, Boyle, and Otto Guericke, Mr Hawkef-

bee, in his Physico-mechanical Experiments, published in the year 1700, distinguished himself by his experiments and discoveries in electricity. He first discovered the electric power of glass, the light proceeding from it, and the noise occasioned by it, together with a variety of phenomena relating to electric attraction and repulsion: Indeed little was added to his observations, till the discovery of a plus and minus electricity by Dr Watson and Dr Franklin about the year 1746, and the farther illustration of that doctrine by Mr Canton.

From the year 1730 to the 1746, the writers on electricity are so numerous, and their experiments so many and various, that a volume would be insufficient for their history. We shall therefore endeavour, in the *first* place, To give a short and connected view of the nature and principles of electricity, so far as they have hitherto been unfolded, without mentioning the persons to whom we are indebted for any particular discovery: And, in the *second* place, Give a description of electrical machines; with a selection of a few of the most curious and useful experiments, which the reader may easily understand after having made himself acquainted with the general principles.

It has been asserted, that all bodies, provided they be heated to a certain degree, and rubbed for a long time, will discover themselves to be possessed of the property of attracting and repelling light substances. However, metals of all kinds, although ever so much heated, or rubbed, or polished, never discover the least signs of electrical attraction; and consequently are excepted from the general rule, as well as water and other fluids, which cannot be subjected to the necessary treatment. Although most bodies, by being heated and rubbed, discover more or less of electrical attraction; yet, as some of them possess this property in a more eminent degree, and with less labour, this circumstance has suggested a division of bodies into two classes, according as they are more or less susceptible of electricity.

The first class comprehends those bodies which receive and collect the electrical matter most easily, and in greatest quantity, after being a little rubbed and heated: these bodies are called *electrics*, or *non conductors*; such as,

1. Diamonds of all kinds; the ruby, the sapphire, the emerald, the opal, the amethyst, the topaz, the beryl, the granat, rock crystal, &c.
2. Glass, and all vitrified bodies, enamels of all colours, porcelain, glass of antimony, of lead, &c.
3. Balsams, resins of all kinds, wax, &c.
4. Bituminous bodies, sulphur, amber, asphaltum, &c.
5. Certain animal productions; as silk, feathers, wool, hairs, and bristles, &c.

The second class comprehends these bodies which either do not at all collect the electrical matter by friction,

or

or in a very inconsiderable degree: such bodies are called *non-electrics*, or *conductors*, viz.

1. Water, and all aqueous and spirituous liquors, which are incapable of being thickened, and subjected to friction

2. All metals, perfect and imperfect, and the greatest part of minerals; as, the load-stone, antimony, zinc, bismuth, the agat, the jasper, marble, free-stone, slate, &c.

3. All living creatures, excepting their hair. To which may be added most animal-sustances; as leather, parchment, bone, ivory, horn, shells, &c.

4. Trees and plants of all kinds; thread, ropes, linen-cloth, paper, &c.

These two classes of bodies have been called by the name of *electrics* and *non-electrics*: but as the electrical matter is not contained in the electrical bodies themselves, but collected by them from the earth; and as non-electric allow the electrical matter to penetrate and flow through them, or to spread equally on their surfaces, the terms *conductor* and *non conductor* are more proper. Metals and water are the only perfect conductors; other bodies conducting only as they contain a mixture of these, without more or less of which they will not conduct at all.

Although conductors cannot be electrified by heat or friction, they may be charged with electricity, or made non-conductors, by an easy operation; but then they retain this property no longer than they are kept from communicating with other conductors. A bar of iron will become an electric or non-conductor, by being suspended by a silk cord, or laid upon a piece of rosin or other non-conductor, and at the same time having one end of it in contact with a well-rubbed glass tube, or globe. In the same manner, water and metals of all kinds may be charged with electricity.

It is absolutely necessary, in exciting electricity by friction, that the glass, or other body, be perfectly dry; the least moisture destroys, or at least diminishes the effect. A moist atmosphere, a burning candle, &c. are extremely unfavourable in making electrical experiments.

Hollow glass globes, of about a foot diameter, and the 16th part of an inch thick, are now used in place of tubes, because it lessens the labour of friction, and accumulates a greater quantity of electrical matter. This globe is turned rapidly by a large wheel like those used by the cutlers. When the globe is rubbed, it soon acquires a considerable degree of electrical virtue, which is discovered by light bodies, at the distance of two or three feet, flying towards it. In approaching the globe with the hand or face, you will likewise feel the electric matter surrounding it like a gentle breeze of wind. These subtle emanations continue to be diffused round the globe as long as the friction is continued; and, when the friction is stopped, they gradually diminish, till they are no longer perceptible. The application of non-conductors to the globe does not diminish the electrical matter: on the contrary, the application of conductors almost instantly annihilates the whole quantity previously collected by the friction. But this effect is not produced, unless when the

conductor at the same time has a communication with the floor or earth where the machine stands. For, as above observed, if the conductor has no communication with the earth, it charges with electricity, and becomes a non-conductor. But non-conductors, as a piece of glass, sulphur, or wax, though they do not diminish the virtue of the globe, yet they do not acquire, like iron, &c. the property of attraction or repulsion. Hence it appears, that the electrical matter passes freely along conductors, and dissipates in the earth; but, on the contrary, that non conductors do not receive any matter from the globe, and are incapable of transmitting it. The following experiments will make this more plain.

1. If a piece of iron be placed on a glass standard, and unconnected with any other body, as soon as the electrical matter is communicated to it, it attracts and repels pieces of gold leaf or other light bodies, and preserves this virtue even for some minutes after its communication with the globe is cut off. But, if a piece of glass, rosin, or any other non-conductor, be placed in the same circumstances, they do not discover any such effect.

2. If a person touches the piece of iron above mentioned with his hand, no friction is capable of making it attract or repel, or exhibit any marks of electricity. The same thing happens, if a chain of any metal touch the iron, and at the same time has a communication with the ground. In both these cases, the electrical matter passes along the iron, and dissipates in the earth.

3. In place of touching the piece of iron with the finger, if a piece of amber, wax, or any other non-conductor be applied to it, the communication with the earth being interrupted by the non-conductor, the iron, in that case, retains the electrical matter as before.

From these experiments we learn, that metals and other conductors receive the electrical matter, and transmit it to other conductors till it diffuses and is lost in the earth; but that, if wax, glass, or any other non-conductor, be applied to the conductor, the motions of the matter is instantly stopt, and accumulates and charges the conductor, at the same time that the non-conductor itself is not all affected. It is for this reason that conductors, as silk-cords, hair-ropes, &c. are always employed to suspend or support such bodies as we want to charge with electricity.

The following experiments will throw further light on this subject.

1. If a man stands upon a piece of rosin about five inches in diameter, and seven or eight inches thick, touching softly the globe, while the operator is rubbing it, his whole body, in a few seconds, will be charged with electrical matter; and the following phenomena will take place.

1. His loose hand, and indeed every part of his body, will mutually attract and repel light bodies at the distance of three or four feet.

2. All conductors which he takes in his hand, will become electrified in the same manner with himself, provided they touch nothing else, or be supported upon non-conductors: and this communication to other conductors,

let

let their number and extension be ever so great, instead of diminishing the electrical virtue in the body of the man, will rather augment its strength and quantity.

3. If this person gives his hand to another likewise standing on a similar piece of rosin, he too will be charged with electrical matter; and the same thing will happen to any number of persons, provided they stand upon rosin, and communicate with one another by an iron chain or other conductor. But the whole company will instantaneously lose the whole of their electrical virtue, if any non-electrified person touch a single man, or if there be any communication between one of them and a conducting substance.

4. If the first man removes his hand from the globe, and at the same time keep his former station, he and all the rest will preserve the power of attracting and repelling light substances for some time; but it gradually diminishes, till its effects totally disappear.

5. If a non-electrified person puts his hand near the first man's face, he will feel a kind of atmosphere surrounding the electrified person; if he advances his hand still nearer any part of the face, for example the nose, both the point of the finger and the nose will appear luminous in the dark: Lastly, if he touches the nose, a spark of fire instantly explodes with a crack, and strikes both parties equally with a shock more or less painful in proportion as the electrified person was charged. It is by the explosion of this spark, that the electrical matter instantly transmits itself from one body to another.

6. When we approach near an electrified person, we perceive an extraordinary smell proceeding from his body, similar to that of the phosphorus of urine.

II. An iron wire, 12,000 feet in length, was suspended about five feet from the ground by silk cords; one end of it was connected to the globe of an electrical machine, and at the other a lead ball was hung in order to perceive when the matter reached it.

1. After five or six turns of the wheel, the matter had passed along the whole wire, and communicated its virtue to the ball, which instantly attracted and repelled light bodies.

2. As this ball was equally electrified with every part of the wire, it is probable that the electric matter would instantly pervade a wire of a still greater length, provided we had a proper apparatus for the purpose.

3. Several metals and other conductors were substituted in place of the ball, and all received the electricity in the same manner.

4. The ball and other non-conductors, when touched with the finger, gave a luminous spark and as smart a shock, as when the end of the wire next the globe was touched.

5. All these effects instantly ceased whenever any person not electrified touched any part of the wire, and commenced again a few seconds after his hand was withdrawn.

6. The same effects are produced, though with more difficulty, when hair or woolen ropes were substituted in place of the silk ones: But they were entirely stopt by hemp-ropes, or when the silk ones were wetted.

7. When a hempen rope was substituted in place of

the wire, the ball at the end of it was electrified with greater difficulty than when it hung at the wire, especially when the rope was dry; but when the rope was wet, the matter passed with more ease.

8. When, in place of the wire, a dry silk cord, or long glass tube, were used, they received but a very small quantity of the matter, which was not perceivable in the glass tube above 12 feet, nor in the cord above 25, beyond the globe.

9. When the wire was cut in several places, and the cut ends kept at the distance of somewhat less than a foot from each, the electrical matter darted through all these interruptions, and appeared in the ball at the furthest end. A strong blast made by a bellows across one of the interruptions, did not obstruct the passage of the matter; neither did the interposition of a piece of glass, wax, and other non-conductors: but all conductors, as the hand of a man, the point of a sword, and even a moist vapour, obstructed its course towards the ball.

10. When a man stood on a piece of rosin, and put a point of a sword in one of the interruptions, he was instantly filled with the matter, although neither he nor the sword touched the wire: neither was the course of the matter towards the ball obstructed by the interposition of the sword.

11. When a ring of brass wire, about three feet in diameter, was suspended in a vertical direction, and the iron wire was made to pass nearly through its centre, without touching any part of the circumference, the ring, in whatever part of the wire it was tried, was sensibly electrified. This shows that the electrical matter expands to a considerable distance on all sides of the electrified body.

12. The same iron wire suspended by silk cords was extended 6000 feet, (just one half of its length), in a straight line; the other half was turned back in a parallel direction towards the globe, leaving about nine or ten inches of interval between the two halves of the wire: Each extremity of the wire was supported by a dry silk cord about seven or eight feet from the globe, and the lead ball was hung at one of them. An iron chain was then fixed with another silk cord above the globe, in order to receive the matter at one of its extremities; the other end of the chain was fixed to a rod of glass about five feet long, in such a manner that the matter received from the globe might be transmitted at pleasure to the wire, by applying the end of the fixed chain to the glass rod. Matters being thus prepared, after five or six turns of the wheel, the chain was applied to one end of the wire; at the same instant the ball at the other end attracted and repelled bits of gold-leaf. The same experiment was repeated, and a finger applied to the ball, and a spark issued out, and a shock was received at the very instant that the chain was applied to the other end of the wire: A spark likewise proceeded from the chain, which afforded an easy opportunity of discovering that the two sparks were perfectly synchronous.

From these experiments it appears,

1. That the electrical matter communicates itself to all non-electrics, or conductors, whatever be their bulk or extension.

2. That the quantity of this matter diffused is always in proportion to the magnitude and extension of the bodies into which it passes; and that it is uniformly diffused, no part of the body retaining more than any other part.

3. That, after being thus communicated to any body, it escapes with equal facility, as soon as it finds a communication with the earth.

4. That small interruptions in the continuity of electrified bodies do not interrupt the motion of the electrical matter.

5. That the motion of the electrical matter is so amazingly swift, that it runs over a space of 12,000 feet in an undefinable instant of time.

6. That it moves with equal rapidity either backward or forward, upon the application of a conductor.

7. Lastly, That an indefinitely large quantity of this matter may be accumulated by applying the globe or tube to conducting bodies of very large dimensions. Of late other methods of condensing a large quantity of electrical matter into a small space have been invented, as will afterwards appear when we come to treat of the Leyden phial.

The attraction and repulsion of light bodies, is the first thing that discovers to us the presence of the electrical matter. This motion is always reciprocal: If the electrified body be lighter than the conductor, and both are at liberty, the motion of the former is quicker than that of the latter; if the one be fixed, and the other at liberty, the unfixed one constantly goes to the one that is fixed, and, at the same, takes the shortest road. The following experiments will illustrate these motions.

1. Present an electrified tube to small pieces of gold-leaf placed on a well-polished plate of copper, they will instantly fly towards the tube.

2. Suspend an electrified tube by two silk cords; take a piece of gold-leaf, and, holding it firm betwixt your fingers, bring it near the tube; and the tube will be attracted and move toward the leaf.

3. If an electrified person, standing on a piece of rosin, holds in his hand a plate of copper, upon which pieces of gold-leaf are placed; and another person, who is not electrified, holds his finger above the plate; the gold-leaf will instantly rise from the plate, and fly towards his finger.

4. Lastly, If two balls of gilt paper be suspended six inches asunder, the one by a silk thread three feet in length, and the other by a small silver wire of the same length; when the ball suspended by the silk thread is electrified by the tube, both balls advance with equal quickness towards one another, though only one of them was electrified.

The most favourable circumstances for exhibiting the attraction of light bodies are the following:

1. They should be perfect conductors.
2. They ought to be of a small size.
3. They should be supported by a non-conductor, and raised four or five feet from the ground.
4. No other non-conductor should be nearer the bodies than the tube with which the experiments are making; otherwise the attraction will be disturbed.

Repulsion generally succeeds attraction; that is, a piece of gold leaf is no sooner attracted by the tube than it is repelled and driven off from it. This repulsion is not very perceptible when the tube is slightly electrified: but, when the electricity is brisk, the gold leaf never fails to be repelled as soon as it has touched the tube. Again, if the electricity be very strong, the gold-leaf, though strongly attracted by the tube, never touches it; the repulsive power beginning to operate two or three inches before the leaf reaches the tube: from that instant the leaf is electrified; and, when it begins to be repelled, it has acquired as dense an electrical atmosphere as the tube: it then flies off, and remains suspended above the tube until it loses the electric virtue it had acquired, either by the moist vapours in the air, or till it loses it suddenly by touching some conductor. Hence it appears, that attraction precedes repulsion, only because it is necessary that the pieces of gold-leaf should acquire as dense an atmosphere as that of the globe before they can be repelled by it.

When the tube has repelled a piece of gold leaf, if another tube, nearly equally electrified, be suddenly substituted in place of the former tube, the leaf will continue to be repelled at an equal distance. But if the substituted tube be much less electrified than the original one, the leaf will be attracted by that tube.

When two or more pieces of gold leaf are presented at the same time to a well electrified tube, they are all equally attracted and repelled; but then they mutually repel one another, so that it is impossible to make any two of them join; and the distance at which they repel one another is equal to the distance to which each of them were repelled from the tube.

If a circular piece of gold-leaf, cut into small fringes to near the centre of the leaf, be presented to an electrified tube, it will first be attracted, and then repelled: in the time of repulsion, all the fringes repel each other, and diverge more or less in proportion to the strength of electricity in the tube.

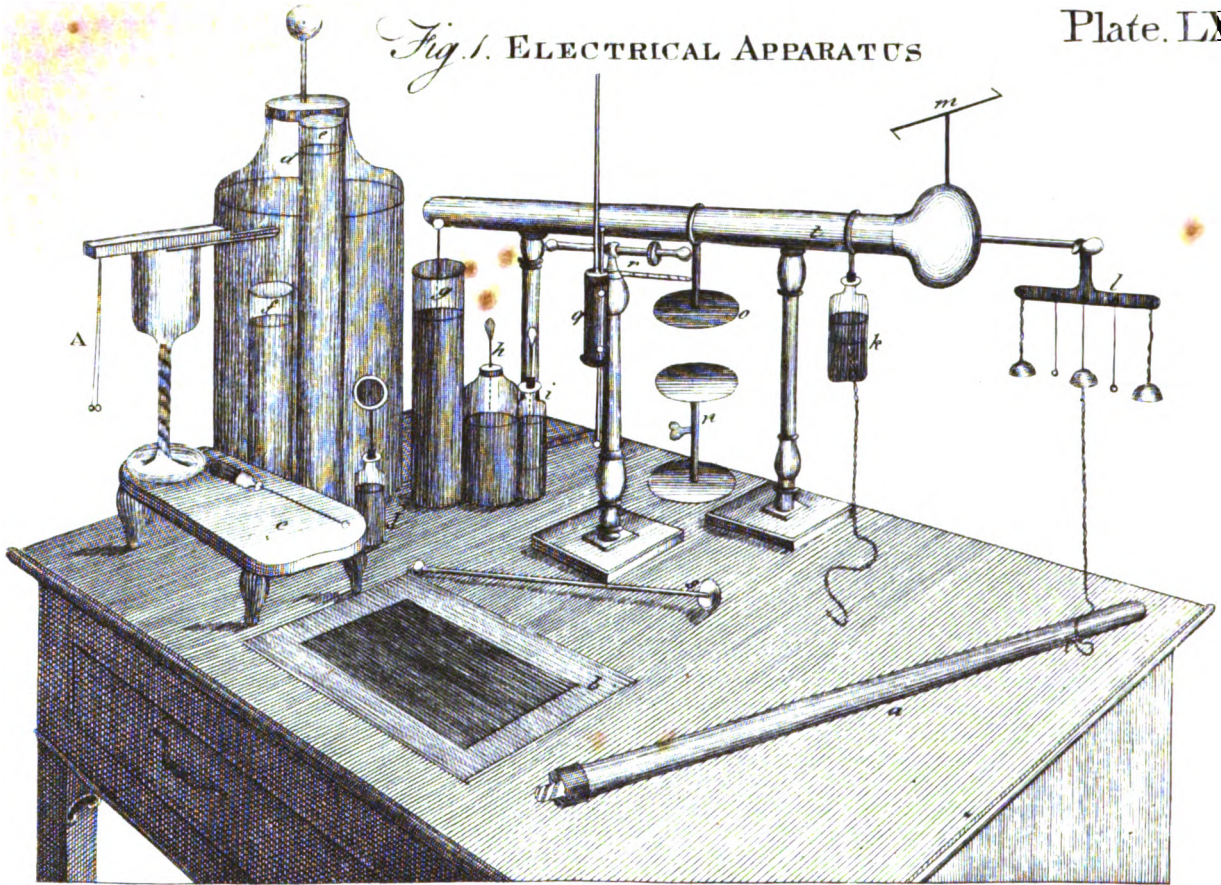
If a small metal vessel filled with water, and furnished with a capillary siphon, having the longer leg hanging over the outside of the vessel, be touched with an electrified iron rod; the water, which could not run out of the siphon but drop by drop, will instantly fly out a tone jet, and divide itself into very fine threads; and these threads continue sometimes suspended in the air, repelled from each other to a considerable distance.

From these instances of attraction and repulsion it appears,

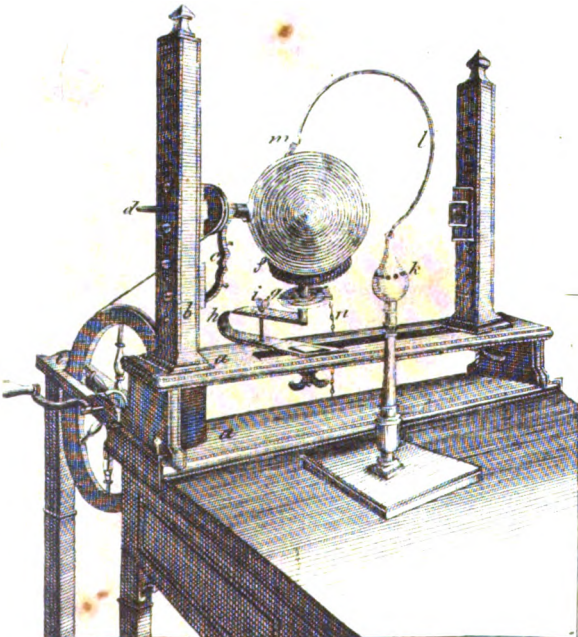
1. That light bodies are attracted by electrified substances until they be equally electrified by communication, and until they acquire as dense an atmosphere as the electrified substances themselves.
2. That, from the moment they acquire this atmosphere, attraction ceases and repulsion begins.
3. That no repulsion takes place but betwixt bodies electrified.
4. That repulsion continues only as long as the density of the two atmospheres are equal; that it ceases whenever the one or the other is diminished; that a new attraction



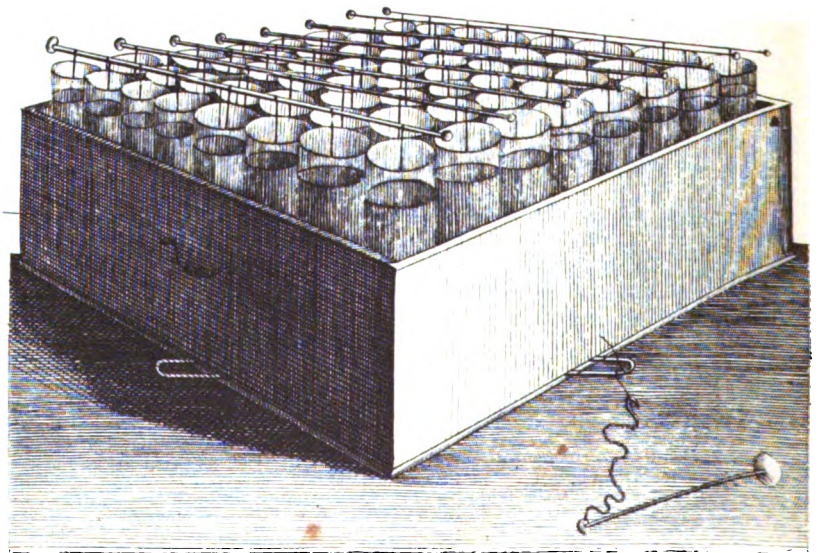
*Fig. 1.* ELECTRICAL APPARATUS



*Fig. 2.*  
PRIESTLY'S ELECTRICAL MACHINE



*Fig. 3.*  
THE BATTERY



*A. Bell Sc.*



traction commences, and continues till an equality in the atmospheres is again restored; and that, immediately upon this, a new repulsion takes place.

5. That repulsion may subsist betwixt two bodies which have never mutually been attracted, provided their atmospheres be equally dense.

6. That the distance to which bodies are repelled is always in proportion to the strength of the electricity they contain. This fact first suggested the notion of an electrometer, or a machine for measuring the different degrees of electricity.

#### *Of Electrical Machines and Apparatus.*

THE improvement of electrical machines has kept pace with the improvements in the science. While nothing more than electrical attraction and repulsion was known, every phenomenon might be exhibited by means of a piece of amber, sealing wax, or glass, which the philosopher rubbed against his coat, and presented to bits of paper, feathers, and other light bodies.

To give a greater degree of friction to electric substances, Otto Guericke and Mr Hawkesbee contrived to whirl sulphur and glass in a spherical form. The first conductors were nothing more than hempen-cords supported by silken lines. In place of these, bars of metal, or gun barrels, were soon substituted; and a rubber was employed to supply the place of a human hand. The discovery of the Leyden bottle, (to be afterwards described) occasioned more additions to the electrical apparatus; and the discoveries of Dr Franklin have made proportional additions necessary. No philosopher can now be satisfied, if he be not able to supply a conductor from the clouds, as well as from the friction of his glass globes or tubes.

Although globes or cylinders are now of the most extensive use in electrical experiments, glass tubes are still most convenient for several purposes; they should be about three feet long, and as wide as a person can conveniently grasp, (Plate LXXIII. fig. 1 *a.*) The thickness of the glass is not material; perhaps the thinner they are the better, if they can bear sufficient friction.

The best rubber for a smooth glass is the rough side of black oiled silk, especially when a little amalgam of mercury or other metal is put upon it.

Glass-globes are in general preferable to cylinders. The globe should have its neck inclosed in a pretty deep brass cap, ending in a dilated brim, of about half an inch broad, if the globe be a large one. It has not been determined what kind of glass is the best; but flint is commonly used. Perhaps globes of twelve or thirteen inches diameter are the best size.

The best rubbers for globes are made of red basil skins, particularly the neck-part of them, where the grain is more open, and the surface somewhat rougher. That the rubber may press the globe equally, it should be put upon a plate of metal bent to the shape of the globe, and stuffed with any thing that is pretty soft: bran is good; and if the stuffing be a conductor, as flax, it will be better than if it be a non-conductor, as hair or wool. It should rest upon a spring, to favour any inequality there may be in the form of the globe. There should

be no sharp edges or angles about the rubber; for that would make the insulation of it ineffectual. By the insulation of the rubber every electrical experiment may be performed with the twofold variety *or positive* and *negative*, and a conductor be made to give and take fire at pleasure. This insulation is best made by means of baked wood, in the form of a plate, five or six inches in diameter, (*y*, fig. 2) interpolated between the metallic part of the rubber and the steel spring that supports it. When positive electricity is intended to be produced, a chain (*n*, fig. 2.) must connect the rubber with the floor; but, when negative electricity is wanted, the chain must be removed, and hung upon the common conductor, while another prime conductor must be connected with the rubber; which will therefore be electrified negatively.

The best method of collecting the electric fire from the globe seems to be by three or four pointed wires, (*m*, fig. 2.) two or three inches long, hanging lightly upon the globe, and suspended on an open metallic ring.

The prime conductor should be fixed very steady: Whatever be the size of the prime conductor, the extremity of it, or that part which is most remote from the globe, should be much larger and rounder than the rest, (*t*, fig. 2); for the effort of the electric matter to fly off is always greatest at the greatest distance from the globe.

The electrician should be provided with METALLIC RODS (*r*, fig. 1.) to take sparks from his conductor for various uses. These should have knobs, larger or smaller in proportion to the curvature of the conductor. If the knob be too small, it will not discharge the conductor at once, but by degrees, and with a less sensible effect; whereas the spark between broad surfaces is thick and strong.

The most formidable part of an electrical apparatus consists in the COATED GLASS that is used for the Leyden experiment. The form of the plate is immaterial with respect to the shock; and, for different experiments, both plates of glass, and jars of various forms and sizes, must be used. For common uses, the most commodious form is that of a jar, as wide as a person can conveniently hold in his hand by grasping, and as tall as it will stand without any danger of falling; perhaps about  $3\frac{1}{2}$  inches in diameter, and 8 inches in height. The mouth should be pretty open, that it may be the more conveniently coated on the inside, as well as the outside, with tinfoil. A considerable variety of these jars may be seen in the above Plate, fig. 1. *c, d, e, f, g, h, i, j, k.*

The method of coating is much preferable to that of putting water or brass-shavings into the jars, which both makes them heavy, and likewise incapable of being inverted, which is requisite in many experiments. Brass-dust, however, or leaden-shot, is very convenient for small phials. The tinfoil may be put on either with paste, gum water, or bees-wax. To coat the insides of vessels which have narrow mouths, moisten the inside with gum water, and then pour some brass dust upon it: Enough will stick to make an exceeding good coating.

In the construction of an ELECTRICAL BATTERY, a  
number

number of small jars are preferable to large ones. If one of them should break by an explosion or any other accident, the loss is less considerable; besides, by means of narrow jars, a greater force (that is, a greater quantity of coated surface) may be contained in less room. The largest jars are about 17 inches in height, and should not be more than 3 in diameter, and of the same width throughout. Thus they may be easily coated both within and without, and a box of a moderate size will contain a prodigious force; for the jars being coated within two inches of the top, each will contain a square foot of coated glass. The battery (Plate LXXIII. fig. 3.) consists of 64 jars, each 8 inches long, and  $2\frac{1}{4}$  in diameter, coated within an inch and a half of the top. The coated part of each is half a square foot; so that the whole battery contains 32 square feet. The wire of each jar has a piece of very small wire twisted about the lower end of it, to touch the inside coating in several places; and it is put through a pretty large piece of cork within the jar, to prevent any part of it from touching the side, which would tend to promote a spontaneous discharge. Each wire is turned round, so as to make a hole or ring at the upper end; and through these rings a pretty thick brass rod with knobs is put, one rod serving for one row of the jars. The communication between these rods is made by laying a chain over them all: this chain is not represented in the plate, lest the figure should appear confused. When only a part of the battery is to be used, the chain should be laid over as many rods as you want rows of jars. The bottom of the box in which all the jars stand is covered with tinfoil and brass-dust; and a bent wire touching this tinfoil is put through the box, and appears on the outside, as in the plate. To this wire is fastened whatever is intended to communicate with the outside of the battery, as the piece of small wire in the figure; and the discharge is made by bringing the brass knob to any of the knobs of the battery.

To discover the kind and degree of electricity, many forms of ELECTROMETERS have been thought of. Mr Canton's balls A, represented on a glass standing on the stool *c*, (Plate LXXIII. fig. 1.) serve to discover small degrees of electricity, to observe the changes of it from positive to negative, and to estimate the force of a shock before the discharge. These balls are two pieces of cork, or pith of elder, nicely turned in a lathe to about the size of a small pea, and suspended on small linen threads. These balls repel one another to distances exactly proportioned to the quantity of electricity contained in the vessel or other substance with which they are connected; and by this work the operator knows pretty exactly the force of the charge, and the shock that will be given.

In order to repeat the experiment tending to shew that the electric fluid is the same with the matter of lightning, and to make observations on the electricity of the atmosphere, the electrician should be provided with A MACHINE FOR DRAWING ELECTRICITY FROM THE CLOUDS. The best construction of which is the following: On the top of any building erect a pole *a*, (Plate LXXIV. fig. 2.) as tall as a man can well manage, having on the top of it a solid piece of glass, or baked

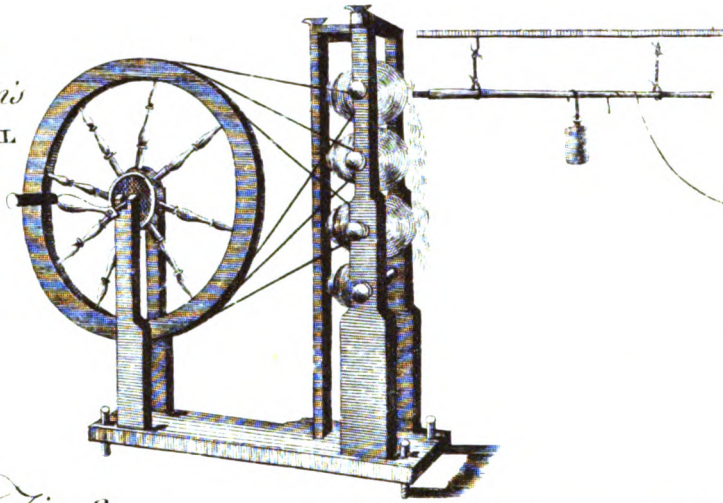
wood, a foot in length. Let this be covered with a tin or copper vessel (*b*) shaped like a funnel, to prevent its ever being wetted; above this, let there rise a long slender rod *c*, terminating in a pointed wire, and having a small wire twisted round its whole length, the better to conduct the electricity to the funnel. From the funnel make a wire (*d*) descend along the building, about a foot distance from it, and conducted through an open path into any room that shall be most convenient for making the experiment. In this room, let a proper conductor be insulated, and connected with the wire coming in at the window. This wire and conductor, being completely insulated, will be electrified whenever there is a considerable quantity of electricity in the air. And notice will be given when it is properly charged, either by Mr Canton's balls hung to it, or by a set of bells disposed in the following manner. Take three bells; suspend the two outermost from the conductor by chains, and that in the middle by a silken string, while a chain connects it with the floor; and hang two small knobs of brass by silken strings, one between each two bells, to serve instead of clappers. In consequence of this disposition, when the two outermost bells, communicating with the conductor, are electrified, they will attract the clappers, and be struck by them. The clappers being thus loaded with electricity, will be repelled, and fly to discharge themselves upon the middle bell. After this, the clappers will be again attracted by the outermost bells; and thus, by striking the bells alternately, a continual ringing may be kept up as long as the operator pleases. In the dark a continual flashing of light will be seen between the clappers and the bells. But when the electrification is very strong, these flashes of light will be so large, that they will be transmitted by the clapper from one bell to the other, without its ever coming to actual contact with either of them, and the ringing will consequently cease.

With regard to the construction of machines for electrical experiments in general, that of Dr Priestly, represented on Plate LXXIII. fig. 2. is perhaps the best. The FRAME consists of two strong boards of mahogany, (*aa*), of the same length, parallel to one another, about four inches asunder, and the lower one is an inch on each side broader than the upper: in the upper board is a groove reaching almost its whole length. One of the pillars *b*, which are of baked wood, is immovable, being let through the upper board, and firmly fixed in the lower; while the other pillar slides in the groove above-mentioned, in order to receive globes or cylinders of different sizes; but it is only wanted when an axis is used. Both the pillars are perforated with holes at equal distances from the top to the bottom; by means of which, globes may be mounted higher or lower according to their size; and they are made tall, to admit the use of two or more globes at a time, one above another. Four of a moderate size may be used, if two be fixed on one axis; and the wheel has several grooves for that purpose.

If a globe with only one neck be used, as in the Plate, a brass arm, with an open socket *c*, is necessary to support the axis beyond the pulley; and this part is also contrived to be put higher or lower, together with the brass socket in which the axis stands. The axis *d*  
let



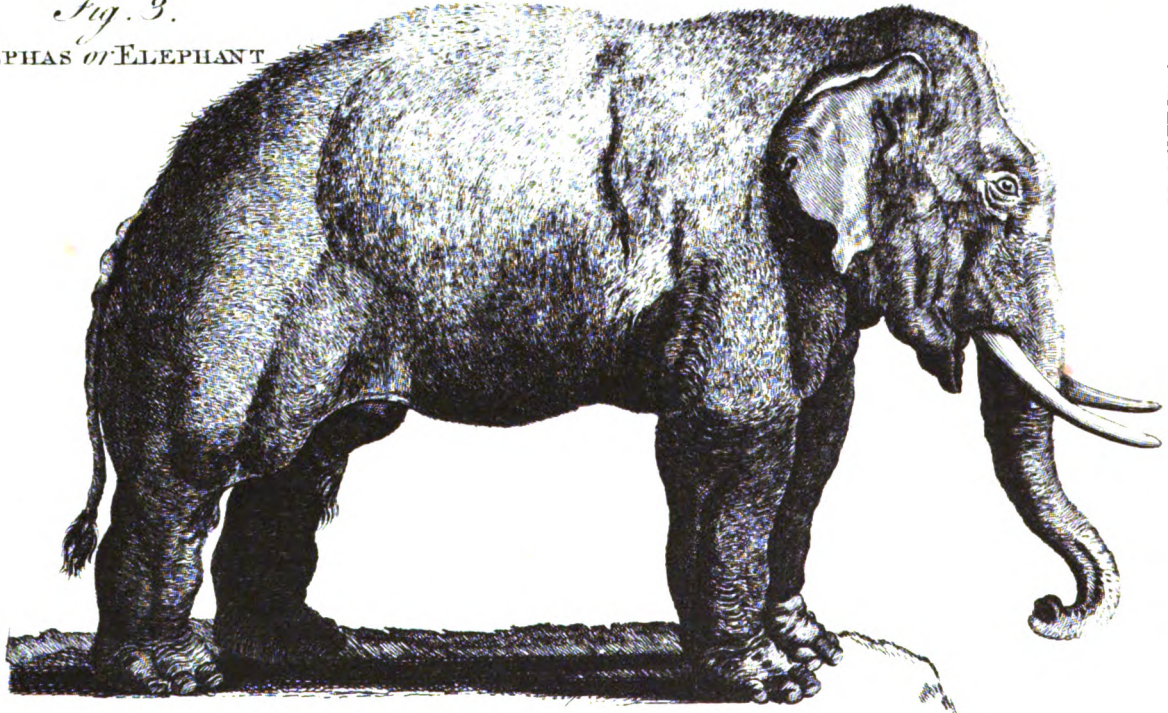
*Fig. 1.*  
WATSON'S  
ELECTRICAL  
MACHINE



*Fig. 2.*  
CLOUD  
MACHINE



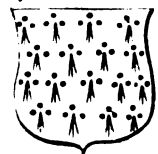
*Fig. 3.*  
ELEPHAS or ELEPHANT



*Fig. 5.* ELATER



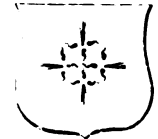
*Fig. 7.* ERMIN



*Fig. 4.* ECHENEIS



*Fig. 8.* ERMINE



*Fig. 6.* ERINACEUS or HEDGEHOG



TO 477

is made to come quite through the pillar, that it may be turned by another handle without the wheel, if the operator chuses. The frame, being screwed to the table, may be placed nearer to, or farther from, the wheel, as the length of the string requires in different states of the weather. The WHEEL is fixed in a frame by itself *e*, by which it may have any situation with respect to the pulley, and be turned to one side, so as to prevent the string from cutting itself.

The RUBBER (*f*) consists of a hollow piece of copper, filled with horse-hair, and covered with a bازل-skin. It is supported by a socket, which receives the cylindrical axis, of a round and flat piece of baked wood *g*, the opposite part of which is inserted into the socket of a bent steel-spring *b*. These parts are easily separated; so that the rubber, or piece of wood that serves to insulate it, may be changed at pleasure. The spring may be either slipped along the groove, or moved in the contrary direction, so as to give it every desirable position with respect to the globe. It is besides furnished with a screw *i*, which makes it press harder or lighter on the globe, as the operator chuses.

The PRIME CONDUCTOR (*k*) is a hollow vessel of polished copper in the form of a pear, supported by a pillar and a firm basis of baked wood; and it receives the electrical matter by means of a long arched wire or rod of very soft brass *l*, easily bent into any shape, and raised higher or lower as the globe requires. It is terminated by an open ring, in which are hung some sharp-pointed wires *m*, playing lightly on the globe when it is in motion. The body of the conductor is furnished with holes and sockets for the insertion of metallic rods to convey the fire where-ever it is wanted.

When positive electricity is required, a wire or chain, as represented in the plate (*n*), connects the rubber with the table or the floor. When negative electricity is wanted, that wire is connected with another conductor, such as that represented, in fig. 1. *t*; where the conductor in fig. 2. is connected with the table by another wire or chain. If the rubber be made tolerably free from points, the negative power will be as strong as the positive.

The machine, represented Plate LXXV. fig. 1. was a contrivance of Dr Watson's, to whirl four large globes at a time, and unite the power of them all. The construction is so simple, that we need not give any particular description of it, especially after having so fully described that of Dr Priestley.

*Of positive and negative Electricity, and the Leyden Phial.*

DR WATSON and Dr Franklin first suggested the notion of *positive* and *negative*, or *plus* and *minus* electricity: several experiments led them to conclude, that every body in nature, and particularly all conducting bodies, possessed a certain quantity of electric matter, and that this natural quantity might be augmented or diminished by being placed in particular circumstances. When a body receives a larger quantity than the natural one, it is said to be electrified *plus*, or *positively*; when the natural quantity is diminished, it is said to be electrified *mi-*

*nus*, or *negatively*. The following experiments will shew the different circumstances requisite to produce these two kinds of electricity.

1. A person standing on wax, and rubbing the tube, and another person on wax drawing the fire, they will both appear to be electrified by a person standing on the floor; that is, he will perceive a spark on approaching each of them with his knuckle.

2. But, if the persons on wax touch one another during the exciting of the tube, neither of them will appear to be electrified.

3. If they touch one another after exciting the tube, and drawing the fire as before, there will be a stronger spark between them, than happens between either of them and the person on the floor.

4. After such strong spark, neither of them discover any electricity.

These appearances are explained in the following manner: the electrical fire is supposed to be a common element, of which each of the three persons above-mentioned has his equal share, before any operation is begun with the tube. A, who stands on wax and rubs the tube, collects the electrical fire from himself into the glass; and his communication with all conductors being cut off by the wax, his body is not again immediately supplied. B, who stands likewise on wax, passing his knuckle along near the tube, receives the fire which was collected by the glass from A; and his communication with conductors, or the common stock of electrical matter, being likewise cut off, he retains the additional quantity received. To C, standing on the floor, both appear to be electrified: for he having only the middle quantity of electrical fire, receives a spark upon approaching B who has an over quantity, but gives one to A who has an under quantity. If A and B approach to touch each other, the spark is stronger, because the distance betwixt them is greater: after such touch, there is no spark between either of them and C, because the electrical fire in all is reduced to the original equality. If they touch while electrifying, the equality is never destroyed, the fire only circulating. Hence we say, B is electrified *positively*, A *negatively*; or rather B is electrified *plus*, A *minus*: and in experimenting, it is common to electrify bodies *plus* or *minus* at pleasure. To electrify *plus* or *minus*, it is sufficient to know, that the parts of the tube or sphere that are rubbed, do, in the instant of the friction, attract the electrical fire, and therefore take it from the thing rubbing: the same parts immediately, as the friction upon them ceases, are disposed to give the fire they have received to any body that has less. Thus you may circulate it or accumulate it upon, or subtract it from any body, as you connect that body with the rubber, or the receiver, the communication in the common stock being cut off.

The great shock from what is called the LEYDEN PHIAL, was first discovered by Mr CUNRUS, a native of Leyden; but was never so thoroughly understood till Dr Franklin published his experiments with regard to it. A glass phial or jar, filled, till within an inch of the top, with water, brals dust, or other non conducting substances, was first used; but coating the vessel with tin foil,

or brags-dust, as mentioned above in the section concerning the electrical apparatus, was found to answer better.

We shall here give Dr Franklin's account of this phial nearly in his own words, together with the experiments confirming it.

1. While the wire and inside of the bottle are electrified *positively* or *plus*, the outside of the bottle is electrified *negatively* or *minus*, in exact proportion; *i. e.* whatever quantity of electrical fire is thrown into the inside, an equal quantity goes out of the outside. To understand this, suppose the natural quantity of electricity in the whole bottle, before the operation begins, is equal to 20; and, at every stroke of the tube, or turn of the globe, suppose a quantity equal to 1 is thrown in; then, after the first stroke, the quantity contained in the wire and inside of the bottle will be 21, and in the outside 19; after the second stroke, the inside will have 22, and the outside 18; and so on, till, after 20 strokes, the inside will have a quantity of electrical fire equal to 40, and the outside none at all; and then the operation ends: for no more can be thrown into the inside, when no more can be driven out of the outside. If more is attempted to be thrown in, it is spued back through the wire, or flies out in loud cracks through the sides of the bottle.

2. The equilibrium of electric matter in the bottle being thus lost, it cannot be restored by any *inward* communication or contact of the parts: but this must be done by a communication formed *without* the bottle between the inside and the outside, by some conductor touching or approaching both sides at the same time; in which case the equilibrium is restored with an inexpressible violence and quickness: or, it may be done by touching each side alternately; in which case, the equilibrium is restored by degrees.

3. As no more electrical fire can be thrown into the inside of the bottle, when all is driven from the outside; so, in a bottle not yet electrified, none can be thrown into the inside, when none can get out at the outside; which happens, either when the glass is too thick or when the bottle is placed in a non-conductor. Again, when the bottle is electrified, but little of the electrical fire can be drawn out from the inside by touching the wire, unless an equal quantity can, at the same time, get in at the outside. Thus, place an electrified bottle on clean glass, or dry wax, and you will not, by touching the wire, get out the fire from the inside: place it on a conductor, and touch the wire, then you will get it out in a short time; but soonest when you form a direct communication as above.

4. The shock to the nerves, or rather convulsion, is occasioned by the sudden passage of the fire through the body, in its way from the inside to the outside of the bottle. The fire takes the shortest course; but it does not appear, that, in order to receive a shock, a communication with the floor is necessary; for he that holds the bottle with one hand, and touches the wire with the other, will be shocked as much, though his shoes be dry, or even standing on wax. And on the touch of the wire (or of the prime conductor, which is the same thing,) the fire does not proceed from the touching finger to the wire, but from the wire to the finger, and passes

through the body to the other hand, and so into the outside of the bottle.

The following experiments will confirm this account of the Leyden phial.

1. Place an electrified phial on wax; a small cork-ball held in your hand, suspended by a dry silk thread, and brought near to the wire, will first be attracted and then repelled: When in a repelled state, sink your hand, that the ball may be brought towards the outside of the bottle; it will be instantly attracted till it has parted with its fire.

If the outside of the bottle had a positive electrical atmosphere, as well as the inside and the wire, an electrified cork would be repelled from the one as well as the other.

2. From a bent wire sticking in the table, let a small linen thread hang down within half an inch of the electrified phial; touch the wire of the phial repeatedly with your finger; and, at every touch, you will see the thread instantly attracted by the outside of the bottle. As soon as you draw any fire from the inside by touching the wire, the outside draws in an equal quantity by the thread.

3. Fix a wire in the outside coating of the bottle, so as that bending upwards its ring-end may be level with the top or ring-end of the wire in the cork of the bottle, and at three or four inches distance. Then electrify the bottle, and place it on wax. If a cork, suspended by a silk thread, hang between these two wires, it will play incessantly from the one to the other, till the equilibrium between the inside and the outside of the bottle is restored.

4. Place a man on a cake of wax, and present him the wire of the electrified phial to touch, you standing on the floor and holding it in your hand. As often as he touches it, he will be electrified *plus*; and any one standing on the floor may draw a spark from him. The fire, in this experiment, passes out of the wire into him; and, at the same time, out of your hand into the outside of the bottle. Give him the electrical phial to hold, and touch the wire; as often as you touch it, he will be electrified *minus*, and may draw a spark from any one standing in the floor. The fire in this case passes from the wire to you, and from him into the outside of the bottle.

5. Lay two books, or two glasses, back to back, two two or three inches distant, place the electrified phial; on one of them, and then touch the wire; that book will be electrified *minus*, the electrical fire being drawn out of it by the outside of the bottle. Take off the bottle, and, holding it in your hand, touch the other with the wire; that book will be electrified *plus*, the fire passing into it from the wire, and the outside of the bottle is at the same time supplied from your hand.

The same explosion and shock happens, if the electrified phial is held in one hand by the hook of the wire, and the coating touched with the other, as when held by the coating and touched at the hook. To take the charged phial safely by the hook, and not at the same time diminish its force; it must first be set down on a non-conductor. The phial will be electrified as strongly, if held by the hook, and the coating applied to the globe or tube,

tube, as when held by the coating and the hook applied: but the *direction* of the electrical fire, being different in the charging, will also be different in the explosion; the bottle charged through the hook will be discharged thro' the hook; the bottle charged thro' the coating will be discharged thro' the coating; because the fire must come out the same way it went in.

6. To prove this, take two bottles that were equally charged thro' the hooks, one in each hand; bring their hooks near each other, and no spark or shock will follow; because each hook is disposed to give fire, and neither to receive it. Set one of the bottles on glass, take it up by the hook, and apply its coating to the hook of the other; then there will be an explosion and shock, and both bottles will be discharged. [*N B.* To charge a bottle commodiously thro' the coating; place it on a glass stand; form a communication from the prime conductor to the coating, and another from the hook to the wall or floor; when it is charged, remove the latter communication before you take hold of the bottle, otherwise great part of the fire will escape by it.]

When the terms of *charging* or *discharging* the phial are used, it is in compliance with custom, and for want of better ones; since there is really no *more* electrical fire in the phial after what is called its *charging* than before, nor *less* after its *discharging*. Besides, the phial will not suffer what is called a *charging*, unless as much fire can go out of it one way as is thrown in by another. A phial cannot be charged standing on wax or glass, or hanging on the prime conductor, unless a communication be formed between its coating and the floor. But suspend two or more phials on the prime conductor, one hanging to the tail of the other, and a wire from the last to the floor, an equal number of turns of the wheel will charge them all equally, and each as strongly as a single one would have been.

When a bottle is charged in the common way, its *inside* and *outside* surfaces stand ready, the one to give fire by the hook, the other to receive it by the coating: yet as the first will not give out, unless the other can at the same instant receive in; so neither will the latter receive in, unless the first can at the same instant give out. When both can be done at once, it is done with inconceivable quickness and violence.

Glass has within its substance the same quantity of electrical fire at all times, and that quantity is very great in proportion to the mass of glass. This quantity it obstinately retains; and will have neither more nor less, though it will allow a change to be made in its parts and situation; that is, we may take away part from one of the sides, provided we throw an equal quantity into the other. Yet when the situation of the electrical fire is thus altered in the glass, it will not be at rest, or in its natural state, till it be restored to its original equality; and this restitution cannot be made through the substance of the glass, but must be done by a conducting communication formed without from surface to surface. Thus the whole force of the bottle, and power of giving a shock, resides in the GLASS itself; the coatings, or conducting substances in contact with the two surfaces, ser-

ving only to give and receive to and from the several parts of the glass; that is, to give in one side, and take away from the other. This was discovered by Dr Franklin, and proved by the following experiment: ' Purposing, (says he,) to analyze the electrified bottle, in order to find wherein its strength lay, we placed it on glass; and drew out the cork and wire, which for that purpose had been loosely put in. Then taking the bottle in one hand, and bringing a finger of the other near its mouth, a strong spark came from the water, and the shock was as violent as if the wire had remained in it, which shewed that the force did not lie in the wire. Then to find if it resided in the water, being crowded into and condensed in it, as confined by the glass, which had been our former opinion, we electrified the bottle again, and placing it on glass drew out the wire and cork as before; then taking up the bottle, we decanted all its water into an empty bottle, which likewise stood on glass; and taking up that other bottle, we expected, if the force resided in the water, to find a shock from it; but there was none. We judged then that it must either be lost in decanting, or remain in the first bottle. The latter we found to be true; for that bottle on trial gave the shock, though filled up as it stood with fresh un-electrified water from a tea-pot — To find, then, whether glass had this property merely as glass, or whether the form contributed any thing to it; we took a pane of sash-glass, and laying it on the hand, placed a plate of lead on its upper surface; then electrified that plate, and bringing a finger to it, there was a spark and shock. We then took two plates of lead of equal dimensions, but less than the glass by two inches every way, and electrified the glass between them, by electrifying the uppermost lead; then separated the glass from the lead; in doing which, what little fire might be in the lead was taken out, and the glass being touched in the electrified parts with a finger, afforded only very small pricking sparks, but a great number of them might be taken from different places. Then dexterously placing it again between the leaden plates, and completing a circle between the two surfaces, a violent shock ensued. — Which demonstrated the power to reside in glass as glass; and that the non-electrics in contact served only, like the armature of a loadstone, to unite the force of the several parts, and bring them at once to any point desired: it being the property of a non-electric, that the whole body instantly receives or gives what electrical fire is given to or taken from any one of its parts. —

' It is amazing to observe in how small a portion of glass a great electrical force may lie. A thin glass bubble about an inch diameter, weighing only six grains, being half filled with water, partly gilt on the outside, and furnished with a wire hook, gives, when electrified, as great a shock as a man can well bear. As the glass is thickest near the orifice, I suppose the lower half, which being gilt was electrified and gave the shock, did not exceed two grains; for it appeared, when broke, much thinner than the upper half. — If one of these thin bottles be electrified by the coating, and the spark taken

' taken out through the gilding, it will break the glass inwards, at the same time that it breaks the gilding outwards. And since there is no more electrical fire in a bottle after charging than before, how great must be the quantity in this small portion of glass! It seems as if it were of its very substance and essence. Perhaps if that due quantity of electrical fire so obstinately retained by glasses, could be separated from it, it would no longer be glass; it might lose its transparency, or its brittleness, or its elasticity.—Experiments may possibly be invented hereafter to discover this.'

*Of the Similarity between Lightning and Electricity.*

1. Flashes of lightning are generally seen crooked, and waving in the air. The electric spark has always the same direction when it is drawn from an irregular body at some distance, or through a space in which the best conductors are disposed in an irregular manner, which is always the case in the heterogeneous atmosphere of our globe.

2. Lightning strikes the highest and most pointed objects in its way preferable to others, as high hills, and trees, towers, spires, masts of ships, points of spears, &c. In like manner, all pointed conductors receive or throw off the electric fluid more readily than those which are terminated by flat surfaces.

3. Lightning is observed to take the readiest and best conductor. So does electricity in the discharge of the Leyden phial. For this reason, it would be safer, during a thunder-storm, to have one's cloaths wet than dry, as the lightning might then, in a great measure, be transmitted to the ground, by the water, on the outside of the body. It is found, that a wet rat cannot be killed by the explosion of the electrical bottle, but that a dry rat may.

4. Lightning burns. So does electricity. It will kindle hard dry rosin, spirits unwarmed, and even wood. It will fire gunpowder, by only ramming it hard in a cartridge, into each end of which pointed wires are introduced, and brought within half an inch of one another, and discharging a shock through them.

5. Lightning sometimes dissolves metals. So does electricity. The method in which Dr Franklin made electricity melt metals, was by putting thin pieces of them between two panes of glass, bound fast together, and sending an electric shock through them. Sometimes the pieces of glass, by which they were confined, would be shattered to pieces by the discharge, and be broken into a kind of coarse sand, which once happened with pieces of thick looking-glass; but if they remained whole, the pieces of metal would be missing in several places where it had lain between them, and instead of it a metallic stain would be seen on both the glasses, the stains on the under and upper glass being exactly similar in the minutest stroke.

6. Lightning rends some bodies. So does electricity. The electric spark will strike a hole through a quire of paper.—When wood, bricks, stone, &c. are rent by lightning, the splinters will fly off on that side where

there is the least resistance. In like manner, when a hole is struck through a piece of pasteboard by an electrified jar, if the surfaces of the pasteboard are not confined and compressed, there will be a bur raised all round the hole on both sides of the pasteboard; but if one side be confined, so that the bur cannot be raised on that side, it will all be raised on the other side, which way soever the fluid was directed. For the bur round the outside of the hole is the effect of the explosion, which is made every way from the center of the electric stream, and not an effect of its direction.

7. Lightning has often been known to strike people blind. And a pigeon, after a violent shock of electricity, by which it was intended to be killed, was struck blind likewise.

8. In a thunder-storm at Stretham, described by Dr Miles, the lightning stripped off some paint which had covered a gilded moulding of a pannel of wainscot, without hurting the rest of the paint. Dr Franklin imitated this, by passing a slip of paper over the filleting of gold on the cover of a book, and sending an electric flash through it. The paper was torn off from end to end, with such force, that it was broken in several places; and in others there was brought away part of the grain of the Turkey leather in which the book was bound. This convinced the doctor, that if it had been paint, it would have been stripped off in the same manner with that on the wainscot at Stretham.

9. Lightning destroys animal-life. Animals have likewise been killed by the shock of electricity. The largest animals which Dr Franklin and his friends had been able to kill were a hen, and a turkey which weighed about ten pounds.

10. Magnets have been observed to lose their virtue, or to have their poles reversed, by lightning. Dr Franklin did the same by electricity. By electricity he frequently gave polarity to needles, and reversed them at pleasure. A shock from four large jars, sent through a fine sewing needle, gave it polarity, so that it would traverse when laid on water. What is most remarkable in these electrical experiments upon magnets is, that if the needle, when it was struck, lay east and west, the end which was entered by the electric blast pointed north; but that if it lay north and south, the end which lay towards the north would continue to point north, whether the fire entered at that end or the contrary. He also observed, that the polarity was strongest when the needle was struck lying north and south, and weakest when it lay east and west. He takes notice, that, in these experiments, the needle, in some cases, would be finely blued, like the spring of a watch, by the electric flame; in which case the colour given by a flash from two jars only might be wiped off, but that a flash from four jars fixed it, and frequently melted the needles. The jars which the doctor used held seven or eight gallons, and were coated and lined with tinfoil.

To demonstrate, in the completest manner possible, the sameness of the electric fluid with the matter of lightning, Dr Franklin contrived to bring lightning from the heavens, by means of an electrical kite, which he raised when a storm of thunder was perceived to be coming on. This kite



kite had a pointed wire fixed upon it, by which it drew the lightning from the clouds. This lightning descended by the hempen string, and was received by a key tied to the extremity of it; that part of the string which was held in the hand being of silk, that the electric virtue might stop when it came to the key. He found that the string would conduct electricity even when nearly dry, but that when it was wet it would conduct it quite freely; so that it would stream out plentifully from the key at the approach of a person's finger.

At this key he charged phials, and from electric fire thus obtained he kindled spirits, and performed all other electrical experiments which are usually exhibited by an excited globe or tube.

The first appearance of a thunder-storm (which generally happens when there is little or no wind) is one dense cloud, or more, increasing very fast in size, and rising into the higher regions of the air. The lower surface is black, and nearly level; but the upper finely arched, and well defined. Many of these clouds often seem piled one upon another, all arched in the same manner; but they keep continually uniting, swelling, and extending their arches.

At the time of the rising of this cloud, the atmosphere is generally full of a great number of separate clouds, motionless, and of odd and whimsical shapes. All these, upon the appearance of the thunder-cloud, draw towards it, and become more uniform in their shapes as they approach; till, coming very near the thunder-cloud, their limbs mutually stretch towards one another; they immediately coalesce, and together make one uniform mass. These are called *adscitious* clouds, from their coming in, to enlarge the size of the thunder-cloud. But, sometimes the thunder-cloud will swell, and increase very fast without the conjunction of any adscitious clouds, the vapours in the atmosphere forming themselves into clouds where-ever it passes. Some of the adscitious clouds appear like white fringes, at the skirts of the thunder-cloud, or under the body of it; but they keep continually growing darker and darker, as they approach to unite with it.

When the thunder-cloud is grown to a great size, its lower surface is often ragged, particular parts being detached towards the earth, but still connected with the rest. Sometimes the lower surface swells into various large protuberances, bending uniformly towards the earth. And sometimes one whole side of the cloud will have an inclination to the earth and the extremity of it will nearly touch the earth. When the eye is under the thunder-cloud, after it is grown large, and well formed, it is seen to sink lower, and to darken prodigiously; at the same time that a number of small adscitious clouds (the origin of which can never be perceived) are seen in a rapid motion, driving about in very uncertain directions under it. While these clouds are agitated with the most rapid motions, the rain generally falls in the greatest plenty; and if the agitation be exceeding great, it commonly hails.

When the thunder-cloud is swelling, and extending its branches over a large tract of country, the lightning is seen to dart from one part of it to another, and often

to illuminate its whole mass. When the cloud has acquired a sufficient extent, the lightning strikes between the cloud and the earth, in two opposite places, the path of the lightning lying through the whole body of the cloud and its branches. The longer this lightning continues, the rarer does the cloud grow, and the less dark is its appearance; till, at length, it breaks in different places, and shows a clear sky. When the thunder-cloud is thus dispersed, those parts which occupy the upper regions of the atmosphere are equally spread, and very thin; and those that are underneath are black, but thin too; and they vanish gradually, without being driven away with any wind.

That thunder-clouds were sometimes in a positive as well as negative state of electricity, Signior Beccaria had discovered, before he heard of its having been observed by Dr Franklin or any other person. The same cloud, in passing over his observatory, electrified his apparatus sometimes positively, and sometimes negatively. The electricity continued longer of the same kind, in proportion as the thunder-cloud was simple, and uniform in its direction; but when the lightning changed its place, there commonly happened a change in the electricity of his apparatus. It would change suddenly after a very violent flash of lightning, but the change would be gradual when the lightning was moderate, and the progress of the thunder-cloud slow.

It was an immediate inference from his observations of the lightning abroad, and his apparatus within, that the quantity of electric matter, in an usual storm of thunder, is almost inconceivably great; considering how many pointed bodies, as trees, spires, &c. are perpetually drawing it off, and what a prodigious quantity is repeatedly discharged to or from the earth.

Considering the vast quantity of electric fire that appears in the most simple thunder-storms, he thinks it impossible that any cloud, or number of clouds, should ever contain it all, so as either to discharge or receive it. Besides, during the progress and increase of the storm, though the lightning frequently struck to the earth, the same clouds were the next moment ready to make a still greater discharge, and his apparatus continued to be as much affected as ever. The clouds must, consequently, have received at one place, the moment that a discharge was made from them in another. In many cases, the electricity of his apparatus, and consequently of the clouds, would instantly change from one kind to another several times; an effect which cannot be accounted for by any simple discharge or recruit. Both must have taken place in a very quick succession.

The extent of the clouds doth not lessen this difficulty: for, be it ever so great, still the quantity ought to be lessened by every discharge: and besides, the points by which the silent discharges are made are in proportion to the extent of the clouds. Nor is the difficulty lessened by supposing that fresh clouds bring recruits; for besides that the clouds are not ripe for the principal storm, till all the clouds, to a great distance, have actually coalesced, and formed one uniform mass, those recruits bear no sort of proportion to the discharge, and whatever it was, it would soon be exhausted.

The fact, therefore, must be, that the electric matter is continually darting from the clouds in one place, at the same time that it is discharged from the earth in another. And it is a necessary consequence from the whole, that the clouds serve as conductors to convey the electric fluid from those places of the earth which are overloaded with it, to those which are exhausted of it.

That great quantities of electric matter do sometimes rush out of particular parts of the earth, and rise through the air into the higher regions of the atmosphere, he thinks is evident from the great quantities of sand, ashes, and other light substances, which have often been carried up into the air, and scattered uniformly over a large tract of country. No other known efficient cause of this phenomenon can be assigned, except the wind; and it has been observed when there was no wind stirring; and the light bodies have even been carried against the wind. He supposes, therefore, that these light bodies are raised by a large quantity of electric matter, issuing out of the earth, where it was overcharged with it, and attracting and carrying with it every substance that could serve as a conductor in its passage. All these bodies, being possessed of an equal quantity of the electric fluid, will be dispersed equally in the air, and consequently over that part of the earth where the fluid was wanting, and whither they serve to convey it. Had these bodies been raised by the wind, they would have been dispersed at random, and in heaps.

This comparatively rare phenomenon, he thinks, exhibits both a perfect image, and demonstration, of the manner in which the vapours of the atmosphere are raised to form thunder-clouds. The same electric matter, wherever it issues, attracts to it, and carries up into the higher regions of the air, the watery particles that are dispersed in the atmosphere. The electric matter ascends to the higher regions of the atmosphere, being solicited by the less resistance it finds there than in the common mass of the earth; which, at those times, is generally very dry, and consequently highly electric. The uniformity with which thunder-clouds spread themselves, and swell into arches, must be owing to their being affected by some cause which, like the electric matter, diffuses itself uniformly where-ever it acts, and to the resistance they meet with in ascending through the air. As a proof of this, steam, rising from an electrified eolipile, diffuses itself with the same uniformity, and in similar arches, extending itself towards any conducting substance.

The same cause which first raised a cloud, from vapours dispersed in the atmosphere, draws it to those that are already formed, and continues to form new ones; till the whole collected mass extends so far, as to reach a part of the earth where there is a deficiency of the electric fluid. Thither too, will those clouds, replete with electricity, be strongly attracted, and there will the electric matter discharge itself upon the earth. A channel of communication being, in this manner, found, a fresh supply of electric matter will be raised from the overloaded part, and will continue to be conveyed by the medium of the clouds, till the equilibrium of the fluid, between the two places of the earth be restored. When

the clouds are attracted in their passage by those parts of the earth where there is a deficiency of the fluid, those detached fragments are formed, and also those uniform depending protuberances, which, in some cases, are the cause of water-spouts, and hurricanes.

That the electric matter, which forms and animates the thunder-clouds, issues from places far below the surface of the earth; and that it buries itself there, is probable from the deep holes that have, in many places, been made by lightning. Flashes of lightning have, also, been seen to arise from subterraneous cavities, and from wells. Violent inundations have accompanied thunder-storms, not occasioned by rain, but by water bursting from the bowels of the earth, from which it must have been dislodged by some internal concussion. Deep wells have been known to fill faster in thunder-storms, and others have constantly grown turbid at the approach of thunder.

This very rise, as well as the whole progress of thunder-clouds, has sometimes been in a manner visible. Exhalations have been frequently seen to rise from particular caverns, attended with a rumbling noise, and to ascend into the higher regions of the air, with all the phenomena of thunder-storms described above, according to the description of persons who lived long before the connection between electricity and lightning was suspected.

The greatest difficulty attending this theory of the origin of thunder-storms relates to the collection and insulation of electric matter within the body of the earth. With respect to the former, he has nothing particular to say. Some operations in nature are certainly attended with a loss of the equilibrium in the electric fluid, but no person has yet assigned a more probable cause of the redundancy of electric matter which, in fact, often abounds in the clouds, than what we may suppose possible to take place in the bowels of the earth. And supposing the loss of the equilibrium possible, the same cause that produced the effect would prevent the restoring of it; so that not being able to force a way, at least one sufficiently ready, through the body of the earth, it would issue at the most convenient vent into the higher regions of the air, as the better passage. His electrical apparatus, though communicating with the earth, has frequently, in violent thunder-storms, given evident sparks to his finger.

In the enumeration of the effects of thunder-storms, he observes that a wind always blows from the place from which the thunder-cloud proceeds; that this is agreeable to the observations of all mariners, and that the wind is more or less violent in proportion to the suddenness of the appearance of the thunder-cloud, the rapidity of its expansion, and the velocity with which the adscititious clouds join it. The sudden condensation of such a prodigious quantity of vapours must displace the air, and repel it on all sides.

He, in some measure, imitated even this effect of thunder, at least produced a circulation of all the air in his room, by the continued electrification of his chain.

Among other effects of lightning, he mentions the case of a man rendered exceeding stiff, presently after he was struck dead in a storm of thunder. But the most remarkable circumstance, in this case, was the lightning (chuse

ing the best conductor) having struck one particular vein, near his neck, and followed it through its minutest ramifications; so that the figure of it appeared through the skin, finer than any pencil could have drawn it.

He cautions persons not to depend upon the neighbourhood of a higher, or, in all cases, a better conductor than their own body; since, according to his repeated observations, the lightning by no means descends in one undivided track, but bodies of various kinds conduct their share of it, at the same time, in proportion to their quantity and conducting power.

A great number of observations, relating to the descent of lightning, confirm his theory of the manner of its ascent: for, in many cases, it throws before it the parts of conducting bodies, and distributes them along the resisting medium through which it must force its passage.

Upon this principle it is, that the longest flashes of lightning seem to be made by its forcing into its way part of the vapours in the air. One of the principal reasons why those flashes make so long a rumbling, is their being occasioned by the vast length of a vacuum, made by the passage of the electric matter. For though the air collapses the moment after it has passed, and the vibration (on which the sound depends) commences at the same moment, through the whole length of the track; yet, if the flash was directed towards the person who hears the report, the vibrations excited at the nearer end of the track will reach his ear much sooner than those excited at the more remote end; and the sound will, without any repercussion or echo, continue till all the vibrations have successively reached him.

He thinks that the Aurora Borealis may be this electric matter performing its circulation, in such a state of the atmosphere as renders it visible, or approaching nearer to the earth than usual.

Stones and bricks struck by lightning are often vitrified. He supposes that some stones in the earth having been struck in this manner first gave occasion to the vulgar opinion of the thunder-bolt.

Signior Beccaria was very sensible that heat contributes much to the phenomena of thunder, lightning, and rain; but he could not find, by any experiment, that it tended to promote electricity. He therefore rather thought that heat operated, in this case, by exhaling the moisture of the air, and thereby cutting off the communication of the electric fluid between one place and another, particularly between the earth and the higher regions of the air, whereby its effects were more visible.

*Method of securing buildings and persons from the effects of lightning.*

EXPERIMENTS made in electricity first gave philosophers a suspicion that the matter of lightning was the same with the electric matter. Experiments afterwards made on lightning obtained from the clouds by pointed rods, received into bottles, and subjected to every trial, have since proved this suspicion to be perfectly well founded; and that whatever properties we find in electricity, are also the properties of lightning.

This matter of lightning, or of electricity, is an extreme subtle fluid, penetrating other bodies, and subtilizing in them equally diffused.

When by any operation of art or nature, there happens to be a greater proportion of this fluid in one body than in another, the body which has most, will communicate to that which has least, till the proportion becomes equal; provided the distance between them be not too great; or, if it is too great, till there be proper conductors to convey it from one to the other.

If the communication be through the air without any conductor, a bright light is seen between the bodies, and a sound is heard. In our small experiments we call this light and sound the electric spark and snap; but in the great operations of nature, the light is what we call *lightning*, and the sound (produced at the same time, though generally arriving later at our ears than the light does to our eyes) is, with its echoes, called *thunder*.

If the communication of this fluid is by a conductor, it may be without either light or sound, the subtle fluid passing in the substance of the conductor.

If the conductor be good and of sufficient bigness, the fluid passes through it without hurting it. If otherwise, it is damaged or destroyed.

All metals, and water, are good conductors.—Other bodies may become conductors by having some quantity of water in them, as wood, and other materials used in building, but not having much water in them, they are not good conductors, and therefore are often damaged in the operation by lightning.

Glass, wax, silk, wool, hair, feathers, and even wood, perfectly dry, are non-conductors: that is, they resist instead of facilitating the passage of this subtle fluid.

When this fluid has an opportunity of passing through two conductors, one good and sufficient, as of metal, the other not so good, it passes in the best, and will follow it in any direction.

The distance at which a body charged with this fluid will discharge itself suddenly, striking through the air into another body that is not charged, or not so highly charged, is different according to the quantity of the fluid, the dimensions and form of the bodies themselves, and the state of the air between them.—This distance, whatever it happens to be between any two bodies, is called their *striking distance*, as till they come within that distance of each other, no stroke will be made.

The clouds have often more of this fluid in proportion than the earth; in which case as soon as they come near enough (that is, within the striking distance) or meet with a conductor, the fluid quits them and strikes into the earth. A cloud fully charged with this fluid, if so high as to be beyond the striking distance from the earth, passes quietly without making any noise or giving light; unless it meets with other clouds that have less.

Tall trees, and lofty buildings, as the towers and spires of churches, become sometimes conductors between the clouds and the earth; but not being good ones, that is, nor conveying the fluid freely, they are often damaged.

Buildings that have their roofs covered with lead, or other metal, and spouts of metal continued from the roof into

in to the ground to carry off the water, are never hurt by lightning, as whenever it falls on such a building, it passes in the metals and not in the walls.

When other buildings happen to be within the striking distance from such clouds, the fluid passes in the walls, whether of wood, brick or stone, quitting the walls only when it can find better conductors near them, as metal rods, bolts, and hinges of windows or doors, gilding on wainscot, or frames of pictures; the silvering on the backs of looking-glasses; the wires for bells; and the bodies of animals, as containing watry fluids. And in passing thro' the house it follows the direction of these conductors, taking as many in its way as can assist it in its passage, whether in a strait or crooked line, leaping from one to the other, if not far distant from each other, only rending the wall in the spaces where these partial good conductors are too distant from each other.

An iron rod being placed on the outside of a building, from the highest part continued down into the moist earth, in any direction strait or crooked, following the form of the roof or other parts of the building, will receive the lightning at its upper end, attracting it so as to prevent its striking any other part; and, affording it a good conveyance into the earth, will prevent its damaging any part of the building.

A small quantity of metal is found able to conduct a great quantity of this fluid. A wire no bigger than a goose quill has been known to conduct (with safety to the building as far as the wire was continued) a quantity of lightning that did prodigious damage both above and below it; and probably larger rods are not necessary, tho' it is common to make them of half an inch, some of three quarters, or an inch diameter.

The rod may be fastened to the wall, chimney, &c. with staples of iron.—The lightning will not leave the rod (a good conductor) to pass into the wall (a bad conductor) through those staples.—It would rather, if any were in the wall, pass out of it into the rod to get more readily by that conductor into the earth.

If the building be very large and extensive, two or more rods may be placed at different parts, for greater security.

Small ragged parts of clouds suspended in the air between the great body of clouds and the earth (like leaf-gold in electrical experiments), often serve as partial conductors for the lightning, which proceeds from one of them to another, and by their help comes within the striking distance to the earth or a building. It therefore strikes through those conductors a building that would otherwise be out of the striking distance.

Long sharp points communicating with the earth, and presented to such parts of clouds, drawing silently from them the fluid they are charged with, they are then attracted to the cloud, and may leave the distance so great as to be beyond the reach of striking.

It is therefore that we elevate the upper end of the rod six or eight feet above the highest part of the building, tapering it gradually to a fine sharp point, which is gilt to prevent its rusting.

Thus the pointed rod either prevents a stroke from the

cloud, or, if a stroke is made, conducts it to the earth with safety to the building.

The lower end of the rod should enter the earth so deep as to come at the moist part, perhaps two or three feet; and if bent when under the surface so as to go in a horizontal line six or eight feet from the wall, and then bent again downwards three or four feet, it will prevent damage to any of the stones of the foundation.

A person apprehensive of danger from lightning, happening during the time of thunder to be in a house not so secured, will do well to avoid sitting near the chimney, near a looking-glass, or any gilt pictures or wainscot; the safest place is in the middle of the room, (so it be not under a metal lustre suspended by a chain), sitting in one chair and laying the feet up in another. It is still safer to bring two or three mattresses or beds into the middle of the room, and folding them up double, place the chair upon them; for they not being so good conductors as the walls, the lightning will not chuse an interrupted course through the air of the room and the bedding, when it can go thro' a continued better conductor, the wall. But where it can be had, a hammock or swinging bed, suspended by silk cords equally distant from the walls on every side, and from the ceiling and floor above and below, affords the safest situation a person can have in any room whatever; and what indeed may be deemed quite free from danger of any stroke by lightning.

In order to secure ships from sustaining damage by lightning, a copper rod, about the thickness of a goose quill, should be connected with the spindles and iron work of the masts continued down to the deck, and from thence, in the most convenient direction, till the end of the rod be always in contact with the sea-water.

With regard to powder-mills and magazines, the apparatus to conduct the lightning from them should be detached from the buildings themselves, and conveyed to the nearest water.

#### *Of Medical Electricity.*

THE first application of electricity to the cure of diseases was made by M. Jallabert, professor of philosophy at Geneva, on a locksmith whose right arm had been paralytic fifteen years. He was brought to M. Jallabert on the 26th of December 1747, and was completely cured by the 28th of February 1748. In this interval he was frequently electrified, sparks being taken from the arm, and sometimes the electrical shock sent through it.

The report of this cure at Geneva, engaged Mr Sauvages of the academy in Montpellier to attempt the cure of paralytics, in which he had considerable success.

In the year 1757, Mr Patrick Bryden, in a few days, performed a complete cure of a hemiplegia, and indeed an almost universal paralytic affection of two years continuance.

Dr Hart, Dr Wilson, Mr Lovet, Mr Wesley, and many others, relate a number of cases wherein the palsy was either cured or mitigated by electricity.

Dr Watson cured an universal tetanus, in the year 1762, by electrifying the patient, at proper intervals, for three months.

Dr

Dr Franklin and others mention some paralytic cases, in which electricity seemed rather to make the patient worse than better.

Mr Wilson cured a woman of a deafness of seventeen years standing.—And Mr Lovet considers electricity as a specific in all cases of violent pains, obstinate headachs, the sciatica, and the cramp. The toothach, he says, is generally cured by it in an instant. He relates a case, from Mr Floyer surgeon at Dorchester, of a compleat cure of a gutta serena; and another of obstinate obstructions in two young women.

De Haen says, that he never failed to cure St Vitus's dance by electricity; and found it of use in some cases of deafness.

Hitherto electricity has been generally applied to the human body either in the method of drawing sparks, as it

is called, or of giving shocks. But these operations are both violent, and though the strong concussion may suit some cases, it may be of disservice in others, where a moderate simple electrification might have been of use.

The great objection to this method is the tediousness and expence of the application. But an electrical machine might be contrived to go by wind or water, and a convenient room might be annexed to it; in which a floor might be raised upon electrics, a person might sit down, read, sleep, or even walk about during the electrification. It were to be wished, that some physician of understanding and spirit would provide himself with such a machine and room. No harm could possibly be apprehended from electricity, applied in this gentle and insensible manner, and good effects are at least possible, if not highly probable.

## E L E

**ELECTRUM**, in natural history. See **AMBER**.

**ELECTUARY**, in pharmacy, a form in which both officinal and extemporaneous medicines are frequently made.

It may be considered as a number of boluses united together, but is made somewhat softer by an addition of a due proportion of preserves or syrups. When the consistence is very soft, it is called sometimes by the name of opiata.

The principal consideration in prescribing officinal electuaries is, that such things only be put together as will not, by any opposite qualities, destroy one another, or lose their natural properties by lying long in this manner; and likewise that the whole be of a consistence that will hold ingredients of different gravities in equal mixture.

**ELEEMOSYNÆ**, and **ELEEMOSYNARIUS**. See **ALMS**, and **ALMONER**.

**ELEGANCE**, or **ELEGANCY**, an ornament of politeness and agreeableness shewn in any discourse, with such a choice of rich and happy expressions, as to rise politely above the common manners, so as to strike people of a delicate taste.

It is observed that elegance, though irregular, is preferable to regularity without elegance: that is, by being so scrupulous of grammatical construction, we lose certain licences wherein the elegance of language consists.

**ELEGIAC**, in ancient poetry, any thing belonging to elegy. See **ELEGY**.

Elegiac verses are alternately hexameter and pentameter, as in the following verses of Ovid. See **HEXAMETER**.

*Flebilis indignas, elegetia, solve capillis:  
Ab nimis ex vero nunc tibi nomen erit.*

Who was the inventor of elegiac poetry is not known. Horace professes himself quite ignorant of it. The principal writers of elegiac verse, among the Latins, were Propertius, Ovid, and Tibullus, the latter whereof Quintilian esteems the best elegiac poet; but Pliny the younger gives the preference to the first: the

Vol. II. No 46.

2

†

5 F

lone

## E L E

chief writers of elegy among the Greeks were Callimachus, Parthenius, and Euphorion.

**ELEGIT**, in law, a writ of execution, which lies for a person who has recovered debt or damages; or upon a recognizance in any court, against a defendant that is not able to satisfy the same in his goods.

**ELEGY**, a mournful and plaintive kind of poem. See **ELEGIAC**.

As elegy, at its first institution, was intended for tears, it expressed no other sentiments, it breathed no other accents but those of sorrow: with the negligence natural to affliction, it sought less to please than to move; and aimed at exciting pity, not admiration. By degrees, however, elegy degenerated from its original intention, and was employed upon all sorts of subjects, gay or sad, and especially upon love. Ovid's book of Love, the poems of Tibullus and Propertius, notwithstanding they are termed elegies, are sometimes so far from being sad, that they are scarce serious. The chief subjects then to which elegy owes its rise, are death and love: that elegy therefore ought to be esteemed the most perfect in its kind which has somewhat of both at once; such, for instance, where the poet bewails the death of some youth or damsel falling a martyr to love.

**ELEMENT**, a term used by philosophers to denote the original component parts of bodies, or those into which they are ultimately resolvable. See **CHEMISTRY**, Vol. II. p. 66.

**ELEMENT**, in a figurative sense, is used for the principles and foundations of any art or science, as Euclid's Elements, &c.

**ELEMI**, or **ELEMV**, in the materia medica, a kind of resin, very improperly called gum elemi. There are two sorts of it kept in the shops; the one genuine, and brought from Ethiopia; the other spurious, and the produce of America. The true kind is a yellowish resin, with a cast of green and white; its smell is acrid and pleasant, and its taste acrid and bitter. It is very inflammable, and readily dissolves in oil and other fat substances over the fire; which two characters alone

lone sufficiently distinguish it from the gums: but this genuine elemi is very rare in Europe.

The spurious elemi is a whitish resin, produced from a tall tree, with pinnated leaves, not unlike those of the pear-tree. It is in some degree pellucid, and of a fragrant smell. It is only used externally, being greatly recommended for resolving tumours, deterring ulcers, wounds, &c.

**ELENCHUS**, in logic, a sophism, or fallacious argument, which deceives the hearer under the appearance of truth. See **SOPHISM**.

**ELEPHANT**, in zoology. See **ELEPHAS**.

*Knights of the ELEPHANT*, an order of knighthood in Denmark, conferred upon none but persons of the first quality and merit. It is also called the order of St Mary. Its institution is said to have been owing to a gentleman among the Danish croisees having killed an elephant, in an expedition against the Saracens, in 1184; in memory of which king Canutus instituted this order, the badge of which is a towered elephant, with an image of the holy virgin encircled with rays, and hung on a watered sky-coloured ribbon, like the George in England.

**ELEPHANTIASIS**, called also the lepra of the Arabians, in medicine, a chronical disease, one of the two species of leprosy, which affects the whole body, where even the bones as well as the skin are covered with spots and tumours, which being red, at last turn black. See **MEDICINE**.

**ELEPHANTINE**, in Roman antiquity, an appellation given to the books wherein were registered the transactions of the senate and magistrates of Rome, of the emperors or generals of armies and even of the provincial magistrates; the births and classes of the people, and other things relating to the census.

They are supposed to have been so called as being made of ivory; though some will have them to have been written on the intestines of elephants.

**ELEPHANTOPUS**, in botany, a genus of the syngenesia polygamia segregata class. The receptacle is naked; the corolla is divided into five segments; the calix is imbricated; and the pappus has several aristæ. There are two species, both natives of the Indies.

**ELEPHAS**, or the **ELEPHANT**, in zoology, a genus of quadrupeds belonging to the order of bruta. The characters are these: The elephant has no fore-teeth in either jaw, and the dog-teeth are very long: The proboscis, or trunk, is long, and capable of laying hold of any thing; and the body is somewhat naked.

The elephant is the largest of all land-animals. From the front to the origin of the tail he is generally about 16 feet long, from the end of the trunk 25 feet, and about 14 feet high. The circumference of the neck is 17 feet, and the circumference of the body at the grossest part 25 feet 10 inches; the tail is about 6 feet long, and 2½ in circumference. The circumference of the legs is about 6 feet. The eyes are small in proportion to the size of the animal. The muzzle is very different from that of any other quadruped; it is nothing but the origin of a long trunk which hangs

between the two large tusks; the mouth appears behind the trunk, which serves in place of an upper lip and the under lip terminates in a point. The tail is short, and small in comparison of the trunk, which has the appearance of a long thick tail placed before. The feet are short, round, clumsy, and only distinguishable by the toes. The trunk is, properly speaking, the nose extended, and terminated by a couple of nostrils. But, besides serving as an organ of smell, the trunk performs all the functions of a strong and dextrous arm. The trunk of an elephant is about 8 feet long, 5½ feet in circumference near the mouth, and one foot and a half near the extremity: It is a pipe of an irregular conical figure, and widened at the end: The superior side of the trunk is convex, and furrowed transversely; and the inferior side is flat, and has two longitudinal rows of small protuberances resembling the tentacula of the silk-worm and most other caterpillars. The upper part of the trunk corresponds with the extremity of the nose in other quadrupeds, and answers the same intention; the inferior part serves as an upper lip, including the nostrils at the same time; for the trunk is a continued canal, divided into two cavities by a longitudinal partition; these cavities ascend along the forepart of the upper jaw, where they make a turn inward and descend into the palate, and then terminate in two separate orifices; they have likewise each a separate orifice at the end of the trunk. At the place where these cavities make a turn, and before they enter into the bones of the head, there is a moveable cartilaginous plate situate in such a manner as enables the elephant to shut the canal, and to prevent the water with which it occasionally fills the trunk from entering into the passage of the nose where the organs serving for the sensation of smell are placed. The elephant can move the trunk in all directions; he can extend or shorten it at pleasure, without altering the diameters of the two canals within. By this means respiration is not interrupted, whatever be the situation of the trunk; and the water is allowed to remain till the animal chuses to throw it out by an expiration. Each canal is lined with a smooth strong membrane, and the surface of the trunk is covered with another strong membrane or skin. The substance contained between the exterior and interior membranes, is a composition of longitudinal and transverse muscles, which serve to extend and contract the length of the trunk. At the extremity of the trunk there is a concave protuberance, in the bottom of which are the two passages of the nostrils. The inferior part of the protuberance is thicker than the sides, and the superior part is stretched out like a finger about five inches long; which, together with the edges of the whole extremity of the trunk, takes on different figures according to the necessities of the animal. It is by this organ that the animal lays hold of food, or other substances, which he manages with as much dexterity as a man does his hand, taking up grains of corn, or the smallest piles of grass, and conveying them to his mouth. When he drinks, he thrusts his trunk into the water, and fills it by drawing in his breath, and exhausting the air: When

When the trunk is thus filled with water, he can either throw it out to a great distance, or drink it by putting the end of the trunk in his mouth.

The two large tusks, which some call the horns of the elephant, are of a yellowish colour, and extremely hard. The bony substance of which they are composed is known by the name of ivory, and much used in different branches of manufacture.

The ears are very large, and resemble those of an ape. The skin of the elephant has but few hairs on it, and placed at great distances from each other. It is full of wrinkles, like those on the palm of a man's hand, besides many chaped and grealy ridges. The female has two dugs, one on each side of the breast. The parts of generation are small in proportion to those of other animals. The penis resembles that of a horse. The female organ is situate near the middle of the belly, more than two feet distant from the usual situation in other quadrupeds: When they copulate, the female lies down on her back.

Elephants, even in a savage state, are peaceable and gentle creatures. They never use their weapons but in defence of themselves or companions. Their social dispositions are so strong, that they are seldom found alone, but march always in large troops; the oldest and most experienced lead the van; the younger, or lame ones, keep in the middle; and those of a second rate, as to age, walk in the rear. The females carry their young on their tusks, embracing them at the same time with their trunk. They seldom march in this regular order but when they reckon the journey dangerous, such as an expedition to cultivated lands, where they expect to meet with resistance. On other occasions they are less cautious. Some of them falling behind or separating from the rest, but seldom so far as to be without the reach of assistance by alarming and assembling their companions. It is only these wanderers that the hunters dare attack; for it would require a whole army to assail a troop of them; and even an army would be unable to conquer them without losing a number of lives. It is dangerous to offer them the least injury; for they run straight upon the offender; and, although the weight of their body be great, their steps are so large, that they easily outrun the swiftest man, whom they either pierce with their tusks or seize with their trunk, dart him in the air like a stone, and then trample him under their feet. But they never attack any person, unless when provoked. However, as they are extremely sensible and delicate with regard to injuries, it is always prudent to keep out of their way. Travellers who frequent these countries kindle large fires, and beat drums during the night, in order to prevent their approach. After being once attacked by men, or falling into any ambush, they are said never to forget the injury, but search for every opportunity of getting revenge. As they are endowed perhaps with a more exquisite sensation of smell than any other animal, owing to the great extent of their nose, they can scent a man at a very great distance, and trace him by his footsteps.

Elephants are peculiarly fond of the banks of rivers,

deep valleys, and marshy grounds, especially when well shaded with trees. They delight in drawing up water into their trunks, even when they do not drink it, and amuse themselves in dashing the water around. They cannot endure cold, and are equally averse to an excess of heat: In order to avoid the scorching heat of the sun, they retire to the thickest and most shady parts of the forest. The bulk of their bodies is so enormous, that they do not chuse to go into deep waters so frequently as some other quadrupeds; although the length of their trunk, which they raise straight up, and by which they respire, is a great advantage in swimming.

The ordinary food of elephants is roots, herbs, leaves, the tender branches of trees, fruits, and grains: but they abhor flesh or fish. When any of them discovers a fine pasture, he immediately calls and invites his companions to come and eat with him. As they devour a large quantity of food in a short time, they are always shifting their pasture; when they meet with cultivated grounds, they make a prodigious desolation, and destroy more plants by their feet than they use for nourishment, which is very considerable, amounting to 150 pounds of herbage every day: by this means, as they constantly graze in large troops, they lay waste whole fields in an hour. The Indians and negroes employ every art to prevent them from visiting their cultivated lands, making great noise, and burning large fires round their fields. However, these precautions are not always sufficient to prevent the elephants from visiting them. They chase away the domestic animals, put the men to flight, and sometimes even throw down their limber huts. Elephants are hardly susceptible of fear; the only things which can surprize them, or stop their course, are artificial fires, such as squibs, crackers, &c the effects of which are so sudden and so quickly repeated, that the elephants frequently turn back; and when one runs, all the rest instantly follow his example.

Although the social disposition in the elephant be exceeding strong; yet whenever the females come in season, it immediately gives place to the stronger and more interesting passion of love. They observe the greatest delicacy in their amours, abhorring nothing so much as to be seen by their companions. The troop divide themselves into couples, steal off into the most secret places of the forest, and then give way to all the impulses of nature, which are lively and lasting in proportion to the long period of abstinence; for the female goes with young two years, and it is only once in three years that the season of love returns. They bring forth but one at a time, which, as soon as it comes into the world, is as large as a wild boar, and is furnished with teeth; however, the large tusks do not make their appearance till some time after, and at the age of six months they are several inches long. Elephants of this age are as large as an ox, when in a natural state. But it is incredible how they degenerate when enslaved and under the management of men. Their disgust and chagrine for the loss of liberty seems never to depart from their minds. In this state, though they feel, at the proper seasons, the

the strongest desires for the sex, no art can allure them to copulate: but the natural passion, restrained by an excess of modesty, bursts out into such violent fits of fury and resentment, that the strongest chains are hardly sufficient to command them. This is a striking difference betwixt the elephant and most other tamed animals. It is only the individual that we can enslave; the species, in spite of all our endeavours, still retain their original freedom and independence.

The manner of taking and taming the elephant, therefore, merits our attention. In forests and such places as are frequented by elephants, the Indians chuse a spot and inclose it with strong pallisades; they use the largest trees as the principal stakes, to which are fixed smaller ones in a transverse direction. These cross-trees are fixed so as to allow a man to pass easily through. There is likewise a large port left for the elephant, over which is suspended a strong barrier, which is let down as soon as he enters. In order to decoy him into the inclosure, the hunters take along with them a tame female in season, and travel about till they come so near as that the cry of the female can reach a male, whom they previously observe in the forest; then the guide of the female makes her give the cry peculiar to the season of love: the male instantly replies, and sets out in quest of her. The guide then makes the female proceed toward the artificial inclosure, repeating her cries from time to time as she goes along. She enters into the inclosure, the male follows her, and the Indians immediately shut the port behind him. He no sooner discovers the hunters, and that he is inclosed, than his passion for the sex is converted into rage and fury. The hunters entangle him with strong ropes; they fetter his legs and trunk; they bring two or three tame elephants in order to pacify and reconcile him to his condition. In a word, they reduce them to obedience in a few days, by a proper application of torture, and caresses. There are many other methods of catching elephants. Instead of making large inclosures with pallisades, like the kings of Siam, and other monarchs, the poor Indians content themselves with a very simple apparatus: they dig deep pits in the roads frequented by elephants, covering them over with branches of trees, turf, &c. When an elephant falls into one of these pits, he is unable to get out again.

The elephant, when tamed, is the most friendly and obedient of all animals: he is entirely attached to the person who feeds and takes care of him. In a short time he understands signs, and the sound of his master's voice. He distinguishes the language of passion, of command, of satisfaction, and acts accordingly. He receives his orders with attention, and executes them with prudence and alacrity, but without precipitation. He easily learns to bow his knees and lower his body, for the convenience of those who mount him. He caresses his friends with his trunk. He lifts burdens with his trunk, and assists those who are loading him in laying them on his back. He delights in shining harness and trappings. When yoked in a cart or waggon, he pulls equally and cheerfully, unless he be a-

bused by injudicious chastisements. His guide is generally mounted on his neck, with a small rod of iron sharp at the point in his hand; he directs his motion by pricking him on the ears and head; but, for the most part, a word is sufficient.

A tame elephant will do more labour than six horses; but then he requires a proportional quantity of food. They are the principal beasts of burden in many parts of Africa and the East Indies. They carry sacks and bundles of all kinds on their neck, back, and tusks. They never lose or damage any thing committed to their care: They will stand on the edge of a river, take bundles off their necks and tusks, lay them carefully in a boat wherever they are desired, and try with their trunk whether they are properly situated; if they be loaded with casks, they go in quest of stones to prop them and prevent them from rolling.

From the earliest accounts in history, the eastern nations have employed elephants in war; Alexander the Great was the first European who ever mounted an elephant. He carried a number of them into Greece, which Pyrrhus employed some years after against the Romans at the battle of Tarentum. Both the Greeks and Romans soon learnt to get the better of these monstrous animals, they opened their ranks and allowed them to pass through; neither did they attempt to hurt them, but threw darts, &c. at their guides. Now that fire-arms are the principal instruments of war, elephants, who are terrified at the noise and flame, instead of being useful, would only tend to embarrass and confuse an army. However, in Cochin and other parts of Malabar, as also in Tonquin, Siam, and Pegu, where fire-arms are little understood, they are still used in battle. The guide sits astride upon the neck, and the combatants sit or stand upon the other parts of the body.

When the elephant is properly managed, he lives very long even in a state of slavery and labour. That some have lived in this state 120 years, is pretty well authenticated. In a natural state, they often exceed 200 years, and propagate their species till they be 120: It is 30 years before they come to their full growth. [Plate LXXIV. fig. 3.]

ELEVATION, the same with altitude or height. See ALTITUDE.

ELEVATION *of the host*, in the church of Rome, that part of the mass where the priest raises the host above his head for the people to adore. See MASS and HOST.

ELEVATOR, in anatomy, the name of several muscles, so called from their serving to raise the parts of the body to which they belong. See ANATOMY, Part II.

ELEVATORY, in surgery, an instrument for raising depressed or fractured parts of the skull, to be applied after the integuments and periosteum are removed. See SURGERY.

ELEUSINIA, in Grecian antiquity, a festival kept in honour of Ceres, every fourth year by some states, but by others every fifth. The Athenians celebrated it at Eleusis, a town of Attica, whence the name.

It was celebrated with a world of ceremony, and persons of both sexes were initiated in it; it being deemed



deemed impious to neglect doing so. The mysteries were of two sorts, the lesser, and the greater; whereof the former were sacred to Proserpine, Ceres's daughter, and the latter to Ceres herself. According to LaStantius, they consisted in a mythical representation of what mythologists teach of Ceres; though some of the Christian fathers will have the great mystery, or secret, which they were forbidden by law, upon pain of death, to divulge, to have been the representation or figures of both male and female privities, which were handed about and exposed to the company.

**ELEUTHERIA**, another festival celebrated at Platæa, by delegates from almost all the cities of Greece, in honour of Jupiter Eleutherius, or the assertor of liberty.

It was instituted in memory of the victory obtained by the Grecians, in the territories of Platæa, over Mardonius, the Persian general, left by Xerxes with a mighty army to subdue Greece.

**ELF**, a term now almost obsolete, formerly used to denote a fairy, or hobgoblin, an imaginary being, the creature of ignorance, superstition, and craft. See **FAIRY**.

**ELF-ARROWS**, in natural history, a name given to the flints, anciently fashioned into arrow-heads, and still found fossil in Scotland, America, and several other parts of the world; they are believed by the vulgar to be shot by fairies, and that cattle are sometimes killed by them.

**ELGIN**, the capital of the county of Murray, in Scotland, situated on the river Lofey, about six miles north of the Spey: W. long. 2° 25', N. lat. 57° 40'.

**ELIQUATION**, in metallurgy, a separation of the different parts of mixed bodies, by the different degrees of fire required to melt them. See **CHEMISTRY**.

**ELISION**, in grammar, the cutting off, or suppressing a vowel at the end of a word, for the sake of sound, or measure, the next word beginning with a vowel.

Elisions are pretty frequently met with in English poetry, but more frequently in the Latin, French, &c. They chiefly consist in suppressions of the *a*, *e*, and *i*, though an elision suppresses any of the other vowels.

**ELIXATION**, in pharmacy, the extracting the virtues of ingredients by boiling or stewing.

**ELIXIR**, in medicine, a compound tincture extracted from many efficacious ingredients. Hence the difference between a tincture and an elixir seems to be this, that a tincture is drawn from one ingredient, sometimes with an addition of another to open it, and to dispose it to yield to the menstruum; whereas an elixir is a tincture extracted from several ingredients at the same time. See **TINCTURE**.

**ELK**, in zoology. See **CERVUS**.

**ELKHOLM**, a port-town of Gothland, in Sweden, twenty-four miles west of Carelskroon.

**ELL**, a measure of length, different in different countries; but those mostly used, are the English and Flemish ells; whereof the former is three feet nine inches, or one yard and a quarter; and the latter only twenty-seven inches, or three quarters of a yard. In Scotland, the ell contains 37  $\frac{1}{8}$  English inches.

**ELLERENA**, a town of Estremadura, in Spain, fifty miles south east of Merida.

**ELLIPSIS**, in geometry. See **CONIC SECTIONS**.

**ELLIPSIS**, in grammar, a figure of syntax, wherein one or more words are not expressed; and from this deficiency, it has got the name ellipsis.

The ellipsis, properly so called, is when the deficient word or words must be supplied from elsewhere; as *Hectoris Andromache*, where *uxor* is understood; that is, Andromache, Hector's wife.

**ELLIPTIC**, or **ELLIPTICAL**, something belonging to an ellipsis.

**ELLIPOMACHROSTYLA**, in natural history, a genus of imperfect crystals, with single pyramids; one end of their column being affixed to some solid body. They are dodecahedral, with thinner hexangular columns and hexangular pyramids.

Of these crystals, authors enumerate a great many species; among which are the whitish pellucid sprig crystal, a bright brown kind, a dull brown kind, and a bright yellow kind, all which are farther distinguished according to the different lengths of their pyramids.

**ELLIPOPACHYSTYLA**, in natural history, a genus of imperfect crystals, composed of twelve planes, in a hexangular column, terminated by an hexangular pyramid at one end, and irregularly affixed to some other body at the other, with shorter columns.

There are two species of these crystals, one short, bright and colourless, found in great plenty in New Spain and other parts of America; the other, a short, dull, and dusky brown one, found in Germany, and sometimes in England.

**ELM**, in botany. See **ULMUS**.

**ELNA**, a town of Catalonia in Spain, but subject to France, situated ten miles south of Perpignan.

**ELOCUTION**, in rhetoric, the adapting words and sentences to the things or sentiments to be expressed. It consists of elegance, composition, and dignity. The first comprehending the purity and perspicuity of a language, is the foundation of elocution; the second ranges the words in proper order; and the last adds the ornaments of tropes and figures to give strength and dignity to the whole.

**ELODES**, in botany. See **HYPERICUM**.

**ELOGY**, a praise or panegyric bestowed on any person or thing, in consideration of its merit. The beauty of elogy consists in an expressive brevity. Eulogiums should not have so much as one epithet, properly so called, nor two words synonymous; they should strictly adhere to truth; for extravagant and improbable elogies rather lessen the character of the person or thing they would extol.

**ELOINED**, in law, signifies restrained or hindered from doing something: thus it is said, that if those within age be eloined, so that they cannot sue personally, their next friend shall sue for them.

**ELONGATION**, in astronomy, the digression or recess of a planet from the sun, with respect to an eye placed on our earth. See **ASTRONOMY**.

**ELONGATION**, in surgery, is an imperfect luxation, occasioned by the stretching or lengthening of the ligaments of any joint.

**ELOPEMENT**, in law, is where a married woman de-

parts from her husband, and cohabits with an adulterer; in which case the husband is not obliged to allow her any alimony out of his estate, nor is he chargeable for necessaries for her of any kind.

**ELOPS**, in ichthyology a genus of the order of abdo-minales. The head is smooth, and the teeth are in the margin of the jaws and the palate; there are thirty rays in the branchiostege membrane. There is but one species, *viz.* the favrus, with a tail armed both above and below. It is a native of Carolina.

**ELOQUENCE**, the art of speaking well, so as to affect and persuade.

Cicero defines it, the art of speaking with copiousness and embellishment.

Eloquence and rhetoric differ from each other, as the theory from the practice; rhetoric being the art which describes the rules of eloquence, and eloquence that art which uses them to advantage.

**ELSINORE**, a port-town of Denmark, about twenty-two miles north of Copenhagen, and situated on the Sound or the entrance into the Baltic sea.

**ELVAS**, a city and bishop's see of Alentejo, in Portugal, situated near the frontiers of Spanish Estremadura: W. long.  $7^{\circ} 35'$ , and N. lat.  $38^{\circ} 45'$ .

It is one of the strongest fortresses in Portugal.

**ELUL**, in ancient chronology, the twelfth month of the Jewish civil year, and the sixth of the ecclesiastical: it consisted of only twenty-nine days, and answered pretty nearly to our August.

**ELUTRIATION**, the separating the lighter matters from the mixt ores of metals, by means of great quantities of fair water. See **CHEMISTRY**.

**ELY**, a city and-bishop's see of Cambridgeshire, situated about twelve miles north of Cambridge: E. long.  $15'$ , and N. lat.  $52^{\circ} 24'$ .

It is a county of itself, including the territory around, and has a judge who determines all causes civil and criminal within its limits.

**ELYMUS**, in botany, a genus of the tetrandria digynia class. The involucre consists of two leaves; and the spiculae are double. There are eight species, only one of which, *viz.* the arenarius, or sea lyme-grass, is a native of Britain.

**ELYSIUM**, or **ELYSIAN FIELDS**, in heathen mythology, certain plains abounding with woods, fountains, verdure, and every delightful object; supposed to be the habitation of heroes and good men after death.

According to some, the fable of Elysium is of Phœnician extraction, or rather founded upon the account of paradise delivered in the Scriptures.

**ELYTROIDES**, or **VAGINALES**, in anatomy. See Vol I. p. 270.

**EMANATION**, the act of flowing or proceeding from some source or origin; or, the thing that proceeds from that action.

**EMANCIPATION**, in the Roman law, the setting free a son from the subjection of his father; so that whatever moveables he acquires belong in property to him, and not to his father as before emancipation.

Emancipation puts the son in capacity of managing his own affairs, and of marrying without his father's

consent, though a minor. Emancipation differs from manumission, as the latter was the act of a master in favour of a slave, whereas the former was that of a father in favour of his son.

There were two kinds of emancipation; the one tacit, which was by the sons being promoted to some dignity, by his coming of age, or by his marrying, in all which cases he became his own master of course.

The other, express; where the father declared before a judge, that he emancipated his son. In performing this, the father was first to sell his son imaginarily to another, whom they called *pater fiduciarius*, father in trust, of whom being bought back again by the natural father, he manumitted him before the judge by a verbal declaration.

Emancipation still obtains in France with regard to minors or pupils, who are hereby set at liberty to manage their own effects, without the advice or direction of their parents or tutors.

**EMARGINATED**, amongst botanists. See Vol. I. p. 640.

**EMASCULATION**, the act of castrating or depriving a male of those parts which characterise his sex. See **CASTRATION**.

**EMBALMING**, is the opening a dead body, taking out the intestines, and filling the place with odoriferous and desiccative drugs and spices, to prevent its putrifying. The Egyptians excelled all other nations in the art of preserving bodies from corruption; for some that they have embalmed upwards of two thousand years ago, remain whole to this day, and are often brought into other countries as great curiosities. Their manner of embalming was thus: they scooped out the brains with an iron scoop, out at the nostrils, and threw in medicaments to fill up the vacuum: they also took out the entrails, and, having filled the body with myrrh, cassia, and other spices, except frankincense, proper to dry up the humours, they pickled it in nitre, where it lay soaking for seventy days. The body was then wrapped up in bandages of fine linen and gums, to make it stick like glue, and so was delivered to the kindred of the deceased, entire in all its features, the very hairs of the eye-lids being preserved. They used to keep the bodies of their ancestors, thus embalmed, in little houses magnificently adorned, and took great pleasure in beholding them, alive as it were, without any change in their size, features, or complexion. The Egyptians also embalmed birds, &c. The prices for embalming were different; the highest was a talent, the next twenty minæ, and so decreasing to a very small matter: but they who had not wherewithal to answer this expence, contented themselves with infusing, by means of a syringe, thro' the fundament, a certain liquor extracted from the cedar, and leaving it there wrapped up the body in salt of nitre: the oil thus preyed upon the intestines, so that when they took it out, the intestines came away with it, dried, and not in the least putrified: the body being inclosed in nitre, grew dry, and nothing remained besides the skin glued upon the bones.

**EMBARGO**, in commerce, in arrest on ships, or merchandise,

chandise, by public authority; or a prohibition of state, commonly on foreign ships, in time of war, to prevent their going out of port, sometimes to prevent their coming in, and sometimes both, for a limited time.

The king may lay embargoes on ships, or employ those of his subjects, in time of danger, for service and defence of the nation; but they must not be for the private advantage of a particular trader, or company; and therefore a warrant to stay a single ship is no legal embargo. No inference can be made from embargoes which are only in war time; and are a prohibition by advice of council, and not at prosecution of parties. If goods be laden on board, and after an embargo or restraint from the prince or state comes forth, and then the master of the ship breaks ground, or endeavours to sail, if any damage accrues, he must be responsible for the same; the reason is, because his freight is due, and must be paid, nay though the goods be seized as contraband.

Embargo differs from quarantine, inasmuch as this last is always for the term of forty days, in which persons from foreign parts, infected with the plague, are not permitted to come on shore. See *QUARANTINE*.

**EMBASSADOR, or AMBASSADOR**, a public minister sent from one sovereign prince, as a representative of his person, to another.

Embassadors are either ordinary or extraordinary. Ambassador in ordinary, is he who constantly resides in the court of another prince, to maintain a good understanding, and look to the interest of his master. Till about two hundred years ago, ambassadors in ordinary were not heard of; all, till then, were ambassadors extraordinary, that is, such as are sent on some particular occasion, and who retire as soon as the affair is dispatched.

By the law of nations, none under the quality of a sovereign prince can send or receive an ambassador. At Athens, ambassadors mounted the pulpit of the public orators, and there opened their commission, acquainting the people with their errand. At Rome, they were introduced to the senate, and delivered their commissions to them.

Embassadors should never attend any public solemnities, as marriages, funerals, &c. unless their masters have some interest therein; nor must they go into mourning on any occasions of their own, because they represent the persons of their prince. By the civil law, the moveable goods of an ambassador, which are accounted an accession to his person, cannot be seized on, neither as a pledge, nor for payment of a debt, nor by order or execution of judgment, nor by the king's or state's leave where he resides, as some conceive; for all actions ought to be far from an ambassador, as well that which toucheth his necessities, as his person: if, therefore, he hath contracted any debt, he is to be called upon kindly, and if he refuses, then letters of request are to go to his master. Nor can any of the ambassador's domestic servants that are registered in the secretaries of state's office be arrested in person or goods: if they are, the process shall be void, and the parties suing out and executing it shall

suffer and be liable to such penalties and corporal punishment as the lord chancellor or either of the chief justices shall think fit to inflict. Yet ambassadors cannot be defended when they commit any thing against that state, or the person of the prince, with whom they reside; and if they are guilty of treason, felony, &c. or any other crime against the law of nations, they lose the privilege of an ambassador, and may be subject to punishment as private aliens.

**EMBASSY**, the office or function of an ambassador. See the preceding article.

**EMBDEN**, a port-town and city of Germany, capital of a county of the same name, now in possession of the king of Prussia; it is situated at the mouth of the river Ems: E. long.  $6^{\circ} 45'$ , and N. lat.  $53^{\circ} 50'$ .

**EMBER-WEEKS, or DAYS**, in the episcopal church, are certain seasons of the year, set apart for the imploring God's blessing, by prayer and fasting, upon the ordinations performed in the church at such times.

These ordination-fasts are observed four times in the year, *viz.* the Wednesday, Friday, and Saturday after the first Sunday in lent, after Whitsunday, after the fourteenth of September and the thirteenth of December; it being enjoined, by a canon of the church, that deacons and ministers be ordained, or made, only upon the Sundays immediately following these ember-fasts.

**EMBERIZA**, in ornithology, a genus of birds, belonging to the order of passerres. The bill is conical, and the mandibles recede from each other towards the base; the inferior mandible has the sides narrowed inwards, but the upper one is still narrower. There are twenty-four species, *viz.* The nivalis, or great pyed mountain-finch of Ray, and the snow-bird of Edwards, has white-wings; but the outer edge of the prime-feathers are black; the tail is black, with three white feathers on each side. They inhabit Lapland and Hudson's bay, and in hard winters they come into Sweden, when they are totally white. 2. The hyemalis, or snow sparrow of Catesby, is black above, and the belly is white. It is a native of North America. 3. The miliaris, or grey emberiza, is of a greyish colour, spotted with black in the belly, and the orbits are redish. It is the bunting of English authors, and a bird of Europe. 4. The hortulana, or ortolan, has black wings; the first three feathers on the tail are white on the edges, only the two lateral are black outwardly. The orbits of the eyes are naked and yellow; the head is greenish, and yellow towards the inferior mandible. It feeds principally upon the panick-grass; grows very fat, and is reckoned a delicate morsel by certain epicures. It is a bird of Europe. 5. The citrinella, or yellow hammer, has a blackish tail, only the two outward side-feathers are marked on the inner edge with a sharp white spot. It is a bird of Europe, and comes about houses in winter: it builds its nest on the ground in meadows. 6. The olivacea, or olive emberiza, is of an olive colour above, whiter below; the nape of the neck is orange-coloured, and it has a black belt across the breast. It is a native of Dominica. 7. The crix, or grenadier

of Edwards, is greyish, with the front and belly black, a tawny neck and rump, and a black-bill. It is a native of Africa. 8. The quelea, has a grey back, a black front, and a red bill. It is a native of Africa. 9. The capensis, or ortolon of the cape of Good Hope, is greyish, with a white nape of the neck, and a black belt round the orbits and mandibles. It inhabits the Cape of Good Hope. 10. The ludovicica is greyish above, and pale below; the breast is reddish, and there is a black circle on the head. 11. The cia, is reddish, with white eye-brows, and black lines on the head. It is a bird of Europe. 12. The cirius, is a bird of Europe; it has a greyish back, a spotted breast, and yellowish eye-brows. 13. The familiaris is greyish and spotted; the tips of the tail-feathers are white, and hind part of the back yellow. It is a native of Asia. 14. The slaveola, is greyish, with a yellow face; it is about the size of a silk, and is a native of warm countries. 15. The amazona is of a tawny colour, with the crown of the head yellow, and the base of the wings white underneath. It is a native of Surinam. 16. The orizivora, or ortolan of Carolina, is brownish, with a tawny head, and a black belly. It is properly a native of Cuba, but migrates to Carolina about the autumn after the rice is reaped. 17. The schoeniclas, or reed-sparrow, has a black head, a blackish-grey body, and a white spot on the quill-feathers. It is a bird of Europe. 18. The psittacus, is of a tawny ash-colour, with yellow wings, and two of the tail-feathers remarkably long. 19. The paradisæa is brownish, with a red breast, and two long sharp-pointed feathers in the tail, and a black bill. It is a native of Africa, and sheds the long feathers of the tail every year, like the peacock. 20. The serena, has a red bill, a black fillet, a red vertex, and a wedge-shaped tail. 21. The vidua, or Indian sparrow of Aldrovandus, is blackish above, and white below, with four very long feathers in the tail, and a red bill. It is a native of India. 22. The principalis, is spotted, with the breast, bill, and legs red. It is a bird of Argola. 23. The regia, has a red bill, four long equal feathers in the tail, and red legs. It is a native of Africa. 24. The ciris, has a blueish head, a yellow belly, and a green back. It is a native of North America.

**EMBLEM**, a kind of painted enigma, or certain figures painted or cut, metaphorically expressing some action, with reflections underneath, which in some measure explain the sense of the device, and at the same time instruct us in some moral truth, or other matter of knowledge.

**EMBLEMENTS**, among lawyers, denote the profits of sown lands; but are sometimes used, more largely, for any products that naturally arise from the ground.

**EMBOLISMIC, or INTERCALARY.** See **INTERCALARY**.

**EMBOLUS**, the moveable part of a pump, or syringe, called also the piston, or sucker.

**EMBOSSING, or IMBOSSING**, in architecture and sculpture, the forming or fashioning works in relief, whether cut with a chisel or otherwise.

**EMBRASURE**, in architecture, the enlargement made of the aperture of a door or window, on the inside of the wall; its use being to give the greater play for the opening of the door or casement, or to admit the more light.

**EMBROCCATION**, in surgery and pharmacy, an external kind of remedy, which consists in an irrigation of the part affected, with some proper liquor, as oils, spirits, &c. by means of a woollen or linen cloth, or a sponge, dipped in the same.

**EMBROIDERY**, a work in gold, or silver, or silk thread, wrought by the needle upon cloth, stuffs, or muslin, into various figures. In embroidering stuffs, the work is performed in a kind of loom, because the more the piece is stretched, the easier it is worked. As to muslin, they spread it upon a pattern ready designed; and sometimes, before it is stretched upon the pattern, it is starched, to make it more easy to handle. Embroidery on the loom is less tedious than the other, in which, while they work flowers, all the threads of the muslin, both lengthwise and breadthwise, must be continually counted; but, on the other hand, this last is much richer in points, and susceptible of greater variety. Cloths too much milled are scarce susceptible of this ornament, and in effect we seldom see them embroidered. The thinnest muslins are left for this purpose; and they are embroidered to the greatest perfection in Saxony: in other parts of Europe, however, they embroider very prettily, and especially in France.

There are several kinds of embroidery; as, 1. Embroidery on the stamp, where the figures are raised and rounded, having cotton or parchment put under them to support them. 2. Low embroidery, where the gold and silver lie low upon the sketch, and are stitched with silk of the same colour. 3. Guimped embroidery: this is performed either in gold or silver; they first make a sketch upon the cloth, then put on cut vellum, and afterwards sew on the gold and silver with silk thread: in this kind of embroidery they often put gold and silver cord, tinsel, and spangles. 4. Embroidery on both sides, that which appears on both sides of the stuff. 5. Plain embroidery, where the figures are flat and even, without cords, spangles, or other ornaments.

**EMBRUN, or AMBRUN**, a city of Dauphiny, in France, near the confines of Piedmont: E. long. 6° 6', and N. lat. 44° 35'.

**EMBRIO**, in physiology, the first rudiments of an animal in the womb, before the several members are distinctly formed; after which period it is denominated a fœtus.

**EMBRYOTHLASTES**, in midwifery, an instrument contrived for breaking the bones, for the more easy extraction of the fœtus in difficult labours.

**EMBRYOTOMY**, the cutting a fœtus to pieces whilst in the womb, practised in cases of necessity, when there is no other way of saving the mother.

**EMBRYULCUS**, a hook for extracting the child in difficult labours. See **MIDWIFERY**.

**EMERALD**, in natural history, a genus of precious stones, of a green colour, and next in hardness to the ruby. Our jewelers distinguish emeralds into two kinds, the oriental

oriental and occidental: the emeralds of the East-Indies are evidently finer than those of any other part of the world; but our jewellers, seldom meeting with these, call the American emeralds the oriental, and usually sell crystal accidentally tinged with green, under the name of the occidental emerald: these being also the most common, there has grown an opinion among the lapidaries, that the emerald is no harder than the crystal; because what they take to be emeralds, are in general only crystals.

The genuine emerald, in its most perfect state, is perhaps the most beautiful of all the gems; it is found of various sizes, but usually small; a great number of them are met with of about the sixteenth part of an inch in diameter, and they are found from this to the size of a walnut.

The emerald is of different figures like the diamond and many of the other gems, being sometimes found in a roundish or pebble-like form, but much more frequently in a columnar one, resembling common crystal: the pebble-emeralds are always the hardest and brightest, but are seldom found exceeding the size of a pea: the crystalliform ones grow several together, and are often larger: the pebble-kind are found loose in the earths of mountains, and sands of rivers; the columnar are found usually bedded in, or adhering to, a white, opaque, and coarse crystalline mass, and sometimes to the jasper, or the praus.

The oriental emerald is of the hardness of the sapphire and ruby, and is second only to the diamond in lustre and brightness: the American is of the hardness of the garnet, and the European somewhat softer than that, yet considerably harder than crystal: It loses its colour in the fire, and becomes undistinguishable from the white sapphire.

The oriental emeralds are very scarce, and at present found only in the kingdom of Cambay; very few of them have of late been imported into Europe, inasmuch that it has been supposed there were no oriental emeralds; but within these ten years, some few have been brought from Cambay into Italy, that greatly excel the American ones. The American, being what our jewelers call oriental emeralds, are found principally about Peru; and the European are principally from Silesia.

*To counterfeit EMERALDS:* Take of natural crystal, four ounces; of red-lead, four ounces; verdegrease, forty-eight grains; crocus martis, prepared with vinegar, eight grains; let the whole be finely pulverized and sifted; put this into a crucible, leaving one inch empty: lute it well, and put it into a potter's furnace, and let it stand there as long as they do their pots. When cold, break the crucible, and you will find a matter of a fine emerald colour, which, after it is cut and set in gold, will surpass in beauty an oriental emerald.

**EMERY**, in natural history, a rich iron-ore found in large masses of no determinate shape or size, extremely hard, and very heavy. It is usually of a dusky brownish red on the surface; but when broken, is of a fine bright iron-grey, but not without some tinge of red-

ness; and is spangled all over with shining specks, which are small flakes of a foliaceous talc, highly impregnated with iron. It is also sometimes very red, and then usually contains veins of gold. It makes no effervescence with any of the acid menstrua, and is found in the island of Guernsey, in Tuscany, and many parts of Germany.

**EMETIC**, a medicine which induces vomiting.

**EMINENCE**, a title of honour peculiar to cardinals. See **CARDINAL**.

**EMIR**, a title of dignity among the Turks, signifying a prince.

This title was first given to the caliphs; but when they assumed the title of sultans, that of emir remained to their children; as that of Cæsar among the Romans. At length the title became attributed to all who were judged to descend from Mahomet by his daughter Fatimah, and who wear the green turban instead of the white. The Turks make an observation, that the emirs, before their fortieth year, are men of the greatest gravity, learning and wisdom; but after this, if they are not great fools, they discover some signs of levity and stupidity. This is interpreted by the Turks as a sort of divine impulse in token of their birth and sanctity. The Turks also call the vizirs, bashaws, or governors of provinces, by this name.

**EMISSARY**, in a political sense, a person employed by another to sound the opinions of people, spread certain reports, or act as a spy over other peoples actions.

**EMMENAGOGUES**, in pharmacy, medicines which promote the menses, either by giving a greater force to the blood in its circulation, whereby its momentum against the vessels is increased; or by making it thinner, whereby it will more easily pass through any outlet.

**EMMERIC**, a city of Westphalia, in Germany, subject to Prussia: E. long. 5° 45', N. lat. 51° 48'.

**EMOLLIENTS**, in medicine and pharmacy, are such remedies as smooth and soften the asperity of the humours, and relax and supple the solids at the same time.

**EMPALEMENT**, an ancient kind of punishment, which consisted in thrusting a stake up the fundament.

**EMPALEMENT of a flower**, the same with calix. See **CALIX**.

**EMPEROR**, a title of honour among the ancient Romans, conferred on a general who had been victorious, and now made to signify a sovereign prince, or supreme ruler of an empire.

The title of emperor adds nothing to the rights of sovereignty; it only gives preheminance above other sovereigns. The emperors, however, pretend, that the imperial dignity is more eminent than the regal. It is disputed whether emperors have the power of disposing of the regal title; however this may be, they have sometimes taken upon them to erect kingdoms: thus it is that Bohemia, Prussia, and Poland, are said to have been raised to that dignity. In the east, the title of emperor is more frequent than with us; thus the sovereign princes of China, Mogul, &c. are called emperors.

perors. In the west, the title has been a long time restrained to the emperors of Germany. The first who bore it was Charlemagne, who was crowned by Pope Leo III. in 800. And it is to be observed, that there was not a foot of land or territory annexed to the emperor's title.

In the year 1723, the Czar of Muscovy assumed the title of emperor of all the Russias. The kings of France were also called emperors, when they reigned with their sons, whom they associated in the crown: thus Hugh Caput was called emperor, and his son Robert king. The kings of England were anciently styled emperors, as appears from a charter of king Edgar.

The emperor of Germany is a limited monarch in regard to the empire, though he is an absolute sovereign in most of his hereditary dominions; the late emperors of the Austrian family, having hereditary dominions, enumerated all of them in their title. Charles VI. was styled emperor of the Romans, always august, king Bohemian and Hungary, archduke of Austria, &c.; but the present emperors inheriting those countries, her consort enjoys only the title of emperor of the Romans, duke of Lorraine and Tuscany. The emperor creates dukes, marquises, and other noblemen; and he appoints most of the officers, civil and military, in the empire: he is elected by the nine electors; and he summons the general diet of the empire.

**EMPETRUM**, BERRY BEARING HEATH, in botany, a genus of the diœcia triandria class. The calix of both male and female consists of three segments, and the corolla of three petals. The female has nine styli; and the berry contains nine seeds. There are two species, one of which, *viz.* the nigrum, black-berried heath, crow or crane berries, is a native of Britain.

**EMPHASIS**, in rhetoric, a particular stress of the voice and action, laid on such parts or words of the oration as the orator wants to enforce upon his audience.

**EMPHYSEMA**, in surgery, a tumour generally occasioned in a fracture of the ribs. See **SURGERY**, and **MEDICINE**.

**EMPIRE**, a large extent of land, under the jurisdiction or government of an emperor. See **EMPEROR**.

**EMPIRIC**, an appellation given to those physicians who conduct themselves wholly by their own experience, without studying physic in a regular way. Some even use the term, in a still worse sense, for a quack who prescribes at random, without being at all acquainted with the principles of the art.

**EMPIS**, in zoology, a genus of insects belonging to the order of diptera. The beak is horny, insected, consists of two valves, and is longer than the thorax. There are five species, principally distinguished by their colour.

**EMPRESS**, the spouse of an emperor, or a woman who governs an empire. See **EMPEROR**.

**EMPROSTHOTONOS**, a species of convulsion, wherein the head bends forward. See **MEDICINE**.

**EMPYREMA**, in medicine, a disorder wherein purulent matter is contained in the thorax or breast, after an in-

flammation and suppuration of the lungs and pleura. See **MEDICINE**, and **SURGERY**.

**EMPYREUM**, a term used by divines for the highest heaven, where the blessed enjoy the beatific vision.

**EMPYREUMA**, among chemists and physicians, the fiery taste or offensive smell which brandies, and other bodies prepared by fire, are impregnated with. See **CHEMISTRY**.

**EMRODS**. See **HÆMORRHOIDS**.

**EMULGENT**, or **RENAL ARTERIES**. See **ANATOMY**, Part III.

**EMULSION**, a soft liquid remedy, of a colour and consistence resembling milk. See **CHEMISTRY**.

**EMUNCTORY**, in anatomy, a general term for all those parts which serve to carry off the excrementitious parts of the blood and other humours of the body. Such more especially are the kidneys, bladder, and most of the glands. See **ANATOMY**.

**ENÆMON**, in medicine, an epithet often applied by Hippocrates and Galen, to such topical medicines as are appropriated to a wound newly inflicted, before the blood be stopped.

**ENÆOREMA**, in medicine, that pendulous substance which floats in the urine. It is also called *sublimamentum* and *nubeculæ*, from its resemblance to little clouds.

**ENALLAGE**, in grammar, is when one word is substituted for another of the same part of speech: a substantive for an adjective, as *exercitus victor*, for *victoriosus*; *scelus*, for *sceleratus*.

**ENAMEL**, a kind of coloured glass, used in enamelling and painting in enamel.

Enamels have for their basis a pure crystal glass or frit, ground up with a fine calx of lead and tin prepared for the purpose, with the addition usually of white salt of tartar. These ingredients baked together, are the matter of all enamels, which are made by adding colours of this or that kind in powder to this matter, and melting or incorporating them together in a furnace.

For white enamel, Neri (*De Arte Vitriar.*) directs only manganese to be added to the matter which constitutes the basis. For azure, zaffer mixed with calx of brass. For green, calx of brass with scales of iron, or with crocus martis. For black, zaffer with manganese, or with crocus martis; or manganese with tartar. For red, manganese, or calx of copper and red tartar. For purple, manganese with calx of brass. For yellow, tartar and manganese. And for violet-coloured enamel, manganese with thrice-calcined brass.

In making these enamels, the following general cautions are necessary to be observed. 1. That the pots must be glazed with white glass, and must be such as will bear the fire. 2. That the matter of enamels must be very nicely mixed with the colours. 3. When the enamel is good, and the colour well incorporated, it must be taken from the fire with a pair of tongs. 4. The general way of making the coloured enamel is this: powder, sift, and grind all the colours very nicely, and first mix them with one another, and then with the common matter of enamels; then set them in pots in a furnace, and when they are well mixed and incorporated,

incorporated, cast them into water; and when dry, set them in a furnace again to melt; and when melted, take a proof of it. If too deep-coloured, add more of the common matter of enamels; and if too pale, add more of the colours.

Enamels are used either in counterfeiting or imitating precious stones, in painting in enamel; or by enamellers, jewellers, and goldsmiths, in gold, silver, and other metals. The two first kinds are usually prepared by the workmen themselves who are employed in these arts. That used by jewellers, &c. is brought to us chiefly from Venice or Holland, in little cakes of different sizes, commonly about four inches diameter, having the mark of the maker struck upon it with a punchon. It pays the pound 1s. 7  $\frac{4}{5}$  d. on importation, and draws back 1s. 5  $\frac{7}{8}$  d. at the rate of 4s. per pound.

**ENAMELLING**, the art of laying enamel upon metals, as gold, silver, copper, &c. and of melting it at the fire, or of making divers curious works in it at a lamp. It signifies also to paint in enamel.

*The method of painting in ENAMEL.* This is performed on plates of gold or silver, and most commonly of copper, enamelled with the white enamel; whereon they paint with colours which are melted in the fire, where they take a brightness and lustre like that of glass. This painting is the most prized of all for its peculiar brightness and vivacity, which is very permanent, the force of its colours not being effaced or sullied with time, as in other painting, and continuing always as fresh as when it came out of the workman's hands. It is usual in miniature, it being the more difficult the larger it is, by reason of certain accidents it is liable to in the operation. Enamelling should only be practised on plates of gold, the other metals being less pure: copper, for instance, scales with the application, and yields fumes; and silver turns the yellows white. Nor must the plate be made flat; for in such case, the enamel cracks; to avoid which, they usually forge them a little round or oval, and not too thick. The plate being well and evenly forged, they usually begin the operation by laying on a couch of white enamel (as we observed above) on both sides, which prevents the metal from swelling and blistering; and this first lay serves for the ground of all the other colours. The plate being thus prepared, they begin at first by drawing out exactly the subject to be painted with red vitriol, mixed with oil of spike, marking all parts of the design very lightly with a small pencil. After this, the colours (which are to be before ground with water in a mortar of agate extremely fine, and mixed with oil of spike somewhat thick) are to be laid on, observing the mixtures and colours that agree to the different parts of the subject; for which it is necessary to understand painting in miniature. But here the workman must be very cautious of the good or bad qualities of the oil of spike he employs to mix his colours with, for it is very subject to adulterations. See **OIL**.

Great care must likewise be taken, that the least dust imaginable come not to your colours while you are

either painting or grinding them; for the least speck, when it is worked up with it, and when the work comes to be put into the reverberatory to be red-hot, will leave a hole, and so deface the work.

When the colours are all laid, the painting must be gently dried over a slow fire to evaporate the oil, and the colours afterwards melted to incorporate them with the enamel, making the plate red-hot in a fire like what the enamellers use. Afterwards that part of the painting must be passed over again which the fire hath any thing effaced, strengthening the shades and colours, and committing it again to the fire, observing the same method as before, which is to be repeated till the work be finished.

*Method of ENAMELLING by the lamp.* Most enamelled works are wrought at the fire of a lamp, in which, instead of oil, they put melted horse-grease, which they call caballine oil. The lamp, which is of copper or white iron, consists of two pieces, in one of which is a kind of oval plate, six inches long, and two high, in which they put the oil and the cotton. The other part, called the box, in which the lamp is inclosed, serves only to receive the oil which boils over by the force of the fire. This lamp, or, where several artists work together, two or three more lamps are placed on a table of proper height. Under the table, about the middle of its height, is a double pair of organ-bellows, which one of the workmen moves up and down with his foot, to quicken the flame of the lamps, which are by this means excited to an incredible degree of vehemence. Grooves made with a gauge in the upper part of the table, and covered with parchment, convey the wind of the bellows to a pipe of glass before each lamp; and that the enamellers may not be incommoded with the heat of the lamp, every pipe is covered at six inches distance with a little tin plate, fixed into the table by a wooden handle. When the works do not require a long blast, they only use a glass pipe, into which they blow with their mouth.

It is incredible to what a degree of fineness and delicacy the threads of enamel may be drawn at the lamp. Those which are used in making false tufts of feathers are so fine, that they may be wound on the reel like silk or thread. The fictitious jets of all colours, used in embroideries, are also made of enamel; and that with so much art, that every small piece hath its hole to pass the thread through wherewith it is sewed. These holes are made by blowing them into long pieces, which they afterwards cut with a proper tool.

It is seldom that the Venetian or Dutch enamels are used alone; they commonly melt them in an iron-ladle, with an equal part glass or crystal; and when the two matters are in perfect fusion, they draw it out into threads of different sizes, according to the nature of the work. They take it out of the ladle while liquid, with two pieces of broken tobacco pipes, which they extend from each other at arm's length. If the thread is required still longer, then another workman holds one end, and continues to draw it out, while the first holds the enamel to the flame. Those threads, when cold,

- cold, are cut into what lengths the workman thinks fit, but commonly from ten to twelve inches; and as they are all round, if they are required to be flat, they must be drawn through a pair of pincers while yet hot. They have also another iron instrument in form of pincers, to draw out the enamel by the lamp when it is to be worked and disposed in figures. Lastly, they have glass-tubes of various sizes, serving to blow the enamel into various figures, and preserve the necessary vacancies therein; as also to spare the stuff, and form the contours. When the enameller is at work, he sits before his lamp with his foot on the step that moves on the bellows; and holding in his left hand the work to be enamelled, or the brass or iron-wires the figures are to be formed on, he directs with his right the enamel thread, which he holds to the flame with a management and patience equally surprising. There are few things they cannot make or represent with enamel; and some figures are as well finished, as if done by the most skilful carvers.
- ENARTHROSIS**, in anatomy, a species of diarthrosis. See *ΑΝΑΤΟΜΗ*, Part I.
- ENCÆNIA**, the name of three several feasts celebrated by the Jews in memory of the dedication, or rather purification, of the temple, by Judas Maccabæus, Solomon, and Zorobabel.
- This term is likewise used in church-history for the dedication of Christian churches.
- ENCAMPMENT**, the pitching of a camp. See *CAMP*.
- ENCANTHIS**, in surgery, a tubercle arising either from the *caruncula lacrymalis*, or from the adjacent red skin; sometimes so large, as to obstruct not only the *puncta lacrymalia*, but also part of the sight, or pupil itself. See *SURGERY*.
- ENCAUSTIC** and **ENCAUSTUM**, the same with enamelling and enamel. See *ENAMELLING*, and *ENAMEL*.
- ENCEINTE**, in fortification, is the wall or rampart which surrounds a place, sometimes composed of bastions or curtains, either faced or lined with brick or stone, or only made of earth. The enceinte is sometimes only flanked by round or square towers, which is called a Roman wall.
- ENCEPHALI**, in medicine, worms generated in the head, where they cause so great a pain, as sometimes to occasion distraction.
- ENCEPPE'**, in heraldry, denotes fettered, chained, or girt about the middle, as is usual with monkeys.
- ENCHANTER**, a person supposed to practise enchantment or fascination. See *FASCINATION*, *WITCHCRAFT*, &c.
- ENCHANTER'S NIGHTSHADE**, in botany. See *CIRCÆA*.
- ENCHASING**, **INCHASING**, or **CHASING**, the art of enriching and beautifying gold, silver, and other metal-work, by some design or figures represented thereon in low relieve.
- Enchasing is practised only on hollow thin works, as watch-cases, cane-heads, tweezer cases, or the like. It is performed by punching or driving out the metal, to form a figure, from with-inside, so as to stand out prominent from the plane or surface of the metal. In order to this, they provide a number of fine steel blocks, or puncheons, of divers sizes; and the design being drawn on the surface of the metal, they apply the inside upon the heads or tops of these blocks, directly under the lines or parts of the figures; then, with a fine hammer, striking on the metal, sustained by the block, the metal yields, and the block makes an indenture or cavity on the inside, corresponding to which there is a prominence on the outside, which is to stand for that part of the figure.
- Thus the workmen proceeds to chafe and finish all the parts by successive application of the block and hammer to the several parts of the design. And it is wonderful to consider with what beauty and justness, by this simple piece of mechanism, the artists in this kind will represent foliages, grotesques, animals, histories, &c.
- ENCHYSMA**, in medicine, the same with enema. See *ENEMA*.
- ENCLITICA**, in grammar, particles which are so closely united with other words, as to seem part of them, as in *virumque*, &c.
- There are three enclitic particles in Latin, viz. *que*, *ne*, *ve*.
- ENCRATITES**, in church-history, heretics who appeared towards the end of the second century: they were called Encratites, or *Continentes*, because they gloried in abstaining from marriage and the use of wine and animal-food.
- ENCYCLOPÆDIA**. See *CYCLOPÆDIA*, and *DICTIONARY*.
- ENDECERIS**, in antiquity, denotes a vessel or galley with eleven tires of oars.
- ENDEMIC**, or **ENDEMICAL DISEASES**, those to which the inhabitants of particular countries are subject more than others, on account of the air, water, situation, and manner of living.
- ENDIVE**, in botany. See *CICHORIUM*.
- ENDLESS**, something without an end: thus authors mention endless rolls, the endless screw, &c.
- ENDORSE**, in heraldry, an ordinary, containing the eighth part of a pale, which Leigh says is only used when a pale is between two of them.
- ENDORSED**, in heraldry, is said of things borne back to back, more usually called *adosé*. See *ADOSÉ'*.
- ENDOWMENT**, in law, denotes the settling a dower on a woman; though sometimes it is used figuratively, for settling a provision upon a parson, on the building of a church; or the severing a sufficient portion of tithes for a vicar, when the benefice is appropriated.
- ENEMA**, in medicine. See *CLYSTER*.
- ENEMY**, in law, an alien or foreigner, who publicly invades the kingdom.
- ENERGUMENS**, in church history, persons supposed to be possessed by the devil, concerning whom there were many regulations among the primitive Christians. They were denied baptism, and the eucharist; at least, this was the practice of some churches: and though they were under the care of exorcists, yet it was thought



thought a becoming act of charity to let them have the public prayers of the church, at which they were permitted to be present. See EXORCISM.

**ENERGY**, a term of Greek origin, signifying the power, virtue, or efficacy of a thing. It is also used, figuratively, to denote emphasis of speech.

**ENFILADE**, in the art of war, is used in speaking of trenches, or other places, which may be scoured by the enemy's shot along their whole length. In conducting the approaches at a siege, care must be taken that the trenches be not enfiladed from any work of the place. See TRENCHES.

**ENFRANCHISEMENT**, in law, the incorporating a person into any society or body politic.

**ENGASTRIMYTHI**, in Pagan theology, the Pythians, or priestesses of Apollo, who delivered oracles from within, without any action of the mouth or lips.

The ancient philosophers, &c. are divided upon the subject of the engastrimythi. Hippocrates mentions it as a disease. Others will have it a kind of divination. Others attribute it to the operation or possession of an evil spirit. And others to art and mechanism. M. Scottus maintains that the engastrimythi of the ancients were poets, who, when the priests could not speak, supplied the defect by explaining in verse what Apollo dictated in the cavity of the bason on the sacred tripod.

**ENGENDERING**, a term sometimes used for the act of producing or forming any thing: thus meteors are said to be engendered in the middle region of the atmosphere, and worms in the belly. See GENERATION.

**ENGERS**, the capital of a county of the same name, in Germany, situated on the river Rhine, about seven miles north of Coblenz.

**ENGHIEN**, a city of Hainalt, about fourteen miles south-west of Brussels.

**ENGINA**, an island on the north-east of the Morea, about fifty miles east of Corinth.

**ENGINE**, in mechanics, is a compound machine, made of one or more mechanical powers, as levers, pulleys, screws, &c. in order to raise, cast, or sustain any weight, or produce any effect which could not be easily effected otherwise. See MECHANICS.

**ENGINE for extinguishing fires**. See HYDROSTATICS, and HYDRAULICS.

**Pile-ENGINE**, one contrived for driving piles. See MECHANICS.

**Steam-ENGINE**, a machine to raise water by fire, or rather by the force of water turned into steam. See HYDROSTATICS, and HYDRAULICS.

**ENGINEER**, in the military art, an able expert man, who, by a perfect knowledge in mathematics, delineates upon paper, or marks upon the ground, all sorts of forts, and other works proper for offence and defence. He should understand the art of fortification, so as to be able, not only to discover the defects of a place, but to find a remedy proper for them; as also how to make an attack upon, as well as to defend, the place. Engineers are extremely necessary for these purposes: wherefore it is requisite that, besides being ingenious,

VOL. II. No. 46.

†

they should be brave in proportion. When at a siege the engineers have narrowly surveyed the place, they are to make their report to the general, by acquainting him which part they judge the weakest, and where approaches may be made with most success. Their business is also to delineate the lines of circumvallation and contravallation, taking all the advantages of the ground; to mark out the trenches, places of arms, batteries, and lodgments, taking care that none of their works be flanked or discovered from the place. After making a faithful report to the general of what is a-doing, the engineers are to demand a sufficient number of workmen and utensils, and whatever else is necessary.

**ENGLAND**, the southern division of Great Britain, situated in the Atlantic ocean, between 2° E. and 6° W. longitude, and between 49° 55' and 55° 55' N. latitude.

There are in England, including Wales, fifty-two counties, two archbishoprics, twenty-four bishoprics, two universities, twenty-nine cities, upwards of eight hundred towns, and near ten thousand parishes; supposed to contain about 7,000,000 of people.

**New ENGLAND**, comprehending the colonies of Massachusetts, New Hampshire, Connecticut, Rhode-Island, and Providence-Plantation, is situated between 67° and 73° W. longitude, and between 41° and 45° N. latitude.

**ENGLISH**, or the **ENGLISH TONGUE**, the language spoken by the people of England, and, with some variation, by those of Scotland, as well as part of Ireland, and the rest of the British dominions.

The ancient language of Britain is generally allowed to have been the same with the Gaulic, or French; this island, in all probability, having been first peopled from Gallia, as both Cæsar and Tacitus affirm, and prove by many strong and conclusive arguments, as by their religion, manners, customs, and the nearness of their situation. But now we have very small remains of the ancient British tongue, except in Wales, Cornwall, the islands and highlands of Scotland, part of Ireland, and some provinces of France; which will not appear strange, when what follows is considered.

Julius Cæsar, some time before the birth of our Saviour, made a descent upon Britain, though he may be said rather to have discovered than conquered it; but, about the year of Christ 45, in the time of Claudius, Aulus Plautius was sent over with some Roman forces, by whom two kings of the Britons, Cogidunus and Caractacus, were both overcome in battle: whereupon a Roman colony was planted at Malden in Essex, and the southern parts of the island were reduced to the form of a Roman province: after that, the island was conquered as far north as the friths of Dumbarton and Edinburgh, by Agricola, in the time of Domitian; whereupon, a great number of the Britons, in the conquered part of the island, retired to the west part called Wales, carrying their language with them.

The greatest part of Britain being thus become a Roman province, the Roman legions, who resided in Britain for above two hundred years, undoubtedly dis-

seminated

2

5 1

feminated the Latin tongue; and the people being afterwards governed by laws written in Latin, must necessarily make a mixture of languages. This seems to have been the first mutation the language of Britain suffered.

Thus the British tongue continued, for some time, mixed with the provincial Latin, till, the Roman legions being called home, the Scots and Picts took the opportunity to attack and harrafs England: upon which, K. Vortigen, about the year 440, called the Saxons to his assistance, who came over with several of their neighbours, and having repulsed the Scots and Picts, were rewarded for their services with the isle of Thanet, and the whole county of Kent; but growing too powerful, and not being contented with their allotment, dispossessed the inhabitants of all the country on this side of the Severn: thus the British tongue was in a great measure destroyed, and the Saxon introduced in its stead.

What the Saxon tongue was long before the conquest, about the year 700, we may observe in the most ancient manuscripts of that language, which is a gloss on the Evangelists, by bishop Edfrid, in which the three first articles of the Lord's prayer runs thus.

" Uren fader thic arth in heofnas, sic gehalgud thin  
" noma, so cymeth thin ric. Sic thin willa sue is  
" heofnas, and in eorho, &c."

In the beginning of the ninth century the Danes invaded England; and getting a footing in the northern and eastern part of the country, their power gradually increased, and they became sole masters of it in about two hundred years. By this means the ancient British obtained a tincture of the Danish language: but their government being of no long continuance, did not make so great an alteration in the Anglo-Saxon, as the next revolution, when the whole land, *A. D.* 1067, was subdued by William the Conqueror, duke of Normandy in France: for the Normans, as a monument of their conquest, endeavoured to make their language as generally received as their commands, and thereby rendered the British language an entire medley.

About the year 900, the Lord's prayer, in the ancient Anglo-Saxon, ran thus:

" Thuc ur fader the cart on heofenum, si thin na-  
" ma gehalgod; cume thin rice si thin willa on eorhan  
" swa, swa on heofenum, &c."

About the year 1160, under Henry II. it was rendered thus by pope Adrian, an Englishman, in rhyme:

" Ure fader in heaven riche,  
" Thy name be halyed ever lich,  
" Thou bring us thy michell blisse:  
" Als hit in heaven y-doe,  
" Evar in yearth beene it also, &c."

Dr Hicks gives us an extraordinary specimen of the English as spoken in the year 1385, upon the very subject of the English tongue.

" As it is knowe how meny maner peple beeth in  
" this lond; ther beeth also so many dyvers longages  
" and tonges. Notheles Walschemen and Scots that  
" beeth nought medled with other nation, holdeth wel

" nyh hir firste longage and speche; but yif the Scottes,  
" that were sometime confederate and woned with the  
" Pictes, drawe somewhat after hir speche; but the  
" Flemynge, that woneth on the weste side of Wales,  
" haveth lost her strange spech, and spekethe Sexon-  
" liche now. Also Englishemen, they had from the  
" bygyunnyge thre maner speche: northerne, sou-  
" therne, and middel speche in the middel of the  
" lond, as they come of thre maner of peppe of Ger-  
" mania: notheles by commyxtion and mellynge first  
" with Danes, and afterwards with Normans, in meny  
" the contrary longage is apayrcd (*corrupted*.)

" This apayrynge of the burth of the tunge is bycause  
" of tweie thinges; oon is for children in scole gent-  
" the usuage and maner of all other nation, beeth  
" compelled for to leve hire own longage, and for to  
" construe hir lessons and here thynges in French, and  
" so they haveth sethe Normans come first into Eng-  
" lond. Also gentlemen children beeth taught to  
" speke Frensche from the tyme that they beeth rok-  
" ked in here cradel, and kunneth speke and play  
" with a childes broche; and uplondische men will  
" lykne hymself to gentilmen, and fondeth with great  
" besynesse for to speak Frensche to be told of.—Hit  
" seemeth a greet wonder how Englishemen and her  
" own longage and tonge is so dyverse of sown in this  
" oon ilond: and the longage of Normandie is com-  
" lynge of another lond, and hath oon maner soun  
" amonge alle men that spekethe hit arigt in Engeland.  
" Also of the foresaid Saxon tonge that is deled (*di-  
" vided*) a three, and is abide scarceliche with fewe  
" uplondische men is greet wonder. For men of the  
" est, with men of the west, is, as it were, undir  
" the same partie of hevene acordeth more in sown-  
" ynge of speche, than men of the north, with men  
" of the south. Therefore it is that Mercii, that  
" beeth men of myddel Engeland, as it were, par-  
" teners of the endes, underfondeth better the side  
" longages northerne and southerne, than northerne or  
" southerne underfondeth either other.—All the lon-  
" gage of the Northumbers and spechialliche at York,  
" is so scharp, slitting and froynge, and unshape, that  
" we southerne men may that longage unnethe un-  
" derstonde, &c." *Hicks's Thesaur. liter sept.*

In the year 1537, the Lord's prayer was printed as follows: " O our Father which arte in heven, ha-  
" lowed be thy name: let thy kingdome come, thy  
" will be fulfilled as well in erth as it is in heven;  
" geve us this daye in dayly bred, &c." Where it  
" may be observed that the diction is brought almost to  
" the present standard, the chief variations being only  
" in the orthography. By these instances, and many o-  
" thers that might be given, it appears, that the English  
" Saxon language, of which the Normans despoiled us  
" in a great measure, had its beauties, was significant and  
" emphatical, and preferable to what they imposed on us.  
" Great, verily," says Camden, " was the glory of our  
" tongue before the Norman conquest, in this, that the  
" old English could express, most aptly, all the concep-  
" tions of the mind in their own tongue, without bor-  
" rowing from any." Of this he gives several examples.

Having

Having thus shewn how the ancient British language was in a manner extirpated by the Romans, Danes, and Saxons, and succeeded by the Saxon, and after that the Saxon blended with the Norman French, we shall now mention two other causes of change in the language: the first of these is owing to the Britons having been a long time a trading nation, whereby offices, dignities, names of wares, and terms of traffic are introduced, which we take with the wares from the persons of whom we have them, and form them new, according to the genius of our own tongue; and besides this change in the language, arising from commerce, Britain's having been a considerable time subject to the see of Rome, in ecclesiastical affairs, must unavoidably introduce some Italian words among us. Secondly, as to the particular properties of a language, our tongue has undergone no small mutation, or rather has received no small improvement upon that account: for, as to the Greek and Latin, the learned have, together with the arts and sciences now rendered familiar among us, introduced abundance; nay, almost all the terms of art in the mathematics, philosophy, physic, and anatomy; and we have entertained many more from the Latin, French, &c. for the sake of neatness and elegance: so that, at this day, our language, which about 1800 years ago, was the ancient British, or Welch, &c. is now a mixture of Saxon, Teutonic, Dutch, Danish, Norman, and modern French, embellished with the Greek and Latin. Yet this, in our opinion, is so far from being a disadvantage to the English tongue, as now spoke (for all languages have undergone changes, and do continually participate with each other) that it has so enriched it, as now to become the most copious, significant, fluent, courteous, and masculine language in Europe, if not in the world.

**ENGRAFTING, or GRAFTING, in gardening.** See GARDENING.

**ENGRAILED, or INGRAILED, in heraldry,** a term derived from the French *grezly*, hail; and signifying a thing the hail has fallen upon and broke off the edges, leaving them ragged, or with half-rounds, or semicircles, struck out of their edges.

**ENGRAVING, the art of cutting metals and precious stones, and representing thereon figures, letters, or whatever device, or design, the artist fancies.**

Engraving, properly a branch of sculpture, is divided into several other branches, according to the matter whereon it is employed, and the manner of performing it.

The original way of engraving on wood is denominated at present, with us, by cutting in wood; that on metals with aquafortis, is named etching; that by the knife, burnisher, punch, and scraper, is called mezzotinto; that on stones for tombs, &c. stone-cutting; and that performed with the graver on metals or precious stones, keeps alone the primitive name of engraving, being that which we shall at present attend to.

**ENGRAVING on copper.** is employed in representing portraits, histories, landscapes, foliages, figures, build-

ings, &c. either after paintings, or designs for that purpose.

It is performed with the graver on a plate of copper, which, being well polished, is covered over thinly with virgin-wax, and then smoothed, while warm, with a feather, so that the wax be of an equal thickness on the plate; and on this the draught or design, done in black lead, red chalk, or unguimed ink, is laid with the face of the drawing on the wax: then they rub the backside, which will cause the whole design of the drawing to appear on the wax. The design, thus transferred, is traced through on the copper, with a point, or needle; then heating the plate, and taking off the wax, the strokes remain to be followed, heightened, &c. according to the tenor of the design, with the graver, which must be very sharp and well pointed.

In the conduct of the graver consists almost all the art, which depends not so much upon rules as upon practice, the habitude, disposition, and genius of the artist, the principles of engraving being the same with those of painting; for if an engraver be not a perfect master of design, he can never hope to arrive at a degree of perfection in this art. In conducting the strokes, or cuts, of the graver, he must observe the action of the fingers, and of all their parts, with their outlines; and remark how they advance towards, or fall back from his sight, and then conduct his graver according to the risings or cavities of the muscles, or folds, widening the strokes in the light, and contracting them in the shades; as also at the extremity of the outlines, to which he ought to conduct the cuts of the graver, that the figures or objects represented may not appear as if they gnawn, and lightening his hand, that the outlines may be perfectly found, without appearing cut or slit; and, although his strokes necessarily break off where a muscle begins, yet they ought always to have a certain connection with each other, so that the first stroke should often serve to make the second, because this will shew the freedom of the graver.

If hair be the subject, let the engraver begin his work by making the outlines of the principal locks, and sketch them out in a careless manner, which may be finished, at leisure, with finer and thinner strokes to the very extremities.

The engraver must avoid making very acute angles, especially in representing flesh, when he crosses the first strokes with the second, because it will form a very disagreeable piece of tabby-like lattice-work except in the representation of some clouds, in tempests, the waves of the sea, and in representations of skins of hairy animals, and leaves of trees. So that the medium between square and acute seems to be the best and most agreeable to the eye. He that would represent sculpture, must remember, that as statues, &c. are most commonly made of white marble, or stone, whose colour does not produce such dark shades as other matters do, they have no black to their eyes, nor hair of the head and beard lying in the air. If the engraver would

would preserve one quality and harmony in his works, he should always sketch out the principal objects of his piece before any part of them are finished.

The instruments necessary for this sort of engraving are, besides a graver, a cushion, or sand bag, made of leather, to lay the plate on, in order to give it the necessary turns and motions; a burnisher made of iron, or steel, round at one end, and usually flattish at the other, to rub out slips and failures, soften the strokes, &c.; a scraper, to pare off the surface, on occasion; and a rubber, of a black hat, or cloth rolled up, to fill up the strokes that they may appear the more visible.

*In ENGRAVING precious stones*, they use either the diamond, or the emery. The diamond, which is the hardest of all stones, is only cut by itself, or with its own matter. The first thing to be done in this branch of engraving, is to cement two rough diamonds to the ends of two sticks big enough to hold them steady in the hand, and to rub or grind them against each other till they be brought to the form desired. The dust or powder that is rubbed off serves afterwards to polish them, which is performed with a kind of mill that turns a wheel of soft iron. The diamond is fixed in a brass dish, and, thus applied to the wheel, is covered with diamond-dust, mixt up with oil of olives; and when the diamond is to be cut facet-wise, they apply first one face, then another, to the wheel. Rubies, sapphires, and topazes, are cut and formed the same way on a copper wheel, and polished with tripoli diluted in water. As to agates, amethysts, emeralds, hyacinths, granates, rubies, and others of the softer stones, they are cut on a leaden wheel, moistened with emery and water, and polished with tripoli, on a pewter wheel. Lapis-lazuli, opal, &c. are polished on a wooden wheel. To fashion and engrave vases of agate, crystal, lapis-lazuli, or the like, they make use of a kind of lathe, like that used by pewterers to hold the vessels, which are to be wrought with proper tools; that of the engraver generally holds the tools, which are turned by a wheel; and the vessel is held to them to be cut and engraved, either in relievo or otherwise; the tools being moistened, from time to time, with diamond dust and oil, or at least emery and water. To engrave figures or devices on any of these stones, when polished, such as medals, seals, &c. they use a little iron wheel, the ends of whose axis are received within two pieces of iron, placed upright, as in the turner's lathe; and to be brought closer, or set further apart, at pleasure: at one end of the axis are fitted the proper tools, being kept tight by a screw. Lastly. The wheel is turned by the foot, and the stone applied by the hand to the tool, and is shifted and conducted as occasion requires.

The tools are generally of iron, and sometimes of brass; their form is various, but it generally bears some resemblance to chissels, gouges, &c. Some have small round heads, like buttons, others like ferrels, to take the pieces out, and others flat, &c. when the stone has been engraven, it is polished on wheels of hair-brushes and tripoli.

*ENGRAVING on steel* is chiefly employed in cutting seals, punches, matrices, and dyes proper for striking coins, medals, and counters. The method of engraving with the instruments, &c. is the same for coins as for medals and counters: All the difference consists in their greater or less relievo, the relievo of coins being much less considerable than that of medals, and that of counters still less than that of coins.

Engravers in steel commonly begin with punches, which are in relievo, and serve for making the creux, or cavities, of the matrices and dyes: though sometimes they begin with the creux, or hollowness, but then it is only when the intended work is to be cut very shallow. The first thing done, is that of designing the figures; the next is the moulding them in wax, of the size and depth they are to lie, and from this wax the punch is engraven. When the punch is finished, they give it a very high temper, that it may the better bear the blows of the hammer with which it is struck to give the impresson to the matrix.

The steel is made hot to soften it, that it may the more readily take the impresson of the punch; and after striking the punch on it, in this state, they proceed to touch up or finish the strokes and lines; where by reason of their fineness or the too great relievo they are any thing defective, with steel gravers of different kinds, chissels, flatters, &c. being the principal instruments used in graving on steel.

The figure being thus finished, they proceed to engrave the rest of the medal, as the mouldings of the border, the engrailed ring, letters, &c. with little steel punches, well tempered, and very sharp.

*ENGUICHE'*, in heraldry, is said of the great mouth of a hunting horn, when its rim is of a different colour from that of the horn itself.

*ENGYSCOPE*, the same with microscope. See *MICROSCOPE*.

*ENHARMONIC*, in the ancient music, one of their genera or kinds of music, so called from its superior excellence; though wherein it consisted, says Mr Malcom, is hard to say: it was allowed by all to be so very difficult, that few could ever practise it.

*ENHYDRUS*, in natural history, a genus of siderochita or crustated ferrugineous bodies, formed in large and in great part empty cases, inclosing a small quantity of an aqueous fluid.

Of this genus there are only two species: 1. The thick-shelled enhydrus, with black, reddish-brown, and yellow crusts. 2. The thinner-shelled kind, with yellowish-brown and purple crusts; neither of which ferments with aqua fortis, or gives fire with steel.

*ENIXUM*, among chemists, a kind of neutral salt, generated of an acid and an alkali.

The sal enixum of Paracelsus, is the caput mortuum of spirits of nitre with oil of vitriol, or what remains in the retort after the distillation of this spirit; being of a white colour, and pleasing acid taste.

*ENMANCHE'*, in heraldry, is when lines are drawn from the centre of the upper edge of the chief to the sides, to about half the breadth of the chief; signifying

- fyng sleeved, or resembling a sieve, from the French *manche*.
- ENNEAGON**, in geometry, a polygon with nine sides. See **POLYGON**.
- ENNEAHEDRIA**, in natural history, a genus of columnar, crystalliform, and double-pointed spars, composed of a trigonal column, terminated at each end by a trigonal pyramid.
- Of this genus there are several species, distinguished by the length or shortness of the column and pyramids, none of which will give fire with steel, but all of them ferment with aqua fortis. See **SPAR**.
- ENNEANDRIA**, in botany. See **BOTANY**, p. 635. and Plate LIII. fig. 9.
- ENS**, among metaphysicians, denotes entity, being, or existence: this the schools call *ens reale*, and *ens positivum*, to distinguish it from their *ens rationis*, which is only an imaginary thing, or exists only in the imagination.
- ENS**, among chemists, imports the power, virtue, and efficacy which certain substances exert upon our bodies.
- ENS**, in geography, a city of Germany, situated at the confluence of the Danube and the river Ens, about eighty miles south of Vienna: E. long. 14° 20', N. lat. 48° 16'.
- ENSEELED**, in falconry, is said of a hawk that has a thread drawn through her upper eye-lid, and made fast under her beak, to take away the sight.
- ENSIGN**, in the military art, a banner under which the soldiers are ranged according to the different companies or parties they belong to.
- ENSIGN** is also the officer that carries the colours, being the lowest commissioned officer in a company of foot, subordinate to the captain and lieutenant.
- ENSISEIM**, a town of Germany, in the landgraviate of Alsace, about fifty miles south of Strasburg: E. long. 7° 30', N. lat. 47° 50'.
- ENSKIRKEN**, a town of Germany, fifteen miles south-west of Cologne.
- ENTABLATURE**, or **ENTABLEMENT**, in architecture, is that part of an order of a column which is over the capital, and comprehends the architrave, frieze, and cornice. See **ARCHITECTURE**.
- ENTABLER**, in the menage, the fault of a horse whose croupe goes before his shoulders in working upon volts; which may be prevented by taking hold of the right rein, keeping your right leg near, and removing your left leg as far from the horse's shoulder as possible.
- This is always accompanied with another fault called *aculer*. See **ACULER**.
- ENTAIL**. See **TAILLIE**.
- ENTE'**, in heraldry, a method of marshalling, more frequent abroad than with us, and signifying grafted or ingrafted.
- We have, indeed, one instance of *enté* in the fourth grand quarter of his majesty's royal ensign, whose blazon is Brunswick and Lunenburg impaled with ancient Saxony, *enté en pointé*, grafted in point.
- ENTELECHIA**, a word used by Aristotle to express
- the soul, and which, not occurring in any other author, has given the commentators upon that philosopher great trouble to discover its true meaning.
- ENTEROCÉLE**, in surgery, a tumor formed by a prolapsion of the intestines through the rings of the abdomen, and processes of the peritonæum, into the scrotum. See **SURGERY**.
- ENTEROLOGY**, a term used by physicians, for a discourse or treatise on the contents of the head, breast, and abdomen.
- ENTEROMPHALUS**, the same with a hernia umbilicalis, or rupture at the navel.
- ENTERSOLE**, in architecture, a kind of little story, sometimes called a mezzanine, contrived occasionally at the top of the first story, for the conveniency of a wardrobe, &c.
- ENTHUSIASM**, a transport of the mind, whereby it is led to think and imagine things in a sublime, surprising, yet probable manner. This is the enthusiasm felt in poetry, oratory, music, painting, sculpture, &c.
- ENTHUSIASM**, in a religious sense, implies a transport of the mind, whereby it fancies itself inspired with some revelation, impulse, &c. from heaven.
- ENTHUSIAST**, a person possessed with enthusiasm. See the preceding article.
- ENTHYMEME**, among logicians, denotes a syllogism, perfect in the mind, but imperfect in the expression, by reason one of the propositions is suppressed, as being easily supplied by the understanding of those with whom we discourse.
- ENTOMON**, in zoology. See **ONISCUS**.
- ENTREPAS**, in the manege, a broken pace or going, that is neither walk nor trot, but has somewhat of an amble.
- This is a pace or gait of such horses as have no reins or back, and go upon their shoulders; or, of such as are spoiled in their limbs.
- ENTRING-LADDERS**, in a ship, are of two sorts; one used by the vessel's sides, in a harbour, or in fair weather, for persons to go in and out of the ship: the other is made of ropes, with small staves for steps; and is hung out of the gallery to enter into the boat, or to come aboard the ship, when the sea runs so high that they dare not bring the boat to the ship's side for fear of staving it.
- ENTROCHUS**, in natural history. See **ISIS**.
- ENTRY of an heir**, in Scots law, that form of law by which an heir vests in himself a proper title to his predecessor's estate. See *Precept of CLARE CONSTAT*.
- Bill of ENTRY**, in commerce. See **BILL**.
- In making entries inwards, it is usual for merchants to include all the goods they have on board the same ship in one bill, though sometimes they may happen to be upwards of twenty several kinds; and in case the goods are short entered, additional or post entries are now allowed; though formerly the goods, so entered, were forfeited. As to bills of entry outwards, or including goods to be exported, upon delivering them, and paying the customs, you will receive a small piece

of parchment called a cocker, which testifies your payment thereof, and all duties for such goods.

If several sorts of goods are exported at once, of which some are free, and others pay customs; the exporter must have two cockets, and therefore must make two entries; one for the goods that pay, and the other for the goods that do not pay custom.

Entries of goods, on which a drawback is allowed, must likewise contain the name of the ship in which the goods were imported, the importer's name, and time of entry inwards. The entry being thus made, and an oath taken that the customs for those goods were paid as the law directs, you must carry it to the collector and comptroller, or their deputies; who, after examining their books, will grant warrant, which must be given to the surveyor, searcher, or land-waiter, for them to certify the quantity of goods; after which the certificate must be brought back to the collector and comptroller, or their deputies, and oath made that the said goods are really shipped, and not landed again in any part of Great Britain.

**ENVELOPE**, in fortification, a work of earth, sometimes in form of a simple parapet, and at others like a small rampart with a parapet: it is raised sometimes on the ditch, and sometimes beyond it.

**ENVIRONNE'**, in heraldry, signifies surrounded with other things: thus, they say, a lion environné with so many bezants. See **BEZANT**.

**ENUMERATION**, an account of several things, in which mention is made of every particular article.

**ENVOY**, a person deputed to negotiate some affair with any foreign prince or state. Those sent from the courts of France, Britain, Spain, &c. to any petty prince or state, such as the princes of Germany, the republics of Venice, Genoa, &c. go in quality of envoys, not ambassadors; and such a character only do those persons bear, who go from any of the principal courts of Europe to another, when the affair they go upon is not very solemn or important. There are envoys ordinary and extraordinary, as well as ambassadors; they are equally the same under the protection of the law of nations, and enjoy all the privileges of ambassadors, only differing from them in this, that the same ceremonies are not performed to them.

**ENVY**, in ethics, an uneasiness of the mind, caused by the consideration of a good we desire, obtained by one we think less worthy of it than ourselves. See **PASSION**, and **MORALS**.

**EPACT**. See **ASTRONOMY**, *Of the Division of Time*.

**EPANORTHOSIS**, in rhetoric, a figure by which a person corrects, or ingeniously revokes, what he just before alledged, as being too weakly expressed, in order to add something stronger, and more conformable to the passion with which he is agitated.

The epanorthosis is distinguished into two kinds. The one is when we correct or revoke the word, as in the following example of the apostle, *But I laboured more abundantly than they all: yet not I, but the grace of God, which was with me*, 1 Cor. xv. 10. where, what he first attributed to his own merit, he chuses afterwards to call the work of grace, as being

the principal cause. The second kind of epanorthosis, is when we correct or revoke the sentiment, as in the following of Cicero: *Italiam ornare, quam domum suam, nihil: quarequam, Italia ornata, domus ipsa mihi videtur ornatio.*

**EPARER**, in the menage, signifies the flinging of a horse, or his jerking and striking with his hind-legs.

**EPAULEMENT**, in fortification, a work raised to cover side-wise, is either of earth, gabions, or fascines loaded with earth. The epaulements of the places of arms for the cavalry, at the entrance of the trenches, are generally of fascines mixed with earth.

**EPENTHESIS**, in grammar, the interposition or insertion of a letter or syllable in the middle of a word; as *alittuum*, for *alitum*; *relligio*, for *religio*; *induprator*, for *imperator*, &c.

**EPERLANUS**, in ichthyology. See **SALMO**.

**EPHA**, or **EPHAAH**, in Jewish antiquity, a measure for things dry, containing 1.0961 of a bushel.

**EPHÆTUM**, in botany. See **RANUNCULUS**.

**EPHEDRA**, the **SEA-GRAPE**, or **SHRUB HORSE TAIL**, in botany, a genus of the dioecia monadelphia class. The calix of the amentum of the male and female is divided into segments; the corolla is wanting in both; the stamina are seven; there are two pistils, and two seeds covered with a kind of cup-berry. There are two species, none of them natives of Britain.

**EPHEMERY**, in medicine, the name of a species of fever continuing the space of one day, or sometimes more; for the medical writers express themselves by *ephemera simplex. vel plurium dierum*. See **MEDICINE**.

**EPHEMERA**, the **DAY-FLY**, in zoology, a genus belonging to the order of neuroptera. It has no teeth or palpi; there are two large protuberances above the eyes; the wings are erect, the two hind ones being largest; and the tail is bristly. There are eleven species, distinguished by their colour and the number of bristles in their tail. This fly derives its name from the circumstance of its living but one day.

**EPHEMERIDES**, in literary history, an appellation given to those books or journals, which shew the motions and places of the planets for every day of the year.

It is from the tables contained in these ephemerides that eclipses, and all the variety of aspects of the planets, are found.

**EPHEMERUM**, in botany. See **TRADESCANTIA**.

**EPHIALTES**, in medicine, the same with the incubus, or night-mare. See **INCUBUS**.

**EPHIPPUIM**, in anatomy. See **ANATOMY**, Part I.

**EPHOD**, in Jewish antiquity, one part of the priestly habit; being a kind of girdle, which, brought from behind the neck over the two shoulders, and hanging down before, was put cross the stomach, then carried round the waist, and made use of as a girdle to the tunic.

There were two sorts of ephods, one of plain linen for the priests, and the other embroidered for the high priest.

**EPHORI**, in Grecian antiquity, magistrates established

in

in ancient Sparta to balance the regal power. The authority of the ephori was very great. They sometimes expelled and even put to death the kings, and abolished or suspended the power of the other magistrates, calling them to account at pleasure. There were five of them, others say nine. They presided in the public shows and festivals. They were entrusted with the public treasure, made war and peace, and were so absolute, that Aristotle makes their government equal to the prerogative of a monarchy. They were established by Lycurgus.

**EPHYDRUM**, in botany. See **EQUISETUM**.

**EPIC**, or **HEROIC POEM**. See **COMPOSITION**.

**EPICEDIUM**, in ancient poetry, a poem rehearsed during the funeral solemnity of persons of distinction.

**EPICOENE**, in grammar, a term applied to nouns, which, under the same gender and termination, mark indifferently the male and female species.

**EPICUREAN PHILOSOPHY**, the doctrine or system of philosophy maintained by Epicurus and his followers.

His philosophy consisted of three parts, canonical, physical, and ethereal. The first was about the canons, or rules of judging. The censure which Tully passes upon him for his despising logic, will hold true only with regard to the logic of the stoics, which he could not approve of, as being too full of nicety and quirk. Epicurus was not acquainted with the analytical method of division and argumentation, nor was he so curious in modes and formation as the stoics. Soundness and simplicity of sense, assisted with some natural reflections, was all his art. His search after truth proceeded only by the senses, to the evidence of which he gave so great a certainty, that he considered them as an infallible rule of truth, and termed them the first natural light of mankind.

In the second part of this philosophy he laid down atoms, space, and gravity, as the first principles of all things: he did not deny the existence of God, but thought it beneath his majesty to concern himself with human affairs: he held him a blessed immortal being, having no affairs of his own to take care of, and above meddling with those of others.

As to his ethics, he made the supreme good of man to consist in pleasure, and consequently supreme evil in pain. Nature itself, says he, teaches us this truth, and prompts us from our birth to procure whatever gives us pleasure, and avoid what gives us pain. To this end he proposes a remedy against the sharpness of pain: this was to divert the mind from it, by turning our whole attention upon the pleasures we have formerly enjoyed: he held that the wife man must be happy, as long as he is wise; that pain, not depriving him of his wisdom, cannot deprive him of his happiness.

There is nothing that has a fairer show of honesty than the moral doctrine of Epicurus. Gassendus pretends, that the pleasure in which this philosopher has fixed the sovereign good, was nothing else but the highest tranquillity of mind in conjunction with the most perfect health of body: but Tully, Horace, and

Plurarch, as well as almost all the fathers of the church, give us a very different representation: indeed the nature of this pleasure, in which the chief happiness is supposed to be seated, is a grand problem in the morals of Epicurus. Hence there were two kinds of Epicureans, the rigid and the remiss: the first were those who understood Epicurus's notion of pleasure in the best sense, and placed all their happiness in the pure pleasures of the mind, resulting from the practice of virtue: the loose or remiss Epicureans, taking the words of that philosopher in a gross sense, placed all their happiness in bodily pleasures or debauchery.

**EPICYCLE**, in the ancient astronomy, a little circle whose centre is in the circumference of a greater circle; or it is a small orb, or sphere, which being fixed in the deferent of a planet, is carried along with it; and yet, by its own peculiar motion, carries the planet fastened to it round its proper centre.

It was by means of epicycles, that Ptolemy and his followers solved the various phenomena of the planets, but more especially their stations and retrogradations.

**EPICYCLOID**, in geometry, a curve generated by the revolution of the periphery of a circle, along the convex or concave side of the periphery of another circle.

**EPICYEMA**, among physicians, denotes a superfluousness; being a false conception or mole happening after the birth of a regular fœtus.

**EPIDEMIA**, in Grecian antiquity, festivals kept in honour of Apollo and Diana, at the stated seasons when these deities, who could not be present every where, were supposed to visit different places, in order to receive the vows of their adorers.

**EPIDEMIC**, among physicians, an epithet of diseases which at certain times are popular; attacking great numbers at or near the same time. See **MEDICINE**.

**EPIDENDRUM**, in botany, a genus of the gynandria diandria class. The nectarium is oblique, reflected, and shaped like a turban. There are thirty species, none of them natives of Britain.

**EPIDERMIS**, in anatomy. See **ANATOMY**, p. 255.

**EPIDIDYMIS**, in anatomy. See **ANATOMY**, p. 171.

**EPIGASTRIC REGION**, a part or subdivision of the abdomen. See **ANATOMY**, p. 256.

**EPIGLOTTIS**, in anatomy, one of the cartilages of the larynx, or wind-pipe. See **ANATOMY**, p. 281.

**EPIGRAM**, in poetry, a short poem in verse, treating only of one thing, and ending with some lively, ingenious, and natural thought or point.

**EPIGRAPHE**, among antiquarians, denotes the inscription of a building, pointing out the time when, the persons by whom, the uses, and the like, for which it was erected.

**EPILEPSY**, in medicine, the same with what is otherwise called the falling-sickness, from the patient's falling suddenly to the ground. See **MEDICINE**.

**EPILOBIUM**, in botany, the **WILLOW HERB**, a genus of the octandria monogynia class. The calix is divided into four segments, and the corolla consists of four petals; the capsule is oblong and below the flower; and the seeds are pappous. There are seven species, all of them natives of Britain, *viz.* the angustifolium, or rosebay

- rosebay willow herb; the hirsutum, or small flowered hairy willow herb; the ramosum, great flowered willow herb, or codlings and cream; the montanum, or smooth-leaved willow herb; the tetragonum, or narrow-leaved willow-herb; the palustre, or marsh willow herb; and the alpinum, or mountain willow-herb.
- EPILOGUE**, in oratory, the end or conclusion of a discourse, ordinarily containing a recapitulation of the principal matters delivered.
- EPILOGUE**, in dramatic poetry, a speech addressed to the audience after the play is over, by one of the principal actors therein, usually containing some reflections on certain incidents in the play, especially those in the part of the person that speaks it.
- EPIEDIUM**, **BARREN-WORT**, in botany, a genus of the tetrandia monogynia class. It has four cap-shaped nectaria lying upon the petals; the corolla consists of four petals; and the calix is caducous. There is but one species, a native of Germany.
- EPIPHANY**, a Christian festival, otherwise called the Manifestation of Christ to the Gentiles, observed on the sixth of January, in honour of the appearance of our Saviour to the three magi, or wise-men, who came to adore him and bring him presents. The feast of epiphany was not originally a distinct festival, but made a part of that of the nativity of Christ, which being celebrated twelve days, the first and last of which were high or chief days of solemnity, either of these might properly be called epiphany, as that word signifies the appearance of Christ in the world.
- EPIPHONEMA**, in rhetoric, a sententious exclamation containing a lively remark placed at the end of a discourse or narration.
- EPIPHORA**, in medicine, a preternatural defluxion of the eyes, when they continually discharge a sharp ferrous humour, which excoriates the cheeks. See **MEDICINE**.
- EPIPHYSIS**, in anatomy. See **ANATOMY**, Part I.
- EPIPLOCELE**, in medicine, is a kind of hernia, or rupture, in which the omentum subsides into the scrotum.
- EPIPLOMPHALON**, in medicine, an hernia umbilicalis, proceeding from the omentum falling into the region of the umbilicus or navel.
- EPIPLOON** See **OMENTUM**
- EPISCOPACY**, the quality of episcopal government, or that form of church-discipline, wherein diocesan bishops are established distinct from and superior to priests or presbyters. See **BISHOP**.
- EPISCOPAL**, something belonging to bishops.
- EPISCOPALIANS**, in church-history, an appellation given to those who prefer the episcopal government and discipline to all others.
- By the test act, none but episcopalians, or members of the church of England, are qualified to enjoy any office civil or military.
- EPISCOPUS**. See **BISHOP**.
- EPISODE**, in poetry, a separate incident, story, or action, which a poet invents, and connects with his principal action, that his work may abound with a greater diversity of events; though, in a more limited sense, all the particular incidents whereof the action or narration is compounded, are called episodes. See **COMPOSITION**.
- EPISPASTIC**, in medicine, a topical remedy, which being applied to the external parts of the body, attracts the humours to that part.
- EPISTATES**, in the Athenian government, was the president of the proedri. See **PROEDRI**.
- EPISTEMONARCH**, in the ancient Greek church, an officer of great dignity, who had the care of every thing relating to faith, in the quality of censor. His office answered pretty nearly to that of master of the sacred palace at Rome.
- EPISTLE**, denotes the same with a missive letter; but is now chiefly used in speaking of ancient writings, as the epistles of St Paul, epistles of Cicero, epistles of Pliny, &c.
- EPISTOLARY**, something belonging to an epistle. See **EPISTLE**.
- EPISTROPHE**, in rhetoric, a figure, wherein that which is supposed of one thing, is strongly affirmed of another: thus, *Are they Hebrews? so am I. Are they Israelites? so am I. Are they of the seed of Abraham? so am I, &c.*
- EPISTYLE**, in the ancient architecture, a term used by the Greeks for what we call architrave, viz. a massive piece of stone or wood, laid immediately over the capital of a column.
- EPITAPH**, a monumental inscription in honour or memory of a person defunct, or an inscription engraven or cut on a tomb, to mark the time of a person's decease, his name, family; and, usually, some eulogium of his virtues, or good qualities.
- EPITASIS**, in ancient poetry, the second part or division of a dramatic poem, wherein the plot, entered upon in the first part, or protasis, was carried on, heightened, and worked up, till it arrived at its state, or height, called catastasis.
- EPITASIS**, in medicine, the increase of a disease, or beginning of a paroxysm, particularly in a fever.
- EPIPHALAMIUM**, in poetry, a nuptial song, or composition, in praise of the bride and bridegroom, praying for their prosperity, for a happy offspring, &c.
- Among the Greeks, the married couple were no sooner bedded, than the young men and maids gathered round the door, dancing and singing the epithalamium, shouting and stamping with their feet, with intention to drown the maid's cries.
- EPITHEM**, in pharmacy, a kind of fomentation, or remedy of a spirituous or aromatic kind, applied externally to the regions of the heart, liver, &c. to strengthen and comfort the same, or to correct some intemperature thereof. See **FUMENTATION**.
- EPITHET**, in poetry and rhetoric, an adjective expressing some quality of a substantive to which it is joined; or such an adjective as is annexed to substantives by way of ornament and illustration, not to make up an essential part of the description. Nothing, says Aristotle, tires the reader more than too great a redundancy of epithets, or epithets placed improperly; and yet nothing



nothing is so essential in poetry as a proper use of them. The writings of the best poets are full of them, especially Virgil.

**EPITHOME**, in literary history. See **ABRIDGEMENT**.

**EPITRITUS**, in prosody, a foot consisting of three long syllables and one short.

**EPIZEUXIS**, in rhetoric, a figure which repeats the same word, without any other intervening; such is that of Virgil, *Nunc, nunc, insurgite remis*.

**EPOCHA**, in chronology, a term or fixed point of time, whence the succeeding years are numbered or accounted. See **ASTRONOMY**, p. 487.

**EPODE**, in lyric poetry, the third or last part of the ode; the ancient ode being divided into strophe, antistrophe, and epode. See **ODE**.

**EPOPOEIA**, in poetry, the story, fable, or subject treated of in an epic poem.

**EPOTIDES**, in the naval architecture of the ancients, two thick blocks of wood, one on each side the prow of a galley, for warding off the blows of the rostra of the enemy's vessels.

**EPPINGEN**, a town of Germany, situated about ten miles north of Halibron.

**EPSOM**, a town of Surry, about fifteen miles south-west of London; much resorted to on account of its medicinal waters; from which the bitter purging salt being first extracted, got the name of Epsom-salt. At present, however, the bitter purging salt is procured from the bittern, remaining after the crystallization of common salt; and this is found to answer all the purposes of that first obtained from Epsom-waters, and goes by its name. See **CHEMISTRY**.

**EPULONES**, in Roman antiquity, ministers who assisted at the sacrifices, and had the care of the sacred banquet committed to them.

**EQUABLE**, an appellation given to such motions as always continue the same in degree of velocity, without being either accelerated or retarded. See **MECHANICS**.

**EQUAL**, a term of relation between two or more things of the same magnitude, quantity, or quality.  
Mathematicians speak of equal lines, angles, figures, circles, ratios, solids.

**EQUALITY**, that agreement between two or more things, whereby they are denominated equal.

**EQUANIMITY**, in ethics, denotes that even and calm frame of mind and temper, under good or bad fortune, whereby a man appears to be neither puffed up nor overjoyed with prosperity, nor dispirited, soured, or rendered uneasy by adversity.

**EQUATION**, in algebra. See **ALGEBRA**, p. 100.

**EQUATION of time**, in astronomy and chronology, the reduction of the apparent time or motion of the sun, to equable, mean, or true time. See **ASTRONOMY**, p. 459.

**EQUATOR**, in geography, a great circle of the terrestrial globe, equidistant from its poles, and dividing it into two equal hemispheres; one north, and the other south. See **GEOGRAPHY**.

**EQUERRY**, in the British customs, an officer of state, under the master of the horse.

There are five equerries, who ride abroad with his majesty: for which purpose they give their attendance monthly, one at a time, and are allowed a table.

As to the equerries of the crown stable, they have this distinct appellation, as being employed in mounting, managing, and breaking the saddle-horses for his majesty's use, and holding his stirrup.

**EQUES AURATUS**, is used for a knight batchelor, called *auratus*, q. d. *gilt*, because anciently none but knights were allowed to beautify their armour, or other habiliments for war, with gold.

**EQUESTRIAN STATUE**, signifies the statue of a person mounted on horseback.

**EQUESTRIAN ORDER**, among the Romans, signified their knights, or equites; as also their troopers, or horsemen in the field; the first of which orders stood in contradistinction to the senators, as the last did to the foot, military, or infantry: each of these distinctions was introduced into the state by Romulus.

**EQUIANGULAR**, in geometry, an epithet given to figures, whose angles are all equal: such are a square, an equilateral triangle, &c.

**EQUICRURAL**, in geometry. See **ISOSCELES**.

**EQUIDISTANT**, an appellation given to things placed at equal distance from some fixed point, or place, to which they are referred.

**EQUILATERAL**, in general, something that hath equal sides, as an equilateral angle.

**EQUILIBRIUM**, in mechanics, is when the two ends of a lever or balance hang so exactly even and level, that neither doth ascend or descend, but keep in a position parallel to the horizon; which is occasioned by their being both charged with an equal weight.

**EQUIMULTIPLES**, in arithmetic and geometry, are numbers or quantities multiplied by one and the same number or quantity. Hence, equimultiples are always in the same ratio to each other, as the simple quantities before multiplication: thus, if 6 and 8 are multiplied by 4, the equimultiples 24 and 32 will be to each other as 6 to 8.

**EQUINOCTIAL**, in astronomy, a great circle of the celestial globe, whose poles are the poles of the world. See **ASTRONOMY**, and **GEOGRAPHY**.

**EQUINOX**, the time when the sun enters either of the equinoctial points, where the ecliptic intersects the equinoctial. See **ASTRONOMY**.

*Precession of the EQUINOXES.* See **ASTRONOMY**.

**EQUISETUM**, or **HORSE-TAIL**, in botany, a genus of the cryptogamia filices class. The fructification is disposed on an oblong spike, and of an orbicular figure. There are seven species, six of which are natives of Britain, viz. the sylvaticum, or wood horse-tail; the arvense, or corn horse-tail; the palustre, or marsh horse tail; the fluviatile, or river horse-tail; the limosum, or smooth horse-tail; and the hyemale, or rough horse-tail.

**EQUITY**, in a general sense, the virtue of treating all other men according to common reason and justice, or as we would be gladly treated ourselves, when we understand aright what is our due. See **JUSTICE**.

**EQUIVALENT**, an appellation given to things which

agree in nature, or other circumstances, as force, virtue, &c.

**EQUIVOCAL TERMS** or words, among logicians, are these which have a doubtful or double meaning.

According to Mr Locke, the doubtfulness and uncertainty of words has its cause more in the ideas themselves, than in any incapacity of the words to signify them; and might be avoided, would people always use the same term to denote the same idea, or collection of ideas: but, adds he, it is hard to find a discourse on any subject where this is the case; a practice which can only be imputed to folly, or great dishonesty; since a man, in making up his accounts, might with as much fairness use the numeral characters sometimes for one, sometimes for another collection of unities.

**EQUIVOCAL GENERATION**, the production of animals, without the intercourse between the sexes, by the influence of the sun or stars, &c.

This kind of generation is now quite exploded by the learned.

**EQUULEUS**, or **ECUULEUS**, in antiquity, a kind of rack used for extorting a confession, at first chiefly practised on slaves, but afterwards made use of against the Christians.

The equuleus was made of wood, having holes at certain distances, with a screw, by which the criminal was stretched to the third, sometimes to the fourth, or fifth holes, his arms and legs being fastened on the equuleus with cords; and thus was hoisted aloft, and extended in such a manner, that all his bones were dislocated. In this state red-hot plates were applied to his body, and he was goaded in the sides with an instrument called ungula.

**EQUULUS**, in astronomy See **ASTRONOMY**, p. 487.

**EQUUS**, the **HORSE**, in zoology, a genus of quadrupeds belonging to the order of belluæ. This genus comprehends the horse, the ass, and the zebra; they have six erect and parallel fore-teeth in the upper jaw, and six somewhat prominent ones in the under jaw; the dog-teeth are solitary, and at a considerable distance from the rest; and the feet consist of an undivided hoof. The horse is a domestic animal, and the figure and dimensions of his body are so well known, that a general description is altogether unnecessary. We shall therefore confine ourselves to the natural history of this noble animal.

The horse, in a domestic state, is a bold and fiery animal; equally intrepid as his master, he faces danger and death with ardour and magnanimity. He delights in the noise and tumult of arms, and seems to feel the glory of victory: he exults in the chase; his eyes sparkle with emulation in the course. But though bold and intrepid, he is docile and tractable: he knows how to govern and check the natural vivacity and fire of his temper. He not only yields to the hand, but seems to consult the inclination of his rider. Constantly obedient to the impressions he receives, his motions are entirely regulated by the will of his master. He in some measure resigns his very existence to the pleasure of man. He delivers up his whole powers; he reserves

nothing; he will rather die than disobey. Who could endure to see a character so noble abused! Who could be guilty of such gross barbarity!

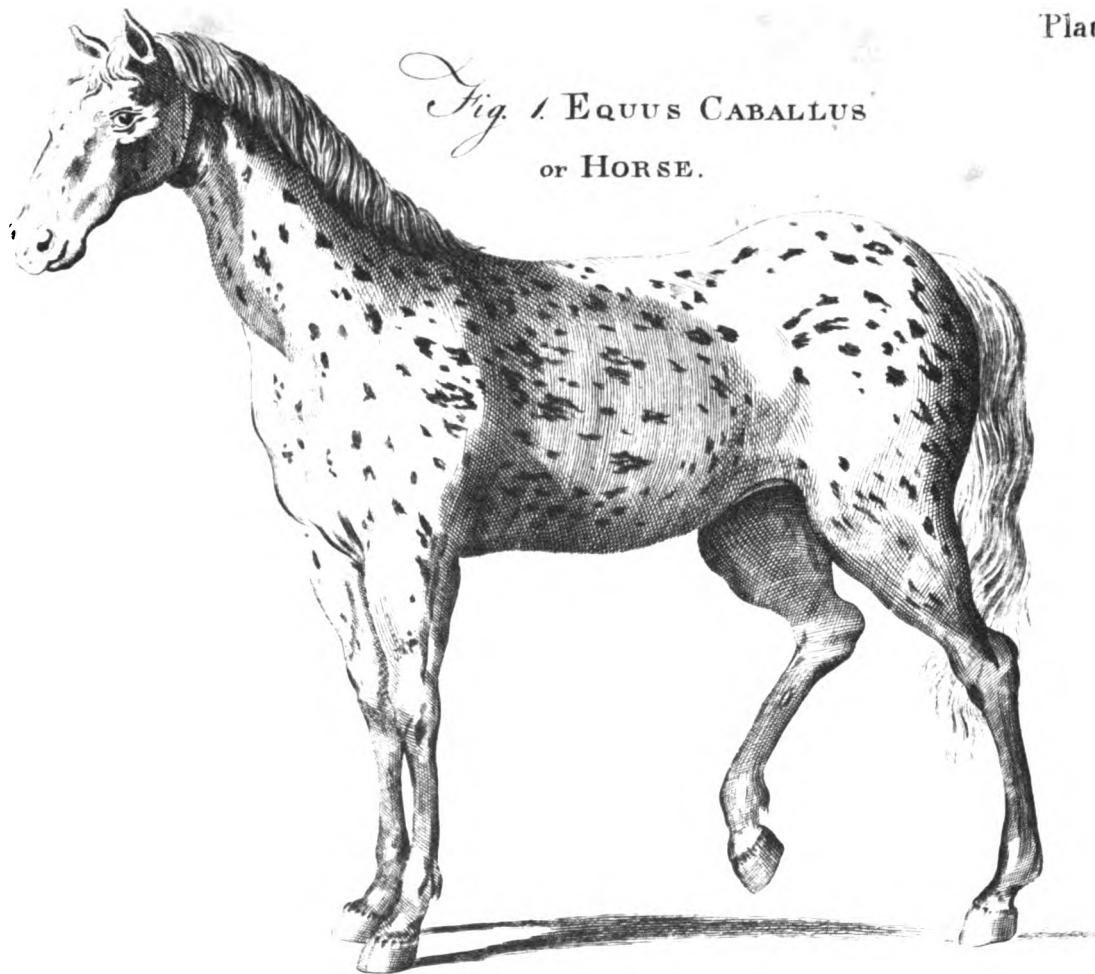
This character, though natural to the animal, is in some measure the effect of education. His education commences with the loss of liberty, and it is finished by constraint. The slavery of the horse is so ancient and so universal, that he is but rarely seen in a natural state. Several ancient writers talk of wild horses, and even mention the places where they were to be found. Herodotus takes notice of white savage horses in Scythia; Aristotle says, they are to be found in Syria; Pliny, in the northern regions; and Strabo, in Spain and the Alps. Among the moderns, Leardon says, that wild horses are to be found in the Highlands of Scotland, and the Orkney Isles; Olaus, in Muscovy; Dapper, in the island of Cyprus; Leo and Marmol, in Arabia and Africa, &c. But, as Europe is almost equally inhabited, wild horses are not to be met with in any part of it; and those of America were originally transported from Europe by the Spaniards; for this species of animals did not exist in the new world. The Spaniards carried over a great number of horses, lest them in different islands, &c. with a view to propagate that useful animal in their colonies. These have multiplied incredibly in the vast deserts of those thinly peopled countries, where they roan at large, without any restraint. M. de Salle relates, that he saw, in the year 1635, horses feeding in the meadows of North America, near the bay of St Louis, which were so ferocious that nobody durst come near them. Oexmelin says, that he has seen large troops of them in St Domingo running in the valleys; that when any person approached, they all flopt; and one of them would advance till within a certain distance, then snort with his nose, take to his heels, and the whole troop after him. Every author who takes notice of these horses of America, agree that they are smaller and less handsome than those of Europe. These relations sufficiently prove, that the horse when at full liberty, though not a fierce or dangerous animal, has no inclination to associate with mankind; that all the softness and ductility of his temper proceeds entirely from the culture and polish he receives in his domestic education, which in some measure commences as soon as he is brought forth.

The motions of the horse are chiefly regulated by the bit and the spur; the bit informs him how to direct his course, and the spur quickens his pace. The mouth of the horse is endowed with an amazing sensibility: the slightest motion or pressure of the bit gives him warning, and instantly determines his course.

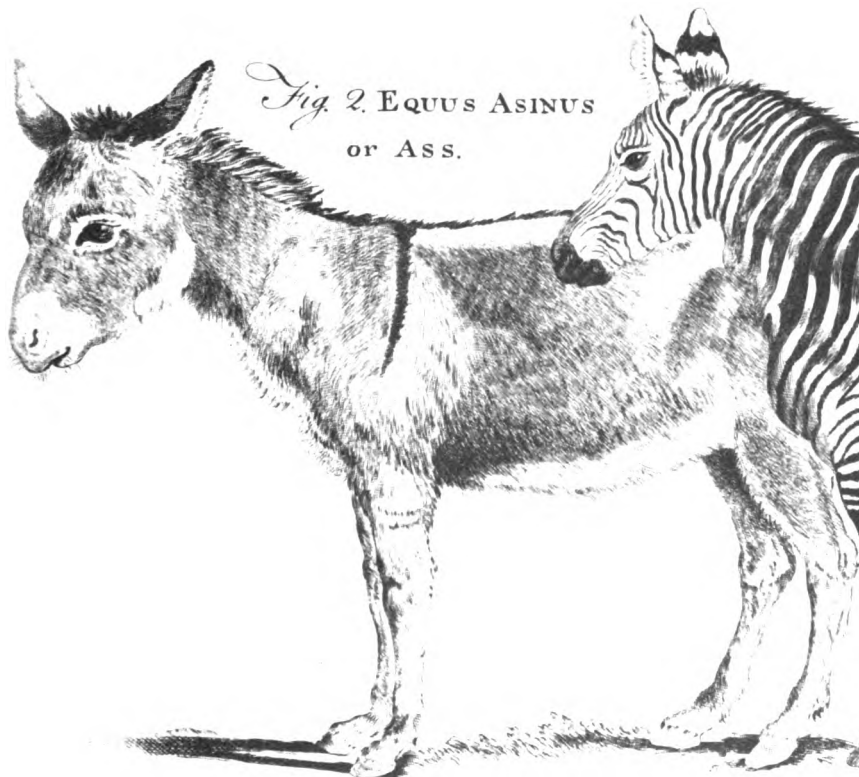
The horse has not only a grandeur in his general appearance, but there is the greatest symmetry and proportion in the different parts of his body. The regularity and proportion of the different parts of the head gives him an air of lightness, which is well supported by the strength and beauty of his chest. He creeds his head, as if willing to exalt himself above the condition of other quadrupeds: his eyes are open and lively:

his

*Fig. 1.* EQUUS CABALLUS  
or HORSE.



*Fig. 2.* EQUUS ASINUS  
or ASS.



*Fig. 3.* EQUUS ZEBRA.



*W. B. Smith del.*



his ears are handsome, and of a proper height; his main adorns his neck, and gives him the appearance of strength and boldness.

At the age of two years, or two years and a half, the horse is in a condition to propagate; and the mare, like most other females, is ready to receive him still sooner. But the foals produced by such early embraces are generally ill made and weakly. The horse should never be admitted to the mare till he is four or four and a half; this is only meant with regard to draught-horses. Fine horses should not be admitted to the mare before they be six years old; and Spanish stallions not till seven. The mares are generally in season from the beginning of April to the end of March; but their chief ardour for the horse lasts but about 15 or 20 days, and this critical season should always be embraced. The stallion ought to be sound, well made, vigorous, and of a good breed. For fine saddle horses, foreign stallions, as Arabians, Turks, Barbs, and Andalousians, are preferable to all others. Next to these, British stallions are the best; because they originally sprang from those above mentioned, and are very little degenerated. The stallions of Italy, and especially the Neapolitans, are very good. The best stallions for draught or carriage horses, are those of Naples, Denmark, Holstein, and Freezeland. The stallions for saddle-horses should be from 14 to 15 hands high, and for draught-horses at least 15 hands. Neither ought the colour of stallions to be overlooked; as a fine black, grey, bay, sorrel, &c. Besides these external qualities, a stallion ought to have courage, tractability, spirit, agility, a sensible mouth, sure limbs &c. These precautions in the choice of a stallion are the more necessary, because he has been found by experience to communicate to his offspring almost all his good or bad qualities, whether natural or acquired.

The mare contributes less to the beauty of her offspring than the stallion; but she contributes perhaps more to their constitution and stature: for these reasons, it is necessary that the mares for breed be perfectly sound, and make good nurses. For elegant horses, the Spanish and Italian mares are best; but, for draught-horses, those of Britain and Normandy are preferable. However, when the stallions are good, the mares of any country will produce fine horses, provided they be well made and of a good breed.

Mares go with young eleven months and some days. They bring forth standing; contrary to the course of most other quadrupeds, who lie during this operation. They continue to bring forth till the age of 16 or 18 years; and both horses and mares live between 25 and 30 years. Horses cast their hair once a year, generally in the spring, but sometimes in the autumn. At this time they are weak, and require to be better fed and taken care of than at any other season.

In Persia, Arabia, and most eastern countries, they never geld their horses, as is done in Europe and China. This operation greatly diminishes their strength, courage, and spirit; but it makes them good humoured, gentle, and tractable. With regard to the time of performing this operation, the practice of different

countries is different: some geld their horses when a year old, and others at 18 months. But the best and most general practice is to delay the operation till they be two years old at least; because, when the gelding is delayed for two years or more, the animals retain more of the strength and other qualities which naturally belong to the male.

As the utility of horses surpasses that of all other domestic animals, it may be of use to subjoin some marks by which the age and other properties of horses may be distinguished.

The first teeth that appear are four, two above and two below, which are called foal-teeth, and may be easily distinguished from the others by their whiteness. The rest come out afterwards till they are twelve in number, six above and six below. When a colt is between two years and a half and three years old, he casts four of these teeth, two above and two below. These we call nippers or gatherers, and are much longer and larger than the fore teeth; with these he nips off the grass, and pulls the hay from the rack. When these are complete, the horse will be three years old, or somewhat more.

When he is about four, he casts again two above and two below, one on each side the nippers; so that now there are no fore-teeth remaining but the corner-teeth; and hence it may be concluded that he is about four years old. The tusks appear next after these, and are a little crooked. Those below come out before those on the upper jaw, and at four years old they are very small. When all the colt-teeth are cast, and the corner-teeth begin to shew themselves, then the horse comes five.

From five to five and a half the corner teeth remain hollow within, and are not quite filled up till the horse is six. At five and a half they are about a quarter of an inch high, and when he is full six near half an inch. Every thing that is to be examined at six years old, are the corner-teeth and the tusks. That part of the corner-teeth that had flesh in it first turns to a brownish spot, like the eye of a garden-bean. At seven the mark or spot becomes faint, and the tooth more even. At eight it quite disappears, though it possibly may remain in a very small degree for two or three years more, which has deceived many. The longer the corner teeth are, the older is the horse; and they are apt to grow foul and turn yellow. When the mark is gone, if you touch the tusks on the upper jaw with your finger, and find it worn away and equal with the palate, you may certainly judge that the horse is ten years old at least. Lastly, when the flanks of a horse are much sunk, the feet broken and spoiled, the pace bad, and the eye-pits very yellow, you may certainly conclude the horse is considerably advanced in years.

When the horse is without blemish, the legs and thighs are clean, the knees strait, the skin and flank thin, and the back sinew strong and well braced. The sinews and the bones should be so distinct, as to make the legs appear thin and lathy, not full and round. The pastern joints should never be large and round;

1102

nor must there be any swelling near the coronet. The hocks should be lean and dry, not puffed up with wind. With regard to the hoof, the coronet should be equally thick, and the horn shining and greyish. A white horn is a sign of a bad foot, for it will wear out in a short time; and likewise when the horn is thin, it is liable to be spoiled in shoeing, and by travelling hard on stony grounds. This is best known when the shoe is taken off; for then the verge all round the sole will appear thin, and the horse will wince at the least touch of the pincers.

A strong foot has the fibres of the hoof very distinct running in a direct line from the coronet to the toe, like the grain of wood. In this case care must be taken to keep the foot moist and pliable. The greatest inconvenience attending a hard strong foot, is its being subject to rifts and fissures, which cleave the hoof quite through sometimes from the coronet down to the bottom.

A narrow heel is likewise a defect; and when it is not above two fingers in breadth the foot is bad. A high heel causes a horse to trip and stumble often; and the low one, with long yielding pasterns, is very apt to be worn quite away on a journey. Too large a foot in proportion to the rest of the body, renders a horse weak and heavy.

The head of a horse should be small, and rather lean than fleshy. The ears should be small, erect, thin, sprightly, and pointed. The forehead, or brow, should be neither too broad nor too flat, and should have a star or snip thereon. The nose should rise a little, and the nostrils should be wide that he may breathe more freely. The muzzle should be small, and the mouth neither too deep nor too shallow. The jaws should be thin, and not approach too near together at the throat, nor too high upwards towards the osset, that the horse may have sufficient room to carry his head in an easy graceful posture. The eyes should be of a middle size, bright, lively, and full of fire. The tongue should be small, that it may not be too much pressed by the bit; and it is a good sign when his mouth is full of white froth, for it shews that he will not soon be overheated.

The neck should be arched towards the middle, growing smaller by degrees from the breast and shoulders to the head. The hair of the mane should be long, small, and fine; and if it be a little frizzled, so much the better. The shoulders should be pretty long, the withers thin, and enlarge gradually from thence downwards; but so as to render his breast neither too narrow nor too gross. A thick-shouldered horse soon tires, and trips and stumbles every minute; especially if he has a thick large neck at the same time. When the breast is so narrow that the fore-thighs almost touch, they are never good for much. A horse of a middle size should have the distance of five or six inches between his fore-thighs, and there should be less distance between his feet than his thighs near the shoulders when he stands upright.

The body or carcase of a horse should be of a middling size in proportion to his bulk, and the back

should sink a little below the withers; but the other parts should be straight, and no higher behind than before. He should also be home-ribbed; but the short ribs should not approach too near the haunches, and then he will have room to fetch his breath. When a horse's back is short in proportion to his bulk, and yet otherwise well limbed, he will hold out a journey though he will travel slow. When he is tall, at the same time with very long legs, he is but of little value.

The wind should never be overlooked in the choice of a horse; and it may easily be known by his flanks, if he is broken-winded, when he stands quiet in the stable; because he always pinches them in with a very slow motion, and drops them suddenly. A thick-winded horse fetches his breath often, and sometimes rattles and wheezes. This may be always discovered when he is put to brisk exercises.

The temper of a horse should always be observed; a vicious horse generally lays his ears close to his pole, shews the whites of his eyes, and looks fullen and dogged. An angry horse may be known by his frowning looks; and he generally seems to stand in a posture of defence. When he is very vicious, he pays no regard to the groom that feeds him: However, some horses that are ticklish will lay back their year ears, and yet be of a good disposition. A fearful horse is apt to start, and never leaves it off till he is old and useless. A fretful horse is very unfit for a journey; and you may discover his temper as soon as he gets out of the stable. A dull, heavy, sluggish horse may be easily known, whatever tricks are used to rouse his spirits.

With regard to the colour of a horse, the bright bay, and indeed all kinds of bays in general, are accounted a good colour. The chestnut horse is generally preferable to the sorrel, unless the former happens to be bald, or party-coloured with white legs. Brown horses have generally black manes and tails, and their joints are of a rusty black. Those of this colour that are dappled are much handsomer than the rest. Horses of a shining black, and well-marked, without too much white, are in high esteem for their beauty. A star, or blaze, or white muzzle, or one or more feet tipped with white, are thought to be rather better than those that are quite black.

Of greys, the dappled are accounted best; though the silver grey makes a more beautiful appearance, and often prove good. The iron grey with white manes and tails are thought not to be so hardy. Greys of every kind will turn white sooner or later; but the nutmeg grey, when the dappled parts incline to bay or chestnut, are said to be good hardy horses. Roan horses have a diversity of colours mixed together; but the white is more predominant than the rest. They are all generally hardy, and fit for the road; and some are exceeding good. Those of a strawberry colour most resemble the sorrel, and they are often marked with white on the face and legs. When the bay is blended with it, he seems to be tintured with claret; and some of these prove to be very good. Dun, fallow, and cream-coloured horses have a lit down their backs; and their manes and tails are black.

Dun

Two horses are seldom chosen by gentlemen, and yet they may be very useful to the country farmer. The fallow and cream-coloured are better esteemed, both for beauty and use. Those horses that are finely spotted with gay colours like leopards are a great rarity, and for that reason are only in the hands of great men.

There is some difference in horses according to the different countries where they are bred. For instance, in France, those of Bretagne are pretty strong made, and have generally black hair, or brown bay; and they have good legs and feet, with a hardy mouth, and a head short and fleshy; but in general they are pretty clumsy. The horses of Franche Comté are said to have the legs of tigers, and the belly of a hind; but they are short and thick, and of a middle size; being much more proper for drawing than riding. The horses of Gascony are not unlike those of Spain; but they are not so handsome, nor so active, and therefore they are more proper to draw carriages. The Limosin horses are very vicious, and are good for little till they are six years old. Their colour is generally bay, or a bay brown. The horses of Normandy are much like those of Bretagne; and those of Poitou have good bodies, legs, feet, and eyes; but they are far from being handsome.

The horses of Germany are much better and more handsome than those of the Low countries. They are of great use for carriages; but much more for the army, and for drawing the artillery. They have a great deal of hair, especially about the legs. They are not large, but they are well set; and yet they have tender feet. The Hungarian horses are excellent for the coach, as well as for riding; but they are large, though well proportioned, and they are of all colours, and in general very swift.

The British horses are of all kinds, they having been brought at first from different countries; but for racers no country can equal them, they having been bred from what are called barbs. The Danish horses are low, short, and square; but they have a fine head, and short hair. The horses of the Low countries are very fit for the coach, and they are best known by the name of Flanders-mares. The Polish horses are like the Danish; only they have not so fine a fore-hand: their colour is generally a bright bay, and that of the outward peel of an onion; and they are fiery and vicious. The horses of Switzerland are pretty much like those of Germany; which is no wonder, since the Germans purchase a great number of them. The horses of Piedmont are fiery, of a middle size, and of all sorts of colours; their legs are good and handsome, their eyes fine, their ears small, and their mouths good; but they do not carry their heads well.

The horses of Naples and Italy are generally ill made, and lean; and yet they are good and useful, for they are light and proper for racing, though not for a long course; they never do well in a colder climate. The Spanish horses are very well made, and handsome, as well as very active and nimble; they have good eyes, handsome legs and heads, and are easily managed;

they are also good for racing if they are well kept: however, they are not so good in northern climates as in their own country. The Turkish horses are of different shapes; but they are generally swift, though their mouths are bad. Most of them are white; tho' there are other colours; and they are large, hardy, strong, and fit for the road.

The horses of Barbary, commonly called barbs, have strong hoofs, and are more proper for racing than any others whatever: some have said they never grow old, because they preserve their vigour to the last. They are excellent stallions; and some of them are used as such in Britain: however, the Arabian horses are not quite so good as the Barbary, though some think they are both of the same kind, only those that are used to the deserts of Arabia are always in action. The horses of the gold-coast of Guinea are very few in number, and in other parts of that coast there are none at all; for many of the negroes, when they have been first brought over to our American plantations, have expressed great admiration at the sight of a horse, and even been afraid to come near one.

The horses of the Cape of Good Hope were originally brought from Persia; and they are generally small and of a chestnut colour; for those that are natives of that country are all wild, and could never yet be tamed. The horses of China are good, and more particularly those in the province Yun Nan, for they are very vigorous, though a little low. The horses of the Eluth Tartars are good and full of fire; and their size is much the same as the Polish horses: they are afraid of nothing, not even of lions and tigers; but perhaps this may be owing to use. In the country of the Mogul they are very numerous, and of all colours: they are generally of the middle size, tho' there are some as large and as handsome as those in Europe. The wild horses of Tartary differ little from the tame; but they are so swift, that they avoid the arrows of the most skilful hunters. [Plate LXXV. fig. 1.]

For the method of training and managing horses, see HORSEMANSHIP; and for their diseases and cure, see FARRIERY.

2. The ass is likewise a domestic animal, and easily distinguished from the horse at first sight; we never confound these two animals, even though they should happen to be of the same colour and stature; however, when we view the different parts of the ass, whether the external or internal, and compare them with the corresponding parts of the horse, the resemblance of these parts is so perfect, that we are surprised to find the individuals so different and so easily distinguishable by the eye. From this circumstance, some naturalists have considered the ass and the horse to be the same species of animals; and that the small differences between them are accidental, or owing to the influence of climate, culture, &c. Linnæus's specific mark of the horse is, that the whole tail is covered with long hair; and his specific mark of the ass is, that the tail has long hair only towards the point, and a black cross over the shoulders. On the other hand, when we consider the differences in the temper, the manners and dispositions of these two animals, and, above all, the

impossibility of mixing them so as to produce a common or intermediate species capable of propagating and transmitting in the same manner as other distinct species, the notion that the horse and the ass are the same species will appear to be without any solid foundation. Besides, the ass differs materially from the horse in the thickness of the head, the length of the ears, the hardness of the skin, and in the voice, the dispositions, the manner of drinking, &c. With regard to animals, there is perhaps but one permanent and uniform specific distinction in nature: a male and female of different species may copulate, may produce a third animal resembling both, but very different from either: but here nature has put a final stop to all further procreation: the third animal, although it be seemingly furnished with every thing necessary for propagating, remains for ever barren. Now, the horse may be made to copulate with the ass; a mule, or mixture of the two, is the fruit of the unnatural embrace: but the impregnation of a mule is found by experience to be altogether impossible.

The ass, therefore, is a distinct species, and his race as ancient as that of the horse. Why then should this useful, patient, sober animal be so much despised? We are apt to compare him, on every occasion, with the horse, and from this comparison are led to very false and unfavourable conclusions. The horse is educated with great care and expence; while the poor ass, abandoned to the abuse of the meanest servants or the cruelty of children, instead of deriving benefit from instruction, loses in effect his natural good qualities by the bad treatment he suffers. He is the sport and buffet-block of every rustic, who beat and overload him without mercy or discretion. They never consider, that the ass would be the most useful, the best made, and most distinguished of all animals, if there were no horses in the world.

The ass is as humble, patient, and tranquil, as the horse is bold, ardent, and impetuous. He submits with firmness, perhaps with magnanimity, to strokes and chastisement; he is temperate both as to the quantity and quality of his food; he contents himself with the rigid and disagreeable herbage which the horse and other animals leave to him, and disdain to eat: he is more delicate with regard to his drink, never using water, unless it be perfectly pure. As his master does not take the trouble of combing him, he often rolls himself on the turf among thistles, ferns, &c. Without regarding what he is carrying, he lies down to roll as often as he can, seeming to reproach his master for neglect and want of attention.

When very young, the ass is a gay, sprightly, nimble, and gentle animal. But he soon loses these qualities, probably by the bad usage he meets with; and becomes lazy, untractable, and stubborn. When under the influence of love, he becomes perfectly furious. The affection of the female for her young is strong: Phoy assures us, that when an experiment was made to discover the strength of maternal affection in a she-ass, she run through the flames in order to come at her colt.

Although the ass be generally ill used, he discovers a great attachment to his master; he smells him at a

distance, searches the places and roads he used to frequent, and easily distinguishes him from the rest of mankind. The ass has a very fine eye, an excellent scent, and a good ear. When overloaded, he hangs his head, and sinks his ears: when too much teased or tormented, he opens his mouth and retracts his lips in a disagreeable manner, which gives him an air of ridicule and derision. If you cover his eyes, he will not move another step; if you lay him on his side, and place his head so that one eye rests on the ground, and cover the other with a cloth, he will remain in this situation without making any attempt to get up. He walks, trots, and gallops in the same manner as the horse; but all his motions are slower. Whatever be the pace he is going at, if you push him, he instantly stops.

The cry of the horse is known by the name of *neighing*; that of the ass, by *braying*, which is a long, disagreeable noise, consisting of alternate discords from sharp to grave and from grave to sharp: he seldom cries but when pressed with hunger or love: the voice of the female is clearer and more piercing than that of the male.

The ass is less subject to vermin than other animals covered with hair; he is never troubled with lice, probably owing to the hardness and driness of his skin; and it is probably for the same reason, that he is less sensible to the whip and spur than the horse.

The teeth of the ass fall out and grow at the same age and in the same manner as those of the horse; and he has nearly the same marks in his mouth.

Asses are capable of propagating when two years old. The females are in season during the months of May and June. The milk appears in the dugs ten months after impregnation; she brings forth in the twelfth month, and always one at a time. Seven days after the birth, the season of the female returns, and she is again in a condition to receive the male. The foal should be taken from her at the end of five or six months, that the growth and nourishment of the foetus may not be obstructed. The stallion or jack-ass should be the largest and strongest that can be found; he should be at least three years old, and never ought to exceed ten.

The ass, like the horse, takes three or four years in growing, and lives till he be 25 or 30: he sleeps less than the horse, and never lies down to sleep but when excessively fatigued. He is more robust, and less subject to diseases than the horse.

Travellers inform us that there are two sorts of asses in Persia; one of which is used for burdens, they being slow and heavy; and the other is kept like horses for the saddle, for they have smooth hair, carry their head well, and are much quicker in their motion; but when they ride them, they sit nearer their buttocks than when on a horse: they are dressed like horses, and are taught to amble like them; but they generally cleave their nostrils to give them more room for breathing. Dr Russell likewise tells us they have two sorts in Syria, one of which is like ours, and the other very large, with remarkable long ears; but they are both put to the same use, which is, to carry burdens.

The



The onager, or wild ass, has, by some authors, been confounded with the zebra; but very improperly, for this last is a distinct species; for the onager is not streaked like this, nor is his shape so beautiful. Wild asses are said to be very swift of course; and when they see a man, they make a bound, and immediately fly away; inasmuch, that there is no taking of them, but by traps and gins. They have much the same shape as common asses; but they are of a brighter colour, and there runs a white list from the head to the tail. Of the hide of these asses, and particularly of that part next the rump, they make that excellent leather which we call siagreen, and which is put to so many curious uses.

In America they have no asses at all, nor yet horses; but they have been carried thither long ago, at first by the Spaniards, and afterwards by other nations, where they have multiplied greatly; inasmuch, that, in some places, there are whole droves of them that run wild, and are very hard to be caught. Asses in general carry the heaviest burdens in proportion to their bulk; and, as their keeping costs little or nothing, it is a great wonder they are not put to more uses than they generally are among us.

The flesh of the common ass is never eaten in these parts of the world; though some pretend their colts are tender, and not disagreeable. [Plate LXXV. fig. 2.]

3. The zebra.—This animal has the figure and gracefulness of the horse, joined to the swiftness of the stag. He is about 7 feet long, from the point of the muzzle to the origin of the tail, and about 4 feet high. The colour of his skin is beautiful and uniform, consisting of alternate parallel rings of black and white disposed in the most regular manner, as represented in the plate, [LXXV. fig. 3.] He is generally less than the horse, and larger than the ass.

The zebra is found no where but in the eastern and southern provinces of Africa, from Æthiopia to the Cape of Good Hope, and from the Cape of Good Hope to Congo. The Dutch have been at great pains to tame and use them for domestic purposes, but with little success. He is hard-mouthed, and kicks when any person attempts to touch or come near him. He is restless and obstinate as a mule: but perhaps the wild horse is naturally as untractable as the zebra; for, it is probable, if he were early accustom'd to obedience and a domestic life, he would become as docile as the horse.

**ERANARCHA**, a public officer among the ancient Greeks, whose business was to preside over and direct the alms and provisions made for the poor. Cornelius Nepos, in his life of Epaminondas, describes his office thus: when any person was reduced to poverty, taken captive, or had a daughter to marry, which he could not effect for want of money, &c. the eranarcha called an assembly of friends and neighbours, and taxed each according to his means and estate, to contribute towards his relief.

**ERANTHEMUM**, in botany, a genus of the diandria monogynia class. The calix is divided into five segments; the tube is siliiform; and the stigma is simple. There is but one species, a native of Æthiopia.

**ERASED**, in heraldry. See **ARRACHE**.

**ERECTION**, in a general sense, the act of raising or elevating any thing, as the erection of a perpendicular, &c. It is also used in a figurative sense, as the erection of a bishopric, marquise, &c.

**ERECTOR CLITORIS**. See **CLITORIS**.

**ERECTOR PENIS**. See **PENIS**.

**EREMIT**. See **HERMIT**.

**EREMITA**, in zoology. See **SCARABÆUS**.

**ERFURT**, a large and beautiful city of Upper Saxony in Germany, capital of Thuringia, and subject to the elector of Mentz: E. long. 11° 6', N. lat. 51°.

**ERGOT**, in farriery, is a stub, like a piece of soft horn, about the bigness of a chestnut, placed behind and below the pastern-joint, and commonly hid under the tuft of the fetlock.

**ERICA**, or **HEATH**, in botany, a genus of the octandria monogynia class. The calix consists of four leaves, and the corolla of four segments; the filaments are inserted into the receptacle; the antheræ are bifid; and the capsule has four cells. There are thirty-eight species, five of which are natives of Britain, viz. the vulgaris, or common heath; the cinerea, or fine-leaved heath; the tetralix, or cross-leaved heath; the ciliaris, or rough-leaved heath; and the multiflora, or fir-leaved heath.

**ERIDANUS**, in astronomy. See Vol. I. p. 487.

**ERIE**, a vast lake to the westward of Pennsylvania, in North America, situated between 80° and 87° W. long. and between 41° and 42° N. lat.

**ERIGERON**, or **SWEET FLEA-BANE**, in botany, a genus of the syngenesia polygamia superflua class. The receptacle is naked; the pappus is hairy; and the radii of the corolla are linear and very narrow. There are sixteen species, two of which are natives of Britain, viz. the acre, or blue-flowered flea-bane; and the canadense, or Canada flea-bane.

**ERINACEUS**, or **HEDGE-HOG**, in zoology, a genus of quadrupeds belonging to the order of fera; the characters of which are these: they have two foreteeth in the upper-jaw, at a considerable distance from one another, and two in the under jaw, less distant; and they have two recumbent dog-teeth, one on each side. There are three species, viz. 1. The europæus, or common hedge-hog, with round ears, and crested nostrils. It is about nine inches long; the upper part of the body is totally covered with sharp prickles, and the under part is covered with hair. The hedge-hog, even when standing on his legs, has a very ugly aspect. His body is an oblong mass, convex above, terminated on the fore-part by a very sharp muzzle, and mounted on four short legs, of which nothing appears but the feet, and the tail is not discernible. His ears are broad, round, and short; and his eyes are small and protuberant. The length of his body, from the point of the muzzle to the anus, is about nine inches.

The hedge-hog has a very uncommon method of defending himself from the attacks of other animals: being possessed of little strength or agility, he does not attempt to fly from or assail his enemies; but erects his bristles, and rolls himself up like a ball, exposing no

part

part of his body that is not furnished with sharp weapons of defence; he will not unfold himself, unless thrown into water: the more he is frightened or harassed, the closer he shuts himself up, and frequently discharges his urine, which has a very foetid and loathsome smell. While in this state, molt dogs, instead of biting him, stand off and bark, not daring to seize him; or, if they attempt it once, their mouths are so pricked with his bristles, that they cannot be prevailed on to attempt it a second time. Both the male and female are covered with bristles from the head to the tail. These bristles are of great use in defending them from other animals; but must be very inconvenient when they incline to copulate. This operation they cannot perform in the manner of other quadrupeds; but do it face to face, either standing on end, or the female lying on her back. The females come in season in the spring, and bring forth their young in the beginning of summer. They commonly bring forth three or four, and sometimes five, at a time. The young ones are of a whitish colour, and only the points of the bristles appear above the skin. It is impossible to tame them: the mother and her young have frequently been confined together, and furnished with plenty of provisions: but, instead of nourishing them, she uniformly devoured them one after another. Males and females have likewise been kept in one apartment, where they lived, but never copulated. Hedge-hogs feed upon fallen fruits, some roots, and insects: they are very fond of flesh-meat, whether raw or roasted. They frequent woods, and live under the trunks of old trees, in the chinks of rocks, or under large stones. Naturalists alledge that they go into gardens, mount the trees, and come down with pears, apples, or plumbs, stuck upon their bristles. But this is a mistake: although kept in a garden, they never attempt to climb trees, or stick even fallen fruit upon their bristles, but lay hold of their food with their mouth. They never come out of their holes in the day, but go about in quest of food during the night. They eat but little, and can live very long without taking any nourishment. They do not lay up any store of provisions in harvest: such an instinct would be useless, as they sleep all the winter. See Plate LXXIV. fig. 6.

2. The inauris, or white hedge hog, has no external ears. It is a native of America.

3. The malacensis, has hanging ears, and is a native of Asia.

ERINGO, in botany. See ERYNGIUM.

ERIOCAULON, in botany, a genus of the triandria trigynia class. The common calix has an imbricated capitulum; it has three equal petals: and the stamina are above the germen. There are five species, none of them natives of Britain.

ERIOCEPHALUS, in botany, a genus of the syngenesia polygamia necessaria class. The receptacle is somewhat hairy; it has no pappus; the calix consists of six equal petals: and there are five floscules in the radius. There are two species, none of them natives of Britain.

ERIOPHORUM, in botany, a genus of the triandria monogynia class. The gluma is palaceous, and imbricated on each side; the corolla is wanting; and there is but one seed, surrounded by long down.

ERITHACUS, in ornithology. See MOTACILLA.

ERIVAN, a city of Persia, on the frontiers of Turkey, situated on the south end of a lake of the same name: E. long. 45°, N. lat. 40° 16'.

ERKELENS, a city of Westphalia, in Germany, ten miles north of Juliers: E. long. 6°, N. lat. 51°.

ERMIN, in zoology. See MUSTELA.

ERMIN, in heraldry, is always argent and sable, that is, a white field, or fur, with black spots. These spots are not of any determinate number, but may be more or less, at the pleasure of the painter, as the skins are thought not to be naturally so spotted; but serving for lining the garments of great persons, the furriers were wont, in order to add to their beauty, to sew bits of the black tails of the creatures that produced them, upon the white of their skin, to render them the more conspicuous, which alteration was introduced into armory. See Plate LXXIV. fig. 7.

ERMIN, or EARS OF CORN, an order of knights in France, instituted by Francis the last of that name, duke of Britany.

This order was so called on account that the collar of it was made up of ears of corn, lying athwart one another in saltier, bound together, both above and below, each ear being crossed twice, the whole of gold. To this collar there hung a little white beast, called an ermin, running over a bank of grass diversified with flowers.

ERMINE', or CROSS ERMINE', is one composed of four ermin spots, placed as represented in Plate LXXIV. fig. 8.

It is to be observed, that the colours in these arms are not to be expressed, because neither this cross nor these arms can be of any other colour but white and black.

ERMINITES should signify little ermines, but it is otherwise; for it expresses a white field powdered with black, only that every such spot hath a little red hair on each.

Erminites also signify a yellow field powdered with black, which the French express much better by *or semée d'ermine de sable*.

EROSION, among physicians, denotes much the same with corrosion, only in a stronger degree. See CORROSION, and CORROSIVES.

EROTIC, in general, any thing relating to the passion love.

ERRATIC, in general, something that wanders, or is not regular: hence it is the planets are called erratic stars.

ERRHINES, in pharmacy, medicines which, when snuffed up the nose, promote a discharge of mucus from that part.

ERROUR, ERROR, a mistake of our judgment, giving assent to that which is not true.

Mr Locke reduces the causes of error to these four: first

- first, want of proofs; secondly, want of ability to use them; thirdly, want of will to use them; and fourthly, wrong measures of probability.
- ERUCA**, in general, denotes caterpillars of all kinds. See *NATURAL HISTORY, Of insects*.
- ERUCA**, the **WHITE ROCKET**, in botany. See *BRASSICA*.
- ERUCA MARINA**. See *APHRODITA*.
- ERUCAGO**, in botany. See *BUNIAS*.
- ERUDITION** denotes an extensive acquaintance with books, especially such as treat of the belles lettres.
- ERVI SPECIES**, in botany. See *SOPHORA*.
- ERUPTION**, in medicine, a sudden and copious excretion of humours, as pus or blood: it signifies also the same with exanthema, any breaking out, as the pustules of the plague, small-pox, measles, &c. See *MEDICINE*.
- ERVUM**, in botany, a genus of the diadelphia decandria class. The calix consists of five segments of an equal length with the corolla. There are six species, three of which are natives of Britain, *viz.* the solonense, or spring tare; the tetraspermum, or smooth tare; and the hirsutum, or hairy tare.
- ERINGIUM**, **ERINGO**, in botany, a genus of the pentandria digynia class. The flowers are capitated, and the receptacle is paleaceous. There are ten species, two of which are natives of Britain, *viz.* the maritimum, or sea-holly eringo; and the campestre, or common eringo. The root of the sea-holly is said to be aperient, diuretic, and aphrodisiac.
- ERYSIMUM**, in botany, a genus of the tetradynamia siliquosa class. The pod is four-sided, divided into two cells. There are six species, four of which are natives of Britain, *viz.* the officinale, or hedge-mustard; the cheiranthoides, or treacle worm-feed; the barbarea, rocket, or winter-crelles; and the alliaria, Jack-by-the-hedge, or sawce-alone. The leaves of the hedge-mustard are said to promote expectoration, and to excite urine and other excretions.
- ERYSIPELAS**, in medicine, an eruption of a fiery or acrid humour, from which no part of the body is exempted, though it chiefly attacks the face. See *MEDICINE*.
- ERYTHRINA**, in botany, a genus of the diadelphia decandria class. The calix is bilabiated; and the corolla consists of a long lanceolated vexillum. There are three species, none of them natives of Britain.
- ERYTHRINUS**, in ichthyology, a species of sparus. See *SPARUS*.
- ERYTHROIDES**, in anatomy, the first of the proper tunics or coats which cover the testicles. See *ANATOMY*, p. 170.
- ERYTHRONIUM**, **DOG'S-TOOTH VIOLET**, in botany, a genus of the hexandria monogynia class. The corolla is bell-shaped, and consists of six petals; there are two nectariferous tubercles at the base of every second petal. There is but one species, a native of Germany.
- ERYTHROPHTHALMUS**, in ichthyology, a species of cyprinus. See *CYPRINUS*.
- ERZERUM**, the capital of the province of Turcomania, or Armenia: E. long. 41°, N. lat. 40°. It is a great thoroughfare from Persia and India to Constantinople, by the way of Trebitund and the Black-sea.
- ESCHAR**, in surgery, the crust or scab occasioned by burns or caustic medicines.
- ESCHAROTICS**, in pharmacy, medicines which produce eschars. See *ESCHAR*.
- ESCHEAT**, in Scots law, is that forfeiture which is incurred upon a person's being denounced rebel. It is either single or liferent: single escheat is the forfeiture of the rebel's moveable estate; liferent escheat is the forfeiture of the rents of his heritable estate, during his life. See *SCOTS LAW*, title 12.
- ESCHIRAKITES**, in matters of religion, a sect of Mahometans, who believe that man's sovereign good consists in the contemplation of God. They avoid all manner of vice, and appear always in good humour, despising the sensual paradise of Mahomet. The most able preachers, in the royal mosques, are of this sect.
- ESCLATTE**, in heraldry, signifies a thing forcibly broken, or rather a shield that has been broken and shattered with the stroke of a battle-ax.
- ESCUAGE**, in our old customs, a kind of knight-service, called service of the shield, by which the tenant was bound to follow his lord to the wars at his own charge.
- ESCULENT**, an appellation given to such plants as may be eaten. See *BOTANY*, p. 628.
- ESCULUS**, in botany. See *QUERCUS*.
- ESCURIAL**, a palace of the king of Spain, twenty-one miles north-west of Madrid; being one of the largest and most beautiful in the world. It has eleven thousand windows, fourteen thousand doors, one thousand eight hundred pillars, seventeen cloysters or piazzas, and twenty-two courts; with every convenience and ornament that can render a place agreeable in so hot a climate, as an extensive park, groves, fountains, cascades, grottos, &c.
- ESCUTCHEON**, or **SCUTCHEON**, in heraldry, is derived from the French *escuffon*, and that from the Latin *scutum*, and signifies the shield whereon coats of arms are represented.
- Most nations, of the remotest antiquity, were wont to have their shields distinguished by certain marks painted on them; and to have such on their shields was a token of honour, none being permitted to have them till they had performed some honourable action.
- The escutcheon, as used at present, is square, only rounded off at the bottom.
- ESDRAS**, the name of two apocryphal books, usually bound up with the scriptures. They were always excluded the Jewish canon, and are not admitted as canonical by the papists themselves.
- ESENS**, a town of Westphalia, twenty-five miles north of Embden.
- ESK**, a river which forms part of the boundary between England and Scotland; and, running from north east to south-west, falls into the Solway frith: it gives name to the country of Eskdale.

**ESKIMAUX**, sometimes called New Britain, and Terra de Labrador, is an extensive country of North America, situated between 59° and 80° W. long. and between 50° and 64° N. lat.

It is bounded by Hudson's straits, which separate it from Greenland, on the north; by the Atlantic ocean, on the east; by the river and bay of St Laurence, on the south-east; and by Hudson's bay, on the west.

**ESLINGEN**, an imperial city of Swabia in Germany, seven miles south-east of Stutgard.

**ESOX**, in ichthyology, a genus belonging to the order of abdominales. The body is elongated; the head is plainish above; the upper jaw is plain, and shorter than the under one, which is dotted; and the branchiostege membrane has from seven to twelve rays. There are nine species.

**ESPALIERS**, in gardening, are rows of trees planted about a whole garden or plantation, or in hedges, so as to inclose quarters or separate parts of a garden; and are trained up regularly to a lattice of wood work in a close hedge, for the defence of tender plants against the injuries of wind and weather.

The trees chiefly planted for espaliers, are apples, pears, and some plumbs. See **GARDENING**.

**ESPERIE**, a city of Hungary, forty miles north of Tokay: it is remarkable for its salt mines.

**ESPINAL**, a town of Lorraine on the Moselle, thirty-five miles south-east of Nancy.

**ESPLANADE**, in fortification, the sloping of the parapet of the covered way towards the campaign.

**ESPLEES**, in law, the general products which lands yield, or the profit or commodity that is to be taken or made of a thing.

**ESPOUSALS**, in law, signify a contract or promise made between a man and a woman, to marry each other; and in cases where marriage may be consummated, espousals go before. Marriage is termed an *espousal de presenti*.

**ESQUIRE** was anciently the person that attended a knight in time of war, and carried his shield.

This title has not for a long time, had any relation to the office of the person, as to carry arms, &c. Those to whom the title of esquire is now of right due, are all noblemens younger sons, and the eldest sons of such younger sons; the eldest sons of knights, and their eldest sons; the officers of the king's courts, and of his household; counsellors at law, justices of the peace, &c. though those latter are only esquires in reputation: besides, a justice of the peace holds this title no longer than he is in commission, in case he is not otherwise qualified to bear it: but a sheriff of a county, who is a superior officer, retains the title of esquire during life, in consequence of the trust once reposed in him: the heads of some ancient families are said to be esquires by prescription.

**ESQUIRES of the king**, are such as have that title by creation, wherein there is some formality used, as the putting about their necks a collar of SS, and bestowing on them a pair of silver-spurs, &c.

**ESSAY**, a trial or experiment for proving the quality of any thing; or an attempt to learn, whether or no any invention will succeed.

**ESSAY**, in literature, a peculiar kind of composition, the character whereof is to be free, easy, and natural; not tied to strict order or method, nor worked up and finished like a formal system.

**ESSAY-HATCH** is the miner's term for a little trench or hole, which they dig to search for shoad or ore.

**ESSECK**, a town of Hungary, near the confluence of the rivers Drave and Danube, with a bridge five miles over: it lies about eighty miles north-west of Belgrade.

**ESSEN**, a town of Westphalia, about ten miles north-east of Dusseldorp.

**ESSENCE**, in metaphysics, that which constitutes the particular nature of each genus or kind, and distinguishes it from all others; being nothing but that abstract idea to which this name is affixed; so that every thing contained in it, is essential to that particular kind.

**ESSENES**, or **ESSENIANS**, in Jewish antiquity, one of the three ancient sects among that people. They allowed a future state, but denied a resurrection from the dead. Their way of life was very singular: they did not marry, but adopted the children of others, whom they bred up in the institutions of their sect: they despised riches, and had all things in common, and never changed their cloaths till they were entirely worn out. When initiated, they were strictly bound not to communicate the mysteries of their sect to others; and if any of their members were found guilty of enormous crimes, they were expelled.

Pliny tells us, that they dwelt on the west side of the lake of Asphaltites; and that they were a solitary kind of men, living without women or money, and feeding upon the fruit of the palm-tree: he adds, that they were constantly recruited by new-comers, whom the surges of ill fortune had made weary of the world; in which manner the sect was kept up for several thousands of years, without any being born among them. The reason why we find no mention made of them in the New Testament, may be their recluse and retired way of life, no less than their great simplicity and honesty, whereby they lay open to no censure or reproof.

**ESSENTIAL**, something necessarily belonging to a thing, from which it cannot be conceived distinct: thus the primary qualities of bodies, as extension, figure, number, &c. are essential or inseparable from them in all their changes and alterations.

**ESSENTIAL OIL**. See **CHEMISTRY**, p. 93.

**ESSEX**, a county of England, bounded by Suffolk, on the north; by the German sea, on the east; by the river Thames, which divides it from Kent, on the south; and by Middlesex and Hertfordshire, on the west.

**ESSOIN**, in law, an excuse for a person summoned to appear and answer to an action, on account of the sickness or other just cause of his absence.

**ESSORANT**, in heraldry, denotes a bird standing on the

the ground with its wings expanded, as if it had been wet, and were drying itself.

**ESTATE**, in law, signifies the title or interest that a person has in lands, tenements, or other effects.

**ESTATES**, in a political sense, is used either to denote the dominions of some prince, or the general classes into which the people are divided.

In Britain, the estates are the king, lords, and commons; or rather the lords and commons, who meet the king in parliament, for reforming abuses, and enacting good and wholesome laws.

**ELSETE'**, in heraldry, denotes the heads of beasts torn off by main force. See **ARACHE'** and **ERASED**.

**ESTHER**, a canonical book of the Old Testament, containing the history of a Jewish virgin, dwelling with her uncle Mordecai at Shushan, in the reign of Ahasuerus, one of the kings of Persia.

**ESTOILE'E**, or **CROSS ESTOILLE'E**, in heraldry, a star with only four long rays in form of a cross; and, accordingly, broad in the centre, and terminating in sharp points.

**ESTONIA**, a province subject to Russia, on the north of Livonia.

**ESTRAY**, in law, any beast not wild that is found within a lordship, and owned by nobody.

**ESTREMADURA**, a province of Spain, bounded by Leon, on the north; by the two Castiles, on the east; by Andalusia, on the south; and by the province of Alentejo, in Portugal, on the west.

**ESTREMADURA** is also a province of Portugal, lying north of Alentejo, and westward of Spanish Estremadura. Lisbon is its capital, as also of the kingdom.

**ESTREMOS**, a town of Alentejo, in Portugal, eighty-five miles south east of Lisbon.

**ETCHING**, a method of engraving on copper, in which the lines or strokes, instead of being cut with a tool or graver, are eaten in with aquafortis.

Etching is done with more ease and expedition than engraving: it requires fewer instruments, and represents most kind of subjects better and more agreeable to nature, as landscapes, ruins, grounds, and all small, faint, loose, remote objects, buildings, &c. See **ENGRAVING**.

The method of etching is as follows: Chuse the copperplate as directed for engraving, and furnish yourself with a piece of ground, tied up in a bit of thin silk, kept very clean, to be laid upon the plate, when both have been warmed; proper needles, to hatch with on the ground; a pencil or brush, to wipe away the bits of ground which rise after its hatching; a polisher; two or three gravers; a pair of compasses, to measure distances and draw circles; a ruler, to hatch straight lines; green wax, to make the wall round the edges of the plate, to contain the aquafortis; an oil-stone; a bottle of aquafortis; some red lead, to colour the back side of the copy; a stift, and a hand-vice, to hold the plate over the candle. See **NEEDLE**, **GRAVER**, **POLISHER**, **COMPASS**, &c.

To make the ground, take three ounces of asphaltum, two ounces of clean rosin, half an ounce of Burgundy-pitch, three ounces of black wax, and three

ounces of virgin-wax: let all these be melted in a clean earthen pipkin over a slow fire, stirring it all the time with a small stick; if it burn to the bottom, it is spoiled. After the ingredients are well melted, and it boils up, put it into a pan of fair water; and before it be quite cold, take it out, and roll it into small lumps to be kept from dust: this ground is what others call the varnish. The next thing is to clean the plate to receive the ground: take a piece of lising, roll it up as big as an egg, tie it very tight, so as to make it a rubber; and having dropped a small quantity of sweet oil, and added a little powder of rotten stone on the plate, rub it with this ball, till it will almost shew your face. Then wipe it all off with a clean rag; and after that, make it quite dry with another clean rag and a little fine whitening.

The next thing is to lay on the varnish; to do which aright you must take a hand-vice, and fix it at the middle of one part of the plate, with a piece of paper between the teeth of the hand-vice and the plate, to prevent the marks of the teeth: then laying the plate on a chaffing-dish, with a small charcoal fire in it, till the plate be so hot, that, by spitting on the back-side, the wet will fly off: rub the plate with the ground tied up in silk, till it be covered all over; and after that daub the plate with a piece of cotton wrapped up in silk, till the ground be quite smooth, keeping the plate a little warm all the time. The varnish being thus smoothed upon the plate, it must be blacked in the following manner: take a thick tallow candle that burns clear, with a short snuff; and having driven two nails into the wall, to let it rest upon, place the plate against the wall with the varnish side downward, and take care not to touch the ground with your fingers: then taking the candle, apply the flame to the varnish as close as possible, without touching the varnish with the snuff of the candle, and guide the flame all over it, till it become perfectly black. After this is done, and the plate dry, the design is traced with a needle through the varnish, and a rim or border of wax is raised round the circumference of the plate; and then the artist has a composition of common varnish and lamp-black, made very thin, wherewith he covers the parts that are not to be bitten, by means of a hair-pencil. And he is every now and then covering or uncovering this or that part of the design, as occasion may require; the conduct of the aquafortis being the principal concern, on which the effect of the print very much depends. The operator must be attentive to the ground, that it does not fail in any part, and where it does to stop up the place with the above composition. The plate is defended from the aquafortis every where, but in the lines or hatches cut through it with the needle, through which the water eats into the copper to the depth required; remembering to keep it stirring with a feather all the while; which done, it is to be poured off again.

Single aquafortis is most commonly used; and if it be too strong, mix it with vinegar, otherwise it will make the work very hard, and sometimes break up the ground: the aquafortis having done its part, the ground

ground is taken off, and the plate washed and dried: after which nothing remains for the artist, but to examine the work with his graver, to touch it up, and heighten it where the aquafortis has missed.

And, lastly, it is to be remembered, that a fresh dip of aquafortis is never given, without first washing out the plate in fair water, and drying it at the fire.

**ETERNITY**, an attribute of God, expressing his infinite or endless duration.

According to Mr Locke, we come by the idea of eternity, by being able to repeat any part of time, as a year, as often as we will, without ever coming to an end.

**ETHER.** See **ÆTHER.**

**ETHICS.** See **MORALS.**

**ETHIOPIA**, or **ÆTHIOPIA**, a very extensive country of Africa, comprehending Abyssinia, Nubia, and Abex: it is bounded by Egypt, and the desert of Barca, on the north; by the Red sea and Indian ocean, on the east; by Anian, and the unknown parts of Africa, on the south; and by other unknown countries on the west.

**ETHMOIDAL**, in anatomy. See **ANATOMY**, p. 152.

**ETHMOIDES OS**, in anatomy. See **ANAT.** p. 157.

**ETNA**, or mount **GIBELLO**, a volcano, or burning mountain of Sicily, situated sixty miles south-west of Messina, and twenty west of Catania. See **VULCANO.**

**ETYMOLOGY**, that part of grammar which considers and explains the origin and derivation of words, in order to arrive at their first and primary signification. See **GRAMMAR.**

**EVACUANTS**, in pharmacy, are properly such medicines as diminish the animal fluids, by throwing out some morbid or redundant humour, or such as thin, attenuate, and promote the motion and circulation thereof.

**EVACUATION**, in medicine, the art of diminishing, emptying, or attenuating the humours of the body. See **MEDICINE.**

**EVANGELIST**, a general name given to those who write or preach the gospel of Jesus Christ.

The word is of Greek origin, signifying one who publishes glad tidings, or is the messenger of good news.

According to Hooker, evangelists were presbyters of principal sufficiency, whom the apostles sent abroad, and used as agents in ecclesiastical affairs, wheresoever they saw need.

The term evangelist however is at present confined to the writers of the four gospels.

**EVANID**, a name given by some authors to such colours as are of no long duration, as those in the rainbow, in clouds before and after sun set, &c.

Evanid colours are also called fantastical and emphatical colours.

**EVANTES**, in antiquity, the priestesses of Bacchus, thus called, by reason, that in celebrating the orgia, they ran about as if distracted, crying, *Evav, evan, olé evan.* See **BACCHANALIA.**

**EVAPORATION**, in chemistry, the setting a liquor in a gentle heat to discharge its superfluous humidity, re-

duce it to a proper consistence, or obtain its dry remainder. See **CHEMISTRY.**

**EVATES**, a branch or division of the druids, or ancient Celtic philosophers. Strabo divides the British and Gaulish philosophers into three sects; bards, evates, and druids. He adds, that the bards were the poets and musicians; the evates, the priests and naturalists; and the druids were moralists as well as naturalists: But Marcellus and Hornius reduce them all to two sects, *viz.* the bards and druids.

**EUBAGES**, an order of priests, or philosophers, among the ancient Celta, or Gauls: some will have the eubages to be the same with the druids and saronidæ of Diodorus; and others, that they were the same with what Strabo calls evates.

**EUCCHARIST**, the sacrament of the Lord's supper, properly signifies giving thanks.

This sacrament was instituted by Christ himself, and the participation of it called communion.

As to the manner of celebrating the eucharist among the ancient Christians, after the customary oblations were made, the deacon brought water to the bishops and presbyters, standing round the table, to wash their hands, according to that of the psalmist, "I will wash my hands in innocency, and so will I compass thy altar, O Lord." Then the deacon cried out aloud, "Mutually embrace and kiss each other;" which being done, the whole congregation prayed for the universal peace and welfare of the church, for the tranquillity and repose of the world, for the prosperity of the age, for wholesome weather, and for all ranks and degrees of men. After this followed mutual salutations of the minister and people; and then the bishop or presbyter having sanctified the elements by a solemn benediction, he brake the bread, and delivered it to the deacon, who distributed it to the communicants; and after that the cup. Their sacramental wine was usually diluted or mixed with water. During the time of administration, they sang hymns and psalms; and, having concluded with prayer and thanksgiving, the people saluted each other with a kiss of peace, and so the assembly broke up.

**EVER-GREEN**, in gardening, a species of perennials, which continue their verdure, leaves, &c. all the year: such are hollies, phillyria's, laurustinus's, bays, pines, firs, cedars of Lebanon, &c.

**EVERLASTING PEA**, a genus of plants, otherwise called lathyrus. See **LATHYRUS.**

**EVESDROPPERS**, in law, persons who stand under the eaves, walls, or windows of a house, by day or by night, to listen after news, and carry it to others, thereby raising strife and contention in the neighbourhood.

**EVESHAM**, a borough town thirteen miles south-east of Worcester, which sends two members to parliament.

**EUGENIA**, the **SILVER TREE**, in botany, a genus of the icofandria monogynia class. The calix is above the fruit, and consists of four segments; the petals are four; and the drupa is quadrangular, and contains

062

- one fixed. There are five species, none of them natives of Britain.
- EVIAN**, a town of Savoy, situated twenty-five miles north-east of Geneva, on the south side of the lake of Geneva.
- EVICTION**, in law, signifies a recovery of lands, or tenements by law.
- EVIDENCE**, that perception of truth which arises either from the testimony of the senses, or from an induction of reason. See **METAPHYSICS**, and **MORALS**.
- EVIDENCE**, in law, any proof, whether it be by testimony of men on oath, or by writings and records so called, because hereby the point in issue is made evident by a jury.
- EVIL**. See **MORALS**.
- King's-EVIL*, in medicine. See **MEDICINE**.
- EULOGY**, in church-history, a name by which the Greeks call the *p. mis benedictus*, or bread over which a blessing is pronounced, and which is distributed to those who are unqualified to communicate.
- EUMENIDES**, in antiquity. See **FURIES**.
- EUNOMIANS**, in church-history, Christian heretics, in the fourth century. They were a branch of Arians, and took their name from Eunomius, bishop of Cyzicus, who was instructed by Ætius, in the points which were then controverted in the church, after having at first followed the profession of arms. Eunomius so well answered the designs of his master, and declaimed so vehemently against the divinity of the **WORD**, that the people had recourse to the authority of the prince, and had him banished; but the Arians obtained his recall, and elected him bishop of Cyzicus. The manners and doctrines of the Eunomians were the same with those of the Arians.
- FUNUCH**, a castrated person. See **CASTRATION**.
- EUNUCHS**, in church-history, a sect of heretics in the third century, who were mad enough to castrate, not only those of their own persuasion, but even all others that they could lay hold of: they took their rise from the example of Origen, who, misunderstanding the following words of our Saviour,—“ And eunuchs who made themselves eunuchs for the kingdom of heaven,”—castrated himself.
- EVOLUTION**, in algebra. See **ALGEBRA**, p. 86.
- EVOLUTION**, in the art of war, the motion made by a body of troops, when they are obliged to change their form and disposition, in order to preserve a post, or occupy another, to attack an enemy with more advantage, or to be in a condition of defending themselves the better.
- EUONYMOIDES**, in botany. See **CELASTRUS**.
- EUONYMUS**, the **SPINDLE-TREE**, in botany, a genus of the pentandria monogynia class. The corolla consists of five petals; the capsule is five-sided, and has five coloured cells; and the seeds have calyptra. There are two species, one of which, *viz.* the *europæus*, spindle-tree, or prickwood, is a native of Britain.
- EVORA**, or **EBORA**, a city of Portugal, seventy miles south-east of Lisbon.
- EUPATORIOPHALACRON**, in botany. See **VIRBESINA**.
- EUPATORIUM**, **HEMP-AGRIMONY**, in botany, a genus of the syngenesia polygamia æqualis class. The receptacle is naked; the pappus is plumose; the calix is oblong and imbricated; and the stylus is long and semi-bifid. There are twenty-one species, only one of which is a native of Britain, *viz.* the *cannabinum*, hemp-agrimony, or Dutch agrimony. The leaves are said to strengthen the stomach.
- EUPHYMISM**, in rhetoric, a figure which expresses things in themselves disagreeable and shocking, in terms implying the contrary quality.
- EUPHORBIA**, in botany, a genus of the dodecandria trigynia class. The corolla consists of four or five petals; and the calix has but one leaf. There are sixty-two species, twelve of which are natives of Britain, *viz.* the *peplus*, or small purple sea-spurge; the *peplus*, or petty spurge; the *exigua*, or dwarf-spurge; the *segetalis*, or corn-spurge; the *helioscopia*, sun-spurge, or wart-wort; the *portlandica*, or Portland spurge; the *paralias*, or sea-spurge; the *verrusca*, or rough fruited spurge; the *platyphyllus*, or broad-leaved spurge; the *amygdaloides*, or wood-spurge; the *characias*, or red spurge; and the *hyberna*, or knotty-rooted spurge. The spurges are exceedingly acrid, and are now rejected both by the Edinburgh and London dispensaries.
- EUPHORBIVM**, in pharmacy, a gum resin brought us always in loose, smooth, and glossy gold-coloured drops or granules. It is the produce of the *euphorbium antiquorum verum*, which grows to ten or twelve feet high. Its principal use is externally in sinapisms, and plasters applied to the feet, which are intended to stimulate, but not absolutely to raise blisters: for it is observed by Avicenna, that when taken internally in large doses, it has been found to exulcerate the intestines, and bring on death itself, after the most terrible symptoms.
- EUPHRASIA**, in botany, a genus of the didynamia angiospermia class. The calix is cylindrical, and consists of four segments; and the capsule is oblong and bilocular. There are six species, two of which are natives of Britain, *viz.* the *officinalis*, or eye-bright; and the *odontites*, or red eye bright. The eye-bright was formerly celebrated as an ophthalmic, but is now totally disregarded.
- EUPHRATES**, the finest river in Turkey in Asia, has two sources, northward of the city of Erzerum, in 40° N. lat. After passing through Armenia, it divides Syria from Diarbec or Assyria, runs through Eyraca or Chaldea; and uniting with the Tygris, it passes by the city of Bassora, fifty miles below which it falls into the gulf of Persia.
- EUREUX**, a city of Normandy in France, twenty-five miles south of Rouen.
- EURIPUS**, a strait between the island of Negropont, and the continent of Greece, remarkable for its irregular tides.
- The term *euripus* is sometimes used, in a more general

general sense, for any straits where the water is much agitated.

**EUROPE**, the East of the four grand divisions of the earth, is situated between  $36^{\circ}$  and  $72^{\circ}$  N. lat ; and between  $10^{\circ}$  degrees W. long. and  $65^{\circ}$  E. long. being about 3000 miles long from north to south, and 2500 miles broad from east to west. It is bounded by the frozen ocean on the north, by Asia on the east, by the Mediterranean, which separates it from Africa, on the south, and by the Atlantic ocean on the west.

Europe is commonly subdivided into three grand divisions, north, middle, and south. The north or upper division comprehends Russia, or Muscovy, Sweden, Denmark, and Norway, and the islands of Britain, Iceland, Greenland, and those of the Baltic. The middle division contains Poland, Germany, and the hereditary dominions of the house of Austria, the Low Countries, or Netherlands, and France. The southern division comprehends Turkey in Europe, the ancient Greece chiefly, Switzerland Italy, Spain and Portugal, and the islands of Sicily, Sardinia, Corsica, Majorca, Minorca, Ivica, and those of the Archipelago.

**EURYTHMY**, in architecture, painting, and sculpture, is a certain majesty, elegance, and easiness, appearing in the composition of divers members, or parts of a body, painting, or sculpture, and resulting from the fine proportion of it.

**EUSTACE**, or **EUSTATIA**, one of the Caribbee islands, four miles west of St Christopher's, and subject to the Dutch.

**EUSTYLE**, in architecture, a sort of building in which the pillars are placed at the most convenient distance one from another, the intercolumniations being just two diameters and a quarter of the column, except those in the middle of the face, before and behind, which are three diameters distant.

**EUTYCHIANS**, in church-history, heretics in the Vth century, who embraced the errors of the monk Eutyches, maintaining that there was only one nature in Jesus Christ.

**EUXINE**, the same with the Black Sea. See **BLACK SEA**.

**EWAGE**, a toll paid for the passage of water, and otherwise called aquage.

**EWE**, the English name of a female sheep. See **OVIS**.

**EWRY**, in the British customs, an office in the king's household, which has the care of the table-linen, of laying the cloth, and serving up water in silver ewers after dinner.

**EXACERBATION**. See **PARONYSM**.

**EXACUM**, in botany, a genus of the tetrandria monogynia class. The calix consists of four leaves, and the corolla of four segments, with a roundish tube; the capsule is bifurcated, and has two cells containing many seeds. There are two species, none of them natives of Britain.

**EXAREISIS** in surgery, the operation of extracting or taking away something that is hurtful to the human body.

**EXAGGERATION**, in rhetoric, a kind of hyperbole,

whereby things are augmented or amplified, by saying more than the truth, either as to good or bad.

**EXAGGERATION**, in painting, a method by which the artist, in representing things, changes them too much, or makes them too strong, either in respect of the design or the colouring.

**EXALTATION**, in chemistry, signifies an operation by which a substance has its properties changed, and raised to a higher degree of dignity and virtue.

**EXAMINERS**, in chancery, two officers of that court, who examine, upon oath, witnesses produced in causes depending there, by either the complainant or defendant, where the witnesses live in London, or near it. Sometimes parties themselves, by particular order, are examined. In the country, above twenty miles from London, on the parties joining in commission, witnesses are examined by commissioners, being usually counsellors or attorneys not concerned in the cause.

**EXANTHEMA** among physicians, denotes any kind of efflorescence or eruption, as the measles, purple spots in the plague, or malignant fevers, &c.

**EXARCH**, in antiquity, an officer sent by the emperors of the east into Italy, in quality of vicar, or rather prefect, to defend that part of Italy which was yet under their obedience, and particularly the city of Ravenna, against the Lombards. The exarch resided at Ravenna, which place, with Rome, was all that was left to the emperors of their Italian dominions. The first exarch was under Justin the younger, in the year 567, after Belisarius and Narces had driven the barbarians out of Italy. The last was Eutychius, defeated by Adolphus king of the Lombards in 752.

**EXCELLENCY**, a title anciently given to kings and emperors, but now to ambassadors, and other persons who are not qualified for that of *highness*, and yet are to be elevated above the other inferior dignities.

**EXCENTRIC**, in geometry, a term applied to circles and spheres which have not the same centre, and consequently are not parallel; in opposition to concentric, where they are parallel, having one common centre.

**EXCENTRICITY**, in astronomy, is the distance of the centre of the orbit of a planet from the centre of the sun; that is, the distance between the centre of the ellipse and the focus thereof. See **ASTRONOMY**.

**EXCEPTION**, in law, denotes a stop or stay to an action.

**EXCERPTA**, in matters of literature. See **EXTRACT**.

**EXCESS**, in arithmetic and geometry, is the difference between any two unequal numbers or quantities, or that which is left after the lesser is taken from or out of the greater. See **ARITHMETIC**.

**EXCHANGE**, in a general sense, a contract or agreement, whereby one thing is given or exchanged for another.

**EXCHANGE**, in commerce, is the receiving or paying of money in one country for the like some in another, by means of bills of exchange.

The security which merchants commonly take from one another when they circulate their business, is a bill



bill of exchange, or a note of hand: these are looked upon as payment.

The punctuality of acquitting those obligations is essential to commerce; and no sooner is a merchant's accepted bill protested, than he is considered as a bankrupt. For this reason, the laws of most nations have given very extraordinary privileges to bills of exchange. The security of trade is essential to every society; and were the claims of merchants to linger under the formalities of courts of law when liquidated by bills of exchange, faith, confidence, and punctuality would quickly disappear, and the great engine of commerce would be totally destroyed.

A regular bill of exchange is a mercantile contract, in which four persons are concerned, *viz.* 1. The drawer, who receives the value: 2. His debtor in a distant place, upon whom the bill is drawn, and who must accept and pay it: 3. The person who gives value for the bill, to whose order it is to be paid: and, 4. The person to whom it is ordered to be paid, creditor to the third.

By this operation, reciprocal debts, due in two distant parts, are paid by a sort of transfer, or permutation of debtors and creditors.

(A) in London is creditor to (B) in Paris, value 100*l.* (C) again in London is debtor to (D) in Paris for a like sum. By the operation of the bill of exchange, the London creditor is paid by the London debtor, and the Paris creditor is paid by the Paris debtor; consequently, the two debts are paid, and no money is sent from London to Paris, nor from Paris to London.

In this example, (A) is the drawer, (B) is the acceptor, (C) is the purchaser of the bill, and (D) receives the money. Two persons here receive the money, (A) and (D), and two pay the money, (B) and (C); which is just what must be done when two debtors and two creditors clear accounts.

This is the plain principle of a bill of exchange. From which it appears, that reciprocal and equal debts only can be acquitted by them.

When it therefore happens that the reciprocal debts of London and Paris (to use the same example) are not equal, there arises a balance on one side. Suppose London to owe Paris a balance, value 100*l.* How can this be paid? Answer, It may either be done with or without the intervention of a bill.

With a bill, if an exchanger, finding a demand for a bill upon Paris for the value of 100*l.* when Paris owes no more to London, sends 100*l.* to his correspondent at Paris in coin, at the expence (suppose) of 1*l.* and then, having become creditor on Paris, he can give a bill for the value of 100*l.* upon his being repaid his expence, and paid for his risk and trouble.

Or it may be paid without a bill, if the London debtor sends the coin himself to his Paris creditor, without employing an exchanger.

This last example shews of what little use bills are in the payment of balances. As far as the debts are equal, nothing can be more useful than bills of exchange; but the more they are useful in this easy way of business, the less profit there is to any person to make a trade of ex-

change, when he is not himself concerned either as debtor or creditor.

When merchants have occasion to draw and remit bills for the liquidation of their own debts, active and passive, in distant parts, they meet upon change; where, to pursue the former example, the creditors upon Paris, when they want money for bills, look out for those who are debtors to it. The debtors to Paris again, when they want bills for money, seek for those who are creditors upon it.

This market is constantly attended by brokers, who relieve the merchant of the trouble of searching for those he wants. To the broker every one communicates his wants, so far as he finds it prudent; and by going about among all the merchants, the broker discovers the side upon which the greater demand lies, for money, or for bills.

He who is the demander in any bargain, has constantly the disadvantage in dealing with him of whom he demands. This is no where so much the case as in exchange, and renders secrecy very essential to individuals among the merchants. If the London merchants want to pay their debts to Paris, when there is a balance against London, it is their interest to conceal their debts, and especially the necessity they may be under to pay them; from the fear that those who are creditors upon Paris would demand too high a price for the exchange over and above par.

On the other hand those who are creditors upon Paris, when Paris owes a balance to London, are as careful in concealing what is owing to them by Paris, from the fear that those who are debtors to Paris would avail themselves of the competition among the Paris creditors, in order to obtain bills for their money, below the value of them, when at par. A creditor upon Paris, who is greatly pressed for money at London, will willingly abate something of his debt, in order to get one who will give him money for it.

From the operation carried on among merchants upon change, we may discover the consequence of their separate and jarring interests. They are constantly interested in the state of the balance. Those who are creditors on Paris, fear the balance due to London; those who are debtors to Paris, dread a balance due to Paris. The interest of the first is to dissemble what they fear; that of the last, to exaggerate what they wish. The brokers are those who determine the course of the day: and the most intelligent merchants are those who dispatch their business before the fact is known.

Now, how is trade in general interested in the question, Who shall outwit, and who shall be outwitted, in this complicated operation of exchange among merchants?

The interest of trade and of the nation is principally concerned in the proper method of paying and receiving the balances. It is also concerned in preserving a just equality of profit and loss among all the merchants, relative to the real state of the balance. Unequal competition among men engaged in the same pursuit, constantly draws along with it bad consequences to the general undertaking; and secrecy in trade will be found, upon examination, to be much more useful to merchants in their private

private capacity, than to the trade they are carrying on.

Merchants endeavour to simplify their business as much as possible; and commit to brokers many operations which require no peculiar talents to execute. This of exchange is of such a nature, that it is hardly possible for a merchant to carry on the business of his bills, without their assistance, upon many occasions. When merchants come upon change, they are so full of fears and jealousies, that they will not open themselves to one another, lest they should discover what they want to conceal. The broker is a confidential man, in some degree, between parties, and brings them together.

Besides the merchants who circulate among themselves their reciprocal debts and credits arising from their importation and exportation of goods, there is another set of merchants who deal in exchange; which is the importation and exportation of money and bills.

Were there never any balance on the trade of nations, exchangers and brokers would find little employment: reciprocal and equal debts would easily be transacted openly between the parties themselves. No man feigns and dissembles, except when he thinks he has an interest in so doing.

But when balances come to be paid, exchange becomes intricate; and merchants are so much employed in particular branches of business, that they are obliged to leave the liquidation of their debts to a particular set of men, who make it turn out to the best advantage to themselves.

Whenever a balance is to be paid, that payment costs, as we have seen, an additional expence to those of the place who owe it, over and above the value of the debt.

If, therefore, this expence be a loss to the trading man, he must either be repaid this loss by those whom he serves, that is, by the nation; or the trade he carries on will become less profitable.

Every one will agree, that the expence of high exchange upon paying a balance, is a loss to a people, no way to be compensated by the advantages they reap from enriching the few individuals among them who gain by contriving methods to pay it off: and if an argument is necessary to prove this proposition, it may be drawn from this principle, to wit, whatever renders the profit upon trade precarious or uncertain, is a loss to trade in general: this loss is the consequence of high exchange; and although a profit does result from it upon one branch of trade, the exchange-business, yet that cannot compensate the loss upon every other.

We may, therefore, here repeat what we have said above, that the more difficulty is found in paying a balance, the greater is the loss to the nation.

*The course of EXCHANGE.*

The course of exchange is the current price betwixt two places, which is always fluctuating and unsettled being sometimes above and sometimes below par, according to the circumstances of trade.

When the course of exchange rises above par, the country where it rises may conclude for certain, that the balance of trade runs against them. The truth of this will appear, if we suppose Britain to import from any foreign place goods to the value of 100,000*l.* at par, and export only to the value of 80,000*l.*; in this case, bills on the said foreign place will be scarce in Britain, and consequently will rise in value; and after the 80,000*l.* is paid, bills must be procured from other places at a high rate to pay the remainder, so that perhaps 120,000*l.* may be paid for bills to discharge a debt of 100,000*l.*

Though the course of exchange be in a perpetual flux, and rises or falls according to the circumstances of trade, yet the exchanges of London, Holland, Hamburg, and Venice, in a great measure regulate those of all other places in Europe.

*I. Exchange with Holland.*

MONEY-TABLE.

<p>8 Pennings, or 2 duytes, 2 Groats, or 16 pennings, 6 Stivers, or 12 pence, 20 Schillings, 20 Stivers, or 40 pence, 6 Guilders, or florins, 2½ Guilders, or florins,</p>	}	make	<p><i>Par in Sterling.</i></p> <p>1 groat or penny = 0 0.54 1 stiver = 0 1.09 1 schilling = 0 6.56 1 pound Flemish = 10 11 18 1 guilder or florin = 1 9.86 1 pound Flemish = 10 11.18 1 rixdollar = 4 6.66</p>	<p><i>s. d.</i></p>
--	---	------	--	---------------------

In Holland there are two sorts of money, bank and current. The bank is reckoned good security; demands on the bank are readily answered; and hence bank-money is generally rated from 3 to 6 per cent. better than the current. The difference between the bank and current money is called the *agio*.

Bills on Holland are always drawn in bank-money; and if accounts be sent over from Holland to Britain in current money, the British merchant pays these ac-

counts by bills, and in this case has the benefit of the *agio*.

PROB. I. *To reduce bank money to current money.*

RULE. As 100 to 100+*agio*, so the given guilders to the answer.

EXAMPLE. What will 2210 guilders in bank money amount to in Holland currency, the *agio* being 3¼ per cent.?

*Guild.*

E X C

*Guill.*

As 100 : 103  $\frac{1}{4}$  :: 2210  
           8           8           825

---

800   825   11050  
           4120  
       17680

---

*Guill. fl. pen.*

8)2210 18232 | 50 (2279 1 4 cur.  
       16 20

---

22 10 | 00 (   
       16 8

---

63 2  
   56 16

---

72 32  
   72 32

---

Or, by practice,

50)2210  
   44.2 = 2 per cent.  
   22.1 = 1 per cent.  
   2.7625 =  $\frac{1}{4}$  per cent.

---

2279.0625

If the agio only be required, make the agio the middle term, thus:

*Guill. fl. pen.*

As 100 : 3  $\frac{1}{4}$  :: 2210 : 69 1 4 agio. Or, work by practice, as above.

PROB. II. To reduce current money to bank money.

RULE. As 100 + agio to 100, so the given guilders to the answer.

EXAMPLE. What will 2279 guilders 1 stiver 4 pennings, Holland currency, amount to in bank money, the agio being 3  $\frac{1}{4}$  per cent.?

*Guill. Guild. Guild. fl. pen.*

As 103  $\frac{1}{4}$  : 100 :: 2279 1 4  
       8           8           20

---

825   800   45581  
       20                   16

---

16500           273490  
       16           45581

---

990           729300  
       165           800

---

8)264000   8)5834400  
   3)33       3)72930 *Guill.*  
    11       11)24310 (2210 bank.

In Amsterdam, Rotterdam, Middleburgh, &c. books and accounts are kept by some in guilders, stivers, and pennings, and by others in pounds, shillings, and pence, Flemish.

( 521 )

E X C

Britain gives 1 l. Sterling for an uncertain number of shillings and pence Flemish. The par is 1 l. Sterling for 36.59 s. Flemish; that is, 1 l. 16 s. 7.08 d. Flemish.

When the Flemish rate rises above par, Britain gains and Holland loses by the exchange, and *vice versa*.

Sterling money is changed into Flemish, by saying,

As 1 l. Sterling to the given rate,

So is the given Sterling to the Flemish sought.

Or, the Flemish money may be call up by practice.

Dutch money, whether pounds, shillings, pence Flemish, or guilders, stivers, pennings, may be changed into Sterling, by saying,

As the given rate to 1 l. Sterling,

So the given Dutch to the Sterling sought.

EXAMPLE. I. A merchant in Britain draws on Amsterdam for 782 l. Sterling: How many pounds Flemish, and how many guilders will that amount to, exchange at 34 s. 8 d. per pound Sterling?

L. s. d.	L.	Decimally.	L. s. d.
If 1 : 34 8 :: 782	12	If 1 : 34 8 :: 782	782
416	782	693	27733
832	3328	242666	2)27109.8
2912	5256	L. 1355 9 4 <i>Flem.</i>	
12)325312	2)27109.8		
2)27109.8			
L. 1355 9 4 <i>Flem.</i>			

By practice.

10 s. = $\frac{1}{2}$	L. s. d.
4 s. = $\frac{1}{5}$	782
8 d. = $\frac{1}{6}$	391
	156 8
	26 1 4
	1355 9 4 <i>Fl.</i>

Or thus:

14 s. = $\frac{7}{5}$	L. s. d.
8 d. = $\frac{1}{6}$	782
	547 8
	26 1 4
	1355 9 4 <i>Fl.</i>

Multiply the Flemish pounds and shillings by 6, and the product will be guilders and stivers; and if there be any pence, multiply them by 8 for pennings; or, divide the Flemish pence by 40, and the quot will be guilders, and the half of the remainder, if there be any, will be stivers, and 1 penny odd will be half a stiver, or 8 pennings, as follows.

L. s. d.	<i>Flem. pence.</i>
1355 9 4	4)32531   2(32 rem.
6	
Guild. 8132 16 <i>fliv.</i>	Guild. 8132 16 <i>fliv.</i>

2. Change 591 l. 5 s. Flemish into Sterling money, exchange at 37 s. 6 d. Flemish per l. Sterling?

**E X C**

*Flem. Ster. Flem.*

<i>s. d. L.</i>	<i>L. s.</i>
If 37 6 : 1 :: 591 5	20
2	_____
5) 75	11025
	2
4) 15	_____
	5) 23650
3	_____
	5) 4730
	_____
	3) 946

*L. s. d. 315 3/4*  
*Ans. 315 5 8 Ster.*

*Decimally.*

<i>5) L.</i>	<i>L. 5) L.</i>
If 1.875 : 1 :: 591.25	
5) .375	5) 118.25
5) .075	5) 23.65
.015	.015) 4.73(313.8
	45
	23
	15
	_____
	80
	75
	_____
	50
	45
	_____
	* 5

Holland exchanges with other nations as follows, viz. with

Hamburgh, on the dollar,	= 66 2/3
France, on the crown,	= 54
Spain, on the ducat,	= 109 4/7
Portugal on the crusade,	= 50
Venice, on the ducat,	= 93
Genoa, on the pezzo,	= 100
Leghorn, on the piastre,	= 100
Florence, on the crown,	= 120
Naples, on the ducat,	= 74 2/3
Rome, on the crown,	= 136
Milan, on the ducat,	= 102
Bologna, on the dollar,	= 94 4/7

Exchange between Britain and Antwerp, as also the Austrian Netherlands, is negotiated the same way as with Holland, only the par is somewhat different, as will be described in article 2d, following.

**E X C**

II. Exchange with Hamburgh.  
**MONEY-TABLE.**

	<i>Par in Sterling.</i>	<i>s. d.</i>
12 Phennings	} make	1 schilling-lub = 0 1 1/4
16 Schilling-lubs		1 mark = 1 6
2 Marks		1 dollar = 3 0
3 Marks		1 rixdollar = 4 6
6 1/2 Marks		1 ducat = 9 4 1/2

Books and accounts are kept at the bank, and by most people in the city, in marks, schilling-lubs, and phennings; but some keep them in pounds, schillings, and groots Flemish.

The agio at Hamburgh runs between 20 and 40 per cent. All bills are paid in bank-money.

Hamburgh exchanges with Britain by giving an uncertain number of schillings and groots Flemish for the pound Sterling. The groot or penny Flemish here, as also at Antwerp, is worth 1/4 of a penny Sterling; and so something better than in Holland, where it is only 1/8 d. Sterling.

*Flemish.*

6 Phennings	} make	1 groot or penny
6 Schilling lubs		1 schilling
1 Schilling-lub		2 pence or groots
1 Mark		32 pence or groots
7 1/2 Marks		1 pound.

The par with Hamburgh, and also with Antwerp, is 35 s. 6 2/3 d. Flemish for 1 l. Sterling.

EXAMPLES. 1. How many marks must be received at Hamburgh for 300 l. Sterling, exchange at 35 s. 3 d. Flemish per l. Sterling?

<i>L. s. d. L.</i>
If 1 : 35 3 :: 300
12
_____
423
300
_____
123
<i>M. scb.</i>
32) 126900(3965 10
96
_____
309
288
_____
210
192
_____
180
160
_____
(20)
16
_____
) 320
32
_____
(00)

*Decimally.*

E X C

Decimally.  
Flem. s. Marks. Flem. s.

If 20 : 7.5 :: 35 25

4 : 1.5 :: 35.25  
1.5

17625  
3525

4)52.875

Marks in 1 l. Sterling 13.21875  
300

Marks in 300 l. Sterling 3965.62500  
16

3750  
625.

Schilling-lubs 10.000

2. How much Sterling money will a bill of 3965 marks 10 schilling-lubs amount to, exchange at 35 s. 3 d. Flemish per l. sterling?

Fl. s. d. L. St. Mks. sch.

If 35 3 : 1 :: 3965 10

12 32 2

423 7930 20 d.

11897

423)126900(300 l. ster.

Decimally.

4 : 1.5 :: 35.25  
1.5

17625  
3525

4)52.875(14.21875  
13.21875)3965.62500(300 l. ster.  
3965625

III. Exchange with France.

MONEY-TABLE.

	Par in Ster.	s. d.	
12 deniers	} make	{	
20 fols			1 fol = 0 0 $\frac{1}{8}$
3 livres			1 livre = 0 9 $\frac{1}{2}$
		1 crown = 2 5 $\frac{1}{2}$	

At Paris, Rouen, Lyons, &c. books and accounts are kept in livres, fols, and deniers; and the exchange with Britain is on the crown, or ecu, of 3 livres, or 60 fols Tournois. Britain gives for the crown an uncertain number of pence, commonly between 30 and 34, the par, as mentioned above, being 29  $\frac{1}{4}$  d.

E X C

EXAMP. 1. What Sterling money must be paid in London to receive in Paris 1978 crowns 25 fols, exchange at 31  $\frac{1}{4}$  d. per crown?

Sols. d. Cr. fols.

If 60 : 31  $\frac{1}{4}$  :: 1978 25

253 60

118705

253

356115

573525

237410

6)0)3003236|5 Rem.

8)500539 3

12)62567 11

2)0)521|3 13

L. 260 13 11  $\frac{1}{4}$  Ans.

By Practice.

Cr. fols.

1978 25, at 31  $\frac{1}{4}$  d.

d.		
30 = $\frac{1}{4}$		247 5 0
1 $\frac{1}{2}$ = $\frac{1}{8}$		12 7 3
$\frac{1}{2}$ = $\frac{1}{4}$		1 0 7 $\frac{1}{2}$
Sols 20 = $\frac{1}{2}$		0 0 10 $\frac{3}{4}$
5 = $\frac{1}{4}$		0 0 2 $\frac{1}{2}$

260 13 11  $\frac{1}{4}$

If you work decimally, say,

Cr. d. Ster. Cr. d. Ster.

As 1 : 31.625 :: 1978 418 : 62567.427088

2. How many French livres will L. 121 : 18 : 6 Sterling amount to, exchange at 32  $\frac{1}{4}$  d. per crown?

d. Liv. L. s. d.

If 32  $\frac{1}{4}$  : 3 :: 121 18 6

263. 8 20

24 2438

42

117048

58524

Liv. fols den.

263)702288(2670 5 11 Ans.

Rem. (78) = 5 fols 11 deniers.

IV. Exchange with Portugal.

MONEY-TABLE.

		<i>Par in Ster. s. d. f.</i>	
400 rees	} make	1 ree	= 0 0 0.27
1000 rees		1 crusade	= 2 3
		1 millree	= 5 7½

In Lisbon, Oporto, &c books and accounts are generally kept in rees and millrees; and the millrees are distinguished from the rees by a mark set between them thus, 485  $\Psi$  372; that is, 485 millrees and 372 rees.

Britain, as well as other nations, exchanges with Portugal on the millree, the par, as in the table, being 67½ d Sterling. The course with Britain runs from 63 d. to 68 d Sterling *per* millree.

EXAMP. 1. How much Sterling money will pay a bill of 827  $\Psi$  160 rees, exchange at 63½ d. Sterling *per* millree?

<i>Rees. d.</i>	<i>Rees.</i>	
If 1000 : 68½ :: 827.160		
8	507	
<hr/>		
8000	507	579012
		413580
		<hr/>
		Rem. 2
8000	419370.120	
	12)	52421 — 5 d.
	20)	4368 — 8 s.

L. 218 8 5¼ *Ans.*

By Practice.

<i>Rees.</i>	
827.160, at 63½ d.	
<hr/>	
60 = ¼	206.790
3 = ⅓	10.3395
⅓ = ⅓	.861625
⅓ = ⅓	.4308125
<hr/>	
	218.4219375

The rees being thousandth parts of the millrees, are annexed to the integer, and the operation proceeds exactly as in decimals.

2. How many rees of Portugal will 500 l. Sterling amount to, exchange at 5 s. 4½ d. *per* millree?

<i>d.</i>	<i>Rees.</i>	<i>L.</i>
If 6.1½ : 1000 :: 500		
8	8	20
<hr/>		
517	8000	10000
		12
		<hr/>
		120000
		8000

517) 5.000000 (1856.866 *Ans.*

V. Exchange with Spain.

MONEY-TABLE.

		<i>Par in Ster. s. d.</i>	
34 mervadies	} make	1 rial	= 0 5½
8 rials		1 piastra	= 3 7
375 mervadies		1 ducat	= 4 11¼

In Madrid, Bilbao, Cadiz, Malaga, Seville, and most of the principal places, books and accounts are kept in piastres, called also *dollars*, rials, and mervadies; and their exchange with Britain generally on the piastra, and sometimes on the ducat. The course runs from 35 d. to 45 d. Sterling for a piastra or dollar of 8 rials.

EXAMP. 1. London imports from Cadiz, goods to the value of 2163 piastres and 4 rials: How much Sterling will this amount to, exchange at 38½ d. Sterling *per* piastra?

<i>d.</i>	<i>Piastr. Rials.</i>		<i>Rials.</i>	<i>d.</i>
	2163 4, at 38½ d.			38½ each.
24 = ⅓	216 6		4 =	19⅓
12 = ¼	108 3			
2 = ½	18 0 6			
⅓ = ⅓	2 5 0½			
⅓ = ⅓	1 2 6¼			
	<hr/>			
	345 17 1¼			
	1 7⅓			

L. 345 18 8⅓ *Ans.*

2. London remits to Cadiz 345 l. 18 s. 8⅓ d. How much Spanish money will this amount to, exchange at 38½ d. Sterling *per* piastra?

<i>d. Piastr. L. s. d.</i>		
If 38½ : 1 :: 345 18 8⅓		
<hr/>	20	
307	6918	614) 1328389 (2193 piastres.
2	12	1228 ...
614	83024	<hr/>
	16	1003
	<hr/>	614
	498149	3898
	83024	3684
	<hr/>	2149
	1328389	1842
		<hr/>
		307
		8
		<hr/>
		614) 2456 (4 rials.
		2446

VI. Exchange with Venice.

MONEY-TABLE.

5½ Soldi	} make	1 gros
24 Gros		1 ducat = 5c½ d. Sterling.

The money of Venice is of three sorts, viz. two of bank money, and the picoli money. One of the banks deals in banco money, and the other in banco current. The bank money is 20 per cent. better than the banco current, and the banco current 20 per cent. better than the picoli money. Exchanges are always negotiated by the ducat banco, the par being 4s. 2½d. Sterling, as in the table.

Though the ducat be commonly divided into 24 gros, yet bankers and negotiators, for facility of computation, usually divide it as follows, and keep their books and accounts accordingly.

12 Deniers d'or } make { 1 fol d'or  
20 Sols d'or } make { 1 ducat = 50½ d. Sterling.  
The course of exchange is from 45 d. to 55 d. Sterling per ducat.

EXAMP. 1. How much Sterling money is equal to 1450 ducats 18 fols 1 denier, bank money of Venice, exchange at 52½ d. Sterling per ducat?

<i>Duc. d.</i>	<i>Duc. fol. den.</i>	<i>d.</i>	<i>d.</i>
If 1 : 52½ :: 1450 18 1		52½ rate.	
	<i>Sols.</i>		
52½	10 = ½	26¼	
2918	5 = ½	13½	
7295	2 = ½	½	
	1 = ½	¼	
<i>d.</i> 75868	den. 1 = 1/12	0¼	
½ = 729¼			
¼ = 364¾			
		47¼	
76962¾			
47¼			
Rem.			
12)77010(6d.			
2 0)641 7(17s.			

L. 320 17 6 Sterling. *Ans.*

2. How many ducats at Venice are equal to 385 l. 2s. 6d. Sterling, exchange at 4s. 4d. per ducat?

<i>L.</i>	<i>Duc. L.</i>	
If .21β : 1 :: 385.625		
.21β)385.625		
21 385625		
	<i>Duc.</i>	
195)347062.5(1779.8	<i>Ans.</i>	
195		
1520		
1365		
1556		
1365		
1912		
1755		
1575		
1560		
(15)		

Bank money is reduced to current money, by allowing for the agio, as was done in exchange with Holland; viz. say, As 100 to 120, or as 10 to 12, or as 5 to 6, so the given bank money to the current sought. And current money is reduced to bank money by reversing the operation. And in like manner may picoli money be reduced to current or to bank money, and the contrary.

100 ducats banco of Venice.	
In Leghorn = 93 pezzos	In Lucca = 77 crowns
In Rome = 68½ crowns	In Francfort = 139½ florins

VII. Exchange with Genoa.

MONEY-TABLE.

12 Denari } make { 1 foldi s. d.  
20 Soldi } make { 1 pezzo = 4 6 Sterling.

Books and accounts are generally kept in pezzos foldi, and denari; but some keep them in lires, foldi, and denari; and 12 such denari make 1 foldi, and 20 foldi make 1 lire.

The pezzo of exchange is equal to 5½ lires; and, consequently, exchange money is 5½ times better than the lire money. The course of exchange runs from 47 d. to 58 d. Sterling per pezzo.

EXAMP. How much Sterling money is equivalent to 3390 pezzos 16 foldi, of Genoa, exchange at 51¼ d. Sterling per pezzo?

<i>Soldi. d.</i>	<i>Pez. foldi.</i>
If 20 : 51¼ :: 3390 16	
8	20
415	
160	67816
	415
	339080
	67816,
	271264

*d.* *L. s. d.*  
160)28143640(175897¼ = 732 18 1¼

If Sterling money be given, it may be reduced or changed into pezzos of Genoa, by reversing the former operation.

Exchange money is reduced to lire money, by being multiplied by 5½, as follows:

<i>Pez. foldi.</i>	<i>Decimally.</i>
3390 16	3390.8
5½	5.75
16954 0	169550
½ = 1695 8	237356
¼ = 847 14	169540

Lires 19497 2      Lires 19497.100

And lire money is reduced to exchange money by dividing it by 5½.

*Soldi of Genoa.*

In Milan, 1 crown	= 80
In Naples, 1 ducat	= 86
In Leghorn, 1 piaſtic	= 20
In Sicily, 1 crown	= 127½

VIII. Exchange with Leghorn.

MONEY-TABLE.

12 Denari } make { 1 foldi s. d.  
20 Soldi } { 1 piaſtre = 4 6 Ster.

Books and accounts are kept in piaſtres, foldi, and denari. The piaſtre here conſiſts of 6 lire, and the lire contains 20 foldi, and the foldi 12 denari, and conſequently exchange money is 6 times better than lire money. The courſe of exchange is from 47 d. to 58 d. Sterling per piaſtre.

EXAMPLE. What is the Sterling value of 731 piaſtres, at 55½ d. each.

s.	d.	731 piaſtres, at 55½ d.
4 or	48 = ½	146 4
7	= ¼	18 5 6
1½	= ¼	4 11 4½

L. 169 0 10½ Anf.

Sterling money is reduced to money of Leghorn, by reverſing the former operation; and exchange money is reduced to lire money by multiplying by 6, and lire money to exchange money by dividing by 6.

100 piaſtres of Leghorn are  
In Naples = 134 ducats. | In Geneva = 185½ crowns.

Soldi of Leghorn.

In Sicily, 1 crown = 133½

In Sardinia, 1 dollar = 95½

The above are the chief places in Europe with which Britain exchanges directly; the exchanges with other places are generally made by bills on Hamburg, Holland, or Venice. We ſhall here however ſubjoin the par of exchange betwixt Britain and moſt of the other places in Europe, with which we have any commercial intercourſe.

	Par in Sterling.	L. s. d.
Rome	1 crown =	6 1½
Naples,	1 ducat =	3 4½
Florence,	1 crown =	5 4½
Milan,	1 ducat =	4 7
Bologna,	1 dollar =	4 3
Sicily,	1 crown =	5 0
Vienna,	1 rixdollar =	4 8
Aufburgh,	1 florin =	3 1½
Francfort,	1 florin =	3 0
Bremen,	1 rixdollar =	3 6
Breſlau,	1 rixdollar =	3 3
Berlin,	1 rixdollar =	4 0
Stetin,	1 mark =	1 6
Emden,	1 rixdollar =	3 6
Holfenna,	1 rixdollar =	3 8
Dantzic,	13½ florins =	1 0 0
Stockholm,	34½ dollars =	1 0 0
Ruffia,	1 rubble =	4 5
Turkey,	1 aſper =	4 6

The following places, viz. Switzerland, Norem- burgh, Leipſic, Dresden, Oſnaburgh, Brunſwic, Co- logn, Liege, Straſburgh, Cracow, Denmark, Norway, Riga, Revil, Narva, exci. ge with Britain, when direct exchange is made, upon the rixdollar, the par being 4s. 6d. Sterling.

IX. Exchange with America and the Weſt Indies.

In North America and the Weſt Indies, accounts, as in Britain, are kept in pounds, ſhillings, and pence. In North America they have few coins circulating among them, and on that account have been obliged to ſubſtitute a paper-currency for a medium of their commerce; which having no intrinsic value, is ſubjected to many diſadvan- tages, and generally ſuffers a great diſcount. In the Weſt Indies coins are more frequent, owing to their commercial intercourſe with the Spaniſh ſettlements.

Exchange betwixt Britain and America, or the Weſt Indies, may be computed as in the following examples:

1. The neat proceeds of a cargo from Britain to Bol- ton amount to 845 l. 17s. 6d. currency: How much is that in ſterling money, exchange at 80 per cent.?

If 180 : 100

18 : 10 L. s. d.  
9 : 5 :: 845 17 6

5  
9)4229 7 6

L. 469 18 7½ Ster. Anf.

2. Bolton remits to Britain a bill of 469 l. 18 s. 7½ d. Sterling: How much currency was paid for the bill at Bolton, exchange at 80 per cent.?

If 100 : 180 L. s. d.  
5 : 9 :: 469 18 7½

9  
5)4229 7 6  
845 17 6 currency. Anf.

3. How much Sterling money will 1730 l. Jamaica currency amount to, exchange at 40 per cent.?

If 140 : 100

14 : 10 L.  
7 : 5 :: 1780

5  
7)8900

s. d.  
1271 8 6½ Ster. Anf.

Bills of exchange from America, the rate being high, is an expenſive way of remitting money to Britain; and therefore merchants in Britain generally chuſe to have the debts due to them remitted home in ſugar, rum, or other produce.

X. Exchange with Ireland,

At Dublin, and all over Ireland, books and accounts are kept in pounds, ſhillings, and pence, as in Britain; and the exchange on the 100 l. Sterling.

The



The par of one shilling Sterling is one shilling and one penny Irish: and so the par of 100l. Sterling is 108l. 6s. 8d. Irish. The course of exchange runs from 6 to 15 per cent.

EXAMP. 1. London remits to Dublin 586l. 10s. Sterling: How much Irish money will that amount to, exchange at  $9\frac{1}{4}$  per cent.?

	L.	
If 100 :	$109\frac{1}{4}$ ::	586.5
8		877
-----		
800 :	877	41055
		41055
		46920
-----		
800)	514360.5	
	542.950625	
	Anf. 642 l. 19s. Irish.	

By practice.

	586.5	
p. cent.		
10 = $\frac{1}{100}$	58.65	
2 = $\frac{1}{50}$	11.73 sub.	
-----		
8 =	46.92	
1 = $\frac{1}{100}$	5.865	
$\frac{4}{100}$ = $\frac{1}{25}$	2.9325	
$\frac{1}{100}$ = $\frac{1}{100}$	.733125	
-----		
9 $\frac{1}{4}$	56.450625 add	
	642.950625	

2. How much Sterling will 625 l. Irish amount to, exchange at  $10\frac{1}{4}$  per cent.?

If $110\frac{1}{4}$ :	100 ::	625
8		800
-----		
883	800 883)	500000
		(566 5 $0\frac{1}{4}$ Ster. Anf.

XI. Exchange betwixt London and other places in Britain.

The several towns in Britain exchange with London for a small premium in favour of London; such as, 1,  $1\frac{1}{4}$ ; &c. per cent. The premium is more or less according to the demand for bills.

EXAMP. Edinburgh draws on London for 860 l. exchange at  $1\frac{1}{4}$  per cent.: How much money must be paid at Edinburgh for the bill?

	L.	
per cent.	860	
1 = $\frac{1}{100}$	8 12	
$\frac{1}{4}$ = $\frac{1}{4}$	2 3	
$\frac{1}{8}$ = $\frac{1}{8}$	1 6	
-----		
	11 16 6 premium.	
-----		
	871 16 6 paid for the bill.	

To avoid paying the premium, it is an usual practice to take the bill payable at London a certain number of days after date; and in this way of doing, 73 days is equivalent to 1 per cent.

XII. Arbitration of Exchanges.

The course of exchange betwixt nation and nation naturally rises or falls according as the circumstances and balance of trade happen to vary. Now to draw upon and remit to foreign places, in this fluctuating state of exchange, in the way that will turn out most profitable, is the design of arbitration. Which is either simple or compound.

I. Simple Arbitration.

In simple arbitration the rates or prices of exchange from one place to other two are given; whereby is found the correspondent price between the said two places, called the *arbitrated price*, or *par of arbitration*: and hence is derived a method of drawing and remitting to the best advantage.

EXAMP. 1. If exchange from London to Amsterdam be 33 s. 9 d. per l. Sterling; and if exchange from London to Paris be 32 d. per crown; what must be the rate of exchange from Amsterdam to Paris, in order to be on a par with the other two?

Ster.	Flem.	Ster.
s.	s.	s. d. d.
If 20 :	33 9 ::	32
12		12
-----		
240	405	
	32	
-----		
	810	
	1215	

240)12560(54 d. Flem: per crown. Anf.

2. If exchange from Paris to London be 32 d. Sterling per crown; and if exchange from Paris to Amsterdam be 54 d. Flemish per crown; what must be the rate of exchange between London and Amsterdam, in order to be on a par with the other two?

Ster.	Flem.	Ster.
d.	d.	d.
If 32. :	54 ::	240
		240
-----		
	216	
	108	

32)12960(405 (33 9 Flem. per l. Ster. Anf.

From these operations it appears, that if any sum of money be remitted, at the rates of exchange mentioned, from any one of the three places to the second, and from the second to the third, and again from the third to the first, the sum so remitted will come home entire, without increase or diminution.

From

From the par of arbitration thus found, and the course of exchange given, is deduced a method of drawing and remitting to advantage, as in the following example.

3. If exchange from London to Paris be 32 d. Sterling *per* crown, and to Amsterdam 405 d. Flemish *per* l. Sterling; and if, by advice from Holland or France, the course of exchange between Paris and Amsterdam is fallen to 52 d. Flemish *per* crown; what may be gained *per cent.* by drawing on Paris, and remitting to Amsterdam?

The par of arbitration between Paris and Amsterdam in this case, by Ex. 1. is 54 d. Flemish *per* crown. Work as under.

*d. St. Cr. L. St. Cr.*  
If 52 : 1 :: 100 : 750 debit at Paris  
*Cr. d. Fl. Cr. d. Fl.*  
If 1 : 52 :: 750 : 39000 credit at Amsterdam.  
*d. Fl. L. St. d. Fl. L. s. d. Ster.*  
If 405 : 1 :: 39000 : 46 5 11½ to be remitted.

100  
-----  
3 14 0½

But if the course of exchange between Paris and Amsterdam, instead of falling below, rise above the par of arbitration, suppose to 56 d. Flemish *per* crown; in this case, if you propose to gain by the negotiation, you must draw on Amsterdam, and remit to Paris. The computation follows.

*L. St. d. Fl. L. St. d. Fl.*  
If 1 : 405 :: 100 : 40500 debit at Amsterdam.  
*d. Fl. Cr. d. F. Cr.*  
If 56 : 1 :: 40500 : 723¼ credit at Paris.  
*Cr. d. St. Cr. L. s. d. Ster.*  
If 1 : 32 :: 723¼ : 96 8 6¾ to be remitted.

100  
-----  
3 11 5¾ gained *per cent.*

In negotiations of this sort, a fund for remittance is afforded out of the sum you receive for the draught; and your credit at the one foreign place pays your debit at the other.

II. *Compound Arbitration.*

In compound arbitration the rate or price of exchange between three, four, or more places, is given, in order to find how much a remittance passing through them all will amount to at the last place; or to find the arbitrated price, or par of arbitration, between the first place and the last. And this may be done by the following

**RULES.** I. Distinguish the given rates or prices into antecedents and consequents; place the antecedents in one column, and the consequents in another on the right, fronting one another by way of equation.

If the first antecedent, and the last consequent to which the antecedent is required, must always be of the same kind.

If the second antecedent must be of the same kind

with the first consequent, and the third antecedent of the same kind with the second consequent, &c.

IV. If to any of the numbers a fraction be annexed, both the antecedent and its consequent must be multiplied into the denominator.

V. To facilitate the operation, terms that happen to be equal or the same in both columns, may be dropped or rejected, and other terms may be abridged.

VI. Multiply the antecedents continually for a divisor, and the consequents continually for a dividend, and the quot will be the answer or antecedent required.

EXAMPLE. 1. If London remit 1000 l. Sterling to Spain, by way of Holland, at 35 s. Flemish *per* l. Sterling; thence to France, at 58 d. Flemish *per* crown; thence to Venice, at 100 crowns *per* 60 ducats; and thence to Spain, at 360 mervadies *per* ducat; how many piastrres, of 272 mervadies, will the 1000 l. Sterling amount to in Spain?

<i>Antecedents.</i>	<i>Consequents.</i>	<i>Abridged.</i>
1 l. Sterling =	35 s. or 420 d. Fl.	1 = 210
58 d. Flemish =	1 crown France	29 = 1
100 crowns France =	60 ducats Venice	1 = 30
1 ducat Venice =	360 mervadies Spain	1 = 45
272 mervadies =	1 piastrre	17 = 1
How many piastrres =	1000 l. Sterling	= 10

In order to abridge the terms, divide 58 and 420 by 2, and you have the new antecedent 29, and the new consequent 210; reject two ciphers in 100 and 1000; divide 272 and 360 by 8, and you have 34 and 45; divide 34 and 60 by 2, and you have 17 and 30; and the whole will stand abridged as above.

Then, 29 × 17 = 493 divisor; and, 210 × 30 × 45 × 10 = 2835000 dividend; and, 493)2835000(5750½ piastrres. *Ans.*

Or, the consequents may be connected with the sign of multiplication, and placed over a line by way of numerator; and the antecedents, connected in the same manner, may be placed under the line, by way of denominator; and then abridged, as follows:

$$\frac{420 \times 60 \times 360 \times 100}{58 \times 100 \times 272} = \frac{210 \times 60 = 360 \times 10}{29 \times 17 \times 272}$$

$$= \frac{210 \times 60 \times 45 \times 100}{29 \times 34} = \frac{210 \times 30 \times 45 \times 10}{29 \times 17}$$

$$= \frac{2835000}{493}$$

And, 493)2835000(5750½ piastrres. *Ans.*

The placing the terms by way of antecedent and consequent, and working as the rules direct, save so many statings of the rule of three, and greatly shortens the operation. The proportions at large for the above question would stand as under.

*L. St. d. Fl. L. St. d. Fl.*  
If 1 : 420 :: 1000 : 420000  
*d. Fl. Cr. d. Fl. Cr.*  
If 58 : 1 :: 420000 : 7241½

*Cr.*

*Cr. Duc. Cr. Duc.*  
 If 100 : 60 :: 7241 $\frac{1}{2}$  : 4344 $\frac{1}{2}$   
*Duc. Mer. Duc. Mer.*  
 If 1 : 360 :: 4344 $\frac{1}{2}$  : 1564137 $\frac{1}{2}$   
*Mer. Piaſt. Mer. Piaſt.*  
 If 2 $\frac{1}{2}$  : 1 :: 1564137 $\frac{1}{2}$  : 5750 $\frac{1}{2}$

If we ſuppoſe the courſe of direct exchange to Spain to be 42 $\frac{1}{2}$  d. Sterling *per* piaſtre, the 1000l. remitted would only amount to 5647 $\frac{1}{2}$  piaſtres; and, conſequent-ly, 103 piaſtres are gained by the negotiation; that is, about 2 *per cent.*

2. A banker in Amſterdam remits to London 400l. Flemiſh; firſt to France at 56d. Flemiſh *per* crown; from France to Venice at 100 crowns *per* 60 ducats; from Venice to Hamburg at 100 d. Flemiſh *per* ducat; from Hamburg to Liſbon at 50 d. Flemiſh *per* cruſade of 400 rees; and, laſtly, from Liſbon to London at 64 d. Sterling *per* milree: How much Sterling money will the remittance amount to? and how much will be gained or ſaved, ſuppoſing the direct exchange from Holland to London at 36s. 10d. Flemiſh *per* l. Sterling?

*Antecedents. Conſequents.*  
 56 d. Flem. = 1 crown  
 100 crowns = 60 ducats.  
 1 ducat = 100 d. Flem.  
 50 d. Flem. = 400 rees.  
 1000 rees = 64 d. Sterling.

How many d. Ster = 400l. or 96000 d. Flemiſh?

This, in the fractional form, will ſtand as follows.

$$\frac{60 \times 100 \times 400 \times 64 \times 96000}{50 \times 100 \times 50 \times 1000} = \frac{368640}{7}, \text{ and}$$

7)368640(52662 $\frac{2}{7}$  d. Ster. = 219l. 8. s. 6 $\frac{2}{7}$  d. St. *Anſ.*

To find how much the exchange from Amſterdam di-rectly to London, at 36s. 10d. Flemiſh *per* l. Sterling, will amount to, ſay,

<i>s. d.</i>	<i>d. Fl. L. St. d. Fl. L.</i>	<i>s. d. St.</i>
36 10	If 442 : 1 :: 96000 : 217 3 10 $\frac{1}{2}$	
12		219 8 6 $\frac{1}{2}$
<hr/>		
442	Gained or ſaved,	2 4 8 $\frac{1}{2}$

In the above example, the par of arbitration, or the arbitrated price, between London and Amſterdam, *viz.* the number of Flemiſh pence given for 1l. Sterling, may be found thus :

Make 64 d. Sterling, the price of the milree, the firſt antecedent; then all the former conſequents will be-come antecedents, and all the antecedents will become conſequents. Place 240, the pence in 1l. Sterling, as the laſt conſequent, and then proceed as taught above, *viz.*

*Antecedents. Conſequents.*  
 64 d. Ster. = 1000 rees.  
 400 rees = 50 d. Flem.  
 100 d. Flem. = 1 ducat.  
 60 ducats = 100 crowns.  
 1 crown = 56 d. Flem.

How many d. Flem. = 240 d. Ster. ?  
 $\frac{1000 \times 50 \times 100 \times 56 \times 240}{64 \times 400 \times 100 \times 60} = \frac{975}{2}, \text{ and}$

2)975(437 $\frac{1}{2}$  d. = 36s. 5 $\frac{1}{2}$  d. Flem. *per* l. Ster. *Anſ.*

Or the arbitrated price may be found from the answer to the queſtion, by ſaying,

<i>d. Ster. d. Flem. d St.</i>
If 368640 : 96000 :: 240
7                    7
672000
240
<hr/>
2688
1344

*d. s. d. Flem.*  
 368640)161280000(437 $\frac{1}{2}$  = 36 5 $\frac{1}{2}$  as before.  
 The work may be proved by the arbitrated price thus :  
 As 1l. Sterling to 36s. 5 $\frac{1}{2}$  d. Flemiſh, ſo 219l. 8s. 6 $\frac{2}{7}$  d. Sterling to 400l. Flemiſh.

The arbitrated price compared with the direct courſe ſhows whether the direct or circular remittance will be moſt advantageous, and how much. Thus the banker at Amſterdam will think it better exchange to receive 1l. Sterling for 36s. 5 $\frac{1}{2}$  d. Flemiſh, than for 36s. 10d. Flemiſh.

EXCHANGE ſignifies alſo a place in moſt conſiderable tra-ading cities, wherein the merchants, negociants, agents, bankers, brokers, interpreters, and other perſons concerned in commerce, meet on certain days, and at certain times thereof, to confer and treat to-gether of matters relating to exchanges, remittances, pay-ments, adventures, aſſurances, freightments, and other mercantile negociations, both by ſea and land.

EXCHEQUER, in the British jurisprudence, an ancient court of record, in which all cauſes concerning the re-venues and rights of the crown are heard and determi-ined, and where the crown-revenues are received.

It took this name from the cloth that covered the ta-ble of the court, which was party-coloured, or che-quer'd.

This court is ſaid to have been erected by William the conqueror, its model being taken from a like court eſtabliſhed in Normandy long before that time. An-ciently its authority was ſo great, that it was held in the king's palace, and the acts thereof were not to be examined or controlled in any other of the king's courts; but, at preſent, it is the laſt of the four courts at Weſtmiſter.

In the exchequer, some reckon seven courts, *viz.* those of pleas, accounts, receipts, exchequer-chamber, (which is an assembly of all the judges on difficult matters in law) errors in the exchequer, errors in the king's bench, and, lastly, the court of equity in the exchequer.

But the exchequer, for dispatch of business, is generally divided into two parts; one of which is chiefly conversant in the judicial hearing and deciding of all causes relating to the king's coffers, formerly termed the exchequer of accounts: the other is called the receipt of the exchequer, as being principally employed in receiving and payment of money.

Officers of the receipt may take one penny in the pound, as their fee for sums issued out; and they are obliged, without delay, to receive the money brought thither; and the money received is to be put in chests under three different locks and keys, kept by three several officers. All sheriffs, bailiffs, &c. are to account in the exchequer; and in the lower part, termed the receipt, the debtors of the king, and persons in debt to them, the king's tenants, and the officers and ministers of the court, are privileged to sue one another, or any stranger, and to be sued in the like actions as are brought in the courts of king's bench and common-pleas.

The judicial part of the exchequer, is a court both of law and equity. The court of law is held in the office of pleas, according to the course of common law, before the barons: in this court, the plaintiff ought to be a debtor or accountant to the king; and the leading process is either a writ of subpœna, or quo minus, which last goes into Wales, where no process out of our courts of law ought to run, except a *capias utlagatum*.

The court of equity is held in the exchequer-chamber before the treasurer, chancellor, and barons; but, generally, before the barons only; the lord chief baron being the chief judge to hear and determine all causes. The proceedings in this part of the exchequer, are by English bill and answer, according to the practice of the court of chancery; with this difference, that the plaintiff here must likewise set forth that he is a debtor to the king, whether he be so or not. It is in this court of equity that the clergy exhibit bills for the recovery of their tithes, &c. Here too the attorney-general exhibits bills for any matters concerning the crown; and a bill may be exhibited against the king's attorney by any person aggrieved in any cause prosecuted against him on behalf of the king, to be relieved therein: in which case, the plaintiff is to attend on the attorney-general with a copy of the bill, and procure him to give in an answer thereto; in the making of which he may call in any person interested in the cause, or any officer, or others, to instruct him, that the king be not prejudiced thereby, and his answer is to be put in without oath.

But besides the business relating to debtors, farmers, receivers, accountants, &c. all penal punishments, infractions, and forfeitures upon popular actions, are matters likewise cognizable by this court; where there also sits a justice-baron, who administers the oaths to high-

sheriffs, bailiffs, auditors, receivers, collectors, comptrollers, surveyors and searchers of all the customs, &c.

The exchequer in Scotland, has the same privileges and jurisdiction as that of England; and all matters competent to the one, are likewise competent to the other.

*Black book of the EXCHEQUER*, a book containing a description of the court of England in 1175, and its officers, with their ranks, wages, privileges, perquisites, &c. also the revenues of the crown, both in money and cattle.

**EXCIPIENT**, in pharmacy, denotes the ingredient, which, in compound medicines, receives all the rest; as the conserve in electuaries, the syrup in boluses, &c.

**EXCISE**, a certain duty or impost charged upon liquors, as beer, ale, cyder, &c. malt, and several other commodities, within the kingdom of Great Britain, and town of Berwick upon Tweed.

The excise is one of the most considerable branches of the king's revenue. It was formerly farmed out, but is now managed for the king by commissioners in both kingdoms, who receive the whole product of the excise, and pay it into the exchequer. These commissioners are nine in number in England, and four in Scotland. The former have a salary of 1000 l. a year, the later 500 l. They are obliged by oath to take no fee or reward but from the king himself; and from them there lies an appeal to five other commissioners called commissioners of appeals.

The duty of excise was first granted to king Charles II. by act of parliament in the year 1660, during the life of that monarch. 1. It was 15 d. *per* barrel upon every barrel of beer or ale above 6 s. the barrel, and 3 d. *per* barrel for every barrel of 6 s. or under, brewed for retail; 15 d. for every hoghead of cyder or perry sold by retail; 1 d. for every gallon of strong water, aqua vitæ, &c. 2. A new excise was granted for ever by the fifth money-act of William and Mary, being for every barrel of beer or ale above 6 s. the barrel, 9 d.; and for every barrel of 6 s. or under, 3 d.; for every hoghead of cyder or perry, 1 s. *per* hoghead. In this excise, the price of the liquor is to be reckoned exclusive of the duty. 3. An excise was granted of 6 d. a bushel on malt in the reign of king William, which by subsequent statutes has been continued yearly ever since. But such malt as shall be made for exportation, and be so entered and kept separate from other malt, is exempted from the payment of this duty. 4. Another new excise upon home made liquors was granted in queen Anne's reign; being an additional excise upon every barrel of beer or ale brewed for sale above 6 s. the barrel, 5 d. exclusive of the duties; and for every barrel at 6 s. or under, 1 d.; for every hoghead of cyder or perry, 5 d.; for every gallon of strong waters or aqua vitæ, 1 d. This excise was not laid upon any such liquors imported. 5. An excise on candles was first granted in the reign of queen Anne, and continued for ever, being a duty of 4 d. a pound on wax, and a half-penny the pound on tallow candles, made in Great Britain for sale or not for sale; but makers for their own use may compound for 1 s. a head for every person in their family. An additional excise on candles was afterwards granted.

granted, being the same with the former in every respect. 6. An excise upon hides and skins tanned in Britain, first granted in queen Anne's reign, was an excise of seventeen different kinds, upon so many different kinds of hides and skins particularly named, and upon all others not named, 13 l. *per cent. ad valorem*. An additional excise was afterwards granted, being an additional duty of different kinds, upon so many different sorts of hides and skins particularly named, and on all others not named, 15 l. *per cent.* on the value. 7. An excise on home-made vellum and parchment, first granted by the same act, being 1 s. *per dozen* on vellum, and 6 d. the dozen on parchment. And afterwards an additional excise on vellum, &c. was granted, being an additional duty of 2 s. the dozen on vellum, and 1 s. the dozen on parchment. 8. An excise on hops of home growth was first granted in queen Anne's reign, being 1 d. *per pound*. 9. An excise on paper, pasteboards, milled-boards, and scale-boards, was first granted in the reign of queen Anne, being a duty of eleven different kinds on so many different sorts of paper particularly named, made in Great Britain; on pasteboards, &c. 3 s. the hundred weight, and on all sorts of paper not named, 12 l. *per cent.* on the value. An additional duty on paper, &c. was granted of eleven different kinds, &c. on pasteboard, 1 s. 6 d. the hundred weight, and on all sorts of paper not named, 6 l. *per cent.* on the value; and on painted paper for hangings, a half-penny the yard square. 10. An excise of 1 d. *per pound* on soap made in Great Britain, was granted by the same act; to which an additional excise has been added of a halfpenny *per pound*. 11. An excise upon printed silks, calicoes, linens and stuffs made in Great Britain, and printed, painted, stained or dyed here, was first granted in queen Anne's reign, being a duty of 3 d. on silks and calicoes, and 1½ d. on linen and stuffs the yard square, excepting silk handkerchiefs, linens and stuffs dyed of one colour, and stuffs made of woollen, or the greatest part in value of woollen. And an additional excise was granted of 6 d. the yard of half-yard broad silks; 1 d. the yard square of silk handkerchiefs; 3 d. the yard square of calicoes, and 1½ d. the yard square of linens and stuffs, excepting, as before, calicoes, &c. dyed of one colour, and woollen stuffs. 12. An excise on starch was first granted for 1 d. the pound; and afterwards an additional excise of 1 d. the pound. 13. The excise on gilt and silver wire made in Great Britain, is 8 d. the ounce on gilt wire, and 6 d. the ounce on silver wire.

If any brewers do not make true entries of their liquors brewed, once a-week at the excise-office, they forfeit 10 l. but this is subject to mitigation, so as not to be less than double the duty; and the retailers of beer and ale and strong waters, neglecting to make their entries once a-month of what liquors they retail, are liable to 40 s. penalty. In case any brewer erects or alters any back, copper, cooler, &c. or keeps a private store-house, or if any maltster keeps any private vessel for steeping barley, without giving proper notice to the officers of excise, such brewer or maltster forfeit 50 l. and where they bribe a gauger, it is 10 l. The officers

of excise may go on board ships, and search for any excisable liquors, as officers of the customs do, and seize commodities forfeited, &c. and complaints made at the chief office of excise are to be heard by three or more commissioners; but two justices of the peace have the power to determine in seizures out of the limits of the excise-office in London.

**EXCLAMATION**, in rhetoric, a figure that expresses the violent and sudden breaking out, and vehemence of any passion.

**EXCOMMUNICATION**, an ecclesiastical penalty or censure, whereby such persons as are guilty of any notorious crime or offence, are separated from the communion of the church, and deprived of all spiritual advantages.

Excommunication among the Jews, according to Elias, a German rabbin, was distinguished into three kinds: 1. Niddui, which was a separation of but a few days; 2. Cherem, a separation attended with execration and malediction; and, 3. Shammatha, which was the last and greater excommunication. But Selden says, that niddui and shammatha are the same thing; and therefore that there were but two kinds of excommunication among the Jews, *viz.* the greater and the lesser. They made also another distinction in excommunication, into total or universal, by which a man was excommunicated with regard to all men; and partial, by which a man was excommunicated in one city, and with regard to certain persons, and not others.

It is observable, that not only the judges had the power of excommunicating, but that each particular person in conversation might excommunicate another, and himself likewise; and this excommunication, if well grounded, was of force: nay, if a man dreamed that he was excommunicated by himself or by another, he was considered as an excommunicated person, because this dream was supposed to be sent from God.

As to the effects of the Jewish excommunication, the lesser excluded the excommunicated person from the society of men; that is, he was not to come nearer them than four cubits, neither he, his wife, children, or domestics, according to Buxtorf. The greater absolutely sequestered the person from the conversation of others; and sometimes he was shut up in a small chamber or prison, where he lived alone. Baronius and Beza pretend, that the greater excommunication excluded men from the use of sacred things. Selden, on the contrary, affirms, that they were allowed to be present in the temple, and partake of the public worship. Buxtorf, who is of the same opinion, adds, that whereas others came into the temple at the right hand, and went out at the left, the excommunicated were obliged both to go in and out at the left.

Excommunication, among the modern Jews, is attended with the most terrible consequences. The excommunicated person is refused all human assistance: if there be a corpse in his house, or a child to be circumcised, none must help him. He is cursed by the book of the law, by the curse of Joshua against Jericho, by that of Elisha against the children, by heaven and earth,

earth, and God is besought that a whirlwind may dash him to pieces. He is pelted with stones if he appear in the streets; and if he obtains absolution, it is upon the most mortifying conditions; for he is publicly tied to a post and whipped, after which he lays himself down at the door of the synagogue, and all those who go out pass over him. This was the very case of the famous Jew Acolla.

In the ancient Christian church, the power of excommunication, as well as other acts of ecclesiastical discipline, was lodged in the hands of the clergy, who distinguished it into the greater and lesser. The lesser excommunication, simply called *aphorismus*, separation or suspension, consisted in excluding men from the participation of the eucharist, and the prayers of the faithful. But they were not expelled the church; for they had the privilege of being present at the reading of the scriptures, the sermons, and the prayers of the catechumens and penitents. This excommunication was inflicted for lesser crimes, such as neglecting to attend the service of the church, misbehaviour in it, and the like.

The greater excommunication, called *panteles aphorismus*, total separation and anathema, consisted in an absolute and entire exclusion from the church and the participation of all its rites. When any person was thus excommunicated, notice was given of it by circular letters to the most eminent churches all over the world, that they might all confirm this act of discipline, by refusing to admit the delinquent to their communion. The consequences of this latter excommunication was very terrible. The excommunicated person was avoided in civil commerce and outward conversation. No one was to receive him into his house, nor eat at the same table with him; and when dead, he was denied the solemn rites of burial. It has been a question, whether the ancient church used to add execration to her censures. Grotius thinks this was done, though very seldom, as in the case of Julian the apostate, for whose destruction the ancient Christians absolutely prayed to God. St Chrysostom was utterly against this practice, affirming that we ought not to pray against the sinner, but against his opinions or actions.

The Romish pontifical takes notice of three kinds of excommunication. 1. The minor, incurred by those who have any correspondence with an excommunicated person. 2. The major, which falls upon those who disobey the commands of the holy see, or refuse to submit to certain points of discipline; in consequence of which they are excluded from the church militant and triumphant, and delivered over to the devil and his angels. 3. Anathema, which is properly that pronounced by the pope against heretical princes and countries. In former ages, these papal fulminations were most terrible things; but at present, they are formidable to none but a few petty states of Italy.

Excommunication in the Greek church, cuts the offender off from all communion with the 318 fathers of the first council of Nice, and with the saints; consigns him over to the devil, and the traitor Judas; and condemns his body to remain after death as hard as a flint

or piece of steel, unless he humbles himself and makes atonement for his sins by a sincere repentance. The form abounds with dreadful imprecations; and the Greeks assert, that if a person dies excommunicated, the devil enters into the lifeless corpse; and therefore, in order to prevent it, the relations of the deceased cut his body in pieces, and boil them in wine. It is a custom for the patriarch of Jerusalem annually to excommunicate the pope and the church of Rome; on which occasion, together with a great deal of idle ceremony, he drives a nail into the ground with a hammer, as a mark of malediction.

The form of excommunication in the church of England anciently ran thus: "By the authority of God the Father Almighty, the Son and Holy Ghost, and of Mary the blessed mother of God, we excommunicate, anathematize, and sequester from the pale of holy mother church," &c. The causes of excommunication in England are, contempt of the bishop's court, heresy, neglect of public worship and the sacraments, incontinency, adultery, simony, &c. It is published in the church; and if the offender does not submit in forty days, the civil magistrate interposes, and the excommunicated person is imprisoned till he submits and obtains absolution. Excommunication disables a person from doing any judicial act, as suing in an action at law, being a witness, &c.

Excommunication, among the Pagans, excluded the person from the sacrifices and the temples, and delivered him over to the furies, which was called *exsecrare*, and *diris devovere*. When Marcus Crassus set out on his expedition against the Parthians, Atticus, tribune of the people, not being able to prevent him, ran to the gate of the city through which the general was to pass, and setting a chaffing-dish in the middle of the way with fire in it, when Crassus drew near, he threw some perfumes into the chaffing dish, and pronounced curses against Crassus with great exclamation, and thus excommunicated him.

**EXCORIATION**, in medicine and surgery, the galling or rubbing off of the cuticle, especially of the parts between the thighs, and about the anus.

**EXCREMENT**, whatever is discharged out of the body of animals after digestion, or the fibrous parts of the aliment, mixed with the bile, saliva, and other fluids. Urine and the feces are the gross excrements that are discharged out of the bladder or belly. Other excrements are the various humours that are secreted from the blood through the various strainers in the body, and which serve for several uses, such as the saliva, sweat, bile, the pancreatic juice, lymph, the semen, nails, the hair, the horns and hoofs of animals.

**EXCRESCENCE**, in surgery, denotes every preternatural tumour which arises upon the skin, either in the form of a wart or tubercle. If they are born with a person, as they frequently are, they are called *æti materni*, or marks from the mother; but if the tumour is large, so as to depend from the skin like a fleshy mass, it is then called a sarcoma.

**EXCRETION**, or **SECRETION**, in medicine, a separation of some fluid, mixed with the blood, by means of the

- the glands. Excretions, by which we mean those that evacuate superfluous and heterogeneous humours, purify the mass of blood: the humours which are generated in the blood are excreted by the glands, and are replaced by a sufficient quantity of aliment.
- EXCRETORY**, in anatomy, a term applied to certain little ducts or vessels, destined for the reception of a fluid, secreted in certain glandules, and other viscera, for the excretion of it in the appropriated places.
- Letters of EXCULPATION**, in Scots law, a writ or summons issued by authority of the court of judicary, at the instance of a panel, for citing witnesses to prove his defences, or his objections to any of the jury or witnesses cited against him. See tit. 33
- EXCURSION**, in astronomy, is used in a synonymous sense with elongation. See **ELONGATION**.
- EXECRATION**, in antiquity, a kind of punishment, consisting of direful curses and marks of infamy: such was that used against Philip king of Macedon, by the Athenians. A general assembly of the people being called, they made a decree, that all the statues and images of that king, and of all his ancestors, should be demolished, and their very names razed; that all the festivals, sacred rites, priests, and whatever else had been instituted in honour of him, should be profaned; that the very places where there had been any monument or inscription to his honour, should be detestable; that nothing should be set up, or dedicated in them, which could be done in clean places: and, lastly, that the priests, as often as they prayed for the Athenian people, allies, armies, and fleets, should as many times detest and execrate Philip, his children, kingdom, land and sea forces, and the whole race and name of the Macedonians.
- EXECUTION**, in a general sense, the act of accomplishing, finishing, or achieving any thing.
- EXECUTION** of summonses or letters, in Scots law, see **LAW**, tit. 12. Execution of testaments; see tit. 28. Execution of civil sentences and decrees; see tit. 32. Execution of criminal sentences; see tit. 33.
- EXECUTOR**, in Scots law, signifies either the person intitled to succeed to the moveable estate of one deceased, or who by law or special appointment is intrusted with the administration of it. See tit. 28.
- EXECUTRY**, in Scots law, is the moveable estate falling to the executor. Under executry, or moveables, is comprehended every thing that moves itself, or can be moved; such as corns, cattle, furniture, ready money, &c. See tit. 9. and 28.
- EXEDRÆ**, in antiquity, a general name for such buildings as were distinct from the main body of the churches, and yet within the limits of the church taken in its largest sense. Among the exedræ the chief was the baptistery. See **BAPTISTERY**.
- EXEGESIS**, a discourse by way of explanation or comment upon any subject. In the Scotch universities, there is an exercise among the students in divinity, called an exegesis, in which a question is stated by the respondent, who is then opposed by two or three other students in their turns; during which time the professor moderates, and solves the difficulties which the respondent cannot overcome.
- EXEMPLAR**, denotes much the same with model. See **MODEL**.
- EXEMPLIFICATION** of letters patent, a transcript or duplicate of them, made from the inrollment thereof, and sealed with the great seal.
- EXEMPTION**, in law, a privilege to be free from some service or appearance: thus, barons and peers of the realm are, on account of their dignity, exempted from being sworn upon inquests; and knights, clergymen, and others, from appearing at the sheriff's turn. Persons of seventy years of age, apothecaries, &c. are also by law exempted from serving on juries; and justices of the peace, attorneys, &c. from parish-offices.
- EXERCISE**, among physicians, such an agitation of the body, as produces salutary effects in the animal œconomy. See **MEDICINE**.
- EXERCISE**, in military affairs, is the ranging a body of soldiers in form of battle, and making them perform the several motions and military evolutions with different management of their arms, in order to make them expert therein.
- EXERCITOR**, in Scots law, he who employs a ship in trade, whether he be owner, or only freights her from the owner.
- EXERGUM**, among antiquarians, a little space around or without the figures of a medal, left for the inscription, cypher, device, date, &c.
- EXETER**, the capital city of Devonshire, situated on the river Ex, ten miles north of the British channel: W. long. 3° 40', N. lat. 50° 44'.
- EXFOLIATION**, a term used by surgeons for the scaling of a bone, or its rising and separating into thin laminæ or scales.
- EXHALATION**, a general term for all effluvia or steams raised from the surface of the earth in form of vapour.
- EXHIBIT**, in law, is where a deed, or other writing, being produced in a chancery suit, to be proved by witnesses, the examiner, or commissioner appointed for the examination of any such, certifies on the back of the deed or writing, that the same was shewn to the witness at the time of his examination, and by him sworn to.
- EXHORTATION**, in rhetoric, differs only from suasion, as being more directly addressed to the passions.
- EXIGENT**, in law, a writ which lies where the defendant in a personal action cannot be found, nor any effects of his within the county, by which he may be attached or distrained.
- EXIGENTERS**, four officers in the court of common-pleas, who make all exigents and proclamations, in all actions where process of outlawry lies. Writs of superseades, as well as the prothonotaries upon exigents, were likewise drawn up in their office.
- EXILE**. See **BANISHMENT**.
- EXISTENCE**, that whereby any thing has an actual essence, or is said to be. See **METAPHYSICS**.
- EXIT** in a theatrical sense, the action of a player in going off the stage, after he has played his part.
- EXLEGALITUS**, among lawyers, the same with an outlawed person.
- EXOCOETUS**, the **FLYING-FISH**, in ichthyology, a genus belonging to the order of abdominales. The head is scaly, and it has no teeth; it has ten radii in the branchiostegæ membrane; the body is whitish, and

the belly is angular: the pectoral fins are very large. When pursued by any other fish, it raises itself from the water by means of these long fins, and flies in the air to a considerable distance, till the fins dry, and then it falls down into the water. There are two species, viz. 1. The volitans, with the belly carinated on each side. It is a native of the European and American seas. 2. The evolans, with a cylindrical belly. It is a native of the German ocean.

**EXODIARY**, in the ancient Roman tragedy, was the person who, after the drama or play was ended, sung the exodium. See **EXODIUM**.

**EXODIUM**, in the ancient Greek drama, one of the four parts or divisions of tragedy, being so much of the piece as included the catastrophe and unravelling of the plot, and answering nearly to our fourth and fifth acts.

**EXODIUM**, among the Romans, consisted of certain humorous verses rehearsed by the exodiary at the end of the Fabulæ Atellanæ.

**EXODIUM**, in the Septuagint, signifies the end or conclusion of a feast. Particularly it is used for the eighth day of the feast of tabernacles, which, it is said, had a special view to the commemoration of the exodus, or departure out of Egypt.

**EXODUS**, a canonical book of the Old Testament; being the second of the pentateuch, or five books of Moses.

It is so called, from the Greek, [*exodos*], the going out, or departure of the children of Israel from the land of Egypt; the history of which is delivered in this book, together with the many miracles wrought on that occasion.

**EX OFFICIO**, among lawyers, signifies the power a person has, by virtue of his office, to do certain acts without being applied to.

**EXOMPHALUS**, in surgery, called also omphalocœle, and hernia umbilicalis, is a preternatural tumour of the abdomen, at the navel, from a rupture, or distension of the parts which invest that cavity. See **SURGERY**.

**EXORCISM**, among ecclesiastical writers, the expelling devils from persons possessed, by means of conjurations and prayers.

Exorcism makes a considerable part of the superstition of the church of Rome, the rituals of which forbid the exorcising any person without the bishop's leave.

The ceremony is performed at the lower end of the church, towards the door. The exorcist first signs the possessed person with the sign of the cross, makes him kneel, and sprinkles him with holy water. Then follow the litanies, psalms, and prayer; after which the exorcist asks the devil his name, and adjures him by the mysteries of the Christian religion not to afflict the person any more: then, laying his right hand on the dæmoniac's head, he repeats the form of exorcism, which is this: "I exorcise thee, unclean spirit, in the name of Jesus Christ: tremble, O Satan! thou enemy of the faith, thou foe of mankind, who hast brought death into the world, who hast deprived men of life, and hast rebelled against justice; thou seducer of mankind, thou root of evil, thou source of avarice, discord, and envy."

The Romanists likewise exorcise houses and other places, supposed to be haunted by unclean spirits; and the ceremony is much the same with that for persons possessed.

**EXORCISTS**, in church history, an order of men, in the ancient church, whose employment it was to exorcise or cast out devils. See the preceding article.

**EXORDIUM**, in rhetoric, is the preamble or beginning, serving to prepare the audience for the rest of the discourse.

Exordiums are of two kinds, either just and formal, or vehement and abrupt. The last are most suitable on occasions of extraordinary joy, indignation, or the like.

**EXOTIC**, an appellation denoting a thing to be the produce of foreign countries.

**EXPANSION**, among metaphysicians, denotes the idea we have of lasting distance, all whole parts exist together.

**EXPANSION**, in physiology, the swelling or increase of the bulk of bodies when heated.

**EXPECTORANTS**, in pharmacy, medicines which promote expectoration. See the next article.

**EXPECTORATION**, the act of evacuating or bringing up phlegm or other matters out of the trachea, lungs, &c. by coughing, hawking, spitting, &c.

**EXPERIENCE**, a kind of knowledge acquired by long use, without any teacher. Mr Locke says, that men receive all the materials of knowledge from experience and observation.

**EXPERIMENT**, in philosophy, is the trial of the result or effect of the applications and motions of certain natural bodies, in order to discover something of their motions and relations, whereby to ascertain some of their phenomena, or causes.

**EXPERIMENTAL PHILOSOPHY**, that philosophy which proceeds on experiments, which deduces the laws of nature, and the properties and powers of bodies, and their actions upon each other, from sensible experiments and observations. The business of experimental philosophy is to inquire into, and to investigate the reasons and causes of, the various appearances and phenomena of nature; and to make the truth or probability thereof obvious and evident to the senses, by plain, undeniable, and adequate experiments, representing the several parts of the grand machinery and agency of nature. See **MECHANICS**, **HYDROSTATICS**, **OPTICS**, and the other branches of **NATURAL PHILOSOPHY**.

**EXPIATION**, a religious act, by which satisfaction, atonement, or amends, is made for the commission of some crime, the guilt done away, and the obligation to punishment cancelled.

The method of expiation among the Jews was chiefly by sacrifice, whether for sins of ignorance, or to purify themselves from certain pollutions.

*Great day of EXPIATION*, an annual solemnity of the Jews, upon the tenth day of the month Tisri, which answers to our September. On this occasion the high-priest laid aside his breast-plate and embroidered ephod, as being a day of humiliation. He first offered a bullock and a ram for his own sins, and those of the priests;



priests; then he received from the heads of the people two goats for a sin offering, and a ram for a burnt-offering, to be offered in the name of the whole multitude. It was determined by lot which of the goats should be sacrificed, and which set at liberty. After this he perfumed the sanctuary with incense, and sprinkled it with blood: then, coming out, he sacrificed the goat upon which the lot had fallen. This done, the goat which was to be set at liberty being brought to him, he laid his hands upon its head, confessed his sins, and the sins of the people, and then sent him away into some desert place: it was called *azazel*, or the scape-goat.

As to the expiations among the heathens, they were of several kinds, as sacrifices, and religious washings.

**EXPIATION**, in a figurative sense, is applied by divines to the pardon procured to mens sins, by the merits of Christ's death.

**EXPIRATION**, in phyc, that part of respiration whereby the air is expelled, or driven out of the lungs.

**EXPLICITÉ**, in the schools, something clear, distinct, formal, and unfolded.

**EXPLOSION**, in phytics, is properly applied to the going off of gun-powder and the report made thereby. Hence, it is used to express such sudden actions of bodies as generate air instantaneously.

**EXPONENT**, in algebra. See **ALGEBRA**.

**EXPONENT** is also used in arithmetic, in the same sense as index or logarithm.

**EXPORTATION**, the shipping and carrying out of the the kingdom wares and commodities for other countries. See **COMMERCE**.

**EXPOSITION**, in general, denotes the setting a thing open to public view: thus it is the Romanists say, the host is exposed, when shewn to the people.

**EXPOSITION**, in a literary sense, the explaining an author, passage, writing, or the like, and setting their meaning in an obvious and clear light.

**EXPOSITOR**, or **EXPOSITORY**, a title given to small dictionaries, serving to explain the hard words of a language.

**EXPOSTULATION**, in rhetoric, a warm address to a person, who has done another some injury, representing the wrong in the strongest terms, and demanding redress.

**EXPOSURE**, in gardening, the situation of a garden, wall, or the like, with respect to the points of the compass, as south or east.

**EXPRESS**, something that is determinate or precise, or in such formal terms as leaves no room for doubt.

**EXPRESS** also denotes a courier. See **COURIER**.

**EXPRESSED OILS**, in chemistry. See **CHEMISTRY**, p. 93.

**EXPRESSION**, in rhetoric, the elocution, diction, or choice of words in a discourse. See **COMPOSITION**.

**EXPRESSION**, in painting, a natural and lively representation of the subject, or of the several objects intended to be shewn.

The expression consists chiefly in representing the human body and all its parts, in the action suitable to

it: in exhibiting in the face the several passions proper to the figures, and observing the motions they impress on the external parts.

**EXPULSION**, in a general sense, the act of violently driving a person out of any city, society, &c.

**EXPULSION**, in medicine, the act whereby any thing is forcibly driven out of the place in which it is: thus we say, the expulsion of the fœtus in delivery.

**EXTASY**, a transport which suspends the function of the senses, by the intense contemplation of some extraordinary or supernatural object.

**EXTASY**, in medicine, a species of catalepsy, when a person perfectly remembers, after the paroxysm is over, the ideas he conceived during the time it lasted.

**EXTENSION**, in philosophy, one of the common and essential properties of body, or that by which it possesses or takes up some part of universal space, which is called the place of that body. See **METAPHYSICS**.

**EXTENSOR**, an appellation given to several muscles, from their extending or stretching the parts to which they belong. See **ANATOMY**, Part II.

*Old and new* **EXTENT**, in Scots law. The *old extent* was a valuation or estimate of the annual value of all the lands in Scotland, taken (it is thought before the reign of Alexander III.) for the purpose of proportionating the public subsidies, and ascertaining the rates of certain feudal casualties. By improvement, and the alteration in the nominal value of money, this valuation, or old extent, became, in length of time, too low a standard for computing their feudal casualties; wherefore, about the reign of Robert I. all inquests for serving heirs were ordained to take proof also of the *present value* of the lands contained in the brief. This last was called the *new extent*. See **SCOTS LAW**, title 12.—None of these extents is the rule by which the land-tax is now proportioned in Scotland. See **VALUATION**, or **VALUED RENT**.

**EXTERIOR**, or **EXTERNAL**. See **EXTERNAL**.

**EXTERMINATION**, in general, the extirpating or destroying something.

**EXTERMINATION**, in Algebra. See **ALGEBRA**, p. 104.

**EXTERNAL**, a term of relation applied to the surface or outside of a body; or that part which appears or presents itself to the eye, touch, &c. in contradistinction to internal.

**EXTERNAL** is also used to signify any thing that is without-side a man, or that is not within himself, particularly in his mind, in which sense we may say external objects, &c.

**EXTINCTION**, in general, denotes the putting out or destroying something, as a fire or flame.

**EXTINGUISHMENT**, in law, is a consolidation or union, as where one has due to him a yearly rent out of lands, and afterwards purchases the lands out of which the rent arises: in this case, both the property and the rent being united in one possessor, the rent is said to be extinguished.

**EXTIRPATION**, the same with extermination. See **EXTERMINATION**.

**EXTRISPEX**, in antiquity, the person who drew pre-figures from viewing the intrails of animals offered in sacrifice.

- crifice. See SACRIFICE, HARUSPEX, and DIVINATION.
- EXTORTION**, in law, is an illegal manner of wresting any thing from a man either by force, menace, or authority.
- EXTRACT**, in pharmacy, is a solution of the purer parts of a mixed body inspissated, by distillation or evaporation, nearly to the consistence of honey. See CHEMISTRY.
- EXTRACT**, in matters of literature, is something copied or collected from a book or paper.
- EXTRACTION**, in chemistry and pharmacy, the operation by which essences, tinctures, &c. are drawn from natural bodies. See CHEMISTRY.
- EXTRACTION**, in surgery, is the drawing any foreign matter out of the body by the hand, or by the help of instruments. See SURGERY.
- EXTRACTION**, in genealogy, implies the stock or family from which a person is descended.
- EXTRACTION of roots**, in algebra and arithmetic. See ALGEBRA, p. 86. and ARITHMETICK, p. 420.
- EXTRACTOR**, in midwifery, an instrument, or forceps, for extracting children by the head. See MIDWIFERY.
- EXTRAVAGANTES**, those decretal epistles, which were published after the clementines. See CLEMENTINES.
- They were so called because, at first, they were not digested, or ranged, with the other papal constitutions, but seemed to be, as it were, detached from the canon law. They continued to be called by the same name when they were afterwards inserted in the body of the canon law. The first extravagantes are those of John XXII. successor of Clement V. the last collection was brought down to the year 1483, and was called the common extravagantes, notwithstanding that they were likewise incorporated with the rest of the canon law.
- EXTRAVASATION**, in contusions, fissures, depressions, fractures, and other accidents of the cranium, is when one or more of the blood-vessels, that are distributed on the dura mater, is broke or divided, whereby there is such a discharge of blood as greatly oppresses the brain, and disturbs its office; frequently bringing on violent pains, and other mischiefs; and at length death itself, unless the patient is timely relieved. See SURGERY, and MEDICINE.
- EXTREMES**, in logic, the terms expressing the two ideas whose relation we inquire after in a syllogism.
- EXTREME UNCTION**. See UNCTION.
- EXTRINSIC**, among metaphysicians, is taken in various senses: sometimes it signifies a thing's not belonging to the essence of another; in which sense, the efficient cause and end of a thing are said to be extrinsic. Sometimes it signifies a thing's not being contained within the capacity of another; in which sense, these causes are called extrinsic which introduce something into a subject from without, as when a fire introduces heat. Sometimes it signifies a thing added or applied to another; in which sense accidents and adherents are said to be extrinsic to the subjects to which they adhere. Sometimes the vision is said to be extrinsic: from some form which does not exist in that thing, but is adjacent to it, or by some means or other without it.
- EXULCERATION**, in surgery. See ULCER.
- EXUVIÆ**, among naturalists, denote the cast-off parts or coverings of animals, as the skins of serpents, caterpillars, and other insects.
- EYE**, in anatomy. See ANATOMY, p. 289.
- Bull's EYE*, in astronomy. See ALDEBARAN.
- EYE-GLASS**, in the microscope. See MICROSCOPE and OPTICS.
- EYMOUTH**, or **AYMOUTH**, a port-town of Scotland, about six miles north of Berwick.
- EYRAC**, or **IZACA ARABIC**, a province of Asiatic Turkey, situated on the river Euphrates, being the ancient Chaldea or Babylonia.
- EYRAC**, or **IRAC AGERI**, the ancient Parthia, now the principal province of Persia, is situated almost in the centre of that kingdom, its capital city being Isphahan, the metropolis of the whole kingdom.
- EYRE**, or **EIRE**, in law, the court of itinerant justices. See JUSTICES.
- EYSENACH**, a city of Germany, in the circle of Upper Saxony: E. long. 10° 12', and N. lat. 51°.
- EZEKIEL**, a canonical book of the Old Testament, referring chiefly to the degenerate manners and corruptions of the Jews of those times.
- It abounds with fine sentences and rich comparisons, and discovers a good deal of learning in profane matters.
- Ezekiel was carried captive to Babylon with Jehoniah, and began his prophecies in the fifth year of the captivity. He was cotemporary with Jeremiah, who prophesied at the same time in Judea. He foretold many events, particularly the destruction of the temple, the fatal catastrophe of those who revolted from Babylon to Egypt, and the happy return of the Jews to their own land.
- EZRA**, a canonical book of the Old Testament, comprehending the history of the Jews from the time of Cyrus's edict for their return, to the twentieth year of Artaxerxes Longimanus. It specifies the number of Jews who returned, and Cyrus's proclamation for the rebuilding the temple, together with the laying its foundation, the obstructions it met with, and the finishing thereof in the reign of Darius.
- The illustrious author of this book, was also the restorer and publisher of the canon of the Old Testament.

## F

## F A C

**FABA**, in botany. See **VICIA**.

**FABAGO**, in botany. See **ZYGOPHILLUM**.

**FABER**, in ichthyology. See **ZEUS**.

**FABLE**, a tale, or feigned narration, designed either to instruct or divert, disguised under the allegory of an action, &c.

Fables were the first pieces of wit that made their appearance in the world, and have been still highly valued, not only in times of the greatest simplicity, but among the most polite ages of the world. Jotham's fable of the trees is the oldest that is extant, and as beautiful as any that have been made since. Nathan's fable of the poor man is next in antiquity. We find Æsop, in the most distant ages of Greece; and in the early days of the Roman commonwealth, we read of a mutiny appeased by the fable of the belly and the members. As fables had their rise in the very infancy of learning, they never flourished more than when learning was at its greatest height; witness Horace, Boileau, and Fontaine.

**FABLE**, is also used for the plot of an epic or dramatic poem; and is, according to Aristotle, the principal part, and, as it were, the soul of a poem. See **COMPOSITION**.

**FACE**, in anatomy, comprehends all that part of the head which is not covered with the common long hair. See **ANATOMY**, Part I. II. and VI.

**FACE**, in the military art, a word of command, intimating to turn about: thus, *face to the right*, is to turn upon the left heel a quarter-round to the right; and, *face to the left*, is to turn upon the right heel a quarter-round to the left.

**FACET**, or **FACETTE**, among jewellers, is the name of the little faces or planes to be found in brilliant and rose diamonds.

**FACTION**, a cabal or party formed in a state, city, or company.

**FACTION**, in antiquity, a name given to the different companies of combatants in the circus. They were four, *viz.* the white, the red, the green, and the blue; to which Domitian added another of purple colour. They were so denominated from the colour of the liveries they wore, and were dedicated, according to M. Aur. Cassiodorus, to the four seasons of the year, the green being consecrated to spring, the blue to winter, the red to summer, and the white to autumn. It appears from ancient inscriptions, that each faction had its procurators and physician; and from history, that party rage ran so high among them, that in a dissension between two factions, in the time of Justinian, almost forty thousand men lost their lives in the quarrel.

**FACITIOUS**, any thing made by art, in opposition to what is the produce of nature. Thus, *facitious cinnabar* is opposed to native cinnabar.

**FACTOR**, in commerce, is an agent or correspondent

VOL. II. No. 49.

†

## F A C

residing beyond the seas, or in some remote part, commissioned by merchants to buy or sell goods on their account, or assist them in carrying on their trade.

A factor receives from the merchants, his constituents, in lieu of wages, a commission or factorage, according to the usage of the place where he resides, or the business he transacts, this being various in different countries, on the purchases and sales of different commodities. He ought to keep strictly to the tenor of his orders; as a deviation from them, even in the most minute particular, exposes him to make ample satisfaction for any loss that may accrue from his non-observance of them. When unlimited orders are given to factors, and they are left to sell or buy on the best conditions they can, whatever detriment occurs to their constituents, they are excused, as it is to be presumed they acted for the best, and were governed by the dictates of prudence. But a bare commission to sell is not sufficient authority for the factor to trust any person, wherefore he ought to receive the money on the delivery of the goods; and, by the general power, he may not trust beyond one, two, or three months, &c. the usual time allowed for sales, otherwise he shall be answerable out of his own estate. If a factor sells on the usual trust to a person of good credit, who afterwards becomes insolvent, he is discharged; but not if the man's credit was bad at the time of sale. If a factor gives a man time for payment of money contracted on sale of his principal's goods, and, after that time is elapsed, sell him goods of his own for ready money, and the man becomes insolvent, the factor in equity ought to indemnify his principal; but he is not compellable by the common law. A factor should always be punctual in the advices of his transactions, in sales, purchases, freights, and more especially in draughts by exchange. If he purchases goods for another at a price limited, and afterwards they rise, and he fraudulently takes them for his own account, and sends them to another part, in order to secure an advantage that seemingly offers, he will, on proof, be obliged, by the custom of merchants, to satisfy his principal for damages. If a factor, in conformity with a merchant's orders, buys with his money, or on his credit, a commodity he shall be directed to purchase; and, without giving advice of the transaction, sells it again to profit, and appropriates to himself the advantage, the merchant shall recover it from him, and besides have him amerced for his fraud. When factors have obtained a profit for their principal, they must be cautious how they dispose of it; for, if they act without commission, they are responsible: and if a merchant remits goods to his factor, and about a month after draws a bill on him, the factor, having effects in his hands, accepts the bill, then the principal breaks; and the goods are seized in the factor's hands

5 T

for

for the behalf of the creditors, it has been conceived the factor must answer the bill notwithstanding, and come in a creditor for so much as he was obliged, by reason of his acceptance, to pay. A factor who enters into a charter-party with a master for freight, is obliged by the contract; but if he loads aboard generally, the principal and the lading are liable for the freightment, and not the factor. If a factor, having money in his hands belonging to his principal, neglect to insure a ship and goods, according to order; if the ship miscarry, the factor, by the custom of merchants, shall make good the damage; and if he make any composition with the insurers after insurance, without orders so to do, he is answerable for the whole insurance.

As fidelity and diligence are expected from the factor, so the law requires the like from the principal: if, therefore, a merchant remits counterfeit jewels to his factor, who sells them as if true; if he receive loss or prejudice by imprisonment or other punishment, the principal shall not only make full satisfaction to the factor, but to the party who bought the jewels.

What is here said of factors, is meant of such as reside abroad to act for merchants, and may be applied to supercargoes, who go a voyage to dispose of a cargo, and afterwards return with another to their principals: but it is also the custom of the merchants of the highest credit throughout the world, to act mutually in the capacity of factors for each other. The business so executed is called commission business, and is generally desirable by all merchants, provided they have always effects in their hands, as a security for all the affairs which they transact for the account of others. And this class of traders of established reputation, have current as well as commission account, constantly between them, and draw on, remit to, and send commissions to each other only by the intercourse of letters, which, among men of honour, are as obligatory and authoritative as all the bonds and ties of law.

**FACTOR**, in arithmetick. See **ARITHMETICK**, p. 371.

**FACTORAGE**, called also commission, is the allowance given to factors by the merchant who employs them. The gain of factorage is certain, however the voyage or sale prove to the merchant: but the commissions vary; at Jamaica, Barbadoes, Virginia, and most of the western parts of the world, the commission runs at 8 per cent. generally through Italy, 2½; in France, Spain, and Portugal, &c. 2; and in Holland and other places near home, 1½ per cent.

**FACTORY** is a place where a considerable number of factors reside, to negotiate for their masters or employers. See **FACTOR**.

The most considerable factories belonging to the British are those established in the East-Indies, Portugal, Turkey, &c.

**FACTUM**, in arithmetic, the product of two quantities multiplied by each other.

**FACULÆ**, in astronomy, certain bright and shining parts, which the modern astronomers have, by means of telescopes, observed upon or about the surface of the sun: they are but very seldom seen.

**FACULTY**, in law, a privilege granted to a person, by

favour and indulgence, of doing what, by law, he ought not to do.

For granting these privileges, there is a court under the archbishop of Canterbury, called the court of the faculties, the chief officer whereof is styled master of the faculties; who has a power of granting dispensations in divers cases, as to marry without the bans being first published; to eat flesh on days prohibited; to ordain a deacon under age; for a son to succeed his father in his benefice; a clerk to hold two or more livings, &c.

**FACULTY**, in the schools, a term applied to the different members of an university, divided according to the arts and sciences taught there: thus in most universities there are four faculties, viz. 1. Of arts, which include humanity and philosophy. 2. Of theology. 3. Of physics. And 4. Of civil law.

**FACULTY of Advocates**. See **ADVOCATES**.

**FACULTY** is also used to denote the powers of the human mind, viz. understanding, will, memory, and imagination. See **METAPHYSICS**.

**FÆCES**, in chemistry, the gross matter, or sediment, that settles at the bottom after distillation, fermentation, and the like.

**FÆCES**, in medicine, the excrements voided by stool.

**FÆCULENT**, in general, is applied to things abounding with fæces, or dregs: thus the blood and other humours of the human body, are said to be fæculent, when without that purity which is necessary to health.

**FAENSA**, a city and bishop's see of Italy, situated in the pope's territories, about thirty miles east of Bologna: E. long. 12° 38', and N. lat. 44° 30'.

**FAGARA**, in botany, a genus of the tetrandria monogynia class. The calix consists of four segments, and the corolla of four petals; and the capsule has four cells, two valves, and contains one seed. There are three species, none of them natives of Britain.

**FAGGOT**, in times of popery here, was a badge worn on the sleeve of the upper garment of such persons as had recanted, or abjured what was then termed heresy; being put on after the person had carried a faggot, by way of penance, to some appointed place of solemnity. The leaving off the wear of this badge was sometimes interpreted a sign of apostacy.

**FAGGOTS**, among military men, persons hired by officers, whose companies are not full, to muster and hide the deficiencies of the company; by which means they cheat the king of so much money.

**FAGONIA**, in botany, a genus of the decandria monogynia class. The calix consists of five leaves, and the corolla of five cordated petals; the capsule has five cells with one seed in each, and ten valves. There are three species, none of them natives of Britain.

**FAGOPYRUM**. See **POLYGONUM**.

**FAGUS**, the **BEECH**, in botany, a genus of the monocæia polyandria class. The calix of the male is bell-shaped, and consists of five segments; it has no corolla, but twelve stamens: the calix of the female consists of four teeth; it has no corolla; the styli are three; and the capsule is muricated, has four cells and two seeds. There are three species, two of them natives of Britain, viz. the castanea, or chestnut-tree; and the sylvatica, or beech-tree.

**FAINTING**.

**FAINTING.** See *ΛΙΠΟΥΣΜΙΑ*.

**FAIR**, a greater kind of market, granted to a town, by privilege, for the more speedy and commodious providing of such things as the place stands in need of. See **MARKET**.

It is incident to a fair, that persons shall be free from being arrested in it for any other debt contracted than what was contracted in the same; or, at least, promised to be paid there. These fairs are generally kept once or twice a year, and, by statute, they shall not be held longer than they ought, by the lords thereof, on pain of their being seized into the king's hands, &c. Also proclamation is to be made how long they are to continue; and no person shall sell any goods after the time of the fair is ended, on forfeiture of double the value, one fourth to the prosecutor, and the rest to the king. There is a toll usually paid in fairs, on the sale of things, and for stallage, picage, &c. See **TOLL**.

**FAIRFIELD** a town of New England, in the province of Connecticut, about an hundred miles south-west of Boston: W. long. 72°, and N. lat. 41°.

**FAIRFORD**, a market-town about nineteen miles south-east of Gloucester.

**FAIRY**, in ancient traditions and romances, signifies a sort of deity, or imaginary genius, conversant on earth, and distinguished by a variety of fantastical actions, either good or bad.

The fairies are a peculiar species of divinities, that have but little relation to any of those of the ancient Greeks or Romans, unless perhaps to the larvæ; tho' others, with great reason, will not have them ranked among gods, but suppose them an intermediate kind of beings, neither gods, angels, men, or devils. They are of oriental extraction, and seem to have been invented by the Persians and Arabs, whose religion and history abound with relations concerning them: these have a particular country which they suppose the fairies to inhabit, called Fairy-land.

Spencer's Fairy Queen is an epic poem, under the persons and characters of fairies. In this sort of writing the poet loses sight of nature, and entertains the reader's imagination with the characters of fairies, witches, magicians, dæmons, and departed spirits. It requires an odd turn of thought, and a peculiar cast of fancy, with an imagination naturally fruitful and superstitious.

This sort of poetry raises a pleasing kind of horror in the mind of the reader, and amuses his imagination with the strangeness and novelty of the persons who are represented in it; but the judicious object to it, as not having probability enough to affect the imagination.

**FAIRY CIRCLE OR RING**, a phenomenon pretty frequent in the fields, &c. supposed by the vulgar to be traced by the fairies in their dances: there are two kinds of it, one of about seven yards in diameter, containing a round bare path, a foot broad, with green grass in the middle of it. The other is of different bigness, encompassed with a circumference of grass. Mess. Jessop and Walker, in the Philosophical Transact. 2-

scribe them to lightning, which is confirmed by their being most frequently produced after storms of that kind, as well as by the colour and brittleness of the grass: roots, when first observed.

Lightning, like all other fires, moves round, and burns more in the extremity than in the middle: the second circle arises from the first, the grass burnt up growing very plentifully afterwards. Others maintain that these circles are made by ants, which are frequently found in great numbers therein.

**FAITH**, in divinity and philosophy, the firm belief of certain truths upon the testimony of the person who reveals them.

The grounds of a rational faith are, 1. That the things revealed be not contrary to, though they may be above natural reason. 2. That the revealer be well acquainted with the things he reveals. 3. That he be above all suspicion of deceiving us.

Where these criterions are found, no reasonable person will deny his assent: thus, we may as well doubt of our own existence, as of the truth of a revelation coming from God, who can neither be deceived himself, nor deceive others by proposing things to be believed that are contradictory to the faculties he has given us. Whatever propositions, therefore, are beyond reason, but not contrary to it, are, when revealed, the proper matter of faith.

*Confession of FAITH.* See **CONFESSION**.

**FAITHFUL**, an appellation assumed by the Mahometans. See **MAHOMETANS**.

**FAKENHAM**, a market-town of Norfolk, about sixteen miles north-west of Norwich.

**FAKIR**, in Pagan theology, a kind of Indian monks, who even outdo the mortifications and severities of the ancient Christian anachorets. See **ANACHORET**.

Some of them mangle their bodies with scourges and knives; others never lie down; and others remain all their lives in one posture.

There are also another kind of fakirs, who do not practice such severities: these flock together in companies, and go from village to village, prophesying and telling fortunes. It is said that even persons of fortune, in India, become fakirs, and that there are more than two millions of them.

**FALCADE**, in the menage, the motion of a horse when he throws himself upon his haunches two or three times, as in very quick corvets; which is done in forming a stop and half stop. See **STOP**.

**FALCATED**, something in the form of a sickle: thus, the moon is said to be falcated when she appears horned. See **MOON** and **PHASES**.

**FALCO**, in ornithology, a genus belonging to the order of accipitres, the characters of which are these: the beak is crooked, and furnished with wax at the base; the head is thick-set with feathers, and the tongue is cloven. There are thirty-two species, viz. 1. The coronatus, or crowned eagle of Edwards, with ash-coloured wax; the legs are covered with white downy feathers, interspersed with black spots; the breast is reddish; and there are black belts on the sides. It is a native of Guinea. 2. The melanæetus, or black

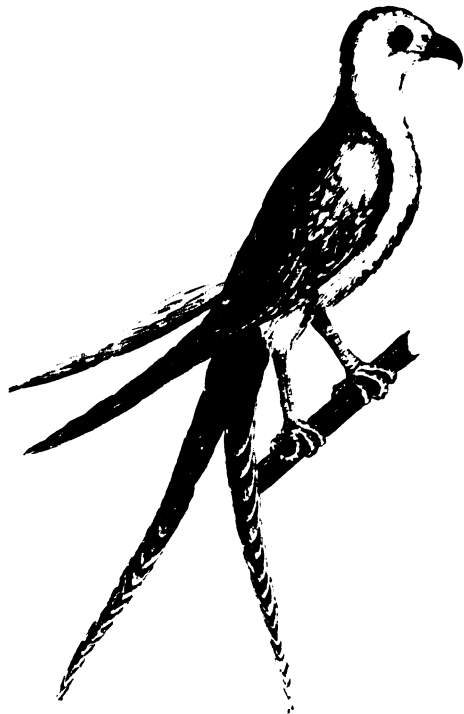
black eagle of Ray, has yellowish wax on the beak; the legs are half covered with feathers; and the body is ash-coloured and streaked with yellow. It is a native of Europe. 3. The leucocephalus, or white-headed eagle of Catesby, is ash-coloured, with the head and tail white; the iris of the eye is white, over which is a prominence covered with a yellow skin; the bill and the feet or wax are yellow, as are likewise the legs and feet; and the talons are black. Though it is an eagle of small size, it weighs nine pounds, is strong and full of spirit, preying on lambs, pigs, and fawns. They always make their nests near the sea, or great rivers, and usually upon old, dead pine or cypress trees, continuing to build annually on the same tree till it falls. Tho' he is so formidable to all birds; yet he suffers them to build near his royal nest without molestation; particularly the fishing hawk, herons, &c. which all build on high-trees, and in some places are so near one another that they appear like a rookery. It is a native both of Europe and America. *Pl. 76. fig. 1.* 4. The ossifragus, with yellow wax, and half-feathered legs; it is about the size of a peacock; the feathers are white at the base, iron-coloured in the middle, and black at the points; and the legs are yellow: it is a native of Europe. 5. The chrysaetos, or golden eagle, has yellow wax on the beak, and feathered legs; the body is variegated with a brown and iron colour; and the base of the tail is undulated with an ash-colour: it is a bird of Europe. 6. The fulvus, with yellow wax, feathered legs, a brown back, and a white streak on the tail; the face is bare betwixt the eyes and nostrils: it is a native of Europe and Canada. 7. The rusticolus, with a yellow wax, yellow ring round the eyes, and yellow legs; the body is ash-coloured undulated with white, and a white ring round the neck: it is a native of Sweden. 8. The barbarus, with yellow wax, and yellow legs; the body is blueish, and spotted with brown: it is a native of Barbary. 9. The cærulescens, with yellow wax, a yellow ring round the eyes, and the feet yellow underneath; the back is of a blackish blue colour; and the temples are surrounded with a white line. This is the smallest bird of the genus, and is a native of Asia. 10. The cyaneus, with white wax, yellow legs, a whitish blue body, and a white ring round the eyes and throat. It is the blue hawk of Edwards, and is a native of Europe and Africa. 11. The pygargus, with yellow wax and legs; the body is ash-coloured, with purple red spots along the belly, and white orbits. It is a bird of Europe. 12. The milvus, or kite, with yellow wax on the back, a forked tail, and iron-coloured bill, and the head of a lighter colour. It is a bird of Europe, Asia, and Africa. Bellonius relates, that, about the end of April, in less than fourteen days, incredible numbers of them are seen flying over the Black Sea into Asia. They feed upon offals, young-birds, &c. Like all the species of this genus, they fly remarkably high, and are endowed with uncommon acuteness of vision. 13. The gentilis, with yellow wax and legs; the body is ash-coloured, with brown spots; and the tail has four blackish streaks. It is a native of the Alps, and is peculiarly fond of larks. 14. The subbuteo, with yellow wax and legs; the back is brown, the nape of the neck white, and the belly is pale, with oblong brown spots. It is

called the hobby by English authors, and is a native of Europe. 15. The buteo, with yellowish wax and legs, a brown body, and a pale belly, with brown spots. He feeds upon rabbits, toads, &c. and is a bird of Europe. 16. The tinnunculus, with yellow wax and legs; the back is reddish, and spotted with black; it has brownish streaks on the breast, and a roundish tail. It inhabits old buildings, and lives upon small birds and mice. 17. The fufflator, with yellowish wax and legs; the body is of a brownish white colour; and the covers of the eyes are bony. He has a fleshy lobe between the nostrils, which, when angry or terrified, he inflates till his head becomes as large as his whole body. He is a native of Surinam. 18. The cachinna, or laughing hawk, has yellowish legs and wax, and white eye-brows; the body is variegated with brown and white; and it has a black ring round the top of the head. It makes a laughing kind of noise when it observes any person, and is a native of America. 19. The hudsonius, has yellow wax, and yellow legs, a brown back, and white eye-brows. It is found at Hudson's bay. 20. The sparverius, has yellow wax, a brown head, a red belly, and blueish wings. It is a native of America. 21. The columbarius, or pigeon-hawk of Catesby, weighs about six ounces. The bill is black at the point, and whitish at the base; the iris of the eye is yellow; the base of the upper mandible is covered with a yellow wax or wax; all the upper part of the body, wings, and tail, are brown. The interior vanes of the quill-feathers have large red spots. The tail is marked with four regular transverse white lines; the throat, breast, and belly are white, mixed with brown; the small feathers that cover the thighs reach within half an inch of the feet, and are white, with a tincture of red, beset with long spots of brown; the legs and feet are yellow. It is a very swift and bold hawk, preying on pigeons, young turkeys, &c. and is a native of Carolina. *Pl. 76. fig. 3.* 22. The superciliosus has yellow legs and wax, and yellow eye-brows; and the body is brown, waved with white. It is a native of Surinam. 23. The vespertinus, is about the size of a pigeon; the body is of a blueish brown colour; and the bill is yellow, and brown at the point. It is a native of Ingria, and flies both in the day and in the night. 24. The lanarius, has yellowish wax, and the bill and legs, which are short, are blueish. It is a native of Europe. 25. The furcatus, or swallow-tailed hawk, weighs about 14 ounces; the bill is black; the eyes are large and black, with a red iris; the head, neck, breast, and belly are white; the upper part of the back and wings a dark purple; but more dusky towards the lower parts, with a tincture of green. The wings are long in proportion to the body, and, when extended, are four feet. The tail is dark purple mixed with green, and remarkably forked. Like swallows, they continue long on the wing, catching, as they fly, beetles, flies, and other insects. They are said to prey upon lizards and serpents, and are found in America. *Pl. 76. fig. 2.* 26. haliaetus, or fishing hawk of Catesby, weighs three pounds and a quarter; it measures, from one end of the wing to the other, five feet and a half. The bill is black, with a blue wax or wax; the iris of the eye is yellow, and the crown of the head brown, with a mixture of white feathers; from each eye, backwards, runs a brown stripe: the

*Fig. 1.*  
FALCO LEUCOCEPHALUS  
OR  
WHITE HEADED EAGLE



*Fig. 2.*  
FALCO FURCATUS  
OR  
SWALLOW TAILD HAWK



*Fig. 3.*  
FALCO COLUMBARIUS  
OR  
PIGEON HAWK









*Fig. 1.* FALCO HALIÆTUS  
or  
FISHING HAWK



*Fig. 2.* FELIS DOMESTICUS  
CAT of ANGORA



*J. Bell Sculp.*

the back, wings, and tail, are of a dark brown; the throat, neck, and belly white; the legs and feet are rough and scaly, and of a pale blue colour; the talons are black, and nearly of an equal size; the feathers of the thighs are short, and adhere close to them, contrary to others of the hawk-kind, which nature seems to have designed for their more easy penetrating the water. Their manner of fishing is, after hovering a while over the water, to precipitate into it with prodigious swiftness, where they remain for some minutes, and seldom rise without a fish. The white-headed eagle, who is generally on the watch, no sooner spies him with his fish, than he flies furiously upon him: the hawk immediately mounts, and screams out; but the eagle always soars above him, and compels him to let the fish fall; the eagle instantly darts down upon the fish, and seldom fails to catch it before it reaches the water. It is remarkable, that, whenever the hawk catches a fish, he calls out, as if it were to give warning to his enemy the eagle, who always obeys the call when within hearing. The lower parts of the rivers and creeks near the sea in America, abound with those eagles and hawks, where these diverting contests are frequently seen. *Pl. 77. fig. 1. 27.* The gyrfalco, with blue wax on the beak, yellow legs, a brown body, marked with ash-coloured streaks underneath, and the sides of the tail white. It is the gyrfalco of Ray, lives upon cranes, pigeons, &c. and is a native of Europe. 28. The aviporus, with black wax, yellow legs, half naked, the head of an ash-colour, and having an ash-coloured stripe on the tail, which is white at the end. It is the honey-buzzard of Ray, and is a native of Europe; it feeds upon mice, lizards, frogs, bees, and other insects. 29. The æruginosus, with greenish wax, a greyish body; and the top of the head, nape of the neck, and legs, are yellowish. It is a native of Europe, and builds its nest in marshes. 30. The palumbarius, with black wax edged with yellow, yellow legs, a brown body, and the prime feathers of the tail are marked with pale streaks, and the eye-brows are white. It is the goose-hawk of Ray, is an inhabitant of Europe, and an enemy to domestic fowls. 31. The nisus, with green wax, yellow legs, and a white belly undulated with grey; the tail is marked with blackish belts. It is the sparrow-hawk of Ray, and a native of Europe. It is peculiarly fond of pigeons, sparrows, and larks. 32. The minutus, with brown wax, yellow legs, and the body is white underneath. It is the least hawk of Brissonius, being about the size of a thrush, and is found at Melita.

**FALCONER**, one who tames, manages, and looks after falcons, or other hawks. See the next article.

**FALCONRY**, the art of training all manner of hawks, but more especially the larger sort, to the exercise of hawking. See **HAWKING**.

When a falcon is taken, she must be seeled in such a manner, that as the seeling slackens, she may see what provision lies before her; but care ought to be taken, not to seel her too hard. A falcon or hawk newly taken, should have all new furniture, as new jesses of good leather, mailed leashes with buttons at the end, and new bewets. There should also be provided a small round stick, to stroke the hawk; because the ostener

VOL. II. No 49.

†

this is done, the sooner and better will she be manned. She must also have two good bells, that she may be found when she scattereth. Her hood should be well fashioned, raised and embossed against her eyes, deep, and yet strait enough beneath, that it may fallen about her head without hurting her; and her back and talons must be a little copied, but not so near as to make them bleed.

**FALKIRK**, a town of Scotland: W. long. 3° 48', N. lat. 56° 20'.

**FALL**, the descent of a heavy body towards the center of the earth; it is also the name of a measure of length used in Scotland, containing six ells.

**FALLACY**, a deception, fraud, or false appearance.

The Epicureans deny that there is any such thing as a fallacy of the senses: for, according to them, all our sensations and perceptions, both of sense and phantasy, are true: whence they make sense the primary criterion of truth.

**FALLING-SICKNESS**. See **MEDICINE**.

**FALLOPIAN TUBES**. See **ANATOMY**, p. 275.

**FALLOW**, a pale red colour, like that of brick half burnt: such is that of a fallow-deer.

**FALLOW-FIELD**, or **FALLOW GROUND**, land laid up, or that has lain untilled for a considerable time.

**FALLOWING of land**, a particular method of improving land. See **AGRICULTURE**.

**FALMOUTH**, a port-town of Cornwall, in England, situated in W. long. 5° 30', N. lat. 50° 15', on a fine bay of the English channel, the entrance whereof is guarded by two forts.

**FALSE**, in general, something contrary to truth, or not what it ought to be; thus we say, a false witness, false action, false weights, false claim, &c.

**FALSHOOD**, in philosophy, is the representing a thing otherwise than it is.

**Crimen falsi**, in the civil law, is fraudulent subornation or concealment with design to darken or hide the truth, and make things appear otherwise than they are. The crimen falsi is committed, 1. By words, as when a witness swears falsely. 2. By writing, as when a man antedates a contract, or the like. 3. By deed, as when he sells by false weights and measures.

**FALX**, in anatomy. See **ANATOMY**, p. 284.

**FAN**, a machine used to raise wind and cool the air by agitating it. The custom which now prevails of wearing fans, was borrowed from the East, where they are almost indispensably necessary for keeping off the sun and the flies. Fans are made of a thin skin or piece of paper, taffaty, or other light stuff, cut semicircularly, and mounted on several little sticks of wood, ivory, tortoise-shell, or the like. The paper, &c. is usually painted, and in mounting is plaited in such a manner, as that the plaits may be alternately inward and outward.

**FAN** is also an instrument used in winnowing corn.

Fans for corn pay on importation, 1 s. 3 <sup>4</sup>/<sub>10</sub> d. and draws-back on exportation, 1 s. 1 <sup>3</sup>/<sub>10</sub> d. India fans pay for every 100 l. gross value at the sale 26 l. 14 s. 2 <sup>2</sup>/<sub>100</sub> d.

The draw-back on exportation is 25 l. 2 s. 11 <sup>1</sup>/<sub>100</sub> d.

**FANATICS**, wild, enthusiastic, visionary persons, who pretend to revelation and inspiration.

**FANCY**, or **IMAGINATION**. See **IMAGINATION**.

**FANIONS**, in the military art, small flags carried along with the baggage.

**FANO**, a bishop's see and port-town of Italy, situated on the gulph of Venice, in 14° E. long. and 44° N. lat.

**FAR**, in horsemanship, an appellation given to any part of a horse's right side: thus the far foot, far shoulder, &c. is the same with the right foot, right shoulder, &c.

**FARCE**, was originally a droll or petty shew exhibited by mountebanks and their buffoons in the open streets, to gather the people together. At present it is of more dignity: it is removed from the street to the theatre, and instead of being performed by merry-andrews to amuse the rabble, is acted by comedians, and become the entertainment of a polite audience. Poets have reformed the wildness of the primitive farces, and brought them to the taste and manner of comedy. The difference between the two on our stage is, that comedy keeps to nature and probability, and therefore is confined to certain laws prescribed by ancient critics; whereas farce disallows of all laws, or rather sets them aside on occasion. Its end is purely to make merry; and it sticks at nothing which may contribute thereto, however wild and extravagant. Hence the dialogue is usually low, the persons of inferior rank, the fable or action trivial or ridiculous, and nature and truth every where heightened and exaggerated to afford the more palpable ridicule.

**FARCIN**, **FARCY**, or **FASIONS**, in farriery, a creeping ulcer, and the most loathsome, stinking, and filthy disease that a horse can be affected with.

For the cure, first bleed the horse well; then take oil of bay and euphorbium mixed together, and anoint the knots with it; or bathe the place with the stale of

an ox or cow, and the herb called lion's foot, all boiled together. Some apply tallow and horse-dung, burn the knots with a hot iron, or wash the fore with salt, vinegar, alum, verdigrease, green copperas, and gun-powder, boiled in chamber-lee. Others again anoint the sores with a salve made of a penny-worth of tar, two penny worth of white mercury, and two handfuls of pigeon's dung.

**FARDING-DEAL**, the fourth part of an acre of land. See **ACRE**.

**FARE**, most commonly signifies the money paid for a voyage, or passage by water; but, in London, it is what persons pay for being conveyed from one part of the town to another in a coach or chair.

**FAREHAM**, a market town of Hampshire, ten miles east of Southampton.

**FAREWELL CAPE**, the most southerly promontory of Greenland, in 50° W. long. and 60° N. lat.

**FARINA FOECUNDANS**, among botanists, the supposed impregnating meal or dust on the apices or anthers of flowers. See **BOTANY**, Sect. III.

**FARINGTON**, a market town of Berkshire, twenty-five miles north-west of Reading.

**FARM**, or **FERM**, signifies the chief messuage in a village; or any large messuage, whereto belongs land, meadow, pasture, wood, common, &c. and which has been used to let for term of life or years, under a certain yearly rent payable by the tenant for the same.

**FARNHAM**, a market-town in the county of Surry, ten miles west of Guilford, remarkable for its large plantations of hops.

**FARO**, a sea-port town of Portugal, in the province of Algarva: W. long. 9°, N. lat. 36° 50'.

**FARREATION**, in antiquity. See **CONFARREATION**.

**FARRIER**, one whose employment is to shoe horses, and cure them when diseased or lame.

## F A R R I E R Y.

**FARRIERY**, the art of curing the diseases of horses. The practice of this useful art has been hitherto almost entirely confined to a set of men who are totally ignorant of anatomy, and the general principles of medicine. It is not therefore surprising, that their prescriptions should be equally absurd as the reasons they give for administering them. It cannot indeed be expected that farriers, who are almost universally illiterate men, should make any real progress in their profession. They prescribe draughts, they rowel, cauterise, &c. without being able to give any other reason for their practice, but because their fathers did so before them. How can such men deduce the cause of a disease from its symptoms, or form a rational method of cure, when they are equally ignorant of the causes of diseases and the operation of medicines?

The miserable state of this useful art, especially in this country, has determined us to select, from the best authors, such a system of practice as seemed to be formed on rational principles; this, we hope, will be a sufficient apology for being so full upon this article.

### *General Directions with regard to the Management of Horses.*

It ought to be laid down as a general rule, to give horses as few medicines as possible; and by no means to comply with the ridiculous custom of some, who are frequently bleeding, purging, and giving balls, though their horses be in perfect health, and have no indication that requires such treatment.

Proper management in their feeding, exercise, and dressing, will alone cure many disorders, and prevent most;

most; for the simplicity of a horse's diet, which chiefly consists of grain and herbage, when good in kind, and dispensed with judgment, secures him from those complicated disorders, which are the general effects of intemperance in the human body.

In France, Germany, and Denmark, horses are seldom purged; there they depend much on alteratives; the use of the liver of antimony, we have from the French, which is in general a good medicine for that purpose, and may, in many cases, be substituted in the room of purging.

As hay is so material an article in a horse's diet, great care should be taken to procure the best: when it is not extraordinary, the dust should be well shook out before it is put in the rack; for such hay is very apt to breed vermin.

Beans afford the strongest nourishment of all grain, but are fittest for laborious horses; except on particular occasions. In some seasons they breed a kind of vermin called the red bugs, which is thought to be dangerous; the best method in such a case, is to procure them well dried and split.

Bran scalded is a kind of panada to a sick horse; but nothing is worse than a too frequent use of it, either dry or scalded; for it relaxes and weakens the bowels too much. The bots in young horses may be owing to too much musty bran and chaff, given with other foul feed to make them up for sale: particular care therefore should be taken that the bran be always sweet and new.

Oats, well ripened, make a more hearty and durable diet than barley, and are much better suited to the constitutions of British horses. A proper quantity of cut straw and hay mixed with them, is sometimes very useful to horses troubled with bots, indigestion, &c.

Horses who eat their litter, should particularly have cut straw and powdered chalk given them with their feed; as it is a sign of a depraved stomach, which wants correcting.

The salt-marshes are good pasture for horses who have been surfeited, and indeed for many other disorders; they purge more by dung and urine than any other pasture, and make afterwards a firmer flesh: their water is for the most part brackish, and of course, as well as the the grass, saturated with salts from the sea-water.

A summer's grass is often necessary; more particularly to horses glutted with food, and which use little exercise; but a month or two's running is proper for most: those especially who have been worked hard, and have stiff limbs, swelled legs, or wind-galls. Horses whose feet have been impaired by quitters, bad shoeing, or any other accidents, are also best repaired at grass. Those lamenesses particularly require turning out to grass, where the muscles or tendons are contracted or shrunk; for by the continual gentle exercise in the field, with the assistance of a patten shoe on the opposite foot, the shortened limb is kept on the stretch, the wasted parts are restored to their usual dimensions, and the limb again recovers its usual tone and strength.

The fields which lie near great towns, and are much dunged, are not proper pasture for horses; but on observation appear very injurious to them, if they feed thereon all the summer.

Horses may be kept abroad all the year, where they have a proper stable or shed, to shelter them from the weather, and hay at all times to come to. So treated, they are seldom sick, their limbs are always clean and dry; and, with the allowance of corn, will hunt, and do more business than horses kept constantly within doors.

If horses, when taken from grass, should grow hot and coltive, mix bran and chopt hay with their corn; and give them sometimes a feed of scalded bran for a fortnight, or longer: let their exercise and diet be moderate for some time, and increase both by degrees.

When horses are soiled in the stable, care should be taken that the herbage is young, tender, and full of sap; whether it be green barley, tares, clover, or any thing else the season produces, and that it be cut fresh once every day at least, if not oftener.

When horses lose their flesh much in soiling, they should in time be taken to a more solid diet; for it is not in soiling as in grazing; where, though a horse loses his flesh at first, yet, after the grass has purged him, he soon grows fat.

Young horses who have not done growing, must be indulged more in their feeding, than those come to their maturity; but if their exercise is so little, as to make it necessary to abridge their allowance of hay, a little fresh straw should constantly be put in their racks, to prevent their nibbling the manger, and turning cribbiters; they should also sometimes be strapped back in order to cure them of this habit.

It is obvious to every one, what care should be taken of a horse after violent exercise, that he cools not too fast, and drinks no cold water, &c. for which reason we shall wave particular directions,

Most horses fed for sale, have the interstices of their muscles so filled with fat, that their true shapes are hardly known. For which reason, a horse just come out of the dealer's hands, should at first be gently used. He ought to lose blood, and have his diet lowered, though not too much: walking exercise is most proper at first, two hours in a day; in a week or fortnight two hours at a time, twice a-day; after this usage for a month bleed him again, and give him two or three times a-week scalded bran, which will prepare him for purging physic, that may now be given safely, and repeated at the usual intervals.

When a horse comes out of a dealer's hands, his cloathing must be abated by degrees, and care taken to put him in a moderately warm stable; otherwise the sudden transition would be attended with the worst consequences.

*Some General Directions in regard to Bleeding, Purging, &c.*

Horses who stand much in stable, and are full fed, require bleeding now and then, especially when their eyes look heavy, dull, red, and inflamed; as also, when they feel hotter than usual, and mangle their hay.

Young horses should be bled when they are shedding their teeth, as it takes off those feverish heats they are then subject to. But the cases that chiefly require bleeding, are colds, fevers of most kinds, falls, bruises, hurts of the eyes, strains, and all inflammatory disorders, &c.

It is right to bleed a horse, when he begins to grow fleshy

fleshy at grass, or at any other time when he looks heavy: and it is generally proper to bleed before purging.

Let your horse always be bled by measure, that you may know what quantity you take away: two or three quarts is always enough at one time; when you repeat it, allow for the disorder, and the horse's constitution.

Let the blood, when cold, be carefully examined, both as to colour and consistence, whether black, florid, fizy, &c.

Purging is often necessary in gross full horses, in some disorders of the stomach, liver, &c. but should be directed with caution. Before a purge is given to any horse, it is necessary some preparation should be made for it, in order to render the operation more safe and efficacious; thus a horse that is full of flesh should first be bled, and at the same time have his diet lowered for a week, especially those that have been pampered for sale; several mashings of scalded bran should also previously be given, in order to open the bowels, and unload them of any indurated excrement; which sometimes proves an obstacle to the working of the physic, by creating great sickness and griping.

Let it be remembered, that a horse is purged with difficulty; that the physic generally lies twenty-four hours in the guts before it works; and, that the tract of bowels it has to pass through, is above thirty yards; and lying horizontally, consequently resinous and other improper drugs may, and often do, by their violent irritations, occasion excessive gripings and cold sweats, shave off the very mucus or lining of the guts, and bring on inflammations, which often terminate in mortifications, and death.

It is remarkable too, that the stomach and guts of a horse are but thin, compared to some other animals of the same bulk, and therefore must be more liable to inflammation and irritation.

Horses kept much in the stable, who have not the proper benefit of air, and exercise, in proportion to their food, should in spring have a mild purge or two, after a previous preparation by bleeding, lowering their diet, and scalded mashings.

Horses that fall off in their stomach, whether it proceeds from too full feeding, or ingendering crudities and indigested matter, should have a mild purge or two.

Horses of a hot temperament, will not bear the common aloetic purges; their physic therefore should be mild and cooling.

Purging is always found very beneficial in stubborn dry coughs: but mild mercurials joined with them, make them yet more efficacious.

Horses of a watery constitution, who are subject to swelled legs, that run a sharp briny ichor, cannot have the causes removed any way so effectually as by purging.

The first purge you give to a horse should be mild, in order to know his constitution.

It is a mistaken notion, that if a proper prepared purge does not work to expectation, the horse will be injured by it; for though it does not pass by stool, its operation may be more efficacious, as an alterative to purify the blood, and it may pass by urine, or other secretions.

Purging medicines are very successfully given in small

quantities, mixed with others; and at then as alteratives.

If mercurial physic is given, care should be taken that it be well prepared; and warmer cloathing, and greater circumspection is then required.

Purges should be given early in the morning upon an empty stomach: about three or four hours after the horse has taken it, he should have a feed of scalded bran; and a lock or two of hay may then be put into his rack. The same day give him two more mashings; but should he refuse warm meat, he may be allowed raw bran.

All his water should be milk warm, and have a handful of bran squeezed in it; but if he refuses to drink white water, give it him without bran.

Early the next morning, give him another mash; but if he refuses to eat it, give him as much warm water as he will drink: let him be properly clothed, and rode gently about. This should be done two or three times a day, unless he purges violently, once or twice will then be sufficient: at night give him a feed of oats mixed with bran.

During the working, a horse should drink plentifully; but, if he will not drink warm water, he must be indulged with cold, rather than not drink at all.

We shall here insert some general forms of purges,

**TAKE** succotrine aloes ten drams, jallap and salt of tartar each two drams, grated ginger one dram, oil of cloves thirty drops; make them into a ball with syrup of buckthorn.

Or,

**TAKE** aloes and cream of tartar each one ounce, jallap two drams, cloves powdered one dram, syrup of buckthorn a sufficient quantity.

Or,

The following, which has an established character among sportsmen.

**TAKE** aloes, from ten drams to an ounce and an half, myrrh and ginger powdered each half an ounce, saffron and oil of anniseed each half a dram.

Mr Gibbon recommends the following,

**TAKE** succotrine aloes ten drams, myrrh finely powdered half an ounce, saffron and fresh jallap in powder of each a dram, make them into a stiff ball with syrup of roses, then add a small spoonful of rectified oil of amber.

The succotrine aloes should always be preferred to the Barbadoes or plantation aloes; though the latter may be given to robust strong horses, but even then should always be prepared with the salt, or cream of tartar; which by opening its parts, prevents its adhesion to the coats of the stomach, and bowels; from whence horrid gripings, and even death itself has often ensued. This caution is well worth remarking, as many a horse hath fallen a sacrifice to the neglect of it.

Half an ounce of Castile soap, to a horse of a gross constitution, may be added to any of the above; and the proportions may be increased for strong horses.

When mercurial physic is intended, give two drams of calomel over night, mixed up with half an ounce of a diapente and a little honey, and the purging ball the next morning.

The

The following, when it can be afforded, is a very gentle and effectual purge, particularly for fine delicate horses; and if prepared with the Indian rhubarb, will not be expensive.

**TAKE** of the finest succotrine aloes one ounce, rhubarb powdered half an ounce or six drams, ginger grated one dram; make into a ball with syrup of roses.

The following purging drink may be given with the utmost safety; it may be quickened, or made stronger, by adding an ounce more fenna, or two drams of jalap.

**TAKE** fenna two ounces, infuse it in a pint of boiling water two hours, with three drams of salt of tartar; pour off, and dissolve in it four ounces of Glauber's salts, and two or three of cream of tartar.

This last physic is cooling, easy, and quick in its operation; and greatly preferable in all inflammatory cases to any other purge, as it passes into the blood, and operates also by urine.

When horses lose their appetites after purging, it is necessary to give them a warm stomach-drink, made of an infusion of chamomile flowers, anniseeds and saffron: or the cordial ball may be given for that purpose.

Should the purging continue too long, give an ounce of discordium in an English pint of Port wine, and repeat it once in twelve hours, if the purging continues. Plenty of gum arabic water should also be given; and in case of violent gripes, fat broth glysters, or tripe liquor, should be often thrown up, with an hundred drops of Jaudanum in each.

The arabic solution may be thus prepared.

**TAKE** of gum arabic and tragacanth of each four ounces, juniper-berries and carraway-seeds of each an ounce, cloves bruised half an ounce; simmer gently in a gallon of water, till the gums are dissolved: give a quart at a time in half a pail of water; but if he will not take it freely this way, give it him often in a horn.

When a purge does not work, but makes the horse swell, and refuse his food and water, which is sometimes the effect of bad drugs, or catching cold, warm diuretics are the only remedy; of which the following are recommended.

**TAKE** a pint of white wine, nitre one ounce; mix with it a dram of camphire, dissolved in a little rectified spirit of wine; then add two drams of oil of juniper, and the same quantity of unrectified oil of amber, and four ounces of honey, or syrup of marshmallows.

When a horse swells much with physic, do not suffer him to be rode about till he has some vent; but rather lead him gently in hand, till some evacuation is obtained.

As it is observed, that horses more willingly take sweet and palatable things, than those that are bitter and of an ill taste; care should be taken, that the latter are given in balls; and that their drinks are always contrived to be as little nauseous as possible, and sweetened either with honey or liquorice. Those that are prepared with gross powders, are by no means so agreeable to a horse, as those made by infusion; as the former often clam the mouth, irritate the membranes about the palate and throat, and

frequently occasion the cough they are intended to prevent.

Balls should be of an oval shape, and not exceed the size of a pullet's egg; when the dose is larger, it should be divided into two; and they should be dipt in oil, to make them slip down the easier.

As we have given some general forms of purges, we shall observe the same rule in regard to glysters, with some few cautions and remarks.

Let it be observed then, that, before the administering emollient clysters in colic disorders, a small-hand, well oiled, should be passed up the horse's fundament, in order to bring away any hardened dung, which otherwise would be an obstacle to the glyster's passage.

A bag and pipe of a proper form, is to be preferred to a syringe, which throws up the glyster with so much force, that it often surpriseth a horse, and makes him reject it as fast as it goes in; whereas the liquor, when pressed gently from the bag, gives him no surprize or uneasiness, but passes easily up into the bowels, where it will sometimes remain a long time, and be extremely useful, by cooling and relaxing them; and will sometimes incorporate so with the dung, as not easily to be distinguished from the other contents of the guts. These emollient glysters are extremely serviceable in most fevers, and greatly preferable to purging ones; which in general are too pungent, and stimulate too much, especially if aloes are a part of the composition.

Nutritive glysters are very necessary, and often save a horse from starving, when his jaws are so locked up by convulsions that nothing can be conveyed by the mouth.

They should not exceed a quart or three pints at a time, but be often repeated: nor should they be too fat; but made of sheeps heads, trotters, or any other meat-broths, milk pottage, rice-milk strained, and many other such nourishing things. For an emollient glyster, take the following.

**TAKE** marshmallows and chamomile flowers each a large handful, bay-berries and sweet fennel-seeds bruised each an ounce; boil in a gallon of water to three quarts, pour off into a pan, and dissolve in it half a pound of treacle, and a pint of lint-seed oil, or any common oil.

To make it more laxative, add four ounces of lenitive electuary, or the same quantity of cream of tartar, or common purging salts.

#### *Purging Glyster.*

**TAKE** two or three handful of marshmallows, fenna one ounce, bitter apple half an ounce, bay berries and anniseed bruised each an ounce, salt of tartar half an ounce; boil a quarter of an hour in three quarts of water; pour off, and add four ounces of syrup of buckthorn, and half a pint of oil.

This glyster will purge a horse pretty briskly; and may be given successfully, when an immediate discharge is wanting; especially in some fevers with inflamed lungs, or other disorders, which require speedy relief.

But it is necessary to caution against a solution of course aloes for this purpose, as it has been found to gripe horses violently, and excite feverish, and sometimes convulsive

convulsive-symptoms; and indeed all pungent and stimulating medicines, as the stronger purgatives generally are, should be given in this form with great caution.

But the generality of emollient glysters, may be prepared with much less trouble: as two quarts of water-gruel, with a half a pound of treacle, a pint of oil, and a handful of common salt, will as effectually answer every purpose. The following is a restraining glyster.

TAKE pomegranate-bark or oak-bark two ounces, red rose-leaves fresh or dry a handful, balauftines an ounce; boil in two quarts of water, till one is near consumed; pour off and dissolve in it four ounces of diascordium; to which may be added a pint of Port wine.

This will answer in all common cases, where restraints are necessary, but should never be given in larger quantities; for the longer glysters of this kind lie in the bowels, the more efficacious they are.

#### Of Colds.

By taking cold, we mean that the pores and outlets of the skin (which in a natural healthy state of body are continually breathing out a fine fluid, like the steam arising from hot water, or smoke from fire) are so far shut up, that these streams, or perspirable matter, not having a free passage through them, are hindered from going off in the usual manner; the consequence of which is, their recoiling on the blood, vitiating its quality, overflowing the vessels, and affecting the head, glands or kernels of the neck and throat, the lungs, and other principal parts.

To enumerate the various causes of colds would be endless; the most usual are, riding horses till they are hot, and suffering them to stand in that condition where the air is cold and piercing; removing a horse from a hot stable to a cold one, and too suddenly changing his cloathing; hence it is, that horses often catch such severe colds, after they come out of dealers hands; and by not being carefully rubbed down, when they come in hot, off journeys.

The signs of a horse's catching cold, are a cough, heaviness and dullness, which affect him more or less in proportion to the severity of it: the eyes are sometimes moist and watery, the kernels about the ears and under the jaws swell, the nose gleans, and he rattles in his breathing; and when the cold is violent, the horse will be feverish, his flanks work, and he will both loath his hot meat and refuse his water. When these last symptoms are attended with a slimy mouth, ears, and feet cold, and a great inward soreness, there is danger of a bad fever.

But when the horse coughs strong, snorts after it, is but little off his stomach, pricks up his ears, and moves briskly in his stall, dungs and stales freely, his skin feels kindly, and his coat does not stare, he is in no danger, and there will be no occasion for medicines of any kind: but you should bleed him about two quarts, keep him warm, and give him feeds of scalded ban, with as much warm water as he will drink, in order to dilute his blood.

If the disorder should increase, the horse feel hot, and

refuse his meat, bleed him, if strong, two quarts more; and if you are not satisfied, without giving medicines, avoid, as you would poison, a farrier's drench; (which is generally composed of some hot, mauscular powders, given in a quantity of ale; which too often increases the fever, by overheating the blood, and palls the horse's stomach by its loathsomeness;) and instead of it, infuse two ounces of anniseeds, with a dram of saffron, in a pint and a half of boiling water; pour off the clear, and dissolve in it four ounces of honey; to which may be added four spoonfuls of salad oil: this drink may be given every night; or one of the following balls, provided there is no fever; in which case, it always will be more eligible to give two or three ounces of nitre or salt prunella every day in his feeds, or water, till it is removed; but should the horse be inclined to costiveness, remember that his body should be kept open by emollient glysters, or cream of tartar dissolved in his water, to the quantity of three or four ounces a-day.

#### Pectoral Horse-ball.

TAKE of the fresh powders of anniseed, clicampane, carraway, liquorice, turmeric, and flour of brimstone, each three ounces; juice of liquorice four ounces, dissolved in a sufficient quantity of mountain; saffron powdered half an ounce, salad oil and honey half a pound, oil of anniseed one ounce: mix together with wheat flour enough to make them into a paste.

Or, the following from Dr BRACKEN.

TAKE anniseed, carraway seed, and greater cardamoms, finely powdered, of each one ounce, flour of brimstone two ounces, turmeric in fine powder one ounce and a half, saffron two grams, Spanish juice dissolved in water two ounces, oil of anniseed half an ounce, liquorice powder one ounce and a half, wheat flower a sufficient quantity to make into a stiff paste, by beating all the ingredients well in a mortar.

These balls consist of warm opening ingredients; and, given in small quantities, about the size of a pullet's egg, will encourage a free perspiration; but in case of a fever, should be cautiously continued. They are much more efficacious, and in all cases superior to the farrier's drenches, if dissolved in a pint of warm ale.

This simple method, with good nursing and hot mashes, warm water and cloathing, especially about the head and throat, which promotes the running at the nostrils, will answer the most sudden colds; and when the horse feeds heartily, and snorts after coughing, moderate exercise every day will hasten his recovery.

To a horse loaded with flesh, a rowel may sometimes be necessary, as may also a gentle purge or two, to some, when the distemper is gone off.

#### Of Fevers in general.

The symptoms of a fever are great restlessness, the horse ranging from one end of his rack to the other; his flanks beat; his eyes are red and inflamed; his tongue parched and dry; his breath is hot, and smells strong;



he loses his appetite, and nibbles his hay, but does not chew it, and is frequently smelling to the ground; the whole body is hotter than ordinary, (though not parched, as in some inflammatory disorders;) he dunges often, little at a time, usually hard, and in small bits; he sometimes itales with difficulty, and his urine is high-coloured; his flanks beat; and he seems to thirst, but drinks little at a time, and often; his pulse beats full and hard, to fifty strokes and upwards in a minute.

The first intention of cure is bleeding, to the quantity of two or three quarts, if the horse is strong and in good condition; then give him a pint of the following drink, four times a-day; or an ounce of nitre, mixed up into a ball with honey, may be given thrice a-day, instead of the drink, and washed down with three or four horns of any small liquor.

TAKE of baum, sage and chamomile flowers, each a handful, liquorice root sliced half an ounce, salt prunel or nitre three ounces; infuse in two quarts of boiling water; when cold, strain off, and squeeze into it the juice of two or three lemons, and sweeten with honey.

As the chief ingredient to be depended on in this drink is the nitre; it may perhaps be as well given in water alone; but as a horse's stomach is soon palled, and he requires palatable medicines, the other ingredients may in that respect have their use. Soleysel for this purpose advises two ounces of salt of tartar, and one of sal armoniac to be dissolved in two quarts of water, and mixed with a pail of common water, adding a handful of bran or barley-flour to qualify the unpleasant taste: this may be given every day, and is a useful medicine.

His diet should be scalded bran, given in small quantities; which, if he refuses, let him have dry bran sprinkled with water: put a handful of picked hay into the rack, which a horse will often eat, when he will touch nothing else; his water need not be much warmed, but should be given often, and in small quantities: his cloathing should be moderate; too much heat and weight on a horse being improper in a fever; which scarce ever goes off in critical sweats (as those in the human body terminate) but by strong perspiration.

If in a day or two he begins to eat his bran, and pick a little hay; this method with good nursing will answer: but if he refuses to feed, more blood should be taken away, and the drinks continued; to which may be added two or three drams of saffron, avoiding at this time all hotter medicines: the following glyster should be given, which may be repeated every day, especially if his dung is knotty or dry.

TAKE two handfuls of marshmallows, and one of chamomile flowers; fennel seed an ounce; boil in three quarts of water to two; strain off, and add four ounces of treacle, and a pint of linseed oil, or any common oil.

Two quarts of water-gruel, fat broth, or pot-liquor, with the treacle and oil, will answer this purpose; to which may be added a handful of salt. These sort of glysters are properer than those with purging ingredients.

The following opening drink is very effectual in these

fevers, and may be given every other day, when the glysters should be omitted; but the nitre balls or drink may be continued, except on those days these are taken.

TAKE of cream of tartar and Glauber's salts, each four ounces; dissolve in barley water, or any other liquor: an ounce or two of lenitive electuary may be added, or a dram or two of powder of jallap, to quicken the operation in some horses.

Four ounces of Glauber's salts, or cream of tartar, with the same quantity of lenitive electuary, may be given for the same purpose, if the former should not open the body sufficiently.

In four or five days the horse generally begins to pick his hay, and has a seeming relish to food; though his flanks will heave pretty much for a fortnight: yet the temper of his body and return of appetite shew, that nothing more is requisite to complete his recovery, than walking him abroad in the air, and allowing plenty of clean litter to rest him in the stable.

This method of treating a fever is simple, according to the laws of nature; and is confirmed by long experience, to be infinitely preferable to the hot method.

The intention here is to lessen the quantity of blood; promote the secretion of urine and perspiration, and cool and dilute the fluids in general.

There is another sort of fever that horses are subject to, of a more complicate and irregular nature than the former; which if not properly treated, often proves fatal.

The signs are a slow fever with languishing, and great depressions; the horse is sometimes inwardly hot, and outwardly cold; at other times hot all over, but not to any extreme; his eyes look moist and languid; he has a continual moisture in his mouth, which is the reason he seldom cares to drink, and when he does it is but little at a time. He feeds but little, and leaves off as soon as he has eat a mouthful or two; he moves his jaws in a feeble, loose manner, with an unpleasant grating of his teeth; his body is commonly open; his dung soft and moist, but seldom greasy; his italing is often irregular, sometimes little, at other times profuse, seldom high-coloured, but rather pale, with little or no sediment.

When a horse's appetite declines daily, till he refuses all meat, it is a bad sign. When the fever doth not diminish, or keep at a stand, but increases, the case is then dangerous. But when it sensibly abates, and his mouth grows drier, the grating of his teeth ceases, his appetite mends, and he takes to lay down (which perhaps he has not done for a fortnight) these are promising signs. A horse in these fevers always runs at the nose, but not the kindly white discharge, as in the breaking of a cold, but of a reddish or greenish dusky colour, and of a consistence like glue, and sticks like turpentine to the hair on the inside of the nostrils: If this turns to a gleet of clear thin water, the horse's hide keeps open, and he mends in his appetite; these are certain signs of recovery.

The various and irregular symptoms that attend this slow fever, require great skill to direct the cure, and more knowledge of the symptoms of horses diseases, than the generality of gentlemen are acquainted with. The experienced

perienced farrier should therefore be consulted and attended to, in regard to the symptoms; but very seldom as to the application of the remedy, which is generally above their comprehension; though it may be readily selected, by duly attending to the observations here inculcated.

First then, a moderate quantity of blood, not exceeding three pints, may be taken away, and repeated in proportion to his strength, fullness, inward soreness, cough, or any tendency to inflammation. After this, the fever-drink, (p. 457. col. 1. parag. 3.) may be given, with the addition of an ounce of snake-root, and three drams of saffron and camphor dissolved first in a little spirit of wine; the quantity of the nitre may be lessened, and these increased, as the symptoms indicate.

The diet should be regular; no oats given, but scalded, or raw bran sprinkled; the best flavoured hay should be given by handfuls, and often by hand, as the horse sometimes cannot lift up his head to the rack.

As drinking is so absolutely necessary to dilute the blood, if the horse refuses to drink freely of warm water or gruel, he must be indulged with having the chill only taken off, by standing in the stable; nor will any inconvenience ensue, but oftener an advantage; for the nauseous warmth of water, forced on horses for a time, palls their stomachs, and takes away their appetites, which the cold water generally restores.

Should the fever after this treatment increase, the horse feed little, stale often, his urine being thin and pale, and his dung sometimes loose, and at other times hard: should the moisture in his mouth continue, his skin being sometimes dry, and at others moist, with his coat looking starting, and surfeited: upon these irregular symptoms, which denote great danger, give the following balls, or drink; for in these cases there is no time to be lost.

**TAKE** of contrayerva-root, myrrh, and snake-root powdered, each two drams, saffron one dram, mithridate or Venice treacle half an ounce; make into a ball with honey, which should be given twice or thrice a-day, with two or three horns of an infusion of snake-root, sweetened with honey; to a pint and a half of which may be added half a pint of treacle water or vinegar, which latter is a medicine of excellent use in all kinds of inflammatory and putrid disorders, either external or internal.

Should these balls not prove successful, add to each a dram of camphor, and where it can be afforded, to a horse of value, the same quantity of castor. Or the following drink may be substituted in their stead for some days.

**TAKE** of contrayerva and snake-root of each two ounces, liquorice-root sliced one ounce, saffron two drams; infuse in two quarts of boiling water close covered for two hours; strain off, and add half a pint of distilled vinegar, four ounces of spirit of wine, wherein half an ounce of camphor is dissolved, and two ounces of mithridate or Venice treacle; give a pint of this drink every four, six, or eight hours.

Should the horse be costive, recourse must be had to glysters, or the opening drink: should he purge, take care not to suppress it, if moderate; but if, by continuance, the horse grows feeble, add diascordium to his

drinks, instead of the mithridate; if it increases, give more potent remedies.

Let it be remembered, that camphor is a very powerful and effectual medicine in these kinds of putrid fevers; being both active and attenuating, and particularly calculated to promote the secretions of urine and perspiration.

Regard should also be had to his staling; which, if in too great quantities, so as manifestly to depress his spirits, should be controuled by proper restrainers, or by preparing his drinks with lime-water. If, on the contrary, it happens that he is too remiss this way, and stales so little as to occasion a fullness, and swelling of the body and legs, recourse may be had to the following drink:

**TAKE** of salt prunella, or nitre, one ounce; juniper-berries, and Venice turpentine, of each half an ounce; make into a ball with oil of amber.

Give him two or three of these balls, at proper intervals, with a decoction of marsh-mallows, sweetened with honey.

But if, notwithstanding the method we have laid down, a greenish or reddish gleet is discharged from his nostrils, with a frequent sneezing; if he continues to lose his flesh, and becomes hide-bound; if he altogether forsakes his meat, and daily grows weaker; if he swells about the joints, and his eyes look fixed and dead; if the kernels under his jaws swell, and feel loose; if his tail is raised and quivers; if his breath smells strong, and a purging ensues with a discharge of fetid dark-coloured matter, his case may then be looked on as desperate, and all future attempts to save him will be fruitless.

The signs of a horse's recovery are known by his hide keeping open, and his skin feeling kindly; his ears and feet will be of a moderate warmth, and his eyes brisk and lively; his nose grows clean and dry; his appetite mends, he lays down well, and both stales and dungs regularly.

Be careful not to overfeed him on his recovery; let his diet be light, feeds small, and increased by degrees as he gets strength; for by overfeeding, horses have frequent relapses, or great surfeits, which are always difficult of cure.

If this fever should be brought to intermit, or prove of the intermitting kind, immediately after the fit is over, give an ounce of Jesuit's bark, and repeat it every six hours, till the horse has taken four or six ounces; should eruptions or swellings appear, they ought to be encouraged, for they are good symptoms at the decline of a fever, denote a termination of the distemper, and that no further medicines are wanted.

The true reasons perhaps why so many horses miscarry in fevers, are, that their masters, or doctors, will not wait with patience, and let nature have fair play: that they generally neglect bleeding sufficiently at first; and are constantly forcing down sugar sops, or other food in a horn, as if a horse must be starved in a few days, if he did not eat: then they ply him twice or thrice a-day with hot medicines and spirituous drinks, which (excepting a very few cases) must be extremely pernicious to a horse, whose diet is naturally simple, and whose stomach and blood, unaccustomed to such heating medicines, must be greatly injured, and without doubt are often inflamed by such treatment.

Dilute

Dilute the blood with plenty of water, or white drink; let his diet be warm bran mashes, and his hay sprinkled. Should the fever rise, which will be known by the symptoms above described, give him an ounce of nitre thrice a-day in his water, or made up in a ball with honey. Let his body be kept cool and open, with the opening drink, given twice or thrice a-week; or an ounce of salt of tartar may be given every day, dissolved in his water, for that purpose, omitting then the nitre. After a week's treatment in this manner, the cordial ball may be given once or twice a-day, with an infusion of liquorice-root sweetened with honey; to which may be added, when the phlegm is tough, or cough dry and husky, a quarter of a pint of linseed or fallad oil, and the same quantity of oxymel squills.

The following cooling purge is very proper to give at the decline of the distemper, and may be repeated three or four times.

TAKE two ounces of senna; anniseed and fennel bruised, each half an ounce; salt of tartar three drams; let them infuse two hours in a pint of boiling water; strain off, and dissolve in it three ounces of Glauber's salt, and two of cream of tartar; give for a dose in the morning.

This purge generally works before night very gently; and in fevers, and all inflammatory disorders, is infinitely preferable to any other physic.

Before we close this chapter on fevers, it may be no improper hint to the curious, to take notice that a horse's pulse should more particularly be attended to than is customary, as a proper estimate may thereby be made both of the degree and violence of the fever present, by observing the rapidity of the blood's motion, and the force that the heart and arteries labour with to propel it round. The highest calculation that has been made of the quickness of the pulse in a healthy horse, is, that it beats about forty strokes in a minute; so that in proportion to the increase above this number, the fever is rising, and if farther increased to above fifty, the fever is very high.

How often the pulse beats in a minute may easily be discovered by measuring the time with a stop-watch, or minute sand-glass, while your hand is laid on the horse's near side, or your fingers on any artery; those which run up on each side the neck, are generally to be seen beating as well as felt a little above the chest; and one within side each leg may be traced with the finger.

A due attention to the pulse is so important an article, in order to form a proper judgment in fevers, that it would appear amazing it has so much been neglected, if one did not recollect, that the generality of farriers are so egregiously ignorant, that they have no manner of conception of the blood's circulation, nor in general have they ability enough to distinguish the difference between an artery and a vein.—With such pretty guardians do we intrust the healths and lives of the most valuable of animals!

*Of a PLEURISY, and INFLAMMATION of the LUNGS, &c.*

THESE disorders have scarce been mentioned by any writer in farriery before Mr Gibson; who, by frequent

ly examining the carcases of dead horses, has found them subject to the different kinds of inflammations here described.

In order to distinguish these disorders from others, we shall describe the symptoms in Mr Gibson's own words.

"A pleurisy then, which is an inflammation of the pleura; and a peripneumony, which is an inflammation of the lungs; have symptoms very much alike; with this difference only, that in a pleurisy a horse shews great uneasiness, and shifts about from place to place; the fever, which at first is moderate, rises suddenly very high; in the beginning he often strives to lie down, but starts up again immediately, and frequently turns his head towards the affected side, which has caused many to mistake a pleuritic disorder for the gripes, this sign being common to both, though with this difference: in the gripes a horse frequently lies down and rolls, and when they are violent he will also have convulsive twitches, his eyes being turned up, and his limbs stretched out as if he were dying; his ears and feet are sometimes occasionally hot, and sometimes as cold as ice; he falls into profuse sweats, and then into cold damps; strives often to stale and dung, but with great pain and difficulty; which symptoms generally continue, till he has some relief: but in a pleurisy, a horse's ears and feet are always burning hot, his mouth parched and dry, his pulse hard and quick: even sometimes when he is nigh dying, his fever is continued and increasing; and though in the beginning he makes many motions to lie down, yet afterwards he reins back as far as his collar will permit, and makes not the least offer to change his posture, but stands panting with short stops, and a disposition to cough, till he has relief, or drops down.

In an inflammation of the lungs, several of the symptoms are the same; only in the beginning he is less active, and never offers to lie down during the whole time of his sickness; his fever is strong, breathing difficult, and attended with a short cough: and whereas in a pleurisy a horse's mouth is generally parched and dry; in an inflammation of the lungs, when a horse's mouth is open, a rosy slime will run out in abundance; he gleans also at the nose a reddish or yellowish water, which sticks like glue to the inside of his nostrils.

In a pleurisy, a horse heaves and works violently at his flanks, with great restlessness, and for the most part his belly is tucked up; but in an inflammation of the lungs, he always shews fullness, and the working of his flanks is regular, except after drinking and shifting his posture; and his ears and feet are for the most part cold, and often in damp sweats.

The cure of both these disorders is the same. In the beginning a strong horse may lose three quarts of blood, the next day two quarts more; and if symptoms do not abate, the bleedings must be repeated, a quart at a time; for it is speedy, large, and quick-repeated bleedings that are in these cases chiefly to be depended on. But if a horse has had any previous weakness, or is old, you must bleed him in less quantities, and oftener. Mr Gibson recommends rowels on each side the breast, and one on the belly; and a blistering ointment to be rubbed all over his brisket upon the foremost ribs.

The diet and medicines should be both cooling, attenuating, relaxing, and diluting; and the horse should have warm mashes, and plenty of water or gruel. The following balls may be given thrice a-day.

**TAKE** of spermaceti and nitre, of each one ounce; oil of anniseed, thirty drops; honey enough to make a ball.

A pint of barley-water, in which figs and liquorice-root have been boiled, should be given after each ball; to which the juice of lemons may be added; and if the lungs are greatly oppressed with a dry short cough, two or three horns full of the decoction may be given three or four times a-day, with four spoonfuls of honey and linseed oil. A strong decoction of the rattle-snake-root is also much recommended in pleuritic disorders, and may be given to the quantity of two quarts a-day, sweetened with honey. It remarkably attenuates the blood, and disperses the inflammation, and in some parts is deemed a specific for this complaint.

An emollient glyster should be injected once a day, to which may be added two ounces of nitre or cream of tartar.

In two or three days he will probably run at the nose, and begin to feed; but should he not, and continue hot and short-breathed, you must bleed him again, and give the following glyster.

**TAKE** fenna and marshmallows, of each two ounces; fenel and bay-berries, each one ounce; boil in five pints of clear water, to two quarts; pour off the clear, and add four ounces of purging salts, two or three of syrup of buckthorn, and half a pint of linseed, or any common oil.

If by these means he grows cooler, and his pain moderates, repeat the glyster the next day, unless it worked too much; then intermit a day; and when he comes to eat scalded bran and picked hay, leave off the balls, and continue only the decoction, with now and then a glyster.

But let it be observed, that a horse seldom gets the better of these disorders, unless he has relief in a few days; for if the inflammation is not checked in that time, it usually terminates in a gangrene, or collection of matter, which, for want of expectoration, soon suffocates him.

But as pleuritic disorders are apt to leave a taint on the lungs, great care should be taken of the horse's exercise and feeding, which should be light and open for two or three weeks.

There is also an external pleurisy, or inflammation of the muscles between the ribs, which, when not properly treated, proves the foundation of that disorder called the *chest-founder*; for if the inflammation is not dispersed in time, and the viscid blood and juices so attenuated by internal medicines, that a free circulation is obtained; such a stiffness and inactivity will remain on these parts, as will not easily be removed, and which is generally known by the name of chest-founder.

The signs of this inflammation, or external pleurisy, are a stiffness of the body, shoulders, and fore-legs; attended sometimes with a short dry cough, and a shrinking when handled in those parts.

Bleeding, soft pectorals, attenuants, and gentle purges

are the internal remedies; and externally, the parts affected may be bathed with equal parts of spirit of sal armoniac, and ointment of marshmallows, or oil of chamomile.

These outward inflammations frequently fall into the inside of the fore-leg, and sometimes near the shoulder; forming abscesses, which terminate the disorder.

The membrane which separates the lungs, and more particularly the diaphragm or midriff, is often also inflamed; which is scarce to be distinguished from the pleurisy, only in this, that when the midriff is greatly inflamed, the horse will sometimes be jaw-set, and his mouth so much closed that nothing can be got in; but the method of cure is the same.

### *Of a COUGH, and ASTHMA.*

THE consequence often of the preceding disorders injudiciously treated, are settled habitual coughs; which frequently degenerate into asthmas, and broken-wind.

Nothing has more perplexed practitioners than the cure of settled coughs; the cause of which, perhaps, has been their want of attention to the different symptoms which distinguish one cough from another; for without strict observance thereof, it is impossible to find out the true method of cure.

Thus, if a horse's cough is of long standing, attended with loss of appetite, wasting of flesh, and weakness, it denotes a consumption; and that the lungs are full of knotty, hard substances, called tubercles, which have often been discovered on dissection.

The following signs denote when the cough proceeds from phlegm, and slimy matter, that stop up the vessels of the lungs.

The horse's flanks have a sudden quick motion; he breathes thick, but not with his nostrils open, like a horse in a fever, or that is broken-winded; his cough is sometimes dry and husky, sometimes moist, before which he wheezes, rattles in the throat, and sometimes throws out of his nose and mouth great gobs of white phlegm, especially after drinking, or when he begins or ends his exercise, which discharge commonly gives great relief. Some such horses wheeze and rattle to such a degree, and are so thick-winded, that they can scarce move on, till they have been out some time in the air; though then they will perform beyond expectation.

The above asthmatic case proves often very obstinate; but, if it happens to a young horse, and the cough is not of long standing, it is greatly relieved, if not totally cured, by the following method.

If the horse is full of flesh, bleed him plentifully; if low in flesh, more sparingly; which may occasionally be repeated, on very great oppressions and difficulty of breathing, in proportionate quantities.

As mercurial medicines are found remarkably useful in these cases, give a mercurial ball (with two drams of calomel) over night, and a common purge next morning; or the following, which is recommended by Mr Gibbon.

**TAKE** gum-galbanum, ammoniacum, and assa foetida,

of

of each two drams, fine aloes one ounce, saffron one dram, oil of anniseeds two drams, oil of amber one dram; with honey enough to form into a ball.

They may be repeated at proper intervals, with the usual cautions. In the intermediate days, and for some time after, one of the following balls may be given every morning.

**TAKE** cinnabar of antimony, finely levigated, six ounces; gum ammoniacum, galbanum, and assa fetida, of each two ounces; garlick four ounces; saffron half an ounce: make into a paste for balls, with a proper quantity of honey.

**TAKE** of the pectoral or cordial ball one pound, balsam of Peru half an ounce, balsam of sulphur annisated one ounce, flowers of Benjamin half an ounce, honey as much as is sufficient to form them into a paste; give the size of a pigeon's egg every morning.

Exercise in a free open air is very serviceable, and the diet should be moderate.

The following are the symptoms of a dry cough, or asthma.

The horse afflicted with this cough eats heartily, hunts and goes through his business with alacrity, appears well coated, and has all the signs of perfect health; yet he coughs at particular times almost incessantly, without throwing up any thing, except that the violence of the cough will cause a little clear water to distill from his nose. Though this cough is not periodical, yet some of these horses cough most in a morning, after drinking.

This may properly be styled a nervous asthma in a horse; as probably it chiefly affects the nerves in the membranous parts of the lungs and midriff; and is a case very doubtful at least, if not incurable; but when the horse is young, the following method may be successful.

Take away first a moderate quantity of blood; then give him two drams of calomel, mixed up with an ounce of diapente, for two nights; and the next morning a purging ball. Keep him well clothed and littered, and feed him with scalded bran and warm water.

Once in eight or ten days this purge may be repeated, with one mercurial ball only, given over-night.

The following balls may then be taken, one every day, about the size of a pullet's egg, the horse fasting two hours afterwards; and should be continued two months, or longer, to be of real service.

**TAKE** native cinnabar, or cinnabar of antimony, half a pound; gum guaiacum four ounces; myrrh, and gum armoniac, of each two ounces; Venice soap half a pound: the cinnabar must be finely levigated, as before observed, and the whole mixed up with honey, or oxymel squills.

The following also will be found a useful remedy in obstinate dry coughs.

**TAKE** gum ammoniacum, squills, and Venice soap, of each four ounces, balsam of sulphur with anniseeds one ounce; beat up into a mass, and give as the former.

Before we close this section, it may be necessary to observe here, that some young horses are subject to coughs

on cutting their teeth; their eyes also are affected from the same cause. In these cases, always bleed; and if the cough is obstinate, repeat it, and give warm mashes; which, in general, are alone sufficient to remove this complaint.

#### *Of a BROKEN WIND.*

THIS disorder hitherto seems to have been little understood; but Mr Gibbon is inclined to think, that the source of it is frequently owing to injudicious or hasty feeding young horses for sale; by which means the growth of the lungs, and all the contents within the chest, are so increased, and in a few years so preternaturally enlarged, that the cavity of the chest is not capacious enough for them to expand themselves in, and perform their functions.

A narrow contracted chest with large lungs may sometimes naturally be the cause of this disorder: and it has been observed, that horses rising eight years old are as liable to this distemper, as, at a certain period of life, men fall into asthmas, consumptions, and other chronic diseases.

The reason why this disorder becomes more apparent at this age, may be, that a horse comes to his full strength and maturity at this time: at six he commonly finishes his growth in height; after that time he lets down his belly, and spreads, and all his parts are grown to their full extent; so that the pressure on the lungs and midriff is now more increased.

But how little weight soever these reasons may have, repeated dissections have given ocular proofs of a preternatural largeness, not only of the lungs of broken-winded horses, but of their heart and its bag, and of the membrane which divides the chest; as well as of a remarkable thinness in the diaphragm, or midriff.

This disproportion has been observed to be so great, that the heart and lungs have been almost of twice their natural size, perfectly sound, and without any ulceration whatever; or any defect in the wind-pipe, or its glands.

Hence it appears, that this enormous size of the lungs, and the space they occupy, by hindering the free action of the midriff, is the chief cause of this disorder; and as the substance of the lungs was found more fleshy than usual, they of course must lose a great deal of their spring and tone.

Whoever considers a broken-wind in this light, must own that it may be reckoned among the incurable distempers of horses; and that all the boasted pretensions to cure are vain and frivolous, since the utmost skill can amount to no more than now and then palliating the symptoms, and mitigating their violence.

We shall therefore only lay down such methods as may probably prevent this disorder, when pursued in time. But if they should not succeed, we shall offer some remedies and rules to mitigate its force, and to make a horse as useful as possible under this malady.

It is usual, before a broken wind appears, for a horse to have a dry obstinate cough, without any visible sickness or loss of appetite; but, on the contrary, a disposition to foul feeding, eating the litter, and drinking much water.

In order then to prevent, as much as possible, this disorder, bleed him, and give him the mercurial physic above prescribed, which should be repeated two or three times.

The following balls are then to be taken for some time, which have been found extremely efficacious in removing obstinate coughs.

**TAKE** aurum mosaicum, finely powdered, eight ounces; myrrh and elicanpane, powdered, each four ounces; anniseeds and bay-berries, each an ounce; saffron, half an ounce; make into balls with oxymel squills.

The aurum mosaicum is made of equal parts of quicksilver, tin, sal armoniac, and sulphur. We give this medicine as strongly recommended by Mr Gibson; but how far the aurum mosaicum may contribute to its efficacy, may perhaps justly be disputed: as a substitute in its room, therefore, for this purpose, we recommend the same quantity of powdered squills, or gum ammoniacum, or equal parts of each.

Broken-winded horses should eat sparingly of hay, which as well as their corn may be wetted with chamber lye or fair water; as this will make them less craving after water.

The volatile salts in the urine may make it preferable to water, and may be the reason why garlick is found so efficacious in these cases; two or three cloves given at a time in a feed, or three ounces of garlick bruised, and boiled in a quart of milk and water, and given every other morning for a fortnight, having been found very serviceable; for by warming and stimulating the solids, and dissolving the tenacious juices, which choak up the vessels of the lungs, these complaints are greatly relieved.

Careful feeding, and moderate exercise has greatly relieved broken-winded horses.

Horses sent to graze in order to be cured of an obstinate cough, have often returned completely broken-winded, where the pasture has been rich and succulent, so that they have had their bellies constantly full. As the ill consequence therefore is obvious, where you have not the conveniency of turning out your horse for a constancy, you may soil him for a month or two with young green barley, tares, or any other young herbage.

To pursue thick-winded horses, Barbadoes and common tar have often been given with success, to the quantity of two spoonfuls mixed with the yolk of an egg, dissolved in warm ale, and given fasting two or three times a week, especially those days you hunt or travel.

But in order to make all these sorts of horses of any real service to you, the grand point is to have a particular regard to their diet, observing a just œconomy both in that and their exercise; giving but a moderate quantity of hay, corn, or water, at a time, and moistening the former, to prevent their requiring too much of the latter, and never exercising them but with moderation, as has before been observed. The following alterative ball may be given once a-fortnight or three weeks; and as it operates very gently, and requires no confinement but those days it is given (when warm meat and water are necessary), it may be continued for two or three months.

**TAKE** succotrine aloes six drams; myrrh, galbanum, and ammoniacum, of each two drams; bay-berries half an ounce: make into a ball with a spoonful of

oil of amber, and a sufficient quantity of syrup of buckthorn.

#### *Of a CONSUMPTION.*

**WHEN** a consumption proceeds from a defect in a horse's lungs, or any principal bowel; the eyes look dull; the ears and feet are mostly hot; he coughs sharply by fits; sneezes much, and frequently groans with it; his flanks have a quick motion; he gleans often at the nose, and sometimes throws out a yellowish curdled matter; and he has little appetite to hay, but will eat corn, after which he generally grows hot.

As to the cure, one of the principal things is bleeding in small quantities (a pint, or pint and half, from some horses is sufficient) which should be repeated as often as the breath is more than ordinarily oppressed. Pectorals may be given to palliate present symptoms; but as dissections have discovered both the glands of the lungs and mesentery to be swelled, and often indurated, the whole stress lies on mercurial purges, and the following ponderous alteratives, given intermediately.

**TAKE** native cinnabar, or cinnabar of antimony, one pound, powdered very fine, and add the same quantity of gum guaiacum and nitre; give the horse an ounce of this powder twice a-day, wetting his feeds.

The spring grass is often extremely serviceable, but the salt marshes are to be preferred, and to be more depended on than medicines; for great alterations are thereby made in the blood and juices, and no small benefit arises from open air and proper exercise.

#### *Of an APOPLEXY or STAGGERS, CONVULSIVE DISORDERS, LETHARGY, EPILEPSY, and PALSY.*

**FARRIERS** generally include all distempers of the head under two denominations, *viz.* *stagers* and *convulsions*; wherein they always suppose the head primarily affected. But in treating these disorders, we will distinguish between those that are peculiar to the head, as having their source originally thence; and those that are only concomitants of some other disease.

In an apoplexy a horse drops down suddenly, without other sense or motion than a working at his flanks.

The previous symptoms are, drowsiness; watery eyes, somewhat full and inflamed; a disposition to reel, feebleness, a bad appetite; the head almost constantly hanging, or resting on the manger; sometimes with little or no fever, and scarce any alteration in the dung or urine: the horse is sometimes disposed to rear up, and apt to fall back when handled about the head; which is often the case with young horses, to which it does not prove suddenly mortal; but with proper help they may sometimes recover. If the apoplexy proceeds from wounds, or blows on the head, or matter on the brain; besides the above symptoms, the horse will be frantick by fits, especially after his feeds, so as to start and fly at every thing. These cases seldom admit of a perfect recovery; and when horses fall down suddenly, and work violently at their flanks, without any ability to rise after a plentiful bleeding, they seldom recover.

All

All that can be done is to empty the vessels as speedily as possible, by striking the veins in several parts at once, bleeding to four or five quarts, and to raise up the horse's head and shoulders, supporting them with plenty of straw. If he survives the fit, cut several rowels; give him night and morning glysters prepared with a strong decoction of fenna and salt, or the purging glyster mentioned in the directions; blow once a-day up his nostrils a dram of powder of asarabacca, which will promote a great discharge; afterwards two or three aloetic purges should be given; and to secure him from a relapse, by attenuating and thinning his blood, give him an ounce of equal parts of antimony and crocus metallorum for a month; or, which is preferable, the same quantity of cinnabar of antimony and gum guaiacum.

If the fit proceeds only from fulness of blood, high feeding, and want of sufficient exercise, or a sily blood (which is often the case with young horses, who though they reel, stagger, and sometimes suddenly fall down, yet are easily cured by the above method), an opening diet with scalded bran and barley will be necessary for some time; and the bleeding may be repeated in small quantities.

As to the other disorders of the head, such as lethargy or sleeping evil, epilepsy or falling-sickness, vertigo, frenzy, and madness, convulsions, and paralytical disorders, as they are most of them to be treated as the apoplexy and epilepsy, by bleeding and evacuations with the alteratives there directed, we shall wave treating of them separately, but mention some particular rules to distinguish them, according to the plan we laid down, and then offer some general remedies for the several purposes.

In an epilepsy, or falling sickness, the horse reels and staggers, his eyes are fixed in his head, he has no sense of what he is doing, he stales and dungs insensibly, he runs round and falls suddenly; sometimes he is immovable, with his legs stretched out as if he was dead, except only a quick motion of his heart and lungs, which causes a violent working of his flanks; sometimes he has involuntary motions, and shaking of his limbs, so strong, that he has not only beat and spurned his litter, but the pavement with it; and with these alternate symptoms a horse continued more than three hours, and then he has as surprisingly recovered; at the going off of the fit, he generally foams at the mouth, the foam being white and dry, like what comes from a healthful horse when he champs on the bit.

But in all kinds of gripes, whether they proceed from disorders in the guts, or retention of urine, a horse is often up and down, rolls and tumbles about; and when he goes to lie down, generally makes several motions with great seeming carefulness, which shews he has a sense of his pain; and if he lays stretched out for any time, it is generally but for a short space.

Epilepsies and convulsions may arise from blows on the head, too violent exercise, and hard straining; and from a fulness of blood, or impoverished blood, and surfeits; which are some of the causes that denote the original disorder.

In lethargic disorders, the horse generally rests his head with his mouth in the manger, and his pole often reclined

to one side; he will shew an inclination to eat, but generally falls asleep with his food in his mouth, and he frequently swallows it whole, without chewing: emollient glysters are extremely necessary in this case, with the nervous balls recommended for the staggers and convulsions; strong purges are not requisite, nor must you bleed in too large quantities, unless the horse be young and lusty. In old horses, rowels and large evacuations are improper; but volatiles of all kinds are of use, when they can be afforded: the alterative purge (p 554. col. 2. par. 2. from the bottom) may be given, and repeated on his amendment.

This distemper is to be cured by these means, if the horse is not old and past his vigour. It is a good sign if he has a tolerable appetite, and drinks freely without flabbering, and if he lies down, and rises up carefully, though it be but seldom.

But if a lethargic horse does not lie down; if he is altogether stupid and careless, and takes no notice of any thing that comes near him; if he dungs and stales seldom, and even while he sleeps and dozes, it is a bad sign: if he runs at the nose thick white matter, it may relieve him; but if a viscid gleet, that sticks to his nostrils like glue, turn to a profuse running of rosy, reddish and greenish matter, it is an infallible sign of a great decay of nature, and that it will prove deadly.

Young horses from four to six years, are very subject to convulsions, from bots in the spring; and the large coach breed, more than the saddle. They are seized without any previous notice; and if bots and worms are discovered in their dung, the cause seems to be out of doubt; more especially if they have lately come out of a dealer's hands.

When this convulsion proceeds from a distemperature of the midriff, or any of the principal bowels, it is to be distinguished from bots and vermin by previous symptoms; the horse falls off his stomach, and grows gradually weak, feeble, and dispirited in his work, and turns short-breathed with the least exercise.

The lively description of that universal cramp or convulsion, called by some the stag-evil, which seizes all the muscles of the body at once, and locks up the jaws, so that it is impossible almost to force them open, we shall give in Mr Gibson's own words, who says: As soon as the horse is seized, his head is raised with his nose towards the rack, his ears pricked up, and his tail cocked, looking with eagerness as an hungry horse when hay is put down to him, or like a high-spirited horse when he is put upon his mettle; insomuch, that those who are strangers to such things, when they see a horse stand in this manner, will scarce believe any thing of consequence ails him; but they are soon convinced, when they see other symptoms come on apace, and that his neck grows stiff, cramped, and almost immovable; and if a horse in this condition lives a few days, several knots will arise on the tendinous parts thereof, and all the muscles both before and behind will be so much pulled and cramped, and so stretched, that he looks as if he was nailed to the pavement, with his legs stiff, wide, and straddling; his skin is drawn so tight on all parts of the body, that it is almost impossible to move it; and if trial be made to make him

walk, hé is ready to fall at every step, unless he be carefully supported; his eyes are so fixed with the inaction of the muscles, as give him a deadness in his looks; he snorts and sneezes often, pants continually with shortness of breath; and this symptom increases continually till he drops down dead; which generally happens in a few days, unless some sudden and very effectual turn can be given to the distemper.

In all these cases the horse should first be bled plentifully, unless he is low in flesh, old, or lately come off any hard continued duty, then you must be more sparing of his blood; afterwards give the following ball.

**TAKE** *assa fœtida* half an ounce, *Russia castor* powdered two drams, *valerian root* powdered one ounce; make into a ball with honey and oil of amber.

This ball may be given twice a-day at first; and then once, washed down with a decoction of mistletoe or *valerian* sweetened with liquorice or honey: an ounce of *assa fœtida* may be tied up in a piece of strong coarse linen rag, and put behind his grinders to champ on.

The laxative purges and emollient glysters should be given intermediately to keep the body open; but when the former balls have been taken a week or ten days, the following may be given once a-day with the *valerian* decoction.

**TAKE** *cinnabar* of antimony six drams, *assa fœtida* half an ounce, *aristolochia myrrh* and bay-berries of each two drams; make into a ball with treacle and oil of amber.

This is the most effectual method of treating these disorders; but when they are suspected to arise from bots, and worms, which is generally the case, mercurial medicines most lead the way, thus:

**TAKE** *mercurius dulcis* and *philonium* of each half an ounce; make into a ball with conserve of roses, and give the horse immediately; half the quantity may be repeated in four or five days.

The following infusion should then be given, to the quantity of three or four horns, three or four times a-day, till the symptoms abate; when the above nervous balls may be continued till they are removed.

**TAKE** penny-royal and rue of each two large handfuls, chamomile flowers one handful, *assa fœtida* and *castor* of each half an ounce, saffron and liquorice-root sliced of each two drams; infuse in two quarts of boiling water; pour off from the ingredients as wanted.

If the castor is omitted, add an ounce of *assa fœtida*.

The following ointment may be rubbed into the cheeks, temples, neck, shoulders, spines of the back and loins, and where-ever there is the greatest contractions and stiffness.

**TAKE** nerve and marshmallow ointment of each four ounces, oil of amber two ounces, with a sufficient quantity of camphorate spirit of wine; make a liniment.

When the jaws are so locked up that medicines cannot be given by the mouth, it is more eligible to give them by way of glyster; for forcing open the jaws by violence often puts a horse into such agonies, that the symptoms are thereby increased.

In this case also he must be supported by nourishing glysters, made of milk-pottage, broths, &c. which must be given to the quantity of three or four quarts a-day; glysters of this kind will be retained, and absorbed into the blood; and there have been instances of horses thus supported for three weeks together, who must otherwise have perished.

Mr Gibson mentions some extraordinary instances of success in cases of this sort by these methods, and repeated frictions, which are extremely serviceable in all convulsive disorders, and often prevent their being jaw-set; they should be applied with unwearied diligence every two or three hours, where ever any stiffness or contractions in the muscles appear; for a horse in this condition never lies down till they are in some measure removed.

The use of rowels in these cases is generally unsuccessful, the skin being so tense and tight, that they seldom digest kindly, and sometimes mortify; so that if they are applied, they should be put under the jaws, and in the breast.

The red-hot iron so frequently run through the forehead and mane, near the occipital bone, for this purpose, has often been found to have destroyed the cervical ligament.

In paralytic disorders, where the use of a limb or limbs is taken away, the internals above recommended should be given, in order to warm, invigorate, and attenuate the blood; and the following stimulating embrocation should be rubbed into the parts affected.

**TAKE** oil of turpentine four ounces, nerve ointment and oil of bays of each two ounces, camphor rubbed fine one ounce, rectified oil of amber three ounces, tincture of cantharides one ounce.

With this liniment the parts affected should be well bathed for a considerable time, to make it penetrate; and when the hind parts chiefly are lame, the back and loins should be well rubbed with the same. To the nervous medicines above recommended, may be added snake-root, contrayerva, mustard-seed, horse-raddish root steeped in strong beer, or wine where it can be afforded. Take the following for an example, which may be given to the quantity of three pints a-day alone, or two horns full may be taken after the nervous balls.

**TAKE** snake-root, contrayerva, and valerian, of each half an ounce; mustard-seed and horse-raddish root scraped, of each two ounces; long pepper two drams; infuse in three pints of strong wine.

When the horse is recovering from any of the above disorders, the following alterative purge may be repeated two or three times, as it operates very gently.

**TAKE** succotrine aloes one ounce, myrrh half an ounce, *assa fœtida* and gum ammoniacum of each two drams, saffron one dram; make into a ball with any syrup.

Where a retention of dung is the cause of this disorder, the great gut should first be raked thoroughly with a small hand, after which plenty of emollient oily glysters should be thrown up, and the opening drink given, till the bowels are thoroughly emptied of their imprisoned dung. Their diet should for some days be opening, and consist



confist chiefly of scalded bran, with flower of brimstone, scalded barley, &c.

*Of the STRANGLES, and VIVES.*

THE strangles is a distemper to which colts and young horses are very subject; and begins with a swelling between the jaw-bones, which sometimes extends to the muscles of the tongue; and is attended with so great heat, pain, and inflammation, that sometimes, till matter is formed, the horse swallows with the utmost difficulty.

The symptoms are extraordinary heat and feverishness, with a painful cough, and a great inclination to drink without being able; some horses losing their appetite entirely, others eating but little, by reason of the pain which chewing and swallowing occasions: when the swelling begins on the inside of the jaw-bones, it is much longer in coming to matter than when more to the middle; when it arises among the glands, and divides into several tumours, the cure is generally tedious, as it breaks in different places; and when it forms upwards on the wind-pipe and gullet, there is sometimes danger of suffocation, unless the swelling soon breaks. But the most dangerous kind is, when, besides the above symptoms, the horse runs at the nose; this is by some called the *bastard strangles*.

As this disorder seems to be critical, the most approved method is to assist nature in bringing the swellings to maturity, by keeping them constantly moist with ointment of marshmallows, and covering the head and neck with a warm hood. But as all swellings in glandular parts suppurate slowly, the following poultice may be applied hot twice a-day.

TAKE leaves of marshmallows ten handfuls, white-lily root half a pound, linseed and fenugreek-seed bruised of each four ounces; boil them in two quarts of water till the whole is pulpy, and add four ounces of ointment of marshmallows, and a sufficient quantity of hogs-lard, to prevent its growing stiff and dry.

In five or six days, by these means, the matter is generally formed, and makes its way through the skin; and if the discharge is made freely and with ease, the opening need not be enlarged; but should be dressed with the following ointment spread on raw, still continuing the poultice over it to promote the digestion, and prevent any remaining hardness.

TAKE rosin and Burgundy pitch of each a pound and a half, honey and common turpentine each eight ounces, yellow wax four ounces, hogs-lard one pound, verdigrease finely powdered one ounce; melt the ingredients together, but do not put in the verdigrease, till removed from the fire; and it should be stirred in by degrees, till the whole is grown stiff and cool.

If the fever and inflammation run high, and the swelling be so situated as to endanger suffocation, a moderate quantity of blood must be taken away, and the remainder diluted with plenty of water-gruel, or warm water, mashes, &c.

The running at the nose which often attends the stran-

gles is dangerous, especially if it continues after they have ripened and broke, as the horse will be greatly weakened thereby. To prevent this waste and decay, give him every day for some time an ounce of Jesuit's bark; or a strong decoction of guaiacum shavings, which hath been found extremely beneficial in restraining these glandular discharges when too liberal, and in drying up ulcers of all kinds in horses.

If a hardness remains after the sores are healed up, they may be anointed with the mercurial ointment; and when the horse has recovered his strength, purging will be necessary.

The vives or ives differ from the strangles only in this; that the swellings of the kernels, under the ears of the horse, (which are the parts at first chiefly affected), seldom gather, or come to matter, but by degrees perspire off and disperse by warm cloathing, anointing with the marshmallow ointment, and a moderate bleeding or two. But should the inflammation continue notwithstanding these means, a suppuration must be promoted by the methods above recommended in the strangles.

When these swellings appear in an old or full-aged horse, they are signs of great malignity, and often of an inward decay, as well as forerunners of the glanders.

The mercurial ointment above-mentioned, may be prepared thus:

TAKE of crude mercury or quicksilver one ounce, Venice turpentine half an ounce; rub together in a mortar till the globules of the quicksilver are no longer visible; then add two ounces of hogs-lard.

*Of the Diseases of the EYES.*

IN order to make the disorders of the eyes well understood, we shall consider them as arising from different causes; external injuries affecting the globe of the eye; and from internal causes affecting the humours within the globe. We shall consider also the eye as naturally weak from a bad conformation, which possibly may often be hereditary.

In all recent disorders of the eye from external injuries, such as blows, bites, &c. attended with a swelling of the lid, and a running from the eye, you must first sponge the part often with cold spring-water and vinegar; and if much swelled, bleed immediately, and apply over it a poultice made of the pulps of roasted or boiled apples, cleared from their seeds and husks; or of conserve of roses and vinegar, with a little bole, and the white of an egg. When the swelling is abated, either of the following washes will complete the cure.

TAKE white vitriol half an ounce, sugar of lead two drams; dissolve in a pint of spring-water; to which may occasionally be added, when the rheum is very great, and inflammation removed, half an ounce of tully, or compound powder cerufs.

Let the eye and eyelid be bathed three or four times a-day with a clean sponge dipped in this wash; or it may be applied with a feather, leaving a few drops on the eye. When the veins under the eye have been turgid, opening them with a lancet has often been found successful.

M

Mr Gibson, from his own experience, recommends the following, with which alone he has succeeded in most common cases.

TAKE two drams of rose-buds, infuse them in half a pint of boiling water; when cold, pour off the infusion, and add to it twenty grains of sugar of lead.

This is to be used as the former; but the quantity of sugar of lead may occasionally be increased.

Sometimes from the violence of the inflammation, succeeding blows, and external injuries, the coats of the eye shall lose their transparency, thicken, and turn white, or pearl-colour; in the latter case, the horse has some glimmering of light; in the former, he is blind while the eye continues in this state.

If the horse be fleshy and of a gross constitution, bleeding may be repeated, and a rowel will be necessary: let his diet be scalded bran or barley; avoiding for some days oats, beans, or any thing hard to chew.

The cooling opening drink, (p. 547. col. 1. par. 1.) should be given every other day, which will answer better than aloeic purges.

If the eye-lids continue swelled and moist, and the under side of the eye inflamed, an ounce of honey may be added to four ounces of the above waters; or the part may be well bathed with an ounce of honey of roses, and half a dram of sugar of lead, dissolved in three ounces of spring-water: to which may be added, when the eye is very watery, a spoonful or two of red wine, which will help to thicken the matter and dry it up.

If a film or thick slough should remain, it may be taken off, by blowing into the eye equal parts of white vitriol and sugar-candy finely powdered.

Glass finely powdered, mixed up with honey and a little fresh butter, is much recommended by Dr Bracken for this purpose; as also the following ointment.

TAKE ointment of tatty one ounce, honey of roses two drams, white vitriol burnt one scruple; this, with a feather, may be smeared over the eye twice a-day.

Let it be remembered, that it has long been observed in practice, that the eye in its first state of inflammation is so very tender, that the eye-waters prepared with tatty and other powders aggravate the disorder; consequently, during this state, the tinctures of vegetables and solutions of salts are greatly preferable.

Wounds of the eye may be dressed with honey of roses alone, or with a little sugar of lead mixed with it, adding thereto, after a few days, an eighth part of tincture of myrrh; all the preceding directions in regard to inflammation being attended to, especially bleeding, rowels, and gentle cooling physic.

When the humours of the eye are thickened, and the disorder is within the globe, sharp external applications are not only useless, but extremely detrimental, by the irritation they occasion, and consequently should be avoided.

In all cases of this sort, whether moon-eyes, which are only cataracts forming, or in confirmed ones attended with a weeping; general evacuations, with internal alteratives, can only take place.

These generally make their appearance, when a horse is turned five, coming six; at which time one eye becomes clouded, the eye-lids being swelled, and very often shut up; and a thin water generally runs from the diseased eye down the cheek, so sharp as sometimes to excoriate the skin; the veins of the temple, under the eye, and along the nose, are turgid and full: though sometimes it happens that the eye runs but little.

This disorder comes and goes till the cataract is ripe; then all pain and running disappears, and the horse becomes totally blind, which is generally in about two years. During this time some horses have more frequent returns than others; which continue in some a week or more, in others three or four; returning once in two or three months, and they are seldom so long as five without a relapse.

There is another kind of moon-blindness, which is also the forerunner of cataracts, where no humour or weeping attends. The eye is never shut up or closed here, but will now and then look thick and troubled, at which time the horse sees nothing distinctly: when the eyes appear sunk and perishing, the cataracts are longer coming to maturity; and it is not unusual in this case for one eye to escape.

These cases generally end in blindness of one, if not of both eyes; the most promising signs of recovery are when the attacks come more seldom, and their continuance grows shorter, and that they leave the cornea clear and transparent, and the globe plump and full.

The attempts to cure cataracts have hitherto been only palliative and mitigating the symptoms; yet early care has sometimes been successful. To this end the horse should be rowel'd and bled at proper intervals; except where the eyes appear sunk and perishing, where it is often pernicious. During the violence of the symptoms, observe the cooling treatment above recommended, giving him two ounces of nitre every day mixed into a ball with honey, and bathe the parts above the eye with verjuice, or vinegar, wherein rose-leaves are infused; to four ounces of which, half a dram of sugar of lead may be added. The swelling on the lid may afterwards be bathed with a sponge dipt in equal parts of lime and Hungary water, mixed together: the cooling physic, (p. 545 col. 1. par. 4.) should be given every fourth day, till the eye becomes clear, and recovers its usual brightness. The following also is very proper physic for this purpose.

TAKE lenitive electuary and cream of tartar of each four ounces, Glauber's salts three ounces, syrup of buckthorn two ounces.

When the weeping is by these means removed, the alterative powders (See the section, *Of ALTERATIVE MEDICINES*) should be given every day, till two or three pounds are taken, and after an interval of three months, the same course should be repeated. This method has often been attended with good success, where the eyes have been full, and no way perished; in that case, bathe or foment them with the following, twice a-day.

TAKE crude sal armoniac two drams, dissolve in a pint of lime-water, and add to it four ounces of brandy, or Hungary water.

This will act as a stimulus, and may help to thin and rarify

rarify the gummy juices, and bring new supplies of nourishment to the perishing eyes.

This course not succeeding, in order more powerfully to open the vessels of the chrySTALLINE humour, (which in these cases is always found opaque, and, when the cataract is confirmed, entirely loses its transparency,) and hinder as much as possible the forming of obstructions, mercurials are chiefly to be depended on: thus give every other day, for three or four mornings, two drams of calomel, mixed up with conserve of roses; and then purge off with the common ball.

During this course, particular care should be taken of the horse: after repeating this, the alterative powders before-mentioned should be given for some weeks or months, if you expect any benefit from them; or they may be beat up into a ball with live millepedes, and an ounce and a half given every day: if these should not succeed, and the horse is a valuable one, the turbid course recommended in the section on alteratives, seems to be the most promising method left. But to horses that are not so, an ounce of antimony, ground into an impalpable powder, may be given every day in one of his feeds for three months or longer; or a strong decoction of guaiacum shavings may be given for some time, to which crude antimony may be given in the following manner.

**Take** guaiacum shavings one pound, crude antimony tied in a rag the same quantity; boil in two gallons of forge-water to one, and give a quart a-day, either alone, or mixed with his water.

The haws is a swelling and sponginess that grows in the inner corner of the eye, so large sometimes as to cover a part of the eye. The operation here is easily performed by cutting part of it away; but the farriers are apt to cut away too much; the wound may be dressed with honey of roses; and if a fungus or spongy flesh arises, it should be sprinkled with burnt alum, or touched with blue vitriol.

#### *Of the GLANDERS.*

THE cause and seat of the glanders has till lately been so imperfectly handled, and so little understood by the writers of this distemper, that it is no wonder it should be ranked among the incurables: but a new light having been thrown on this whole affair by the study of M. La Fosse, the king of France's farrier, who has been at the pains to trace out, and discover, by dissections, the source and cause of this disorder; we hope the method he has proposed, with some further experiments and improvements, will soon bring to a certainty of cure (in most cases at least) a distemper so dangerous to our horses, and that hitherto has eluded the force of art.

M de la Fosse has distinguished seven different kinds of glanders, four of which are incurable.

The first proceeds from ulcerated lungs, the purulent matter of which comes up the trachea, and is discharged through the nostrils, like a whitish liquor, sometimes appearing in lumps and grumes: in this disorder, though the matter is discharged from the nostrils, yet the malady is solely in the lungs.

The second is a wasting humour, which usually seizes horses at the decline of a disease, caused by too hard labour; this defluxion also proceeds from the lungs.

The third is a malignant discharge, which attends the strangles sometimes, and falls upon the lungs, which runs off by the nostrils.

The fourth is, when an acrimonious humour in the farcy seizes these parts, where it soon makes terrible havoc.

The fifth kind we shall describe by and by, as arising from taking cold.

The sixth kind is a discharge from the strangles, which sometimes vents itself at the nostrils.

These are the various disorders which have been observed sometimes to throw matter out from the nostrils; let us now describe the real glanders.

The matter, then, discharged from the nostrils of a glandered horse, is either white, yellow, or greenish, sometimes streaked, or tinged with blood: when the disease is of long standing, and the bones are fouled, the matter turns blackish, and becomes very fetid; and is always attended with a swelling of the kernels or glands under the jaws; in every other respect the horse is generally healthy and sound, till the distemper has been of some continuance.

It is always a bad sign, when the matter sticks to the inside of the nostrils, like glue or stiff paste; when the inside of the nose is raw, and looks of a livid or lead colour; when the matter becomes bloody, and stinks, and when it looks of an ash-colour. But when only a limpid fluid is first discharged, and afterwards a whitish matter, the gland under the jaw not increasing, and the disorder of no long continuance, we may expect a speedy cure; for in this case, which arises from taking cold, after a horse has been overheated, the pituitary membrane is but slightly inflamed, the lymph in the small vessels condensed, and the glands overloaded, but not yet ulcerated.

From these symptoms, and some observations made both by Bracken and Gibson, it is plain they were not absolute strangers to the seat of this disorder, though they neglected pushing their inquiries to the fountain-head, and consequently were at a loss to know how to apply the remedy to the parts affected.

But our author, after examining by dissection the carcasses of glandered horses, and making a strict scrutiny into the state of the viscera, assisted for that purpose by ingenious and expert anatomists, for ten years together, ascertains this disease to be altogether local; and that the true seat of it is in the pituitary membrane which lines the partition along the inside of the nose, the maxillary sinuses or cavities of the cheek-bones on each side the nose, and the frontal sinuses or cavities above the orbits of the eyes; that the viscera, as liver, lungs, &c. of glandered horses are in general exceeding sound; and consequently that the seat of this disorder is not in those parts, as has been asserted by most authors; nor indeed is it probable it should: for how could such horses preserve their appetite, their good appearance, sleek and shining coats? in a word, all the signs of health for many years together (which many glandered horses are known to enjoy) with such distempered bowels.

But on nicely examining the heads of such horses, he found the cavities above-mentioned more or less filled with a viscous slimy matter, the membrane which lines both them and the nostrils inflamed, thickened, and corroded

with sordid ulcers, which in some cases had eat into the bones.

He observes, that when glandered horses discharge matter from both nostrils, both sides of the membrane and cavities were affected; but when they ran at one nostril only, that side only was found distempered.

It is a curious remark of our author, that the sublingual glands, or the kernels situated under the jaw-bone, which are always swelled in this distemper, do not discharge their lymph into the mouth, as in man, but into the nostrils; and that he constantly found their obstruction agreed with the discharge; if one gland only was affected, then the horse discharged from one nostril only; but if both were, then the discharge was from both.

The seat of this disorder thus discovered, our author with great ingenuity has paved the way for cure, by trepanning these cavities, and taking out a piece of bone, by which means the parts affected may be washed with a proper injection, and in fine the ulcers deterged, healed, and dried up.

But as from the observations since made by this gentleman, there are different species of the glanders, so the cure of the milder kinds may first be attempted by injections and fumigations: thus after taking cold, should a horse for fifteen or twenty days discharge a limpid fluid or whitish matter from one or both nostrils, the glands under the jaw rather growing harder than diminishing, we may expect it will degenerate into a true glanders. To prevent which, after first bleeding, and treating him as we have directed for a cold, let an emollient injection, prepared with a decoction of linseed, marshmallows, elder, chamomile flowers, and honey of roses, or such like, be thrown up as far as possible with a strong syringe, and repeated three times a-day: should the running not lessen or be removed in a fortnight by the use of this injection, a restraining one may now be prepared with tincture of roses, lime-water, &c. and the nostrils fumigated with the powders of frankincense, mastich, amber, and cinnabar, burnt on an iron heated for that purpose; the fume of which may easily be conveyed through a tube into the nostrils.

This method has been found successful when used in time; but the methods of cure depend on the stubbornness of the disorder; and when inveterate, recourse must be had to the operation above described.

*Of the CHOLIC or GRIPES, and Pains in the Bowels, from sudden accidents.*

There seems to be no distemper so little understood by the common farrier, as the cholic or gripes in horses, one general remedy or method serving them in all cases; but as this disorder may be produced by very different causes, the method of cure must also vary, otherwise the intended remedy, injudiciously applied, will not only aggravate the complaint, but make it fatal. We shall divide this disorder into three different species: the stultent or windy, the bilious or inflammatory, and the dry gripes; each of which we shall distinguish by their different symptoms, and then point out the proper remedies.

The stultent or windy cholic is thus known. The horse is often lying down, and as suddenly rising again

with a spring; he strikes his belly with his hinder feet, stamps with his fore-feet, and refuses his meat; when the gripes are violent, he will have convulsive twitches, his eyes be turned up, and his limbs stretched out as if dying, his ears and feet being alternately very hot and cold; he falls into profuse sweats, and then into cold damps; strives often to stale, and turns his head frequently to his flanks; he then falls down, rolls about, and often turns on his back; this last symptom proceeds from a stoppage of urine, that almost always attends this sort of cholic; which may be increased by a load of dung pressing on the neck of the bladder.

These are the general symptoms of cholic and gripes from wind, drinking cold water when hot, and when the perspirable matter is retained, or thrown on the bowels by catching cold; in all which cases they are violently distended. Cribbing horses are more particularly subject to this complaint, by reason they are constantly sucking in great quantities of air.

The first intention is to empty the strait gut with a small hand dipt in oil, which frequently makes way for the confined wind to discharge itself; and by easing the neck of the bladder, the suppression of urine is taken off, and the horse stales and gets ease.

The following ball and glyster seldom fail of giving relief in these cases.

**TAKE** Strasburgh or Venice turpentine, and juniper-berries pounded, of each half an ounce; salt-prunella, or salt-petre, an ounce; oil of juniper, one dram; salt of tartar, two drams; make into a ball with any syrup; it may be given whole, and washed down with a decoction of juniper-berries, or a horn or two of ale.

If the horse does not break wind, or stale plentifully, he will find no relief; therefore in an hour or two give him another ball, and add to it a dram of salt of amber; which may be repeated a third time, if found necessary. During the fit the horse may be walked and trotted gently, but should by no means be harassed beyond his ability, or dragged about till he is jaded.

The following glyster may be given, between the balls, or alone, and repeated occasionally.

**TAKE** chamomile flowers two handfuls; anise, coriander, and fennel seeds, of each an ounce; long pepper half an ounce; boil in three quarts of water to two; and add Daffy's elixir, or gin, half a pint; oil of amber half an ounce, and oil of chamomile eight ounces.

The signs of a horse's recovery, are his lying quiet, without starting, or tumbling, and his gathering up his legs, and ceasing to lash out; and if he continues an hour in this quiet posture, you may conclude all danger over.

The next species of cholic we shall describe, is the bilious or inflammatory; which besides most of the preceding symptoms, is attended with a fever, great heat, panting, and dryness of the mouth; the horse also generally throws out a little loose dung, with a hot scalding water, which when it appears blackish, or of a redish colour, and fetid smell, denotes an approaching mortification.

In this case the horse should immediately be bled to the quantity of three quarts; and it should be repeated, if the symptoms do not abate in a few hours. The emollient

lent glyster, with two ounces of nitre dissolved in it, should be thrown up twice a-day, to cool the inflamed bowels; plenty of gum-arabic water should be taken, and a pint of the following drink given every two or three hours, till several loose stools are procured; and then it should be given only night and morning till the disorder is removed.

TAKE fenna three ounces, salt of tartar half an ounce; infuse in a quart of boiling water an hour or two; then strain off, and add two ounces of lenitive electuary, and four of Glauber's salts.

If this disorder is not removed by these means, but the inflammation and fever increase, attended with a discharge of the flesh coloured water above described, the event will most probably be fatal: and the chief thing to be depended on now, must be a strong decoction of Jesuits bark, given to the quantity of a pint every three hours, with a gill of red port-wine.

A quart of the same may be used for a glyster, with two ounces of Venice turpentine, dissolved with the yolks of two eggs, an ounce of diascordium, and a pint of red wine, and given twice a-day: if the horse recovers, give two or three mild rhubarb purges.

The last we shall describe is the dry gripes, or the cholick, which arises often from costiveness; it is discovered by the horse's frequent and fruitless motion to dung, the blackness and hardness of the dung, the frequent and quick motion of his tail, the high colour of his urine, and his great restlessness and uneasiness.

In this case the strait gut should be examined and emptied with a small hand oiled properly for that purpose; the emollient oily glyster, (p. 545. col. 2. par 7.) should be thrown up twice a day; and the above purging drink given, till the bowels are unloaded, and the symptoms removed.

The diet for a horse in the gripes, should be scalded bran, warm water-gruel, or white water, made by dissolving four ounces of gum-arabic in a quart of water, and mixing it with his other water.

From this history and division of gripes and cholicks, with their different treatment, it appears how absolutely necessary it is they should be well understood, in order to be managed skilfully: it is plain too, that violent hot medicines should in every species of this disorder be guarded against, and given with great caution and discretion, even in the first kind of flatulent cholick, where indeed they can only be wanted; yet too often, when prepared by the farriers with oil of turpentine, geneva, pepper, and brine, &c. they even increase that disorder, by stimulating the neck of the bladder, too forcibly heating the blood, and inflaming the bowels, till a mortification is brought on them. These are, in general, the constant appearances of horses that die of this disorder, whose bowels being examined for that purpose, have been found inflamed, full of red and livid spots, sometimes quite black, cripped with extreme heat, and rotten.

*Of the LAX and SCOURING, with other Disorders of the STOMACH and BOWELS.*

IT is sometimes a nice matter to form a proper judgment when to controul or encourage a looseness, but these

general rules may be a direction: If a healthy full horse, on taking cold, or upon hard riding, overfeeding, eating unwholesome food, or with a slight fever, should have a moderate purging, by no means think of stopping it; but rather encourage it with an open diet, and plenty of warm gruel: but if it continues long, with gripings, the mucus of the bowels coming away, and the horse losing his appetite and flesh, it is then high time to give him proper medicines; if he voids great quantities of slime and greasy matter, give him the following drench, and repeat it every other day for three times.

TAKE lenitive electuary and cream of tartar of each four ounces, yellow rosin finely powdered one ounce, and four ounces of sweet oil; mix with a pint of water gruel.

The following alterative ball alone has been found successful for this purpose, when given twice a-week. with scalded bran and warm gruel.

TAKE succotrine aloes half an ounce, diapente one ounce; make into a ball with the juice of Spanish liquorice dissolved in water, and a spoonful of oil of amber.

To this may be added two drams of myrrh, and a dram of saffron, and (where it can be afforded) half an ounce of rhubarb.

When the purging is attended with a fever, rhubarb should first be given to the quantity of half an ounce, with an ounce and half of lenitive electuary; at night after the working, give half an ounce or more of diascordium in a pint of red wine mulled with cinnamon, and repeat it every day, and the rhubarb ball once in two or three.

But if the distemper increases, the horse's flanks and belly look full and distended, and he appears griped and in pain, let this glyster be given, and the quantity of diascordium increased an ounce in his night-drink

TAKE chamomile flowers one handful, red roses half a handful, pomegranate and balaustines of each an ounce; boil in two quarts of water to one; strain off, and dissolve in it two or three ounces of diascordium, and one of mithridate; to which may be added a pint of port wine: repeat it once a-day.

If the flux continues violent, give an ounce of rock-alum, with an ounce and a half of bole, twice a-day; or, dissolve double this quantity with two ounce of diascordium, and the cordial ball, in two quarts of harts-horn drink; to which may be added a pint of port; and give the horse, three or four times a-day, a pint of this drink. For this purpose also a strong decoction of oak-bark may be given, with either of the above remedies, and to the same quantity; even by itself, it will be found on trial no inconsiderable remedy.

When the discharge is attended with an acrid mucus or slime, the griping and pains are very severe, the common lining of the bowels being washed away; in this case the following glyster should frequently be injected warm.

TAKE of tripe liquor or thin starch two quarts, oil of olives half a pint, the yolk of six eggs well broke, and two or three ounces of course sugar.

Some horses having naturally weak stomachs and bowels,

bowels, throw out their aliment undigested; their dung is habitually soft, and of a pale colour; they feed poorly, and get no flesh: to remedy this complaint, give the following purge two or three times; and then the infusion to the quantity of a pint every morning.

**TAKE** succotrine aloes six drams, rhubarb powdered three drams, myrrh and saffron each a dram; make into a ball with syrup of ginger.

*Infusion.*—**TAKE** zedoary, gentian, winters bark, and orange-peel, of each two ounces; pomegranate-bark and balaustine, of each an ounce; chamomile flowers and centaury, each a handful; cinnamon and cloves, each an ounce: infuse in a gallon of port or strong beer.

The bloody flux is a distemper horses are not very subject to; however, as it sometimes does occur, whenever blood is discharged, attended with gripings, and great pain in the bowels, if the flux is not speedily restrained, the horse probably may be soon lost: we recommend therefore the following glyster and drink for that purpose.

**TAKE** oak-bark four ounces, tormentil-root two ounces, burnt hartshorn three ounces; boil in three quarts of forge-water to two; strain off, and add two ounces of diascordium, four ounces of starch, and half a dram of opium.

A glyster may also be prepared with the same quantity of fat broth, starch and opium, in order to plaster over the coats of the bowels, and abate their violent irritations. Also,

**TAKE** soft chalk two ounces, mithridate or diascordium one ounce, powder of Indian-root half a dram, liquid laudanum fifty or sixty drops; dissolve in a pint of hartshorn drink, and add to it four ounces of cinnamon-water or red wine: give it twice a day.

Gum arabic dissolved in hartshorn drink, or in common water, should be the horse's usual drink.

When horses are apt to be colicive, from whatever cause it arises, gentle openers should be given; such as cream of tartar, Glauber's salts, and lenitive electuary; four ounces of any two of these dissolved in warm ale, whey, or water, given every other morning for two or three times, will answer this purpose; especially if assisted by an oily emollient glyster, prepared with a handful of salt. Scalded bran or barely, with an ounce of fenugreek and linseed, occasionally given, will prevent this complaint: but where it is constitutional, and proceeds from the power and force of digestion in the stomach and guts, as sometimes happens, and the horse is otherwise in perfect health, no inconvenience will arise from it; and it is observed that such horses are able to endure great fatigue and labour.

#### Of WORMS and BOTS.

**AUTHORS** have described three different sorts of worms that affect horses, *viz.* *Bots*, which young horses are often troubled with in the spring; the *Rotundi*, or those resembling earth worms; and the *Ascarides*, or those about the size of the largest sewing needle, with flat heads.

The bots which breed in the stomachs of horses, and are sometimes the cause of convulsions, appear to be very large maggots, composed of circular rings, with little sharp prickly feet along the sides of their bellies (like the feet of hog-lice), which by their sharpness (like the points of the finest needles) seem to be of use to fasten them to the part where they breed and draw their nourishment, and to prevent their being loosened from such adhesion before they come to maturity. The eggs from whence these bots are produced, are dispersed into clusters all round the lower orifice of the stomach, and are laid under the inner coat or thin membrane of the stomach; so that when the animals come to form and life, they burst through this inner coat with their breech and tail straight outwards, and their trunks so fixed into the muscular or fleshy coat of the stomach, that it sometimes requires a good pull to disengage them; from the blood of this last coat they draw their nourishment, which they suck like so many leeches, every one ulcerating and purging up the part where it fixes like a honey-comb; and they often make such quick havock, as to destroy the horse.

The symptoms of worms are various. The bots that many horses are troubled with in the beginning of the summer, are always seen sticking on the strait gut, and are often thrust out with the dung, with a yellowish coloured matter like melted sulphur; they are noways dangerous there, but are apt to make a horse restless and uneasy, and rub his breech against the posts. The season of their coming is usually in the months of May and June, after which they are seldom to be seen, and rarely continue in any one horse above a fortnight or three weeks. Those that take their lodgment in the stomach, are extremely dangerous by causing convulsions; and are seldom discovered by any previous signs before they come to life, when they throw a horse into violent agonies. The other kinds are more troublesome than dangerous; but are known by the following signs: The horse looks lean and jaded, his hair stares as if he was surfeited, and nothing he eats makes him thrive; he often strikes his hind-feet against his belly, is sometimes griped, but without the violent symptoms that attend a cholic or stranguery; for he never rolls and tumbles, but only shews uneasiness, and generally lays himself down quietly on his belly for a little while, and then gets up and falls a feeding; but the surest sign is when he voids them with his dung.

For the cure of bots in the stomach, we have already taken notice that calomel should first be given in large quantities, and repeated at proper intervals, (see p. 554. col. 1.) *Æthiops mineral*, or some of the under-mentioned forms, may be given afterwards.

But bots in the strait gut may be cured by giving the horse a spoonful of savin, cut very small, once or twice a-day in his oats or bran, moistened; and three or four cloves of garlick may be added to advantage. Give also an aloeic purge between whites; the following stands recommended.

**TAKE** fine succotrine aloes, ten drams; fresh jallap, one dram; aristochia, or birthwort, and myrrh powdered,

powdered, of each two drams; oil of favin and amber, of each one dram; syrup of buckthorn enough to form into a ball.

But as the source of worms in general proceeds from a vitiated appetite and a weak digestion, recourse must first be had to mercurials, and afterwards to such things as are proper to strengthen the stomach, promote digestion, and, by destroying the supposed ova, prevent the regeneration of these animals. Thus, two drams of calomel may be given with half an ounce of diapente, and mixed up with conserve of wormwood, over night; and the next morning the above purge: these may be repeated six or eight days. Or the following mercurial purge may be given, which will be less troublesome, and no less efficacious.

TAKE crude quicksilver two drams, Venice turpentine half an ounce; rub the quicksilver till no glistening appears; then add an ounce of aloes, a dram of grated ginger, thirty drops of oil of favin, and a sufficient quantity of syrup of buckthorn to make a ball.

One of these balls may be given every six days, with the usual precautions in regard to mercurial physic; and these powders intermediately.

TAKE powdered tin and Æthiops mineral of each half an ounce: give every night in a mash, or among his corn.

The various preparations of antimony and mercury must be given several weeks together, in order to get entire riddance of these vermin. The Æthiops mineral may be given to the quantity of half an ounce a-day; the the mercurius alkalifatus to two drams a-day, incorporated with a bit of cordial ball. The cinnabar powders, as directed in the farcy, are no less effectual: and when worms are bred from high feeding, or unwholesome food; rue, garlick, tanfy, favin, box, and many other simples, may be given successfully; being for that purpose mixed with their food; as also cut tobacco, from half an ounce to an ounce a-day.

#### *Of the YELLOWS, or JAUNDICE.*

HORSES are frequently subject to this distemper; which is known by a dusky yellowness of the eyes; the inside of the mouth and lips, the tongue and bars of the roof of the mouth, looking also yellow. The horse is dull, and refuses all manner of food; the fever is slow, yet both that and the yellowness increase together. The dung is often hard and dry, of a pale yellow, or light pale green. His urine is commonly of a dark dirty brown colour; and when it has settled some time on the pavement, it looks red like blood. He stales with some pain and difficulty; and if the distemper is not checked soon, grows delirious and frantic. The off-side of the belly is sometimes hard and distended; and in old horses, when the liver has been long diseased, the cure is not practicable, and ends fatally with a wasting diarrhæa: but when the distemper is recent, and in young horses, there is no fear of a recovery, if the following directions are observed.

First of all bleed plentifully; and give the laxative glyster (p. 547. col. 1. par. 2. from the bottom) as horses

are apt to be very costive in this distemper; and the next day give him this purge.

TAKE of Indian rhubarb powdered one ounce and a half, saffron two drams, succotrine aloes six drams, syrup of buckthorn a sufficient quantity.

If the rhubarb should be found too expensive, omit it, and add the same quantity of cream of tartar, and half an ounce of Castile soap, with four drams more of aloes. This may be repeated two or three times, giving intermediately the following balls and drink.

TAKE of Æthiops mineral half an ounce, millepedes the same quantity, Castile soap one ounce; make into a ball, and give one every day, and wash it down with a pint of this decoction.

TAKE madder-root and turmeric of each four ounces, burdock-root sliced half a pound, Monk's rhubarb four ounces, liquorice sliced two ounces; boil in a gallon of forge-water to three quarts; strain off; and sweeten with honey.

Balls of Castile soap and turmeric may be given also for this purpose, to the quantity of three or four ounces a day, and will in most recent cases succeed.

By these means the distemper generally abates in a week, which may be discovered by an alteration in the horse's eyes and mouth; but the medicines must be continued till the yellowness is intirely removed. Should the distemper prove obstinate, and not submit to this treatment, you must try more potent remedies, viz. mercurial physic, repeated two or three times at proper intervals; and then the following balls.

TAKE salt of tartar two ounces, cinnabar of antimony four ounces, live millepedes and filings of steel of each three ounces, saffron half an ounce, Castile or Venice soap half a pound: make into balls, the size of a pullet's egg, with honey; and give one, night and morning, with a pint of the above drink.

It will be proper, on his recovery, to give two or three mild purges; and if a fat full horse, to put in a rowel.

#### *Of the Disorders of the KIDNEYS and BLADDER.*

THE signs of the kidneys being hurt or affected are, a weakness of the back and loins, difficulty of staling, faintness, loss of appetite, and deadness in the eyes; the urine is thick, foul, and sometimes bloody, especially after a violent strain. A horse diseased in his kidneys can seldom back, that is, move strait backwards without pain, which is visible as often as he is put to the trial: the same thing is observable indeed in horses, whose backs have been wrung and wrenched; but with this difference, that in the latter there is seldom any defect or alteration in the urine, except that it is higher coloured.

Bleeding is the prime remedy, and that plentifully, in order to prevent inflammation; and the more so, if a fever attends a difficulty in staling, for then we may suspect the kidneys already inflamed. A rowel in the belly has been found useful; and the following balls may be given twice or thrice a-day, with a pint of marshmallow-decoction, in which half an ounce of gum arabic is dissolved, with an ounce of honey.

TAKE lucatellus-balsam one ounce, spermaceti six drams,

†

6 B

drams,

drams, sal prunella half an ounce; mix into a ball with honey: if the urine is bloody, add half an ounce of Japan earth.

Should the fever continue, bleed largely, give emollient glysters, and the cooling opening drink, (p. 547. col. 1. par. 3.) till it abates.

If the urine passes with difficulty and pain, notwithstanding these means, give this ball, and repeat it twice or thrice a-day till the horse stales frèer and without pain, his urine become of a right consistence, and free from any purulent settlement.

**TAKE** balsam of copivi or Strafsburgh turpentine, and Venice soap, of each one ounce, nitre six drams, myrrh powdered two drams; make into a ball with honey, and wash it down with the marshmallow decoction.

As a suppression of urine arises sometimes from an inflammation of the kidney; so at others, from a paralytic disorder, disabling them in their office of separating the urine from the blood: in this latter case, the bladder is usually empty, so that a horse will make no motion to stale; and if he continues a few days in this condition, his body will swell to a great degree, breaking out in blotches all over, and death will soon close the scene.

If it arises from inflammation, bleed largely, and treat the horse as above recommended; but if not, give stimulating glysters, and strong diuretics, such as the following balls, once in four hours: for if a horse stales not in thirty hours, his danger must be great.

**TAKE** juniper-berries powdered one ounce, sal prunella six drams, ætherial oil of turpentine half an ounce, camphor one dram, oil of juniper two drams; make into a ball with honey, and give after it three or four horns of the marshmallow decoction and honey.

Or,

**TAKE** squills powdered two or three drams, nitre half an ounce or six drams; make into a ball with honey.

If the complaint is not removed by these means, rub the horse's reins well with two parts of oil of turpentine, and one of oil of amber; and apply a poultice of garlick, horse raddish, mustard-seed, camphor, and green soap, spread on thick cloth, over them. Give the horse also two drams of calomel over night, and a moderate purge the next morning. These perhaps are the chief and best remedies that can be given in this generally fatal disorder.

When the strangury in a horse does not arise from wind, or dung pressing on the neck of the bladder (as was observed in the Section on Cholicks) the cause is from inflammation, or too long a retention of the urine. Such horses make frequent motions to stale, stand wide and straddling, are full, and have their flanks distended. In this case bleed largely; give the following drink, and repeat it every two hours, for two or three times, till the horse is relieved.

**TAKE** Venice turpentine, broke with the yolk of an egg, one ounce, nitre or sal prunella six drams, half a pint of sweet oil, and a pint of white wine.

If this drink should not have the desired effect, the diu-

retic ball above mentioned may be given in the same manner, omitting the myrrh.

Give the horse plenty of the marshmallow decoction, in a quart of which dissolve an ounce of nitre and gum arabic, and two of honey.

Horses subject to a *diabetes*, or profuse staling, if old, or of a weak constitution, are seldom cured; they soon lose their flesh and appetite, grow feeble, their coat staring, and they die rotten. Of a young horse there are more hopes; but he must not be indulged with too much water, or moist food. Give him the following:

**TAKE** jesuit's bark four ounces, bistort and tormentil-root of each two ounces; boil in two gallons of lime-water to the consumption of half, and give a pint three times a-day.

As this disorder generally proceeds from too violent exercise, over-training, &c. repeated bleedings in small quantities are absolutely necessary, till the mouths of the vessels close up.

#### Of MOLTEN-GREASE.

By molten-grease is meant a fat or oily discharge with the dung, and arises from a colliquation, or melting down of the fat of a horse's body by violent exercise in very hot weather. It is always attended with a fever, heat, restlessness, starting and tremblings, great inward sickness, shortness of breath, and sometimes with the symptoms of a pleurisy. His dung will be extremely greasy, and he will fall into a scouring; his blood will have a thick skin or fat over it when cold, of a white or yellow hue, but chiefly the latter; the congealed part or sediment is commonly a mixture of size and grease, which makes it so extremely slippery, that it will not adhere to the fingers, and the small portion of serum feels also slippery and clammy. The horse soon loses his flesh and fat, which probably is dissolved and absorbed into blood; and those that survive this shock, commonly grow hide-bound for a time, their legs swelling both before and behind, and continue in this state till the blood and juices are rectified; and if this is not done effectually, the farcy, or some obdinate surfeit, generally follows, very difficult to remove.

In the first place bleed plentifully, and repeat it for two or three days successively in smaller quantities; two or three rowels should also be immediately put in, and the cooling emollient glysters (p. 547. col. 1. par. 2. from the bottom) daily thrown up to abate the fever, and drain off the greasy matter from the intestines. By the mouth give plenty of warm water or gruel, with cream of tartar or nitre, to dilute and attenuate the blood, which in this case is greatly disposed to run into grumes, and endanger a total stagnation.

When the fever is quite gone off, and the horse has recovered his appetite, gentle aloetic purges should be given once a-week, for a month or six weeks, in order to bring down the swelled legs. To this end give the following, which, repeated for some time, will entirely remove this disorder.

**TAKE** of succotrine aloes six drams, of gum guaiacum powdered



powdered half an ounce, of diaphoretic antimony and powder of myrrh of each two drams; make into a ball with syrup of buckthorn.

These will seldom take a horse from his business above two or three days in a week; neither will he lose his flesh or appetite with them, but on the contrary mend in both; which cannot be obtained by any other method of purging, and gives this greatly the preference in many cases.

#### *Of SURFEITS, MANGE, and HIDE-BOUND.*

SURFEITS arise from various causes; but are commonly the effects of some diseases not attended to, or that have been ill cured.

A horse is said to be surfeited, when his coat stares, and looks rusty and dirty, though proper means has not been wanting to keep him clean. The skin is full of scales and dander, that lies thick and mealy among the hair, and is constantly supplied with a fresh succession of the same, for want of due transpiration. Some horses have hurdles of various sizes like peas or tares; some have dry fixed scabs all over their limbs and bodies; others a moisture, attended with heat and inflammation; the humours being so sharp, and violently itching, that the horses rub so incessantly, as to make themselves raw. Some have no eruptions at all, but an unwholesome look, and are dull, sluggish and lazy; some appear only lean and hide-bound: others have flying pains and lameness, resembling a rheumatism; so that in the surfeits of horses, we have almost all the different species of the scurvy and other chronic distempers.

The following method is usually attended with success in the dry species. First take away about three or four pounds of blood, and then give the following mild purge, which will work as an alterative, and should be repeated once a-week, or ten days, for some time.

**TAKE** succotrine aloes six drams or one ounce, gum guaiacum half an ounce, diaphoretic antimony and powder of myrrh of each two drams; make into a ball with syrup of buckthorn.

In the intermediate days, an ounce of the following powder should be given, morning and evening, in his feeds.

**TAKE** native cinnabar, or cinnabar of antimony, finely powdered, half a pound; crude antimony, in fine powder, four ounces; gum guaiacum, also in powder, four ounces: make into sixteen doses for eight days.

This medicine must be repeated till the horse coats well, and all the symptoms of surfeit disappear.

The wet surfeit, which is no more than a moist running scurvy, appears on different parts of the body of a horse, attended sometimes with great heat and inflammation; the neck oftentimes swells so in one night's time, that great quantities of a hot briny humour issues forth, which, if not abated, will be apt to collect on the poll or withers, and produce the poll-evil or fistula. This disease also frequently attacks the limbs, where it proves obstinate and hard to cure: and in some horses shews itself spring and fall.

In this case bleed plentifully, avoid externally all repellents, and give cooling physic twice a-week; as, four ounces of lenitive electuary, with the same quantity of cream of tartar; or the latter, with four ounces of Glauber's salts, quicked, if thought proper, with two or three drams of powder of jallap, dissolved in water-gruel, and given in a morning fasting.

After three or four of these purges two ounces of nitre made into a ball with honey may be given every morning for a fortnight; and if attended with success, repeated for a fortnight longer.

The powders above-mentioned may be also given with the horse's corn; or a strong decoction of guaiacum shavings or logwood may be given alone to the quantity of two quarts a-day. These, and indeed all alterative medicines, must be continued for a long time, where the disorder proves obstinate.

The diet should be cool and opening, as scalded bran or barley; and if the horse is hide-bound, an ounce of fenugreek seeds should be given in his feeds for a month or longer; and, as this disorder often proceeds from worms, give the mercurial physic too, and afterwards the cinnabar powders, as above directed; but as in general, it is not an original disease, but a symptom only of many, in the cure regard must be had to the first cause: thus, as it is an attendant on surfeits, fevers, worms, &c. the removal of this complaint must be variously effected.

In a mangy horse the skin is generally tawny, thick, and full of wrinkles, especially about the mane, the loins and tail; and the little hair that remains in those parts stands almost always strait out or bristly: the ears are commonly naked and without hair, the eye and eyebrows the same; and when it affects the limbs, it gives them the same aspect; yet the skin is not raw, nor peels off, as in the hot inflamed surfeit.

Where this distemper is caught by infection, if taken in time it is very easily cured: and we would recommend a sulphur ointment as most effectual for that purpose, rubbed in every day. To purify and cleanse the blood, give antimony and sulphur for some weeks after. There are a great variety of external remedies for this purpose, such as train-oil and gun-powder, tobacco steeped in chamber-lye, &c. Solleyfell recommends the following.

**TAKE** burnt alum and borax in fine powder of each two ounces. white vitriol and verdgrease powdered of each four ounces; put them into a clean pot, with two pounds of honey, stirring till they are incorporated; when cold, add two ounces of strong aqua-fortis.

But when this disorder is contracted by low feeding, and poverty of blood, the diet must be mended, and the horse properly indulged with hay and corn. The following ointments are effectually used for this disorder, rubbed into the parts affected every day.

**TAKE** powdered brimstone, train-oil, and tar, of each equal quantities; to which may be added ginger, or white hellebore.

Or,

**TAKE** sulphur vivum half a pound, crude sal armoniac one ounce, hogs lard or oil a sufficient quantity to form into an ointment.

These

These are both very powerful remedies for this disorder, and can scarce fail of success.

*Of the FARCIN or FARCY.*

THE true farcy is properly a distemper of the blood-vessels, which generally follows the tract of the veins, and, when inveterate, thickens their coats and integuments, so that they become like so many chords. We shall not describe the different sorts of farcies, seeing they are only degrees of one and the same distemper; but proceed to paint the distemper by its symptoms, which are pretty manifest to the eye.

At first, one or more small swellings, or round buds like grapes or berries, spring out over the veins, and are often exquisitely painful to the touch; in the beginning they are hard, but soon turn into soft blisters, which when broke discharge an oily or bloody ichor, and turn into very foul and ill-disposed ulcers. In some horses it appears on the head only; in some on the external jugular; in others on the plate vein, and runs downwards on the inside of the fore arm towards the knee, and very often upwards towards the brisket: in some the farcy shews itself on the hind-parts, about the pasterns, and along the large veins on the inside of the thigh, rising upwards into the groin, and towards the sheath; and sometimes the farcy makes its appearance on the flanks, and spreads by degrees towards the lower belly, where it often becomes very troublesome.

When the farcy appears on the head only, it is easily cured; especially when it is seated in the cheeks and forehead, the blood-vessels being here small: but it is more difficult when it affects the lips, the nostrils, the eyes, the kernels under the jaws, and other soft and loose parts, especially if the neck-vein becomes chorded. When it begins on the outside of the shoulder or hips, the cure is seldom difficult: but when the farcy arises on the plate-vein, and that vein swells much, and turns corded, and the glands or kernels under the arm pit are affected, it is hard to cure; but more so when the crural veins within side of the thigh are corded, and beset with buds, which affects the kernels of the groin and the cavernous body of the yard. When the farcy begins on the pasterns or lower limbs, it often becomes very uncertain, unless a timely stop is put to it; for the swelling in those dependant parts grows so excessively large in some constitutions, and the limbs so much disfigured thereby with foul sores and callous ulcerations, that such a horse is seldom fit for any thing afterwards but the meanest drudgery: but it is always a promising sign, wherever the farcy happens to be situate, if it spreads no further. It is usual to affect only one side at a time; but when it passes over to the other, it shews great malignancy: when it arises on the spines, it is then for the most part dangerous, and is always more so to horses that are fat and full of blood, than to those that are in a more moderate case. When the farcy is epidemical, as sometimes happens, it rises on several parts of the body at once, forms nasty foul ulcers, and makes a profuse running of greenish bloody matter from both nostrils; and soon ends in a miserable rot.

When the farcy makes its first appearance on the head,

it rises on the cheeks and temples, and looks like a net-work, or small creeping twigs full of berries. Sometimes it inflames the eye, and sometimes little blisters or buds run along the side of the nose. It arises often on the outside of the shoulder, running along the small veins with heat and inflammation; and sometimes a few small buds appear near the withers, and on the outside of the hip. In all these appearances, the disease being superficial, and affecting only the smaller vessels, is easily conquered by the following method, when taken in time; for the simplest farcy, if neglected, may degenerate into the worst sort.

This distemper, then, being of an inflammatory nature, and in a particular manner affecting the blood vessels, must necessarily require large bleeding, particularly where the horse happens to be fat and full of blood. This always checks the beginning of a farcy, but is of small service afterwards; and if a horse is low in flesh, the loss of too much blood sometimes proves injurious. After bleeding, let the horse have four ounces of cream of tartar and lenitive electuary; which may be given every other day for a week, to cool the blood, and open the body; and then give nitre three ounces a-day for three weeks or a month, and anoint the buds and swellings with the following ointment twice a-day.

TAKE ointment of elder four ounces, oil of turpentine two ounces, sugar of lead half an ounce, white vitriol powdered two drams; mix together in a gally-pot.

The buds sometimes by this method are dispersed, leaving only little bald spots, which the hair soon covers again. When they break and run, if the matter be thick and well digested, they will soon be well: but in order to confirm the cure, and to disperse some little lumps which often remain for some time on the skin without hair, give the liver of antimony for a month; two ounces a-day for a fortnight, and then one ounce a-day for the other fortnight: by following this method, a farcy which affects only the small vessels, may be stopped in a week or ten days, and soon after totally eradicated.

When the farcin affects the larger blood-vessels, the cure is more difficult; but let it always be attempted early: therefore on the plate, thigh, or neck veins appearing chorded, bleed immediately on the opposite side, and apply the following to the chorded vein.

TAKE oil of turpentine in a pint bottle six ounces, oil of vitriol three ounces; drop the oil of vitriol into the oil of turpentine by little at a time, otherwise the bottle will burst; when it has done smoking, drop in more oil of vitriol, and so on till all is mixed.

This mixture is one of the best universals in a beginning farcy; but where it is seated in loose fleshy parts, as flanks or belly, equal parts of the oil of vitriol and turpentine are necessary.

Rub the parts first with a woollen cloth; and then apply some of the mixture over the buds, and wherever there is any swelling, twice a day. Give the cooling physic every other day, and then three ounces of nitre every day for some time.

When the farcy begins on the flanks, or towards the lower belly, it often takes its rise from a single puncture  
of

of a sharp spur. The pain and smarting is one sure sign to distinguish the farcy from common accidents; the flaring of the hair, which stands up like a tuft all round the buds or blisters, and the matter that issues from the buds, which is always purulent and of a clammy greasy consistence, are other certain signs. After bathing with the mixture above mentioned till the ulcers are smooth and healing, should the swelling not subside, to prevent the spreading of the buds, and to disperse them, bathe with either of these mixtures as far as the centre of the belly; and at the same time give a course of antimonials, as will presently be prescribed.

**TAKE** spirits of wine four ounces, oil of vitriol and turpentine, of each two ounces, white-wine vinegar, or verjuice, six ounces.

Or the following:

**TAKE** spirits of wine rectified four ounces, camphor half an ounce, vinegar or verjuice six ounces, white vitriol, dissolved in four ounces of spring water, one ounce; mix together.

In the lower limbs the farcy lies sometimes concealed for a great while, and makes so slow a progress, that it is often mistaken for grease, or for a blow or kick, and goes by the general appellation of a humour settled there. In order to distinguish the one from the other, we shall observe that a kick, or bruise, is generally attended with a sudden swelling, or a contused wound, which for the most part digests easily: the grease is also a smooth swelling that breaks out above the bending of the pastern backwards; but the farcy begins on the pastern joint usually with one bud, and runs upwards like a knotty crab-tree.

Very simple means have sometimes stopped it, before it has begun to spread; a poultice with bran and verjuice bound round the part, and renewed once a-day, will often alone succeed; and if proud flesh should arise, touch it with oil of vitriol, or aqua fortis, an hour before you apply the poultice; for when the distemper is local, as we suppose it here, it is to be conquered by outward applications.

When the distemper grows inveterate, and resists the above method, and the vessels continue chorded, Gibson recommends the following mixture.

**TAKE** linseed oil half a pint; oil of turpentine and salt-petre, of each three ounces; tincture of euphorbium and hellebore, of each two drams; the soldiers ointment two ounces; or oil of bays, or oil of origanum, half an ounce; double aqua fortis half an ounce: after the ebullition is over, add two ounces of Barbadoes tar.

Rub this into the chorded veins, and where-ever there is a swelling, once in two or three days; but if the orifices are choked up with proud flesh, or the skin so much thickened over the ulcers as to confine the matter, in either case it is necessary to make an open passage with a small hot iron, and destroy the proud flesh, after which it may be kept down by touching with oil of vitriol, aqua fortis, or butter of antimony. A salve may also be prepared with quicksilver and aqua fortis, rubbing any quantity of the former with enough of the latter, to the consistence of a liniment; smear the ulcers with this when-

ever they appear foul, and you will find it preferable to most other curing medicines.

Our farriers, after opening the buds, put in usually a small quantity of corrosive sublimate or arsenic, which they call coring out the farcy; this may answer where the buds are few, and not situated near large blood-vessels, joints, or tendons: others use Roman vitriol, or sublimate and vitriol, in equal quantities: but let it be remembered, that many a horse has been poisoned by these medicines ignorantly used, and in too large quantities.

The following balls are proper in every state of the farcy; and when the distemper has been in its infancy, before the skin was much defaced, has often cured it in a week or two, by giving them only once or twice a-day: but in an old farcy they should be given for two or three months together.

**TAKE** of native cinnabar, or cinnabar of antimony, eight ounces; long birthwort and gum guaiacum powdered, of each four ounces: make into a paste with honey, and form into balls of the size of a large walnut, and roll them into liquorice powder.

The tediousness of this course has encouraged the giving of mercurials; and indeed where they are directed with skill, they must be attended with success: the stronger preparations, as the red and white precipitates, and turbit, being combined with sharp saline parts, may be hazardous and injurious; but the latter given in small quantities have been found very successful in such kind of inveterate disorders. Mr Gibson says, he has given it to a dram at a doze, where the limbs have been greatly swelled; that in forty-eight hours the sores were all dried up, and the limbs reduced; but that it made the horse so violently sick for several days, and scoured him to such a degree, that it could not be repeated.

One would have thought that the success attending this medicine so suddenly, might have encouraged Gibson to have made further trials in smaller quantities; which had he done, it is more than probable he would not have been disappointed: for the grand secret in giving mercurials as alteratives, is the introducing them into the blood, without operating on the stomach and bowels; and to do this effectually, they must be given in small quantities, and so bridled as to controul their force on the first passages; taken in this manner, they will mix gradually with the blood and juices, and operate both effectually and safely.

Dr Bracken recommends the knots and chords to be rubbed with the mercurial ointment before they break, in order to disperse them; and after breaking, to dress the sores with equal parts of Venice turpentine and quicksilver: if by these means the mouth should become sore, treat as above.—This method seems to be effectual with proper care.

The following is also recommended by the same gentleman:

**TAKE** butter of antimony and bezoar mineral, of each one ounce; beat up with half a pound of cordial ball, and give the bigness of a walnut, or three quarters of an ounce, every day for two or three weeks, falling two or three hours after it.

We shall here take notice of what is called the water-farcy, which has no resemblance to a true farcy, either in its cause, symptoms, or effects, but has only obtained this name through custom and ignorance.

This water farcy then is of two kinds; one the product of a feverish disposition, terminating on the skin, as often happens in epidemical colds; the other is dropical, where the water is not confined to the belly and limbs, but shews itself in several parts of the body by soft swellings yielding to the pressure of the finger. This last kind usually proceeds from foul feeding, or from the latter grass and fog, that often comes up in great plenty with continued cold rains, and breeds a sluggish viscid blood. In the former case, we have seen the limbs and whole body enormously swelled, and very hard, the belly and sheath greatly distended; which were as surprisngly reduced in four and twenty hours, by slight scarifications within side the leg and thigh, with a sharp penknife, and three or four strokes on the skin of the belly on each side the sheath; from these scarifications there was a constant and surprisng large dripping of water, which soon relieved the horse; when a few purges completed his recovery.

In the other species of dropsy the curative intentions are to discharge the water, recover the crasis or strength of the blood, and brace up the relaxed fibres throughout the whole body. To this end, purge once a-week or ten days; and give intermediately either of the following.

**TAKE** black hellebore fresh gathered, two pounds; wash, bruise, and boil in six quarts of water, to four; and then strain out the liquor, and put two quarts of white-wine on the remaining hellebore, and let it infuse warm forty-eight hours; then strain off, mix both together, and give the horse a pint night and morning.

**TAKE** nitre two ounces, squills powdered three drams or half an ounce, camphor one dram, honey enough to form into a ball, to be given once a-day alone, or washed down with a horn or two of the above drink.

Before we close this section, it is proper to lay down the symptoms of an incurable farcy, that the owners of such horses may save themselves unnecessary expense and trouble in their endeavours to obtain a cure.

When a farcy, by improper applications, or by neglect, has spread and increased, or after long continuance resisted the medicines above recommended; if fresh buds are continually sprouting forth, while the old ones remain foul and ill conditioned; if they rise on the spines of the back and loins; if the horse grows hide bound, and runs at the nose; if abscesses are formed in the fleshy parts between the interstices of the large muscles; if his eyes look dead and lifeless; if he forsakes his food, and scours often, and his excrements appear thin and of a blackish colour; if the plate or thigh vein continues large and chorded after siring, and other proper applications: these symptoms denote the distemper to have penetrated internally, and that it will degenerate into an incurable consumption: it is most probable also, that the whole mass of fluids are tainted, and become irremediable by art.

#### Of ALTERATIVE MEDICINES.

By alteratives, or altering medicines, are to be understood such as, having no immediate sensible operation, gradually gain upon the constitution, by changing the humours or juices from a state of distemperature to health. This intention in some cases may perhaps be effected by correcting the acrimony of the juices, and accelerating the blood's motion; and in others by attenuating, or breaking its particles, and dividing those cohesions which obstruct the capillaries or finer vessels; and so promote the due secretions of the various fluids. It is certain, that many have but an indifferent opinion of a medicine that does not operate externally, and gratify their senses with a quantity of imaged humours ejected from the body: but let such people remember, that there are good humours as well as bad, which are thrown off together; that no evacuating medicine has a power of selecting, or separating the bad from the good; and consequently that they are thrown out only in a proportionate quantity. These few hints may be sufficient to convince the judicious reader of the great advantages arising from alteratives, and the preference due to them in most cases over purgatives; unless it could be proved, as already mentioned, that the latter could cull out and separate from the blood the bad humours solely, leaving the good behind; but this selective power has long been justly exploded as ridiculous and uncertain, since it is plain, that all kinds of purging medicines differ only in degree of strength, and operate no otherwise upon different humours than as they stimulate more or less.

We shall therefore take this opportunity of recommending some alterative medicines, which are not so generally known as they ought to be; and that too on the surest grounds, a proper experience of their good effects in repeated trials. The first then is nitre or purified saltpetre, which has long been in great esteem, and perhaps is more to be depended on in all inflammatory fevers than any other medicine whatever: but besides this extensive power of allaying inflammatory disorders, it is now offered as a remedy, taken in proper quantities, as an alterative for surfeits, molten-grease, hide-bound, grease-heels, &c. And as it has been known to succeed even in the cure of the farcy, what other distempers in horses, arising from vitiated fluids, may it not be tried on, with a strong probability of success? This great advantage will arise from the use of this medicine over most others, that, as its operation is chiefly by urine, it requires no confinement or cloathing; but the horse may be worked moderately throughout the whole course. This medicine has been found equally efficacious (by many trials made in one of our hospitals) in correcting the acrimony of the juices, and disposing the most obstinate and inveterate sores to heal up, and hence probably it came recommended as an alterative to our horses.

The quantity of nitre given at a time should be from two to three ounces a-day; let it be finely powdered, and then mix with it by little at a time as much honey as will

will form it into a ball; give it every morning fasting for a month; or it may be given at first for a fortnight only, intermitting a fortnight, and then repeat it. If it be observed that the horse shews an uneasiness at the stomach after taking it, a horn or two of any liquor should be given after it, or it may be dissolved at first in his water, or mixed with his corn; though the ball, where it agrees, is the easiest method of giving.

When horses take drinks with great reluctance, powders must be given in their feeds; thus crude antimony, or liver of antimony finely powdered, may be given to the quantity of half an ounce, night and morning; but in all surfeits, gum guaiacum mixed with antimony is found more efficacious. Thus,

TAKE of crude antimony finely powdered, or, where it can be afforded, cinnabar of antimony, and gum guaiacum, of each a pound: mix together with an oily pistle to prevent the gum's caking: divide the whole into thirty-two dozes, *viz.* an ounce each doze; let one be given every day in the evening feed.

Or,

TAKE of cinnabar of antimony, gum guaiacum, and Castile or Venice soap, of each half a pound, salt of tartar four ounces; beat them up into a mass, and give an ounce every day. To these may be added very advantageously, an ounce and an half of camphor.

*Æthiops mineral* given to the quantity of half an ounce a-day, is a very good sweetener and corrector of the blood and juices; but it has been observed, after having been taken a week or ten days, to make some horses flabby, and unable to chew their hay and oats; and the same symptoms have arose, where only two drams of crude mercury has been given, and continued about the same space of time.

*Diet Drinks.*—1. A decoction of logwood, prepared like that of guaiacum, is also successfully given in surfeits.

2. Lime-water, prepared with shavings of sassaparilla and liquorice, is a good diet-drink, to sweeten and correct a horse's blood; and may be given with the nitre balls for that purpose.

3. Tar-water also, as has before been hinted, may in many cases be well worth trial: but let it be remembered, that all medicines of this kind should be continued a considerable time in obstinate cases.

#### Of ROWELLING.

THERE seems to be no remedy so much made use of, and so little understood by farriers in general, as rowels; for which reason we shall endeavour to set the whole affair in a clearer light, than hitherto it has appeared in.

We shall begin then by describing rowelling, which is an artificial vent made between the skin and flesh, in order to unload and empty the vessels in general, and thereby relieve particular parts, when too much oppressed by a fulness or redundancy.

The general and absurd reasoning of farriers on the effects and use of rowelling, in some measure makes this section the more necessary, as it is too notorious how

impertinently they talk on this subject: for in short, with them, a rowel is to draw off all the bad and corrupt humours from the blood by a sort of magic.

It is necessary to observe, that the matter generally discharged by a rowel, is nothing more than an ouzing from the extremities of the vessels divided in the making of it; in fact then, it is blood, which loses its colour, by being shed out of the vessels, the warmth of the part, and its confinement.

If this is granted, it will evidently appear, that the good effects ensuing this operation, must be owing to a gradual depletion or emptying of the vessels in general; by which means the surcharge or load on a particular part, is taken off and removed, and impurities or bad juices (generally called humours) run off with the good in proportion to their quantity in the blood.

Thus, to lean hide-bound horses, and those of a dry hot constitution, the discharge, by depriving the constitution of so much blood and fluids, is daily exhausting the strength of the animal; and may be productive of bad consequences, by defrauding the constitution of a necessary fluid.

But in disorders from fulness, attended with acrimony, or sharpness of the juices, and with desfluxions on the eyes, lungs, or any part of consequence; the gradual discharge, brought on by these means, will contribute to lessen the fulness on the parts affected, and give the vessels an opportunity of recovering their tone, while evacuating and alterative medicines are doing their office.

It may be necessary, however, to observe, that there is a wonderful communication between the vessels of the cellular membrane under the skin, which remarkably appears, by inflating those of sheep, calves, &c. by the butchers; hence probably it is that some disorders of this integument, are so apparently relieved by issues, or rowels, without our having any recourse to that general depletion of the vessels, we have just observed, to account for it; and hence also may be deduced their utility, sometimes in draining off any extravasated fluids, which may lodge between the interstices of the muscles, after violent strains of the shoulder; also in discharging such vitious or sharp fluids as are thrown on the membranes, and occasion those flying pains and lamenesses, which we find are often removed by this local remedy.

#### Of STRAINS in VARIOUS PARTS.

IT is necessary to observe, that in all strains, the muscular or tendinous fibres are overstretched; and sometimes ruptured, or broke. To form therefore a true idea of these disorders, let us first consider every muscle and tendon as composed of springy elastic fibres, which have a proper power of their own to contract and extend themselves; or, to make their action more familiar, let us compare them to a piece of catgut, that we may the better judge with what propriety oily medicines are directed for their cure. Thus then, if by a violent extension of this catgut, you had so overstretched it as to destroy its springiness or elasticity, and was inclined to recover its lost tone; would you for that purpose think of soaking it in oil? And is not the method of treating strains, or over-

stretched muscles and tendons, full as preposterous, when you bathe or soak them in oily medicines, at a time that they want restringents to brace them up? Yet custom has so established this practice, and fallacious experience seemingly so confirmed it, that it would be a difficult task to convince the illiterate and prejudiced of the absurdity, who, by attributing effects to wrong causes, are led into this error, and the oils usurp the reputation that is due only to rest and quiet: they seem, however, to be aware of the ill consequences, by their adding the hot oils, as spike, turpentine, and origanum; which, though they in some measure guard against the too suppling quality of the other oils, yet the treatment is still too relaxing to be of real service.

And indeed, in all *violent* strains of either tendons or muscles, whatever opinion we may entertain of bathing and anointing with favourite nostrums, which often succeed in slight cases, where perhaps bandage alone would have done; yet it is the latter, with proper resting the relaxed fibres, till they have thoroughly recovered their tone, that are the chief things to be depended on; and frequently some months are necessary for effecting the cure.

All violent strains of the ligaments, which connect the bones together, especially those of the thigh, require time, and turning out to grass, to a perfect recovery. External applications can avail but little here, the parts affected lying too deep, and so surrounded with muscles that medicine cannot penetrate to them. The sooner, in these cases, a horse is turned out to grass, the better; as the gentle motion in the field will prevent the ligaments and joint oil from thickening, and of course the joint itself from growing stiff.

When a horse's shoulder is overstrained, he does not put out that leg as the other; but to prevent pain, sets the sound foot hardily on the ground to save the other; even though he be turned short on the lame side, which motion tries him the most of any. When trotted in hand, instead of putting his leg forward in a right line, he forms a circle with the lame leg; and when he stands in the stable, that leg is advanced before the other.

In order to cure this lameness, first bleed him, and let the whole shoulder be well bathed three times a day with hot verjuice or vinegar, in which may be dissolved a piece of soap; but if the lameness continues without swelling, or inflammation, after resting two or three days, let the muscles be well rubbed for a considerable time, to make them penetrate, with good opodeldoch, or either of the following mixtures:

TAKE camphorated spirit of wine, two ounces; oil of turpentine, one ounce; this proportion will prevent the hair coming off.

Or,

TAKE the best vinegar, half a pint; spirit of vitriol, and camphorated spirit of wine, of each two ounces.

When the shoulder is very much swelled, it should be fomented with woollen cloths (large enough to cover the whole) wrung out of hot verjuice and spirit of wine; or a fomentation prepared with a strong decoction of wormwood, bay-leaves, and rosemary, to a quart of which may be added half a pint of spirit of wine.

A rowel in the point of the shoulder in this case often

does great service; especially if the strain has been very violent, and the swelling very large: but as to boring up the shoulder with a hot iron, and afterwards inflating it, is both a cruel and absurd treatment; and the pegging up the sound foot, or setting on a patten-shoe, to bring the lame shoulder on a stretch, is a most preposterous practice, and directly calculated to render a horse incurably lame; for it can only be necessary in cases the very opposite to this, where the muscles have been long contracted, and we want to stretch them out.

Where poultices can be applied, they are at first undoubtedly very effectual, after bathing with hot vinegar or verjuice, and are to be preferred greatly to cold charges, which, by drying so soon on the part, keep it stiff and uneasy: let them be prepared with oat-meal, rye-flour, or bran boiled up in vinegar, strong beer or red-wine lees, with lard enough to prevent their growing stiff; and when by these means the inflammation and swelling is brought down, bathe the part twice a-day with either of the above mixtures, opodeldoch, or camphorated spirit of wine; and roll the part three or four inches, both above and below, with a strong linen roller, of about two fingers width; which contributes not a little to the recovery, by bracing up the relaxed tendon; and perhaps is more to be depended on than the applications themselves.

In strains of the *coffin joint*, that have not been discovered in time, there will grow such a stiffness in the joint, that the horse will only touch the ground with his toe; and the joint cannot be played with the hand; the only method here is repeated blistering, and then firing superficially.

Strains of the *back sinews* are very common, and are easily discovered by the swelling, which extends sometimes from the back-side of the knee down to the heel, but for the most part the horse sets that leg before the other. The tendon should be well bathed three or four times a-day with hot vinegar; and if much swelled, apply the poultices above recommended; and when the swelling is down, bathe with the mixtures above, or with camphorated spirit of wine and oil of amber, in which is dissolved as much camphor as the spirits will take up, and roll up the tendon with a proper bandage, or laced stocking; which last, properly fitted to the limb, might be wore to great advantage, not only in these sort of injuries, but in most others, where there is a disposition to the grease, or other swellings of the limbs, from weak and relaxed fibres. Curriers shavings wetted with vinegar have been found useful for this purpose; as has also tar and spirit of wine: but where the tendons have suffered by repeated injuries of this kind, the case will demand blistering, firing, and proper rest.

Strains of the *knees* and *pasterns* arise frequently from kicks or blows; if they are much swelled, apply first the poultices; and when the swelling is abated, bathe with the above, or the following.

TAKE vinegar, one pint; camphorated spirits of wine, four ounces; white vitriol, dissolved in a little water, two drams.

Or,

TAKE the white of three or four eggs, beat them into a froth with a spoon; to which add an ounce of rock

rock allum, finely powdered; spirit of turpentine, and wine, of each half an ounce; mix them well together.

As great weakness remains in the pasterns after violent strains, the best method is to turn the horse out to grass till he is perfectly recovered; when this cannot be complied with, the general way is to blister and fire.

When a horse is lame in the *stifle*, he generally treads on his toe, and cannot set the heel to the ground. Treat him at first with the vinegar and cooling retringents; but if a large swelling, with puffiness, ensues, foment it well with the discutient fomentation till it disperses; and then bathe the part with any of the above medicines.

A lameness in the *wrist-bone* and hip, is discovered by the horse's dragging his leg after him, and dropping backward on his heel when he trots. If the muscles of the hip are only injured, this kind of lameness is cured easily; but when the ligaments of the joint are affected, the cure is often very difficult, tedious, and uncertain. In either case, at first bathe the parts well with the cooling medicines, four or five times a-day; in the muscular strain, this method alone may succeed; but in the ligamentous, it is rest and time only can restore the injured parts to their proper tone.

Strains in the *hock* are to be treated by soaking the parts with coolers and repellers; but when the ligaments are hurt, and they are attended with great weakness and pain, use the fomentation. If a hardness should remain on the outside, it may be removed by repeated blistering; if within, it may be out of the power of any external applications to remove; however, the joint should be fired gently with small razes or lines pretty close together, and then covered with a mercurial plaster. To the discutient fomentation above mentioned may be added crude sal armoniac, with a handful of wood-ashes boiled in it.

The blistering ointment for the above purposes may be found in the Section of Bone-spavin; but the sublimate should be omitted.

The *string*, used for the strengthening relaxed sinews or tendons, should act only on the skin, which, by contracting and hardening it all round the sinews, compresses them more firmly like a bandage. The bow-men of old submitted to this operation, in order to give strength to the muscles and tendons of their arms. A proper degree of skill is very requisite to perform it effectually on a horse; for a due medium should be observed, and the instrument neither so slightly applied, as to scarify the skin only superficially, nor so deep as to wound or cauterize the sinew or its sheath. The lines should be drawn pretty close together, on each side of the joint or sinew, following the course of the hair; no cross lines should be made, as they but disfigure the horse afterwards, without any real use. The firing instrument, or knife, ought to be a little rounded on the edge, gradually thickening to the back, that it may retain the heat for some time, but should not be applied till the flaming redness is partly gone off. The cauterized parts may be bathed with spirit of wine at first, and anointed afterwards with bees-wax and oil, which alone is sufficient to complete the cure.

### OF TUMOURS and IMPOSTHUMES.

TUMOURS, or swellings, arise either from external injuries, or internal causes.

Swellings, caused by external accidents, as blows and bruises, should at first be treated with retringents; thus, let the part be bathed frequently with hot vinegar or verjuice, and, where it will admit of bandage, let a flannel wetted with the same be rolled on: if by this method the swelling does not subside, apply, especially on the legs, a poultice with red-wine lees, strong-beer grounds, and oatmeal, or with vinegar, oil, and oatmeal; either of these may be continued twice a-day, after bathing, till the swelling abates: when, in order to disperse it entirely, the vinegar should be changed for camphorated spirit of wine, to four ounces of which may be added one of spirit of sal armoniac; or it may be bathed with a mixture of two ounces of crude sal armoniac boiled in a quart of chamber-lye, twice a day, and rags dipped in the same may be rolled on.

Fomentation made by boiling worm-wood, bay-leaves, and rosemary, and adding a proper quantity of spirits, are often of great service to thin the juices, and fit them for transpiration; especially if the injury has affected the joints.

But in bruises, where the extravasated blood will not by these means be dispersed, the shortest way is to open the skin, and let out the grumes.

Critical tumours, or swellings, which terminate fevers, should by no means be dispersed; except when they fall on the pastern or coffin joint, so as to endanger them: in this case the discutient fomentation, (p. 568. col. 1. bottom) should be applied three or four times a-day, and a cloth or flannel frequently wrung out of the same should be bound on, in order to keep the joint continually breathing.

But if the swelling fixes under the jaws, behind the ears, on the poll, withers, or in the groins and sheath, &c. it should be encouraged and forwarded by ripening poultices where-ever they can be applied; oatmeal boiled soft in milk, to which a proper quantity of oil and lard is added, may answer this purpose; or the poultice recommended in the Section of Strangles: these must be applied twice a-day, till the matter is perceived to fluctuate under the fingers, when it ought to be let out; for which purpose, let the tumour be opened with a knife or strong lancet, the whole length of the swelling, if it can be done safely; for nothing contributes so much to a kind healing, as the matter's having a free discharge, and the openings being big enough to dress to the bottom.

Pledgets of tow, spread with black or yellow basilicon (or the wound ointment) and dipped in the same, melted down with a fifth part of oil of turpentine, should be applied to the bottom of the sore, and filled up lightly with the same, without cramming; it may be thus dressed once or twice a-day, if the discharge is great, till a proper digestion is procured, when it should be changed for pledgets spread with the red precipitate ointment, applied in the same manner.

Should the sore not digest kindly, but run a thin water and look pale, foment, as often as you dress, with the above fomentation; and apply over your dressing the strong-beer poultice, and continue this method till the matter grows thick, and the sore florid.

The following ointments will generally answer your expectations in all common cases, and may be prepared without, as well as with, the verdegrease.

**TAKE** Venice turpentine and bees-wax of each a pound, oil of olives one pound and a half, yellow rosin twelve ounces; when melted together, two or three ounces of verdegrease, finely powdered, may be stirred in, and kept so till cold, to prevent its subsiding.

**TAKE** of yellow basilicon, or the above ointment, without verdegrease, four ounces; red precipitate, finely powdered, half an ounce: mix them together cold with a knife or spatula.

This last, applied early, will prevent a fungus, or proud flesh, from shooting out; for if you dress too long with the above digestive, the fungus will rise fast, and give some trouble to suppress it; when it will be necessary to wash the sore as often as you dress, with a solution of blue vitriol in water, or to sprinkle it with burnt alum and precipitate. If these should not be powerful enough, touch with a caustic, or wash with the sublimate water, made by dissolving half an ounce of corrosive sublimate in a pint of lime-water.

But this trouble may in a great measure be prevented, if the sore is on a part where bandages can be applied with compresses of linen cloth: for even when these excrescences regerminate, as it were under the knife, and spring up in spite of the caustics above mentioned, they are to be subdued by moderate compression made on the sprouting fibres, by these means.

Authors on farriery have given in general very proper receipts to answer every intention of this kind by medicines; but as they have not laid down sufficient rules for their application in those cases where they are most wanted, the following general directions will not be unacceptable; as the difficulty in healing some kinds of sores arises frequently from the unskilful manner of dressing them.

It may be necessary then to observe here, once for all, that the cures of most sores are affected by the simplest methods, and that it is often of much more consequence to know how to dress a sore, than what to dress it with; and in this consists indeed the chief art of this branch of surgery; for the most eminent in that profession have long since discovered, that variety of ointments and salves are unnecessary in the cure of most wounds and sores, and they have accordingly discarded the greatest part, formerly in repute for that purpose; repeated observations having taught them, that after the digestion, nature is generally disposed to heal up the wound fast enough herself, and that the surgeon's chief care is to prevent a luxuriance, commonly called proud flesh; which all ointments, wherein lard or oil enters, are but too prone to encourage, as they keep the fibres too lax and supple; and which dry lint alone, early applied, as easily prevents, by its absorbing quality, and light compression on the sprouting fibres.

Thus, if a hollow wound or sore is crammed with tents, or the dressings are applied too hard, the tender shoots of flesh from the bottom are prevented pushing up; and the sides of the sore in time from this distension may grow horny, and turn fistulous; nor has the matter by this method a free discharge.

On the other hand, if sores of any depth are dressed superficially, the external parts being more disposed to heal and come together than the internal, they will fall into contact, or heal too soon; and the sore, not filling up properly from the bottom, will break out afresh.

Hence we may justly conceive how little stress is to be laid on famous ointments, or family salves, unskilfully applied; for unless this due medium is observed, or obtained in the dressing, no hollow sore can heal up properly.

As soon then as a good digestion is procured (which is known by the thickness and whiteness of the matter discharged, and the florid red colour at the bottom of the sore) let the dressings be changed for the precipitate medicine; or the sore may be filled up with dry lint alone, or dipped in lime-water with a little honey and tincture of myrrh, or brandy, about a fifth part of the latter to one of the former; a pledget of lint dipped in this mixture should also be applied to the bottom of the sore, which should be filled up with others to the surface or edges, but not crammed in too hard, as before observed, nor yet applied too loosely.

By this method, the sore would incarn, or heal up properly, and soft spongy flesh would be prevented, or suppressed in time; whereas when ointments or salves are too long continued, a fungus, or proud flesh, is thereby so encouraged in its growth, that it requires some time to destroy and eat it down again: a proper compress of cloth, and a linen roller, is absolutely necessary both for this purpose, and to secure on the dressings, where ever they can conveniently be applied.

#### *Of Wounds in General.*

In all fresh wounds made by cutting instruments, there is nothing more required than bringing the lips of the wound into contact by suture or bandage, provided the part will allow of it; for on wounds of the hips, or other prominent parts, and across some of the large muscles, the stitches are apt to burst on the horse's lying down and rising up in the stall; in such cases the lips should not be brought close together: one stitch is sufficient for a wound two inches long; but in large wounds, they should be at an inch or more distance; and if the wound is deep in the muscles, care should be taken to pass the needles proportionably deep, otherwise the wound will not unite properly from the bottom.

Should the wound bleed much from an artery divided, the first step should be to secure it, by passing a crooked needle underneath, and tying it up with a waxed thread: if the artery cannot be got at this way, apply a button of lint or tow to the mouth of the bleeding vessel, dipped in a strong solution of blue vitriol, styptic water, oil of vitriol, or hot oil of turpentine, powdered vitriol, or colcothar, &c. and remember always to apply it close to the mouth of the bleeding vessels,



vessels, and take care that it is kept there by proper compress and bandage, till an eschar is formed; otherwise it will elude your expectations, and frequently alarm you with fresh bleedings.

In a memoir presented to the Royal Academy of Sciences by M. La Fosse, he gives an account of the success he had met with in stopping the bleedings of very considerable arteries in horses, by the application of the powder of puff balls, the arteries cicatrizing by this means only, without any succeeding hæmorrhage. This Lycoperdon, or puff-ball, was made use of for this purpose in human subjects, about 160 years ago, by Felix Wurtz, a famous old surgeon in Germany; but he does not seem to have a thought of trusting to it in such considerable arteries as M. La Fosse mentions, viz. those of the leg and thigh, the bleedings from which divided vessels he stopt in a few minutes by the use of this powder only. The agaric of the oak may also be used for this purpose, where it can be retained by a proper bandage.

These applications, as indeed all styptics, seem to act by constringing the extremity of the vessel, or choking it up, till a grume of blood is formed internally, which plugs up the orifice; and has been found to adhere to it so, as to constitute one body with the vessel.

We avoid setting down any famous receipts for fresh wounds, whether ointments, or Fryar's balsams, being well assured, that in a healthy sound constitution, nature furnishes the best balsam, and performs herself the cure, which is so often attributed to the medicine; when it is otherwise, and the blood is deprived of its balsamic state, as will appear from the aspect of the wound, and its manner of healing, it must be rectified by proper internal medicines, before a good foundation for healing can be laid by any external applications whatever.

The lips of the wound when being brought together by the needle or bandage, it needs only to be covered with rags dipped in brandy, or a pledget of tow spread with the wound ointment, (see p. 570. col. 1. par. 3.) the directions in the preceding sections being observed, and the wounded part kept as much as possible from motion.

Punctured wounds from thorns, or any other accidents, should be treated in the same manner; applying the beer, or bread and milk poultice over the dressing, till some signs of digestion appear; and fomenting the part well every day. This method is also very successfully used to those swellings, which often arise on the neck from bleeding, the sores being sprinkled with precipitate, and burnt alum powdered, to fetch out the core, or fungus, which chokes up the orifice. The usual method is to introduce a piece of vitriol, or sublimate, which often brings on a plentiful discharge, fetches out the core, and makes a cure; but it is often with the loss of the vein, and it sometimes leaves a large swelling and imposthumation.

In gun-shot wounds, when the ball has not penetrated too deep, it should be extracted, if it can be fetched away without disturbance, together with any extraneous bodies that might pass in with it; the wound should be dressed with the old digestive of Venice or common turpentine, divided with the yolks of eggs, to which may be added some honey and tincture of myrrh. The entrance of these wounds frequently requires to be enlarged, and

a depending orifice should always be procured if possible; and if the wound should not digest kindly, apply the beer poultice, and foment with the discutient fomentation, p. 569. col. 2. par. 3.

In scalds, or burns from gun-powder, or any other cause, when the skin remains entire, bathe the part well, and keep it soaked with rags dipped in spirit of wine camphorated: salt bound thick on the part has been found very effectual for this purpose: and indeed all saline and spirituous applications excel others, while the skin is yet unbroke; but when the skin is separated, anoint the part, and keep it constantly supple with linseed or salad oil, and a plaister spread with bees-wax and oil; if the skin is so scorched, that sloughs must be digested out, dress with the wound-ointment and oil of turpentine, and finish the cure with any drying ointment. Should the horse be feverish from the pain, bleed him, give cooling glysters, and treat him as we have directed in simple fevers.

#### *Of Ulcers in General.*

We shall not here enter into a description of each particular species of ulcers, but only lay down some directions for their general treatment; by which means we shall avoid the usual proximity of authors on this subject, and yet give so general an idea of the nature of ulcers, as we hope will be sufficiently instructive both of the application and of the proper remedy to each.

It may be necessary to observe, that we may often in vain pursue the best methods of cure by external applications, unless we have recourse to proper internal remedies; for as all ulcers, difficult to heal, proceed from a particular indisposition of the blood and juices, before the former can be brought into any order, the latter must be corrected by alteratives and sweetening medicines.

The first intention in the cure of ulcers is bringing them to digest, or discharge a thick matter; which will, in general, be effected by the green ointment, or that with precipitate; but should the sore not digest kindly by these means, but discharge a gleety thin matter, and look pale, you must then have recourse to warmer dressings, such as balsam, or oil of turpentine, melted down with your common digestive, and the strong beer poultice over them; it is proper also in these kind of sores where the circulation is languid, and the natural heat abated, to warm the part, and quicken the motion of the blood, by fomenting it well at the time of dressing; which method will thicken the matter, and rouse the native heat of the part, and then the former dressings may be re applied.

If the lips of the ulcer grow hard or callous, they must be pared down with a knife, and afterwards rubbed with the caustic.

Where soft fungous flesh begins to rise, it should carefully be suppressed in time, otherwise the cure will go on but slowly; if it has already sprouted above the surface, pare it down with a knife, and rub the remainder with a bit of caustic; and, to prevent its rising again, sprinkle the sore with equal parts of burnt alum, and red precipitate; or wash with the sublimate water, and dress with dry lint even to the surface, and then roll over a compress of linen as tight as can be borne; for a proper degree of pressure,

pressure, with mild applications, will always oblige these spongy excrescences to subside, but without bandage the strongest will not so well succeed.

All sinuses, or cavities, should be laid open as soon as discovered, after bandages have been ineffectually tried; but where the cavity penetrates deep into the muscles, and a counter opening is impracticable or hazardous; where, by a continuance, the integuments of the muscles are constantly dripping and melting down; in these cases injections may be used, and will frequently be attended with success. A decoction of colcothar boiled in forge-water; or solution of lapis medicamentosus in lime-water, with a fifth part of honey and tincture of myrrh, may be first tried, injected, three or four ounces twice a day; or some resin melted down with oil of turpentine, may be used for this purpose: if these should not succeed, the following, which is of a sharp and caustic nature, is recommended on Mr Gibson's experience.

TAKE of Roman vitriol half an ounce; dissolve in a pint of water. then decant and pour off gently into a large quart-bottle: add half a pint of camphorated spirit of wine, the same quantity of the best vinegar, and two ounces of *Egyptiacum*.

This mixture is also very successfully applied to ulcerated greasy heels, which it will both cleanse and dry up.

These sinuses, or cavities, frequently degenerate into *fistule*, that is, grow pipey, having the inside thickened, and lined, as it were, with a horny callous substance. In order to their cure, they must be laid open, and the hard substance all cut away; where this is impracticable, scarify them well, and trust to the precipitate medicine made strong, rubbing now and then with caustic, butter of antimony, or equal parts of quicksilver and aquafortis.

When a rotten or foul bone is an attendant on an ulcer, the flesh is generally loose and slabby, the discharge oily, thin, and stinking, and the bone discovered to be carious, by its feeling rough to the probe passed through the flesh for that purpose. In order to a cure, the bone must be laid bare, that the rotten part of it be removed; for which purpose, destroy the loose flesh, and dress with dry lint; or the drossils may be pressed out of tincture of myrrh or euphorbium: the throwing off the scale is generally a work of nature, which is effected in more or less time, and in proportion to the depth the bone is affected; though burning the foul bone is thought by some to hasten its separation.

Where the cure does not properly succeed, mercurial physic should be given, and repeated at proper intervals: and to correct and mend the blood and juices, the antimonial and alterative powders, with a decoction of guaiacum and lime-waters, are proper for that purpose.

#### Of a BONE-SPAVIN.

WITHOUT entering at all into the cause of this disorder, which is a bony excrescence, or hard swelling, growing on the inside of the hock of a horse's leg, we shall content ourselves with describing the different kinds thereof, by their symptoms; and then enter on their cure.

A spavin, that begins on the lower part of the hock,

is not so dangerous as that which puts out higher, between the two round processes of the leg bone; and a spavin near the edge is not so bad as that which is more inward toward the middle, as it does not so much affect the bending of the hock.

A spavin, that comes by a kick or blow, is at first no true spavin, but a bruise on the bone, or membrane which covers it; therefore not of that consequence, as when it proceeds from a natural cause: and those that put out on colts, and young horses, are not so bad as those that happen to horses in their full strength and maturity; but in very old horses they are generally incurable.

The usual method of treating this disorder is by blisters and firing, without any regard to the situation, or cause whence it proceeds. Thus, if a fulness on the fore-part of the hock comes upon hard riding, or any other violence, which threatens a spavin; in that case, such coolers and repellers are proper, as are recommended in strains and bruises. Those happening to colts and young horses are generally superficial, and require only the milder applications; for it is better to wear them down by degrees, than to remove them at once by severe means.

Various are the prescriptions for the blistering ointment; but the following, on proper experience, stands well recommended by Mr Gibson.

TAKE nerve and marsh mallow ointment, of each two ounces; quicksilver, one ounce, thoroughly broke with an ounce of Venice turpentine: Spanish flies powdered, a dram and a half; sublimate, one dram; oil of origanum, two drams.

The hair is to be cut as close as possible, and then the ointment applied pretty thick over the part; this should be done in the morning, and the horse kept tied up all day without any litter till night; when he may be untied, in order to lie down; and a pitch or any sticking plaister may be laid over it, and bound on with a broad tape or bandage to keep all close.

After the blister has done running, and the scabs begin to dry and peel off, it may be applied a second time, in the same manner as before; this second application generally taking greater effect than the first, and in colts and young horses makes a perfect cure.

When the spavin has been of long standing, it will require to be renewed, perhaps, five or six times; but after the second application, a greater distance of time must be allowed, otherwise it might leave a scar, or cause a baldness; to prevent which, once a fortnight or three weeks is often enough; and it may in this manner be continued six or seven times, without the least blemish, and will generally be attended with success.

But the spavins that put out on older, or full-aged horses, are apt to be more obstinate, as being seated more inward; and when they run among the sinuosities of the joint, they are for the most part incurable, as they then lie out of the reach of applications, and are arrived to a degree of impenetrable hardness.

The usual method in these cases is to fire directly, or to use the strongest kind of caustic blisters; and sometimes to fire and lay the blister immediately over the part; but this way seldom succeeds farther than putting a stop

to the growth of the spavin, and is apt to leave both a blemish and stiffness behind; besides the great risk run (by applications of these fiery and caustic medicines to the nervous and tendinous parts about the joints) of exciting violent pain and anguish, and destroying the limb.

The best and safest way therefore, is to make trial of the blistering ointment above, and to continue it according to the directions there laid down, for some months, if found necessary; the horses in the intervals working moderately: the hardness will thus be dissolved by degrees, and wear away insensibly.

Where the spavin lies deep, and runs so far into the hollow of the joint, that no application can reach it, neither firing nor medicines can avail, for the reasons above-mentioned; though bold ignorant fellows have sometimes succeeded in cases of this sort (by men of judgment deemed incurable) by the application of caustic ointments with sublimate, which act very forcibly, enter deep, and make a large discharge, and by that means destroy a great part of the substance, and dissolve away the remainder: Tho', whoever is at all acquainted with the nature of these medicines, must know how dangerous in general their operation is on these occasions; and that a proper prepared cautery made like a steam, under the direction of a skilful hand, may be applied with less danger of injuring either tendons or ligaments. After the substance of the swelling has been properly penetrated by the instrument, it must be kept running by the precipitate medicine, or mild blistering ointment. Where the spavin lies not deep in the joint, and the blistering method will not succeed, the swelling may be safely fired with a thin iron forced pretty deep into the substance, and then should be dressed, as is above directed.

#### Of a CURB and RING-BONE.

As a spavin rises among the bones on the fore-part of the hock, so a curb takes its origin from the junctures of the same bones, and rises on the hind-part, forming a pretty large tumour over the back part of the hind-leg, attended with stiffness, and sometimes with pain and lameness.

A curb proceeds from the same causes that produce spavins; viz. hard riding, strains, blows, or kicks. The cure at first is generally easy enough effected by blistering, repeated two or three times, or oftener. If it does not submit to this treatment, but grows excessively hard, the quickest and surest way is to fire with a thin iron, making a line down the middle from top to bottom, and drawing several lines in a penniform manner pretty deep; and then to apply a mild blistering plaster or ointment over it.—This method will entirely remove it.

There is another swelling taken notice of on the outside of the hock, which is called a *jardon*. This commonly proceeds from blows and kicks of other horses; but frequently happens to menaged horses, by setting them on their haunches: it is seldom attended with much lameness, unless it has been neglected, or some little process of the bone be broke. It should first be treated with the coolers and repellers in (p. 574 and 575.); but if any swelling continues hard, and insensible, the best way is to blister or fire; but the mild blisters alone generally succeed.

The *ring-bone* is a hard swelling on the lower part of the pastern, which generally reaches half-way round the fore-part thereof, and from its resemblance to a ring has its denomination. It often arises from strains, &c. and when behind, from putting young horses too early upon their haunches; for in that attitude a horse throws his whole weight as much, if not more, upon his pasterns, than on his hocks.

When it appears distinctly round the pastern, and does not run downwards toward the coronet, so as to affect the coffin-joint, it is easily cured; but if it takes its origin from some strain or defect in the joint originally, or if a callosity is found under the round ligament that covers that joint, the cure is generally dubious, and sometimes impracticable; as it is apt to turn to a quitor, and in the end to form an ulcer upon the hoof.

The ring-bones that appear on colts and young horses, will often insensibly wear off of themselves, without the help of any application; but when the substance remains, there needs no other remedy besides blistering, unless when by long continuance it is grown to an oblongate hardness, and then it may require both blistering and firing.

To fire a ring-bone successfully, let the operation be performed with a thinner instrument than the common one, and let the lines or razes be made not above a quarter of an inch distant, crossing them obliquely, somewhat like a chain: apply a mild blister over all, and, when quite dried up, the rupture-plaster; and then turn the horse to graze for some time.

#### Of SPLENTS.

THESE are hard excrescences that grow on the shank-bone, and are of various shapes and sizes. Some horses are more subject to splents than others; but young horses are most liable to these infirmities, which often wear off and disappear of themselves. Few horses put out splents after they are seven or eight years old, unless they meet with blows or accidents.

A splent that arises in the middle of the shank-bone is no ways dangerous; but those that arise on the back part of this bone, when they grow large and press against the back sinew, always cause lameness or stiffness, by rubbing against it: the others, except they are situated near the joints, seldom occasion lameness.

As to the cure of splents, the best way is not to meddle with them, unless they are so large as to disfigure a horse, or are so situated as to endanger his going lame.

Splents in their infancy, and on their first appearance, should be well bathed with vinegar, or old verjuice; which, by strengthening the fibres, often put a stop to their growth: for the membrane covering the bone, and not the bone itself, is here thickened: and in some constitutions purging, and afterwards diuretic drinks, will be a great means to remove the humidity and moisture about the limbs, which is what often gives rise to such excrescences.

Various are the remedies prescribed for this disorder; the usual way is to rub the splent with a round stick or the handle of a hammer, till it is almost raw, and then touch it with oil of origanum. Others lay on a pitch-plaster,

plaster, with a little sublimate, or arsenic, to destroy the substance: some use oil of vitriol; some tincture of cantharides: all which methods have at times succeeded; only they are apt to leave a scar with the loss of hair. Those applications that are of a more caustic nature, often do more hurt than good, especially when the splent is grown very hard, as they produce a rottenness, which keeps running several months before the ulcer can be healed, and then leaves an ugly scar.

Mild blisters often repeated, as recommended in the section upon the *Bone-Spavin*, should first be tried as the most eligible method, and will generally succeed, even beyond expectation: but if they fail, and the splent be near the knee or joints, you must fire and blister in the same manner as for the bone-spavin.

Splents on the back part of the shank-bone are difficult to cure, by reason of the back sinews covering them: the best way is to bore the splent in several places with an iron not very hot; and then to fire in the common way, not making the lines too deep, but very close together.

#### *Of the POLL-EVIL.*

THE poll-evil is an abscess near the poll of a horse, formed in the sinuses between the poll-bone, and the uppermost vertebrae of the neck.

If it proceeds from blows, bruises, or any external violence, at first bathe the swelling often with hot vinegar; and if the hair be fretted off with an ouzing through the skin, make use of two parts of vinegar, and one of spirit of wine; but if there be an itching, with heat and inflammation, the safest way is to bleed, and apply poultices with bread, milk, and elder-flowers: this method, with the assistance of physick, will frequently disperse the swelling, and prevent this evil.

But when the tumour is critical, and has all the signs of matter, the best method then is to forward it by applying the ripening poultices already taken notice of, till it comes to maturity, and bursts of itself; or if opened with a knife, great care should be taken to avoid the tendinous ligament that runs along the neck under the mane: when matter is on both sides, the opening must be made on each side, and the ligament remain undivided.

If the matter flows in great quantities, resembles melted glue, and is of an oily consistence, it will require a second incision, especially if any cavities are discovered by the finger or probe; these should be opened by the knife, the orifices made depending, and the wound dressed with the common digestive of turpentine, honey, and tincture of myrrh, and, after digestion, with the precipitate ointment; or wash the sore with the following, made hot, and fill up the cavity with tow soaked in it.

TAKE vinegar or spirit of wine half a pint, white vitriol dissolved in spring-water half an ounce, tincture of myrrh four ounces.

This may be made sharper by adding more vitriol; but if the flesh is very luxuriant, it should first be pared down with a knife before the application; with this wash alone Mr Gibson has cured this disorder without any other formality of dressing, washing with it twice a-day, and

laying over the part a quantity of tow soaked in vinegar and the white of eggs beat together.

But the most compendious method of cure, is found by observation to be by *scalding*, as the farriers term it; and is thus prosecuted when the sore is foul, of a bad disposition, and attended with a profusion of matter.

TAKE corrosive sublimate, verdegrease in fine powder, and Roman vitriol, of each two drams; green copperas half an ounce, honey or *Ægyptiacum* two ounces, oil of turpentine and train oil of each eight ounces, rectified spirit of wine four ounces; mix together in a bottle.

The manner of scalding is first to clean the abscess well with a piece of sponge dipped in vinegar; then put a sufficient quantity of the mixture into a ladle with a spout, and when it is made scalding hot, pour it into the abscess, and close the lips together with one or more stitches. This is to remain in several days; and if good matter appears, and not in an over great quantity, it will do well without any other dressing, but bathing with spirit of wine; if the matter flows in great abundance, and of a thin consistence, it must be scalded again, and repeated till the matter lessens and thickens.

#### *Of a FISTULA, and BRUISES on the WITHERS; WARBLES on the Back, and SIT-FASTS.*

BRUISES on the withers frequently imposthume, and for want of care turn fistulous. They arise often from pinches of the saddle, and should be treated with repellents: for this purpose bathe the tumour well with hot vinegar three or four times a day; if that does not succeed alone, an ounce of oil of vitriol may be put to a quart of vinegar, or half an ounce of white vitriol dissolved in a little water, and added to the same quantity. These are generally very effectual repellents for this purpose in horses, and will frequently prevent imposthuration: when the swelling is attended with heat, smarting, and little hot watery pimples, the following mixture will then be more proper to bathe with.

TAKE two ounces of crude sal ammoniac, boiled in a quart of lime-water; where that cannot be had, a handful of pearl or wood-ashes may be boiled in common water: pour off the decoction when settled, and mix with it half a pint of spirit of wine: anoint the part afterwards with linseed oil, or elder ointment, to soften and smooth the skin.

But when the swellings are critical, the consequence of a fever settled on this part, you must avoid the repelling method, and assist in bringing the swelling to matter, by means of suppurating poultices: experienced farriers advise, never to open these tumours till they break off themselves: for if they are opened before they are ripe, the whole sore will be spongy, and discharge a bloody ichor, which soon degenerates into a fordid ulcer. But take care to enlarge the openings and pare away the lips, that your dressings may be applied easily; and avoid the ligament which runs along the neck to the withers: if a gathering forms on the opposite side, open it in the same manner, but take care they incline downwards, for the sake of depending orifices, and letting the matter flow off

off easily. For the method of dressing, we must refer to the preceding Section; and if the bones should be found foul, they must be dressed with tincture of myrrh till they scale off: if the fungus is very troublesome, and the discharge oily, yellow and viscid, pledgets soaked in the following, made hot, have been found very effectual, bathing the swelling round with spirit of wine and vinegar.

TAKE half an ounce of blue vitriol dissolved in a pint of water; oil of turpentine, and rectified spirit of wine, of each four ounces; white-wine vinegar, six ounces; oil of vitriol and Ægyptiacum, of each two ounces.

When the cavities are truly fistulous, the callosities must be cut out, where it can be done, with a knife; and the remainder destroyed by corrosives, viz. precipitate, burnt alum, and white vitriol, as we have already observed in the Section on Ulcers.

*Wartles* are small hard tumours under the saddle-part of the horse's back, occasioned by the heat of the saddle in travelling, or its uneasy situation. A hot greasy dish-cloth at first frequently applied, will sometimes remove them. Camphorated spirits of wine are also very effectual for this purpose to disperse them, to which a little spirit of sal armoniac may be added. The repellents above-mentioned are successfully applied in these cases; and if you are obliged to work the horse, take care your saddle is nicely chambered.

A *fit-fast* proceeds generally from a warble, and is the horse's hide turned horny, which, if it cannot be dissolved and softened by rubbing with the mercurial ointment, must be cut out, and treated then as a fresh wound.

#### Of WIND-GALLS, BLOOD and BOG SPAVINS.

A WIND-GALL is a flatulent swelling, which yields to the pressure of the finger, and recovers its shape on the removal thereof: the tumour is visible to the eye, and often seated on both sides of the back sinew, above the fetlocks, on the fore legs, but most frequently on the hind-legs; though they are met with in various parts of the body, where-ever membranes can be so separated, that a quantity of air and serosities may be included within their duplicatures.

When they appear near the joints and tendons, they are generally caused by strains, or bruises on the sinews, or the sheath that covers them; which, by being over-stretched, have some of their fibres ruptured; whence probably may ouze out that fluid which is commonly found with the included air: though where these swellings shew themselves in the interstices of large muscles, which appear blown up like bladders, air alone is the chief fluid; and these may safely be opened, and treated as a common wound.

On the first appearance of wind-galls, their cure should be attempted by restreints and bandage; for which purpose, let the swelling be bathed twice a-day with vinegar, or verjuice alone; or let the part be fomented with a decoction of oak-bark, pomegranate, and alum boiled in verjuice, binding over it with a roller, a woollen cloth soaked in the same. Some, for this purpose, use

red-wine lees, others carriers suavings wetted with the same, or vinegar, bracing the part up with a firm bandage.

If this method, after a proper trial, should not be found to succeed, authors have advised the swelling to be pierced with an awl, or opened with a knife: but mild blistering has in general the preference given to these methods; the included fluids being thereby drawn off, the impacted air dispersed, and the tumour gradually diminished.

A *blood-spavin* is a swelling and dilatation of the vein that runs along the inside of the hock, forming a little soft swelling in the hollow part, and is often attended with a weakness and lameness of the hock.

The cure should be first attempted with the restreints and bandage above recommended, which will contribute greatly to strengthen all weaknesses of the joints, and frequently will remove this disorder, if early applied: but if by these means the vein is not reduced to its usual dimensions, the skin should be opened, and the vein tied with a crooked needle and wax-thread passed underneath it, both above and below the swelling, and the turgid part suffered to digest away with the ligatures: for this purpose, the wound may be daily dressed with turpentine, honey, and spirit of wine, incorporated together.

A *bog-spavin* is an encysted tumour on the inside the hough; or, according to Dr Bracken, a collection of brownish gelatinous matter, contained in a bag, or cyst, which he thinks to be the lubricating matter of the joint altered, the common membrane that incloses it forming the cyst. This case he has taken the pains to illustrate in a young colt of his own, where he says, When the spavin was pressed hard on the inside the hough, there was a small tumour on the outside, which convinced him the fluid was within-side the joint: he accordingly cut into it, discharged a large quantity of this gelatinous matter, dressed the sore with dossils dipped in oil of turpentine, putting into it, once in three or four days, a powder made of calcined vitriol, alum, and bole: by this method of dressing, the bag sloughed off, and came away, and the cure was successfully compleated without any visible scar.

This disorder, according to the above description, will scarcely submit to any other method, except firing, when the cyst ought to be penetrated to make it effectual; but in all obstinate cases that have resisted the above methods, both the cure of this and of the swellings called wind-galls should be attempted in this manner. If, through the pain attending the operation or dressings, the joint should swell and inflame, foment it twice a-day, and apply a poultice over the dressings till it is reduced.

#### Of MALLENDERS and SALLENDERS.

MALLENDERS are cracks in the bend of the horse's knee, that discharge a sharp indigested matter: they are often the occasion of lameness, stiffness, and the horse's tumbling.

*Sallenders* are the same distemper, situate on the bending of the hough, and occasion a lameness behind.

They are both cured by washing the parts with a lather of soap warmed, or old chamber-lye; and then apply o-

ver the cracks a strong mercurial ointment spread on tow, with which they should be dressed, night and morning, till all the scabs fall off: if this should not succeed, anoint them night and morning with a little of the following, and apply the above ointment over it.

TAKE hogs lard, two ounces; sublimate mercury, two drams.

Or,

TAKE hogs lard, two ounces; oil of vitriol, two drams.

Take the next from Gibson, which is to be depended on:

ÆTHIOPS mineral, half an ounce; white vitriol, one dram; soft green soap, six ounces.

Anoint with this often; but first clip away the hair, and clear the scabs. On their drying up, it may be proper to give a gentle purge or two; or the nitre balls may be taken advantageously, for a fortnight or three weeks.

#### Of LAMPAS, BARBS, and WOLVES TEETH.

THE *lampas* is an excrescence in the roof of the horse's mouth, which is sometimes so luxuriant, that it grows above the teeth, and hinders his feeding. The cure is in lightly cauterising the flesh with a hot iron, taking care that it does not penetrate too deep, so as to scale off the thin bone that lies under the upper bars; the part may be anointed with burnt alum and honey, which is proper for most sores in the mouth.

This operation is by some thought to be entirely unnecessary; it being a general observation with them, that all young horses have their mouths more or less full of what are called *lampas*; and that sometimes they rise higher than the fore-teeth; but they further observe, in proportion as a horse grows older, the roof flattens of itself, and the teeth then appear to rise. We are obliged to the ingenious M. La Fosse for this remark, and hope it will be the means of abolishing this cruel and unnecessary operation.

*Barbs* are small excrescences under the tongue, which may be discovered by drawing it aside, and are cured by cutting close off, and washing with brandy or salt and water.

A horse is said to have *wolves-teeth*, when the teeth grow in such a manner, that their points prick, or wound either the tongue, or gums, in eating. Old horses are most liable to this infirmity, and whose upper overshoot the under teeth in a great degree.

To remedy this evil, you may either chop off the superfluous parts of the teeth with a chizel and mallet, or file them down, which is the better way, till you have sufficiently wasted them.

#### Of the GREASE.

IN order to treat this disorder with some propriety; we shall consider it as arising from two different causes; a fault or relaxation in the vessels, or a bad disposition in the blood and juices. We must here observe, that the blood and juices (or humours, for there are always some in the best state of blood) are brought to the extremest parts by the arteries, and returned by the veins;

in which latter, the blood is to rise in perpendicular columns, to return the circulating fluids from the extremities: hence swellings in the legs of horses may easily be accounted for, from a partial stagnation of the blood and juices in the finer vessels, where the circulation is most languid; and especially when there is want of due exercise, and a proper muscular compression on the vessels, to push forward the returning blood, and propel the inert and half stagnating fluids through their vessels; in short, the blood in such cases cannot so readily ascend as descend, or a greater quantity is brought by the arteries than can be returned by the veins.

The grease then, considered in this light, must be treated as a local complaint, where the parts affected are alone concerned, the blood and juices being yet untainted, and in good condition; or as a disorder where they are both complicated: but when it is an attendant on some other distemper, as the farcy, yellows, dropsy, &c. such diseases must first be cured before the grease can be removed. In the former case, moderate exercise, proper dressing, cleanliness, and external application, will answer the purpose; in the latter, internals must be called in to our assistance, with proper evacuations.

When a horse's heels are first observed to swell in the stable, and subside or go down on exercise; let care be taken to wash them very clean every time he comes in, with soap-suds, chamber-lye, or vinegar and water, which, with proper rubbing, will frequently prevent, or remove this complaint: or let them be well bathed twice a-day with old verjuice, or the following mixture, which will brace up the relaxed vessels; and if rags dipped in the same are rolled on, with a proper bandage, for a few days, it is most likely the swellings will soon be removed by this method only, as the bandage will support the vessels, till they have recovered their tone. To answer this end also, a laced stocking made of strong canvas or coarse cloth, neatly fitted to the part, would be found extremely serviceable, and might easily be contrived by an ingenious mechanic.

TAKE rectified spirit of wine, four ounces; dissolve in it half an ounce of camphor; to which add wine-vinegar, or old verjuice, six ounces; white vitriol, dissolved in a gill of water, one ounce; mix together, and shake the phial when used.

But if cracks or scratches are observed, which ouze and run, let the hair be clipped away, as well to prevent a lodgment (which becomes stinking and offensive by its stay) as to give room for washing out dirt or gravel, which, if suffered to remain there, would greatly aggravate the disorder.

When this is the case, or the heels are full of hard scabs, it is necessary to begin the cure with poultices, made either of boiled turnips and lard, with a handful of linseed powdered; or oatmeal and rye flour, with a little common turpentine and hogs lard, boiled up with strong-beer grounds or red-wine lees. The digestive ointment being applied to the sores for two or three days, with either of these poultices over it, will, by softening them, promote a discharge, unload the vessels, and take down the swelling; when they may be dried up with the following:

TAKE

TAKE white vitriol and burnt alum, of each two ounces; Ægyptiacum, one ounce; lime-water, a quart or three pints: wash the sores with a sponge dipped in this, three times a-day, and apply the common white ointment spread on tow; to an ounce of which may be added two drams of sugar of lead.

This method is generally very successful, when the distemper is only local, and requires no internal medicines; but if the horse be full and gross, his legs greatly gorged, so that the hair stands up, and is what some term pen-feathered, and has a large stinking discharge from deep foul sores, you may expect to meet with great trouble, as these disorders are very obstinate to remove, being often occasioned by a poor dropical state of blood, or a general bad disposition in the blood and juices.

The cure in this case, if the horse is full and fleshy, must be begun by bleeding, rowels, and repeated purging; after which, diuretic medicines are frequently given with success. Thus,

TAKE four ounces of yellow rosin, one of sal prunellæ; grind them together with an oiled pestle, add a dram of oil of amber, and give a quart of forge-water every morning, fasting two hours before and after taking, and ride moderately.

As this drink is found very disagreeable to some horses, I would recommend the nitre-balls in its stead, given to the quantity of two ounces a-day, for a month or six weeks, mixed up with honey, or in his feeds: take the following also for that purpose.

Yellow rosin, four ounces; salt of tartar, and sal prunellæ, of each two ounces; Venice soap, half a pound; oil of juniper, half an ounce; make into balls of two ounce weight, and give one every morning.

The legs, in this case, should be bathed or fomented, in order to breathe out the stagnant juices, or to thin them, so that they may be able to circulate freely in the common current. For this purpose, foment twice a day with the discutient fomentation, p. 569. col. 2. par. 3. in which a handful or two of wood-ashes has been boiled; apply then the above poultices, or the following, till the swelling has subsided, when the sores may be dressed with the green ointment till they are properly digested, and then dried up with the water and ointment above recommended.

TAKE honey, one pound; turpentine, six ounces; incorporate with a spoon; and add of the meal of fenugreek and linseed, each four ounces; boil in three quarts of red-wine lees to the consistence of a poultice; to which add, when taken from the fire, two ounces of camphor in powder; spread it on thick cloths, and apply warm to the legs, securing it on with a strong roller.

If the sores are very foul, dress them with two parts of the wound-ointment, and one of Ægyptiacum, and apply the following, spread on thick cloths, and rolled on.

TAKE of black soap, one pound; honey, half a pound; burnt alum, four ounces; verdigrease powdered, two ounces; wheat flour, a sufficient quantity.

If the diuretic balls should not succeed, they must be

changed for the antimonial and mercurial alteratives, already mentioned; but turning a horse out in a field, where he has a hovel or shed to run to at pleasure, would greatly contribute to quicken the cure, and indeed would in general effect it alone; but if this cannot be complied with, let him be turned out in the day-time.

If the horse is not turned out, a large and convenient stall is absolutely necessary, with good dressing and care.

The last thing we shall recommend, is a method to oblige a horse to lie down in the stable. This undoubtedly is of the utmost consequence, as it will not a little contribute to the removal and cure of this disorder; for by only changing the position of his legs, a freer circulation would be obtained, and the swelling taken down: whereas in general it is greatly aggravated by the obstinacy of the horse, who refuses to lie down at all (probably from the pain it gives him to bend his legs for that purpose) by which means the stiffness and swelling increases, till the over-gorged and distended vessels are obliged to give way, and by bursting, discharge the fluids, which should circulate through them.

#### OF SCRATCHES, CROWN-SCABS, RAT-TAILS, and CAPELLETS.

SCRATCHES in the heels have so much affinity with the grease, and are so often concomitants of that distemper, that the method of treating them may be selected chiefly from the preceding section; which at first should be by the linseed and turnip poultice, with a little common turpentine to soften them, and relax the vessels; the green ointment may then be applied for a few days to promote a discharge, when they may be dried up with the ointments and washes recommended in the above section. It is best afterwards to keep the heels supple, and softened with currier's dubbing, which is made of oil and tallow. This will keep the hide from cracking, and be as good a preservative as it is to leather; and by using it often before exercise, will prevent the scratches, if care is taken to wash the heels with warm water, when the horse comes in. When they prove obstinate, and the sores are deep, use the following; but if any cavities or hollow places are formed, they should first be laid open; for no foundation can be laid for healing, till you can dress to the bottom.

TAKE Venice turpentine, four ounces; quicksilver, one ounce; incorporate well together by rubbing some time, and then add honey and sheeps suet, of each two ounces.

Anoint with this once or twice a day; and if the horse is full or fleshy, you must bleed and purge; and if the blood is in a bad state, the alteratives must be given to rectify it.

The *crown-scab* is an humour that breaks out round the coronet, which is very sharp and itching, and attended with a scurfulness: sharp waters prepared with vitriol are generally used for the cure; but the safest way is first to mix marshmallow and yellow basilicon, or the wound ointment, equal parts, and to spread them on tow, and lay all round the coronet. A doze or two of physic may be very proper, with the diuretic medicines, (par. 4. 5. 6. of the preced. col. and the alteratives above recommended

commended, in rebellious cases. *Vid.* the Section on ALTERATIVES.

*Rat-tails* are excrescences, which creep from the paster to the middle of the hanks, and are so called from the resemblance they bear to the tail of a rat. Some are moist, others dry; the former may be treated with the drying ointment and washes, p. 577. col. 1. par. 1. the latter with the mercurial ointment, p. 555. col. 2. par. 6. If the hardness does not submit to the last medicine, it should be pared off with a knife, and dressed with turpentine, tar and honey, to which verdigrease or white vitriol may occasionally be added; but before the use of the knife, you may apply this ointment.

TAKE black soap, four ounces; quick-lime, two ounces; vinegar enough to make an ointment.

There are particular swellings which horses are subject to, of a wenny nature, which grow on the heel of the hock, and on the point of the elbow, and are called by the French and Italians capellets: they arise often from bruises and other accidents; and when this is the case, should be treated with vinegar and other repellers; but when they grow gradually on both heels, or elbows, we may then suspect the blood and juices in fault that some of the vessels are broke, and juices extravasated; in this case, the suppuration should be promoted, by rubbing the part with marshmallow ointment, and when matter is formed, the skin should be opened with a lancet, in some dependent part towards one side, to avoid a scar: the dressings may be turpentine, honey, and tincture of myrrh. The relaxed skin may be bathed with equal parts of spirit of wine and vinegar, to which an eighth part of oil of vitriol may be added. The contents of these tumours are various, sometimes watery, at others suety, or like thick paste; which, if care be not taken to digest out properly with the cyst, will frequently collect again; was it not for the disfigurement, the shortest method would be to extirpate them with a knife, which, if artfully executed, and the skin properly preserved, would leave very little deformity.

#### *Of the Diseases of the FEET.*

##### *Of NARROW HEELS, and BINDING of the HOOF, &c.*

THOUGH narrow heels in general arise from a natural defect, yet they are often rendered incurable by bad shoeing; for some farriers hollow the quarters so deep and thin, that they may be pinched in with the fingers, and think by that method to widen them out by a strong broad webbed shoe; but this turns them narrow above, wires their heels, and dries, or rots the frog. The best way in all such cases is not to hollow the foot in shoeing, and to pare nothing out but what is rotten or foul; if the foot be hard and dry, or inclined to be rotten, bathe it often with chamber-lye, or boil two pounds of linseed bruised in two quarts of the same, to the consistence of a poultice, then add six ounces of soft green soap, and anoint the foot with it every day, rubbing a little of it upon the sole.

Or,

TAKE bees-wax two ounces; fresh butter or lard, six

ounce; tar, one ounce; as much linseed, or neats-foot oil, as will make it the consistence of a smooth ointment.

The hoofs, if too dry, may be anointed with the above, or with lard only; some for this purpose use tar, tallow, and honey, but most greasy and unctuous applications will answer this intention; the feet also, if too dry, may be stuffed with bran and lard heated or worked up together in the hand, which is very proper also to apply every night, when your horse is travelling in hot weather on roads that are dry and hard; cow-dung likewise is a proper stuffing for the feet, but vinegar should cautiously be mixed with it; for though it is a known cooler, it is a remarkable restrigent, which in this case would be extremely prejudicial; instead of which, a print of fresh butter may be first applied to the sole, and the cow-dung laid over it.

There is another disorder the hoofs are subject to, which is their being too soft and moist; this may be constitutional, or proceed from going much in wet and marshy grounds, standing constantly on wet litter, or any infirmity that may bring too great a moisture into the feet. In this case the horse's hoofs may be bathed every day with warm vinegar, verjuice, copperas-water, and such like restrigents; to which may be added galls, alum, &c. remembering to let the horse stand constantly dry.

We say a horse is *hoof-bound*, when the hoof is so tight round the instep, that it turns the foot somewhat into the shape of a bell. This is caused sometimes by shoeing as above, to widen the heel, and sometimes by cutting the toes down too much, which gives that shape to the foot, and causes the horse to go lame.

To remedy this disorder, Mr Gibson recommends the following method: let the foot be drawn down from the coronet almost to the toe with a drawing knife, making seven or eight lines or razes through the hoof, almost to the quick; afterwards keep it charged with pitch rosin, till the lines are wore out in shoeing, which will require several months.

##### *Of SAND CRACKS and QUITTORS.*

WHAT is called a sand-crack, is a little cleft on the outside of the hoof: if it runs in a strait line downwards, and penetrates through the bony part of the hoof, it often proves troublesome to cure; but if it passes through the ligament that unites the hoof with the coronet, it is then apt to breed a quittor, or false quarter, which is dangerous.

When the crack only penetrates through the hoof, without touching the ligament, unless the hoof be hollow, it may easily be cured, by rasping only the edges smooth, and applying thick pledgets of basilicon, and binding them down with a piece of soft lilt; if some precipitate be added to it, this medicine will be improved thereby; and in general answers the end, without any other application. But if you perceive any hollownet's under the hoof, and that the cleft has a tendency to penetrate through the gristle or ligament, the best method, in that case, is to fire out of hand with irons that are not made



made too hot, first rasping very thin and wide from both sides of the cluit: the horse must not carry any weight for some time, but be turned out to graze, or wintered in a good farm yard.

A quitor is an ulcer formed between the hair and hoof, usually the inside quarter of a horse's foot; it arises often from treads and bruises, sometimes from gravel, which, by working its way upwards, lodges about the coronet: if it is only superficial, it may be cured with cleansing dressings, bathing the coronet every day with spirit of wine, and dressing the sore with the precipitate medicine.

But if the matter forms itself a lodgment under the hoof, there is no way then to come at the ulcer, but by taking off part of the hoof; and if this be done artfully and well, the cure may be effected without danger.

When the matter happens to be lodged near the quarter, the farrier is sometimes obliged to take off the quarter of the hoof, and the cure is then, for the most part, but palliative; for when the quarter grows up, it leaves a pretty large seam, which weakens the foot; this is what is called a false quarter, and a horse with this defect seldom gets quite sound.

If the matter, by its confinement, has rotted the coffin-bone, which is of so soft and spongy a nature, that it soon becomes so, you must enlarge the opening, cut away the rotten flesh, and apply the actual cautery, or hot iron pointed pyramidically, and dress the bone with dosils of lint, dipped in tincture of myrrh, and the wound with the green or precipitate ointment. When the sore is not enlarged by the knife, which is the best, and less painful method, pieces of sublimate are generally applied, which bring out with them cores, or lumps of flesh; blue vitriol powdered, and mixed with a few drops of the oil, is used also for this purpose, and is said to act as effectually, and with less pain and danger; during the operation of these medicines, the foot should be kept in some soft poultice, and care should be taken, during the whole dressing, to prevent proud flesh rising, which otherwise will not only retard the cure, but prevent a firm and sound healing.

#### *Of WOUNDS in the FEET, from NAILS, GRAVEL, &c.*

ACCIDENTS of this sort are very common, and sometimes for want of early care, prove of bad consequence; for the parts, being naturally tender, are very susceptible of inflammation; and when matter is once formed, if a free discharge is not procured, the bone, which is spongy, soon becomes affected, and the whole foot is then in danger.

When any extraneous bodies, such as nails, stubs, thorns, &c. have passed into the horse's foot, you should endeavour to get them out as soon as possible; and after washing the part with oil of turpentine, dress the hole with lint dipped in the same, melted down with a little tar; the foot may be stopped up with bran and hogs-lard heated together, or put it into the turnip, or any soft poultice; this method is generally successful, when the nail, &c. is entirely removed; but if any piece, or particle, should remain behind, which may be suspected by the degree of pain, and discharge of matter; after par-

ing away the sole as thin as possible, introduce a bit of sponge tent, in order to enlarge the hole, that it may be drawn out by a small pair of forceps, or brought away by digestion: if this method should not succeed, but the lameness continues, with a discharge of a thin bloody, or stinking matter, you must no longer delay opening the wound with a drawing-knife to the bottom, and then dress as above directed, or with the turpentine digestive, divided with the yolk of an egg, and a little tincture of myrrh; afterwards with the precipitate medicine.

If the lameness proceeds from pricking in shoeing, the foot should be pared thin on the wound side, and after dressing with the tar and turpentine, let it be stopped with the poultices above mentioned, or with two ounces of common turpentine, melted down with four of lard; should this method not succeed, follow the above directions.

If the nail penetrates to the joint of the foot, where matter may be formed, and by its long continuance putrify, so as to erode the cartilages of the joint, the case is incurable.

If the nail has passed up to the nut-bone, it is incurable, because this little bone cannot exfoliate, and because the cartilaginous part of it is destroyed, as soon as injured.

If the nail has not passed to the tendon, the horse will do well, without a necessity for drawing the sole; but if the tendon is wounded, the sole must be carefully drawn, because a sinovia and gleet is discharged.

When gravel is the cause, if for the most part follows the nail-holes, and if it gets to the quick cannot return, unless it is scraped out; for the make of the hoof, which is spiral like an ear of corn, favours its ascent, so that the gravel continues working upwards towards the coronet, and forms what the farriers call a quitor-bone.

The nature of this disorder points out the method of cure, which is to be as expeditious and careful as possible, in getting out the gravel; if it is found difficult to effect this, let the sole or hoof be pared thin, and, if necessary, the wound enlarged to the bottom, and then dressed up as usual. Should the coffin-bone be affected, you must follow the directions laid down in the preceding section, remembering always to bathe the hoof with vinegar, or repellers, in order to allay the heat and inflammation, which often happen on such occasions; and should the pain and anguish affect the legs, treat them in the same manner, or charge the leg and pastern with a mixture of wine-lees and vinegar.

*Figs* are spongy swellings on the bottom of horses feet, generally on the sides of the frush. These, or any other kind of excrescences, such as warts, corns, grapes, &c. are best removed by the knife; and if any part of them be left behind, or should shoot up afresh, touch them with the caustic, or oil of vitriol, and dress with Egyptianum; to which may be added, when they are very rebellious, a small quantity of sublimate; when the roots are quite destroyed, you may incarn with the precipitate medicines, and dry up the sore with the following wash.

TAKE of white vitriol, alum, and galls in powder, of each two ounces; dissolve them by boiling a little in two quarts of lime water, and keep in a bottle for use, which should be shook when used.

*cf*

*Of the RUNNING THRUSH, CANKER, and  
Loss of Hoof.*

THE *thrush* or *frush* is an imposthume that sometimes gathers in the frog; or a scabby and ulcerous disposition, which sometimes causes it to fall off: when the discharge is natural, the feet should be kept clean, but no drying washes made use of, it being thought as unsafe to repel some of these discharges, as to cure some sweaty feet.

When an imposthume, or gathering appears, the safest way is to pare out the hard part of the frog, or whatever appears rotten; and wash the bottom of the foot two or three times a-day with old chamber-lye; this is the safest and best way of treating them. But when a horse has been neglected, and there is in a strong flux to the part, it is apt to degenerate into a canker; to prevent which, use the following wash.

TAKE spirit of wine and vinegar of each two ounces, tincture of myrrh and aloes one ounce, Ægyptiacum half an ounce; mix together.

Bathe the thrush with this, where-ever there appears a more than ordinary moisture, and lay over the ulcer a little tow dipped in the same. The purges and diuretics recommended in the greafe, should be given at this time, to prevent the inconveniencies that the drying up these discharges frequently occasion.

A *canker* in the foot proceeds, for the most part, from thrushes, when they prove rotten and putrid, though many other causes may produce this disorder. The method used by farriers for the cure is generally with hot oils, such as vitriol, aqua-fortis, and batter of antimony, which are very proper to keep down the rising flesh, and should be used daily, till the fungus is suppressed, when once in two days will be sufficient, strewing fine precipitate powder over the new-grown flesh, till the sole begins to grow.

There is one great error committed often in this cure, that is, in not having sufficient regard to the hoof; for it should not only be cut off, where-ever it presses on the tender parts, but should be kept soft with linseed oil; and as often as it is dressed, bathe the hoof all round the coronet with chamber-lye. Purging is very proper to complete the cure.

The *loss of the hoof* may be occasioned by whatever accident may bring an imposthuration in the feet, whereby the whole hoof becomes loosened, and falls off from the bone. If the coffin-bone remains uninjured, a new hoof may be procured by the following method.

The old hoof should by no means be pulled off, unless some accident happens that requires its removal; for it serves as a defence to the new one, and makes it grow more smooth and even; and indeed nature will generally do this office at her own proper time.—On the removal of the hoof, a boot of leather, with a strong sole, should be laced about the pastern, bolstering and stopping the foot with soft flax, that the tread may be easy; dress the sore with the wound ointment, to which should be added the fine powders of myrrh, mastick, and olibanum. If this medicine should not be sufficient to prevent a fungus, burnt alum or precipitate may be added to

it, and the luxuriant flesh may be daily washed with the sublimate water.

*Of RUPTURES, ANTICOR, COLT-EVIL or GONORRHOEA, and Discharges of the MOUTH.*

IN regard to ruptures, though they are generally divided into particular classes, we shall only observe, that by violent efforts of the horse, or other accidents, the guts or caul may be forced between the muscles of the belly at the navel, and through the rings of the muscles into the scrotum or cod. The swellings are generally about the size of a man's fist, sometimes much larger, descending to the very hock; they are frequently soft, and yield to the pressure of the hand, when they will return into the cavity of the belly with a rumbling noise; and, in most, the vacuity may be felt through which they passed.

On their first appearance, endeavours should be made to return them by the hand; but if the swelling should be hard and painful, in order to relieve the stricture, and relax the parts, through which the gut or caul has passed, let a large quantity of blood be immediately taken away, and the part fomented twice or thrice a-day, applying over it a poultice made with oatmeal, oil and vinegar, which should be continued till the swelling grows soft and eases, or the gut is returned. In the mean time it would be proper to throw up emollient oily glysters twice a-day, and to let the horse's chief diet be boiled barley, scalded malt, or bran.

Should the swelling afterwards return, we apprehend the restraining applications, usually recommended on these occasions, will avail little without a suspensory bandage; so that an ingenious mechanic in that art is chiefly to be relied on for any future assistance; though it has been observed, that with moderate feeding, and gentle exercise, some horses have continued to be very useful under this complaint.

The *anticor* is a disorder not very common among our horses, or those in northern climates; but is particularly taken notice of by the French, Spanish, and Italian writers; who describe it a malignant swelling in the breast, which extends sometimes to the very sheath under the belly; it is attended with a fever, great depressions, and weakness, and a total loss of appetite.

The cure should first be attempted by large and repeated bleedings, to abate the inflammation; emollient glysters should be injected twice or thrice a-day, with an ounce of sal prunella in each, and the cooling drink in the Section on Fevers should be given inwardly; the swelling should be bathed with the marshmallow ointment, and a ripening poultice, with onions boiled in it, should be daily applied over it. If by this method, continued four or five days, the inflammation in the throat and gullet is removed, our attention should more particularly turn to encourage the swelling at the breast, and bring it, if possible, to matter: to which end, continue the poultice, and give two ounces of Venice treacle dissolved in a pint of beer every night; when the swelling is grown soft, it must be opened with the knife, and dressed with serpentaine digestive, the danger now being over.

But

But should it be found impracticable to bring the swelling to matter, and it increases upwards, so as to endanger suffocation; authors have advised to pierce the tumour with a hot pointed cautery in five or six places, to dress with the above digestive; and in order to stimulate and promote a greater discharge, to add to it a small quantity of Spanish flies and euphorbium in powder; fomenting at the same time, and bathing the circumjacent parts with ointment of marshmallows. M. Guerinere, as well as Soleyfell, have advised opening the skin, when the tumour cannot be brought to matter, in order to introduce a piece of black hellebore-root steeped in vinegar, and to confine it there for twenty-four hours; this also is intended as a stimulant, and is said to answer the intention, by occasioning sometimes a swelling as big as a man's head.

Besides the disorders of the mouth, which we have already animadverted on, there are frequently observed on the inside the lips and palate, little swellings or bladders called *giggs*: slitting them open with a knife, or lancet, and washing them afterwards with salt and vinegar, is in general their cure; but when they degenerate into what are called cankers, which are known by little white specks, that spread and occasion irregular ulcers, the best method then is to touch them daily with a small flat cautery, moderately heated, till the spreading is stopped, and to rub the sores three or four times a-day with Ægyptiacum, and tincture of myrrh, sharpened with oil, or spirit of vitriol; when by this dressing the sloughs are separated, they may be washed frequently with a sponge dipped in copperas, or sublimate water, if they continue to spread; or a tincture made by dissolving half an ounce of burnt alum, and two ounces of honey, in a pint of tincture of roses. Either of these will dry them up, and are very useful in most disorders of the mouth.

A relaxation and swelling of the palate sometimes happens to horses on catching cold. To remedy this disorder,

blow pepper on the part, or anoint it with the same mixed up with honey. The tincture above-mentioned may be used for this purpose, to which may be added half an ounce of spirit of sal-armoniac.

The colt-evil is supposed to arise from stoned colts having full liberty with mares, before they are able to cover them; whence frequently ensues an excoriation or fretting on the glands, and a swelling on the sheath; this last disorder frequently proceeds too from dirt, or filth lodging there, and is often removed by washing the part clean with butter and beer: but when the yard itself is swelled, foment it twice a day with marshmallows boiled in milk, to which may be added a little spirit of wine; anoint the excoriation with the white ointment, or wash it with a sponge dipped in lime, to a pint of which may be added two drams of sugar of lead: the yard should be suspended up to the belly; and if the swelling should increase with the inflammation, bleed, and give the cooling physic, anoint with ointment of elder, and apply the bread and milk poultice.

If a simple gonorrhœa or seminal gleet is observed to drip from the yard, (which is often the case in high-fed young horses, where a relaxation of the glands and seminal vessels has been brought on by frequent emissions) let the horse be plunged every day into a river or pond; give him two or three rhubarb purges, at proper distances, and intermediately the following balls.

Take of balsam of copivi, or Venice turpentine, oil-banum, and mastich powdered, of each two drams; bole armoniac half an ounce: mix up into a ball with honey, and give it night and morning, till the discharge lessens, and then every night, till it goes off.

Balls prepared with rhubarb and turpentine may also be given for this purpose; two drams of the former, with half an ounce of the latter.

## F A S

**FASCES**, in Roman antiquity, axes bound up together with rods or staves, and carried before the Roman magistrates as a badge of their authority and office.

**FASCETS**, in the art of making glass, are the irons thrust into the mouths of bottles, in order to convey them into the annealing tower.

**FASCIA**, in architecture, signifies any flat member having a considerable breadth and but a small projecture, as the band of an architrave, larmier, &c.

**FASCIA LATA**, in anatomy. See *ANATOMY*, p. 206.

**FASCIÆ**, in astronomy, certain parts on Jupiter's body resembling belts or swaths. They are more lucid than the rest of that planet, and are terminated by parallel lines, sometimes broader and sometimes narrower.

**FASCIALIS**, in anatomy. See *SARTORIUS*.

**FASCINATION**, a kind of witchcraft or enchantment supposed to operate by the influence either of the eye or tongue.

**FASCINES**, in fortification, faggots of small wood, of about a foot diameter and six feet long, bound in the

## F A T

middle and at both ends. They are used in raising batteries, making chandeliers, in filling up the moat to facilitate the passage to the wall, in binding the ramparts where the earth is bad, and in making parapets of trenches to screen the men.

**FASHION-PIECES**, in the sea-language, are two compassing pieces of timber, into which is fixed one on each side the transom. See *TRANSOM*.

**FAST**, or **FASTING**, in general, denotes the abstinence from food; but is more particularly used for such abstinence on a religious account.

**FASTERMANS**, among our Saxon ancestors, were pledges or bondsmen, who were answerable for each other's good behaviour.

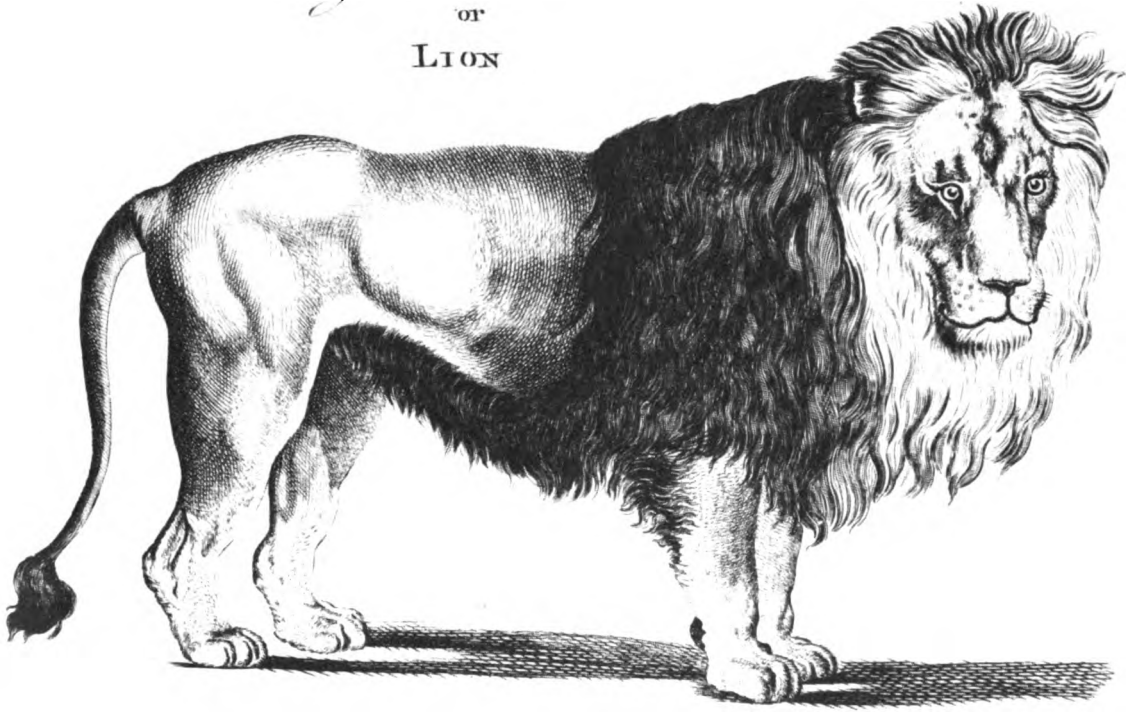
**FASTI**, in Roman antiquity, the calendar wherein were expressed the several days of the year, with their feasts, games, and other ceremonies.

**FAT**, in anatomy, an oleaginous or butyraceous matter, secreted from the blood, and filling up the cavity of the adipose cells. Fat, properly and distinctly so called,

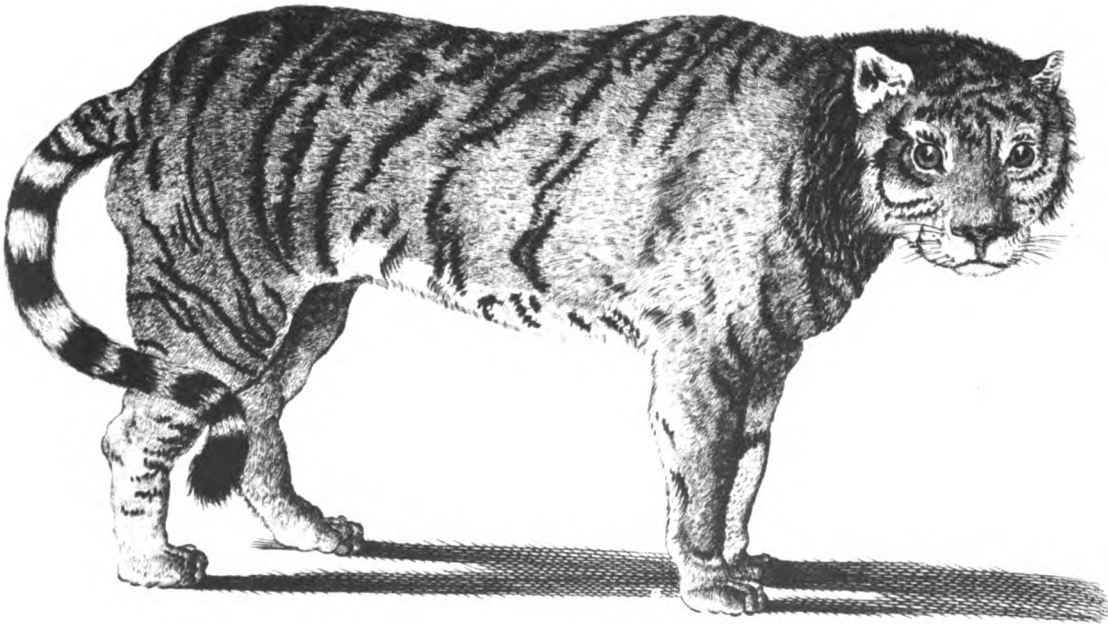
- ed, is not secreted from glandules, but from the little arteries of the adipose membrane. Authors distinguish it into two kinds, which they express by the words *sebum* or *ad. ps.* and *pinguedo*. According to this distinction, there is no such thing as sebum or hard fat in the human body, its fat being all of that sort expressed by *pinguedo*, or soft and oily. That this oleaginous matter has a circulatory motion, or an egress into the veins, is very evident from the sudden consumption of it in many diseases, and from its vast diminution by exercise or labour.
- FAT**, in the sea-language, signifies the same with broad. Thus a ship is said to have a fat quarter, if the trussing in or tuck of her quarter be deep.
- FAT** is used also for several utensils; as, 1. A great wooden vessel, used for the measuring of malt, and containing a quarter or eight bushels. 2. A large brewing vessel, used by brewers to run their wort in. 3. A leaden pan or vessel for the making of salt at Droitwich.
- FAT** likewise denotes an uncertain measure of capacity. Thus a fat ofising glass contains from  $3\frac{1}{4}$  hundred weight to 4 hundred weight; a fat of unbound books, half a maund or four bales; of wire, from 20 to 25 hundred weight; and of yarn, from 220 to 221 bundles.
- FATE**, denotes an inevitable necessity depending upon a superior cause. It is also used to express a certain unavoidable designation of things, by which all agents, both necessary and involuntary, are swayed and directed to their ends.
- FATES**, in mythology. See **PARCÆ**.
- FATHOM**, a long measure containing six feet, used chiefly at sea for measuring the length of cables and cordage.
- FATUUS IGNIS**, in physiology, a meteor otherwise called Will-with-a-wisp. See **WILL**.
- FAVIFORM**, in general, something resembling a honey-comb. Surgeons give this appellation to certain ulcers, which emit a sanies through little holes, especially in the head.
- FAVISSÆ**, in antiquity, were, according to Festus and Gellius, cisterns to keep water in: but the faviæ in the Capitol at Rome were dry cisterns or subterraneous cellars, where they laid up the old statues, broken vessels, and other things used in the temple. These were much the same with what, in some of the modern churches, are called the archives and treasury.
- FAUNALIA**, in Roman antiquity, three annual festivals in honour of the god Faunus; the first of which was observed on the ides of February, the second on the 16th of the calends of March, and the third on the nones of December. The principal sacrifices on this occasion were lambs and kids. Faunus was a deity of the Romans only, being wholly unknown to the Greeks.
- FAUNS**, a kind of rural deities, among the ancient Romans, represented with horns on their heads, sharp-pointed ears, and the rest of their bodies like goats.
- FAWN**, among sportsmen, a buck or doe of the first year; or the young one of the buck's breed in its first year.
- FE**, or **St FE**, the capital of New Mexico: W. long. 100°, N. lat. 36°.
- St FE de bogota**, the capital of the kingdom of New Granada: W. long. 73°, N. lat. 4°. It is an archbishoprick and the seat of the governor of the province, &c.
- St FE** is also a town of Spain, in the province of Granada, situated on the river Xcmil: W. long. 3° 45', N. lat. 37° 20'.
- St FE** is also the capital of a province of the same name, in Terra Firma in South America, situated on the river of St Martha, 200 miles south of Carthage: W. long. 77°, N. lat. 7° 25'.
- FEALTY**, in law, an oath taken on the admittance of any tenant, to be true to the lord of whom he holds his land.
- FEAST**, or **FESTIVAL**, in a religious sense, is a day of feasting and thanksgiving.
- Among the ancients, feasts were instituted upon various accounts, but especially in memory of some favourable interposition of Providence. Thus, the Jews had their feast of passover, pentecost, and tabernacles; the Greeks their cerealia, panathenæa, &c. and the Romans their saturnalia, ambarvalia, &c. See **PASSOVER**, **CEREALIA**, &c.
- FEATHER**, in physiology, a general name for the covering of birds; it being common to all the animals of this class to have their whole body, or at least the greatest part of it, covered with feathers or plumage.
- FEBRIFUGE**, in medicine, an appellation given to such medicines as mitigate, or remove a fever.
- FEBRIS**, **FEVER**, in medicine. See **FEVER**.
- FEBRUARY**, in chronology, the second month of the year, reckoning from January, first added to the calendar of Romulus by Numa Pompilius.
- February derives its name from Februa, a feast held by the Romans in this month, in behalf of the manes of the deceased; at which ceremony sacrifices were performed, and the last offices were paid to the shades of the defunct.
- February, in a common year, consists only of twenty-eight days; but in the bissextile year, it has twenty-nine, on account of the intercalary day, added that year.
- FECLALES**, or **FOECIALES**, a college of priests instituted at Rome by Numa, consisting of twenty persons, selected out of the best families. Their business was to be arbitrators of all matters relating to war and peace, and to be the guardians of the public faith.
- FEF**, in Scots law, signifies a complete feudal property. See **SCOTS LAW**, title 10. Hence, where the bare liferent of any feudal subject is meant to be conveyed to A, and the absolute property to B; that meaning is expressed thus, to A in liferent, and to B in fee.
- FEELERS**, in natural history, a name used by some for the horns of insects.
- FEELING**, one of the five external senses, by which we obtain the ideas of solid, hard, soft, rough, hot, cold, wet, dry, and other tangible qualities.
- FEINT**, in fencing, a shew of making a thrust at one



*Fig. 1.* FELIS LEO  
OR  
LION



*Fig. 2.* FELIS TIGRIS  
OR  
TIGER



part, in order to deceive the enemy, that you may really strike him in another.

A simple feint is a mere motion of the wrist, without stirring the foot.

**FELAPTON**, in logic, one of the six first modes of the third figure of syllogisms; whereof the first proposition is an universal negative, the second an universal affirmative, and the third a particular negative.

**FELIN**, a town of Livonia, about an hundred miles north-east of Riga.

**FELIS**, the **CAT**, a genus of quadrupeds belonging to the order of feræ, the characters of which are these: The fore teeth are equal; the molars or grinders have three points; the tongue is furnished with rough sharp prickles, and pointing backwards; and the claws are sheathed, and retractile. This genus comprehends seven genera, viz.

1. The **LEO**, or **LION**. The largest lions are from eight to nine feet in length, and from four to eight feet high: those of a smaller size are generally about  $5\frac{1}{2}$  feet long, and about  $3\frac{1}{2}$  high. His head is very thick, and his face is beset on all sides with long bushy yellowish hair; this shaggy hair extends from the top of the head to below the shoulders, and hangs down to his knees: the belly and breast are likewise covered with long hair. The rest of the body is covered with very short hair, excepting a bush at the point of the tail. The ears are roundish, short, and almost entirely concealed under the hair of his front. The shaginess of the fore-part of his body makes the hinder part have a naked appearance. The tail is long and very strong; the legs are thick and fleshy; and the feet are short; the length of the claws is about an inch and a quarter, are of a whitish colour, very crooked, and can be extended or retracted into the membranous sheath at pleasure: Their points are seldom blunted, as they are never extended but when he seizes his prey.

The female, or lioness, has no mane, or long hair about her head or shoulders; in her we see distinctly the whole face, head, ears, neck, shoulders, breast, &c. all these parts being in some measure concealed under the long hair of the male, give the female a very different appearance: besides, she is considerably less than the male. The hair of both male and female is of a yellowish colour, and whitish on the sides and belly.

In warm countries, quadrupeds in general are larger and stronger than in the cold or temperate climates. They are likewise more fierce and hardy; all their natural qualities seem to correspond with the ardour of the climate. The lions nourished under the scorching sun of Africa or the Indies, are the most strong, fierce, and terrible. Those of mount Atlas, whose top is sometimes covered with snow, are neither so strong or so ferocious as those of Biledulgerid or Zaara, whose plains are covered with burning sand. It is in these hot and barren deserts, that the lion is the dread of travellers, and the scourge of the neighbouring provinces. But it is a happy circumstance that the species is not very numerous: they even appear to diminish daily. The Romans, says Mr Shaw, brought

many more lions out of Lybia for their public shows, than are now to be found in that country. It is likewise remarked, that the lions in Turkey, Persia, and the Indies are less numerous than formerly. As this formidable and courageous animal makes a prey of most other animals, and is himself a prey to none, this diminution in the number of the species can be owing to nothing but an increase in the number of mankind: for it must be acknowledged, that the strength of this king of animals is not a match for the dexterity and address of a Negro or Hottentot, who will often dare to attack him face to face, and with very slight weapons.

The ingenuity of mankind augments with their number; that of other animals continues always the same. All the noxious animals, as the lion, are reduced to a small number, not only because mankind are become more numerous, but likewise because they have become more ingenious, and have invented weapons which nothing can resist. This superiority in the numbers and industry of mankind, at the same time that it has broke the vigour of the lion, seems likewise to have enervated his courage. This quality, though natural, is exalted or lowered according to the good or bad success with which any animal has been accustomed to employ his force. In the vast deserts of Zaara; in those which seem to separate two very different races of men, the Negroes and Moors, between Senegal and the boundaries of Mauritania; in those uninhabited regions above the country of the Hottentots; and, in general, in all the meridional parts of Africa and Asia, where mankind have disdained to dwell, lions are still as numerous, and as ferocious as ever. Accustomed to measure their strength by that of all other animals which they encounter, the habit of conquering renders them haughty and intrepid. Having never experienced the strength of man, or the power of his arms, instead of discovering any signs of fear, they disdain and set him at defiance. Wounds irritate, but do not terrify them: they are not even disconcerted at the sight of numbers. A single lion of the Desert has been known to attack a whole caravan; and if, after a violent and obstinate engagement, he found himself weakened, he retreats fighting, always keeping his face to the enemy. On the other hand, the lions which live near the villages or huts of the Indians or Africans, being acquainted with man and the force of his arms, are so dastardly as to fly and leave their prey at the sight of women or children.

This softening in the temper and disposition of the lion, shows that he is capable of culture, and susceptible, at least to a certain degree, of the impressions that he receives: accordingly, history informs us of lions yoked in triumphal chariots, trained to war, or the chase; and that, faithful to their masters, they never employed their strength or courage but against their enemies. It is, however, certain, that a lion taken young and brought up among domestic animals, will easily be accustomed to live and sport with them; that he is mild and careless to his master, especially when he is young; and that, if his natural ferocity sometimes breaks out, it

is rarely turned against those who have been kind to him. But, as his passions are impetuous and vehement, it is not to be expected that the impressions of education will at all times be sufficient to balance them: for this reason it is dangerous to let him suffer hunger long, or to vex him by ill-timed teazings: bad treatment not only irritates him, but he remembers it long, and meditates revenge. On the other hand, he is exceedingly grateful, and seldom forgets benefits received. He has been often observed to disdain weak or insignificant enemies, to despise their insults, and to pardon their offensive liberties. When led into captivity, he will discover symptoms of uneasiness, without anger or peevishness: on the contrary, his natural temper softens, he obeys his master, caresses the hand that gives him food, and sometimes gives life to such animals as are thrown to him alive for prey; by this act of generosity he seems to consider himself as for ever bound to protect them; he lives peaceably with them, allows them a part, and sometimes the whole of his food, and will rather submit to the pangs of hunger than fill his stomach with the fruit of his beneficence. We may likewise observe, that the lion is not a cruel animal; he kills rather from necessity than choice, never destroying more than he eats, and whenever his appetite is satisfied he is mild and peaceable.

The aspect of the lion does not detract from the noble and generous qualities of his mind. His figure is respectable; his looks are determined; his gait is stately; and his voice is tremendous. In a word, the body of the lion appears to be the best model of strength joined to agility. The force of his muscles is expressed by his prodigious leaps and bounds, often 20 feet at once; by the brisk motion of his tail, a single sweep of which is sufficient to throw a man to the ground; by the ease with which he moves the skin of his face, and particularly of his forehead; and, lastly, by the faculty of erecting and agitating the hair of his mane when irritated.

Lions are very ardent in their amours: when the female is in season, she is often followed by eight or ten males, who roar incessantly, and enter into furious engagements, till one of them completely overcomes the rest, takes peaceable possession of the female, and carries her off to some secret recess. The lioness brings forth her young in the spring, and produces but once every year.

All the passions of the lion, the soft passion of love not excepted, are excessive; the love of offspring is extreme: the lioness is naturally weaker, less bold, and more gentle than the lion; but she becomes perfectly rapacious and terrible when she has young. Then she exhibits more courage than the male; she knows no danger; she attacks indifferently men and all other animals, kills them, and carries them to her young ones, whom she thus early instructs to suck their blood and tear their flesh. She generally brings forth in the most secret and inaccessible places; and, when afraid of a discovery, she endeavours to conceal the traces of her feet, by returning frequently on her steps, or rather by effacing them with her tail; and, when the danger is great, she carries off her young and conceals them some where else. But, when an actual attempt is made to deprive her of her young, she becomes

perfectly furious, and defends them till she be torn to pieces.

The lion seldom goes abroad in the middle of the day; he goes round in the evening and night, in quest of prey. He is afraid of fire, never approaches the artificial fires made by the shepherds for the protection of their flocks; he does not trace other animals by the scent, but is obliged to trust to his eyes. Many historians have even misrepresented him as incapable of finding out his prey; but that he is obliged to the jackal, an animal of exquisite scent, in order to provide for him, and that this animal either accompanies or goes before him for this purpose. The jackal is a native of Arabia, Lybia, &c. and, like the lion, lives upon prey; perhaps sometimes he follows the lion, but it is with a view to pick up what he leaves behind, not to provide for him; for, being a small and feeble animal, he ought rather to fly than to serve the lion.

The lion, when hungry, will attack any animal that presents itself: but he is so very formidable, that all endeavour to avoid his rencounter; this circumstance often obliges him to conceal himself, and lie in wait till some animal chances to pass. He lies squat on his belly in a thicket; from which he springs with such force and velocity, that he often seizes them at the first bound. He endures hunger longer than thirst; he seldom passes water without drinking, which he does by lapping like a dog. For his ordinary subsistence, he requires about 15 pounds of raw flesh each day.

The roaring of the lion is so strong and loud, that it resembles the rumbling of distant thunder. His roaring is his ordinary voice: but when he is irritated, his cry is shorter, repeated more suddenly, and is still more terrible than the roaring: besides he beats his sides with his tail, stamps with his feet, erects and agitates the hair of his head and mane, moves the skin of his face, shows his angry teeth, and lolls out his tongue.

The gait of the lion is stately, grave, and slow, though always in an oblique direction. His movements are not equal or measured, but consist of leaps and bounds; which prevents him from stopping suddenly, and makes him often over-leap his mark. When he leaps upon his prey, he makes a bound of 12 or 15 feet, falls above it, seizes it with his fore-feet, tears the flesh with his claws, and then devours it with his teeth.

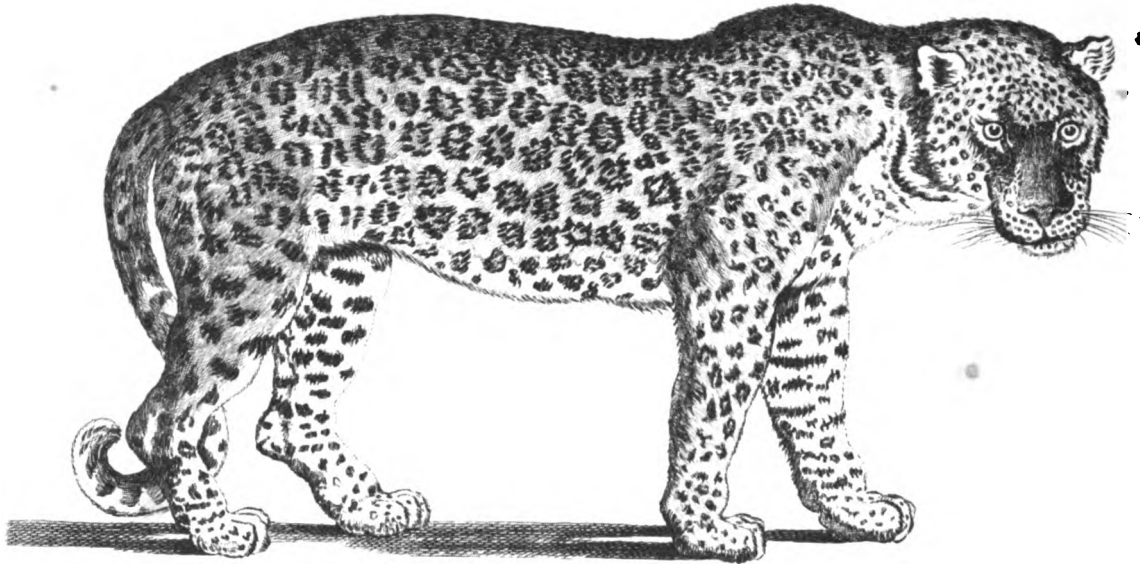
The lion, however terrible, is hunted by large dogs, well supported by men on horseback: they dislodge him, and oblige him to retire. But it is necessary that both the dogs and horses be trained before-hand; for almost every animal frets and flies as soon as he feels the very smell of a lion. His skin, although hard and firm, does not resist either a ball or a javelin: however, he is seldom killed by a single stroke; and is more frequently taken by address than force. They put a live animal above a deep pit covered with light substances, and thus decoy him into the snare.

2. The TIGER The size of this animal, according to some authors, is larger, and, according to others, somewhat less than the lion. M. de la Landemagon assures us, that he has seen a tiger in the East-Indies 15 feet long, including undoubtedly the length of the

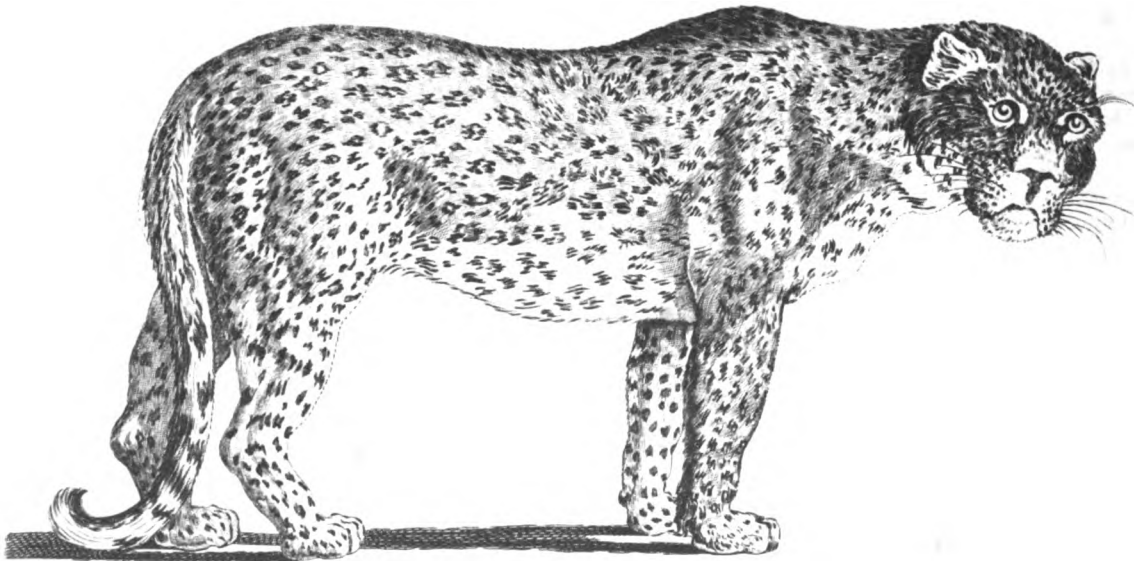




*Fig. 1.* FELIS PARDUS or  
PANTHER



*Fig. 2.* FELIS LEOPARDUS or  
LEOPARD



the tail, which, supposing it to be four feet, makes the body of the tiger about 10 feet in length. The skeleton preserved in the cabinet of the French king, indicates that the animal was about 7 feet long from the point of the muzzle to the origin of the tail; but then it must be considered that he was caught young, and lived all his days in confinement. The head of the tiger is large and roundish; and the ears are short, and at a great distance from each other. The form of the body has a great resemblance to that of the panther. The skin is of a darkish yellow colour, striped with long black streaks; the hair is short, excepting on the sides of the head, where it is about four inches long. The point of the tail is black, and the rest of it is interspersed with black rings. His legs and claws resemble those of the lion, only the legs are much shorter in proportion to the size of the animal.

The tiger is more ferocious, cruel, and savage than the lion. Although gorged with carnage, his thirst for blood is not appeased; he seizes and tears in pieces a new prey with equal fury and rapacity, the very moment after devouring a former one; he lays waste the country he inhabits; he neither dreads the aspect nor the weapons of men; puts to death whole troops of domestic animals; and attacks young elephants, rhinoceros's, and sometimes even braves the lion himself. The tiger seems to have no other instinct but a constant thirst after blood, a blind fury which knows no bounds or distinction, and which often stimulates him to devour his own young, and to tear the mother in pieces for endeavouring to defend them. He lies in wait at the banks of rivers, &c. where the heat of the climate obliges the other animals to repair for drink. Here he seizes his prey, or rather multiplies his massacres: for he no sooner kills one animal, than he flies with equal fury upon the next, with no other view but to plunge in his head into their bodies and drink their blood. However, when he kills a large animal, as a horse or a buffalo, he sometimes does not tear out the entrails on the spot; but, to prevent any interruption, he drags them off to the wood, which he executes with incredible swiftness. This is a sufficient specimen of the strength of this rapacious animal.

Neither force, restraint, or violence can tame the tiger. He is equally irritated with good as with bad treatment: he tears the hand which nourishes him with equal fury as that which administers blows: he roars, and is enraged at the sight of every living creature. Almost every natural historian agrees in this horrible character. When viewing the beautiful tiger which is at present exhibiting in the city of Edinburgh, we at first suspected that his character was not so bad or ferocious as represented by historians: he allowed the keeper not only to come near him, but to stroke his head and take his paw in his hand. However, this appeared to be only a forced complaisance; he was chained so close to the floor, that he had only just room to stand: he snarled and roared when his master troubled him more than he inclined; and, upon throwing him a piece of flesh, his eyes instantly sparkled with rage; he put himself in a posture of defence, set up the most horrible roarings, and made several bounds to get at the keeper as well as the spectators.

It is happy for other animals, that the species of the tiger is not numerous, and that they are confined to the warm climates. They are found in Malabar, Siam, Bengal, the interior parts of Africa, and, in general, in all the regions that are inhabited by the elephant and rhinoceros.

The tiger has always been a more rare animal than the lion, and yet brings forth an equal number of young, namely, four or five at a litter. The female is furious at all times; but, when her young are attempted to be taken from her, her rage is redoubled: she braves every danger; she pursues the ravishers, who are obliged, when hard pressed, to drop one of the young in order to retard her motion; she stops, takes it up, and carries it into some secret part of the forest; but she instantly returns and pursues the hunters into their villages or boats.

The tiger moves the skin of his face, grinds his teeth, and roars, like the lion; but the sound of his voice is different.

3. The PANTHER.—It is about the size of a large dog, and has a great resemblance to a domestic cat. The tongue is rough and remarkably red; the teeth are strong and sharp; the skin is exceedingly beautiful, being of a yellow colour, variegated with roundish black spots, and the hair is short.

The panther has a cruel and ferocious aspect; his motions are brisk and lively; his cry resembles that of an enraged dog, but more strong and rough. He is not so perfectly ungovernable as the tiger: but, notwithstanding all attempts to render him obedient and tractable, he may rather be said to be subdued than tamed; for he never entirely loses his natural ferocity. Accordingly, when kept with a view to hunting bucks, goats, or other animals, great care is necessary in training him, and still greater in conducting him. When leading out to the field, they put him in a cage and carry him on a cart. When the game is sprung, they open the door of the cage; he instantly springs towards the animal, often seizes him in a few bounds, throws him to the ground, and strangles him. But, if he happens to miss his aim, he becomes mad with rage, and sometimes falls upon his master, who, in order to prevent accidents of this kind, generally carries along with him pieces of flesh, or perhaps a lamb or a kid, which he throws to him in order to appease his fury.

The panther is no where to be found but in Africa, and the regions of the Indies.

4. The ONCA or ONCE, is less than the panther; the tail is longer; the hair is likewise longer, and of a whitish grey colour. The once is easily tamed; and is employed in hunting in several parts of Asia, where dogs are very scarce. He has not the delicate scent of a dog; does not trace other animals by the smell; neither can he run them down in a fair chase; but lies in wait for their approach, and then darts upon them unawares. He leaps so nimbly, that he easily clears a ditch or a wall several feet high: besides, he often climbs trees, waits till some animal passes, and instantly leaps down upon them. This method of catching their prey, is practised by the panther and leopard, as well as the once.

5. The LEOPARD differs from the panther and the once in the beauty of his colour, which is a lively yellow, with smaller spots than those of the two latter, and

disposed in groups. He is larger than the once, and is than the panther. The manners and disposition of the leopard are nearly the same with those of the panther. He is never tamed or employed in hunting. The panther, once, and leopard, are inhabitants of Africa and the warmer regions of Asia. In general, these animals delight in thick forests, and frequent the banks of rivers, and the neighbourhood of solitary villages, where they lie in wait to surprize domestic animals and the wild beasts that come in quest of water. They seldom attack men, even when provoked. With regard to their skins, they are all valuable, and make excellent furs.

6. The **LYNX** is about 2½ feet long and 15 inches high. He has a great resemblance to the cat; but his ears are longer, and his tail is much shorter; his hair is streaked with yellow, white, and black colours. The lynx is an inhabitant of Muscovy, Poland, Canada, &c. his eyes are brilliant, his aspect is soft, and his air is gay and sprightly; like the cat, he covers his urine with earth; he howls something like the wolf, and is heard at a considerable distance; he does not run like the dog or wolf, but walks and leaps like a cat; he pursues his prey even to the tops of trees; neither wild-cats nor squirrels can escape him; he lies in wait for stags, goats, hares, &c. and darts suddenly upon them; he seizes them by the throat and sucks their blood, then opens the head and eats the brain; after this, he frequently leaves them and goes in quest of fresh prey; the colour of his skin changes according to the season or the climate; the winter furs are more beautiful than those of summer.

7. The **CAT**, is a well-known domestic animal, and therefore requires no particular description. The wild-cat, the cat of Angora, &c. differ only in the length of their hair, and some small varieties arising from climate and their manner of living.

Of all domestic animals, the character of the cat is the most equivocal and suspicious. He is kept, not for any amiable qualities, but purely with a view to banish rats, mice, and other noxious animals from our houses, granaries, &c. Although cats, when young, are playful and gay, they possess at the same time an innate malice and perverse disposition, which increases as they grow up, and which education learns them to conceal, but never to subdue. Constantly bent upon theft and rapine, though in a domestic state, they are full of cunning and dissimulation; they conceal all their designs; seize every opportunity of doing mischief, and then fly from punishment. They easily take on the habits of society, but never its manners: for they have only the appearance of friendship and attachment. This dissingenuity of character is betrayed by the obliquity of their movements, and the ambiguity of their looks. In a word, the cat is totally destitute of friendship; he thinks and acts for himself alone. He loves ease, searches for the softest and warmest places to repose himself. The cat is likewise extremely amorous; and, which is very singular, the female is more ardent than the male; she not only invites, but searches after and calls upon him to satisfy the fury of her desires; and, if the male disdains or flies from her, she pursues, bites, and in a manner compels him. This heat of passion in females lasts but nine or ten days, and hap-

pens twice in the year, namely in the spring and autumn; however, in some it happens thrice or four times in the year. The female goes with young 55 or 56 days, and generally produces four or five at a litter. As the male has an inclination to destroy the young, the female takes care to conceal them from him; and, when she is apprehensive of a discovery, she takes them up in her mouth one by one, and hides them in holes or inaccessible places. When she has nursed a few weeks, she brings them mice, small birds, &c. in order to learn them to eat flesh. But, it is worth notice, that these careful and tender mothers sometimes become unnaturally cruel, and devour their own offspring.

The cat is incapable of restraint, and consequently of being educated to any extent. However, we are told, that the Greeks in the island of Cyprus trained this animal to catch and devour serpents, with which that island was greatly infested. This however was not the effect of obedience, but of a general taste for slaughter; for he delights in watching, attacking, and destroying all kinds of weak animals indifferently. He has no delicacy of scent, like the dog; he hunts only by the eye: neither does he properly pursue; he only lies in wait, and attacks animals by surprize: and after he has caught them, he sports with and torments them a long time, and at last kills them (when his belly is full) purely to gratify his sanguinary appetite.

The eye of the cat differs greatly from that of most other animals. The pupil is capable of a great degree of contraction and dilatation; it is narrow and contracted like a line during the day, round and wide in the dark; it is from this conformation of the eye that the cat sees best in the night, which gives him a great advantage in discovering and seizing his prey.

Although cats live in our houses, they can hardly be called domestic animals; they may rather be said to enjoy full liberty; for they never act but according to their own inclination. Besides, the greatest part of them are half wild; they do not know their masters, and frequent only the barns, out-houses, &c. unless when pressed with hunger.

Cats have a natural antipathy at water, cold, and bad smells. They love to bask in the sun, and lie in warm places. They likewise have an affection for certain aromatic smells; they are transported with the root of the valerian.

Cats take about eighteen months before they come to their full growth; but they are capable of propagation in twelve months, and retain this faculty all their life, which generally extends to nine or ten years. They eat slowly, and are peculiarly fond of fishes. They drink frequently; their sleep is light; and they often assume the appearance of sleeping, when in reality they are meditating mischief. They walk softly, and without making any noise. As their hair is always dry, it easily gives out an electrical fire, which becomes visible when rubbed across in the dark. Their eyes likewise sparkle in the dark like diamonds.

The wild, or savage cat, couples with the domestic one, and is consequently the same species. It is not unusual for domestic cats, both male and female, when stimulated by love, to repair to the woods in quest of these savages.

Fig. 3. FESS



Fig. 4. FER DE FOUCHE TTE

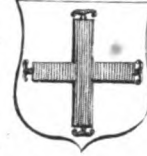


Fig. 6. FITCHEE



Fig. 7. FLORY



Fig. 8. FOURCHEE



Fig. 9. FRET



Fig. 10. FUSIL



Fig. 1. FELIS LINX

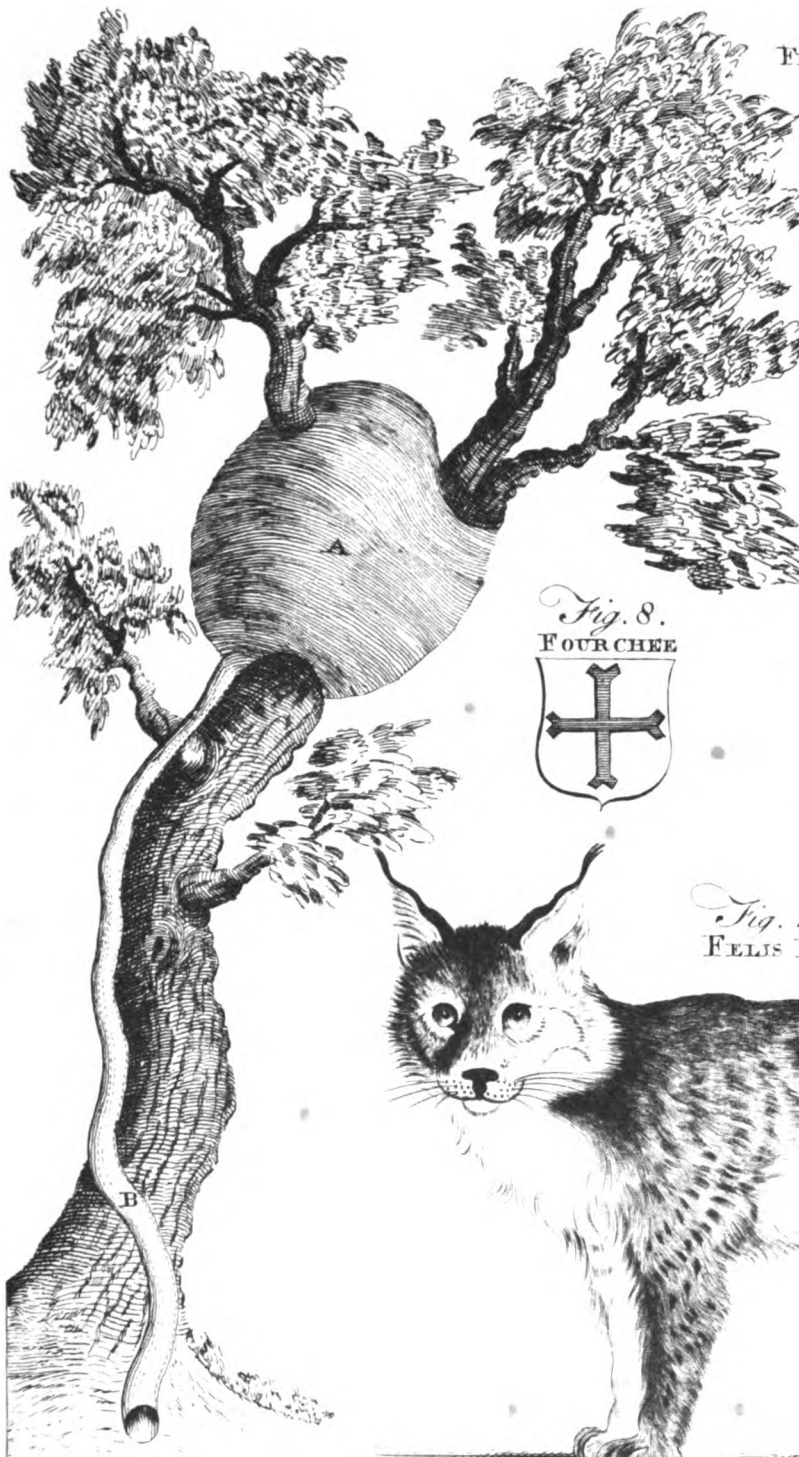
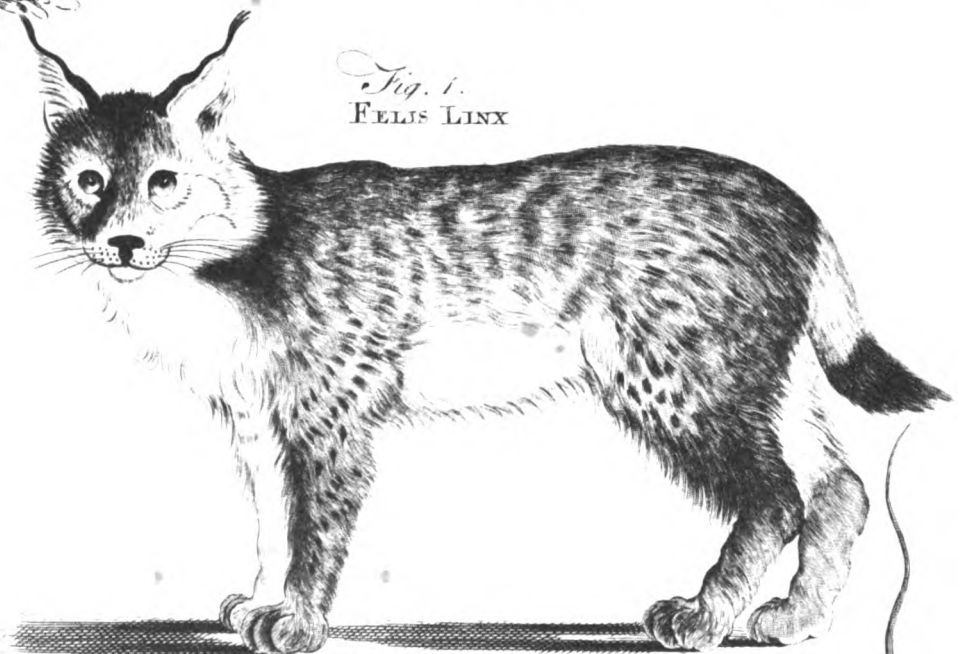


Fig. 3. FORMICA HERCULANEA or LARGEST ANT

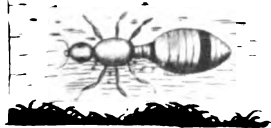


Fig. 2. FISTULAFIA TABACARIA or TOBACCO PIPE FISH



A Bell Sculptor



- vage cats. The only difference between them is, that the savage cat is stronger, larger, and more ferocious. The cat is a native of almost every country in the world; and all the varieties in their appearance may be reasonably enough attributed to the climates which produce them. See figures of the principal species of the *FELIS*, on Plate LXXVIII, LXXIX, and LXXX.
- FELKIRK**, a town of Austria, in Germany, thirty-five miles south-east of Constance.
- FELLOWSHIP, or COMPANY**, in arithmetic. See **ARITHMETIC**. p. 386.
- FELO DE SE**, in law, a person that lays deliberately violent hands on himself, and is the occasion of his untimely death, whether by hanging, drowning, stabbing, shooting, or any other way.
- FELON**, in law, a person guilty of felony. See **FELONY**.
- FELONY**, in law, a capital crime, next in degree to petit treason, and committed with an evil intention; such are murder, theft, suicide, sodomy, rape, &c.
- FELT**, in commerce, a sort of stuff deriving all its consistence merely from being fulled, or wrought with lees and size, without either spinning or weaving. Felt is made either of wool alone, or of wool and hair. Those of French make,  $3\frac{1}{2}$  yards long, and  $1\frac{1}{2}$  broad, for cloaks, pay each 2l. 14s. 17 $\frac{1}{2}$ d. on importation; and draw back 1l. 12s. 3d. on exporting them again.
- FELTRI**, a town of Italy, subject to Venice, thirty-five miles north of Padua.
- FELUCCA**, in sea-affairs, a little vessel with six oars, frequent in the Mediterranean, which has this peculiarity, that its helm may be applied either in the head or stern, as occasion requires.
- FEMALE**, a term peculiar to animals, signifying that sex which conceives and generates its young within itself.
- FEMININE**, in grammar, one of the genders of nouns. The feminine gender serves to intimate that the noun belongs to the female. In Latin, the femine gender is most commonly distinguished by the article *hec*, as it is in the Greek by  $\eta$ . In the French, the article *la* commonly denotes this gender; but we have no such distinction by articles in the English language.
- FEMUR, or FEMORIS**, in anatomy. See **ANATOMY**, p. 182.
- FEN**, a place overflowed with water, or abounding with bogs.
- FENCE**, in country-affairs, a hedge, wall, ditch, bank, or other inclosure, made around gardens, woods, corn-fields, &c. The chief reason why wood-lands and plantations so seldom prosper, is in a great measure owing to the neglect of fencing them round to keep out the cattle. This neglect prevails much in the northern parts of this island, though the use of fences is certainly more necessary there than in the south, as the lands require more shelter and warmth. There are several ways of fencing lands, but the usual is that of hedging it with either white or black thorn, crab, holly, alder, or furze, &c.
- FENCE MONTH**, the month wherein deer begin to fawn, during which it is unlawful to hunt in the forest. It commences fifteen days before mid-summer, and ends fifteen days after it. This month, by ancient foresters is called defence-month.
- FENCING**, the art of making a proper use of the sword, as well for attacking an enemy, as for defending one's self.
- FENNEL**, in botany. See **ANETHUM**.
- FEOD**, the same with fee. See **FEU**.
- FEODAL, and FEODATORY**. See **FEUDAL, and FEUDATORY**.
- FEOFFMENT**, in law, is a gift or grant of any manors, messuages, lands, or tenements, to another in fee; that is, to him and his heirs for ever, by delivery of - seisin, and possession of the estate granted.
- FERÆ**, in zoology, an order of quadrupeds, the distinguishing characters of which are, that all the animals belonging to it have six fore teeth in each jaw, and the canine, or dog-teeth, considerably long. Under this order are comprehended the following genera, *viz.* the phoca, canis, felis, viverra, mustela, urfus, didelphis, talpa, forex, and erinaceus. See **CANIS, FELIS, &c.**
- FERALIA**, in antiquity, a festival observed among the Romans on February 21st, or, according to Ovid, on the 17th of that month, in honour of the manes of their deceased friends and relations. During the ceremony, which consisted in making presents at their graves, marriages were forbidden, and the temples of the divinities shut up; because they fancied that, during this festival, the ghosts suffered no pains in hell, but were permitted to wander about their graves, and feast upon the meats prepared for them.
- FER DE FOURCHETTE**, in heraldry, a cross having at each end a forked iron, like that formerly used by soldiers to rest their musquets on. It differs from the cross fourché, the ends of which turn forked, whereas this has that sort of fork fixed upon the square end. See Plate LXXX. fig. 4.
- FER DE MOULIN, milrinde, inke de moulin**, in heraldry, is a bearing supposed to represent the iron-ink or ink of a mill, which sustains the moving mill-stone.
- FERDEN, or VERDEN**, a city of Germany, subject to Hanover; it is situated in lower Saxony, on the river Aller, twenty six miles south east of Bremen: E. lon. 9°, and N. lat. 53° 24'.
- FERENTARII**, in Roman antiquity, were auxiliary troops, lightly armed; their weapons being a sword, bow, arrows, and a sling.
- FERETINO**, a city and bishop's see of Italy, about fifty miles east of Rome: E. long. 14° 5', and N. lat. 41° 45'.
- FERIÆ**, in Roman antiquity, holidays, or days upon which they abstained from work. The Romans had two kinds of feriæ: 1. The public, common to all the people in general. 2. The private, which were only kept by some private families. The public feriæ were fourfold: 1. Stativæ feriæ, holidays which always fell out upon the same day of the

the month, and were marked in the calendar; of these the chief were the *agonalia*, *carmentalia*, and *Iupercalia*. 2. *Conceptivæ ferix*, holidays appointed every year upon certain or uncertain days by the magistrates or the pontiff; such were the *latinæ*, *paganalia*, *compitalia*, &c. See *PAGANALIA*, &c. 3. *Imperativæ ferix*, holidays commanded or appointed by the authority of the consuls or prætors; of this kind we may reckon the *lectisternium*. See *LECTISTERNIUM*. 4. *Nundinæ*, the days for fairs. See *NUNDINÆ*.

**FERIÆ LATINÆ** were instituted by Tarquinius Superbus, who having overcome the Tuscans, made a league with the Latins, and proposed to them to build a temple in common to Jupiter Latialis, in which both nations might meet, and offer sacrifice for their common safety. At this festival a white bull was sacrificed; and each town, both of the Latins and Romans, provided a certain quantity of meat, wine, and fruits. At first the solemnity continued but one day; after the expulsion of the kings, the senate added a third, a fourth, and so on to ten days.

**FERIA**, in the Romish breviary, is applied to the several days of the week; thus Monday is the *feria secunda*, Tuesday the *feria tertia*; though these days are not working days, but holidays. The occasion of this was, that the first Christians were used to keep the easter-week holy, calling Sunday the *prima feria*, &c. whence the term *feria* was given to the days of every week. But besides these, they have extraordinary *ferix*, viz. the three last days of passion-week, the two following easter-day, and the second *ferix* of rogation.

**FERMANACH**, a county of Ireland, in the province of Ulster, the chief town of which is Inniskilling.

**FERMENT**, any body which, being applied to another, produces fermentation.

Ferments are either matters already in the act of fermentation, or that soon run into this act. Of the first kind are the flowers of wine, yeast, fermenting beer, or fermenting wine, &c. and of the second are the new expressed vegetable juices of summer-fruit.

Among distillers, ferments are all those bodies which, when added to the liquor, only correct some fault therein, and, by removing some obstacle to fermentation, forward it by secondary means; as also such as, being added in time of fermentation, make the liquor yield a larger proportion of spirit, and give it a finer flavour.

**FERMENTATION**, may be defined a sensible internal motion of the constituent particles of a moist, fluid, mixt or compound body; by the continuance of which motion, these particles are gradually removed from their former situation or combination, and again, after some visible separation is made, joined together in a different order and arrangement. See *CHEMISTRY*.

P. 94.

**FERMO**, a port-town of Italy, situated on the gulf of Venice, about thirty miles south of Ancona. It is an archbishop's see.

**FERN**, *fliv*, in botany. See *FILIX*, *OSMUNDA*, *ACROSTICUM*, &c.

**FERNANDO**, or **FERNANDES**, an island in the Pacific ocean: W. long. 83°, S. lat. 33°.

**FERRARA**, a city and archbishop's see of Italy; E. long. 12° 6', N. lat. 44° 50'.

**FERRE**, or *le FERRE*, a city of Picardy, in France, forty miles south-east of Amiens: E. long. 3° 26', N. lat. 49° 45'.

**FERRET**, in zoology. See *MUSTELA*.

**FERRETS**, among glass-makers, the iron with which the workmen try the melted metal, to see if it be fit to work.

It is also used for those irons which make the rings at the mouth of bottles.

**FERRITTO**, in glass-making, a substance which serves to colour glass.

This is made by a simple calcination of copper, but it serves for several colours: there are two ways of making it, the first is this. Take thin plates of copper, and lay them on a layer of powdered brimstone, in the bottom of a crucible; over these lay more brimstone, and over that another lay of the plates, and so on alternately till the pot is full. Cover the pot, lute it well, place it in a wind furnace, and make a strong fire about it for two hours. When it is taken out and cooled, the copper will be found so calcined, that it may be crumbled to pieces between the fingers, like a friable earth. It will be of a reddish, and, in some parts, of a blackish colour. This must be powdered and sifted fine for use.

**FERRO**, W. long. 19°, N. lat. 28°, the most westerly of the Canary islands, near the African coast, where the first meridian was lately fixed in most maps; but now, the geographers of almost every kingdom make their respective capitals the first meridian, as we do London.

**FERRO**, some little islands situated in the northern ocean, 200 miles north-west of the Orcades, and as many south-east of Iceland: W. long. 7°, N. lat. 63°.

**FERROL**, a sea-port-town of Spain, in the principality of Galicia, situated on a bay of the Atlantic ocean, twenty miles north-east of the Groyne, and fifty miles north of Compostella, a good harbour, where the Spanish Squadrons frequently secured themselves in the late war: W. long. 8° 40', N. lat. 43° 30'.

**FERRUGINOUS**, any thing partaking of iron, or which contains particles of that metal.

**FERRUGO**, *RUST*. See *RUST*.

**FERRUM**, *IRON*. See *IRON*.

**FERRY**, a liberty by prescription, or the king's grant, to have a boat for passage, on a firth or river, for carrying passengers, horses, &c. over the same for a reasonable toll.

**FERTILITY**, that quality which denominates a thing fruitful or prolific.

**FERULA**, in botany, a genus of the pentandria digynia class. The fruit is oval, compressed, and has three furrows on each side. There are nine species, none of them natives of Britain.

FESSE



**FESSE**, in heraldry, one of the nine honourable ordinaries, consisting of a line drawn directly across the shield, from side to side, and containing the third part of it, between the honour-point and the nombril.

It represents a broad girdle or belt of honour, which knights at arms were anciently girded with. See Plate LXXX. fig. 5.

**FESSE POINT**, is the exact centre of the escutcheon. See **POINT**.

**FESSE-WAYS**, or *in fesse*, denotes any thing borne after the manner of a fesse; that is, in a rank across the middle of the shield.

*Party per fesse*, implies a parting across the middle of the shield, from side to side, through the fesse point.

**FESTI DIES**, in Roman antiquity, certain days in the year, devoted to the honour of the gods.

Numa, when he distributed the year into twelve months, divided the same into the dies festi, dies profesti, and dies intercesi.

The festi were again divided into days of sacrifices, banquets, games, and ferizæ. See **SACRIFICE**, **EPULÆ**, **LUDI**, and **FERIÆ**.

The profesti were those days allowed to men for the administration of their affairs, whether of a public or private nature: these were divided into fasti, comitiales, comperendini, stati, and præliares. See **FASTI**, **COMITIALES**, &c.

The intercesi were days common both to gods and men, some parts of which were allotted to the service of the one, and some to that of the other.

**FESTINO**, in logic, the third mood of the second figure of the syllogism, the first proposition whereof is an universal negative, the second a particular affirmative, and the third a particular negative: as in the following example:

FES No bad man can be happy,

TI Some rich men are bad men:

NO Ergo, some rich men are not happy.

**FESTIVAL**, the same with feast. See **FEAST**.

**FESTOON**, in architecture and sculpture, &c. an ornament in form of a garland of flowers, fruits and leaves, intermixed or twisted together.

**FESTUCA**, in botany, a genus of grasses, belonging to the triandria digynia class. The calix has two valves; and the spica is oblong and cylindrical. There are sixteen species, eleven of which are natives of Britain, viz. the ovina, or sheep's fescue-grass; the rubiufcula, or hard fescue-grass; the rubra, or purple fescue-grass; the bromoides, or barren fescue-grass; the myuros, or wall fescue-grass; the pratensis, or meadow fescue-grass; the elatior, or tall fescue-grass; the decumbens, or small fescue-grass; the fluitans, or flat fescue-grass; the loliacea, or spiked fescue-grass; and the sylvatica, or wood fescue-grass.

**FETIPOUR**, a city of the hither India, twenty-five miles west of Agra: E. long. 78° 40', N. lat. 27°.

**FETLOCK**, in the menage, a tuft of hair growing behind the pastern joint of many horses; for those of a low size have scarce any such tuft.

**FEUD**, the same with fee. See **FEE**.

**FEUDAL**, or **FODAL**, denotes any thing belonging to a fee. See **FEE**.

**FEUDATORY**, or **FODATORY**, a tenant who formerly held his estate by feudal service.

**FEU-DUTY**, in Scots law, is the annual rent or duty which a vassal, by the tenor of his right, becomes bound to pay to his superior. See **SCOTS LAW**, title 11.

**FEU-HOLDING**, in Scots law, is that particular tenor by which a vassal is taken bound to pay an annual rent or feu-duty to his superior. See **SCOTS LAW**, tit. 11.

**FEVER**, in medicine. See **MEDICINE**.

**FEVERFEW**, in botany. See **MATRICARIA**.

**FEVERSHAM**, a port-town of Kent, and one of the cinqueports. See **CINQUEPORT**.

It stands seven miles west of Canterbury.

**FEZ**, the capital of the empire of Fez and Morocco, in Africa: W. long 6°, N. lat. 33° 30'.

It is a large and populous city, and the usual residence of the emperor.

**FIAR**, in Scots law, the person vested in the feudal property of a subject. See **FEE**.

**FIASCONE**, a city and bishop's see of Italy, about twelve miles south of Orvieto.

**FIAT**, in law, a short order or warrant signed by a judge, for making out and allowing certain processes.

**FIBRARIÆ**, a class of fossils, naturally and essentially simple, not inflammable nor soluble in water, and composed of parallel fibres, some shorter, others longer; their external appearance being bright, and in some degree transparent: add to this, that they never give fire with steel, nor ferment with, or are soluble in acid menstrua.

**FIBRE**, in anatomy, a perfectly simple body, or at least as simple as any thing in the human structure; being fine and slender like a thread, and serving to form other parts. Hence some fibres are hard, as the bony ones; and others soft, as those destined for the formation of all the other parts.

The fibres are divided also, according to their situation, into such as are straight, oblique, transverse, annular, and spiral; being found arranged in all these directions, in different parts of the body.

**FIBROSE**, something consisting of fibres, as the roots of plants. See **ROOT**.

**FIBULA**, in anatomy. See **ANATOMY**, p. 184.

**FICARIA**, in botany. See **RANUNCULUS**.

**FICEDULA**, in ornithology. See **MOTACILLA**.

**FICOIDEA**, in botany. See **AIZOON**.

**FICOIDES**, a name given to several distinct plants, as the mesembryanthemum musa, and opuntia. See **MESEMBRYANTHEMUM**.

**FICTION**. See **FABLE**.

**FICUS**, the **FIG-TREE**, in botany, a genus of the polygamia polyœcia class. The common receptacle is turbinated, fleshy, and conceals the stozcules. The calix of the male consists of three segments; it has no corolla, but has three stamina: the calix of the female consists of five segments; it has no corolla, and but one pistil, and one seed. There are seven species, all of them natives of warm climates. The fruit of the fig-tree is a soft emollient sweet, and as such enters into several compositions.

- FIDA**, a town on the slave-coast of Guinea: E. long. 3°, N. lat. 6°.
- FIDD**, in the sea-language, an iron, or wooden pin, to splice and fasten ropes together.
- FIDD-HAMMER**, one whose handle is a fidd, or made taper-wife.
- FIDDLE**. See **VIOLIN**.
- FIDEL COMMISSUM**, in Roman antiquity, an estate left in trust with one person, for the use of another. See **TRUSTEE**.
- FIDICINALES**, muscles of the fingers. See **LUMBRICALES**.
- FIEF**, or **FEE**. See **FEE**.
- FIELD**, in agriculture, a piece of ground inclosed, whether for tillage or pasture.
- FIELD**, in heraldry, is the the whole surface of the shield, or the continent, so called because it containeth those achievements anciently acquired in the field of battle. It is the ground on which the colours, bearings, metals, furs, charges, &c. are represented. Among the modern heralds, field is less frequently used in blazoning than shield or escutcheon. See the article **SHIELD**, &c.
- FIELD BOOK**, in surveying, that wherein the angles, stations, distances, &c. are set down.
- FIELD-COLOURS**, in war. are small flags of about a foot and half square, which are carried along with the quarter-master general, for marking out the ground for the squadrons and battalions.
- FIELD-FARE**, in ornithology. See **TURDUS**.
- FIELD-OFFICERS**, in the art of war. See **OFFICER**.
- FIELD-PIECES**, small cannons, from three to twelve pounders, carried along with an army in the field.
- FIELD-STAFF**, a weapon carried by the gunners, about the length of a halbert, with a spear at the end; having on each side ears screwed on, like the cock of a match-lock, where the gunners screw in lighted matches, when they are upon command; and then the field-staffs are said to be armed.
- FIELD-WORKS**, in fortification, are those thrown up by an army in besieging a fortress, or by the besieged to defend the place. Such are the fortifications of camps, highways, &c.
- Elysian FIELDS**. See **ELYSIAN**.
- FERI FACIAS**, in law, a writ that lies where a person has recovered judgment for debt or damages in the king's courts against one, by which the sheriff is commanded to levy the debt and damages on the defendant's goods and chattels.
- FIFE**, in music, is a sort of wind-instrument, being a small pipe. See **PIPE**.
- FIFE**, in geography, a county of Scotland bounded by the Frith of Tay on the north; by the German sea on the east; by the Frith of Forth on the south; and by Montecoth and Stirling on the west.
- FIVE-RAILS**, in a ship, are those that are placed on banisters, on each side of the top of the poop, and so along with hances or falls.
- They reach down to the quarter-deck. and to the stair of the gang-way.
- FIFTH**, in music, one of the harmonical intervals or concords. See **MUSIC**.
- FIG**, or fig-tree. See **FIGUS**.
- FIGWORT**, a plant called by the botanists scrophularia. See **SCROPHULARIA**.
- FIGURAL**, **FIGURATE**, or **FIGURATIVE**, a term applied to whatever is expressed by obscure resemblances. The word is chiefly applied to the types and mysteries of the Mosaic law; as also to any expression which is not taken in its primary and literal sense.
- FIGURE**, in physics, expresses the surface or terminating extremities of any body.
- FIGURES**, in arithmetic, are certain characters whereby we denote any number which may be expressed by any combination of the nine digits, &c. See **ARITHMETIC**.
- FIGURE**, among divines, is used for the mysteries represented under certain types.
- FIGURE**, in dancing, denotes the several steps which the dancer makes in order and cadence, considered as they mark certain figures on the floor.
- FIGURE**, in painting and designing, denotes the lines and colours which form the representation of any animal, but more particularly of a human personage.
- FIGURE**, in composition. See **ALLEGORY**, **APOSTROPHE**, **HYPERBOLE**, **PERSONIFICATION**, &c.
- FIGURED**, in general, something marked with figures.
- The term figured is chiefly applied to stuffs, whereon the figures of flowers, and the like, are either wrought or stamped.
- FILAMENT**, in physiology and anatomy. See **FIBRE**.
- FILAMENT**, among botanists, is particularly used for the stamina. See **BOTANY**, Sect. II.
- FILBERT**, or **FILBERD**, the fruit of the corylus, or hazel. See **CORYLUS**.
- FILE**, among mechanics, a tool used in metal, &c. in order to smooth, polish, or cut.
- This instrument is of iron, or forged steel, cut in little furrows, with chisels and a mallet, this and that way, and of this or that depth, according to the grain or touch required. After cutting the file, it must be tempered with a composition of chimney soot, very hard and dry, diluted, and wrought up with urine, vinegar, and salt; the whole being reduced to the consistence of mustard. Tempering the files consists in rubbing them over with this composition, and covering them in loam; after which they are put in a charcoal fire, and taken out by that time they have acquired a cherry colour, which is known by a small rod of the same steel put in along with them. Being taken out of the fire, they are thrown into cold spring-water; and when cold, they are cleaned with charcoal and a rag; and being clean and dry, are kept from rust by lying them up in wheat bran. Iron files require more heating than steel ones. Files are of different forms, sizes, cuts, and degrees of fineness, according to the different uses and occasions for which they are made.
- FILE**, in the art of war, a row of soldiers, standing one behind another, which is the depth of the battalion

- or Squadron. The files of a battalion of foot are generally three deep; as are sometimes those of a Squadron of horse. The files must be straight, and parallel one to another.
- FILIGRANE**, or **FILIGREE-WORK**, any piece of gold or silver-work that is curiously done with grains or drops on the filaments or threads.
- FILIPENDULA**, in botany. See **SPURFA**.
- FILIX**, in botany, an order of the cryptogamia class of plants. See **BOTANY**, p. 636.
- FILLET**, in anatomy. See **FROENUM**.
- FILLET**, or **FILLET**, in architecture, a little square member, ornament, or moulding, used in divers places, and upon divers occasions, but generally as a crowning over a greater moulding.
- FILLET**, in heraldry, a kind of orle or bordure, containing only a third or fourth part of the breadth of the common bordure. It is supposed to be withdrawn inwards, and is of a different colour from the field. It runs quite round, near the edge, as a lace over a cloak.
- FILLET**, in the menage, the loins of an horse, which begin at the place where the hinder part of the saddle rests.
- FILLER HORSE**, one yoked immediately to a cart.
- FILLY**, a term among horse-dealers, to denote the female or mare-colt.
- FILM**, a thin skin or pellicle. In plants, it is used for that thin, woody skin, which separates the seeds in the pods, and keeps them apart.
- FILTER**, or **FILTRE**, in chemistry, a strainer commonly made of bibulous or filtering paper in the form of a funnel, through which any fluid is passed, in order to separate the gross particles from it, and render it limpid.
- FIMBRIÆ**, denotes appendages disposed by way of fringe round the border of any thing.
- FIMBRIATED**, in heraldry an ordinary with a narrow bordure or hem of another tincture.
- FIN**, in natural history, a well-known part of fishes, consisting of a membrane supported by rays, or little bony or cartilaginous ossicles.
- FINAL**, in general, whatever terminates or concludes a thing.
- FINAL LETTERS**, among Hebrew grammarians, five letters so called, because they have a different figure at the end of words from what they have in any other situation.
- FINAL**, in geography, a port town of Italy, subject to Genoa, and situated on the Mediterranean, about thirty-seven miles south-west of that city.
- FINANCES**. in the French polity, signify the revenues of the king and state.
- FINCH-KIND**, in ornithology, an appellation given to a genus of birds, known among authors by the name of *fringilla*. See **FRINGILLA**.
- FINE**. in law, has divers significations, it being sometimes taken for a sum of money advanced and paid for the income of lands. It is likewise used in another sense, where a sum is paid as an amends, or by way of punishment for an offence committed.
- FINERS of gold and silver**, are those who separate these metals from coarser ores. See **REFINERS**.
- FINERY**, in the iron works, one of the forges at which the iron is hammered and fashioned into what they call a bloom, or square bar.
- FINGERS**, in anatomy, the extreme part of the hand divided into five members. See **ANATOMY**, part I. and II.
- FINISTERRA**, the most westerly cape or promontory of Spain, in 10° 15' W. long. and 43° N. lat. This cape is likewise the most westerly part of the continent of Europe.
- FINITE**, something bounded or limited, in contradistinction to infinite. See **INFINITE**.
- FINLAND**, a province of Sweden, lying northward of the gulph of Finland, and eastward of the Bothnick gulph. It is a frontier province, bounded by Russia on the east.
- FIR-TREE**, in botany. See **PINUS**.
- FIRE**, a general name, by which men seem to understand a certain sensation or complex notion of light, heat, burning, melting, &c.
- The power of fire is so great, its effects so extensive, and the manner of its acting so wonderful, that some of the wisest nations of old revered and worshipped it, as the supreme deity. Some of the chemists also, after they had discovered its surprising operations, suspected it to be an uncreated being: and indeed the most famous of them have acknowledged it as the source of all their knowledge; and hence have professed themselves philosophers by fire, nor thought they could be honoured with a nobler title. Now, amongst all the wonderful properties of fire, there is none more extraordinary than this, that though it is the principal cause of almost all the sensible effects that continually fall under our observation, yet it is itself of so infinitely a subtle nature, that it eludes the most sagacious enquiries, nor ever comes within the cognizance of our senses. Fire is generally divided into three kinds or species, *viz.* celestial, subterraneous, and culinary.
- By celestial fire is principally understood that of the sun, without regard to that of the fixed stars, though this perhaps may be of the same nature.
- By subterraneous fire we understand that which manifests itself in fiery eruptions of the earth, volcanoes, or burning mountains; or by any other effects it produces in mines, or the more central parts of the earth.
- By culinary fire we mean that employed in all chemical operations, and the common occasions of life.
- The sun's heat appears to be the actuating principle, or general instrument of all the operations in the animal, vegetable, atmospherical, marine, and mineral kingdoms.
- Fire, considered in itself, seems to exist in the greatest purity and perfection in the celestial regions; at least we are insensible of any considerable smoke it yields:

yields : for the rays of light come to us from the sun, unmixed with any of that gross, feculent, or terrestrial matter, found in culinary and subterranean fires : but, allowing for this difference, the effects of the solar fire appear the same as those of culinary fire.

If we to examine the effects of subterraneous fires, we shall find them the same with those produced by culinary fire. Thus, burnt coals, cinders, and melted minerals, are thrown up by Vesuvius and other burning mountains. Warm nephritical exhalations, natural hot springs, steams, vapours, smoke, &c. are found in several parts of the globe, rising nearly in the same manner as if they were produced by the heat of a furnace. Whence it appears, that subterraneous fires are of the same nature with the culinary.

As men generally affix to the word fire, a complex idea of burning, light, heat, melting, &c. this idea should be analysed, in order to see what parts are essential, and what precarious or arbitrary.

We frequently find the effects of fire produced where no visible fire appeared. Thus the fingers are easily burnt by an iron heated below the degree of ignition, or so as to be no ways visibly red-hot or fiery : whence it follows, that the eye is no judge of fire.

So likewise the touch gives no positive notice of any degree of fire below the natural heat of the body, or any so great as to destroy the organ.

Again, the effects of fire are often produced without any manifest signs of burning, melting, &c. as in evaporations, &c. If this method of exclusion and rejection were pursued to its due length, we should perhaps find no criterion, infallible mark, or characteristic of fire in general, but that of a particular motion struggling among the minute parts of bodies, and tending to throw them off at the surface. If this should prove the case, then such a motion will be the form and essence of fire ; and which, being present, makes fire also present : and, when absent, makes fire also absent : whence to produce fire, and produce this motion in bodies, will be one and the same thing.

The great and fundamental difference in respect to the nature of fire is, whether it be originally such, formed thus by the Creator himself at the beginning of things ; or whether it be mechanically producible from other bodies, by inducing some alterations in the particles thereof. The former opinion is maintained by Homberg, Boerhaave, the younger Lemery, and s'Gravesande ; the latter is chiefly supported by the English philosophers, lord Bacon, Mr Boyle, and Sir Isaac Newton.

Bacon, in the treatise *De Forma Calicli*, deduces, from a great number of particulars, that heat in bodies is no other than motion so and so circumstanced ; so that to produce heat in a body, nothing is required but to excite a certain motion in the parts thereof.

Boyle seconds him in an express treatise of the mechanical origin of heat and cold, and maintains the same doctrine with new observations and experiments ; as a specimen of which, we shall hear give the two following.

1. In the production of heat, says that able philoso-

pher, there appears nothing on the part either of the agent or patient, but motion and its natural effects. When a smith briskly hammers a piece of iron, the metal thereby becomes exceedingly hot ; yet there is nothing to make it so, except the forcible motion of the hammer impressing a vehement and variously determined agitation on the small parts of the iron, which, being a cold body before, grows, by that super-induced commotion of its small parts, hot : first, in a more loose acceptation of the word, with regard to some other bodies, compared with which it was cold before ; then sensibly hot, because this agitation surpasses that of the points of our fingers ; and in this instance oftentimes the hammer and anvil continue cold after the operation ; which shews, that the heat acquired by the iron was not communicated by either of those implements, as heat ; but produced in it by a motion, great enough strongly to agitate the parts of so small a body as the piece of iron, without being able to have the like effect upon so much greater masses of metal as the hammer and the anvil : though if the percussions were often and briskly renewed, and the hammer were small, this also might be heated : whence it is not necessary that a body itself be hot to give heat.

2. If a large nail be driven by a hammer into a plank of wood, it will receive several strokes on its head before it grows hot ; but when it is once driven to the head, a few strokes suffice to give it a considerable heat ; for while, at every blow of the hammer, the nail enters further into the wood, the motion produced is chiefly progressive, and is of the whole nail tending one way ; but when that motion ceases, the impulse given by the stroke being unable to drive the nail further on, or break it, must be spent in making a various, vehement, and intestine commotion of the parts among themselves, wherein the nature of heat consists.

Agreeable to this is the opinion of Sir Isaac Newton, who conceives that gross bodies may be converted into light, by the agitation of their particles ; and light, again, into gross bodies, by being fixed therein.

On the other hand, M. Homberg, in his *Essai du Souffre Principe*, holds, that the chemical principle, or element sulphur, which is supposed one of the simple, primary, pre-existent ingredients of all natural bodies, is real fire, and consequently that fire is coeval with bodies.

Dr s'Gravesande goes on much the same principle : fire, according to him, enters the composition of all bodies, is contained in all bodies, and may be separated or procured from all bodies, by rubbing them against each other ; and thus putting their fire in motion : but fire, he adds, is by no means generated by such motion.

Mr Lemery, the younger, agrees with these two authors in asserting this absolute and ingenerable nature of fire : but he extends it farther. Not contented to confine it as an element to bodies, he endeavours to shew, that it is equally diffused through all space, and that it is present in all places ; in the void spaces between bodies, as well as in the insensible interstices between their parts.

This

This last sentiment falls in with that of Boerhaave and the celebrated M. Musschenbroek. But notwithstanding what those able philosophers have advanced, it is evident that fire, heat, flame, &c. are only the different modifications of the particles of light, and that the particles of light themselves depend entirely on velocity for their lucific quality; since, by many experiments, we know, that the particles of bodies become lucid, or particles of light, by only producing in them a requisite degree of velocity: thus the particles in a rod of iron, being hammered very nimbly, shine and become red-hot: thus also the violent stroke of the flint against the steel, in striking fire, puts the particles of the steel, which it takes off, into such a motion as causes them to melt, and become red-hot, which makes the sparks of fire produced by each stroke: as, therefore, fire consists in the great velocity of the particles, so it may be communicated from one body in which it is, to another in which it is not, after the same manner that one body in motion will communicate motion to another that has got none.

Fire differs from heat only in this, that heat is a motion in the particles of a body, with a lesser degree of velocity; and fire, a motion with a greater degree of velocity, viz. such as is sufficient to make the particles shine; though we often call such a state as will burn, *fire*, though it does not actually shine; and we seldom call those lucid bodies fires, which only shine, and do not burn. These are a sort of phosphori, which, though they have no heat, yet seem to owe their lucidity to the motion of their parts.

There seems to be no other difference between fire and flame, than this; that fire consists in a glowing degree of velocity in the parts of a body, while yet subsisting together in the mass; but flame is the same degree of velocity in the particles dissipated and flying off in vapours: or, to use Sir Isaac Newton's expression, flame is nothing else but a red-hot vapour. See FLAME.

**FIRE**, in chemistry. See CHEMISTRY, p. 67. and 110. Vol. II.

**Electrical FIRE**. See ELECTRICITY.

**Walking FIRE**, in meteorology. See WILL-WITH-A WHISP.

**FIRE**, in theology. See HELL.

We read of the sacred fire in the first temple of Jerusalem, concerning which the Jews have a tradition that it came down from heaven: it was kept with the utmost care, and it was forbidden to carry any strange fire into the temple. This fire is one of the five things which the Jews confess were wanting in the second temple.

The Pagans had their sacred fires, which they kept in their temples with the most religious care, and which were never to be extinguished. Numa was the first who built a temple to Fire as a goddess, at Rome, and instituted an order of priestesses for the preservation of it. See VESTALS.

Fire was the supreme god of the Chaldeans; the magi were worshippers of fire; and the Greeks and Armenians still keep up a ceremony called the *Ilyo*

Fire, upon a perfusion that every Easter-day a miraculous fire descends from heaven into the holy sepulchre, and kindles all the lamps and candles there.

**FIRE-LOCK**. See GUN, MUSQUET, &c.

**FIRE POTS**, in the military art, small earthen pots, into which is put a charged grenade, and over that powder enough till the grenade is covered; then the pot is covered with a piece of parchment, and two pieces of match across lighted: this pot being thrown by a handle of matches where it is designed, it breaks and fires the powder, and burns all that is near it, and likewise fires the powder in the grenade, which ought to have no fuse, to the end its operations may be the quicker.

**FIRE-WORKS**. See PYROTECHNIA.

**FIRE SHIP**, in the navy, a vessel charged with artificial fire-works, which having the wind of an enemy's ship, grapples her, and sets her on fire.

**FIRE-OFFICE**, an office of insurance from fire. See ASSURANCE.

**Wild-FIRE**, a kind of artificial or factitious fire, which burns even under water, and that with greater violence than out of it. It is composed of sulphur, naphtha, pitch, gum, and bitumen; and is only extinguishable by vinegar mixed with sand and urine, or by covering it with raw hides. Its motion or tendency is said to be contrary to that of natural fire, and it always follows the direction in which it is thrown, whether it be downwards, sideways, or otherwise.

**FIRING-IRON**, in farriery, an instrument not unlike the blade of a knife; which being made red-hot, is applied to a horse's hams, or other places standing in need of it, as in preternatural swellings, farcy, knots, &c. in order to discuss them.

**FIRKIN**, an English measure of capacity, for things liquid, being the fourth part of the barrel: it contains 8 gallons of ale, soap, or herrings; and 9 gallons of beer. See MEASURE and BARREL.

**FIRLOT**, a dry measure used in Scotland. The oat-firlot contains 21½ pints of that country; the wheat-firlot contains about 2211 cubical inches; and the barley-firlot, 31 standard pints. Hence it appears that the Scotch wheat-firlot exceeds the English bushel by 33 cubical inches.

**FIRMAMENT**, in the Ptolemaic astronomy, the eighth heaven or sphere, with respect to the seven spheres of the planets which it surrounds. It is supposed to have two motions; a diurnal motion, given to it by the primum mobile, from east to west, about the poles of the ecliptic; and another opposite motion from west to east; which last it finishes, according to Tycho, in 25412 years, according to Ptolemy in 36000, and according to Copernicus in 25800, in which time the fixed stars return to the same points in which they were at the beginning. This period is commonly called the Platonic year, or the great year.

**FIRMAMENT** is also used in divers places of scripture, to denote the middle region of the air.

**FIRMAN** is a passport or permit granted by the great mogul to foreign vessels, to trade within the territories of his jurisdiction.

**FIRMNESS**, denotes the consistence of a body, or that

state wherein its sensible parts cohere in such a manner, that the motion of one part induces a motion of the rest.

**FIRST-FRUITS**, among the Hebrews, were oblations of part of the fruit of the harvest, offered to God as an acknowledgment of his sovereign dominion.

**FIRST-FRUITS**, in the church of England, are the profits of every spiritual benefice for the first year, according to the valuation thereof in the king's books.

**FISC**, in the civil law, the treasury of a prince. It differs from the *ærarium*, which was the treasury of the public or people: thus, when the money arising from the sale of condemned persons goods was appropriated for the use of the public, their goods were said *publicari*; but when it was destined for the support of the prince, they were called *confiscari*.

**FISCAL**, in the civil law, something relating to the pecuniary interest of the prince or people. The officers appointed for the management of the fisc, were called *procuratores fisci*, and *advocati fisci*; and among the cases enumerated in the constitutions of the empire where it was their business to plead, one is against those who have been condemned to pay a fine to the fisc on account of their litigiousness, or frivolous appeals.

**FISH**, in natural history. See **NATURAL HISTORY**.

*Breeding of FISHES* may be turned to great advantage; for besides furnishing your table, obliging your friends, and raising money, your land will be thereby greatly improved, so as to yield more this way than by any other employment whatever.

When fish are fed in large pools or ponds, either malt boiled, or fresh grains, is the best food; thus carps may be raised and fed like capons, and tenches will feed as well. The care of feeding them is best committed to a gardener or the butler, who should be always at hand. In a stew, any sort of grain boiled, especially peas, and malt coarse ground; also the grains after brewing, while fresh and sweet: but one bushel of malt not brewed, will go as far as of grains. See **FISH-POND**, *infra*.

**FISH**, in a ship, a plank or piece of timber, fastened to a ship's mast or yard, to strengthen it, which is done by nailing it on with iron spikes, and waulding or winding ropes hard about them.

**FISHES**, in heraldry, are the emblems of silence and watchfulness; and are borne either upright, imbowed, extended, endorsed respecting each other, surmounting one another, fretted, &c.

In blazoning fishes, those borne feeding, should be termed devouring; all fishes borne upright and having fins, should be blazoned hauriant; and those borne transverse the escutcheon, must be termed naiant.

**FISH-PONDS**, those made for the breeding or feeding of fish.

Fish-ponds are no small improvement of watery and boggy lands, many of which are fit for no other use. In making of a pond, its head should be at the lowest part of the ground, that the trench of the flood-gate or sluice, having a good fall, may not be too long in emptying. The best way of making the head secure,

is to drive in two or three rows of flakes above six feet long, at about four feet distance from each other, the whole length of the pond-head, whereof the first row should be rammed at least about four feet deep. If the bottom is false, the foundation may be laid with quicklime; which slacking, will make it as hard as a stone. Some lay a layer of lime, and another of earth dug out of the pond, among the piles and strakes; and when these are well covered, drive in others as they see occasion, ramming in the earth as before, till the pond-head be of the height designed.

The dam should be made sloping on each side, leaving a waste to carry off the over-abundance of water in times of floods or rains; and as to the depth of the pond, the deepest part need not exceed six feet, rising gradually in shoals towards the sides, for the fish to sun themselves, and lay their spawn. Gravelly and sandy bottoms, especially the latter, are best for breeding; and a fat soil with a white fat water, as the washings of hills, commons, streets, sinks, &c. is best for fattening all sorts of fish. For storing a pond, carp is to be preferred for its goodness, quick growth, and great increase, as breeding five or six times a-year. A pond of an acre, if it be a feeding and not breeding one, will every year feed two hundred carps of three years old, three hundred of two years old, and four hundred of a year old. Carps delight in ponds that have marl or clay bottoms, with plenty of weeds and grass, whereon they feed in hot months.

Your pond should be drained every three or four years, and your fish sorted. If it is a breeding one, the smaller ones are to be taken out, to store other ponds with; leaving a good stock of females, at least eight or nine years old, as they never breed before that age. In feeding ponds, it is best to keep them pretty near of a size.

**FISHERY**, a place where great numbers of fish are caught.

The principal fisheries for salmon, herring, mackrel, pilchards, &c. are along the coasts of Scotland, England, and Ireland; for cod, on the banks of Newfoundland; for whales, about Greenland; and for pearls, in the East and West-Indies.

**FISHERY** denotes also the commerce of fish, more particularly the catching them for sale.

Were we to enter into a very minute and particular consideration of fisheries, as at present established in this kingdom, this article would swell beyond its proper bounds; because to do justice to a subject of that concernment to the British nation, requires a very ample and distinct discussion. We shall, however, observe, that since the Divine Providence has so eminently stored the coasts of Great Britain and Ireland with the most valuable fish; and since fisheries, if successful, become permanent nurseries for breeding expert seamen: it is not only a duty we owe to the Supreme Being, not to despise the wonderful plenty he hath afforded us, by neglecting to extend this branch of commerce to the utmost; but it is a duty we owe to our country, for its natural security, which depends upon the strength of our royal navy. No nation can have a navy, where there

there is not a fund of business to breed and employ seamen, without any expence to the public; and no trade is so well calculated for training up these useful members of this society, as fisheries.

The situation of the British coasts is the most advantageous for catching fish in the world: the Scottish islands, particularly those to the north; and west, lie most commodious for carrying on the fishing trade to perfection; for no country in Europe can pretend to come up to Scotland in the abundance of the finest fish, with which its various creeks, bays, rivers, lakes, and coast are replenished. King Charles I. was so sensible of the great advantage to be derived from fisheries, that he began the experiment, together with a company of merchants: but the civil wars soon occasioned that project to be set aside. King Charles II. made a like attempt; but his pressing wants made him withdraw what money he had employed that way, whereupon the merchants that joined with him did so too. Since the union, several attempts have been made to retrieve the fisheries, and a corporation settled to that effect, entitled the Royal British Fishery.

In the year 1750, the parliament of Great Britain taking the state of the fisheries into consideration, an act was passed for the encouragement of the white-herring fishery, granting a charter, whereby a corporation is created, to continue twenty one years, by the name of the Society of the Free British Fishery, to be under the direction of a governor, president, vice-president, council, &c. who are to continue in office the space of three years, with power to make bye-laws, &c. and to raise a capital of 500,000*l.* by way of subscription. And any number of persons, who, in any part of Great Britain, shall subscribe 10,000*l.* into the stock of this society, under the name of the Fishing Chamber, and carry on the said fishery on their own account of profit and loss, shall be entitled to the same bounty allowed to the society. The bounty is 30*s.* the tun, to be paid yearly, for fourteen years, besides 3 *per cent.* for the money advanced by each chamber. The act contains other proper regulations relative to the nets, marks on the herring-barrels, number of hands, and the quantity of salt that is entitled to the bounty, &c. It is then by the encouragement given by this act, that we now see a laudable emulation prevailing all over the two kingdoms, and fishing buffets fitted out from almost every port, in order to repair to the Shetland islands, where the herring-fishery is carried on with an ardor becoming so important a branch of trade. Scotland, which suffered incredibly from the neglect of this valuable and natural produce of the seas, has not been backward to join in a scheme that tends so evidently to its own advantage; for the cities of Edinburgh and Glasgow, the towns of Montrose, Dundee, Perth, Inverness, and some other boroughs, have raised the proper sum, and chambers have been erected in each of them; the gentlemen of estates adjoining to the respective places above-mentioned, liberally contributing with merchants, towards the prosecution of an undertaking so visibly tending to the good of their country in general.

*Cod-FISHERY.* There are two kinds of cod-fish, the one green or white cod, and the other dried or cured cod; though it is all the same fish differently prepared; the former being sometimes salted and barrelled, then taken out for use; and the latter, having lain some competent time in salt, dried in the sun or smoke. We shall therefore speak of each of these apart; and first of

*Green-cod FISHERY.* The chief fisheries for green cod are in the bay of Canada, on the great bank of Newfoundland, and on the isle of St Peter, and the isle of S ble, to which places vessels resort from divers parts both of Europe and America. They are from 100 to 150 tuns burden, and will catch between thirty and forty thousand cod each. The most essential part of the fishery is, to have a master who knows how to cut up the cod, one who is skilled to take off the head properly, and above all a good salter, on which the preserving of them, and consequently the success of the voyage, depends. The best season is from the beginning of February to the end of April; the fish, which in the winter retire to the deepest water, coming then on the banks, and fattening extremely. What is caught from March to June keeps well; but those taken in July, August, and September, when it is warm on the banks, are apt to spoil soon. Every fisher takes but one at a time: the most expert will take from 350 to 400 in a day; but that is the most, the weight of the fish and the great coldness on the bank fatiguing very much. As soon as the cod are taken, the head is taken off; they are opened, gutted, and salted; and the salter stows them in the bottom of the hold, head to tail, in beds a fathom or two square; laying layers of salt and fish alternately, but never mixing fish caught on different days. When they have lain thus three or four days to drain off the water, they are replaced in another part of the ship, and salted again; where they remain till the vessel is loaded. Sometimes they are cut in thick pieces, and put up in barrels for the conveniency of carriage.

*Dry-cod FISHERY.* The principal fishery for dry cod is, from Cape Rose to the Bay des Exports, along the coast of Placentia, in which compass there are divers commodious ports for the fish to be dried in. These, though of the same kind with the fresh cod, are much smaller, and therefore fitter to keep, as the salt penetrates more easily into them. The fishery of both is much alike; only this latter is most expensive, as it takes up more time, and employs more hands, and yet scarce half so much salt is spent in this as in the other. The bait is herrings, of which great quantities are taken on the coast of Placentia. When several vessels meet and intend to fish in the same port, he whose shallow first touches ground, becomes entitled to the quality and privileges of admiral: he has the choice of his station, and the refusal of all the wood on the coast at his arrival. As fast as the masters arrive, they unrig all their vessels, leaving nothing but the shrouds to sustain the masts, and in the mean time the mates provide a tent on shore, covered with branches of trees, and sails over them, with a scaffold of great trunks of pines, twelve, fifteen, sixteen, and often

often twenty feet high, commonly from forty to sixty feet long, and about one third as much in breadth. While the scaffold is preparing, the crew are a fishing; and as fast as they catch, they bring their fish ashore; open and salt them upon moveable benches; but the main salting is performed on the scaffold. When the fish have taken salt, they wash and hang them to drain on rails; when drained, they are laid on kinds of stages, which are small pieces of wood laid a-crofs, and covered with branches of trees, having the leaves stripped off for the passage of the air. On these stages, they are disposed, a fish thick, head against tail, with the back uppermost, and are turned carefully four times every twenty four hours. When they begin to dry, they are laid in heaps ten or twelve thick, in order to retain their warmth; and every day the heaps are enlarged, till they become double their first bulk; then two heaps are joined together, which they turn every day as before; lastly, they are salted again, beginning with those first salted; and being laid in huge piles, they remain in that situation till they are carried on board the ships, where they are laid on the branches of trees disposed for that purpose, upon the ballast, and round the ship, with mats to prevent their contracting any moisture.

There are four kinds of commodities drawn from cod, *viz.* the zounds, the tongues, the roes, and the oil extracted from the liver. The first is salted at the fishery, together with the fish, and put in barrels from 6 to 700 pound. The tongues are done in like manner, and brought in barrels from 4 to 500 pounds. The roes are also salted in barrels, and serve to cast into the sea to draw fish together, and particularly pilchards. The oil comes in barrels, from 400 to 520 pounds, and is used in dressing leather.—In Scotland, they catch a small kind of cod on the coasts of Buchan, and all along the Murra; frith on both sides; as also in the frith of Forth, Clyde, &c. which is much esteemed. They salt and dry them in the sun upon rocks, and sometimes in the chimney. They also cure skait, and other smaller fish in the same manner; but most of these are for home consumption.

*Coral-FISHERY.* See *CORAL-fishery.*

*Herring-FISHERY.* See *CLUPEA.*

*Pilchard-FISHERY.* The chief pilchard-fisheries are along the coasts of Dalmatia on the coast of Bretagne, and along the coasts of Cornwall and Devonshire. That of Dalmatia is very plentiful: that on the coasts of Bretagne employs annually about 300 ships. The pilchards caught on our coasts, though bigger, are not so much valued as those on the coasts of France, owing principally to their not being so thoroughly cured. They naturally follow the light, which contributes much to the facility of the fishery: the season is from June to September. On the coasts of France they make use of the roes of the cod-fish as a bait, which thrown into the sea, makes them rise from the bottom, and run into the nets. On our coasts there are persons posted ashore, who, spying by the colour of the water where the shoals are, make signs to the boats to go among them to cast their nets. When taken, they are brought

on shore to a warehouse, where they are laid up in broad piles, supported with backs and sides; and as they are piled, they salt them with bay-salt, in which lying to soak for thirty or forty days, they run out a deal of blood, with dirty pickle and bitter: then they wash them clean in sea-water; and, when dry, barrel and press them hard down to squeeze out the oil, which issues out at a hole in the bottom of the cask. The Cornishmen observe of the pilchard, that it is the least fish in size, most in number, and greatest for gain, of any they take out of the sea.

*Salmon-FISHERY.* The chief salmon-fisheries in Europe are in England, Scotland, and Ireland, in the rivers, and sea-coasts adjoining to the river-mouths. The most distinguished for salmon in Scotland are, the river Tweed, the Clyde, the Tay, the Dee, the Don, the Spey, the Nefs, the Bewley, &c. in most of which it is very common, about the height of summer, especially if the weather happen to be very hot, to catch four or five score of salmon at a draught. The chief rivers in England for salmon are, the Tyne, the Trent, the Severn, and the Thames. The fishing usually begins about January; and in Scotland they are obliged to give over about the middle of August; because, as it is then supposed the fish come up to spawn, it would be quite depopulating the rivers to continue fishing any longer. It is performed with nets, and sometimes with a kind of locks or wears made on purpose, which in certain places have iron or wooden grates so disposed, in an angle, that being impelled by any force in a contrary direction to the course of the river, they may give way and open a little at the point of contact, and immediately shut again, closing the angle. The salmon, therefore, coming up into the rivers, are admitted into these grates, which open, and suffer them to pass through, but shut again, and prevent their return. Salmon are also caught with a spear, which they dart into him when they see him swimming near the surface of the water. It is customary likewise to catch them with a candle and lanthorn, or wisp of straw set on fire; for the fish naturally following the light, are struck with the spear, or taken in a net spread for that purpose, and lifted with a sudden jerk from the bottom. We make no mention of the method of catching salmon with a line or hook, because it is much the same with that explained under the article *Trout-FISHING.*

*Curing Salmon.* When the salmon are taken, they open them along the back, take out the guts and gills, and cut out the greatest part of the bones, endeavouring to make the inside as smooth as possible; then salt the fish in large tubs for the purpose, where they lie a considerable time soaking in brine; and about October, they are packed close up in barrels, and sent to London, or exported up the Mediterranean. They have also in Scotland, a great deal of salmon salted in the common way, which after soaking in brine a competent time, is well pressed, and then dried in smoke: this is called *kipper*, and is chiefly made for home consumption, and, if properly cured and prepared, is reckoned very delicious.

*Sturgeon-*



**Sturgeon-FISHERY.** The greatest sturgeon-fishery is in the mouth of the Volga, on the Caspian sea, where the Muscovites employ a great number of hands, and catch them in a kind of inclosure formed by huge stakes representing the letter Z, repeated several times. These fisheries are open on the side next the sea, and close on the other; by which means the fish ascending in its season up the river, is embarrassed in these narrow angular retreats, and so is easily killed with a harpiron. Sturgeons, when fresh, eat deliciously; and in order to make them keep, they are salted or pickled in large pieces, and put up in cags from thirty to fifty pounds. But the great object of this fishery is the roe, of which the Muscovites are extremely fond, and of which is made the caviar, or kavia, so much esteemed by the Italians. See **CAVEAR**.

**Whale-FISHERY.** Whales are chiefly caught in the north sea: the largest fort are found about Greenland, or Spitzbergen. At the first discovery of this country, whales not being used to be disturbed, frequently came into the very bays, and were accordingly killed almost close to the shore, so that the blubber being cut off was immediately boiled into oil on the spot. The ships in these times took in nothing but the pure oil and the fins, and all the business was executed in the country, by which means a ship could bring home the product of many more whales than she can according to the present method of conducting this trade. The fishery also was then so plentiful, that they were obliged sometimes to send other ships to fetch off the oil they had made, the quantity being more than the fishing ships could bring away. But time and change of circumstances have shifted the situation of this trade. The ships coming in such numbers from Holland, Denmark, Hamburg, and other northern countries, all intruders upon the English, who were the first discoverers of Greenland, the whales were disturbed, and gradually, as other fish often do, forsaking the place, were not to be killed so near the shore as before; but are now found, and have been so ever since, in the openings and space among the ice, where they have deep water, and where they go sometimes a great many leagues from the shore.

The whale fishery begins in May, and continues all June and July; but whether the ships have good or bad success, they must come away, and get clear of the ice, by the end of August; so that in the month of September at farthest, they may be expected home; but a ship that meets with a fortunate and early fishery in May, may return in June or July.

The manner of taking whales at present is as follows. As soon as the fishermen hear the whale blow, they cry out, *Fall! fall!* and every ship gets out its long boat, in each of which there are six or seven men: they row till they come pretty near the whale, then the harpooner strikes it with his harpoon. This requires great dexterity; for through the bone of his head there is no striking, but near his spout there is a soft piece of flesh, into which the iron sinks with ease. As soon as he is struck, they take care to give him rope enough, otherwise, when he goes down, as he

frequently does, he would inevitably sink the boat: this rope he draws with such violence, that, if it were not well watered, it would, by its friction against the sides of the boat, be soon set on fire. The line fastened to the harpoon is six or seven fathom long, and is called the fore-runner; it is made of the finest and softest hemp, that it may slip the easier: to this they join a heap of lines of 90 or 100 fathoms each; and when there are not enough in one long boat, they borrow from another. The man at the helm observes which way the rope goes, and steers the boat accordingly, that it may run exactly out before; for the whale runs away with the line with so much rapidity, that he would overset the boat, if it were not kept straight. When the whale is struck, the other long boats row before, and observe which way the line stands, and sometimes pull it; if they feel it stiff, it is a sign the whale still pulls in strength; but if it hangs loose, and the boat lies equally high before and behind upon the water, they pull it in gently, but take care to coil it so, that the whale may have it again easily if he recovers strength: they take care, however, not to give him too much line, because he sometimes entangles it about a rock, and pulls out the harpoon. The fat whales do not sink as soon as dead, but the lean one's do, and come up some days afterwards. As long as they see whales, they lose no time in cutting up what they have taken, but keep fishing for others: when they see no more, or have taken enough, they begin with taking off the fat and whiskers in the following manner. The whale being lashed along-side, they lay it on one side, and put two ropes, one at the head, and the other in the place of the tail, which, together with the fins, is struck off as soon as he is taken, to keep those extremities above water. On the off-side of the whale are two boats, to receive the pieces of fat, utensils, and men, that might otherwise fall into the water on that side. These precautions being taken, three or four men with irons at their feet, to prevent slipping, get on the whale, and begin to cut out pieces of about three feet thick, and eight long, which are hauled up at the capstane or windlafs. When the fat is all got off, they cut off the whiskers of the upper jaw with an ax. Before they cut, they are all lashed to keep them firm, which also facilitates the cutting, and prevents them from falling into the sea: when on board, five or six of them are bundled together, and properly stowed; and after all is got off, the carcase is turned adrift, and devoured by the bears, who are very fond of it. In proportion as the large pieces of fat are cut off, the rest of the crew are employed in slicing them smaller, and picking out all the lean. When this is prepared, they stow it under the deck, where it lies till the fat of all the whales is on board; then cutting it still smaller, they put it up in tubs in the hold, cramming them very full and close. Nothing now remains but to sail homewards, where the fat is to be boiled and melted down into train oil. See **TRAIN OIL**.

It were in vain to speak in this place of the advantages that may be derived to Great Britain from the whale-fishery. We shall only remark, that the legisla-

ture think that trade of so great importance, as to grant a very considerable bounty for the encouragement of it; for every British vessel of 200 tons or upwards, bound to the Greenland-seas on the whale-fishery, if found to be duly qualified according to the act, obtains a licence from the commissioners of the customs to proceed on such voyage: and on the ship's return, the master and mate making oath that they proceeded on such voyage and no other, and used all their endeavours to take whales, &c. and that all the whale fins, blubber, oil, &c. imported in their ship, were taken by their crew in those seas, there shall be allowed 40s. for every ton according to the admeasurement of the ship.

Besides these fisheries, there are several others both on the coasts of Great Britain and in the North Seas, which, although not much the subject of merchandize, nevertheless employ great numbers both of ships and men; as, 1. The oyster-fishing at Colchester, Feversham, the Isle of Wight, in the Swales of the Medway, and in all the creeks between Southampton and Chichester, from whence they are carried to be fed in pits about Wevenhoe and other places. See OYSTER. 2. The lobster-fishing all along the British Channel, the Frith of Edinburgh, on the coast of Northumberland, and on the coast of Norway, from whence great quantities are brought to London. And lastly, the fishing of the pot-fish, fin-fish, sea-unicorn, sea horse, and the seal, or dog-fish; all which are found in the same seas with the whales, and yield blubber in a certain degree; besides, the horn of the unicorn is as estimable as ivory, and the skins of the seals are particularly useful to trunkmakers.

**Trout FISHING.** The baits for this purpose are either natural or artificial, as earth, worms, minnows, and fishing flies, both natural and artificial. Whatever worms are used, they answer best if kept some time in an earthen pot, with moss often changed in summer. If you fish for trout with hand on the ground, the hook is to be introduced into the worm a little above the middle, coming out again a little below; then draw the worm above the arming of the hook, making your first entrance at the tail-end, that the point of the hook may come out at the head-end. When you fish with minnows, take the whitest and middle sized; and after putting the hook in at the mouth, and out at the gills, and drawing it through about three inches, slip it again into his mouth, so as the point and beard may come out at the tail. This done, tie the hook and tail together with a fine white thread, and let the body of the minnow be almost streight upon the hook.

**FISSURE of the bones,** in surgery, is when they are divided either transversely or longitudinally, not quite through, but cracked after the manner of glass, by any external force. See SURGERY.

**FISTULA,** in the ancient music, an instrument of the wind-kind, resembling our flute, or flageolet.

The principal wind-instruments of the ancients, were the tibia and fistula. But how they were constituted,

wherein they differed, or how they were played on, does not appear.

**FISTULA,** in medicine and surgery. See MEDICINE and SURGERY.

**FISTULA,** in farriery. See FARRIERY.

**FISTULAR,** or **FISTULOUS,** appellations given by surgeons to wounds and ulcers, which degenerate into fistulas.

**FIT,** in medicine. See PAROXYSM.

**FITCHEE,** in heraldry, a term applied to a cross, when the lower end of it is sharpened into a point, as in Plate LXXX. fig. 6.

**FITCHES,** in husbandry, a sort of pulse, more generally known by the name of chick-pea, or cicer. See CICER.

**FITZ,** makes part of the surname of some of the natural sons of the kings of England, as Fitz-roy; which is purely French, and signifies the king's son.

**FIVE CHURCHES,** a bishop's see of lower Hungary, 76 miles south of Buda.

**FIVES,** or **VIVES,** in farriery. See FARRIERY, p. 555.

**FIXATION,** in chemistry, the rendering any volatile substance fixed, so as not to fly off upon being exposed to a great heat; hence,

**FIXED BODIES** are those which bear a considerable degree of heat without evaporating, or losing any of their weight.

**FLACCIDITY,** among physicians, a disorder of the solids, cured by astringent and cardiac medicines, joined with exercise and good air.

**FLAG,** a general name for colours, standards, ancients, banners, ensigns, &c.

The fashion of pointed or triangular flags, as now used, Rod. Toletan assures, came from the Mahometan Arabs, or Saracens, upon their seizure of Spain, before which time all the ensigns of war were stretched or extended on cross pieces of wood, like the banners of a church. The pirates of Algiers, and throughout the coasts of Barbary, bear an hexagonal flag.

**FLAG** is more particularly used at sea; for the colours, ancients, standards, &c. borne on the top of the masts of vessels, to notify the person who commands the ship, of what nation it is, and whether it be equipped for war or trade, see Plate LXXXI.

The admiral in chief carries his flag on the main top, the vice-admiral on the fore-top, and the rear-admiral on the mizzen-top.

When a council of war is to be held at sea, if it be on board the admiral, they hang a flag in the main shrouds; if in the vice-admiral, in the fore-shrouds; and if in the rear-admiral, in the mizzen shrouds.

Besides the national flag, merchant ships frequently bear lesser flags on the mizzen-mast, with the arms of the city where the master ordinarily resides; and on the fore-mast, with the arms of the place where the person who freights them lives.

**FLAG OFFICERS,** those who command the several squadrons of a fleet, such are the admirals, vice-admirals, and rear-admirals.

The

FLAGS

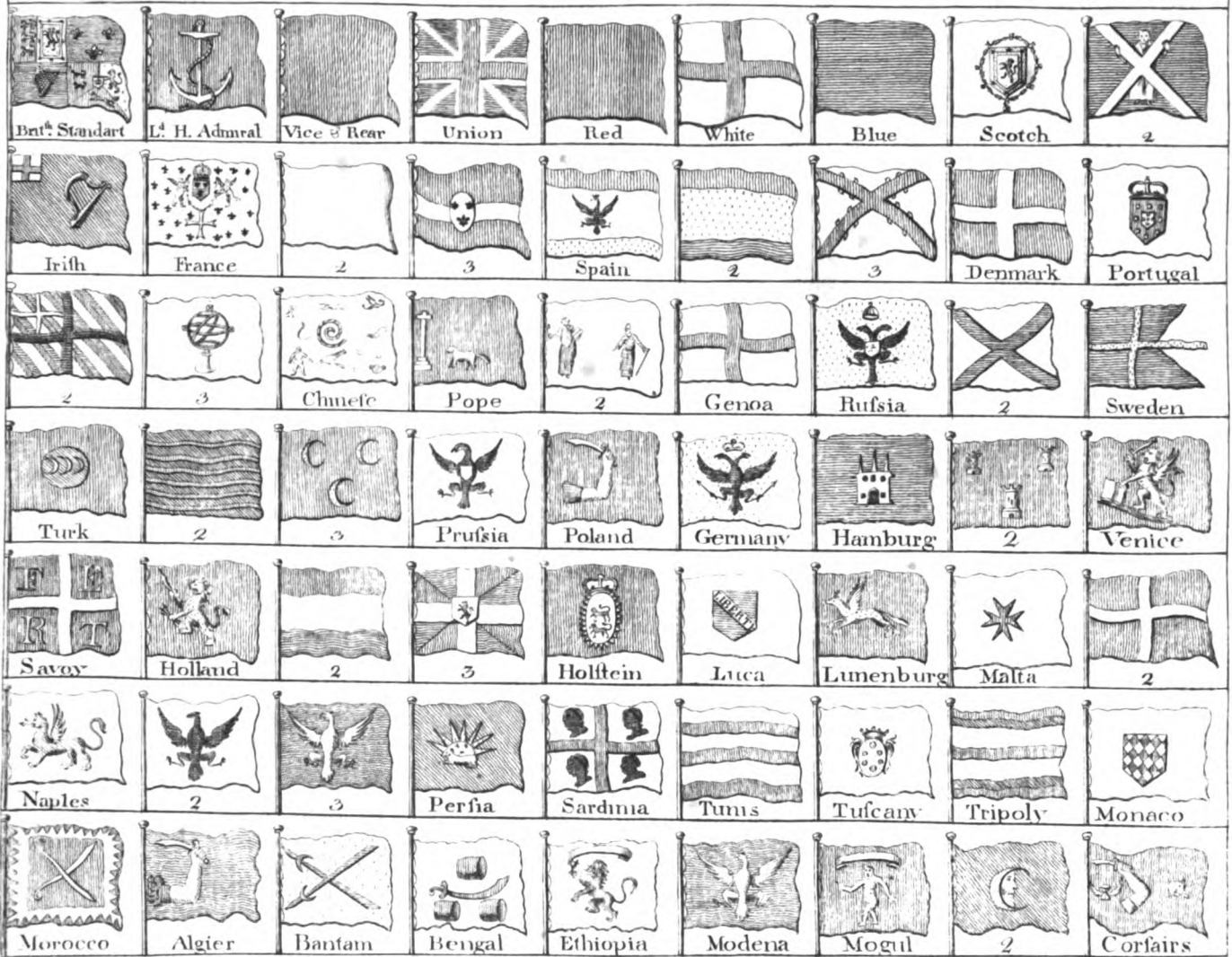
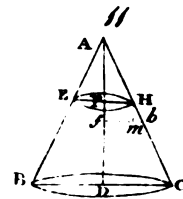
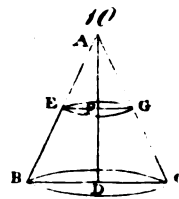
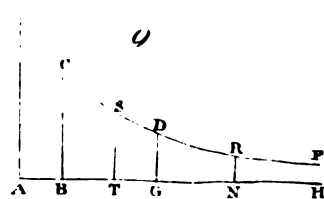
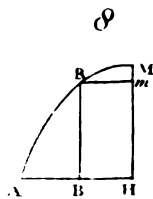
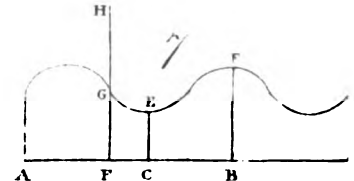
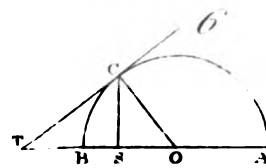
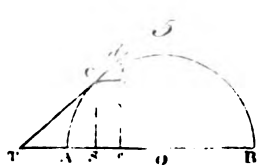
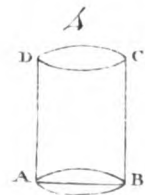
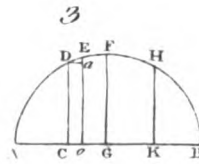
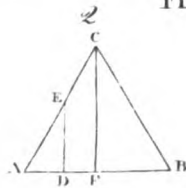
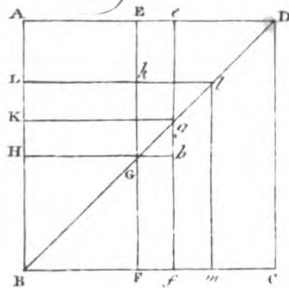


Fig. 1.

FLUXIONS



J. B. K.



The flag officers in our pay, are the admiral, vice-admiral, and rear-admiral of the white, red, and blue. See ADMIRAL.

**FLAG-SHIP**, a ship commanded by a general or flag-officer, who has a right to carry a flag, in contradistinction to the secondary vessels under the command thereof.

**FLAG-FLOWER**, in botany. See IRIS.

*Corn* **FLAG**, in botany. See GLADIOLUS.

**FLAGELLARIA**, in botany, a genus of the hexandria trigynia class. The calix consists of six segments; it has no corolla; and the berry contains but one seed. There is but one species, a native of the East-Indies.

**FLAGEOLET**, or **FLAJOLET**, a little flute, used chiefly by the shepherds and country people. It is made of box, or other hard wood, and sometimes of ivory, and has six holes besides that at the bottom, the mouth-piece, and that behind the neck.

**FLAIL**, an instrument for threshing corn.

A flail consists of the following parts. 1. The hand-staff, or piece held in the thresher's hand. 2. The swiple, or that part which strikes out the corn. 3. The caplins, or strong double leathers, made fast to the tops of the hand-staff and swiple. 4. The middle-band, being the leather thong, or fish skin, that ties the caplins together.

**FLAMBEAU**, a kind of large taper, made of hempen wicks, by pouring melted wax on their top, and letting it run down to the bottom. This done, they lay them to dry; after which they roll them on a table, and join four of them together by means of a red-hot iron; and then pour on more wax, till the flambeau is brought to the size required.

Flambeaus are of different lengths, and made either of white or yellow wax. They serve to give light in the streets at night, or on occasion of illuminations.

**FLAMBOROUGH-HEAD**, in geography, a cape or promontory of Yorkshire, five miles east of Burlington: E. long. 25', N. lat. 54° 15'.

**FLAME**, the small parts of an inflammable body, that are set on fire, or briskly agitated and thrown off, with a certain vibrative motion at the surface of that body into the open air: or, in Sir Isaac Newton's words, the flame of a body is only the smoke thereof heated red hot; and the smoke is only the volatile part of the body separated by the fire. See FIRE.

**FLAMEN**, in Roman antiquity, the name of an order of priests, instituted by Romulus or Numa; authors not being agreed on this head.

They were originally only three, *viz.* the flamen dialis, flamen martialis, and flamen quirinus. They were chosen by the people, and installed by the sovereign pontiff. Afterwards, their number was increased to fifteen; the three first of whom were senators, and called flamines majores; the other twelve, taken from among the people, being denominated flamines minores.

The flamen dialis, or priest of Jupiter, was a considerable person at Rome; the flamen martialis, or priest of Mars, was the second in dignity; and the flamen quirinalis, was the next to him,

**FLANDERS**, a province of the Netherlands, bounded by the German sea and the United provinces on the north; by the province of Brabant, on the east; by Hainault and Artois, on the south; and by another part of Artois and the German sea, on the west; being about sixty miles long, and fifty broad, and divided between the Austrians, the French, and the Dutch.

Flanders is a perfectly champaign country, with not a rising ground or hill in it, and watered with many fine rivers and canals. Its chief commodities are fine lace, linen, and tapestry.

**FLANEL**, or **FLANNEL**, a loose sort of woollen stuff, not crossed, and woven on a loom like bays.

**FLATS**, in music, a kind of additional notes, which, together with sharps, serve to remedy the defects of musical instruments, wherein temperament is required. See MUSIC.

**FLATULENCY**, in medicine. See MEDICINE.

**FLAW**, in the sea-language, signifies a sudden gust of wind.

**FLAX**, in botany. See LINUM.

The following particulars with regard to the manner of raising flax has been for some years past warmly commended by the Trustees for fisheries, manufactures, and improvements in Scotland.

*Of the choice of the Soil, and Preparing the Ground for FLAX.* A skilful flax-raiser always prefers a free open deep loam, and all grounds that produced the preceding year a good crop of turnip, cabbage, potatoes, barley, or broad clover; or has been formerly laid down rich, and kept for some years in pasture.

A clay soil, the second or third crop after being limed, will answer well for flax; provided, if the ground be still stiff, that it be brought to a proper mould, by tilling after harvest, to expose it to the winter frosts.

All new grounds produce a strong crop of flax, and pretty free of weeds. When a great many mole-heaps appear upon new ground, it answers the better for flax after one tilling.

Flax-seed ought never to be sown on grounds that are either too wet or dry; but on such as retain a natural moisture: and such grounds as are inclined to weeds ought to be avoided, unless prepared by a careful summer-fallow.

If the lintseed be sown early, and the flax not allowed to stand for seed, a crop of turnip may be got after the flax that very year; the second year a crop of bear or barley may be taken; and the third year, grass-seeds are sometimes sown along with the lintseed. This is the method mostly practised in and about the counties of Lincoln and Somerset, where great quantities of flax and hemp are every year raised, and where these crops have long been capital articles. There, old ploughed grounds are never sown with lintseed, unless the soil be very rich and clean. A certain worm, called in Scotland the Coup-worm, abounds in new broke up grounds, which greatly hurts every crop but flax. In small inclosures surrounded with trees or high hedges, the flax, for want of free air, is subject to fall before it be ripe, and the droppings of rain and dew

dew from the trees prevent the flax within the reach of the trees from growing to any perfection.

Of preceding crops, potatoes and hemp are the best preparation for flax. In the fens of Lincoln, upon proper ground of old tillage, they sow hemp, dunging well the first year; the second year hemp without dung; the third year flax without dung; and that same year a crop of turnip eat on the ground by sheep; the fourth year hemp with a large coat of dung, and so on for ever.

If the ground be free and open, it should be but once ploughed, and that as shallow as possible, not deeper than 2½ inches. It should be laid flat, reduced to a fine garden-mould by much harrowing, and all stones and sods should be carried off.

Except a little pigeon's dung for cold or four ground, no other dung should be used preparatory for flax, because it produces too many weeds, and throws up the flax thin and poor upon the stalk.

Before sowing, the bulky clods should be broken, or carried off the ground; and stones, quickenings, and every other thing that may hinder the growth of the flax, should be removed.

*Of the choice of Lintseed.* The brighter in colour, and heavier the seed is, so much the better: that which when bruised appears of a light or yellowish green, and fresh in the heart, oily and not dry, and smells and tastes sweet, and not stuffy, may be depended upon.

Dutch seed of the preceding year's growth, for the most part, answers best; but it seldom succeeds if kept another year. It ripens sooner than any other foreign seed. Philadelphia seed produces fine lint and few bolls, because sown thick, and answers best in wet cold soils. Riga seed produces coarser lint, and the greatest quantity of seed. Scots seed, when well winned and kept, and changed from one kind of soil to another, sometimes answers pretty well; but should be sown thick, as many of its grains are bad, and fail. It springs well, and its flax is sooner ripe than any other; but its produce afterwards is generally inferior to that from foreign seed.

A kind has been lately imported, called memmelseed, which looks well, is short and plump, but seldom grows above eight inches, and on that account ought not to be sown.

*Of Sowing Lintseed.* The quantity of lintseed sown, should be proportioned to the condition of the soil; for if the ground be in good heart, and the seed sown thick, the crop will be in danger of falling before it is ready for pulling. From eleven to twelve pecks Linlithgow measure of Dutch or Riga seed, is generally sufficient for one Scots acre; and about ten pecks of Philadelphia seed, which being the smallest grained, goes farthest Riga lintseed, and the next year's produce of it, is preferred in Lincolnshire.

The time for sowing lintseed is from the middle of March to the end of April, as the ground and season answers; but the earlier the seed is sown, the less the crop interferes with the corn-harvest.

Late sown lintseed may grow long, but the flax upon the stalk will be thin and poor.

After sowing, the ground ought to be harrowed till

the seed is well covered, and then (supposing the soil as before mentioned to be free and reduced to a fine mould) the ground ought to be rolled.

When a farmer sows a large quantity of lintseed, he may find it proper to sow a part earlier and part later, that in the future operations of weeding, pulling, watering, and grassing, the work may be the easier and more conveniently gone about.

It ought always to be sown on a dry bed.

*Of Weeding FLAX.* It ought to be weeded when the crop is about four inches long. If longer deferred, the weeders will so much break and crook the stalks, that they will never perhaps recover their straightness again; and when the flax grows crooked, it is more liable to be hurt in the rippling and swingling.

Quickening-grass should not be taken up; for, being strongly rooted, the pulling of it always loosens a deal of the lint.

If there is an appearance of a settled drought, it is better to defer the weeding, than by that operation to expose the tender roots of the flax to the drought.

How soon the weeds are got out, they ought to be carried off the field, instead of being laid in the furrows, where they often take root again, and at any rate obstruct the growth of the flax in the furrows.

*Of Pulling FLAX.* When the crop grows so short and branchy, as to appear more valuable for seed than flax, it ought not to be pulled before it be thoroughly ripe; but if it grows long and not branchy, the seed should be disregarded, and all the attention given to the flax. In the last case it ought to be pulled after the bloom has fallen, when the stalk begins to turn yellow, and before the leaves fall, and the bolls turn hard and sharp-pointed.

When the stalk is small, and carries few bolls, the flax is fine; but the stalk of coarse flax is gross, rank, branchy, and carries many bolls.

When flax has fallen and lies, such as lies ought to be immediately pulled, whether it has grown enough or not, as otherwise it will rot altogether.

When parts of the same field grow unequally, so that some parts are ready for pulling before other parts; only what is ready should be pulled, and the rest should be suffered to stand till ready.

The flax-raiser ought to be at pains to pull, and keep by itself, each different kind of lint which he finds in his field; what is both long and fine, by itself; what is both long and coarse, by itself; what is both short and fine, by itself; what is both short and coarse, by itself; and in like manner every other kind by itself that is of the same size and quality. If the different kinds be not thus kept separate, the flax must be much damaged in the watering, and the other succeeding operations.

What is commonly called under growth, may be neglected as useless.

Few persons that have seen flax pulled, are ignorant of the method of laying it in handfuls across other: which gives the flax sufficient air, and keeps the handfuls separate and ready for the rippler.

*Of Stacking up FLAX during the winter, and Winning*  
12c

*the Seed.* If the flax be more valuable than the seed, it ought by no means to be stacked up; for its own natural juice allits it greatly in the watering: where, as, if kept long unwatered, it loses that juice, and the harle adheres so much to the boon, that it requires longer time to water, and even the quality of the flax becomes thereby harsher and coarser. Besides, the flax stacked up over-year, is in great danger from vermin and other accidents; the water in spring is not so soft and warm as in harvest; and near a year is thereby lost of the use of the lint: but if the flax be so short and branchy as to appear most valuable for seed, it ought, after pulling, to be stoked and dried upon the field, as is done with corn, then stacked up for winter, rippled in spring, and after sheeling the seed should be well cleaned from bad seeds, &c.

*Of Rippling FLAX.* After pulling, if the flax is to be regarded more than the seed, it should be allowed to lie some hours upon the ground to dry a little, and so gain some firmness, to prevent the skin or harle, which is the flax, from rubbing off in the rippling; an operation which ought by no means to be neglected, as the bolls, if put into the water along with the flax, breed vermin there, and otherwise spoil the water. The bolls also prove very inconvenient in the grassing and breaking.

In Lincolnshire and Ireland, they think that rippling hurts the flax; and therefore, in place of rippling, they strike the bolls against a stone.

The handfuls for rippling should not be great, as that endangers the lint in the rippling comb.

After rippling, the flax-raiser will perceive, that he is able to assort each size and quality of the flax by itself more exactly than he could before.

*Of Watering FLAX.* A running stream wastes the lint, makes it white, and frequently carries it away. Lochs, by the great quantity and motion of the water, also waste and whiten the flax, though not so much as running streams. Both rivers and lochs water the flax quicker than canals.

But all flax ought to be watered in canals, which should be digged in clay ground if possible, as that soil retains the water best: but if a firm retentive soil cannot be got, the bottom or sides of the canal, or both the bottom and sides, may be lined with clay; or, instead of lining the sides with clay, which might fall down, a ditch may be dug without the canal, and filled with clay, which will prevent both extraneous water from entering, and the water within from running off.

A canal of forty feet long, six broad, and four deep, will generally water the growth of an acre of flax.

It ought to be filled with fresh soft water from a river or brook, if possible two or three weeks before the flax is put in, and exposed all that time to the heat of the sun. The greater way the river or brook has run, the softer, and therefore the better will the water be. Springs, or short runs from hills, are too cold, unless the water is allowed to stand long in the canal. Water from coal or iron, is very bad for flax. A little of the powder of galls thrown into a glass of water, will immediately discover if it comes from minerals of that kind, by turning it into a dark colour, more or less tinged in proportion to the quantity of vitriol it contains.

The canal ought not to be under any shade; which, besides keeping the sun from softening the water, might make part of the canal cooler than other parts, and so water the flax unqually.

The flax-raiser will observe, when the water is brought to a proper heat, that small plants will be rising quickly in it, numbers of small insects and reptiles will be generating there, and bubbles of air rising on the surface. If no such signs appear, the water must not be warm enough, or is otherwise unfit for flax.

Moss-holes, when neither too deep nor too shallow, frequently answer well for watering flax, when the water is proper, as before described.

The proper season for watering flax is, from the end of July to the end of August.

The advantage of watering flax as soon as possible, after pulling, has been already mentioned.

The flax being sorted after rippling, as before-mentioned, should next be put in beets, never larger than a man can grasp with both his hands, and tied very slack, with a band of a few stalks. Dried rushes answer exceedingly well for binding flax, as they do not rot in the water, and may be dried and kept for use again.

The beets should be put into the canals slope-ways, or half standing upon end, the root-end uppermost. Upon the crop-ends, when uppermost, there frequently breeds a deal of vermin, destructive of the flax, which is effectually prevented by putting the crop-end downmost.

The whole flax in the canal ought to be carefully covered from the sun with divots; the grassy side of which should be next the flax, to keep it clean. If it is not thus covered, the sun will discolour the flax, though quite covered with water. If the divots are not weighty enough to keep the flax entirely under water, a few stones may be laid above them. But the flax should not be pressed to the bottom.

When the flax is sufficiently watered, it feels soft to the grip, and the *harle* parts easily with the *boon* or *show*, which last is then become brittle, and looks whitish. When these signs are found, the flax should be taken out of the water, beet after beet; each gently rinsed in the water, to cleanse it of the nastiness which has gathered about it in the canal; and as the lint is then very tender, and the beet slackly tied, it must be carefully and gently handled.

Great care ought to be taken that no part is overdone; and as the coarsest waters soonest, if different kinds be mixed together, a part will be rotted, when the rest is not sufficiently watered.

When lint taken out of the canal is not found sufficiently watered, it may be laid in a heap, for twelve, eighteen, or twenty-four hours, which will have an effect like more watering; but this operation is nice, and may prove dangerous in unskillful hands.

After the flax is taken out of the canal, fresh lint should not be put a second time into it, until the former water be run off, and the canal cleaned, and supplied with fresh water.

*Of grassing FLAX.* Short heath is the best field for grassing flax, as, when wet, it softens to the heath, and is thereby prevented from being blown away by the wind. The heath also keeps it a little above the

earth, and so exposes it the more equally to the weather. When such heath is not to be got, links, or clean old lea-ground is the next best. Long grafs-grounds should be avoided, as the grafs growing thro' the lint frequently spots, tenders, or rots it; and grounds exposed to violent winds should also be avoided.

The flax, when taken out of the water, must be spread very thin upon the ground; and being then very tender, it must be gently handled. The thinner it is spread the better, as it is then the more equally exposed to the weather. But it ought never to be spread during a heavy shower, as that would wash and wattle the harle too much, which is then excessively tender, but soon after becomes firm enough to bear the rains, which, with the open air and sunshine, cleans, softens, and purifies the harle to the degree wanted, and makes it blifter from the boon. In short, after the flax has got a little firmness by being a few hours spread in dry weather, the more rain and sunshine it gets the better.

If there be little danger of high winds carrying off the flax, it will be much the better of being turned about once a-week. If it is not to be turned, it ought to be very thin spread. The spreading of flax and hemp requires a deal of ground, and enriches it greatly.

The skilful flax-raiser spreads his first row of flax at the end of the field opposite to the point from whence the most violent wind commonly comes, placing the root-ends foremost; he makes the root-ends of every other row overlap the crop-ends of the former row three or four inches, and binds down the last row with a rope; by which means the wind does not

easily get below the lint to blow it away: and as the crop-ends are seldom so fully watered as the root-ends, the aforesaid overlapping has an effect like giving the crop-ends more watering. Experience only can fully teach a person the signs of flax being sufficiently grassed: then it is of a clearer colour than formerly; the harle is blistered up, and easily parts with the boon, which is then become very brittle. The whole should be sufficiently grassed before any of it is lifted; for if a part be lifted sooner than the rest, that which remains is in great danger from the winds.

A dry day ought to be taken for taking up the flax; and if there is no appearance of high wind, it should be loosed from the harle or grafs, and left loose for some hours, to make it thoroughly dry.

As a great quantity of flax can scarcely be all equally watered and grassed, and as the different qualities will best appear at lifting the flax off the grafs; therefore at that time each different kind should be gathered together, and kept by itself; that is, all of the same colour, length, and quality.

The smaller the beets lint is made up in, the better for drying, and the more convenient for slacking, housing, &c. and in making up these beets, as in every other operation upon flax, it is of great consequence that the lint be laid together as it grew, the root-ends together, and the crop-ends together.

*Of keeping FLAX after it is grassed.* Nothing needs be said here, but that if the flax is to be stacked, it should be set in an airy place, upon a dry foundation, such as pob-middings, or the like, and well covered from the weather; and if housed, the floor must be dry, and the house well aired, and water-tight.

*Follows an Estimate of the Expence, Produce, and Profit of a Scots acre of FLAX,—supposing the season favourable, that no accidental losses happen, and that the farmer is neither unskilful nor negligent.*

	<i>A medium crop.</i>	<i>A great crop.</i>	<i>An extraordinary crop.</i>
Ground-rent, labouring the ground, and leading the flax	L. 2 10 0	L. 3 10 0	L. 5 0 0
Lintseed from L. 2 to L. 4 per hogshhead, the medium			
3s. 4d. per peck.	1 16 8	1 10 0	1 6 8
	for 11 pecks.	for 9 pecks.	for 8 pecks.
Clodding and sowing	0 2 0	0 2 0	0 2 0
Weeding	0 12 0	0 8 0	nothing.
Pulling, rippling, putting in, and covering in the water	0 14 0	0 15 0	1 0 0
Taking out of the water, grassing, and stacking	0 8 0	0 12 0	0 18 0
Breaking, and scutching, at 2s. per stone	3 0 0	4 0 0	6 0 0
	for 30 stones.	for 40 stones.	for 60 stones.
<b>Total expence</b>	<b>L. 9 2 8</b>	<b>L. 10 17 0</b>	<b>L. 14 6 8</b>
Produce at 10s. per stone	L. 15 0 0	L. 20 0 0	L. 30 0 0
	for 30 stones.	for 40 stones.	for 60 stones.
Lintseed sold for oil at 1s. per peck	0 16 0	0 18 0	1 0 0
The chaff of the bolls is well worth the expence of drying the seed; as it is good food, boiled and mixed with beer, for horses.			
<b>Total produce</b>	<b>L. 15 16 0</b>	<b>L. 20 18 0</b>	<b>L. 31 0 0</b>
Ballance for profit	L. 6 14 4	L. 10 1 0	L. 16 13 4

These



There is nothing stated here as expence of the canal in which the flax is watered ; because that varies much according to the conveniencies people have for making it : and a canal once made requires for after-years only to be repaired and cleansed.

It is a certain fact, that the greater the crop is, the better is the quality of the same kind of flax.

The advantage of having both a crop of flax and a crop of turnip the same year—or of sowing grafs-seeds along with the lintseed—and of reducing the ground to a fine garden mould, free of weeds, ought to be attended to.

*For Cambrick and fine Lawn.* The ground must be a rich light soil, rather sandy, but cannot be too rich.

It ought to be ploughed in September, or the beginning of October, first putting a little hot rotten dung upon it.

Second ploughing in January after a hard frost ; and when you intend to sow it, plough it a third time, or rather hoe it, reducing the clods very fine ; but make no furrows : the land must be made level like a garden ; but never work the land when wet.

The seed should be sown the beginning of April, and about double the quantity that is generally sown by our farmers ; if the land be very rich, it will require rather more than double.

As soon as sown (if the weather be dry) it will be necessary to roll the ground.

The lint must be weeded very clean when about three inches high ; directly after which you must set forked sticks, of about one and half inch thick (which ought to be prepared before) every four or five feet, according to the length of the poles you are to lay upon them ; they should be well fixed in the ground, the forked part to receive the poles about six or seven inches above the lint ; each row of poles should be two, three, or four feet asunder, according to the length of the brushwood you are to lay upon them.

The poles ought to be from ten to fifteen feet long, and strong enough to support the brush across the poles ; take the longest brushwood you can get, the more branchy the better, very thick, filling up the vacancies with smaller brush, and any of the branches that rise higher than eighteen or twenty inches ought to be lopped off to make the brush lie as level as possible : any sort of brush will do except oak, as that tinges the lint.

Your lint must be pulled as soon as the seed is fully formed, which is a few days after it is out of the bloom before the lint turn yellow.

It must be pulled above the brushwood, and every handful laid upon it as soon as possible : if it is fine weather, leave it four or five hours in that manner ; then carry it to a screen near a barn, to put it under cover in case of rain ; there it must be spread four or five days, and always put in the barn at night, or when it appears to rain : the bundles must be opened in the barn, or made hollow, to prevent it from heating.

These operations must be performed until the lint is perfectly dry, and out of danger of heating ; taking care all the time to keep the roots as even as possible,

and if possible, keep it from rain or wet : if you cannot prevent it from being wet, it will be better to leave it on the grafs till dry ; because when once wet, the putting it under cover before dry will make it turn black ; a thing which must be prevented at all events.

If any of the lint upon the border, or through the piece of ground, be coarser than another, it must be separated from the rest.

The utmost care must be taken to preserve the lint entire, or unbroke ; for this reason they beat off the seed with a round mell or bittle.

The most proper ground is summer fallow, or after potatoes, or lea ; if possible near a wood, to prevent the expence of carrying brush.

As soon as the seed is off, if you intend to water it that season, it must be tied in bundles about as large as you can grasp with your two hands.

The water proper for it, is a very small rivulet or soft spring free of any metallic ore, and taking care that no flood or foul water enters your pit ; which must be at least five feet deep, about nine or ten broad at the top, and seven or eight at the bottom, the length will depend on the quantity of flax you have to water. A very small stripe of water, when clear, should always be running in and off from your pit when the lint is in it.

The pit ought to be made three or four months before it be used

You must drive poles about four inches thick, with a hook inclining downwards, in this form 7, all along the sides of the pit, about five feet asunder. The hooks must be level, or rather under the surface of the water. A long pole, the whole length of the pit, must be fixed into these hooks on each side ; and cross poles put under that, to keep the lint under water ; but, the cross poles are not used till the lint is put in. You must order it so, that all the lint should be three or four inches under water. You next bring your lint to the sides of the pit ; then put your sheaves head to head, causing each overlap the other about one third, and take as many of these as make a bundle of two or two and a half feet broad, laying the one above the other, till it is about four or four and a half feet high ; then you tie them together in the middle, and at each root-end : after this, you wrap your bundle in straw, and lay it in the water, putting the thin or broad side undermost, taking care that none of your lint touch the earth ; after it is fully pressed under water, put in your cross poles to keep it under. The bundles ought to lie in the pit a foot separate from each other. This renders it easy to take out ; for, if the bundles entangle, they will be too heavy to raise.

The time of watering depends so much upon the weather, and softness or hardness of the water, that it is impossible to fix any certain time. This must be left to the skill of the farmer. If the flax be intended for spinning yarn soft and fit for cambrick, it ought to be spread upon short grafs for four or five days before you put it into the water ; but if for lawns, lace, or thread, it is best to dry it outright. In either case, avoid as much as possible to let it get rain ; as much rain washes and  
washes

washes out the oil, which is necessary to preserve the strength.

The great property of this flax is to be fine and long. Thick sowing raises all plants fine and slender, and when the ground is very rich, it forces them to a great length. Pulling green prevents that coarse hardness which flax has when let stand till it be full ripe, and gives it the fine silky property. The brushwood, when the flax springs up, catches it by the middle, prevents it from lying down and rotting; infallible consequences of sowing thick upon rich ground. It likewise keeps it straight, moist, and soft at the roots; and by keeping it warm, and shaded from the sun, greatly promotes its length. The keeping it from rain, heating, taking proper care of your water, preserves the colour, and prevents these bars in cloth so much complained off by bleachers.

**FLAX-DRESSING.** *The different methods of that operation.*

For many ages it was the practice to separate the boon or core from the flax, which is the bark of the plant, by the following simple *hand-methods*. First, for breaking the boon; the stalks in small parcels were beat with a mallet; or, more dexterously, the *break* (Plate LXXXII. fig. 1. and 2.) was used thus: The flax being held in the left-hand a-crofs the three *under-teeth* or *swords* of the break (A, fig. 1. and a, fig. 2.), the *upper-teeth* (B, fig. 1. and b, fig. 2.) were with the right-hand quickly and often forced down upon the flax, which was artfully shifted and turned with the left-hand. Next, for clearing the flax of the broken boon; the workman with his left-hand held the flax over the *stock* (fig. 3. and 4.) while with his right-hand he struck or threshed the flax with the *scutcher* (fig. 5.).

These methods of breaking and scutching the flax being slow and very laborious, a *water-mill* was invented in Scotland about forty years ago, which, with some late improvements, makes great dispatch, and in skilful and careful hands gives satisfaction. It has been generally constructed to break the boon by three dented rollers, placed one above the other. The middle one of which being forced quickly round takes the other two along with it, and one end of handfuls of the flax being by the workman directed in between the upper and middle rollers, the flax is immediately drawn in by the rollers; a curved board or plate of tin behind the rollers directs the flax to return again between the middle and undermost rollers;—and thus the operation is repeated until the boon be sufficiently broke. Great weights of timber or stone at the ends of levers, press the upper and under-rollers towards the middle one.

The scutching is next carried on by the mill in the following manner: Four arms, something like the hand-scutchers before described, project from a perpendicular axle; a box around the axle incloses these projecting scutchers; and this box is divided among the workmen, each having sufficient room to stand and handle his flax, which, through slits in the upper-part and sides of the box, they hold in to the stroke of the

scutchers; which, moving round horizontally, strike the flax a-crofs or at right angles, and so thresh out or clear it of the boon.

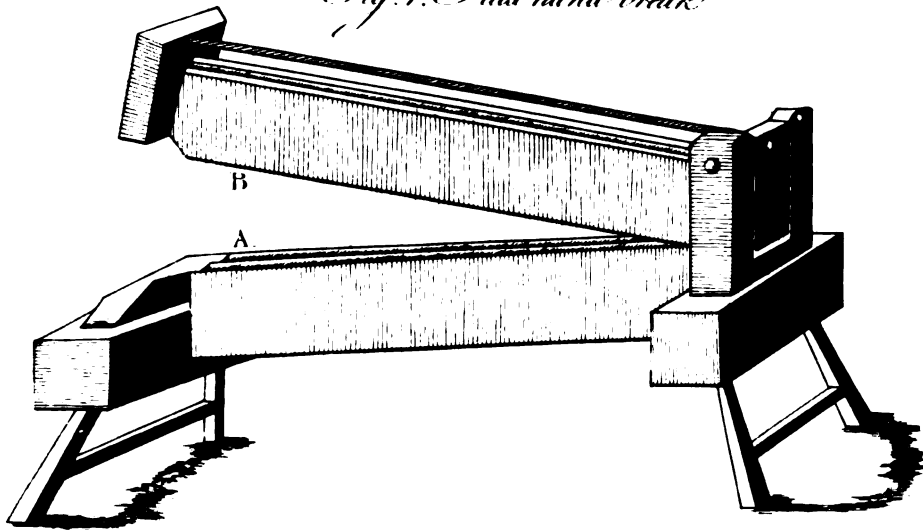
The breaking of the flax by *rollers* is scarcely subject to any objection, but that it is dangerous to workmen not sufficiently on their guard, who sometimes allow the rollers to take hold of their fingers, and thereby their whole arm is instantly drawn in: thus many have lost their arms. To avoid this danger, a break upon the general principles of the hand-break before described, has been lately adapted to water machinery, and used in place of rollers. The horizontal stroke of the scutchers was long thought too severe, and wasteful of the flax; but very careful experiments have discovered that the waste complained of must be charged to the unskilfulness or negligence of the workmen, as in good hands the mill carries away nothing but what, if not so scutched off, must be taken off in the heckling with more loss both of time and flax. But to obviate this objection of the violence of the *horizontal scutchers*, an imitation of hand scutching has lately been applied to water. The scutchers then project from an horizontal axle, and move like the arms of a check-reel, striking the flax neither across nor perpendicularly down, but sloping in upon the parcel exactly as the flax is struck by the hand-scutcher. This sloping stroke is got by raising the scutching-stock some inches higher than the centre of the axle; and by raising or lowering the stock, over which the flax is held, or screwing it nearer to or farther from the scutchers, the workman can temper or humour the stroke almost as he pleases.

A lint-mill with horizontal scutchers upon a perpendicular axle, requires a house of two stories, the rollers or break being placed in the ground story, and the scutchers in the loft above; but a mill with vertical scutchers on an horizontal axle, requires but one ground story for all the machinery.

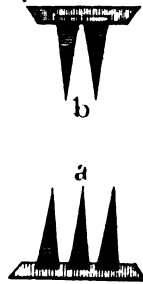
Another method of breaking and scutching flax, more expeditious than the old hand-methods, and more gentle than water-mills, has also been lately invented in Scotland. It is much like the break and scutcher giving the sloping stroke last described, moved by the foot. The treddle is remarkably long, and the scutchers are fixed upon the rim of a fly-wheel. The foot-break is also assisted in its motion by a fly. These foot-machines are very useful where there are no water-mills, but they are far inferior to the mills in point of expedition.—[See plans of the water-mills, and foot-machine, on the unnumbered plates betwixt the LXXXII. and LXXXIII.]

The next operation that flax undergoes after scutching, is heckling. The *heckle* (fig. 6. Plate LXXXII.) is firmly fixed to a bench before the workman, who strikes the flax upon the teeth of the heckle, and draws it thro' the teeth. To persons unacquainted with that kind of work this may seem a very simple operation; but, in fact, it requires as much practice to acquire the slight of heckling well, and without wadding the flax, as any other operation in the whole manufacture of linen. They use coarser and wider teathed heckles, or finer, accord-

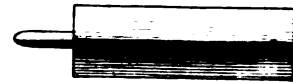
*Fig. 1. Four hand break!*



*Fig. 2. Section of the Break!*

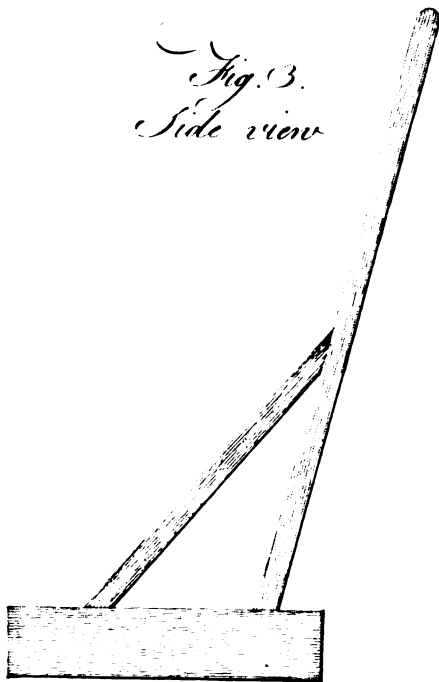


*Fig. 5. Hand Skutcher*

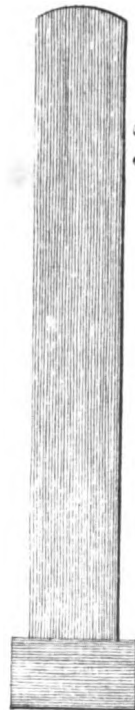


*Skutching Stock*

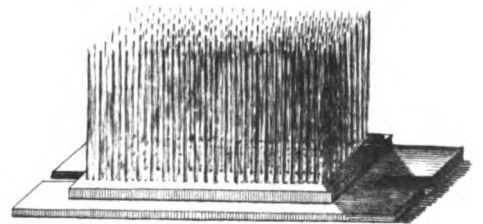
*Fig. 3. Side view*



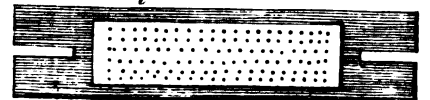
*Fig. 4. Front view*



*Fig. 6. God Fleckle*



*Fig. 7. plan of the Fleckle*



*J. Bell & Co.*



ing to the quality of the flax; generally putting the flax thro' two heckles, a coarser one first, and next thro' a fine heckle.

*Flax for cambrick and fine lawn, thread and lace, is dressed in a manner somewhat different. It is not sketched so thoroughly as common flax; which from the skutch proceeds to the heckle, and from that to the spinner: whereas this fine flax, after a rough skutching, is scraped and cleaned with a blunt knife upon the workman's-knee covered with his leather apron; from the knife it proceeds to the spinner, who, with a brush made for the purpose, straightens and dresses each parcel just before she begins to spin it.*

*Total-FLAX. See LINARIA.*

**FLEA**, in zoology. See PULEX.

**FLEA BANE**, in botany. See CONYZA.

**FLEA BITTEN**, that colour of a horse, which is white or grey, spotted all over with dark reddish spots.

**FLEAM**, in surgery and farriery, an instrument for letting a man or horse blood. A case of fleams, as it is called by farriers, comprehends six sorts of instruments; two hooked ones, called drawers, and used for cleaning wounds; a pen knife; a sharp pointed lancet, for making incisions; and two fleams, one sharp and the other broad pointed. These last are somewhat like the point of a lancet, fixed in a flat handle, only no longer than is just necessary to open the vein.

**FLECHE**, a town of France, under the meridian of London, twenty miles north-east of Angers.

**FLEECE**, the covering of wool, shorn off the bodies of sheep. See WOOL.

*Order of the Golden FLEECE*, an order of knighthood instituted by Philip II. duke of Burgundy. These knights at first were twenty four, besides the duke himself, who reserved the nomination of six more: but Charles V. increased them to fifty. He gave the guardianship of this order to his son Philip king of Spain, since which the Spanish monarchs are chiefs of the order. The knights had three different mantles ordained them at the grand solemnity, the collar and fleece.

**FLEET**, commonly implies a company of ships of war, belonging to any prince or state: but sometimes it denotes any number of trading ships, employed in a particular branch of commerce.

In sailing, a fleet of men of war is usually divided into three squadrons: the admiral's, the vice admiral's, and the rear-admiral's squadron, all which, being distinguished by their flags and pendants, are to put themselves, and, as near as may be, to keep themselves in their customary places, *viz.* The admiral, with his squadron, to sail in the van, that so he may lead the way to all the rest in the day-time, by the sight of his flag in the main top-mast head; and in the night time, by his lights or lanterns. The vice-admiral and his squadron, is to sail in the centre or middle of the fleet. The rear-admiral, and the ships of his squadron, is to bring up the rear. But sometimes other divisions are made; and those composed of the lighter ships and the best sailors, are placed as wings to the van, centre, and rear.

**FLEET** is also a noted prison in London, where persons

are committed for contempt of the king and his laws, particularly of his courts of justice: or for debt, where any person will not, or is unable to pay his creditors.

There are large rules and a warden belonging to the fleet prison, which had its name from the float or fleet of the river or ditch, on the side whereof it stands.

**FLENSBURGH**, a port town subject to Denmark, sixteen miles north of the city of Sleswick.

**FLESH**, in anatomy, a similar, fibrous part of an animal body, soft and bloody, being that whereof most of the other parts are composed, and whereby they are connected together: or more properly, it is such parts of the body where the blood-vessels are so small, as only to retain blood enough to preserve their colour red.

**FLEURY**, a town of Burgundy, in France, thirty miles north of Chalons.

**FLEXIBLE**, in physics, a term applied to bodies capable of being bent or diverted from their natural figure or direction.

**FLEXOR**, in anatomy, a name applied to several muscles, which are so called from their office, which is to bend the part to which they belong; in opposition to the extensors, which open or stretch them. See ANATOMY, part II.

**FLINT**, in natural history, a semipellucid stone, composed of crystal debased with earth, of one uniform substance, and free from veins; but of different degrees of colour, according to the quantity of earth it contains, and naturally surrounded with a whitish crust.

Flint is a stone of an extremely fine, compact, and firm texture, and very various, both in size and figure. It is of all the degrees of grey, from nearly quite black, to almost quite white. It breaks with a fine, even, glossy surface; and is moderately transparent, very hard, and capable of a fine polish. It readily strikes fire with steel, and makes not the least effervescence with aquafortis, and burns to a whiteness. Its uses in glass making, &c. are too well known to need a particular recital.

**FLOATAGES**, all things floating on the top of the sea or any water, a word much used in the commissions of water bailiffs.

**FLOOD**. See DELUGE.

**FLORENCE**, an archbishop's see and city of Italy, situated on the river Arno, in Tuscany, forty-five miles east of Leghorn: E. long. 12° 15', and N. lat. 43° 30'. Florence is one of the most elegant towns in Italy, has an university, and is six miles in circumference. The statues, paintings, and curiosities in the grand duke's palace are the admiration of travellers.

**FLORENTINE**, a town of Champaign in France, twenty-eight miles south-west of Troyes.

**FLORES**, in geography, one of the Azores islands, subject to Portugal.

**FLORID STYLE**, is that too much enriched with figures and flowers of rhetoric.

**FLORIDA**, in geography, a name first given by the Spaniards to all that part of North America which lies north of the gulph of Mexico. However, all that retains the name Florida, at present, is the peninsula between the British colony of Georgia and cape Florida,

*viz.* between  $25^{\circ}$  and  $30^{\circ}$  of N. latitude, and between  $81^{\circ}$  and  $85^{\circ}$  W. longitude.

**FLORIN**, is sometimes used for a coin, and sometimes for a money of account.

Florin, as a coin, is of different values, according to the different metals and different countries where it is struck. The gold florins are most of them of a very coarse alloy, some of them not exceeding thirteen or fourteen carrats, and none of them seventeen and a half. As to silver florins, those of Holland are worth about 1 s. 8 d. those of Genoa were worth  $8\frac{1}{2}$  Sterling.

Florin, as a money of account, is used by the Italian, Dutch, and German merchants and bankers, but admits of different divisions in different places. In Holland, it is on the footing of the coin of that name, containing 20 stivers. At Frankfort and Nuremberg it is equivalent to 3 s. Sterling, and is divided into creutzers, and pinnings. At Liege, it is equivalent to 2 s. 3 d. At Strasburg, to 1 s. 3 d. In Savoy, to 11 d. At Genoa, to  $8\frac{1}{2}$  d. And at Geneva, to  $6\frac{1}{2}$  d. See COIN.

**FLORIST**, a person well skilled in flowers, their kinds and cultivation.

**FLORY**, **FLOWRY**, or **FLEURY**, in heraldry, a cross that has the flowers at the end circumflex and turning down, differing from the potence, inasmuch as the latter stretches out more like that which is called patee.

The cross flory is represented in Plate LXXX. fig. 7.

**FLOS**, **FLOWER**, in botany: See FLOWER.

**FLOS**, in chemistry, the most subtil part of bodies separated from the more gross parts by sublimation, in a dry form. See CHEMISTRY.

**FLOTSON**, or **FLOTSOM**, goods that by shipwreck are lost, and floating upon the sea; which, with jetson and lagan, are generally given to the lord admiral: but this is the case only where the owners of such goods are not known. And here it is to be observed, that jetson signifies any thing that is cast out of a ship when in danger, and afterwards is beat on the shore by the water, notwithstanding which the ship perishes. Lagan is where heavy goods are thrown overboard, before the wreck of the ship, and sink to the bottom of the sea.

**FLOUNDER**, the English name of a species of pleuronectes. See PLEURONECTES.

**FLOUR**, the meal of wheat-corn, finely ground and sifted. See MEAL.

**FLOWER**, among botanists and gardeners, the most beautiful part of trees and plants, containing the organs or parts of fructification. See BOTANY.

**External FLOWER**. See XERANTHEMUM.

**Everlasting FLOWER**. See GNAPHALIUM.

**FLOWER FENCE**. See POINCIANA.

**FLOWER DE LUCE**. See IRIS.

**Sultan-FLOWER**. See CYANUS.

**Sun-FLOWER**. See HELIANTHUS.

**Trumpet-FLOWER**. See BIGNONIA.

**Wind-FLOWER**. See ANEMONE.

**FLOWER DE LIS**, or **FLOWER DE LUCE**, in heraldry, a bearing representing the lily, called the queen of flowers, and the true hieroglyphic of royal majesty; but of late it is become more common, being borne in some coats one, in others three, in others five, and in some semee, or spread all over the escutcheon in great numbers.

The arms of France are, three flower de lis or, in a field azure.

**FLUDDER**. See COLYMBUS.

**FLUID**, an appellation given to all bodies whose particles easily yield to the least partial pressure, or force impressed.

*Laws and properties of FLUIDS*. See HYDRAULICS and HYDROSTATICS.

**FLUOR**, in physics, a fluid; or, more properly, the state of a body that was before hard or solid, but is now reduced by fusion, or fire, into a state of fluidity.

**FLUOR**, in mineralogy, implies a sort of mineral concretion, frequently found amongst ores and stones, in mines and quarries.

**FLUOR ALBUS**, or **WHITES**. See MEDICINE.

**FLUSHING**, or **VLISSINGEN**, a port-town of Zealand in Holland, five miles south of Middleburgh: E. long.  $3^{\circ} 25'$ , N. lat.  $51^{\circ} 30'$ . It is a town of great foreign trade, and has a good secure harbour.

**FLUTE**, an instrument of music, the simplest of all those of the wind kind. It is played on by blowing it with the mouth, and the tones or notes are changed by stopping and opening the holes disposed for that purpose along its side.

*German FLUTE*, is an instrument entirely different from the common flute. It is not, like that, put into the mouth to be played, but the end is stoped with a tampon or plug; and the lower lip is applied to a hole about two inches and a half, or three inches, distant from the end. This instrument is usually about a foot and a half long; rather bigger at the upper end than the lower; and perforated with holes, besides that for the mouth, the lowest of which is stoped and opened by the little finger's pressing on a brass or sometimes a silver key, like those in hautboys, bassoons, &c. Its sound is exceeding sweet and agreeable; and serves as a treble in a concert.

Coarse flutes, on importation, pay the gros, containing twelve dozen,  $3$  s.  $10\frac{3}{4}$  d. and on exportation draw back  $3$  s.  $4\frac{1}{4}$  d.

**FLUTES**, or **FLUTINGS**. See ARCHITECTURE.

**FLUVIALIS**, in botany. See NAJAS.

**FLUX**, in medicine, an extraordinary issue, or evacuation of some humours of the body. See MEDICINE.

**FLUX**, in metallurgy, whatever can cause a body otherwise not at all, or hardly, fusible by fire, to melt. See CHEMISTRY.

FLUXIONS.

# F L U X I O N S.

**F**LUXIONS, a method of calculation which greatly facilitates computations in the higher parts of mathematics. Sir Isaac Newton and Mr Leibnitz contended for the honour of inventing it. It is probable they had both made progress in the same discovery, unknown to each other, before there was any publication on the subject.

In this branch of mathematics magnitudes of every kind are supposed generated by motion: a line by the motion of a point, a surface by the motion of a line, and a solid by the motion of a surface. And some part of a figure is supposed generated by an uniform motion; in consequence of which the other parts may increase uniformly or with an accelerated or retarded motion, or may decrease in any of these ways; and the computations are made by tracing the comparative velocities with which the parts flow.

Fig. 1. If the parallelogram ABCD be generated by an uniform motion of the line AB toward CD while it moves from FE towards  $f_e$ , while the line BF receives the increment  $Ff$ , and the figure will be increased by the parallelogram  $F_e f$ ; the line FE in this case undergoes no variation.

The fluxion of any magnitude at any point is the increment that it would receive in any given time, supposing it to increase uniformly from that point; and as the measures will be the same, whatever the time be, we are at liberty to suppose it less than any assigned time.

The first letters in the alphabet are used to represent invariable quantities; the letters  $x, y, z$  variable quantities; and the same letters with points over them  $\dot{x}, \dot{y}, \dot{z}$ , represent their fluxions.

Therefore if  $AB = a$ , and  $EF = x$ ;  $Ff$ , the fluxion of BF, will be  $= \dot{x}$ , and  $F_e f$ , the fluxion of AF,  $= a\dot{x}$ .

If the rectangle be supposed generated by the uniform motion of FG towards CD, at the same time HG moves uniformly towards AD, the point G keeping always on the diagonal, the lines FG HG will flow uniformly; for while Bf receives the increment  $Ff$  and HB, the increment HK, FG will receive the increment  $hg$  and HG the increment  $hg$ , and they will receive equal increments in equal successive times. But the parallelogram will flow with an accelerated motion; for while F flows to  $f$  and H to K, it is increased by the gnomon  $KGf$ ; but while F and H flow through the equal spaces  $fm$  KL, it is increased by the gnomon  $Lgm$  greater than  $KGf$ ; consequently when fluxions of the sides of a parallelogram are uniform, the fluxion of the parallelogram increases continually.

The fluxion of the parallelogram BHGF is the two parallelograms KG and  $Gf$ ; for though the parameter receives an increment of the gnomon  $KGf$ , while its sides flow to  $f$  and K, the part  $gG$  is owing to the additional velocity wherewith the parallelogram flows during that time; and therefore is no part of the measure of the fluxion, which must be computed by supposing the para-

meter to flow uniformly as it did at the beginning, without any acceleration.

Therefore if the sides of a parallelogram be  $x$  and  $y$ , their fluxions will be  $\dot{x}$   $\dot{y}$ ; and the fluxion of the parallelogram  $xy + y\dot{x}$ ; and if  $x = y$ , that is, if the figure be a square, the fluxion of  $x^2$  will be  $2x\dot{x}$ .

Fig. 2. Let the triangle ABC be described by the uniform motion of DE from A towards B, the point E moving in the line DF, so as always to touch the lines AC, CB; while D moves from A to F, DE is uniformly increased, and the increase of the triangle is uniformly accelerated. When DE is in the position FC, it is a maximum. As D moves from F to B, the line FC decreases, and the triangle increases, but with a motion uniformly retarded.

Fig. 3. If the semicircle AFB be generated by the uniform motion of CD from A towards B, while C moves from A to G, the line CD will increase, but with a retarded motion; the circumference also increases with a retarded motion, and the circular space increases with an accelerated motion, but not uniformly, the degrees of acceleration growing less as CD approaches to the position GF. When C moves from G to B, it decreases with a motion continually accelerated, the circumference increases with a motion continually accelerated, and the area increases with a motion continually retarded, and more quickly retarded as CD approaches to B.

The fluxion of a quantity which decreases is to be considered as negative.

When a quantity does not flow uniformly, its fluxion may be represented by a variable quantity, or a line of a variable length; the fluxion of such a line is called the second fluxion of the quantity whose fluxion that line is; and if it be variable, a third fluxion may be deduced from it, and higher orders from these in the same manner: the second fluxion is represented by two points, as  $\ddot{x}$ .

The increment a quantity receives by flowing for any given time, contains measures of all the different orders of fluxions; for if it increases uniformly, the whole increment is the first fluxion; and it has no second fluxion. If it increases with a motion uniformly accelerated, the part of the increment occasioned by the first motion measures the first fluxion, and the part occasioned by the acceleration measures the second fluxion. If the motion be not only accelerated, but the degree of acceleration continually increased, the two first fluxions are measured as before; and the part of the increment occasioned by the additional degree of acceleration measures the third; and so on. These measures require to be corrected, and are only mentioned here to illustrate the subject.

## DIRECT METHOD.

*Any flowing quantity being given, to find its fluxion.*

**RULE I.** To find the fluxion of any power of a quantity

tity, multiply the fluxion of the root by the exponent of the power, and the product by a power of the same root less by unity than the given exponent.

The fluxion of  $x^n$  is  $n x^{n-1} \dot{x}$ , of  $x^n$   $n x^{n-1} \dot{x}$ ; for the root of  $x^n$  is  $x$ , whose fluxion is  $\dot{x}$ ; which multiplied by the exponent  $n$ , and by a power of  $x$  less by unity than  $n$ , gives the above fluxion.

If  $x$  receive the increment  $\dot{x}$ , it becomes  $x+\dot{x}$ ; raise both to the power of  $n$ , and  $x^n$  becomes  $x^n+n x^{n-1} \dot{x}+\frac{n \cdot n-1}{2} x^{n-2} \dot{x}^2+\dots$ ; but all the parts of the increment, except the first term, are owing to the accelerated increase of  $x^n$ , and form measures of the higher fluxions. The first term only measures the first fluxion; the fluxion of  $\frac{1}{x^2}$  is  $-\frac{2}{x^3} \dot{x}$ ; for put  $x=x^2+z^2$ , we have  $\dot{x}=2z\dot{z}$ , and the fluxion of  $x^{-\frac{1}{2}}$ , which is equal to the proposed fluent, is  $-\frac{1}{2} x^{-\frac{3}{2}} \dot{x}$ , for which substituting the values of  $\dot{x}$  and  $z$ , we have the above fluxion.

**RULE II.** To find the fluxion of the product of several variable quantities multiplied together, multiply the fluxion of each by the product of the rest of the quantities, and the sum of the products thus arising will be the fluxion sought.

Thus the fluxion of  $xy$ , is  $\dot{x}y+x\dot{y}$ ; that of  $xyz$ , is  $\dot{x}yz+x\dot{y}z+xy\dot{z}$ ; and that of  $xyzu$ , is  $\dot{x}yzu+xy\dot{z}u+xyz\dot{u}+xyzu\dot{x}$ .

**RULE III.** To find the fluxion of a fraction.—From the fluxion of the numerator multiplied by the denominator, subtract the fluxion of the denominator multiplied by the numerator, and divide the remainder by the square of the denominator.

Thus, the fluxion of  $\frac{x}{y}$  is  $\frac{y\dot{x}-x\dot{y}}{y^2}$ ; that of  $\frac{x}{x+y}$ , is  $\frac{x\dot{x}+y\dot{x}-x\dot{y}-y\dot{x}}{(x+y)^2} = \frac{y\dot{x}-x\dot{y}}{(x+y)^2}$ .

**RULE IV.** In complex cases, let the particulars be collected from the simple rules and combined together.

The fluxion of  $\frac{x^2 y^2}{z}$  is  $\frac{2x^2 y \dot{y} + 2y^2 x \dot{x} z - x^2 y^2 \dot{z}}{z^2}$ ; for the fluxion of  $x^2$  is  $2x\dot{x}$ , and of  $y^2$  is  $2y\dot{y}$ , by Rule I. and therefore the fluxion of  $x^2 y^2$  (by Rule II)  $2x^2 y \dot{y} + 2y^2 x \dot{x}$ ; from which, multiplied by  $z$ , (by Rule III.) and subtracting from it the fluxion of the denominator  $z$ , multiplied by the numerator, and dividing the whole by the square of the denominator, gives the above fluxion.

**RULE IV.** The second fluxion is derived from the first, in the same manner as the first from the flowing quantity.

Thus the fluxion of  $x^3$ ,  $3x^2 \dot{x}$ ; its second,  $6x \dot{x}^2 + 3x^2 \ddot{x}$  (by Rule II); and so on: but if  $x$  be invariable,  $\dot{x}=0$ , and the second fluxion of  $x^3=6x \dot{x}^2$ .

**PROB. I.** To determine maxima and minima. When a quantity increases, its fluxion is positive; when

it decreases, it is negative; therefore when it is just between increasing and decreasing, its fluxion is  $=0$ .

**RULE.** Find the fluxion, make it  $=0$ , whence an equation will result that will give an answer to the question.

**Fig. 4. EXAMP.** To determine the dimensions of a cylindrical measure ABCD, open at the top, which shall contain a given quantity (of liquor, grain, &c.) under the least internal superficies possible.

Let the diameter  $AB=x$ , and the altitude  $AD=y$ ; moreover, let  $\rho$  (3.14159, &c.) denote the periphery of the circle whose diameter is unity, and let  $c$  be the given content of the cylinder. Then it will be  $1:\rho::x:(\rho x)$  the circumference of the base; which, multiplied by the altitude  $y$ , gives  $\rho xy$  for the concave superficies of the cylinder. In like manner, the area of the base, by multiplying the same expression into  $\frac{1}{4}$  of the diameter  $x$ , will be found  $=\frac{\rho x^2}{4}$ ; which drawn into the altitude  $y$ , gives

$\frac{\rho x^2 y}{4}$  for the solid content of the cylinder; which being made  $=c$ , the concave surface  $\rho xy$  will be found  $=\frac{4c}{x}$  and consequently the whole surface  $=\frac{4c}{x} + \frac{\rho x^2}{4}$ : Where-

of the fluxion, which is  $-\frac{4cx}{x^2} + \frac{\rho xx}{2}$  being put  $=0$ , we

shall get  $-8c + \rho x^3 = 0$ ; and therefore  $x = \sqrt[3]{\frac{8c}{\rho}}$ : further, because  $\rho x^2 = 8c$ , and  $\rho x^2 y = 4c$ , it follows, that  $x = 2y$ ; whence  $y$  is also known, and from which it appears, that the diameter of the base must be just the double of the altitude.

**Fig. 7.** To find the longest and shortest ordinates of any curve, DEF, whose equation or the relation which the ordinates bear to the abscissas is known.

Make AC the abscissa  $x$ , and CE the ordinate  $=y$ ; take a value  $y$  in terms of  $x$ , and find its fluxion: which making  $=0$ , an equation will result whose roots give the value of  $x$  when  $y$  is a maximum or minimum.

To determine when it is a maximum and when a minimum, take the value of  $y$ , when  $x$  is a little more than the root of the equation so found, and it may be perceived whether it increases or decreases.

If the equation has an even number of equal roots,  $y$  will be neither a maximum nor minimum when its fluxion is  $=0$ .

**PROB. 2.** To draw a tangent to any curve.

**Fig. 5.** When the abscissa CS of a curve moves uniformly from A to B, the motion of the curve will be retarded if it be concave, and accelerated if convex towards AB; for a straight line TC is described by an uniform motion, and the fluxion of the curve at any point is the same as the fluxion of the tangent, because it would describe the tangent if it continued to move equally from that point. Now if S<sub>1</sub> or C<sub>1</sub> be the fluxion of the base, C<sub>1</sub>d will be the fluxion of the tangent, and d<sub>1</sub>e of the ordinate. And because the triangles TSC, and d<sub>1</sub>ce, are equiangular, d<sub>1</sub>e : c<sub>1</sub> :: CS : ST, wherefore

**RULE.** Find a fourth proportional to the fluxion of the



the ordinate valued in terms of the abscissa, the fluxion of the abscissa, and the ordinate, and it determines the line ST, which is called the semi-tangent, and TC joined is a tangent to the curve.

Fig. 6. **EXAMP.** To draw a right line CT, to touch a given circle BCA in a given point C.

Let CS be perpendicular to the diameter AB, and put  $AB=a$ ,  $BS=x$ , and  $SC=y$ : Then, by the property of the circle,  $y^2 (CS^2) = BS \times AS (=x \times a-x) = ax - x^2$ ; whereof the fluxion being taken, in order to determine the ratio of  $x$  and  $y$ , we get  $2yy' = ax' - 2xx'$ ; consequently

$$\frac{x'}{y} = \frac{2y}{a-2x} = \frac{y}{\frac{1}{2}a-x}; \text{ which multiplied by } y, \text{ gives } \frac{yx'}{y} = \frac{y^2}{\frac{1}{2}a-x} = \text{the subtangent ST.}$$

Whence (O being supposed the centre) we have  $OS (\frac{1}{2}a-x) : CS (y) :: CS (y) : ST$ ; which we also know from other principles.

**PROB. 3.** To determine points of contrary flexure in curves.

Fig. 7. Supposing C to move uniformly from A to B, the curve DEF will be convex towards AB when the celerity of E increases, and concave when it decreases; therefore at the point where it ceases to be convex and begins to be concave, or the opposite way, the celerity of E will be uniform, that is,  $C'$  will have no second fluxion. Therefore,

**RULE.** Find the second fluxion of the ordinate in terms of the abscissa, and make it  $=0$ ; and from the equation that arises you get a value of the abscissa, which determines the point of contrary flexure.

**Ex.** Let the nature of the curve ARS be defined by the equation  $ay = a^{\frac{1}{2}}x^{\frac{1}{2}} + xx$ , (the abscissa AF and the ordinate FG being, as usual, represented by  $x$  and  $y$  respectively). Then  $y$ , expressing the celerity of the point  $r$ ,

in the line FH, will be equal to  $\frac{\frac{1}{2}a x^{\frac{1}{2}} + 2xx'}{a}$ : Whose

fluxion, or that of  $\frac{1}{2} a^{\frac{1}{2}} x^{-\frac{1}{2}} + 2x$  (because  $a$  and  $x$  are constant) must be equal to nothing; that is,  $-\frac{1}{4} a^{\frac{1}{2}} x^{-\frac{3}{2}} + 2x' = 0$ : Whence  $a^{\frac{1}{2}} x^{-\frac{3}{2}} = 8$ ,  $a^{\frac{1}{2}} = 8x^{\frac{3}{2}}$ ,  $64x^3 = a^3$ , and  $x = \frac{2}{3}a = AF$ ; therefore  $FG (= \frac{a^{\frac{1}{2}}x^{\frac{1}{2}} + xx}{a}) = \frac{2}{3}a$ : From

which the position of the point G is given.

**PROB. 4.** To find the radii of curvature.

The curvature of a circle is uniform in every point, that of every other curve continually varying; and it is measured at any point by that of a circle whose radius is of such a length as to coincide with it in curvature in that point.

All curves that have the same tangent have the same first fluxion, because the fluxion of a curve and its tangent are the same. If it moved uniformly on from the point of contact, it would describe the tangent. And the deflection from the tangent is owing to the acceleration or retardation of its motion, which is measured by its second fluxion; and consequently two curves which have not only the same tangent, but the same curvature at the

point of contact; will have both their first and second fluxions equal. It is easily proven from thence, that

the radius of curvature is  $= \frac{z^2}{-xy}$ , where  $x$ ,  $y$ , and  $z$  represent the abscissa, ordinate, and curve respectively.

**EXAMP.** Let the given curve be the common parabola, whose equation is  $y = a^{\frac{1}{2}}x^{\frac{1}{2}}$ : Then will  $y' = \frac{1}{2}a^{\frac{1}{2}}x^{-\frac{1}{2}} = \frac{a^{\frac{1}{2}}}{2x^{\frac{1}{2}}}$ , and (making  $x$  constant)  $y'' = -\frac{1}{4} \times \frac{1}{2} a^{\frac{1}{2}} x^{-\frac{3}{2}} = -\frac{a^{\frac{1}{2}}}{4x^{\frac{3}{2}}}$ : Whence  $z (\sqrt{x^2 + y^2}) = \frac{x}{2} \sqrt{\frac{4x+a}{x}}$ , and

$$\text{the radius of curvature } \left( \frac{z^2}{-xy} \right) = \frac{a+4x}{2\sqrt{ax}}$$

Which at the vertex, where  $x=0$ , will be  $=\frac{1}{2}a$ .

**INVERSE METHOD:**

*From a given fluxion to find a fluent.*

This is done by tracing back the steps of the direct method. The fluxion of  $x$  is  $x'$ ; and therefore the fluent of  $x$  is  $x$ : but as there is no direct method of finding fluents, this branch of the art is imperfect. We can assign the fluxion of every fluent, but we cannot assign the fluent of a fluxion, unless it be such a one as may be produced by some rule in the direct method from a known fluent.

**GENERAL RULE.** Divide by the fluxion of the root, add unity to the exponent of the power, and divide by the exponent so increased.

For, dividing the fluxion  $nx^{n-1}x'$  by  $x'$  (the fluxion of the root  $x$ ) it becomes  $nx^{n-1}$ ; and, adding 1 to the exponent  $(n-1)$  we have  $nx^n$ ; which, divided by  $n$ , gives  $x^n$ , the true fluent of  $nx^{n-1}x'$ .

Hence (by the same rule) the

Fluent of  $3x^2x'$  will be  $=x^3$ ;

That of  $8x^3x' = \frac{8x^4}{4}$ ;

That of  $2x^5x' = \frac{x^6}{3}$ ;

That of  $y^{\frac{1}{2}}y' = \frac{2}{3}y^{\frac{3}{2}}$ .

Sometimes the fluent so found requires to be corrected. The fluxion of  $x$  is  $x'$ , and the fluxion of  $a+x$  is also  $x'$ , because  $a$  is invariable, and has therefore no fluxion.

Now when the fluent of  $x'$  is required, it must be determined, from the nature of the problem, whether any invariable part, as  $a$ , must be added to the variable part  $x$ .

When fluents cannot be exactly found, they can be approximated by infinite series.

**Ex.** Let it be required to approximate the fluent of

$$\frac{a^2-x^2}{c^2-x^2} \times x^n x'$$

in an infinite series.

The value of  $\frac{a^2-x^2}{c^2-x^2}$ , expressed in a series, is  $\frac{a}{c} + \frac{a}{2c^3} \times x^2 + \frac{3a}{8c^5} \times x^4 + \frac{5a}{16c^7} \times x^6 + \dots$   
 $\frac{a}{2c^3} - \frac{1}{2ac} \times x^2 + \frac{3a}{8c^5} - \frac{1}{4ac^3} - \frac{1}{8a^3c} \times x^4 + \frac{5a}{16c^7} - \frac{3}{16ac} \times x^6 + \dots$   
 $\frac{1}{16a^3c^3} - \frac{1}{16a^5c} \times x^6 + \dots$ . Which value being therefore multiplied by  $x^n x$ , and the fluent taken (by the common method) we get  $\frac{a x^{n+1}}{n+1 \times c} + \frac{a}{2c^3} - \frac{1}{2ac} \times \frac{x^{n+3}}{n+3} + \frac{3a}{8c^5} - \frac{1}{4ac^3} - \frac{1}{8a^3c} \times \frac{x^{n+5}}{n+5} + \frac{5a}{16c^7} - \frac{3}{16ac^5} - \frac{1}{16a^3c^3} - \frac{1}{16a^5c} \times \frac{x^{n+7}}{n+7} + \dots$

PROB. 1. To find the area of any curve.

RULE. Multiply the ordinate by the fluxion of the abscissa, and the product gives the fluxion of the figure, whose fluent is the area of the figure.

EXAMP. 1. Fig. 8. Let the curve ARMH, whose area you will find, be the common parabola. Let  $u$  represent the area, and  $\dot{u}$  its fluxion.

In which case the relation of AB ( $x$ ) and BR ( $y$ ) being expressed by  $y^2 = ax$  (where  $a$  is the parameter) we thence get  $y = a^{\frac{1}{2}} x^{\frac{1}{2}}$ ; and therefore  $\dot{u} = RmHB (=y \dot{x}) = a^{\frac{1}{2}} x^{\frac{1}{2}} \dot{x}$ : whence  $u = \frac{2}{3} \times a^{\frac{1}{2}} x^{\frac{3}{2}} = \frac{2}{3} a^{\frac{1}{2}} x^{\frac{1}{2}} \times x = \frac{2}{3} yx$  (because  $a^{\frac{1}{2}} x^{\frac{1}{2}} = y$ ) =  $\frac{2}{3} \times AB \times BR$ : hence a parabola is  $\frac{2}{3}$  of a rectangle of the same base and altitude.

EXAMP. 2. Let the proposed curve CSDR (fig. 9.) be of such a nature, that (supposing AB unity) the sum of the areas CSTBC and CDGBC answering to any two proposed abscissas AT and AG, shall be equal to the area CRNBC, whose corresponding abscissa AN is equal to AT  $\times$  AG, the product of the measures of the two former abscissas.

First, in order to determine the equation of the curve, (which must be known before the area can be found) let the ordinates GD and NR move parallel to themselves towards HF; and then having put GD =  $y$ , NR =  $z$ , AT =  $a$ , AG =  $s$ , and AN =  $u$ , the fluxion of the area CDGB will be represented by  $y \dot{s}$ , and that of the area CRNB by  $z \dot{u}$ : which two expressions must, by the nature of the problem, be equal to each other; because the latter area CRNB exceeds the former CDGB by the area CSTB, which is here considered as a constant quantity: and it is evident, that two expressions, that differ only by a constant quantity, must always have equal fluxions.

Since, therefore,  $y \dot{s}$  is =  $z \dot{u}$ , and  $u = as$ , by hypothesis, it follows, that  $u = as$ , and that the first equation (by substituting for  $u$ ) will become  $y \dot{s} = a z \dot{s}$ , or  $y = az$ , or lastly  $y \dot{s} = z as$ , that is, GD  $\times$  AG = NR  $\times$  AN: therefore, GD : NR :: AN : AG; whence it appears, that every ordinate of the curve is reciprocally as its corresponding abscissa.

Now, to find the area of the curve so determined, put AB = 1, BC =  $b$ , and BG =  $x$ : then, since AG (1 +  $x$ )

: AB (1) :: BC ( $b$ ) : GD ( $y$ ) we have  $y = \frac{b}{1+x}$ , and

consequently  $\dot{u} (=y \dot{x}) = \frac{b \dot{x}}{1+x} = b \times \dot{x} - x \dot{x} + x^2 \dot{x} - x^3 \dot{x} + x^4 \dot{x} - \dots$ . Whence, BGD C, the area itself will be =  $b \times x - \frac{x^2}{2} + \frac{x^3}{3} - \frac{x^4}{4} + \frac{x^5}{5} - \dots$ , which was to be found.

Hence it appears, that as these areas have the same properties as logarithms, this series gives an easy method of computing logarithms; and the fluent may be found by means of a table of logarithms, without the trouble of an infinite series: and every fluxion whose fluent agrees with any known logarithmic expression, may be found the same way. Hence the fluents of fluxions of the following forms are deduced.

The fluent of  $\frac{x}{\sqrt{x^2 \pm a}}$ , = hyp. log. of  $x + \sqrt{x^2 \pm a}$ ;

of  $\frac{x}{\sqrt{2ax + xx}}$  = hyp. log. of  $a \times x + \sqrt{2ax + x^2}$ ;

of  $\frac{2ax}{a^2 - x^2}$  hyp. log. of  $\frac{a+x}{a-x}$ ;

and of  $\frac{2ax}{x \sqrt{a^2 \pm x^2}}$  = hyp. log. of  $\frac{a - \sqrt{a^2 \pm x^2}}{a + \sqrt{a^2 \pm x^2}}$ .

PROB. 2. To determine the length of curves.

Fig. 5. Because Cde is a right-angled triangle,  $Cd^2 = Ce^2 + de^2$ ; wherefore the fluxions of the abscissa and ordinate being taken in the same terms and squared, their sum gives the square of the fluxion of the curve; whose root being extracted, and the fluent taken, gives the length of the curve.

EXAMP. To find the length of a circle from its tangent. Make the radius AO (fig. 5.) =  $a$ , the tangent of AC =  $t$ , and its secant =  $s$ , the curve =  $z$ , and its fluxion =  $\dot{z}$ ; because the triangles OTC, OCS, are similar, OT : OC :: OC :: OS; whence OS =  $\frac{a^2}{s}$ , and SA =  $a - \frac{a^2}{s} = a - \frac{a^2}{\sqrt{a^2 + t^2}}$ ; whose

fluxion is  $\frac{a^2 \dot{t}}{a^2 + t^2}$ ; and because the triangles OTC,

$dCe$  are similar, TC (=  $t$ ): TO (=  $\sqrt{a^2 + t^2}$ ) :: Ce =  $\left( \frac{a^2 \dot{t}}{a^2 + t^2} \right)$ : Cd =  $\frac{a^2 \dot{t}}{a^2 + t^2}$  = fluxion of the curve.

Now by converting this into an infinite series, we have the fluxion of the curve =  $t - \frac{t^3}{a^2} + \frac{t^5}{a^4} - \frac{t^7}{a^6} + \dots$ , and consequently  $z = t - \frac{t^3}{3a^2} + \frac{t^5}{5a^4} - \frac{t^7}{7a^6} + \frac{t^9}{9a^8} - \dots$ , = AR.

Where, if (for example's sake) AR be supposed an arch of 30 degrees, and AO (to render the operation more easy) be put = unity, we shall have  $t = \sqrt{3} = .5773502$  (because Ob  $\sqrt{3}$ : bR (1) :: OA (1) : AT ( $t$ ) =  $\sqrt{3}$ ) Whence,

$$t^3 (=t \times t^2 = t \times 3) = .1924500$$

$$t^5 (=t^3 \times t^2 = \frac{t^3}{3}) = .0641500$$

$$\begin{aligned}
 t^6 & \left( = t^5 \times t = \frac{t^6}{3} \right) = .0213833 \\
 t^7 & \left( = t^6 \times t = \frac{t^7}{3} \right) = .0071277 \\
 t^8 & \left( = t^7 \times t = \frac{t^8}{3} \right) = .0023759 \\
 t^9 & \left( = t^8 \times t = \frac{t^9}{3} \right) = .0007919 \\
 t^{10} & \left( = t^9 \times t = \frac{t^{10}}{3} \right) = .0002639 \\
 & \text{&c.}
 \end{aligned}$$

And therefore AR =  $\frac{.1934500}{3} + \frac{.0641500}{5} - \frac{.0213833}{7} \times \frac{.0091277}{9} - \frac{.0023759}{11} + \frac{.0007919}{13} - \frac{.0002639}{15} + \frac{.0000879}{17} - \frac{.0000293}{19} + \frac{.0000097}{21} - \frac{.0000032}{23} = .5235987$ : for the length of an arch of 30 degrees, which multiplied by 6 gives 3.141592 + for the length of the semi-periphery of the circle whose radius is unity.

Other series may be deduced from the versed sine, sine and secant; and these are of use for finding fluents which cannot be expressed in finite terms. For,

the fluent of	}	is equal to the arch whose	$\frac{w}{\sqrt{2aw-w^2}}$	} is $\frac{w}{a}$ , and Radius Unity.
			$\frac{w}{\sqrt{a^2-w^2}}$	
			$\frac{aw}{a^2+w^2}$	
			$\frac{aw}{w\sqrt{w^2-a^2}}$	
			Verfed-sine	
			Right-sine	
			Tangent	
			Secant	

PROB. 3. To find the contents of a solid.

Let the surface of the generating plane be multiplied by the space it passes through in any time, the product will give a solid which is the fluxion of the solid required: the surface must therefore be computed in terms of  $x$ , which represents the line or axis on which it moves, and by its motion on which the fluxion is to be measured, and the fluent found will give the contents of the solid.

EXAMP. Let it be proposed to find the content of a cone ABC, fig. 10.

Put the given altitude (AD) of the cone =  $a$ , and the semi-diameter (BD) of its base =  $b$ , the solid =  $s$ , its fluxion =  $\dot{s}$ , and the area of a circle, whose radius is unity, =  $p$ : then the distance (AF) of the circle EFG, from the vertex A, being denoted by  $x$ , &c. we have, by similar triangles, as  $a : b :: x : EF (y) = \frac{bx}{a}$ . Whence in this case,  $\dot{s}$

$$(= \dot{p} y^2 x) = \frac{\dot{p} b^2 x^3}{a^2}; \text{ and consequently } s = \frac{\dot{p} b^2 x^3}{3a^2};$$

which, when  $x = a$  (=AD) gives  $\frac{\dot{p} b^2 a}{3}$  (=  $\dot{p} \times B D^2 \times \frac{1}{3} A D$ ) for the content of the whole cone ABC: which appears from hence to be just  $\frac{1}{3}$  of a cylinder of the same base and altitude.

PROB. 4. To compute the surface of any solid body.

The fluxion of the surface of the solid is equal to the periphery of the surface, by whose motion the solid is generated, multiplied by its velocity on the edge of the solid, and the computation is made as in the foregoing.

EXAMP. Fig. 11. Let it be proposed to determine the convex superficies of a cone ABC.

Then, the semi-diameter of the base (BD, or CD) being put =  $b$ , the slanting line, or hypotenuse AC =  $c$ , and FH (parallel to DC) =  $y$ , AG =  $x$ , the surface =  $w$ , its fluxion =  $\dot{w}$ , and  $p$  = the periphery of a circle whose diameter is unity, we shall, from the similarity of the triangles ADC and Hmb, have  $b : c :: y : mb : z (Hb) = \frac{cy}{b}$ : whence  $\dot{w} (2py\dot{z}) =$

$$\frac{2pcy\dot{z}}{b}; \text{ and consequently } w = \frac{pcy^2}{b}. \text{ This, when }$$

$y = b$ , becomes =  $pcb = p \times DC \times AC$  = the convex superficies of the whole cone ABC: which therefore is equal to a rectangle under half the circumference of the base and the slanting line.

The method of fluxions is also applied to find the centres of gravities, and oscillation of different bodies; to determine the paths described by projectiles and bodies acted on by central forces, with the laws of centripetal force in different curves; the retardates given to motions performed in resisting media; the attractions of bodies under different forms; the direction of wind, which has the greatest effect on an engine; and to solve many other curious and useful problems.

F L Y

FLY in zoology. See NATURAL HISTORY.

FLY, in mechanics, a cross with leaden weights at its ends; or rather a heavy wheel at right angles to the axis of a windlass, jack, or the like; by means of which the force of the power, whatever it be, is not only preserved, but equally distributed in all parts of the revolution of the machine. See MECHANICS.

FLYING, the progressive motion of a bird, or other-winged animal, in the air.

The parts of birds chiefly concerned in flying are

F L Y

the wings, by which they are sustained or wafted along. The tail, Messrs Willughby, Ray, and many others, imagine to be principally employed in steering and turning the body in the air, as a rudder: but Borelli has put it beyond all doubt, that this is the least use of it, which is chiefly to assist the bird in its ascent and descent in the air; and to obviate the vacillations of the body and wings: for, as to turning to this or that side, it is performed by the wings and inclinations of the body, and but very little by the help of the tail. The flying

Flying of a bird, in effect, is quite a different thing from the roving of a vessel. Birds do not vibrate their wings towards the tail, as oars are struck towards the stern, but waft them downwards; nor does the tail of the bird cut the air at right angles, as the rudder does the water; but is disposed horizontally, and preserves the same situation what way soever the bird turns.

In effect, as a vessel is turned about on its centre of gravity to the right, by a brisk application of the oars to the left, so a bird in beating the air with its right wing alone, towards the tail, will turn its fore part to the left. Thus pigeons changing their course to the left, would labour it with their right wing, keeping the other almost at rest. Birds of a long neck alter their course by the inclinations of their head and neck, which altering the course of gravity, the bird will proceed in a new direction.

*The manner of FLYING* is thus: the bird first bends his legs, and springs with a violent leap from the ground; then opens and expands the joints of his wings, so as to make a right line perpendicular to the sides of his body: thus the wings with all the feathers therein, constitute one continued lamina. Being now raised a little above the horizon, and vibrating the wings with great force and velocity perpendicularly against the subject air, that fluid resists those successions, both from its natural inactivity and elasticity, by means of which the whole body of the bird is protruded. The resistance the air makes to the withdrawing of the wings, and consequently the progress of the bird, will be so much the greater, as the waft or stroke of the fan of the wing is longer: but as the force of the wing is continually diminished by this resistance, when the two forces continue to be in equilibrio, the bird will remain suspended in the same place; for the bird only ascends so long as the arch of air the wing describes makes a resistance equal to the excess of the specific gravity of the bird above the air. If the air, therefore, be so rare as to give way with the same velocity as it is struck withal, there will be no resistance, and consequently the bird can never mount. Birds never fly upwards in a perpendicular line, but always in a parabola. In a direct ascent, the natural and artificial tendency would oppose and destroy each other, so that the progress would be very slow. In a direct descent they would aid one another, so that the fall would be too precipitate.

**FLYING FISH**, a name given by the English writers to several species of fish, which, by means of their long fins, have a method of keeping themselves out of water a long time. See **EXOCOETUS**.

**FLYING FINION**, is part of a clock, having a fly, or fan, whereby to gather air, and so bridle the rapidity of the clock's motion, when the weight descends in the striking part.

**FOAL**, or **COLT**, the young of the horse kind. The word colt, among dealers, is understood of the male kind. See **EQUUS** and **HORSEMANSHIP**.

**FOCHEN**, a town of China capital of the province of Fokein: E. long. 118°, N. lat. 26° 20'.

**FOCUS**, in geometry and conic sections, is applied to certain points in the parabola, ellipsis and hyperbola, where the rays reflected from all parts of these curves concur and meet. See **CONIC SECTIONS**.

**FOCUS**, in optics, is the point wherein rays are collected after they have undergone reflection or refraction. See **OPTICS**.

**FOENUGREEK**, in botany. See **TRICONELLA**.

**FOETOR**, in medicine, stinking or foetid effluvia, arising from the body or any part thereof.

**FOETUS**, denotes the child while it is contained in the mother's womb, but particularly after it is formed, till which time it is more properly called embryo. See **MIDWIFERY**.

**FOG**, or **MIST**, a meteor, consisting of gross vapours, floating near the surface of the earth.

**FOIL**, among glass-grinders, a sheet of tin, with quicksilver or the like, laid on the backside of a looking-glass, to make it reflect.

**FOIL**, among jewellers, a thin leaf of metal placed under a precious stone, in order to make it look transparent, and give it an agreeable different colour, either deep or pale: thus, if you want a stone to be of a pale colour, put a foil of that colour under it; or if you would have it deep, lay a dark one under it.

**FOLIA**, among botanists, particularly signify the leaves of plants; those of flowers being expressed by the word petal. See **BOTANY**.

**FOLIACEUM EXPANSUM**, in anatomy, a term applied to the extreme part of the Fallopian tube, next the ovary, which is expanded like the mouth of a trumpet, and surrounded with a sort of fringe.

**FOLIAGE**, a cluster or assemblage of flowers, leaves, branches &c.

**FOLIAGE** is particularly used for the representations of such flowers, leaves, branches, rinds, &c. whether natural or artificial, as are used for enrichments on capitals, friezes, pediments, &c.

**FOLIO**, in merchants books, denotes a page, or rather both the right and left hand pages, these being expressed by the same figure, and corresponding to each other. See **BOOK-KEEPING**.

**FOLIO**, among printers and booksellers, the largest form of books, when each sheet is so printed, that it may be bound up in two leaves only.

**FOLKSTONE**, a market town of Kent, six miles west of Dover.

**FOMAHANT**, in astronomy, a star of the first magnitude, in the constellation aquarius.

**FOMENTATION**, in medicine, the bathing any part of the body with a convenient liquor; which is usually a decoction of herbs, water, wine, or milk; and the applying of bags stuffed with herbs and other ingredients, which is commonly called dry fomentation.

**FONDI**, a city and bishop's see of Naples, in the province of Lavoro, about thirty-five miles north-west of Capua: E. long. 14° 20', and N. lat. 41° 35'.

**FONT**, among ecclesiastical writers, a large basin, in which water is kept for the baptizing of infants, or other persons.

FON-

**FONTAINE**, a town of Hainalt, fifteen miles east of Mons.

**FONTAINEBLEAU**, a village of the isle of France, about thirty miles south-east of Paris; remarkable for an elegant royal palace.

**FONTANELLA**, in anatomy, the quadrangular aperture, between the os frontis and ossa sincipitis, in infants just born.

**FONTARABIA**, a port-town of Spain, in the province of Biscay, twenty miles west of Bayonne: W. long.  $1^{\circ} 35'$ ; and N. lat.  $43^{\circ} 20'$ .

**FONTENAYLE**, a town of Orleans, in France, about forty-six miles west of Poitiers.

**FONTENOY**, a town of Hainalt, situated three miles south east of Tournay.

**FONTEVRAUD**, or *Order of FONTEVRAUD*, a religious order instituted about the latter end of the XIth century. By the rules of this order the nuns were to keep silence for ever, and their faces to be always covered with their veils; and the monks wore a leathern girdle, at which hung a knife and sheath.

**FONTICULUS**, or *FONTANELLA*, in surgery, an issue, seton, or small ulcer made in various parts of the body, in order to eliminate the latent corruption out of it.

**FONTINALIS**, in botany, a genus of the cryptogamia musci class. The anthera is operculated, and the calyptra is sessile. There are four species, all natives of Britain, viz. the antipyretica, or greater water-moss; the minor, or lesser water-moss; the squamosa, or scaly water-moss; and the pennata, or feathered water-moss.

**FOOD** implies whatever aliments are taken into the body, to nourish it. See **MEDICINE**

**FOOL**, according to Mr Locke, is a person who makes false conclusions from right principles; whereas a madman, on the contrary, draws right conclusions from wrong principles.

**FOOL'S STONES**, in botany. See **ORCHIS**.

**FOOT**, a part of the body of most animals whereon they stand, walk, &c. See **NATURAL HISTORY**.

**FOOT**, in anatomy. See **ANATOMY**, part I.

**FOOT**, in the Latin and Greek poetry, a metre or measure, composed of a certain number of long and short syllables.

These feet are commonly reckoned twenty-eight, of which some are simple, as consisting of two or three syllables, and therefore called disyllabic or trisyllabic feet; others are compound, consisting of four syllables, and are therefore called tetrasyllabic feet.

The disyllabic feet are four in number, viz. the pyrrhichius, spondeus, iambus, and trocheus. See **PYRRHICHIVS**, &c.

The trisyllabic feet are eight in number, viz. the dactylus, anapæstus, tribrachys, molossus, amphibrachys, amphimacer, bacchius, and antibacchius. See **DACTYL**, &c.

The tetrasyllabic are in number sixteen, viz. the proclufmaticus, dispondeus, choriambus, antispastus, diiambus, dichoreus, ionicus a majore, ionicus a minore, epitritus primus, epitritus secundus, epitritus

tertius, epitritus quartus, pæon primus, pæon secundus, pæon tertius, and pæon quartus. See **PROCLEUSMATICUS**, &c.

**FOOT** is also a long measure, consisting of 12 inches.

Geometricians divide the foot into 10 digits, and the digit into 10 lines.

**FOOT square**, is the same measure both in breadth and length, containing 144 square or superficial inches.

**Cubic or Solid FOOT**, is the same measure in all the three dimensions, length, breadth, and depth or thickness, containing 1728 cubic inches.

**FOOT of a horse**, in the menage, the extremity of the leg, from the coronet to the lower part of the hoof.

**FOOT LEVEL**, among artificers, an instrument that serves as a foot-rule, a square, and a level. See **LEVEL**, **RULE**, and **SQUARE**.

**FORAMEN**, in anatomy, a name given to several apertures or perforations in divers parts of the body; as,  
1. The external and internal foramina of the cranium or skull.  
2. The foramina, in the upper and lower jaw.  
3. Foramen lachrymale.  
4. Foramen membranæ tympani. See **ANATOMY**.

**FORCALQUIER**, a town of Provence, in France, thirty miles north of Aix.

**FORCE**, in mechanics, denotes the cause of the change in the state of a body when being at rest it begins to move, or has a motion which is either not uniform or not direct. See **MECHANICS**.

*Central FORCES*. See **MECHANICS**.

**FORCE**, in law, signifies any unlawful violence offered to things or persons.

**FORCEPS**, in surgery, &c. a pair of scissors for cutting off, or dividing, the fleshy membranous parts of the body, as occasion requires. See **SURGERY**.

**FORE-CASTLE OF A SHIP**, that part where the fore-mast stands. It is divided from the rest by a bulk-head.

**FOREIGN**, some thing extraneous, or that comes from abroad.

**FOREIGNER**, the natural born subject to some foreign prince.

Foreigners, tho' made denizens, or naturalized, are disabled to bear any office in the government, to be of the privy council, or members of parliament, &c. This is by the acts of the settlement of the crown. Such persons as are not freemen of a city, or corporation, are also called foreigners, to distinguish them from the members of the same.

**FORELOCKS**, in the sea-language, little flat wedges made with iron, used at the ends of bolts, to keep them from flying out of their holes.

**FORELORN-HOPE**, in the military art, signifies men detached from several regiments, or otherwise appointed, to make the first attack in day of battle; or, at a siege, to storm the counterscarpe, mount the breach, or the like.

They are so called from the great danger they are unavoidably exposed to; but the word is old, and begins to be obsolete.

**FORE-MAST OF A SHIP**, a large round piece of timber, placed in her fore-part, or fore-castle, and carrying the fore-sail and fore-top sail yards. Its length is usually  $\frac{1}{2}$  of the main-mast, and the fore top-gallant mast is  $\frac{1}{3}$  the length of the fore-top.

**FOREMAST-MEN**, are those on board a ship that take in the top-sails, sling the yards, furl the sails, bowse, trice, and take their turn at the helm, &c.

**FOREST**, in general, a great wood, or a large extent of ground covered with trees.

**FOREST**, in law, is defined by Manwood, a certain territory of woody grounds, and fruitful pastures, privileged for wild beasts and fowls of forest, chase and warren, to rest and abide under the protection of the king, for his princely delight, bounded with unremoveable marks, and meres, either known by matter of record or prescription; replenished with wild beasts of venery, or chase, with great covers of vert for the said beasts; for preservation and continuance whereof, with the vert and venison, there are certain particular laws, privileges, and officers.

Forests are of that antiquity in England, that, excepting the new forest in Hampshire erected by William the Conqueror, and Hampton Court erected by Henry VIII. it is said that there is no record or history which makes any certain mention of their erection, though they are mentioned by several writers, and in divers of our laws and statutes.

There are sixty-nine forests in England, thirteen chafes, and 800 parks. The four principal forests are New Forest, Sherwood Forest, Dean Forest, and Windsor Forest.

**FOREST-TOWNS**, in geography, certain towns of Swabia, in Germany, lying along the Rhine and the confines of Switzerland, and subject to the house of Austria. Their names are Rhinefeld, Seckingen, Lausenbourg, and Waldshut.

**FORE-STAFF, or CROSS-STAFF**, an instrument used at sea for taking the altitude of the sun, moon or stars.

**FORESTALLER**, a person who is guilty of forestalling. See the next article.

**FORESTALLING**, in law, buying or bargaining for any corn, cattle, victuals, or merchandize, in the way as they come to fairs or markets to be sold, before they get thither, with an intent to sell the same again at a higher price.

The punishment for this offence, upon conviction at the quarter sessions, by two or more witnesses, is, for the first time, two months imprisonment and the loss of the goods, or the value; for the second offence, the offender shall be imprisoned six months, and lose double the value of the goods; for the third offence, he shall suffer imprisonment during the king's pleasure, forfeit all his goods and chattels, and stand on the pillory: but the statute does not extend to maltsters buying barley, or to badgers licensed.

**FORESTER**, a sworn officer of the forest, appointed by the king's letters-patent, to walk the forest at all hours, watch over the vert and venison; also to make attachments and true presentments of all trespasses committed within the forest.

**FORETHOUGHT FELONY**, in Scots law, signifies premeditated murder.

**FORFAR**, the capital of the county of Angus, in Scotland: W. long.  $2^{\circ} 32'$ , and N. lat.  $56^{\circ} 25'$ .

It is a parliament town, classed with Perth, Dundee, Coupar, and St Andrews, which all together send out member.

**FORFEITURE**, properly signifies the effect of transgressing some penal law, and extends to lands or goods.

**FORFICULA**, the **EAR-WIG**, in zoology, a genus of insects belonging to the order of coleoptera. The antennae are bristly; the elytra are dimidiated: the wings are covered; and the tail is forked. There are two species, viz. the auriculata, or common ear-wig, with the tops of the clytra white; and the minor, with testaceous and unspotted elytra.

**FORGE**, properly signifies a little furnace, wherein smiths and other artificers of iron or steel, &c. heat their metals red-hot, in order to soften them and render them more malleable and manageable on the anvil.

**FORGE** is also used for a large furnace, wherein iron-ore, taken out of the mine, is melted down: or it is more properly applied to another kind of furnace, wherein the iron-ore, melted down and separated in a former furnace, and then cast into sows and pigs, is heated and fused over again, and beaten afterwards with large hammers, and thus rendered more soft, pure, ductile, and fit for use.

**FORGER**, in law, one guilty of forgery. See the next article.

**FORGERY**, in a legal sense, is where a person fraudulently makes and publishes false writings to another's prejudice: or, it signifies the writ that lies against him who offends that way.

**FORISFAMILIATION**, in law, when a child, upon receiving a portion from his father, or otherwise renounces his legal title to any further share of his father's succession, he is said to be *forisfamiliated*. See **SCOTS LAW**, title 23.

**FORLI**, a town of Romania, in the pope's territories, fifty miles south-west of Ravenna.

**FORM**, in physics, the essential or distinguishing modification of the matter whereof a natural body is composed, so as thereby to give it such a particular manner of existence; being that which constitutes it such a particular body, and distinguishes it from every other body.

**FORM** is also used, in a moral sense, for the manner of being or doing a thing according to rules: thus we say, a form of government, a form of argument, &c.

**FORM**, in law, the rules established and requisite to be observed in legal proceedings.

**FORM**, in carpentry, is used to denote the long seats or benches in the choirs of churches or in schools, for the priests, prebends, religious, or scholars to sit on. At schools, the word form is frequently applied to what is otherwise termed a class. See **CLASS**.

**FORM** also denotes the external appearance or surface of a body, or the disposition of its parts, as to the length, breadth, and thickness.

**FORM**

**FORM** is also used, among mechanics, for a sort of mould whereon any thing is fashioned or wrought: as the hatter's form, the paper-maker's form, &c.

**Printer's FORM**, an assemblage of letters, words, and lines, ranged in order, and so disposed into pages by the compositor; from which, by means of ink and a press, the printed sheets are drawn.

Every form is inclosed in an iron-chase, wherein it is firmly locked by a number of pieces of wood; some long and narrow, and others of the form of wedges. There are two forms required for every sheet, one for each side; and each form consists of more or fewer pages, according to the size of the book.

**FORMAL**, something belonging to, or constituting the form of a thing. See **FORM**.

**FORMICA**, or the **АНТ**, in zoology, a genus of insects belonging to the order of hymenoptera, the characters of which are these: There is a small scale betwixt the breast and belly, and the joint is so deep that the animal appears as if it were almost cut through the body. The females, and the neuters or working ants which have no sexual characteristics, are furnished with a hidden sting; and both the males and females have wings, but the neuters have none. There are eighteen species, most of them distinguished by their colours.

These insects keep together in companies like the bees, and maintain a sort of republic. Their nest is not exactly square, but longer one way than the other; and in it there are a sort of paths, which lead to different magazines. Some of the ants are employed in making the ground firm, by mixing it with a sort of glue, for fear it should crumble, and fall down upon their heads. They may be sometimes seen to gather several twigs, which serve them for rafters, which they place over the paths, to support the covering; they lay others across them, and upon them rushes, weeds, and dried grass, which they heap up into a double declivity, which serves to turn off the water from their magazines. Some of these serve to lay up their provisions in, and in others they lay their eggs.

As for the provisions, they lay up every thing that is fit for them to eat; and you may often see one loaded with pippin, or grain of fruit, another with a dead fly, and several together with the carcase of a may-bug, or other insect. If they meet with any they cannot bring away, they eat it upon the spot, or at least so much of it, as may reduce it to a bulk small enough for them to carry. They do not run about where they please, at all adventures: for some of them are sent abroad to make discoveries; and if they bring back news they have met with a pear, or a sugar-loaf, or a pot of sweatmeats, they will run from the bottom of the garden, as high as the third story of a house, to come at it. They all follow each other in the same path, without wandering to the right or the left; but in the fields they are more at their liberty, and are allowed to run about in search of game. There is a sort of green fly, that does a great deal of mischief among the flowers, and which curl up the leaves of peach and pear trees; and these

are surrounded with a sort of glue, or honey, which the ants hunt after very greedily; for they touch neither the plant nor the flies themselves.

Next to this, their greatest passion is to lay up hoards of wheat, and other corn; and for fear the corn should sprout by the moisture of the subterraneous cells, they gnaw off the end which would produce the blade. The ants are often seen pushing along grains of wheat, or barley, much larger than themselves.

In Africa, and particularly in Guiney, the ants are exceeding troublesome, and do a great deal of mischief. They make their nests of earth in the fields, twice as high as a man; besides which they build large nests in high trees, from which places they advance in such prodigious swarms to the houses, that they frequently oblige the inhabitants to quit their beds in the night-time. They will sometimes attack a living sheep, which in a night's time they will reduce to a perfect skeleton, leaving not the least thing except the bones. It is common for them to serve domestic fowls in the same manner, and even the rats themselves cannot escape them. If you place a worm or a beetle where only one or two ants are, they will immediately depart, and bring with them above an hundred; after which they seize their prey, and march off with it in good order. These ants are of various sorts, some great, others small, some black, and others red; the sting of this last is very painful, and causes an inflammation; the white are as transparent as crystal, and have such strong teeth, that in a night's time they will eat their way through a thick wooden chest, and make it as full of holes as if it had been penetrated by hail-shot.

There are also several sorts of ants in the East Indies, whose numbers are prodigious: some of them are exceeding large, and of a ruddy colour, inclining to black; and some have wings, but others have none. They are very pernicious to the fruits of the earth, and do a great deal of mischief in houses, unless great care is taken to prevent them. It is remarkable, that if one ant meets another that is laden, it always gives way to let it pass freely.

The ant lays eggs in the manner of the common flies, and from these eggs are hatched a sort of small maggots or worms without legs: these are sharp at one end and blunt at the other; and are white, but so transparent, that the intestines are seen through the skin. These, after a short time, change into large white aureliæ, which are what are usually called ants eggs. That end which is to be the tail is the largest, and that which is the head is somewhat transparent.

The ants move these about at pleasure with their forceps. It is well known, that when a nest of these creatures is disturbed and the aureliæ scattered about, the ants are at infinite pains to get together all that are unhurt, and make a nest for them again: nay, any ants will do this, and those of one nest will often take care of the aureliæ of another.

The affection of the ant for its offspring is amazing. They carry the young worms about in their mouths, that nothing may injure them; and when the earth

earth of the nest is dry, they carry them down to a greater depth, but when wet they bring them to the surface, that they may not be injured by the damps.

The common ant builds only with small pieces of dry earth, and there is always found a vast quantity either of eggs, worms, or aureliæ, at the bottom of the nest. The aureliæ are covered only with a thin skin; and when carefully opened, they shew the worm perfect, and in its several stages of perfection.

The forecast of ants in providing against the winter is a mistake. They are supposed not to eat in the winter, but to spend that season, like dormice and many other sorts of animals, in a state of sleep. What confirms this is, that they have been observed, as the cold draws on in the autumn, to move very heavily, and in the vintage-time they can hardly stir at all; so that the provision they make seems intended not for themselves, but for their young.

The care these creatures take of their offspring is remarkable. Whenever a hill is disturbed, all the ants are found busied in consulting the safety, not of themselves, but of the eggs or these larger bodies enclosing the maggot or young ant; they carry these down any way so as to get them out of sight, and will do this over and over as often as they are disturbed.

They carry away the eggs and vermicles together in their confusion; but as soon as the danger is over, they carefully separate them, and place each sort in parcels by themselves under shelter of different kinds, and at various depths, according to the different degrees of warmth and coverture the different states require.

In the warm season of the year, they every morning bring up the eggs, as they are usually called, to the surface, or nearly so; and from ten in the forenoon to five in the afternoon or thereabouts, all these will be found just under the surface; and if the hills be examined toward eight in the evening, they will be found to have carried them all down; and if rainy weather be coming on, it will be necessary to dig a foot deep or more, in order to find them.

These little creatures are very troublesome in gardens, and in pasture-lands; as well by feeding on the fruit, as by making up hills for their habitation. In the hotter countries, as Italy, Spain, and the West Indies; ants are the great pest of the fields. Trees may be preserved from them by encompassing the stem, for four fingers breadth, with a roll of wool, newly pulled from the sheep's belly; or by laying saw-dust all round the stump of it. Some anoint the tree with tar, which has the same effect.

The large, black, winged ants of America, to avoid the great rains which fall there at particular seasons, make to themselves large nests on trees, with a covered way for them to go up and down on the lee-side of the tree. These nests are roundish on the outside, made of light brown earth, plastered smooth. They are larger than a bushel; and in the inside are many sinous caverns or lodgings communicating with one another. See Plate LXXX. fig. 1. A, The ants

nest; B, The tubular passage, made of the same materials.

FORMICA, in medicine, a callous sort of wart.

FORMICA-LEO, the ANT-LION, or ANT-EATER, in zoology, an insect so called from its devouring great numbers of ants. It is the caterpillar or worm of a fly much resembling the libellæ or dragon-flies.

The address of this insect in catching the ant is admirable; it makes a hole of a conical or funnel shape, in the loose sand; and is sure to catch all the ants that come within the verge of this hole, by throwing up sand on them, whereby they are forcibly carried into the power of the enemy at the bottom of the hole.

FORMOSA, an island in the pacific ocean, between 119° and 122° of E. long. and between 22° and 25' N. lat. about 100 miles east of Canton in China. It is subject to the Chinese.

FORMULA, or FORMULARY, a rule or model, or certain terms prescribed or decreed by authority, for the form and manner of an act, instrument, proceeding, or the like.

FORMULA, in church-history and theology, signifies a profession of faith.

FORMULA, in medicine, imports the constitution of medicines, either simple or compound, both with respect to their prescription and consistence.

FORMULARY, a writing containing the form of an oath, declaration, attestation, abjuration, &c. to be made on certain occasions.

FORNACALIA, or FORNICALIA, in Roman antiquity, a festival instituted by Numa in honour of Fornax, the goddess of ovens; wherein certain cakes were made, and offered in sacrifice before the ovens.

FORNICATION, the act of incontinency between single persons; for when either of the parties is married, such act is adultery. See ADULTERY.

FORNIX, in anatomy. See ANATOMY, p. 285.

FORRAGE, in the military art, denotes hay, oats, barley, wheat, grass, clover, &c. brought into the camp by the troopers, for the sustenance of their horses.

It is the business of the quarter-master-general to appoint the method of forrage, and post proper guards for the security of the forragers.

FORRES, a parliament-town of Scotland in the county of Murray, about thirteen miles west of Elgin: W. long. 3° 20', and N. lat. 57° 40'.

It is classed with Inverness, Fortrose, and Nairn.

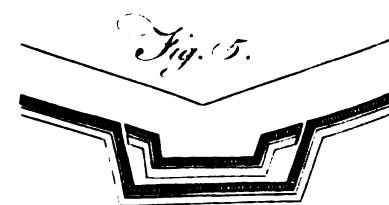
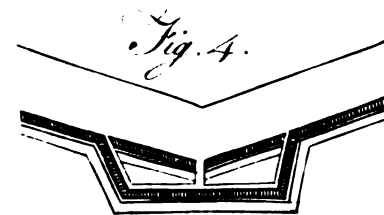
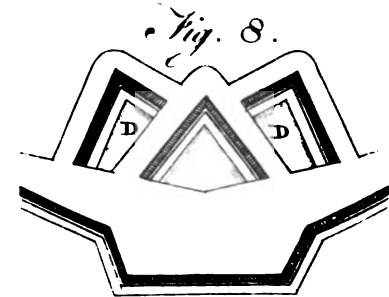
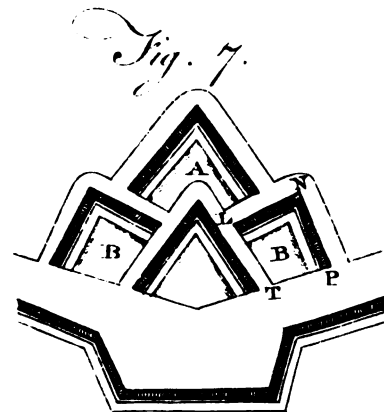
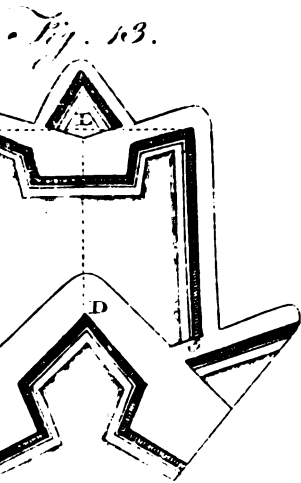
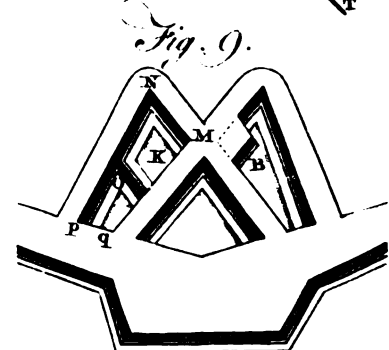
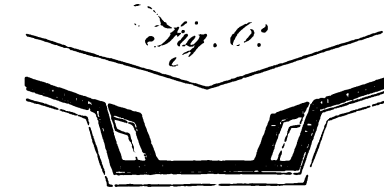
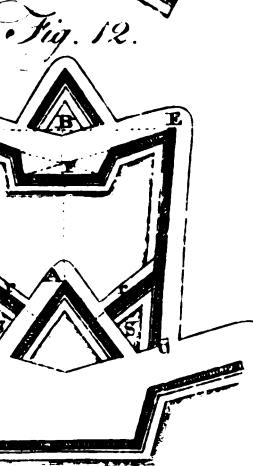
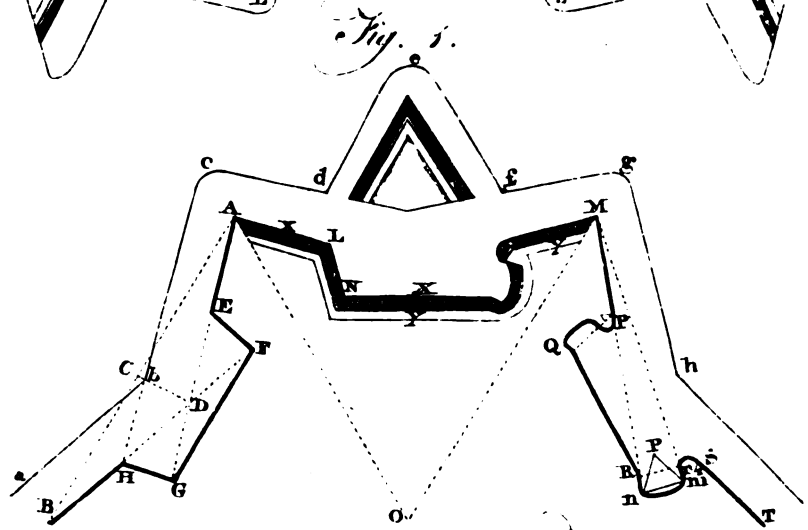
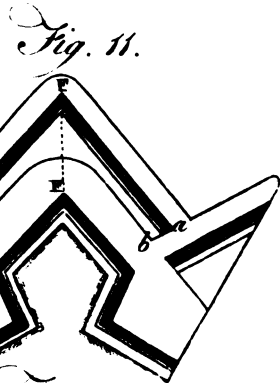
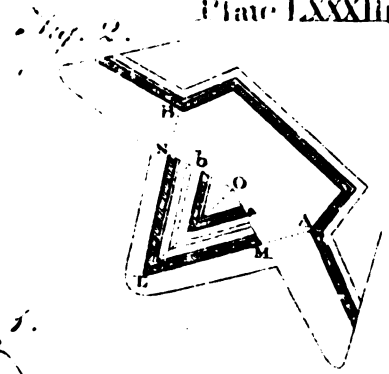
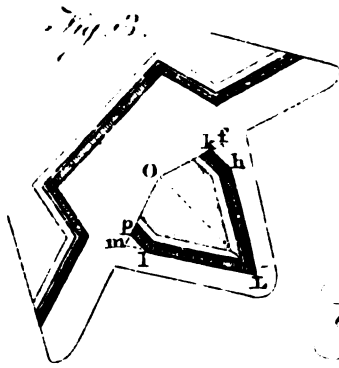
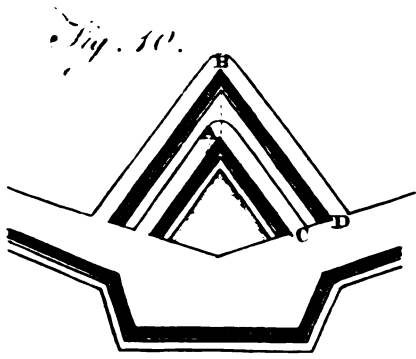
FORT, in the military art, a small fortified place, environed on all sides with a moat, rampart, and parapet. Its use is to secure some high ground or the passage of a river, to make good an advantageous post, to defend the lines and quarters of a siege, &c.

FORTALICE, in Scots law, signified anciently a small place of strength, originally built for the defence of the country; and which on that account was formerly reckoned *inter regalia*, and did not go along with the lands upon which it was situated without a special grant from the crown. Now, fortalices are granted by a general grant of the lands; and the word is become synonymous with manor-place, messuages &c.

FORTIFICATION.







A. Bell. Sc.

# F O R T I F I C A T I O N .

**F**ORTIFICATION, the art of fortifying a town, or other place; or of putting them in such a posture of defence, that every one of its parts defends, and is defended by some other parts, by means of ramparts, parapets, moats, and other bulwarks; to the end, that a small number of men within, may be able to defend themselves for a considerable time against the assaults of a numerous army without; so that the enemy in attacking them, must of necessity suffer great loss.

Fortification is either ancient or modern, regular or irregular. Ancient fortification, at first, consisted of walls or defences made of trunks and other branches of trees mixed with earth, to secure them against the attacks of the enemy. This was afterwards altered to stone walls, on which were raised breast-works, behind which they made use of their darts and arrows in security. Modern fortification is that which is flanked and defended by bastions and out works, the ramparts of which are so solid, that they cannot be beat down but by the continual fire of several batteries of cannon. Regular fortification, is that built in a regular polygon, the sides and angles of which are all equal, being commonly about a musket-shot from each other. Irregular fortification, on the contrary, is that where the sides and angles are not uniform, equidistant, or equal; which is owing to the irregularity of the ground, valleys, rivers, hills, and the like.

## SECTION I. *Of Regular Fortification.*

THE art of regular fortification may be distinguished into two parts, *viz.* the elementary or theoretical, and practical.

The elementary part consists in tracing the plans and profiles of a fortification on paper, with scales and compasses; and to examine the systems proposed by different authors, in order to discover their advantages and disadvantages.

And the practical part consists in forming a project of a fortification, according to the nature of the ground and other necessary circumstances, to trace it on the ground, and to execute the project, together with all the military buildings, such as magazines, store-houses, bridges, &c.

Notwithstanding all the improvements which have been made in the art of fortifying since the invention of gunpowder, that of attacking is still superior to it: engineers have tried in vain to render the advantages of a fortification equal to those of the attack; the superiority of the besiegers fire, together with the greater number of men, obliges generally, sooner or later, the besieged to submit.

The greatest improvement made in the art of attacking

happened in the year 1697, when M. Vauban made first use of ricochet firing at the siege of Ath, whereby the besieged placed behind the parapets were as much exposed to the fire of the besiegers as if there had been none; whereas before, they had been secure as long as the parapet was not demolished: and the worst is, that there can be no remedy found to prevent this enslaving without falling into inconveniencies almost as bad as those which we endeavour to avoid.

Although authors agree as to the general form in the present manner of fortifying, yet they mostly differ in particular constructions of the parts. As it would be both needless and superfluous to treat of all the different methods hitherto proposed, we shall content ourselves with explaining those only, which are most esteemed by the best judges, and have been mostly put in practice.

### *Construction of M. VAUBAN's Method.*

This method is divided into little, mean, and great; the little is chiefly used in the construction of citadels, the mean in that of all sorts of towns, and the great in particular cases only.

We shall give the construction of the mean, as being most useful, and refer the reader to the table hereafter, for those dimensions which are different in these several fortifications.

[Plate LXXXIII. fig. 1.] Inscribe in a circle a polygon of as many sides as the fortification is designed to have fronts; let AB be one of the sides of half an exagon, which bisect by the perpendicular CD: divide half AC of it into nine equal parts, and one of these into ten others; then these divisions will serve as a scale to construct all the parts of the fortification, and each of them is supposed to be a toise or fathom, that is six French feet; and therefore the whole side AB is supposed to be 180 toises.

As the dividing a line into so many equal parts, is troublesome and tedious; it is more convenient to have a scale of equal parts by which the works may be constructed.

If therefore, in this case, the radius is taken equal to 180 toises, and the circle described with that radius being divided into six equal parts, or the radius being carried six times round, you will have an exagon inscribed; AB being bisected by the perpendicular CD as before, set off 50 toises from C to D, and draw the indefinite lines ADG, BDF, in which take the parts AE, BH, each equal to 50 toises; from the centre E describe an arc through the point H, meeting AD in G, and from the centre H describe an arc through the point E, meeting BD in F; or which is the same, make each of the lines EG HF equal to the distance EH; then the lines joining the points A, E, F, G, H, B, will be the principal or outline of the front.

If the same construction be performed on the other sides of the polygon, you will have the principal or outline of the whole fortification.

If, with a radius of 20 toises, there be described circular arcs, from the angular points B, A, M, T, and lines are drawn from the opposite angles E, H, &c. so as to touch these arcs, their parts a b, b, c, &c. together with these arcs will represent the outline of the ditch.

DEFINITIONS.

1. The part FEALN, is called the bastion.
2. AE, AL, the faces of the bastion.
3. EF, LN, the flanks.
4. FG, the curtain.
5. FN, the gorge of the bastion.
6. AG, BF, the lines of defence.
7. AB, the exterior side of the polygon.
8. CD, the perpendicular.
9. Any line which divides a work into two equal parts, is called the capital of that work.
10. abc, the counterscarp of the ditch.
11. A, M, the flanked angles
12. H, E, L, the angles of the shoulder, or shoulder only.
13. G, F, N, the angles of the flank.
14. Any angle whose point turns from the place is called a saliant angle, such as A, M; and any angle whose point turns towards the place, re-entering angle, such as b, F, N.
15. If there be drawn two lines parallel to the princi-

pal or outline, the one at 3 toises distance, and the other at 8 from it; then the space yx included between the principal one and that farthest distant, is called the rampart.

And the space xx, contained by the principal line, and that next to it, and which is generally stained black, is called the parapet.

16. There is a fine line drawn within four feet of the parapet, which expresses a step called banquette.

N. B. All works have a parapet of three toises thick, and a rampart of 8 to 10, besides their slopes. The rampart is elevated more or less above the level of the place, from 10 to 20 feet, according to the nature of the ground and the particular constructions of engineers.

The parapet is a part of the rampart elevated from 6 to 7½ feet above the rest, in order to cover the troops which are drawn up there from the fire of the enemy in a siege; and the banquette is two or three feet higher than the rampart, or about four feet lower than the parapet; so that when the troops stand upon it, they may just be able to fire over the parapet.

17. The body of the place, is all that which is contained within this first rampart; for which reason, it is often said to construct the body of the place; which means properly, the construction of the bastions and curtains.

18. All the works which are constructed beyond the ditch before the body of the place are called outworks.

T A B L E .

Side of Polyg.	Forts.						Little Fortif.				Mean		Great.	
	80	90	100	110	120	130	140	150	160	170	150	190	200	200
Perpendicular.	10	11	12½	14	15	16	20	21	23	25	30	31	25	22
Faces bast.	22	25	28	30	33	35	40	42	45	47	50	53	55	60
Cap. of ravel.	25	28	30	35	38	40	45	50	50	52	55	55	60	50

In the first vertical column are the numbers expressing the lengths of the exterior sides from 80 to 260.

In the second, the perpendiculars answering to these sides.

In the third, the lengths of the faces of bastions; and in the fourth, the lengths of the capitals of the ravelins.

The forts are mostly, if not always, squares; for which reason, the perpendiculars are made one eighth of the exterior sides; because if they were more, the gorges of the bastions would become too narrow.

The little fortification is chiefly designed for citadels, and are commonly pentagons; the perpendiculars are made one seventh of the exterior side; the mean is used in all kinds of fortifications from an exagon upwards to any number of sides: and the great is seldom used but in an irregular fortification, where there are some sides that cannot be made less without much expence: or in a town which lies near a great river, where the side next the river is made from 200 to 260 toises; and as that side is less exposed to be attacked than any other, the perpendicular is made shorter, which saves much expence.

The faces of the bastions are all ¾ths of the exterior

sides, or nearly so, because the fractions are neglected.

It may be observed in general, that in all squares the perpendicular is ¼th of the exterior side, and all pentagons ¼th, and in all the rest upwards ½th.

1. Construction of Orillons and retired Flanks.

Describe the front MPQRST as before, and divide the flank into three equal parts, of which suppose Sr to be one: from the opposite flanked angle M draw a line Mr, in which take the part mr  $\frac{1}{3}$  toises; take likewise Rn in the line of defence MR, produced, equal to 5 toises, and join nm, upon which as a base describe the equilateral triangle npm, and from the angle p, opposite to the base as centre, is described the circular flank nm.

And if Sr be bisected by the perpendicular 1, 2, and another be erected upon the face ST, at S; the intersection 2 of these two perpendiculars, will be the centre of the arc which forms the orillon.

The orillons are very useful in covering the retired flanks, which cannot be seen but directly in the front; and as these orillons are round, they cannot be so easily destroyed as they would be, if they were of any other figure.

2. Con-

2. *Construction of Ravelins or Half-moons.*

Fig. 2. Set off 50 toises, from the re-entering angle O of the counterescarp, on the capital OL of the ravelin, or on the perpendicular produced, and from the point L draw lines to the shoulders A B; whose parts LM, LN, terminated by the counterescarp, will be the faces MO, ON, the semi-gorges of the ravelin required.

This is Mr Vauban's method of constructing ravelins, according to some authors; and others will have the faces of the ravelin to terminate on those of the bastions within 3 toises of the shoulders; which seems to be the best way, for the ravelins cover the flanks much better than the others.

The ditch before the ravelin is 12 toises, its counterescarp parallel to the faces of the ravelins, and is made in a circular arc, before the saliant angle; as likewise all ditches are in general.

When the ravelins are made with flanks, as in fig. 3. the faces should terminate off those of the bastions, at least 5 toises from the shoulders.

The flanks are made by setting off 10 toises from the extremities of the faces, from f to h, and from m to l, fig. 3. and from the points h, l, the flanks hk, lp, are drawn parallel to the capital LO of the ravelin.

There are sometimes redoubts made in the ravelin, such as in fig. 2. which is done by setting off 16 toises from the extremities of the faces on the semi-gorges from N to b, and from M to a; and from the points b, a, the faces are drawn parallel to those of the ravelin: the ditch before this redoubt is 6 toises, and its counterescarp parallel to the faces.

3. *Construction of Tenaillies.*

A tenaille is a work made in the ditch before the curtains, the parapet of which is only 2 or 3 feet higher than the level ground of the ravelin. There are three different sorts: the first are those as in fig. 4. which are made in the direction of the lines of defence, leaving a passage of 3 toises between their extremities and the flanks of the bastions, as likewise another of 2 in the middle for a bridge of communication to the ravelin.

The second sort, are those as in fig. 5. Their faces are in the lines of defence, and 16 toises long, besides the passage of 3 toises between them and the flanks of the bastions; their flanks are found by describing arcs from one shoulder of the tenaille as centre thro' the other, on which are set off 10 toises for the flanks desired.

And the third sort, are those as in fig. 6. Their faces are 16 toises, as in the second sort, and the flanks are parallel to those of the bastions.

The use in general of tenaillies, is to defend the bottom of the ditch by a grazing fire, as likewise the level ground of the ravelin, and especially the ditch before the redoubt within the ravelin, which can be defended from no where else so well as from them.

The first sort do not defend the ditch so well as the others, as being too oblique a defence; but as they are not subject to be enfiladed, M. Vauban has generally preferred them in the fortifying of places, as may be seen in the citadel of Lille, at Landau, New-Brifac, and in a great many other places.

The second sort defend the ditch much better than the

first, and add a low flank to those of the bastions; but as these flanks are liable to be enfiladed, they have not been much put in practice. This defect might however be remedied, by making them so as to be covered by the extremities of the parapets of the opposite ravelins, or by some other work.

As to the third sort, they have the same advantage as the second, and are likewise liable to the same objections; for which reason they may be used with the same precautions which have been mentioned in the second.

Tenaillies are esteemed so necessary, that there is hardly any place fortified without them; and it is not without reason; for when the ditch is dry, the part behind the tenaillies serves as a place of arms, from which the troops may rally, destroy the works of the enemy in the ditch, oppose their descent, and retire with safety; and the communication from the body of the place to the ravelin becomes easy and secure; which is a great advantage; for by that means the ravelin may make a much better defence, as it can be supplied with troops and necessaries at any time. And if the ditch is wet, they serve as harbours for boats, which may carry out armed men to oppose the passage over the ditch whenever they please; and the communication from the tenaillies to the ravelin, becomes likewise much easier than it would be without them.

4. *Construction of Lunettes.*

Fig. 7. Lunettes are placed on both sides of the ravelin, such as B, to increase the strength of a place: they are constructed, by bisecting the faces of the ravelin with the perpendicular LN; on which is set off 30 toises from the counterescarp of the ditch, for one of its faces; the other face PN, is found by making the semi-gorge TP of 25 toises; the ditch before the lunettes is 12 toises, the parapet 3, and the rampart 8; as in the ravelin.

There is sometimes another work made to cover the saliant angle of the ravelin; such as A, called *Bonnet*, whose faces are parallel to those of the ravelin, and when produced bisect those of the lunettes; the ditch before it is 10 toises.

There are likewise lunettes, such as D, in fig. 8, whose faces are drawn perpendicular to those of the ravelin, within a third part from the saliant angle; and their semi-gorges are only 20 toises.

These kind of works may make a good defence, and are no very great expence; for as they are so near the ravelin, the communication with it is very easy, and one cannot well be maintained till they are all three taken.

5. *Construction of Tenaillons.*

Fig. 9. Produce the faces of the ravelin beyond the counterescarp of the ditch, at a distance MN of 30 toises, and take on the counterescarp of the great ditch 15 toises from the re-entering angle p to q, and draw Nq; then qNmp will be the tenaillon required; its ditch is 12 toises, that is, the same as that of the ravelin. Sometimes there is made a retired battery in the front of the tenaillons, as in fig. B; this battery is 10 toises from the front to which it is parallel, and 15 toises long.

There are commonly retrrenchments made in the tenaillons, such as O; their parapets are parallel to the fronts

fronts MN, or rather perpendicular to the side Nq, and bisect the side qN; the ditch before this retrenchment is 3 toises, and there is a banquette before the parapet next to the ditch of about 8 feet, called *Berm*: it serves to prevent the earth of the parapet (which seldom has any revetement) from falling into the ditch.

It is to be observed, that the ravelin, before which tenaillons are constructed, must have its saliant angle much greater than the former construction makes them; otherwise the saliant angles of the tenaillons become too acute; for which reason we made the capital of this ravelin 45 toises, and the faces terminate within 3 toises of the shoulders.

#### 6. Construction of Counterguards.

Fig. 10. 11. When the counterguard is placed before the ravelin, set off 40 toises on the capital of the ravelin from the saliant angle A, to the saliant angle B, of the counterguard; and 10 from C to D, on the counterscarp of the ditch.

When the counterguard is before the bastion, such as in fig. 2, its saliant angle F is 50 toises from the saliant angle E of the bastion, and the breadth near the ditch of the ravelin is 10 toises as before.

The ditch before the counterguards is 12 toises, and its counterscarp parallel to the faces.

Counterguards are made before the ravelin in some particular occasions only, but are frequently constructed before the bastions, as covering the flanks wonderfully well. Some authors, as Blondel, and Mr Coehorn, will have them much narrower than they are here.

#### 7. Construction of Hornworks.

Fig. 12. Produce the capital of the ravelin beyond the saliant angle A, at a distance AB of about 80 toises; draw DBE at right angles to AB; in which take BD, BE, each equal to 55 toises; and on the exterior side DE, trace a front of a polygon in the same manner as that of the body of the place, making the perpendicular BF 18 toises, and the faces 30.

The branches Da Eb of the hornwork, when produced, terminate on the faces of the bastions, within 5 toises of the shoulders. The ditch of the hornwork is 12 toises, and its counterscarp parallel to the branches; and in the front terminates at the shoulders, in the same manner as the great ditch before the bastions.

The capital of the ravelin before the front of the hornwork is 35 toises, and the faces terminate on the shoulders, or rather 2 or 3 toises beyond them: and the ditch before the ravelin is 8 toises.

There are sometimes retrenchments made within the hornwork, such as S, S: which are constructed by erecting perpendiculars to the faces of the ravelins, within 25 toises of their extremities. This retrenchment, like all others, has a parapet turfed only with a berm of 8 feet before it; as likewise, a ditch from 3 to 5 toises broad.

Fig. 13. When a hornwork is made before the bastion, the distance DL of the front from the saliant angle of the bastion is 100 toises, and the branches terminate on the faces of the adjacent ravelins within 5 toises from their extremities; all the rest is the same as before.

#### 8. Construction of Crownworks.

Plate LXXXIV. fig. 1. From the saliant angle of

the ravelin, as a centre, describe an arc of a circle with a radius of about 120 toises, cutting the capital of the ravelin produced at C; from the point C, set off the cords CB, CF, each of them equal to 110 toises; and on each of which, as an exterior side, construct a front of a polygon of the same dimensions as in the hornwork; that is, the perpendicular should be 18 toises, the faces 30, and the branches terminate on the faces of the bastions, within 25 toises of the shoulders.

The ditch is 12 toises, the capital of the ravelin 35, and its ditch 8; that is, the same as in the hornwork.

Sometimes the crownwork is made before the bastion, as in fig. 2. the arc is described from the saliant angle A of the bastion, with a radius of 120 toises, as before, and the branches terminate on the faces of the adjacent ravelins within 25 toises of their extremities; the rest of the dimensions and constructions are the same as before.

Hornworks, as well as crownworks, are never made but when a large spot of ground falls beyond the fortification, which might be advantageous to an enemy in a siege, or to cover some gate or entrance into a town;

#### 9. Construction of Covert-ways and Glacis.

Although we have not hitherto mentioned the covert-way, nevertheless all fortifications whatsoever have one; for they are esteemed to be one of the most essential parts of a modern fortification; and it is certain, the taking the covert-way, when it is in a good condition and well defended, is generally the most bloody action of the siege.

After having constructed the body of the place, and all the outworks which are thought necessary, lines are drawn parallel to the outmost counterscarps of the ditches, at 6 toises distant from it; and the space mnmn, included between that line and the counterscarp, will be the covert-way required.

Fig. 3. There is in every re-entering angle of the counterscarp a place of arms, m; which is found by setting off 20 toises from the re-entering angle a, on both sides from a to b, and from a to c; and from the points b, c, as centres, arcs are described with a radius of 25 toises, so as to intersect each other in d; then the lines drawn from this intersection to the points b, c, will be the faces of the places of arms.

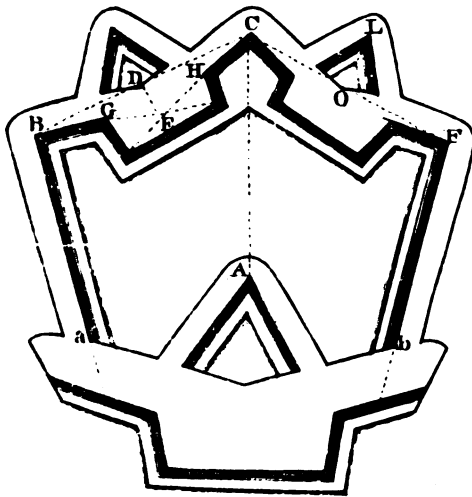
If lines are drawn, parallel to the lines which terminate the covert way, and the places of arms, at 20 toises distant from them, the space x, x, x, between these lines and those which terminate the covert-way, will be the glacis.

At the extremities of the places of arms, are traverses made, such as v, v, which serves to inclose them; these traverses are 3 toises thick, and as long as the covert-way is broad; and a passage is cut in the glacis round them, of about 6 or 8 feet, in order to have a free communication with the rest of the covert-way.

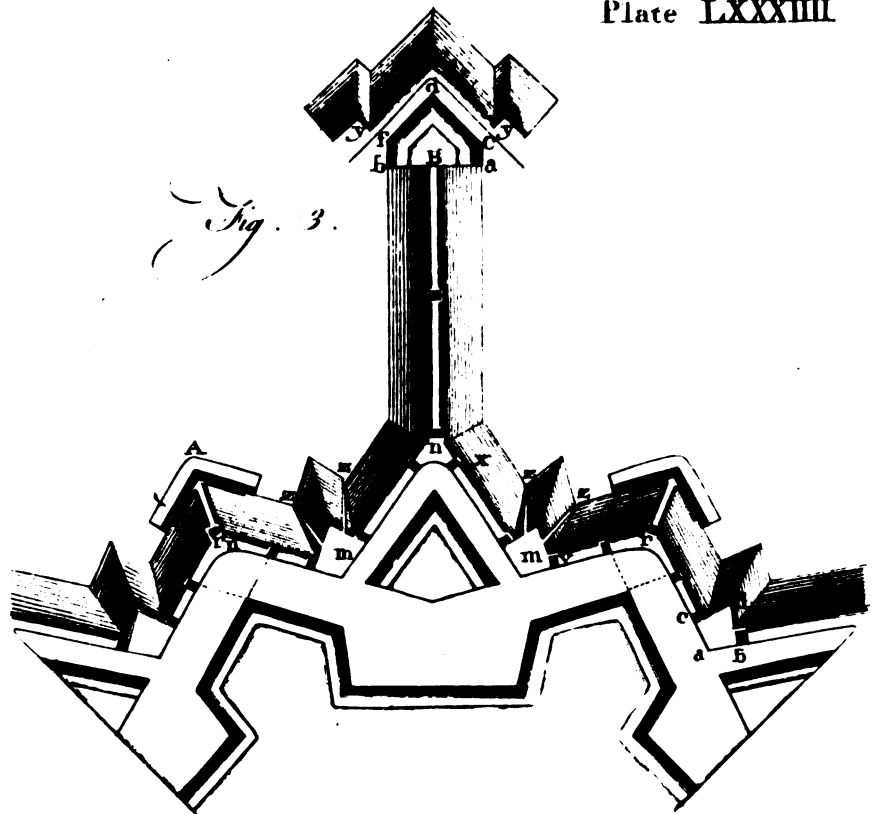
There are also traverses of the same dimensions before every saliant angle of the bastion and outworks, and are in the same direction of the faces of those works produced; and the thickness lies at the same side as the parapets.

The passages round these last traverses are likewise from 6 to 8 feet wide.

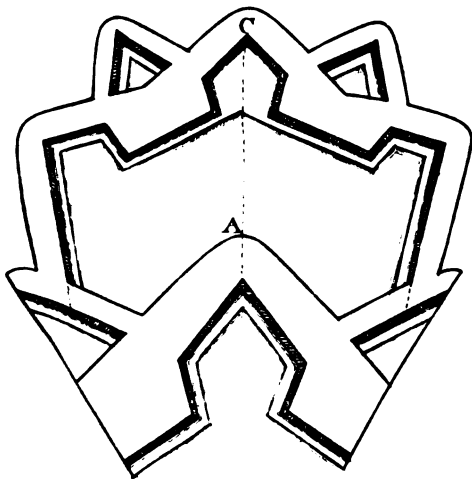
*Fig. 1.*



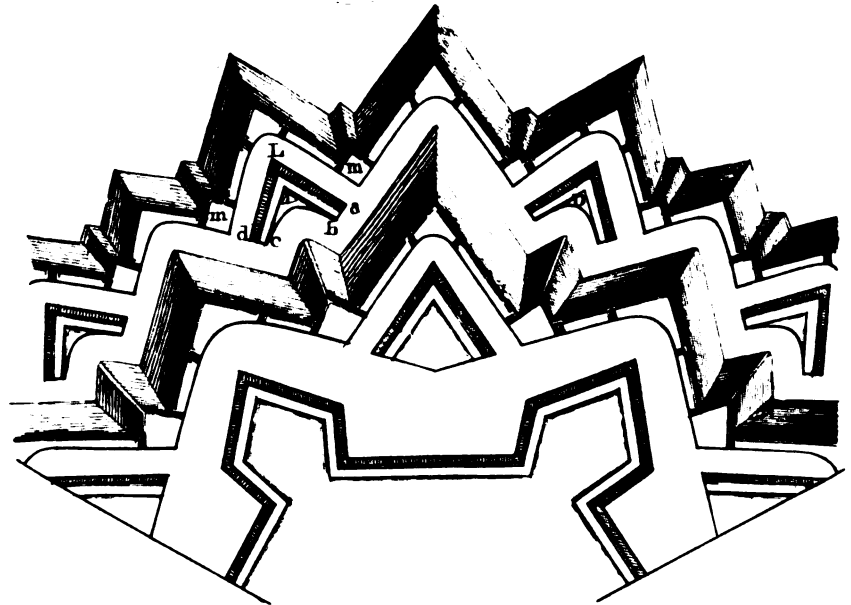
*Fig. 3.*



*Fig. 2.*



*Fig. 4.*



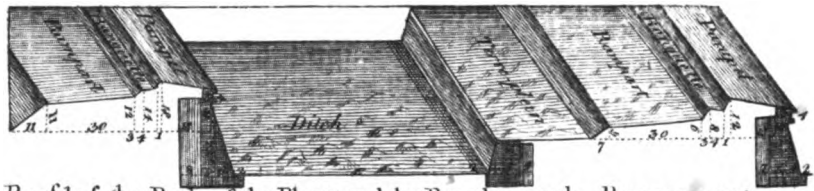
*A. Bull. Sculp.*



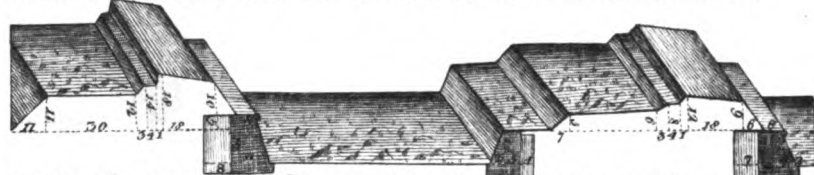




Fig. 1.



Profil of the Body of the Place and the Ravelin with Revetement



Profil of the Body of the Place and the Ravelin with demi-revetement

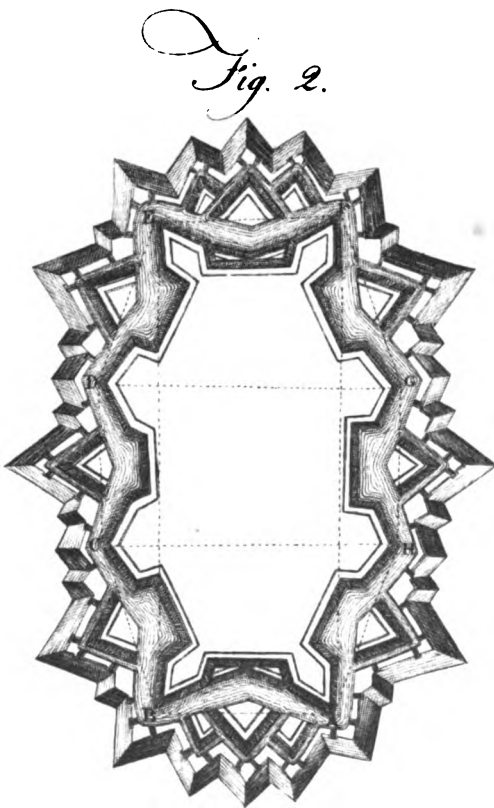
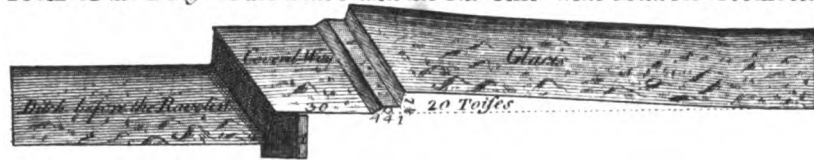


Fig. 2.

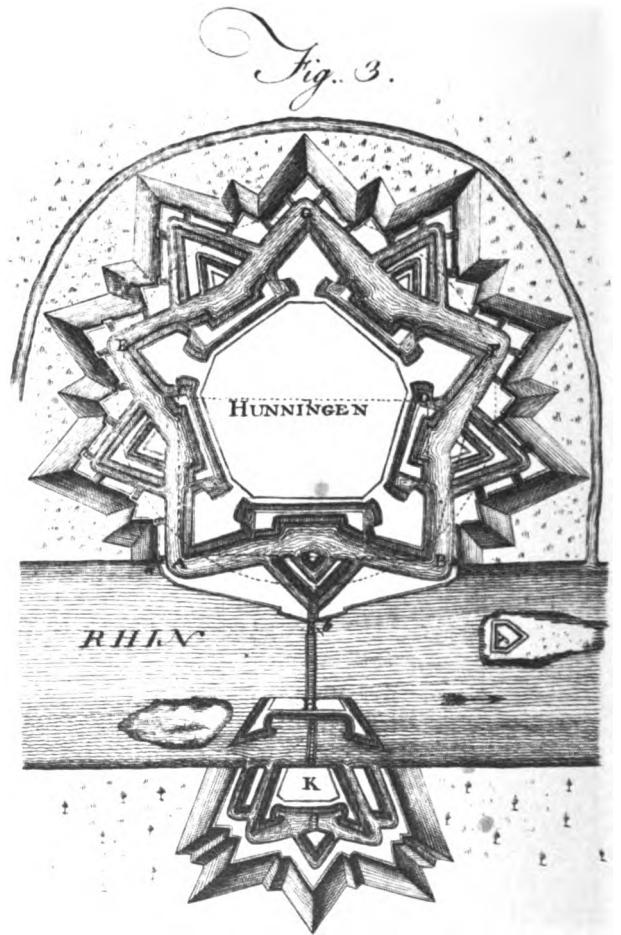


Fig. 3.

C. Bellin sc.

In each place of arms are two sally ports *z. z.*, which are 10 or 12 feet wide, for the troops to sally out; in time of a siege they are shut up, with barriers or gates.

10. *Construction of Arrows and Detached Redoubts.*

An arrow is a work made before the salient angles of the glacis, such as *A*, fig. 3.; it is composed of a parapet of 3 toises thick, and 40 long; and the ditch before it 5 toises, terminating in a slope at both ends. The communication from the covert way into these arrows is 4 or 5 toises wide, and there is a traverse *r* at the entrance of 3 toises thick, with a passage of 6 or 8 feet round it.

A detached redoubt is a kind of work much like a ravelin, with the flanks placed beyond the glacis; such as fig. B: they are made in order to occupy some spot of ground which might be advantageous to the besiegers; likewise to oblige the enemy to open their trenches farther off than they would do otherwise.

Their distance from the covert-way ought not to exceed 120 toises, that it may be defended by musket shot from thence.

The gorge *ab* is 40 toises, the flanks *ac*, *bf*, which are perpendicular to the gorge *10*, and the faces *cd*, *fd* 40; the ditch before it is 6 toises, ending in slopes at both ends; the covert way 4; the branches of the covert-way are 42 toises long, or thereabouts; the faces of the places of arms *y, y*, which are perpendicular to the branches, 10; and the other, which is parallel to them, 14.

The communication from the covert-way into the redoubt, is 5 or 6 toises wide; and there is a traverse made just at the entrance; and another in the middle when it is pretty long. The parapets of this communication terminate in a slope or glacis.

If these redoubts are above 50 toises distant from the covert-way, the besiegers carry their trenches round, and enter through the gorge; by which the troops that are in them are made prisoners of war, if they do not retire betimes; to prevent this, some other outworks should be made to support them.

11. *Construction of Second Ditches, and Covert-ways.*

Fig. 4. When the ground is low, and water to be found, there is often a ditch of about 10 or 12 toises made round the glacis; and opposite to the places of arms are constructed lunettes, beyond the ditch: such as *D*, whose breadth on the counterscarp of the ditch is 10 toises, from *b* to *a*, and from *c* to *d*; and the faces *aL*, *dL*, are parallel to those of the places of arms; the ditch before them is from 8 to ten toises wide.

The second covert-way is 4 toises, the semi-gorges of the places of arms, *m*, about 15, and the faces perpendicular to the counterscarp; the second glacis is from 15 to 18 toises broad.

This second covert-way has traverses every where, in the same manner as the first.

12. *Construction of Profiles.*

Plate LXXXV. fig. 1. A profile is the representation of a vertical section of a work; it serves to shew those dimensions which cannot be represented in plans, and are necessary in the building of a fortification; they are generally constructed upon a scale of 30 feet to an

inch. It would be needless to describe all their particular dimensions, since they are marked in the schemes; we shall therefore lay down the principal rules only, given by M. Vauban, on this subject.

1. Every work ought to be at least 6 feet higher than that before it, so that it may command those before it; that is, that the garrison may fire from all the works at the same time, with great and small arms, at the besiegers in their approaches: notwithstanding this specious pretence, there are several authors, who object against it. For they say, if you can discover the enemy from all the works, they can discover, by the same reason, all the works from their batteries; so that they may destroy them without being obliged to change their situation, and thereby dismount all the guns of the place before they come near it.

But if all the works were of the same height, those within cannot be destroyed, till such time as those before them are taken; guns might be placed in the covert-way and outworks to obstruct the enemy's approach, and when they come near the place, they might be transported into the inner-works; and as the body of the place would be much lower, the expence would be considerably diminished.

But when works are low, they are easily enfiladed by the ricochet batteries, which is a kind of firing with a small quantity of powder, by giving the gun an elevation of 10 or 12 degrees: this might however be partly prevented, by making the parapets near the salient angles, for the space of 8 toises on each side, 5 or 6 feet higher than the rest of the works.

2. The covert-way should be lower than the level-ground, otherwise the body of the place must be raised very high, especially when there are several outworks; this is to be understood only when the works exceed each other in height, otherwise it need not be below the level.

3. The bases of all inward slopes of earth should be at least equal to the height, if not more.

4. The bases of all outward slopes of earth, two thirds of their heights.

5. The slopes of all walls or revetements should be one fifth of their height; but one sixth would be sufficient in our opinion: the height of a wall is estimated from the bottom of the ditch, and not from the beginning of its foundation.

6. The slopes of all parapets and traverses are one sixth of their breadth; that is, 3 feet towards the field, or the inside, where the banquettes should be, 3 feet higher than the outside.

7. When the revetement of a rampart goes quite up to the top, 4 feet of the upper-part is a vertical wall of 3 feet thick, with a square stone at the top of it, projecting 6 inches, and a circular one below, or where the slope begins, of 8 or 10 inches diameter; they go quite round the rampart, and the circular projection is called the *cordon*.

Where the straight part of the wall ends and the slope begins, the wall is always made 5 feet thick; and the counterforts or buttresses reach no higher than that place.

7. When the rampart is partly walled, and partly turf-

ed, then one fifth of the height which is turfed must be added to 5 feet, to get the thickness of the wall above.

And having the thickness of any wall above, by adding one fifth of its height from the bottom of the ditch, the sum will be the thickness of the wall at the bottom; but if a sixth part is only taken for the slope, then a sixth part must be added.

For instance, suppose a rampart of 30 feet high from the bottom of the ditch, and that 10 of which are to be turfed; then the fifth part of 10, which is 2, added to 5, gives 7 for the wall above; and as this wall is 20 feet high, the fifth of which is 4, and 3 added to the thickness 7 above, gives 11 for the thickness near the foundation.

Plate LXXXV. fig. 1. Represents, in military perspective, the profiles of the body of a place, the ravelin and covert-way; which gives a clear idea of what is meant by a profile, and from which those of all other works may be easily conceived.

## SECT. II. *Of Irregular Fortification.*

THE most essential principle in fortification, consists in making all the fronts of a place equally strong, so that the enemy may find no advantage in attacking either of the sides; this can happen no otherwise but in a regular fortification situated in a plain or even ground; but as there are but few places which are not irregular, either in their works or situations, and the nature of the ground may be such as makes it impracticable to build them regular, without too great expence; it is so much the more necessary to shew in what consists the strength or weakness of a town irregularly fortified, so that the weakest part may be made stronger by additional outworks; as likewise if such a place is to be attacked, to know which is the strongest or weakest.

### 1. *Construction of an irregular place situated in an open country.*

If the place to be fortified is an old town inclosed by a wall or rampart, as it most frequently happens, the engineer is to consider well all the different circumstances of the figure, situation, and nature of the ground, to regulate his plan accordingly, so as to avoid the disadvantages, and gain all the advantages possible; he should examine, whether by cutting off some parts of the old wall or rampart, and taking in some ground, the place cannot be reduced into a regular figure, or nearly so; for, if that can be done without increasing the expence considerably, it should by no means be omitted; old towns have often towers placed from distance to distance, as Douay, Tournay, and many other places, which are generally made use of, and mended when it may be done; if there is a rampart without bastions or towers, it must be well considered, whether bastions may not be added, or if it is not better to make only some outworks; if the ditch about this rampart is not too wide and deep, it would be advantageous to make detached bastions, otherwise ravelins and counterguards must be constructed; special care must be taken, to make all sides of the polygon as nearly equal as possible, and that the length of the lines of defence do not exceed the reach of musket-

shot; but if that cannot be done, those sides which are on the narrowest part should be made the longest.

If it should happen, that some of the sides are inaccessible or of very difficult approach, either on account of some precipice, marshy ground, or inundation, they may be made much longer than the others, which are of easy access, and the flanks need not be so large as the rest; by doing so, there will be some expences saved, which may be used in making the other sides stronger by adding more outworks.

There are few situations, but what are more advantageous in some parts than in others; it is therefore the business of an engineer to distinguish them, and to render those sides strong by art, which are not so by nature.

If the situation is low and watery, lunettes or tenailions, and such other small outworks should be constructed, because they are not of any great expence, and may make a very good defence; but if one side of the place is only low, and running water is to be had, a second ditch and covert-way with lunettes may be made, by observing, that if the first glacis is made to slope, so as to become even with the level of the water in the second ditch; or if the water can be swelled, by means of dykes or sluices, so as to overflow the best part of the first glacis, it should be done; for by so doing, these works will be able to make a very good defence, since the besiegers will find it a difficult matter to lodge themselves upon this glacis, which cannot be done but within a few toises of the first covert-way, where the besieged are ready to receive them, and to destroy their works with great advantage; whereas the enemy cannot support their workmen but from the second covert-way, which is too far off to be of any great service to them.

But if the situation is of a dry nature, without any water about it, caponiers should be made in the great ditch, from the curtains to the ravelin, and batteries raised in the entrance of the ditch before the ravelin, whose parapet must slope off into a glacis, so as to afford no cover for the enemy behind them; arrows, and detached redoubts are likewise very proper to be used in such a case, and sometimes horn or crown works, if it should be thought convenient; but these works should never be constructed, without an absolute necessity, either to occupy a spot of ground which might be advantageous to the enemy, or to cover some gate or entrance into the town, for they are of so great expence, that their defence seems not to be answerable to it.

Most of the places in Flanders are fortified with hornworks, such as Ipres, Tournay, Lille, and others.

If the place to be fortified is new, and the situation will not admit of a regular construction; particular care must be taken in chusing such a spot of ground as is most advantageous, and least liable to any disadvantages, either in the building or in the maintaining of it: all hills or rising grounds should be avoided, which might command any part of the works; marshy grounds, because such situations are unwholesome; or lakes and standing waters, for the same reason, excepting a lake is, or may be made navigable: good water should be had either within the place or near it, for it is absolutely necessary for men and cattle:

cattle; the air should be wholesome, otherwif: the continual sickness that may reign in such a place might prevent people to come and live in it, and the garrison would not be in a condition to defend themselves as they ought to do; in short, all the different circumstances attending such an undertaking should be maturely considered, before a resolution is taken to fortify any place.

When a situation is pitched upon, the next thing to be considered is, the bigness of the town and the number of its outworks, which must absolutely depend upon the consequence such a place is of to a nation; if it is only to guard a pass, or entrance into a county, it need not be so large; but if it is to be a place either to promote or to protect trade, it should be large and commodious; the streets should be wide, and the buildings regular and convenient: as to what regards the fortification, its construction should depend on the nature of the situation, and the number of the works on the funds or expence a prince or a nation will be at; which however ought to be according to the benefit arising from such a place: for, as such undertakings are of very great expence, an engineer cannot be too sparing in his works; on the contrary, the greatest œconomy should be used, both in regard to the number of works, and to their construction. The body of the place may have \* revetements quite up to the top, or only in part, and the rest turfed; but as to the outworks, they should have half revetements, or they may be made with turf only; as being not so necessary to prevent the place from being surpris'd, and may nevertheless make a good defence.

On Plate LXXXV. fig. 2. is the plan of an octagon, one half of which is similar and equal to the other half; it being supposed, that the situation would not admit of fortification quite regular; and the exterior sides are each 180 toises, and the works are constructed according to our method; but because the sides AB, EF, are weaker than the rest, as has been proved before, we have added tenailles, redoubts in the ravelins, and lunettes, to render them nearly equal in strength with the others; and if counter-guards were made before the bastions A and B, it would effectually secure that front. Instead of lunettes, any other works may be made, as it may be thought convenient and according to the nature of the ground. If it should be judged necessary to add other outworks to the ravelins all round the place, care must be taken to add likewise more to the fronts AB, EF, in order to render the advantages and disadvantages of attacking on either side equal.

### 2. *Construction of an irregular place, situated on a hill or rock.*

In the construction of such places, care must be taken that no neighbouring hill commands any part of the works; the town should always be built on the highest part; but if it should be thought more convenient to place it lower, then the upper part must be fortified with a fort; the situation should be made level as near as possible, by removing the earth from some places to fill up others; and

if it cannot well be levelled without extraordinary expence, works must be made on the highest part, so as to command and protect the lower; the works ought to occupy all the upper part of the hill, but if it should be too extensive to be all inclosed, or so irregular as not to be fortified without great inconvenience, the parts which fall without should be fortified with some detached works, and a communication with the place must be made either above or under ground. There should be no cavity or hollow roads, within cannon-shot, round about the place, where the enemy might be able to approach under cover; if there should happen to be a spring, near the top of the hill, it should be inclosed in the fortification, or if that cannot be done, by some work or other; for there is nothing more necessary, and at the same time scarcer in such situations than water, for which reason there cannot be too much care taken in providing it; several cisterns are to be made to receive the rain-water, and to preserve it; wells should be dug likewise, though ever so deep, the water of which will serve for common use.

Places built on hills or rocks, should never be large, for their use is generally to guard passes or inlets into a country, and are seldom useful in traffic, and it is a difficult matter to provide for a large garrison in such situations, neither should any such place be built without some very material reasons; but when it is absolutely necessary, great care and precautions should be taken to render the works as perfect as the situation will admit of, and at the same time to be as frugal in the expence as possible.

### 3. *Construction of irregular fortifications, situated near rivers, lakes, or the sea.*

As the intent of building these kind of places is chiefly to facilitate and protect trade, it is of much more importance than any other kind, especially in maritime countries, where the principal strength and power depends on it; for which reason, we shall treat of it more largely than any other part.

The first thing to be considered is their situations, which ought to be such as to afford a good harbour for shipping, or a safe and easy entrance in stormy weather; but as it is hardly possible to find any, where ships may go in and lie secure with all winds, care should be taken to make them safe to enter with those winds which are most dangerous: but it is not sufficient that the harbour is safe against stormy weather, they should likewise be so against an enemy, both by land and water; for it often happens, that ships are destroyed where it was imagined they were secure, which is of too great a consequence not to be provided against; for which reason, forts or batteries must be built in the most convenient places, to prevent the enemy's ships from coming too near, so as to be able to cannonade those in the harbour, or sling shells amongst them: and if there is any danger of an enemy's approach by land, high ramparts and edifices must be built, so as to cover them.

When a river is pretty large, and it is not convenient for

\* Revetements are chiefly made to prevent a place from being surpris'd; outworks do not want to be made so, the taking them by surpris'e is of no great consequence, except in a siege, when other cautions are used to prevent it.

for making a harbour without great expence, the ships may ride along the shore, which, for that reason, must be made accessible for ships of burden; this may be done by advancing the quay into the river, if the water is too shallow, or by digging the river sufficiently deep for that purpose.

And to prevent any enemy from coming up the river, forts must be built on both sides, especially when there are any turnings or windings. Antwerp is such a place; for the Scheld is sufficiently deep to carry ships of great burden, which may come quite near the town-wall; and several forts are built below it on both sides, so that it would not be an easy matter for an enemy to come up the river.

When the river is but small, so that no ships of burden can come through it; it is sufficient to make it run through some of the works, whose proper landing places are contrived, from whence the goods may be carried into the place; as at Sarrelouis, where a horn work is built beyond the Sarre, in the gorge of which the goods are landed.

If the breadth of the river does not exceed 200 yards, it commonly passes through the middle of the town, and proper quays are made on each side; in such a case, the fortification is so contrived as that the river passes through the curtain, in order to have a bastion on each side to defend the coming in and going out.

When M. Vauban fortified near rivers, he made always the exterior side near the water much longer than any of the others; such is Hunningen on the Rhine, and Sarrelouis on the Sarre; but for what reason he fortified these places in that manner, has not been told by any author.

But it is plain, that the sides which terminate at the river, are the weakest; because the besiegers trenches being secured by the river, they may draw most of their troops off, and act therefore with more vigour and strength on the other side: besides, as the strength of a side increases in proportion as the angle of the polygon is greater, by making the side next the river longer, the angles at its extremities become wider, and consequently the adjacent sides stronger.

There are other advantages, besides these mentioned already, which arise from the lengthening that side; for if the river is pretty deep so as not to be fordable, that side is not liable to be attacked; and by increasing its length, the capacity of the place increases much more in proportion to the expence, than if more sides were made; the centre of the place will be likewise nearer the river, which makes it more convenient for transporting the goods from the water-side to any part of the town.

Plate I. XXXV. fig. 3. To illustrate this method of M. Vauban's we shall give the plan of Hunningen; this place was built for the sake of having a bridge over the Rhine, for which reason he made it only a pentagon; the side AB next to the river is 200 toises, and each of the others but 150.

About the space  $abc$ , which lies before the front AB, is a stone-wall, and the passages  $x, x$ , are shut up with sluices, to retain the water in the ditches in dry seasons, and to prevent an enemy from destroying the sluice near the point  $c$ , whereby the water would run out and leave the ditches dry; the redout  $y$  was built in the little island hard by, in order to cover that sluice; without this precaution the place might be insulted from the river-side, where the water is shallow in dry seasons.

The hornwork K beyond the Rhine was built to cover the bridge; but as this work cannot be well defended cross the river, the hornwork H was made to support the other.

Before we finish the description of this plan, we shall shew how to find the long side AB, as being useful in the following work.

After having inscribed the two sides GE, GF, in a circle, draw the diameter CD, so as to be equally distant from the line joining the points E, F, that is parallel to it; on this diameter set off 100 toises on each side of the centre, from these points draw two indefinite perpendiculars to the diameter; then if from the points E, F, as centres, two arcs are described with a radius of 150 toises, their intersections A and B, with the said perpendiculars, will determine the long side AB, as likewise the other two FB and EA. In like manner may be found the long or short side of any polygon whatsoever.

When a place near a river is to be fortified, for the safety of commerce, particular care should be taken in leaving a good space between the houses and the water-side, to have a key or landing place for goods brought by water; it should also be contrived to have proper places for ships and boats to lie secure in stormy weather, and in time of a siege; and as water-carriage is very advantageous for transporting goods from one place to another, as likewise for bringing the necessary materials, not only for building the fortification, but also the place itself, the expences will be lessened considerably, when this convenience can be had; for which reason, places should never be built any where else but near rivers, lakes, or near the sea; excepting in extraordinary cases, where it cannot be avoided.

## F O R

FORTISSIMO, in music, sometimes denoted by FFF, or *fff*, signifies to sing or play very loud or strong.

FORT-LEWIS, a fortress of Alsace, in Germany, situated on the western shore of the Rhine, subject to France: E. long  $8^{\circ}$ , and N. lat.  $48^{\circ} 46'$ .

FORTUNATE-ISLANDS, in ancient geography, certain islands, concerning the situation of which authors are not agreed, famous for the golden apples of the Hesperides. See HESPERIDES.

## F O R

The common opinion is, that they are the same with the Canary islands.

FORTUNE, a goddess worshipped with great devotion by the ancient Greeks and Romans, who believed her to preside over human affairs, and to distribute wealth and honour at her pleasure.

FORUM, in Roman antiquity, a public standing place within the city of Rome, where causes were judicially tried, and orations delivered to the people.

FORUM,

**FORUM**, was also used for a place of traffic, answering to our market place: of these there were vast numbers, as the *forum piscarium, clitorium, &c.* These were generally called *fora v. nalia*, in contradistinction to the former, which were called *fora civilia*.

**FORUM**, is also used, among cauvils, &c. for jurisdiction; thus they say, *In foro legis, &c.*

**FOSS**, or **FOSSA**, in anatomy, a kind of cavity in a bone, with a large aperture, but no exit or perforation.

**Foss way**, one of the four principal highways of England, that anciently led through the kingdom; supposed to be made by the Romans, having a ditch upon one side thereof.

**FOSSIL**, in natural history, denotes, in general, every thing dug out of the earth, whether they be natives thereof, as metals, stones, salts, earths, and other minerals; or extraneous, repolited in the bowels of the earth by some extraordinary means. See **NATURAL HISTORY**.

**FOSSOMBRONE**, a city and bishop's see of Italy, ten miles south-east of Urbino.

**FOUMART**, in zoology. See **MUSTELA**.

**FOUNDATION**, in architecture, is that part of a building which is under ground. See **BUILDING**.

The foundation is properly so much of the masonry as reaches as high as the surface of the ground, and ought always to be proportioned to the load or weight of the building that it is to bear. Sometimes the foundation is massive, and continued under the whole building, as in the antique arches and aqueducts, and some amphitheatres; but it is more usually in spaces or intervals, either to avoid expence, or because the vacuities are at too great a distance, in which latter case they make use of insulated pillars bound together by arches.

Palladio allows a sixth part of the height of the whole building for the hollowing or under-digging; unless there be cellars under ground, in which case he would have it somewhat lower; and as to thickness, double the width of the walls is no bad rule.

**FOUNDATION of Bridges**, is laid after different manners. The first is by inclosing all round the space of ground you would build upon, by dams made with piles set deep in the ground in double rows, well strengthened and bound together with cross pieces and cords, and filling the vacant spaces between them with chalk or other earthy matter. This being done, the water must be emptied out, and the foundation dug according to the quality of the ground, driving down piles, if it be necessary, upon which the walls of the foundation must be laid. But this method is only practicable in building on such rivers, where the water is neither very rapid, nor very deep. The second is done by laying the foundation on grate work, rafts of stout oak well bound together, and made fast at the surface of the water with cables or machines, and building upon them large quarters of stone, cramped together, and joined with good mortar, or cement, and afterwards letting them descend softly by these cables and ma-

chines perpendicularly to the bottom of the water. This was the method practised in laying the foundation of Westminster Bridge, the grating being made of the bottom of a frame called by the French Caisson, the sides of which were so contrived, that they might be taken off, after a pier was finished. The third is by drawing off all, or the greatest part of the water of the river into some other place.

**FOUNDER**, in a general sense, the person who lays a foundation, or endows a church, school, religious-house, or other charitable institution.

**FOUNDER** also implies an artist who casts metals, in various forms, for different uses, as guns, bells, statues, printing characters, candlesticks, buckles, &c. whence they are denominated gun-founders, bell-founders, figure-founders, letter-founders, founders of small works, &c. See **FOUNDRY**.

**FOUNDER**, in the sea language: A ship is said to founder, when by an extraordinary leak, or by a great sea breaking in upon her, she is so filled with water, that she cannot be freed of it; so that she can neither veer nor steer, but lie like a log; and not being able to swim long, will at last sink.

**FOUNDRY**, or **FOUNDRY**, the art of casting all sorts of metals into different forms. It likewise signifies the work-house or smelting-hut wherein these operations are performed.

**FOUNDRY of small-works, or casting in sand**. The sand used for casting small works, is, at first, of a pretty soft, yellowish, and clammy nature: but it being necessary to strew charcoal dust in the mould, it at length becomes of a quite black colour. This sand is worked over and over, on a board, with a roller, and a sort of knife; being placed over a trough to receive it, after it is by these means sufficiently prepared.

This done, they take a wooden board of a length and breadth proportional to the things to be cast, and putting a ledge round it, they fill it with sand, a little moistened, to make it duly cohere. Then they take either wood or metal models of what they intend to cast, and apply them so to the mould, and press them into the sand, as to leave their impression there. Along the middle of the mould is laid half a small brass cylinder, as the chief canal for the metal to run through, when melted, into the models or patterns; and from this chief canal are placed several others, which extend to each model or pattern placed in the frame. After this frame is finished, they take out the patterns, by first loosening them all round, that the sand may not give way.

Then they proceed to work the other half of the mould with the same patterns in just such another frame, only that it has pins, which, entering into holes that correspond to it in the other, make the two cavities of the pattern fall exactly on each other.

The frame thus moulded, is carried to the melter, who, after extending the chief canal of the counter-part, and adding the cross canals to the several models in both, and strewing mill-dust over them, dries them in a kind of oven for that purpose.

Both parts of the mould being dry, they are joined together by means of the pins; and to prevent their giving way, by reason of the melted metal passing through the elastic cylindrical canal, they are screwed or wedged up like a kind of a press.

While the moulds are thus preparing, the metal is fusing in a crucible of a size proportionate to the quantity of metal intended to be cast.

When the moulds are coolish, the frames are unscrewed, or unwedged, and the cast work taken out of the sand, which sand is worked over again for other castings.

**FOUNDRY of Statues.** The casting of statues depends on the due preparation of the pit, the core, the wax, the outer mould, the inferior furnace to melt off the wax, and the upper to fuse the metal. The pit is a hole dug in a dry place something deeper than the intended figure, and made according to the prominence of certain parts thereof. The inside of the pit is commonly lined with stone, or brick; or when the figure is very large, they sometimes work on the ground, and raise a proper fence to resist the impulsion of the melted metal.

The inner mould, or core, is a rude mass to which is given the intended attitude and contours. It is raised on an iron grate, strong enough to sustain it, and is strengthened within by several bars of iron. It is generally made either of potter's clay, mixed with hair, and horse-dung; or of plaster of Paris mixed with brick-dust. The use of the core is to support the wax, the shell and lessen the weight of the metal. The iron bars and the core are taken out of the brass figure through an aperture left in it for that purpose, which is soldered up afterwards. It is necessary to leave some of the iron bars of the core, that contribute to the steadiness of the projecting part, within the brass figure.

The wax is a representation of the intended statue. If it be a piece of sculpture, the wax should be all of the sculptor's own hand, who usually forms it on the core; though it may be wrought separately in cavities, moulded on a model, and afterwards arranged on the ribs of iron over the grate; filling the vacant space in the middle with liquid plaster and brick dust, whereby the inner core is proportioned as the sculptor carries on the wax.

When the wax, which is the intended thickness of the metal, is finished, they fill small waxen tubes perpendicular to it from top to bottom, to serve both as canals for the conveyance of the metal to all parts of the work; and as vent-holes, to give passage to the air, which would otherwise occasion great disorder, when the hot metal came to encompass it.

The work being brought thus far, must be covered with its shell, which is a kind of crust laid over the wax, and which being of a soft matter, easily receives the impression of every part, which is afterwards communicated to the metal upon its taking the place of the wax, between the shell and the mould. The matter of this outer mould is varied according as different layers are applied. The first is generally a composition of clay, and old white crucibles well ground and sifted, and mixed up with water, to the consistence of a

colour fit for painting: accordingly they apply it with a pencil, laying it seven or eight times over, and letting it dry between whites. For the second impression, they add horse dung, and natural earth to the former composition. The third impression is only horse-dung and earth. Lastly, the shell is finished by laying on several more impressions of this last matter, made very thick with the hand.

The shell, thus finished, is secured by several iron girts, bound round it, at about half a foot distance from each other, and fastened at the bottom to the grate under the statue, and at top to a circle of iron where they all terminate.

If the statue be so big that it would not be easy to move the moulds with safety, they must be wrought on the spot where it is to be cast. This is performed two ways: in the first, a square hole is dug under ground, much bigger than the mould to be made therein, and its inside lined with walls of free-stone, or brick. At the bottom is made a hole of the same materials with a kind of furnace, having its aperture outwards: in this is a fire made to dry the mould, and afterwards melt the wax. Over this furnace is placed the grate, and upon this the mould, &c. formed as above. Lastly, at one of the edges of the square pit, is made another large furnace to melt the metal. In the other way, it is sufficient to work the mould above ground, but with the like precaution of a furnace and grate underneath. When finished, four walls are to be run around it, and by the side thereof a massive made for a melting-furnace. For the rest, the method is the same in both. The mould being finished, and inclosed as described, whether under ground or above it, a moderate fire is lighted in the furnace under it, and the whole covered with planks, that the wax may melt gently down, and run out at pipes contrived for that purpose, at the foot of the mould, which are afterwards exactly closed with earth, so soon as the wax is carried off. This done, the hole is filled up with bricks thrown in at random, and the fire in the furnace augmented, till such time as both the bricks and mould become red hot. After this, the fire being extinguished, and every thing cold again, they take out the bricks and fill up their place with earth moistened, and a little beaten to the top of the mould, in order to make it the more firm and steady. These preparatory measures being duly taken, there remains nothing but to melt the metal, and run it into the mould. This is the office of the furnace above described, which is commonly made in the form of an oven with three apertures, one to put in the wood, another for a vent, and a third to run the metal out at. From this last aperture, which is kept very close, while the metal is in fusion, a small tube is laid, whereby the melted metal is conveyed into a large earthen basin, over the mould, into the bottom of which all the big branches of the jets, or casts, which are to convey the metal into all the parts of the mould, are inserted.

These casts, or jets, are all terminated with a kind of plugs, which are kept close, that, upon opening the furnace, the brass, which gushes out with violence, may



may not enter any of them, till the basin be full enough of matter to run into them all at once. Upon which occasion they pull out the plugs, which are long iron rods with a head at one end, capable of filling the whole diameter of each tube. The whole of the furnace is opened with a long piece of iron fitted at the end of each pole, and the mould filled in an instant. This completes the work in relation to the casting part; the rest being the sculptor's or carver's business, who, taking the figure out of the mould and earth wherewith it is encompassed, saws off the jets with which it appears covered over, and repairs it with chisels, gravers, punchcois, &c.

**Foundery of bells.** The metal, it is to be observed, is different for bells, from what it is for statues; there being no tin in the statue-metal: but there is a fifth, and sometimes more, in the bell-metal.

The dimensions of the core and the wax for bells, if a ring of bells especially, are not left to chance, but must be measured on a scale, or diapason, which gives the height, aperture, and thickness necessary for the several tones required. See **DIAPASON**.

It is on the wax that the several mouldings and other ornaments are formed to be represented in relief, on the outside of the bell.

The business of bell-foundry is reducible to three particulars. 1. The proportion of a bell. 2. The forming of the mould; and, 3. The melting of the metal.

The proportions of our bells differ much from those of the Chinese: in ours, the modern proportions are, to make the diameter fifteen times the thickness of the brim, and twelve times the height.

There are two kinds of preparations, *viz.* the simple and the relative: the former are those proportions only that are between the several parts of a bell, to render it sonorous; the relative proportions establish a requisite harmony between several bells.

The particulars necessary for making the mould of a bell are, 1. The earth; the most cohesive is the best: it must be well ground and sifted, to prevent any chinks. 2. Brick-stone; which must be used for the mine, mould, or core, and for the furnace. 3. Horse dung, hair, and hemp, mixed with the earth, to render the cement more binding. 4. The wax for inscriptions, coats of arms, &c. 5. The tallow equally mixed with the wax, in order to put a slight lay of it upon the outer mould, before any letters are applied to it. 6. The coals to dry the mould.

For making the mould, they have a scaffold consisting of four boards, ranged upon tressels. Upon this they carry the earth, grossly diluted, to mix it with horse-dung, beating the whole with a large spatula.

The compasses of construction is the chief instrument for making the mould, which consist of two different legs joined by a third piece. And last of all, the founders shelves, on which are the engravings of the letters, cartridges, coats of arms, &c.

They first dig a hole of a sufficient depth to contain the mould of the bell, together with the case, or cannon, under ground; and about six inches lower than

the terreplain, where the work is performed. The hole must be wide enough for a free passage between the mould and walls of the hole, or between one mould and another, when several bells are to be cast. At the centre of the hole is a stake erected, that is strongly fastened in the ground. This supports an iron peg, on which the pivot of the second branch of the compasses turns. The stake is encompassed with a solid brick-work, perfectly round, about half a foot high, and of the proposed bell's diameter. This they call a mill-stone. The parts of the mould are, the core, the model of the bell, and the shell. When the outer surface of the core is formed, they begin to raise the core, which is made of bricks that are laid in courses of equal height upon a lay of plain earth. At the laying each brick, they bring near it the branch of the compasses, on which the curve of the core is shaped, so as that there may remain between it and the curve the distance of a line, to be afterwards filled up with layers of cement. The work is continued to the top, only leaving an opening for the coals to bake the core. This work is covered with a layer of cement, made of earth and horse dung, on which they move the compasses of construction, to make it of an even smoothness every where.

The first layer being finished, they put the fire to the core, by filling it half with coals, through an opening that is kept shut, during the baking, with a cake of earth, that has been separately baked. The first fire consumes the stake, and the fire is left in the core half or sometimes a whole day: the first layer being thoroughly dry, they cover it with a second, third, and fourth; each being smoothed by the board of the compasses, and thoroughly dried before they proceed to another.

The core being completed, they take the compasses to pieces, with intent to cut off the thickness of the model, and the compasses are immediately put in their place to begin a second piece of the mould. It consists of a mixture of earth and hair, applied with the hand on the core, in several cakes that close together. This work is finished by several layers of a thinner cement of the same matter smoothed by the compasses, and thoroughly dried, before another is laid on. The first layer of the model is a mixture of wax and grease spread over the whole. After which are applied the inscriptions, coats of arms, &c. besmeared with a pencil dipped in a vessel of wax in a chaffing-dish: this is done for every letter. Before the shell is begun, the compasses are taken to pieces, to cut off all the wood that fills the place of the thickness to be given to the shell.

The first layer is the same earth with the rest, sifted very fine; whilst it is tempering in water, it is mixed with cow's hair, to make it cohere. The whole being a thin cullis, is gently poured on the model, that fills exactly all the sinuosities of the figures, &c. and this is repeated till the whole is two lines thick over the model. When this layer is thoroughly dried, they cover it with a second of the same matter, but something thicker: when this second layer becomes of some consistence, they apply the compasses again, and

light

light a fire in the core, so as to melt off the wax of the inscriptions, &c.

After this, they go on with other layers of the shell, by means of the compasses. Here they add to the cow's hair a quantity of hemp, spread upon the layers, and afterwards smoothed by the board of the compasses. The thickness of the shell comes to four or five inches lower than the mill-stone before observed, and surrounds it quite close, which prevents the extravasation of the metal. The wax should be taken out before the melting of the metal.

The ear of the bell requires a separate work, which is done during the drying of the several incrustations of the cement. It has seven rings; the seventh is called the bridge, and unites the others, being a perpendicular support to strengthen the curves. It has an aperture at the top, to admit a large iron peg, bent at the bottom; and this is introduced into two holes in the beam, fastened with two strong iron keys. There are models made of the rings, with masses of beaten earth, that are dried in the fire, in order to have the hollow of them. These rings are gently pressed upon a layer of earth and cow's hair, one half of its depth; and then taken out, without breaking the mould. This operation is repeated twelve times for twelve half-moulds, that two and two united may make the hollows of the six rings: the same they do for the hollow of the bridge, and bake them all, to unite them together.

Upon the open place left for the coals to be put in, are placed the rings that constitute the ear. They first put into this open place the iron-ring to support the clapper of the bell; then they make a round cake of clay, to fill up the diameter of the thickness of the core. This cake, after baking, is clapped upon the opening, and foldered with a thin mortar spread over it, which binds the cover close to the core.

The hollow of the model is filled with an earth, sufficiently moist to fix on the place, which is strewed at several times upon the cover of the core; and they beat it gently with a pestle, to a proper height; and a workman smooths the earth at top with a wooden trowel dipped in water.

Upon this cover, to be taken off afterwards, they assemble the hollows of the rings. When every thing is in its proper place, they strengthen the outside of the hollows with mortar, in order to bind them with the bridge, and keep them steady at the bottom, by means of a cake of the same mortar, which fills up the whole aperture of the shell. This they let dry, that it may be removed without breaking. To make room for the metal, they pull off the hollows of the rings, through which the metal is to pass, before it enters into the cavity of the mould. The shell being unloaded of its ear, they range under the mill-stone five or six pieces of wood, about two feet long, and thick enough to reach almost the lower part of the shell; between these and the mould they drive in wooden wedges with a mallet, to shake the shell of the model whereon it rests, so as to be pulled up, and got out of the pit.

When this and the wax are removed, they break

the model and the layer of earth, through which the metal must run, from the hollow of the rings, between the shell and the core. They smoke the inside of the shell, by burning straw under it, that helps to smooth the surface of the bell. Then they put the shell in the place, so as to leave the same interval between that and the core; and before the hollows of the rings or the cap are put on again, they add two vents, that are united to the rings, and to each other, by a mass of baked cement. After which they put on this mass of the cap, the rings, and the vent, over the shell, and folder it with thin cement, which is dried gradually by covering it with burning coals. Then they fill up the pit with earth, beating it strongly all the time, round the mould.

The furnace has a place for the fire, and another for the metal. The fire-place has a large chimney with a spacious ash-hole. The furnace which contains the metal, is vaulted, whose bottom is made of earth, rammed down; the rest is built with brick. It has four apertures; the first, through which the flame revivates; the second is closed with a stopple that is opened for the metal to run; the others are to separate the dross, or scoriae, of the metal by wooden rakes: through these last apertures passes the thick smoke. The ground of the furnace is built sloping, for the metal to run down.

**FOUNDERY of great guns and mortar pieces.** The method of casting these pieces is little different from that of bells: they are run massy, without any core, being determined by the hollow of the shell; and they are afterwards bored with a steel trepan, that is worked either by horses, or a water-mill.

For the metal, parts, proportions, &c. of these pieces, see **CANNON**.

**Letter FOUNDERY, or casting of printing letters.** The first thing requisite is to prepare good steel-punches, on the face of which is drawn the exact shape of the letter with pen and ink, if the letter be large, or with a smooth blunted point of a needle, if small; and then, with proper gravers, the cutter digs deep between the strokes, letting the marks stand on the punch; the work of hollowing being generally regulated by the depth of the counter punch. then he files the outside, till it is fit for the matrice.

They have a mould to justify the matrices by, which consists of an upper and under part, both which are alike, except the stool and spring behind, and a small roundish wire in the upper part, for making the nick in the shank of the letter. These two parts are exactly fitted into each other, being a male and female gage, to slide backwards and forwards. See **GAGE**.

Then they justify the mould, by casting about twenty samples of letters, which are set in a composing-stick, with the nicks towards the right hand; and comparing these every way with the pattern-letters, set up in the same manner, they find the exact measure of the body to be cast.

Next they prepare the matrix, which is of brass or copper, an inch and a half long, and of a proportionable thickness to the size of the letter it is to contain.

In

In this metal is sunk the face of the letter, by striking the letter-punch the depth of an *n*. After this, the sides and face of the matrice are justified, and cleared, with files, of all bunchings that have been made by linking the punch.

Then it is brought to the furnace, which is built upright of brick with four square sides, and a stone at top, in which is a hole for the pan to stand in.

Printing letters are made of lead, hardened with iron or stub-nails. To make the iron run, they mingle an equal weight of antimony, beaten small in an iron mortar, and stub-nails together. They charge a proper number of earthen pots, that bear the fire, with the two ingredients, as full as they can hold, and melt it in an open furnace, built for that purpose.

When it bubbles, the iron is then melted, but it evaporates very much. This melted compost is ladled into an iron-pot, wherein is melted lead, that is fixed on a furnace close to the former, 3 lb of melted iron to 25 lb of lead; this they incorporate according to art.

The caster taking the pan off the stone, and having kindled a good fire, he sets the pan in again, and metal in it to melt. If it be a small-bodied letter, or a thin letter with great bodies, that he intends to cast, his metal must be very hot, and sometimes red hot, to make the letter come. Then taking a ladle, of which he has several sorts, that will hold as much as will make the letter and break, he lays it at the hole where the flame bursts out: then he ties a thin leather, cut with its narrow end against the face, to the leather groove of the matrice, by whipping a brown thread twice about the leather groove, and fastening the thread with a knot. Then he puts both pieces of the mould together, and the matrice into the matrice-check; and places the foot of the matrice on the stool of the mould, and the broad end of the leather on the wood of the upper half of the mould, but not tight up, lest it hinder the foot of the matrice from sinking close down upon the stool, in a train of work. Afterwards laying a little rosin on the upper part of the mould, and having his casting-ladle hot, he, with the boiling side, melts the rosin, and presses the broad end of the leather hard down on the wood, and so fastens it thereto. Now he comes to casting, when placing the under half of the mould in his left hand, with the hook or jag forward, he holds the ends of its wood between the lower part of the ball of his thumb and his three hinder fingers; then he lays the upper half of the mould upon the under half, so as the male gages may fall into the female; and, at the same time, the foot of the matrice places itself upon the stool, and clasping his left hand thumb strongly over the upper half, he nimbly catches hold of the bow or spring, with his right hand fingers at the top of it, and his thumb under it, and place the point of it against the middle of the notch in the backside of the matrice, pressing it forwards as well towards the mould, as downwards, by the shoulder of the notch, close upon the stool, while, at the same time, with his hinder fingers, as aforesaid, he draws the under half of the mould towards the ball of

his thumb, and thrusts, by the ball of his thumb, the upper part towards his fingers, that both the registers of the mould may press against both sides of the matrice, and his thumb and fingers press both sides of the mould close together.

Then he takes the handle of his ladle in his right hand, and with the ball of it gives two or three strokes outwards upon the surface of the melted metal, to clear it of the scum; then he takes up the ladle full, and having the mould in the left hand, turns his left side a little from the furnace, and brings the geat of his ladle to the mouth of his mould; and turns the upper part of his right hand towards him, to pour the metal into it, while, at the same instant, he puts the mould in his left hand forwards, to receive the metal with a strong shake, not only into the bodies of the mould, but, while the metal is yet hot, into the very face of the matrice, to receive its perfect form there as well as in the shank. Then he takes the upper half of the mould off, by placing his right thumb on the end of the wood next his left thumb, and his two middle fingers at the other end of the wood: he tosses the letter, break and all, out upon a sheet of walle paper, laid on a bench, a little beyond his left hand, and then is ready to cast another letter, as before, and likewise the whole number in that matrix.

Then boys, commonly employed for this purpose, separate the breaks from the shanks, and rub them on a stone, and afterwards a man cuts them all of an even height, which finishes the fount for the use of the printer. See next article.

A workman will ordinarily cast 3000 of these letters in a day. The perfection of letters thus cast, consists in their being all severally square and straight on every side; and all generally of the same height, and evenly lined, without stooping one way or other; neither too big in the foot, nor the head; well grooved, so as the two extremes of the foot contain half the body of the letter; and well ground, barbed, and scrapped, with a sensible notch, &c. See PRINTING.

**FOUNT**, or **FONT**, among printers, a set or quantity of letters, and all the appendages belonging thereto, as numeral characters, quadrates, points, &c. cast by a letter-founder, and sorted.

**FOUNTAIN**, in philosophy, a spring or source of water rising out of the earth. Among the ancients, fountains were held sacred, and even worshipped as a kind of divinities. For the phænomena, theory, and origin of fountains, see **HYDROSTATICS**.

**FOUNTAIN**, or **Artificial FOUNTAIN**, called also a *jet d'eau*, is a contrivance by which water is violently spouted upwards. See **HYDROSTATICS**.

**FOURCHE'E**, or **FOURCHY**, in heraldry, an appellation given to a cross forked at the ends. See Plate LXXX. fig. 8.

**FOWEY**, a borough-town of Cornwall, which sends two members to parliament: W. long. 5°, and N. lat. 50° 26'

**FOWL**, among zoologists, denotes the larger sorts of birds, whether domestic or wild: such as geese, pheasants, partridges, turkey, ducks, &c.

**FOX**, in zoology. See **CANIS**.

**FOX-GLOVE**, in botany. See **DIGITALIS**.

**FOY**, or **ST FOY**, a town in Guienne, in France, thirty two miles east of Bourdeaux; it is situated under the meridian of London, in  $44^{\circ}$ ,  $56'$ , N. lat.

**FRACTION**, in arithmetic and algebra. See **ARITHMETIC**, p. 387. and **ALGEBRA**, p. 83.

**Decimal Fractions**. See **ARITHMETIC**, p. 395.

**FRACTURE**, in surgery, a rupture of a bone, or a solution of continuity in a bone, when it is crushed or broken by some external cause. See **SURGERY**.

**FRÆNUM**, in anatomy, a term applied to some membranous ligaments of the body.

**FRÆNUM LINGUÆ**. See **ANATOMY**, p. 305.

**FRÆNUM PENIS**. See **ANATOMY**, p. 274.

**FRAGA**, a town of Arragon, in Spain, situated under the meridian of London: N. lat.  $41^{\circ}$   $16'$ :

**FRAGARIA**, the **STRAWBERRY**, in botany, a genus of the icofandria polygynia class. The calix is divided into ten segments; the petals are five; and the receptacle is an oval deciduous berry. There are three species, two of them natives of Britain, viz. the vesca, or common strawberry; and the sterilis, or barren strawberry.

**FRANCE**, a large kingdom of Europe, situated between  $5^{\circ}$  W. and  $7^{\circ}$  E. long. and between  $43^{\circ}$  and  $51^{\circ}$  N. lat. being bounded by the English channel and the Austrian Netherlands, on the north; by Germany, Switzerland, Savoy, and Piedmont, in Italy, on the east; by the Mediterranean sea, and the Pyrenean mountains, which separate it from Spain, on the south; and, by the bay of Biscay, on the west. This kingdom was formerly divided into twelve provinces; but at present it is divided into twenty-five general governments, over every one of which is an officer, called an intendant, appointed by the king, who has a power of controlling the governor, and all other officers of justice; and presides over the receivers-general of his generality.

**FRANCFORT**, a city of Germany, situated on the confines of Hesse and Franconia, on both sides of the river Maine: E. lon.  $7^{\circ}$   $30'$ , N. lat.  $50^{\circ}$   $10'$ .

**FRANCFORT on the Oder**, a city of Germany, in the circle of Upper Saxony, and marquisate of Brandenburg, situated in E. long.  $15^{\circ}$ , N. lat.  $52^{\circ}$   $22'$ .

**FRANCHE-COMTE**, the same with the county of Burgundy. See **BURGUNDY**.

**FRANCHE-COMTE**, a province of France bounded by Lorrain on the north; by Alsace and Switzerland, on the east; by La Brefs and Bugey, on the south; by the dukedom of Burgundy, on the west.

**FRANCHISE**, in a general sense, a privilege or exemption from ordinary jurisdiction; as that for a corporation to hold pleas among themselves to such a value, or the like.

**FRANCISCAN MONKS**, **FRIARS MINOR**, or **GREY FRIARS**, religious of the order of St Francis, founded by him in the year 1209.

The rule of the Franciscans, as established by St Francis himself, is briefly this: they are to live in com-

mon, to observe chastity, and to pay obedience to the pope and their superiors.

Before they can be admitted into the order, they are obliged to sell all they have, and give it to the poor: they are to perform a year's noviciate, and when admitted never to quit the order upon any account. They are to fast from the feast of All-saints, to the Nativity. This order has produced four popes, forty-two cardinals, and an infinite number of patriarchs.

**FRANCOLINI**, a town of Italy, situated on the river Po, about nine miles north-east of Ferrara.

**FRANCONIA**, a circle of the German empire, lying between Bohemia on the east, and the electorate of Mentz on the west. Its capital is Nuremberg; and from this county the Franks, who conquered and gave name to the kingdom of France, are said to have come.

**FRANGULA**, in botany. See **RHAMNUS**.

**FRANGULÆ SPECIES**, in botany. See **MAUROCEANIA**.

**FRANK LANGUAGE**, or **LINGUA FRANCA**, a kind of jargon spoken on the Mediterranean, and particularly throughout the coasts and parts of the Levant, composed of Italian, Spanish, French, vulgar Greek, and other languages.

**FRANK**, or **FRANC**, an ancient coin, either of gold or silver, struck and current in France. The value of the gold frank was somewhat more than that of the gold crown; the silver frank was a third of the gold one: this coin is long out of use, though the term is still retained as the name of a money of account; in which sense it is equivalent to the livre, or twenty sols.

**FRANKENDAL**, a city of Germany, in the palatinate of the Rhine, situated on the west side of the river Rhine, in E. long.  $8^{\circ}$   $15'$ , N. lat.  $49^{\circ}$   $30'$ .

**FRANCENIA**, **SEA-HEATH**, or **SEA-CHICKWEED**, a genus of the hexandria monogynia class. The calix is tunnel shaped, and divided into five segments; the petals are five; the stigma has six divisions; and the capsule consists of one cell, with three valves. There are three species, two of them natives of Britain, viz. the lævis, or smooth sea-heath; and the pulverulenta, or broad leaved sea-heath.

**FRANKENSTEIN**, a town of Germany, in the palatinate of the Rhine, and duchy of Zuebruggen, situated twelve miles north-west of Landau.

**FRANKER**, a town of the United Provinces in the province of West Friesland, nine miles west of Lewarden.

**FRANKS**, **FRANKIS**, or **FRANQUIS**, an appellation given by the Turks, and other nations of Asia, to all the people of the western parts of Europe, to which they give the name of *Frankistan*.

**FRANSTAT**, or **FRAUSTAT**, a town of Silesia, situated twenty-five miles north-east of Glogaw, subject to Prussia.

**FRASCATI**, or **FRESCATI**, a town of Italy, in the campania of Rome, thirteen miles east of that city; near which place is the Tusculum of Cicero, called Grotto Ferrate.

**FRATERNITY**, in the Roman-catholic countries, signifies

signifies a society for the improvement of devotion.

Of these there are several sorts; as, 1. The fraternity of the rosary, founded by St Dominic: it is divided into two branches, called the common rosary, and the perpetual rosary; the former of whom are obliged to confess and communicate every first Sunday in the month, and the latter to repeat the rosary continually. See ROSARY.

2. The fraternity of the scapulary, whom the blessed Virgin, according to the sabbatin bull of pope John XXII. has promised to deliver out of hell the first Sunday after their death. See SCAPULARY.

3. The fraternity of St Francis's girdle, are clothed with a sack of a grey colour, which they tie with a cord; and, in processions, walk bare-footed, carrying in their hands a wooden cross.

4. That of St Austin's leathern girdle, comprehends a great many devotees.

Italy, Spain, and Portugal, are the countries where one sees the greatest number of these fraternities, some of which assume the name of arch-fraternities. Pope Clement VII. instituted the arch-fraternity of charity, which distributes bread every Sunday among the poor, and gives portions to forty poor girls on the feast of St Jerom their patron. The fraternity of death, buries such dead as are abandoned by their relations, and causes masses to be celebrated for them.

**FRATRICELLI, LITTLE BROTHERS**, in church history, a sect of heretics who appeared in Italy about the year 1298, and afterwards spread all over Europe. They wore the habit of the Franciscan order, and pretended that ecclesiastics ought to have no possessions of their own.

**FRATRIAGE**, the partition among brothers or coheirs, coming to the same inheritance or succession.

**FRATRES ARVALES**. See ARVALES.

**FRATRICIDE**, the crime of murdering one's brother. See PARRICIDE.

**FRAUD**, in law, signifies deceit in grants, or conveyances of lands, &c. or in bargains and sales of goods, &c. to the damage of another person.

**FRAXINUS**, the **ASH**, in botany, a genus of trees, belonging to the polygamia diœcia class. The calix of the hermaphrodite is divided into four parts; it has no corolla; the stamina are two; and it has but one pistil: the female has one pistil, and one lanceolated seed. There are three species, only one of which, *viz.* the excelsior or common ash, is a native of Britain.

The wood of this tree is in great use among several artificers, as wheel-wrights, cart-wrights, carpenters, turners, &c. also for making ploughs, harrows, axle-trees, oars, balls, &c. It is said to be as lasting for building as oak, and often preferred before it: though the timber of the trunk greatly excels that of a bough.

**FRAY**, among sportsmen. A deer is said to fray its head, when it rubs it against a tree, to cause the pills of the new horns to come off.

**FREAM**, a name given by farmers to plowed lands worn out of heart, and laid fallow till it recover.

**FREDENBERG**, a town of Germany, in the circle of Westphalia, fifty miles west of Cassel.

**FREDERICA**, a town of Georgia, in North America, situated in W. long. 81° 30', N. lat. 31°, on the island of St Simons, in the mouth of the river Alamaha.

**FREDERICKSBURG**, a castle and palace of the king of Denmark, situated in the isle of Zeland, twenty miles north-west of Copenhagen, built upon piles in the middle of a lake.

**FREDERICKSBURG**, a fort upon the gold-coast of Guinea, near cape Three-points, subject to the Danes. It lies in W. long. 2° N. lat. 5°.

**FREDERICKSHALL**, a strong town of Norway, in the province of Agerhuys, situated on the frontiers of Sweden, thirty miles north of Frederickstat.

**FREDERICKSODE**, a town of Jutland, in the province of Reypen, situated on the little belt in the Baltic sea, twenty miles west of Odensee.

**FREDERICKSTAT**, a town of Sleswick, or south Jutland, situated on the river Eyder, near the German ocean, thirty-one miles west of Sleswick.

**FREDERICKSTAT**, a town of Norway, in the principality of Agerhuys, situated on a bay of the sea, called the Schaggerrack, near the frontiers of Sweden: E. long. 11° 24', N. lat. 59°.

**FREE**, in a general sense, is used in opposition to whatever is constrained or necessitated. When applied to things endowed with understanding, it more peculiarly relates to the liberty of the will.

**FREE-HOLD**, signifies lands or tenements which a person holds in fee-simple, fee-tail, or for term of life.

**FREE-STONE**, a whitish stone, dug up in many parts of Britain, that works like alabaster, but is more hard and durable; being of excellent use in building, &c. It is a kind of the grit stone, but finer sanded, and a smoother stone; and is called free, from its being of such a constitution as to cut freely in any direction.

**FREE-THINKER**. See DEIST.

**FREEDOM**, in general, the state or quality of being free.

**FREEDOM of the will**, that power or faculty of the mind, whereby it is capable of acting or not acting, chusing or rejecting whatever it judges proper. Of this every man must be sensible, who finds in himself a power to begin or forbear, continue or end several actions, barely by a thought or preference of the mind.

**FREEZE**, or **FRIEZE**, in commerce, a coarse kind of woollen stuff, or cloth, for winter wear; so called, as being freezeed or naped on each side.

**FREEZING**, in philology, the same with coagulation. See CONGELATION and FROST.

Philosophers are by no means agreed as to the cause of this phenomenon. The Cartesians account for it by the recess or going out of the ethereal matter from the pores of the water. The corpuscularians, on the other hand, attribute it to the ingress of frigorific particles, as they call them; and Hobbes asserts, that these particles

ticles are nothing else but common air, which entangling itself with the particles of water, prevents their motion. Others will have a kind of nitrous salt to be the cause of congelation, by insinuating itself between the particles of water, and fixing them together, like nails. And, indeed, it seems probable that cold and freezing do arise from some substance of a saline nature floating in the air; since all salts, and particularly nitrous ones, when mixed with ice and snow, greatly increase their cold, and even bulk.

Boerhave observes, that it is extremely difficult to exhibit to the eye the precise degree of cold wherein ice begins to form; since heat and cold, once given to a body, adhere long to it before they quit it. When the air, therefore, is in such a state as keeps Fahrenheit's thermometer at 32 degrees, water will not freeze; because water being 800 times denser than air, retains the warmth considerably longer than air. If any person, therefore, is curious to know in what degree of cold water begins to freeze, let him first suspend a thermometer in a free open air on all sides; and then wetting a thin linen cloth with clear water, and hanging it likewise in the open air, it will grow stiff upon the first access of the freezing cold, and thereby shew when water is beginning to turn to ice. See THERMOMETER.

By means of freezing, wine, vinegar, and malt-liquors may be reduced to a fourth part of their quantity, without any considerable loss of their essential parts; since only the aqueous parts freeze, leaving the vinous parts concentrated or brought into less compass, and capable of being transported with less expence, and keeping for several years.

**FREEZING MIXTURE.** Mr Boyle shews in his history of cold, that not only all kinds of salts, but likewise spirits, sugar, and saccharum saturni, mixed with snow, are capable of freezing most fluids; and the same effect was also produced by the mixture of oil of vitriol, or spirit of nitre with snow.

**FREIGHT, or FRAIGHT,** in navigation and commerce, the hire of a ship, or a part thereof, for the conveyance and carriage of goods from one port or place to another; or the sum agreed on between the owner and the merchant, for the hire and use of a vessel.

**FRENCH,** in general, something belonging to France: thus we say, the French language, French customs, polity, &c.

The French language is made up of Latin, Greek, Teutonic, and the language spoken by the old Gauls. It is natural, and easily pronounced, and therefore used by most nations of Europe in conversing with foreigners. There are very few compound words in French, which is acknowledged to be its disadvantage. It has also few diminutives; but as to purity, easiness, and flexibility, it yields to none.

**FRESCO,** a method of painting in relieve on walls, so as to endure the weather.

It is performed with water-colours on fresh plaster; or on a wall laid with mortar not yet dry. This sort of painting has a great advantage by its incorporating

with the mortar, and, drying along with it, becomes very durable.

The compost should be made of rubbish stones mix with well burnt flint, or lime, and water: but the saltiness of the lime must be washed out, by pouring water frequently on it. But this should not be done in moist weather.

To prevent the plaster from peeling, strike into the joints of the wall stumps of horse-nails six inches distant from each other. First plaster the walls pretty thick; then let it dry for some time, the design and colours being first ready prepared. This painting is chiefly performed on walls and vaults newly plastered with lime and sand; and the plaster is only to be put on in proportion as the painting proceeds.

Plaster the wall a second time, about the thickness of half a crown, only so much as you intend to work upon; and while it is wet, work the colours therein, which will incorporate with the plaster so as never to wash out.

The painting must be worked with a free hand, and your colours made high enough at first, as there can be no alteration made after the first painting.

In this work scarce any thing else is used but earths, which still retain their colour, defending it from the burning and salt of the lime. The colours are white, made of lime slacked some time, and white marble dust, red and yellow oker, violet red, verditer, lapis lazuli, finalt, black Spanish brown, Spanish white, &c. all which are grounded and worked up with water.

The brushes and pencils for this work must be long and soft, or else they will rake and raze the painting: the colours must be full and flowing from the brush, and the design or cartoon must be perfect in the paper-copy.

**FRESH,** in general, something that is new, pure, and good; or, that has little or no salt in it.

**FRET, or FRETTE,** in architecture, a kind of knot or ornament, consisting of two lists or small fillets variously interlaced or interwoven, and running at parallel distances equal to their breadth.

**FRET,** in heraldry, a bearing composed of six bars, crossed, and variously interlaced, as represented in plate LXXX. fig. 9.

Some call it the true lover's knot.

**FRET,** in music, signifies a kind of stop on some instruments, particularly bass-voils and lutes. Frets consist of strings tied round the neck of the instrument, at certain distances, within which such and such notes are to be found.

**FRET-WORK,** that adorned with frets. It is sometimes used to fill up and enrich flat empty spaces; but is mostly practised in roofs, which are fretted over with plaster work.

**FREYSTAT.** a town of Silesia, in Germany, E. long. 17° 55', N. lat. 50°.

**FRIABLE,** among naturalists, an appellation given to bodies that are easily crumbled to pieces: such are the free stone, pumice-stone, &c.

**FRIAR,** a term common to monks of all orders, found-  
ed

ed on this, that there is a kind of fraternity, or brotherhood, between the several religious persons of the same convent or monastery.

Friars are generally distinguished into these four principal branches, *viz.* 1. Minors, grey friars, or franciscans. 2. Augustines. 3. Dominicans, or black friars. 4. White friars, or carmelites. From these four the rest of the orders descend. See FRANCISCANS, AUGUSTINES, &c.

**FRIBURG**, the capital of a canton of the same name in Switzerland, situated eighteen miles south west of Bern: E. long.  $6^{\circ} 55'$ , N. lat.  $46^{\circ} 50'$ .

**FRIBURGH**, a city of Swabia, in Germany, twenty-eight miles south of Stralsburg.

**FRICENTO**, a town and bishop's see of Italy, forty-three miles east of the city of Naples.

**FRICITION**, in mechanics, the rubbing of the parts of engines and machines against each other, by which means a great part of their effect is destroyed. See MECHANICS.

**FRIDBURG**, an imperial city of Bavaria, in Germany: E. long.  $10^{\circ}$ , and N. lat.  $48^{\circ} 35'$ .

**FRIDBURG** is also the name of two other towns in Germany, both situated in the circle of Upper Saxony, the one nine miles south-west of Dresden, and the other thirty miles west of Leipzig.

**FRIEDBURG**, an imperial city of Germany, sixteen miles north of Francfort on the main.

**FRIESLAND**, one of the most northern provinces of the united Netherlands, bounded by the German ocean on the north, by Groningen and Overysfel on the east, by the Zuider-sea and Overysfel on the south, and by the same ocean on the west: its chief town is Lewarden.

*East-FRIESLAND*, a province of Westphalia, in Germany, being the north-west part of Germany, bordering on Groningen.

**FRIEZE**, **FREEZE**, or **FRISE**, in architecture, a large flat face, or member, separating the architrave from the cornice, being that part of the entablature between the architrave and the cornice. See ARCHITECTURE.

**FRIGAT**, among seamen, a ship of war, light built, and that is a good sailer.

A frigate has commonly two decks; whence that called a light frigate, is a frigate with only one deck.

**FRIGID**, is applied to a jejune style, that is unanimated by any ornaments, and consequently without any force or vigour.

**FRIGORIFIC**, in physiology, small particles of matter, which, according to Gassendus and others, being actually and essentially cold, and penetrating other bodies, produce in them that quality which we call cold.

**FRILL**, in falconry. When a hawk trembles, or shivers, they say she frills.

**FRINGILLA**, in ornithology, a genus belonging to the order of passeris. The bill is conical, straight, and sharp-pointed. There are no less than thirty species comprehended under this genus, distinguished principally by varieties in their colour.

1. The brown fringilla with a tawny neck, and white spots on the wings and hinder part of the back.

It is the Carolina ortolan of Catesby, and is a bird of the island of Cuba; only the hens pass into Carolina in the autumn. 2. The fringilla with black limbs, and the wings white on both sides; the three first feathers of the tail are without spots, but two of the chief are obliquely spotted. It is the chaffinch of English authors, and is a bird of Europe. 3. The fringilla, with the base of the wings underneath of a deep yellow colour. It is the brambling or mountain finch of English authors, and is a bird of Europe. 4. The brown fringilla, with a reddish breast and shoulders, and the black wings marked with a reddish spot: It is an inhabitant of Sweden. 5. The fringilla with a blackish spotted head, and a white spot behind the eyes. It is the greater chaffinch of Albin, and is found in Lapland. 6. The fringilla with the limbs, wings, and tail black, only the outermost from the middle externally white. It is a bird of Sweden. 7. The grey fringilla, spotted with black, has a space running from the bill to the sides of the neck black. It is the shomburgher, a kin to the lark of Edwards, and is a bird of South America. 8. The black fringilla, with a reddish gloss, and a reddish belly, with a white spot on the wings, is the American black sparrow with red eyes, of Catesby. 9. The fringilla, with the quill-feathers red forwards, and the outermost without any spots; the two outermost are white in the middle, as the rest are at the point. This is the goldfinch of English authors. 10. The fringilla with a red face and tail, the belly undulated with white and black, and the back green. It is the green goldfinch of Edwards, and is a Chinese bird. 11. The fringilla with purple tail-feathers, with the hinder halves black. It is the amaduvad of Albin, and an inhabitant of the East Indies. The cock is all over purple; but the hen is ash-coloured, except the bill and tail. 12. The green fringilla with a red head, a yellow collar, and a blue breast. It is the red-headed green finch of Edwards. 13. The fringilla all over red, is the red fly-catcher of Catesby, and is a bird of America. 14. The yellow fringilla, with a black forehead and brown wings, is the American goldfinch of Catesby. 15. The fringilla with a black head, a tawny breast, and a white streak on the wings and above and below the eyes, is the Bahama finch of Catesby. 16. The fringilla with a wedge-like tail, a reddish body, a red bill, and the temples, rump and belly of a violet colour, is the red and blue Brazilian finch of Edwards. 17. The green fringilla, with the supercilia, breast and belly yellow, but the prime feathers of the wings are white on the outer edge. It is the Indian green finch of Edwards, and is found in Madera. 18. The fringilla with a whitish body and bill, and the prime feathers of the wings and tail greenish. This is the Canary bird of English authors, and is found in the Canary islands. 19. The fringilla with the prime feathers of the wings yellow in the middle, and the fore first chief tail-feathers without spots; but they are yellow at the base, and black at the points. It is the siskin of English authors, and haunts places where juniper-bushes grow. 20. The brown fringilla, with a flame coloured crest,

- is the brown linnet of Klein. 21. The brown fringilla, with a yellowish bill, is an European bird, as are also the two former. 22. The fringilla, with the prime feathers of the wings, and the chief feathers of the tail black, but white on the edges. It is the greater red-headed linnet of Ray, and is a bird of Europe. 24. The fringilla, with a brown back, and a blue belly and tail, is the blue bellied finch of Edwards, and is found in Africa. 25. The violet-coloured fringilla, with the forehead and under part of the body of a deep yellow colour; the back, neck, prime feathers of the wings, and upper part of the tail are of a bluish black colour; but the forehead, breast, belly, and under part of the neck are of a deep yellow. The bill is exceeding short, triangular, black and crooked at the point. 26. The fringilla with the chief feathers of the tail brown, and the outermost marked with a wedge-like spot; the body is variegated with grey and black, and the head is black. It is the reed sparrow of English authors, and is a bird of Europe. 27. The fringilla with the prime feathers of the wings and tail brown, the body variegated with grey and black, and a single white streak on the wings. This is the house-sparrow of English authors, and is an European bird. 28. The fringilla with the prime feathers of the wings and tail brown, the body variegated with grey and black, and a double white streak on the wings. This is the mountain sparrow of Ray, and is a bird of Europe. 29. The ferruginous fringilla, with a black head and a blue bill, is the Chinese sparrow of Edwards. 30. The black fringilla, with a white belly, is the American snow-sparrow of Catesby.
- FRINWALT**, or **FRIDLAND**, a town of Brandenburg, thirty miles north-east of Berlin, situated on the west side of the river Oder.
- FRIO**, a cape or promontory of Brasil: W. long. 44°, and S. lat. 23° 30'.
- FRISACH**, a town of Bavaria, sixty miles south-east of Saltzburg: E. long. 14° 15', and N. lat. 47° 20'.
- FRISONE**, in ornithology. See **LOXIA**.
- FRIT**, in the glass-manufacture, the matter or ingredients whereof glass is to be made, when they have been calcined or baked in a furnace; or it is the calcined matter to be run into glass. See **GLASS**.
- FRITH**, in its most usual acceptation, signifies an arm of the sea: such are the frith of Forth or of Edinburgh, the frith of Clyde, Murray frith, &c.
- FRITILLARIA**, in botany, a genus of the hexandria monogynia class. The corolla consists of six bell-shaped petals, with a hollow nectarium above the unguis of each petal; and the stamina are of an equal length with the petals. There are five species, only one of which is a native of Britain, *viz.* the meagris or common checkered daffodil.
- FRIULI**, a province of Italy, subject to Venice, and bounded by Carinthia in Germany on the north, by Carniola on the east, by the gulph of Venice on the south, and by the Bellunese and Feltrin on the west.
- FRIZING** of cloth, a term, in the woollen manufactory, applied to the forming of the nap of a cloth, or fluff, into a number of little hard burrs or prominences, covering almost the whole ground thereof.
- Some cloths are only frized on the back side, as black cloths; others on the right side, as coloured and mixed cloths, rascens, bays, freezes, &c.
- Frizing may be performed two ways; one with the hand, that is, by means of two workmen, who conduct a kind of plank that serves for a frizing instrument.
- The other way is by a mill, worked either by water, or a horse, or sometimes by men. This latter is esteemed the better way of frizing, by reason the motion being uniform and regular, the little knobs of the frizing are formed more equally and regularly.
- FROBISHER'S STRAITS**, in west Greenland, lie a little to the northward of Cape Farewel: W. long. 48°, and N. lat. 63°.
- FRODINGHAM**, a market-town of Yorkshire, thirty miles east of York.
- FRODSHAM**, a market-town of Chester, fourteen miles north east of Cheller.
- FROG**, in zoology. See **RANA**.
- FRONTEIRA**, a town of Portugal, in the province of Alentejo: W. long 8° 6', and N. lat. 38° 50'.
- FRONTIER**, the border, confine, or extremity of a kingdom or province, which the enemies find in front, when they would enter the same: thus we say, a frontier town, a frontier province, &c.
- Frontiers were anciently called marches.
- FRONTIS OS**, in anatomy. See **ANATOMY**, p. 152.
- FRONTIGNIAC**, a town of Languedoc in France, situated sixteen miles south-west of Montpellier, and remarkable for producing excellent wine.
- FROST**, in physiology, such an excessively cold state of the air as converts watery fluids into ice.
- In very cold snowy weather, not only water, but urine, beer, ale, milk, vinegar, and even wine, are either wholly or in part converted into ice, though the last but slowly. As to the freezing of expressed oils, a very intense cold may deprive them of their fluidity, so as to be capable of being cut into portions of any figure; but whether they are convertible into real ice, is not yet determined. In Russia oil freezes much harder than with us, but does not even there become perfect ice. Common anniseed-water, and the like weak spirits, are said to be converted into an imperfect ice in Muscovy; and the strong spirits into a substance like that of oil. When brandy freezes, a liquid part, much stronger than common brandy, retires to the centre of the vessel.
- Even solid bodies are liable to be affected by frost: timber is often apparently frozen, and rendered exceedingly difficult to saw. Marble, chalk, and other less solid terrestrial concretions, will be shattered by strong and durable frosts. Metals are contracted by frost: thus, an iron tube, twelve foot long, upon being exposed to the air in a frosty night, lost two lines of its length. On the contrary, it swells or dilates fluids near one tenth of their bulk. Mr Boyle made several experiments with metalline vessels, exceeding thick and strong; which being filled with water close stopped, and exposed to the cold, burst by the expansion of the frozen fluid within them. Trees are frequently



quently burnt up with frost, as with the most excessive heat; and in very strong frosts, walnut-trees, alders, and even oaks, are sometimes miserably split and cleft, so as to be seen through, and this with a terrible noise, like the explosion of fire arms.

Frost naturally proceeds from the upper parts of bodies downwards; but how deep it will reach in earth or water, is not easily known, because this depth may vary with the degree of coldness in the air, by a longer or shorter duration of the frost, the texture of the earth, the nature of the juices wherewith it is impregnated, the constitution of its more internal parts as to heat and cold, the nature of its effluvia, &c. Mr Boyle, in order to ascertain this depth, after four nights of hard frost, dug in an orchard, where the ground was level and bare, and found the frost had scarce reached three inches and a half; and in a garden nearer the house, only two inches below the surface. Nine or ten successive frosty nights froze the bare ground in the garden six inches and a half deep; and in the orchard, where a wall sheltered it from the south sun, to the depth of eight inches and a half. He also dug in an orchard, near a wall, about a week afterwards, and found the frost to have penetrated to the depth of fourteen inches. In a garden at Moscow, the frost in a hard season only penetrates to two feet: and the utmost effect that capt. James mentions the cold to have had upon the ground of Charlton island, was to freeze it to ten feet deep: whence may appear the different degrees of cold of that island and Russia. And as to the freezing of water at the above-mentioned island, the captain tells us, it does not naturally congeal above the depth of six feet, the rest being by accident. Water also, exposed to the cold air in large vessels, always freezes first at the upper surface, the ice gradually increasing and thickening downwards; for which reason frogs retire in frosty weather to the bottom of ditches, and it is said, that shoals of fish retire in winter to those depths of the sea and rivers, where they are not to be found in summer. Water, like the earth, seems not disposed to receive any very intense degree of cold at a considerable depth or distance from the air. The vast masses of ice found in the northern seas being only many flakes and fragments, which, sliding under each other, are, by the congelation of the intercepted water, cemented together.

In cold countries, the frost proves often fatal to mankind; not only producing cancers, but even death itself. Those who die of it have their hands and feet first seized till they grow past feeling it; after which the rest of their bodies is so invaded, that they are taken with a drowsiness, which if indulged, they awake no more, but die insensibly. But there is another way whereby it proves mortal, *viz.* by freezing the abdomen and viscera, which on dissection are found to be mortified and black.

**Hoar-Frost**, a cold moist vapour, that is drawn up a little way into the air, and in the night falls again on the earth, where it is congealed into icy crystals of various figures. Hoar-frost therefore is nothing but dew, turned into ice by the coldness of the air.

**FROTH**, a white, light substance, formed on the surface of fluids, by vehement agitation, consisting of little spherules, or globules.

**FROTH SPIT**, or **CUCKOW SPIT**, a name given to a white froth, or spume, very common, in the spring and first months of the summer, on the leaves of certain plants, particularly on those of the common white field lychnis or catch fly, thence called by some spatling poppy.

All writers on vegetables have taken notice of this froth, though few have understood the cause or origin of it till of late; being formed by a little leaping animal, called by some the flea grass-hopper, by applying its anus close to the leaf, and discharging thereon a small drop of a white viscous fluid, which containing some air in it, is soon elevated into a small bubble: before this is well formed, it deposites such another drop, and so on, till it is every way overwhelmed with a quantity of these bubbles, which form the white froth which we see.

**FRUCTIFEROUS**, signifies properly any thing that produces fruit.

**FRUCTIFICATION**, among botanists, in a more lax sense, includes the flower and fruit, with their several coverings. See **BOTANY**.

**FRUIT**, in general, includes whatever the earth produces for the nourishment and support of man, and other animals; as herbs, grain, hay, corn, &c.

**FRUIT**, more properly, signifies the production of a tree, or plant, for the propagation or multiplication of its kind; in which sense the word takes in all kinds of seeds with their furniture. But botanists usually understand by it that part of a plant wherein the seeds are contained.

**FRUIT** also implies an assemblage of seeds in a head; as in a ranunculus, &c. and all kinds of seeds, or grains, whether inclosed in a cover, capsule, or pod; and whether bony, fleshy, skinny, membranous, or the like. See **AGRICULTURE**, Part I.

**FRUMENTACEOUS**, a term applied by botanists to all such plants as have a conformity with wheat, in respect of their fruits, leaves, ears, or the like.

**FRUMENTARI**, a kind of soldiers, or archers, under the western empire.

The first time we read of these officers is in the time of the emperor Adrian, who made use of them to inform himself of whatever passed. They did not make any particular corps distinct from the rest of the forces, but there was a certain number of them in each legion. It is supposed, that they were at first a number of young persons disposed by Augustus throughout the provinces, particularly on all the grand roads, to acquaint the emperor, with all expedition, of every thing that happened.

Afterwards they were incorporated into the troops themselves, where they still retained their ancient name. As their principal office was the giving intelligence, they were often joined with the curiosi, with whom they agreed in this part of their office.

Their name of frumentarii is derived from their being also a sort of purveyors to the armies, cities, &c.

col.

collecting all the corn from the several provinces to furnish the common-wealth.

**FRUMENTATION**, in Roman antiquity, a largess of corn bestowed on the people. This practice of giving corn to the people was very ancient among the Romans; and frequently used to sooth the turbulent humour of the populace. At first the number of those to whom this largess was given, was indeterminate, till Augustus fixed it at two hundred thousand.

**FRUSH**, or **FROG**, among farriers, a sort of tender horn which arises in the middle of a horse's sole; and, at some distance from the toe, divides into two branches, running towards the heel in the form of a fork.

**FRY**, in zoology, signifies the spawn, or rather young, of fish.

**FUCUS**, in botany, a genus of submarine plants, belonging to the cryptogamia class.

The fucus consists of a tough matter, formed into a kind of leaves, which are flat and variously divaricated; and which have some appearance of fructification, in punctated tubercles, covering oblong vesicles, supposed by Linnæus to be male flowers; and smooth roundish vesicles, hollow and interwoven with filaments, which appear to him to be female flowers. There are thirty-four species of fucus, or sea wrack, many of them to be found on our coasts.

**FUEL**, whatever is proper to burn or make a fire; as, wood, turfs, peats, bituminous earths, coals, &c.

**FUGALIA**, in Roman antiquity, a feast supposed by some to be the same with the refugium, held on the 24th of February, in memory of the expulsion of the kings, and the abolishing of the monarchical government. Others again distinguish the fugalìa from the refugium. And others think, that the Fugalìa was the same with the poplufugia, or the feast of Fugia, the goddess of joy, occasioned by the rout of an enemy, which was the reason the people abandoned themselves to riot and debauchery.

**FUGITIVE**, a person obliged to fly his country, or remove from a place where he had some abode, or establishment, on account of his crimes, debts, or other occasions.

**FUGUE**, in music, is when different parts of a musical composition follow each other; each repeating what the first had performed.

**FULCRUM**, in mechanics, the prop or support by which a lever is sustained. See **MECHANICS**.

**FULD**, a town and abbey of Germany, the abbot of which is a prince of the empire: E. long. 9° 35', N. lat. 50° 34'.

**PULICA**, the **COOT**, in ornithology, a genus of birds, of the order of grallæ. It has a convex bill, with the upper mandible fornicated over the lower at the edge; the lower mandible is gibbous behind the tip. The forehead is bald, and the feet have four toes a little lobated. There are four species.

1. The Fulica with a bald forehead, a black body, and lobated toes. It is the coot of Ray, and an inhabitant of Europe, and feeds upon seeds and herbs, and runs as well as swims upon the water. 2. The felica with a bald forehead, and toes without webs.

It is the water-hen, or moor-hen of Ray, and is found in Europe. 3. The fulica with a bald forehead, a violet-coloured body, and toes without webs, is the purple water hen of Edwards, and it inhabits Asia and America. 4. The felica with a carunculated forehead, a variegated body, squamous shoulders, and toes without webs; but the nail on the hinder toe is exceeding long. It is the spur-winged water-hen of Edwards, and is an inhabitant of South America. The nail on the hind toe is strait, and longer than a man's finger. The pollex rests upon one joint, and the wings are green.

**FULIGINOUS**, whatever proceeds from a thick, sooty smoke, such as litharge and lamp black.

**FULIGNO**, a city of Italy, in the pope's territories, ten miles north of Spoleto.

**FULIGO**, in natural history, a species of pumice-stone. See **PUMICE**.

**FULLER**, a workman employed in the woollen manufactories, to mill or scour cloths, serges, and other stuffs, in order to render them more thick, compact, and durable. See **CLOTH**.

**FULLER'S EARTH**, in natural history, a soft, greyish, brown, dense, and heavy marle: when dry, it is of a greyish ash-coloured brown, in all degrees from very pale to almost black, and it has generally something of a greenish cast: it is very hard and firm, of a compact texture, of a rough and somewhat dusty surface that adheres slightly to the tongue: it is very soft to the touch, not staining the hands, nor breaking easily between the fingers: it has a little harshness between the teeth, and melts freely in the mouth: thrown into water, it makes no ebullition, or hissing, but swells gradually in bulk, and falls into a fine soft powder. It makes no effervescence with aqua fortis.

It is of great use in scouring cloths, stuffs, &c. imbibing all the grease and oil used in preparing, dressing, &c. of the wool, for which reason it is made a contraband commodity, and is not to be exported under the penalty of 1 s. for every pound weight. See **FULLING**.

**FULLER'S WEED**, in botany. See **DIPSACUS**.

**FULLERY**, a place where cloths, &c. are fulled. See the next article.

**FULLING**, the art or act of scouring and pressing cloths, stuffs, stockings, &c. to cleanse, thicken, and render them more firm and strong, which is done by means of a water mill.

Fuller's earth is used with some proportion of soap; but soap alone would do much better, was it not dearer than fuller's earth.

Fulling of stockings, caps, &c. is performed either with the hands or feet, or a kind of wooden machine, either armed with wooden teeth, or those of horses or bullocks. The ingredients generally used on this occasion are fuller's earth, urine, white soap and green soap. But water softened with chalk is far preferable.

**FULMINATING**, something that thunders, or resembles thunder.

**FULMINATION**, in chemistry, is used in a synonymous sense with detonation.

Fulmination,

**Fulmination** in the depuration of the more perfect metals, is, when, upon infusing them with lead, a brighter colour succeeds a kind of sulphureous cloud, before appearing in the metals, during the fusion.

**FULMINATION**, in the Romish canon law, a sentence of a bishop, official, or other ecclesiastic appointed by the pope, by which it is decreed, that some bull sent from the pope shall be executed.

**FUMARIA**, in botany, a genus of the diadelphia hexandria class. The calix consists of two leaves; and the corolla is ringent. There are 11 species, three of them natives of Britain, *viz.* the officinalis, or fumitory; the capreolata, or ramping fumitory; and the claviculata, or climbing fumitory.

The whole plant of the officinalis is used in medicine, being accounted good in the scurvy, jaundice, and disorders of the mesentery and spleen.

**FUMIGATION**, in chemistry, a kind of calcination, when metals, or other hard bodies, are corroded, or softened, by receiving certain fumes for that purpose.

**FUMIGATION**, in medicine, the application of fumes to particular parts of the body; as those of sacitious cinnabar, to venereal ulcers.

**FUMITORY**, in botany. See **FUMARIA**.

**FUNCHAL**, the capital of the Madeira islands, subject to Portugal: W. long. 16°, N. lat. 32° 33'.

**FUNCTION**, the act of fulfilling the duties of any employment.

**FUNCTION**, being also applied to the actions of the body, is by physicians divided into vital, animal, and natural. The vital functions are those necessary to life, and without which the individual cannot subsist; as the motion of the heart, lungs, &c. The natural functions are such as it cannot subsist any considerable time without them, as the digestion of the aliment, and its conversion into blood. Under animal functions are included the senses of touching, tasting, &c. memory, judgment, and voluntary motion, without any, or all of which an animal may live, but not very comfortably.

The animal functions perform the motion of the body by the action of the muscles, and this action consists chiefly in the shortening the fleshy fibres, which is called contraction, the principal agents of which are the arteries and nerves distributed in the fleshy fibres.

In short, all parts of the body have their own functions, or actions peculiar to themselves. Life consists in the exercise of these functions, and health in the free and ready exercise of them.

**FUND**, in commerce, signifies the stocks of the great trading and monied companies. See **STOCKS**.

**FUNDAMENT**, in anatomy. See **ANUS**.

**FUNDI-BAY**, that situated between New England and New Scotland, in which there is said to be an excellent fishery.

**FUNEN**, the second island for magnitude belonging to the king of Denmark, situated at the entrance of the Baltic sea, and separated from Jutland by the strait called the lesser Belt, and from the island of Zealand by the strait called the great Belt. Its chief town is Odensee.

Vol. II. No. 53.

**FUNERAL RITES**, ceremonies accompanying the interment or burial of any person.

These rites differed among the ancients according to the different genius and religion of each country. The Egyptians, among the rest of their funeral rites, embalmed their dead.

Among the ancient Greeks it was usual sometimes, before the interment, to put a piece of money into the mouth of the deceased, which was thought to be Charon's fare for wafting the departed soul over the infernal river. This ceremony was not used in those countries which were supposed to be situated in the neighbourhood of the infernal regions, and to lead thither by a ready and direct road. The corpse was likewise furnished with a cake, composed of flour, honey, &c. which was designed to appease the fury of Cerberus, the door-keeper of hell, and to procure the ghost a safe and quiet entrance.

During the time the corpse continued in the house, there stood before the door a vessel of water, the design of which was, that those concerned about the body might purify themselves by washing; it being the opinion of the Greeks, as well as of the Jews, that pollution was contracted by touching a dead body.

The ceremonies by which they expressed their sorrow for the death of their friends, were various; but it seems to have been a constant rule to recede as much as possible in habit and behaviour from their ordinary customs. For this reason they abstained from banquets and entertainments; they directed themselves of all ornaments; they tore, cut off, or shaved their hair, which they cast into the funeral pile, to be consumed with the body of their deceased friend. Sometimes they threw themselves on the ground, and rolled in the dust, or covered their head with ashes; they beat their breasts, and even tore their flesh with their nails, upon the loss of a person they much lamented. When persons of rank, such as public magistrates, or great generals, died, the whole city put on a face of mourning: all public meetings were intermitted; the schools, baths, shops, temples, and all places of concourse were shut up.

Interring or laying the dead in the ground, seems to have been the most ancient practice among the Greeks; though burning came afterwards to be generally used among them. It was customary to throw into the funeral pile those garments the deceased usually wore. The pile was lighted by one of the dead person's nearest relations or friends, who made prayers and vows to the winds to assist the flames, that the body might quickly be reduced to ashes; and during the time the pile was burning, the dead person's friends stood by it, pouring libations of wine, and calling upon the deceased.

When Numa reformed the religion of Rome, he ordered that the pontiffs should have the care of the funeral ceremonies; which, in most respects, were like those of the Greeks already described.

The funeral rites among the Hebrews, were solemn and magnificent: when any person was dead, his relations and friends rent their cloaths; which custom is but faintly imitated by the modern Jews, who only cut off a

bit of their garment, in token of affliction. It was usual to bend the dead person's thumb into the hand, and fasten it in that posture with a string; because the thumb then having the figure of the name of God, they thought the devil would not dare to approach it. When they came to the burying place, they made a speech to the dead in the following terms: "Blessed be God, who has formed thee, fed thee, maintained thee, and taken away thy life. O dead! he knows your numbers, and shall one day restore your life, &c." Then they spoke the elogium, or funeral oration, of the deceased; after which they said a prayer, called the righteousness of judgment; then turning the face of the deceased towards heaven, they called out, "Go in peace."

The ancient Christians testified their abhorrence of the Pagan custom of burning the dead; and always deposited the body entire in the ground: and it was usual to bestow the honour of embalming upon the martyrs at least, if not upon others. They prepared the body for burial, by washing it with water, and dressing it in a funeral attire. The exportation, or carrying forth of the body, was performed by near relations, or persons of such dignity as the circumstances of the deceased required. Psalmody, or singing of Psalms, was the great ceremony used in all funeral processions among the ancient Christians.

In the Romish church, when a person is dead, they wash the body, and put a crucifix in its hand. At its feet stands a vessel full of holy water, and a sprinkler, that they who come in may sprinkle both themselves and the deceased. In the mean time some priest stands by the corpse, and prays for the deceased till it is laid in the earth. In the funeral procession, the exorcist walks first, carrying the holy water; next the cross-bearer, afterwards the rest of the clergy, and last of all the officiating priest. They all sing the *miserere*, and some other psalms; and at the end of each psalm a *requiem*. We learn from Alet's ritual, that the faces of deceased laymen must be turned towards the altar, when they are placed in the church; and those of the clergy, towards the people. The corpse is placed in the church surrounded with lighted tapers: after the office for the dead, mass is said; then the officiating priest sprinkles the corpse thrice with holy water, and as often throws incense on it. The body being laid in the grave, the friends and relations of the deceased sprinkle the grave with holy water.

The funeral ceremonies of the Greek church, are much the same with those of the Latin. It needs only be observed, that after the funeral service, they kiss the crucifix, and salute the mouth and forehead of the deceased; after which each of the company eats a bit of bread, and drinks a glass of wine in the church, wishing the soul a good repose, and the afflicted family all consolation.

**FUNERAL GAMES**, a part of the ceremony of the ancient funerals.

It was customary for persons of quality, among the ancient Greeks and Romans, to institute games with all sorts of exercises, to render the death of their

friends more remarkable. This practice was generally received, and is frequently mentioned by ancient writers. Patroclus's funeral games, take up the greatest part of one of Homer's Iliads; and Agamemnon's ghost is introduced by the same poet telling the ghost of Achilles, that he had been a spectator at a great number of such solemnities.

The celebration of these games among the Greeks, mostly consisted of horse-races; the prizes were of different sorts and value, according to the quality and magnificence of the person that celebrated them. The garlands, given to victors on this occasion, were usually of parsley, which was thought to have some particular relation to the dead.

Those games, among the Romans, consisted chiefly of processions; and sometimes of mortal combats of gladiators around the funeral pile. They, as well as the Greeks, had also a custom, though very ancient, of cutting the throats of a number of captives before the pile, as victims to appease the manes of the deceased. Cæsar relates, that the Gauls had this custom,

The funeral games were abolished by the emperor Claudius.

**FUNERAL ORATION**, a discourse pronounced in praise of a person deceased, at the ceremony of his funeral.

**FUNGIBLES**, in Scots law, are such things as are estimated by number, weight, or measure; as, coin, butter, ale, &c.

**FUNGITÆ**, in natural history, a kind of fossile coral, of a conic figure, though sometimes flatted and striated longitudinally.

**FUNGUS**, in surgery, denotes any spongy excrescence. See **SURGERY**.

**FUNGUS**, in botany, See **BOTANY**, p. 636.

**FURCA**, in antiquity, a piece of timber resembling a fork, used by the Romans as an instrument of punishment.

The punishment of the furca was of three kinds: the first only ignominious, when a master, for small offences, forced his servant to carry a furca on his shoulders about the city. The second was penal, when the party was led about the circus, or other place, with the furca about his neck, and whipped all the way. The third was capital, when the malefactor, having his head fastened to the furca, was whipped to death.

**FURCHE'**, in heraldry, a cross forked at the ends.

**FURIES**, in Pagan antiquity, certain goddesses whose office it was to punish the guilty after death. These were three in number; Alecto, Megera, and Tisiphone, who were described with snakes instead of hair, and eyes like lightening, carrying iron-chains and whips in one hand, and in the other flaming torches; the latter to discover, and the former to punish the guilty; and they were supposed to be constantly hovering over such persons as had been guilty of any enormous crime.

Mythologists suppose, that Tisiphone punished the crimes which sprang from hatred or anger; Megera, those from envy; and Alecto, those from an insatiable pursuit after riches and pleasure. They were worshipped at Casina in Arcadia, and at Carmia in Peloponnesus.

- Fus.** They had a temple at Athens, near the Areopagus, and their priests were chosen from amongst the judges of that court. At Telphusia, a city in Arcadia, a black ewe was sacrificed to them.
- FURLING**, in the sea language, signifies the wrapping up and binding any sail close to the yard; which is done by hauling upon the clew lines, bunt-lines, &c. which wraps the sail close together, and being bound fast to the yard, the sail is furled.
- FURLONG**, a long measure, equal to one eighth of a mile, or forty poles.  
It is also used, in some law-books, for the eighth part of an acre.
- FURLOUGH**, in the military language, a licence granted by an officer to a soldier, to be absent for some time from his duty.
- FURNACE**, an utensil, or vessel, proper to contain fire; or to raise and maintain a vehement fire in, whether of coal or wood. See **CHEMISTRY**, p. 110.
- FURNES**, a town of Flanders, ten miles east of Dunkirk: E. long.  $2^{\circ} 25'$ , and N. lat.  $51^{\circ} 10'$ .
- FUROR UTERINUS**, a disorder peculiar to women. See **MEDICINE**.
- FURR**, in commerce, signifies the skin of several wild beasts, dressed in alum with the hair on, and used as a part of dress by princes, magistrates, and others. The kinds most in use are, those of the ermine, sable, castor, hare, coney, &c.
- FURSTENBURGH**, a town and castle of Germany, the capital of a county of the same name, thirty miles north west of Constance: E. long.  $8^{\circ} 30'$ , and N. lat.  $47^{\circ} 50'$ .
- FURSTENFIELD**, a town of Austria and dutchy of Stiria, thirty-six miles east of Gratz: E. long.  $16^{\circ} 46'$ , N. lat.  $47^{\circ} 26'$ .
- FURTHCOMING**, in law, the name of an action competent to any person who has used arrestment in the hands of his debtor's creditor, for having the subject arrested declared his property. See **SCOTS LAW**, title 25.
- FURUNCLE**, or **BOIL**, in surgery, a small resisting tumour, with inflammation, redness, and great pain, arising in the adipose membrane, under the skin.
- FURZE**, in botany. See **ULEX**.
- FUSANUS**, in botany. See **EVONYMUS**.
- FUSAROLE**, in architecture, a moulding or ornament placed immediately under the echinus, in the Doric, Ionic, and Composite capitals.
- FUSEE**, in clock-work, is that conical part drawn by the spring, and about which the chain or string is wound; for the use of which, see **WATCH**.
- FUSEE**, or **FIRELOCK**. See **MUSQUET**.
- FUSIBILITY**, in natural philosophy, that quality of bodies which renders them fusible.
- FUSIL**, in heraldry, a bearing of a rhomboidal figure, longer than the lozenge, and having its upper and lower angles more acute and sharp than the other two in the middle. It is called in Latin *fusus*, a spindle, from its shape. See Plate LXXX. fig. 10.
- FUSILIERS**, or **FUSILERS**, in the military art, are foot-soldiers, armed with fuses, or firelocks.
- FUSION**, the melting of metals, minerals, &c. by means of fire. See **CHEMISTRY**.
- FUSTIAN**, in commerce, a kind of cotton stuff, which seems as it were whaled on one side.  
Right fustians should be altogether made of cotton-yarn, both woof and warp; but a great many are made, of which the warp is flax, or even hemp.  
There are fustians made of several kinds, wide, narrow, fine, coarse; with shag or nap, and without it.
- FUSTICK**, or **FUSTOCK**, a yellow wood, that grows in all the Caribbee islands, used in dyeing yellow. It pays no duty on importation.
- FUTTOCKS**, in a ship, the timbers raised over the keel, or the encompassing timbers that make her breadth.
- FUTURE**, in general, denotes whatever regards futurity, or the time to come.



## G

## G A B

## G A G

- GABARA**, or **GABBARA**, in antiquity, the dead bodies which the Egyptians embalmed, and kept in their houses, especially those of such of their friends as died with the reputation of great piety and holiness, or as martyrs. See **EMBALMING**, and **MUMMY**.
- GABEL**, according to the French duties or customs, a tax upon salt, which makes the second article in the king's revenue, and amounts to about one fourth part of the whole revenue of the kingdom.
- GABIN**, a town of great Poland, forty-six miles north-west of Warsaw: E. long.  $20^{\circ}$ , N. lat.  $52^{\circ} 35'$ .
- GABIONS**, in fortification, baskets made of osier-twigs, of a cylindrical form, six feet high, and four wide; which being filled with earth, serve as a shelter from the enemies fire.
- GABLOCKS**, the artificial spurs of game-cocks.
- GAD**, among miners, a small punch of iron, with a long wooden handle, used to break up the ore.  
One of the miners holds this in his hand, directing the point to a proper place, while the other drives it into the vein, by striking it with a sledge-hammer.
- GAD-FLY**. See **OESTRUS**.
- GADUS**, in ichthyology, a genus of fishes belonging to the order of jugulares. The head is smooth; there are

arc seven cylindrical rays in the branchiostege membrane; the body is oblong, with deciduous scales; the whole fins are covered with the common skin of the fish; the rays of the back-fins are blunt, and those of the breast are sharp. There are seventeen species, principally distinguished by their cirri, and the number of back-fins.

**GAGE**, in the sea-language. When one ship is to windward of another, she is said to have the weather-gage of her. They likewise call the number of feet that a vessel sinks in the water, the ship's gage: this they find by driving a nail into a pike near the end, and putting it down beside the rudder till the nail catch hold under it; then as many feet as the pike is under water, is the ship's gage.

**GAGE**, among letter-founders, a piece of box, or other hard wood, variously notched; the use of which is to adjust the dimensions, slopes, &c. of the different sorts of letters. See **FOUNDERY**.

**Sliding-GAGE**, a tool used by mathematical instrument-makers, for measuring and setting off distances.

**Sea GAGE**, an instrument invented by Dr Hales and Dr Desaguliers, for finding the depth of the sea, the description whereof is this. AB (Plate LXXXVI. fig. 1. N<sup>o</sup> 1.) is the gage bottle, in which is cemented the gage-tube *Ff* in the brass cap at G. The upper end of tube F is hermetically sealed, and the open lower end *f* is immersed in mercury, marked C, on which swims a small thickness or surface of treacle. On the top of the bottle is screwed a tube of brass HG, pierced with several holes, to admit the water into the bottle AB. The body K is a weight hanging by its shank L, in a socket N, with a notch on one side at *m*, in which is fixed the catch *l* of the spring S, and passing through the hole L, in the shank of the weight K, prevents its falling out when once hung on. On the top, in the upper part of the brass tube at H, is fixed a large empty ball, or full-blown bladder I, which must not be so large, but that the weight K may be able to sink the whole under water.

The instrument, thus constructed, is used in the following manner: The weight K being hung on, the gage is let fall into deep water, and sinks to the bottom; the socket N is somewhat longer than the shank L, and therefore, after the weight K comes to the bottom, the gage will continue to descend, till the lower part of the socket strikes against the weight; this gives liberty to the catch to fly out of the hole L, and let go the weight K; when this is done, the ball or bladder I, instantly buoys up the gage to the top of the water. While the gage is under water, the water having free access to the treacle and mercury in the bottle, will by its pressure force it up into the tube *Ff*, and the height to which it has been forced by the greatest pressure, *viz.* that at the bottom, will be shewn by the mark in the tube which the treacle leaves behind it, and which is the only use of the treacle. This shews into what space the whole air in the tube *Ff* is compressed; and consequently the height or depth of the water, which by its weight produced that compression, which is the thing required.

If the gage-tube *Ff* be of glass, a scale might be drawn on it with the point of a diamond, shewing, by inspection, what height the water stands above the bottom. But the length of 10 inches is not sufficient for fathoming depths at sea, since that, when all the air in such a length of tube is compressed into half an inch, the depth of water is no more than 634 feet, which is not half a quarter of a mile.

If, to remedy this, we make use of a tube fifty inches long, which for strength may be a musket barrel, and suppose the air compressed into an hundredth part of half an inch; then by saying, as 1 : 99 :: 400 : 39600 inches, or 3300 feet; even this is but little more than half a mile, or 2640 feet. But since it is reasonable to suppose the cavities of the sea bear some proportion to the mountainous parts of the land, some of which are more than three miles above the earth's surface; therefore, to explore such great depths, the Doctor contrived a new form for his sea gage, or rather for the gage-tube in it, as follows: BCD*F* (*ibid.* N<sup>o</sup> 2.) is a hollow metalline globe communicating on the top with a long tube AB, whose capacity is a ninth part of that globe. On the lower part at D, it has also a short tube DE, to stand in the mercury and treacle. The air contained in the compound gage-tube is compressed by the water as before; but the degree of compression, or height to which the treacle has been forced, cannot there be seen through the tube; therefore, to answer that end, a slender rod of metal or wood, with a knob on the top of the tube AB, will receive the mark of the treacle, and shew it, when taken out.

If the tube AB be 50 inches long, and of such a bore that every inch in length should be a cubic inch of air, and the contents of the globe and tube together 500 cubic inches; then, when the air is compressed within an hundredth part of the whole, it is evident the treacle will not approach nearer than 5 inches of the top of the tube, which will agree to the depth of 3300 feet of water as above. Twice this depth will compress the air into half that space nearly, *viz.* 2½ inches, which correspond to 6600 which is a mile and a quarter. Again, half that space, or 1¼ inch, will shew double the former depth, *viz.* 13200 feet, or 2¼ miles, which is probably very nearly the greatest depth of the sea.

**GAIETA**, a strong fortified town of the kingdom of Naples in Italy, thirty-five miles north-west of the city of Naples: E. long. 14° 30', and N. lat. 41° 20'.

**GAINSBOROUGH**, a market-town of Lincolnshire, fourteen milles north-west of Lincoln; which gives the title of earl to the noble family of Noel.

**GAIOPHRAGMIA**, in natural history, a genus of septariæ, divided by septæ or partitions of earthy matter, of which there are several species. See **SEPTARIA**.

**GALACTITES**, in natural history, the name by which the ancients called a smooth, ash-coloured, indurated kind of clay, said to have been used with success for obstructions and ulcers of the eyes, and as an astringent.

**GALANGALS**, in the materia medica, the name of a root

root kept in the shops, but now mostly out of use in practice.

**GALANTHUS**, the *SNOW-DROP*, in botany, a genus of the hexandria monogynia class. It has three concave petals, a simple stigma, and a nectarium composed of three small petals. There is but one species, a native of Germany.

**GALATA**, a great suburb belonging to Constantinople, opposite to the seraglio, on the other side of the harbour. It is here the Greeks, Armenians, Franks, Christians, and Jews inhabit, and are allowed the exercise of their respective worships.

**GALATIA**, the ancient name of Amasia, a province of Lesser Asia.

**GALAX**, in botany, a genus of the pentandria monogynia class. The calix consists of ten leaves; and the capsule has one cell and two elastic valves. There is but one species, a native of Virginia.

**GALAXY**, in astronomy. See *ASTRONOMY*, p. 487.

**GALBANUM**, in pharmacy, a gum issuing from the stem of an umbelliferous plant, growing in Persia and many parts of Africa.

It is sometimes met with in the shops in loose granules, called drops or tears; and sometimes in large masses, formed of a number of these blended together; but in these masses some accidental foulness is often mixed with the gum. The single drops usually approach to a roundish, oblong, pear-like form. Galbanum is soft like wax, and, when fresh drawn, white; but it afterwards becomes yellowish or reddish: it is of a strong smell, of an acrid and bitterish taste; it is inflammable in the manner of a resin, and soluble in water like a gum.

It attenuates and dissolves tough phlegm, and is therefore of service in asthmas and inveterate coughs.

**GALEGA**, in botany, a genus of the diadelphia decandria class. The calix consists of equal tubulated teeth; and the pod has oblique striæ, with a seed between each. There are eight species, none of them natives of Britain.

**GALENISTS**, in church-history, a branch of anabaptists, who are said to have adopted several Arian opinions concerning the divinity of our Saviour.

**GALEODOLON**, in botany. See *LEONURUS*.

**GALERITA**, in ichthyology, a species of blennius. See *BLENNIUS*.

**GALICIA**, the most north-west province of Spain, bounded by the ocean on the north-west, by the provinces of Asturias and Leon on the east, and by Portugal on the south.

**GALICIA**, or *GUADALAJARA*, a province of Mexico, bounded by new Mexico on the north, by the gulph of Mexico on the east, by Mexico Proper on the south, and by the Pacific Ocean and gulph of California on the west.

**GALILE**, or *GALILEE*, once a province of Judea, now of Turkey in Asia, was bounded by mount Lebanon on the north, by the river Jordan and the sea of Galilee on the east, by the river Chison on the south, and by the Mediterranean on the west. It was the scene of many of our Saviour's miracles.

Vol. II. No. 53.

**GALILEANS**, a sect of the Jews. Their founder was one Judas, a native of Galilee, from which place they derived their name. Their chief, esteeming it an indignity for the Jews to pay tribute to strangers, raised up his countrymen against the edict of the emperor Augustus, which had ordered a taxation or inrollment of all the subjects of the Roman empire.

They pretended that God alone should be owned as Master and Lord; and in other respects were of the opinion of the Pharisees; but, as they judged it unlawful to pray for infidel princes, they separated themselves from the rest of the Jews, and performed their sacrifices apart.

**GALL**, in the animal œconomy. See *BILE*.

**GALL BLADDER**. See *ANATOMY*, p. 269.

**GALL**, in natural history, denotes any protuberance or tumour produced by the puncture of insects on plants and trees of different kinds.

These galls are of various forms and sizes, and no less different with regard to their internal structure. Some have only one cavity, and others a number of small cells communicating with each other. Some of them are as hard as the wood of the tree they grow on, whilst others are soft and spongy; the first being termed gall-nuts, and the latter berry-galls, or apple-galls.

The general history of galls is this: an insect of the fly kind is instructed by nature to take care for the safety of her young, by lodging her eggs in a woody substance, where they will be defended from all injuries: she for this purpose wounds the leaves or tender branches of a tree; and the lacerated vessels, discharging their contents, soon form tumours about the holes thus made. The hole in each of these tumours, through which the fly has made its way, may for the most part be found; and when it is not, the maggot inhabitant or its remains are sure to be found within, on breaking the gall. However, it is to be observed, that in those galls which contain several cells, there may be insects found in some of them, though there be a hole by which the inhabitant of another cell has escaped.

Oak galls put, in a very small quantity, into a solution of vitriol in water, though but a very weak one, give it a purple or violet colour; which, as it grows stronger, becomes black; and on this property depends the art of making our writing ink, as also a great deal of those of dying and dressing leather, and other manufactures.

In medicine, galls are found to be very astringent, and good, under proper management, in diarrhœas, dysenteries, and hæmorrhages of all kinds; they have also a very eminent virtue as a febrifuge.

**GALLERY**, in architecture, a covered place in a house, much longer than broad, and usually in the wings of a building; its use being chiefly to walk in.

**GALLERY**, in fortification, a covered walk across the ditch of a town, made of strong beams, covered over head with planks, and loaded with earth: sometimes it is covered with raw hides to defend it from the artificial fires of the besieged.

**GALLERY of a mine**, is a narrow passage, or branch of

a mine carried on under ground to a work designed to be blown up.

**GALLERY**, in a ship, that beautiful frame, which is made in the form of a balcony, at the stern of a ship without board; into which there is a passage out of the admiral's or captain's cabin, and is for the ornament of the ship.

**GALLEY**, in naval affairs, a low-built vessel, using both sails and oars, and commonly carrying only a main-mast and fore mast, which may be struck or lowered at pleasure. Such vessels are much used in the Mediterranean, especially by the king of France. See **SHIP**.

**GALLI**, in antiquity, the priests of the goddess Cybele, who were eunuchs, and took their name from Gallus, a river in Phrygia.

When a youth was to be initiated into this order, the custom was to throw off his cloaths, to run crying aloud into the midst of the troop, and then drawing a sword to castrate himself; after this, he ran about the streets, carrying in his hands the marks of his mutilation, which he was to throw into a house, and in that house to put on a woman's dress.

**GALLICIAN**, any thing belonging to France: thus the term Gallician church denotes the church of France, or the assembly of the clergy of that kingdom.

**GALLICISM**, a mode of speech peculiar to the French language, and contrary to the rules of grammar in other languages.

**GALLINÆ**, in ornithology, an order of birds. See **NATURAL HISTORY**.

**GALLINACIOUS**, an appellation given to the birds of the order of the gallinæ.

**GALLINULA**, in ornithology. See **SCOLOPAX**.

**GALLION**, or **GALLEON**, in naval affairs, a sort of ships employed in the commerce of the West Indies. The Spaniards send annually two fleets; the one for Mexico, which they call the flota, and the other for Peru, which they call the gallions. See **FLOTA**.

**GALLIOT**, a small galley designed only for chace, carrying only one mast, and two or three patereroes; it can both sail and row, and has sixteen or twenty oars. All the seamen on board are soldiers, and each has a musket by him on quitting his oar.

**GALLIPAGO-ISLANDS**, are situated in the Pacific Ocean on both sides the equator, between 85° and 90° W. long. and about four hundred miles west of Peru.

**GALLIPOLI**, a port town of European Turkey, situated at the entrance of the Propontis, or Sea of Marmora, about 100 miles south-west of Constantinople: E. long. 28°, and N. lat. 40° 45'.

**GALLIPOLI** is also a port town of the kingdom of Naples, situated on the gulph of Otranto, about twenty-three miles west of that city: E. long. 19°, and N. lat. 40° 25'.

**GALLIUM, LADIES-BEDSTRAW**, in botany, a genus of the tetrandria monogynia class. The corolla consists of one plane petal; and the seeds are two, and round. There are 23 species, 11 of them natives of Britain. *viz.* the verum, or yellow ladies-bedstraw; the mollugo, or wild madder; the montanum, or mountain ladies-bedstraw; the uliginosum, or marsh goose-

grafs; the erectum, or small mountain bastard madder; the puillum, or least ladies-bedstraw; the palustre, or white ladies-bedstraw; the spurium, or goose-grafs with smoother seeds; the aparine, cleavers, or goose-grafs; the parisiense, or least goose-grafs; and the boreale, or crosswood madder.

**GALLO**, an island on the Pacific Ocean near the coast of Peru, about 200 miles west of Popayan: W. long. 80°, and N. lat. 2° 15'.

**GALLO** is also a town of Italy, ten miles south of Ancona.

**GALLO**, or **PUNTO GALLO**, a sea-port of Ceylon, subject to the Dutch: E. long. 78°, and N. lat. 6°.

**GALLON**, a measure of capacity both for dry and liquid things, containing four quarts; but these quarts, and consequently the gallon itself, are different, according to the quality of the thing measured: for instance, the wine gallon contains 231 cubic inches, and holds eight pounds averdupois, of pure water: the beer and ale gallon contains 282 solid inches, and holds ten pounds three ounces and a quarter averdupois, of water: and the gallon for corn, meal, &c. 272½ cubic inches, and holds nine pounds thirteen ounces of pure water.

**GALLOPAVO**, in zoology. See **MELEAGRIS**.

**GALLOWAY**, a county of Scotland, which gives the title of earl to a branch of the noble family of Stuart.

It is divided into two districts; the western, called Upper Galloway, being the same with Wigtonshire; and the eastern, or stewartry of Kirkudbright, called Lower Galloway.

**GALLOWAY** is also the capital of a county of the same name, in the province of Connaught, in Ireland: W. long. 9° 12', and N. lat. 53° 12'.

It has a good port, and is advantageously situated for foreign trade.

**GALLUS**, in ornithology. See **PHASIANUS**.

**GALLY**, in printing, a frame into which the compositor empties the lines out of his composing stick, and in which he ties up the page when it is completed.

The gally is formed of an oblong square board, with a ledge on three sides, and a groove to admit a false bottom, called a gally-slice.

**GAMBIA**, a great river of Africa, which, running from east to west falls into the Atlantic ocean, 14° N. lat. and 15° W. lon.

**GAMBOGE**, is a concreted vegetable juice, the produce of two trees, both called by the Indians caracapulli, and is partly of a gummy, and partly of a resinous nature. It is brought to us either in form of orbicular masses, or of cylindrical rolls of various sizes; and is of a dense, compact, and firm texture, and of a beautiful yellow. It is chiefly brought to us from Cambaja, in the East Indies, called also Cambodja, and Cambogia; and from thence it has obtained its names of cambadium, cambogium, and gambogium.

It is a very rough and strong purge; it operates both by vomit and stool, and both ways with much violence, almost in the instant in which it is swallowed; but yet without griping. It requires caution and judgment in administering it; but those who know how to give it properly,



properly, find it an excellent remedy in dropsies, cachexies, jaundice, althmas, catarrhs, and in the worst cutaneous eruptions.

**GAME**, in general, signifies any diversion, or sport, that is performed with regularity, and restrained to certain rules. See **GAMING**.

**GAMES**, in antiquity, were public diversions, exhibited on solemn occasions. Such, among the Greeks, were the Olympic, Pythian, Isthmian, Nemean, &c. games; and, among the Romans, the Apollinarian, Circensian, Capitoline, &c. games. See **OLYMPIC**, **PYTHIAN**, &c.

**GAME**, in law, signifies birds or prey, taken or killed by fowling, or hunting. There are several statutes for punishing offences committed by persons not qualified by law to take or destroy the game.

**GAME-COCK**, a fighting cock, or one kept for sport; a barbarous practice, which is a disgrace to any civilized nation.

**GAMELIA**, in Grecian antiquity, a nuptial feast, or rather sacrifice, held in the ancient Greek families on the day before a marriage; thus called, from a custom they had of shaving themselves on this occasion, and presenting their hair to some deity to whom they had particular obligations.

**GAMELION**, in the ancient chronology, was the eighth month of the Athenian year, containing twenty-nine days, and answering to the latter part of our January and beginning of February. It was thus called, as being, in the opinion of the Athenians, the most proper season of the year for marriage.

**GAMING**, the art of playing or practising any game, particularly those of hazard, as cards, dice, tables, &c.

Mr de Moivre, in a treatise de Mensura Sortis, has computed the variety of chances in several cases that occur in gaming, the laws of which may be understood by what follows.

Suppose  $p$  the number of cases in which an event may happen, and  $q$  the number of cases wherein it may not happen, both sides have the degree of probability, which is to each other as  $p$  to  $q$ .

If two gamesters, A and B, engage on this footing, that, if the cases  $p$  happen, A shall win; but if  $q$  happen, B shall win, and the stake be  $a$ ; the chance of

A will be  $\frac{p a}{p+q}$ , and that of B  $\frac{q a}{p+q}$ ; consequently, if

they sell the expectancies, they should have that for them respectively.

If A and B play with a single die, on this condition, that, if A throw two or more aces at eight throws, he shall win; otherwise B shall win; what is the ratio of their chances? Since there is but one case wherein an ace may turn up, and five wherein it may not, let  $a=1$ , and  $b=5$ . And, again, since there are eight throws of the die, let  $n=8$ ; and you will have  $a^n + b^n - nab^n - 1$ , to  $b^n + nab^n - 1$ : that is, the chance of A will be to that of B, as 663991 to 10156525, or nearly as 2 to 3.

A and B are engaged at single quoits; and, after playing some time, A wants 4 of being up, and B 6;

but B is so much the better gamester, that his chance against A upon a single throw would be as 3 to 2; what is the ratio of their chances? Since A wants 4, and B 6, the game will be ended at nine throws; therefore, raise  $a+b$  to the ninth power, and it will be  $a^9 + 9a^8b + 36a^7bb + 84a^6b^3 + 126a^5b^4 + 126a^4b^5$ , to  $84a^3b^6 + 36aab^7 + 6ab^8 + b^9$ : call  $a$  3, and  $b$  2, and you will have the ratio of chances in numbers, viz. 1759077 to 194048.

A and B play at single quoits, and A is the best gamester, so that he can give B 2 in 3, what is the ratio of their chances at a single throw? Suppose the chances as  $z$  to 1, and raise  $z+1$  to its cube, which will be  $z^3 + 3z^2 + 3z + 1$ . Now since A could give B 2 out of 3, A might undertake to win three throws running; and, consequently, the chances in this case will be as  $z^3$  to  $3z^2 + 3z + 1$ . Hence  $z^3 = 3z^2 + 3z + 1$ ; or,  $2z^3 = z^3 + 3z^2 - 3z + 1$ . And, therefore,  $z^{\frac{1}{2}} =$

$z + 1$ ; and, consequently,  $z = \frac{1}{\sqrt{2}-1}$ . The chances,

therefore, are  $\frac{1}{\sqrt{2}-1}$ , and 1, respectively.

Again, suppose I have two wagers depending, in the first of which I have 3 to 2 the best of the lay, and in the second 7 to 4, what is the probability I win both wagers?

1. The probability of winning the first is  $\frac{3}{5}$ , that is the number of chances I have to win, divided by the number of all the chances: the probability of winning the second is  $\frac{7}{11}$ : therefore, multiplying these two fractions together, the product will be  $\frac{21}{55}$ , which is the probability of winning both wagers. Now, this fraction being subtracted from 1, the remainder is  $\frac{34}{55}$ , which is the probability I do not win both wagers: therefore the odds against me are 34 to 21.

2. If I would know what the probability is of winning the first, and losing the second, I argue thus: the probability of winning the first is  $\frac{3}{5}$ , the probability of losing the second is  $\frac{4}{11}$ : therefore multiplying  $\frac{3}{5}$  by  $\frac{4}{11}$ , the product  $\frac{12}{55}$  will be the probability of my winning the first, and losing the second; which being subtracted from 1, there will remain  $\frac{43}{55}$ , which is the probability I do not win the first, and at the same time lose the second.

3. If I would know what the probability is of winning the second, and at the same time losing the first, I say thus: the probability of winning the second is  $\frac{7}{11}$ ; the probability of losing the first is  $\frac{2}{5}$ : therefore, multiplying these two fractions together, the product  $\frac{14}{55}$  is the probability I win the second, and also lose the first.

4. If I would know what the probability is of losing both wagers, I say, the probability of losing the first is  $\frac{2}{5}$ , and the probability of losing the second  $\frac{4}{11}$ : therefore, the probability of losing them both is  $\frac{8}{55}$ ; which being subtracted from 1, there remains  $\frac{47}{55}$ : therefore, the odds of losing both wagers is 47 to 8.

This way of reasoning is applicable to the happening or failing of any events that may fall under consideration.

deration. Thus if I would know what the probability is of missing an ace four times together with a die, this I consider as the failing of four different events. Now the probability of missing the first is  $\frac{5}{6}$ , the second is also  $\frac{5}{6}$ , the third  $\frac{5}{6}$ , and the fourth  $\frac{5}{6}$ ; therefore the probability of missing it four times together is  $\frac{5}{6} \times \frac{5}{6} \times \frac{5}{6} \times \frac{5}{6} = \frac{625}{1296}$ ; which being subtracted from 1, there will remain  $\frac{671}{1296}$  for the probability of throwing it once or oftener in four times: therefore the odds of throwing an ace in four times, is 671 to 625.

But if the flinging of an ace was undertaken in three times, the probability of missing it three times would be  $\frac{5}{6} \times \frac{5}{6} \times \frac{5}{6} = \frac{125}{216}$ ; which being subtracted from 1, there will remain  $\frac{91}{216}$  for the probability of throwing it once or oftener in three times: therefore the odds against throwing it in three times are 125 to 91. Again, suppose we would know the probability of throwing an ace once in four times, and no more: since the probability of throwing it the first time is  $\frac{1}{6}$ , and of missing it the other three times is  $\frac{5}{6} \times \frac{5}{6} \times \frac{5}{6}$ , it follows that the probability of throwing it the first time, and missing it the other three successive times, is  $\frac{1}{6} \times \frac{5}{6} \times \frac{5}{6} \times \frac{5}{6} = \frac{125}{1296}$ ; but because it is possible to hit it every throw as well as the first, it follows, that the probability of throwing it once in four throws, and missing the other three, is  $\frac{4 \times 125}{1296} = \frac{500}{1296}$ ; which being subtracted from 1, there will remain  $\frac{796}{1296}$  for the probability of throwing it once, and no more, in four times. Therefore, if one undertake to throw an ace once, and no more, in four times, he has 500 to 796 the worst of the lay, or 5 to 8 very near.

Suppose two events are such, that one of them has twice as many chances to come up as the other, what is the probability that the event, which has the greater number of chances to come up, does not happen twice before the other happens once, which is the case of flinging 7 with two dice before 4 once? Since the number of chances are as 2 to 1, the probability of the first happening before the second is  $\frac{2}{3}$ , but the probability of its happening twice before it is but  $\frac{2}{3} \times \frac{2}{3}$  or  $\frac{4}{9}$ : therefore it is 5 to 4 seven does not come up twice before four once.

But, if it were demanded, what must be the proportion of the facilities of the coming up of two events, to make that which has the most chances come up twice, before the other comes up once? The answer is 12 to 5 very nearly: whence it follows, that the probability of throwing the first before the second is  $\frac{7}{12}$ , and the probability of throwing it twice is  $\frac{7}{12} \times \frac{7}{12}$ , or  $\frac{49}{144}$ ; therefore, the probability of not doing it is  $\frac{95}{144}$ : therefore the odds against it are as 145 to 144, which comes very near an equality.

Suppose there is a heap of thirteen cards of one colour, and another heap of thirteen cards of another colour, what is the probability that, taking one card at a venture out of each heap, I shall take out the two aces?

The probability of taking the ace out of the first heap is  $\frac{1}{13}$ , the probability of taking the ace out of the

second heap is  $\frac{1}{13}$ ; therefore the probability of taking out both aces is  $\frac{1}{13} \times \frac{1}{13} = \frac{1}{169}$ , which being subtracted from 1, there will remain  $\frac{168}{169}$ : therefore the odds against me are 168 to 1.

In cases where the events depend on one another, the manner of arguing is somewhat altered. Thus, suppose that out of one single heap, of thirteen cards of one colour I should undertake to take out first the ace; and, secondly, the two: though the probability of taking out the ace be  $\frac{1}{13}$ , and the probability of taking out the two be likewise  $\frac{1}{13}$ ; yet, the ace being supposed as taken out already, there will remain only twelve cards in the heap, which will make the probability of taking out the two to be  $\frac{1}{12}$ : therefore the probability of taking out the ace, and then the two, will be  $\frac{1}{13} \times \frac{1}{12}$ .

In this last question the two events have a dependence on each other, which consists in this, that one of the events being supposed as having happened, the probability of the other's happening is thereby altered. But the case is not so in the two heaps of cards.

If the events in question be  $n$  in number, and be such as have the same number  $a$  of chances by which they may happen, and likewise the same number  $b$  of chances by which they may fail, raise  $a+b$  to the power  $n$ . And if A and B play together, on condition that if either one or more of the events in question happen, A shall win, and B lose, the probability of A's winning will be  $\frac{a+b)^n - b^n}{a+b)^n}$ ; and that of B's

winning will be  $\frac{b^n}{a+b)^n}$ ; for when  $a+b$  is actually

raised to the power  $n$ , the only term in which  $a$  does not occur is the last  $b^n$ : therefore all the terms but the last are favourable to A.

Thus if  $n=3$ , raising  $a+b$  to the cube  $a^3+3a^2b+3ab^2+b^3$ , all the terms but  $b^3$  will be favourable to A; and therefore the probability of A's winning will be  $\frac{a^3+3a^2b+3ab^2}{a+b)^3}$ , or  $\frac{a+b)^3 - b^3}{a+b)^3}$ ; and the proba-

bility of B's winning will be  $\frac{b^3}{a+b)^3}$ . But if A and B

play on condition, that if either two or more of the events in question happen, A shall win; but in case one only happen, or none, B shall win; the probability of A's winning will be  $\frac{a+b)^n - nab^{n-1} - b^n}{n+b)^n}$ ; for

the only two terms in which  $aa$  does not occur, are the two last, viz.  $nab^{n-1}$  and  $b^n$ .

GAMMUT, in music, a scale whereon we learn to found the musical notes, *ut, re, mi, fa, sol, la*, in their several orders and dispositions. See MUSIC.

GANG-WAY is the several passages or ways from one part of the ship to the other; and whatever is laid in any of those passages, is said to lie in the gang-way.

GANGEA, the capital of a territory in the province of Chirvan, in Persia: E. long. 46°, N. lat. 41°.

GANGES,

**GANGES**, a large river of the hither India, rises in the mountains which separate India from Tartary; and, running from the north west to the south east near 1500 miles through the Mogul's dominions, discharges itself by several channels into the bay of Bengal.

**GANGI**, or **COULER**, a town of Golconda, in the hither India: E. long. 79°, and N. lat. 16°.

**GANGLIO**, or **GANGLION**, in surgery, a hard tubercle, generally moveable, in the external or internal part of the carpus, upon the tendons or ligaments in that part, usually without any pain to the patient.

**GANGRENE**, a very great and dangerous degree of inflammation, wherein the parts affected begin to corrupt, and put on a state of putrefaction. See **MEDICINE** and **SURGERY**.

**GANTLET**, or **GAUNTLET**, a large kind of glove, made of iron, and the figures covered with small plates. It was formerly worn by cavaliers, when armed at all points.

**GAOL**, a prison, or place of legal confinement.

**GAOL DELIVERY**, is where a commission or patent is granted by the king in the nature of a letter, to certain persons, who are thereby appointed his justices, or to two or three of them, authorising them to deliver

his gaol, at such a place, of the prisoners contained therein; and for that end it commands them to meet at such a place, at the time they themselves shall appoint, when the sheriff of the county is commanded to bring all the prisoners in the gaol before them, &c.

**GAP**, a city and bishop's see of Dauphine, in France, eighteen miles west of Embrun: E. long. 5° 46', N. lat. 44° 32'.

**GARBE**, in heraldry, a sheaf of any kind of grain, bore in several coats of arms, and said to represent summer, as a bunch of grapes does autumn.

**GARCINIA**, in botany, a genus of the icofandria monogynia class. The flower consists of four roundish patent petals; and the fruit is a large unilocular coriaceous berry, containing eight hairy and fleshy seeds, convex on one side, and angular on the other. There are two species, none of them natives of Britain.

**GARDA**, a town of the Veronese, in Italy, subject to Venice: E. long. 11°, N. lat. 45° 25'.

**GARDANT**, or **GUARDANT**, in heraldry, denotes any beast full faced, and looking right forward. See Plate LXXXVII. fig. 6. which represents a lion gardant.

**GARDELEBEN**, a town of Bradenburg, in Germany: E. long. 11° 45'; N. lat. 52° 40'.

## G A R D E N I N G.

**GARDENING**, a branch of agriculture, containing the cultivation of gardens.

The simplest idea of a garden, is that of a spot embellished with a number of natural objects, trees, walks, polished parterres, flowers, streams, &c. One more complex comprehends statues and buildings, that nature and art may be mutually ornamental. A third approaching nearer perfection, is of objects assembled together, in order to produce, not only an emotion of beauty, essential to every garden, but also some other particular emotion, grandeur for example, or gaiety. The most perfect idea of a garden is an improvement upon the third, requiring the several parts to be arranged in such a manner, as to inspire all the different emotions that can be raised by gardening. In this idea of a garden, the arrangement is an important circumstance; for some emotions figure best in conjunction, and others ought always to appear in succession and never in conjunction. When the most opposite emotions, such as gloominess and gaiety, stillness and activity, follow each other in succession, the pleasure on the whole will be the greatest; but such emotions ought not to be united, because they produce an unpleasant mixture. For that reason, a ruin, affording a sort of melancholy pleasure, ought not to be seen from a flower-parterre, which is gay and cheerful: but to pass from an exhilarating object to a ruin, has a fine effect; for each of the emotions is the more sensibly felt by being contrasted with the other. Similar emotions, on the other hand, such as gaiety and sweetness, stillness

and gloominess, motion and grandeur, ought to be raised together; for their effects upon the mind are greatly heightened by their conjunction.

Kent's method of embellishing a field, is admirable; which is, to paint a field with beautiful objects, natural and artificial, disposed like colours upon a canvas. It requires indeed more genius to paint in the gardening way: in forming a landscape upon a canvas, no more is required but to adjust the figures to each other: an artist who lays out ground in Kent's manner, has an additional task; he ought to adjust his figures to the several varieties of the field.

One garden must be distinguished from a plurality; and yet it is not obvious wherein the unity of a garden consists. A notion of unity is indeed suggested from viewing a garden surrounding a palace, with views from each window, and walks leading to every corner: but there may be a garden without a house; in which case, what makes it one garden, is the unity of design, every single spot appearing part of a whole. The gardens of Versailles, properly expressed in the plural number, being no fewer than sixteen, are indeed all of them connected with the palace, but have scarce any mutual connection: they appear not like parts of one whole, but rather like small gardens in contiguity. Were these gardens at some distance from each other, they would have a better effect: their junction breeds confusion of ideas, and upon the whole gives less pleasure than would be felt in a slower succession.

Regularity is required in that part of a garden which joins the dwelling-house; for being considered as a more immediate accessory, it ought to partake the regularity of the principal object: but in proportion to the distance from the house considered as the centre, regularity ought less and less to be studied; for, in an extensive plan, it hath a fine effect to lead the mind insensibly from regularity to a bold variety. Such arrangement tends to make an impression of grandeur: and grandeur ought to be studied as much as possible, even in a more confined plan, by avoiding a multiplicity of small parts. A small garden, on the other hand, which admits not grandeur, ought to be strictly regular.

Milton, describing the garden of Eden, prefers justly the grand taste to that of regularity:

Flow'rs worthy of paradise, which not nice art  
In beds and curious knots; but Nature boon  
Pour'd forth profuse on hill, and dale, and plain;  
Both where the morning-sun first warmly smote  
The open field, and where the unpierc'd shade  
Imbrown'd the noontide bow'rs. *Paradise Lost, b. 4.*

An hill, by being covered with trees, appears both more powerful and more lofty; provided no other beauties be hid that might be seen if the hill were naked. To distribute trees in a plain requires more art: near the dwelling-house they ought to be so thin, as not to break the unity of the field; and even at the greatest distance of distinct vision, they ought never to be so crowded as to hide any beautiful object.

In the manner of planting a wood or thicket, much art may be displayed. A common centre of walks, termed *a star*, from whence are seen a number of remarkable objects, appears too artificial, and consequently too stiff and formal, to be agreeable: the crowding withal so many objects together, lessens the pleasure that would be felt in a slower succession. Abandoning therefore the star, let us try to substitute some form more natural, that will lay open all the remarkable objects in the neighbourhood. This may be done by various openings in the wood contrived to catch surrounding objects, which in walking bring successively under the eye these objects as by accident; sometimes a single object, sometimes a plurality in a line, and sometimes a rapid succession of them. In this form, the mind at intervals is roused and cheered by agreeable objects; and the scene is greatly heightened by the surprise it occasions when we stumble, as it were, upon objects of which we had no expectation.

An object terminating in a narrow opening in a wood, appears at a double distance. This suggests another rule for distributing trees in some quarter near the dwelling-house; which is, to place a number of thickets one behind another, with an opening in each directing the eye to the most distant through all the intermediate thickets; which, by making these thickets appear more distant from each other than they are in reality, will enlarge in appearance the size of the whole field. To give this plan its utmost effect, the thickets ought to be at a considerable distance from each other: and, in order that each may be seen distinctly, the opening nearest the eye ought to be wider than the second, the second wider than the third, and so one to the end.

By a judicious distribution of trees, various beauties may be produced, far exceeding what have been mentioned; which will appear as follows. A landscape so rich as to ingross the whole attention, and so limited as sweetly to be comprehended under a single view, has a much finer effect than the most extensive landscape that requires a wandering of the eye through successive scenes. This consideration suggests a capital rule in laying out a field; which is, never at any one station to admit a larger prospect than can easily be taken in at once. A field so happily situated as to command a great extent of prospect, is a delightful subject for applying this rule: let the prospect be split into proper parts by means of trees; studying at the same time to introduce all the variety possible. A plan of this kind executed with taste will produce charming effects: the beautiful prospects are multiplied: each of them is much more agreeable than the entire prospect was originally: and, to crown the whole, the scenery is greatly diversified.

As gardening is not an inventive art, but an imitation of nature, or rather nature itself ornamented, it follows necessarily, that every thing unnatural ought to be rejected with disdain. Statues of wild beasts vomiting water, a common ornament in gardens, prevails in those of Versailles. Is this ornament in a good taste? A jet d'eau, being partly artificial, may, without disgust, be tortured into a thousand shapes: but a representation of what really exists in nature, admits not any unnatural circumstance. These statues therefore of Versailles must be condemned; and yet so insensible has the artist been to just imitation, as to have displayed his vicious taste without the least colour or disguise: a lifeless statue of an animal pouring out water, may be endured without much disgust; but here the lions and wolves are put in violent action, each has seized its prey, a deer or a lamb, in act to devour; and yet, instead of extended claws and open mouth, the whole, as by a hocus-pocus trick, is converted into a different scene; the lion, forgetting his prey, pours out water plentifully; and the deer, forgetting its danger, performs the same operation.

In gardening, every lively exhibition of what is beautiful in nature has a fine effect: on the other hand, distant and faint imitations are displeasing to every one of taste. The cutting evergreens in the shape of animals, is a very ancient practice; as appears from the epistles of Pliny, who seems to be a great admirer of this puerile conceit. The propensity to imitation gave birth to this practice; and has supported it wonderfully long, considering how faint and insipid the imitation is. But the vulgar, great and small, devoid of taste, are entertained with the oddness and singularity of a resemblance, however distant, between a tree and an animal. An attempt in the gardens of Versailles, to imitate a grove of trees by a group of jets d'eau, appears, for the same reason, not less ridiculous.

In laying out a garden, every thing trivial or whimsical ought to be avoided. Is a labyrinth then to be justified? It is a mere conceit, like that of composing verses in the shape of an ax or an egg: the walks and hedges may be agreeable; but in the form of a labyrinth, they serve to no end but to puzzle: a riddle is a conceit not so mean; because

Because the solution is a proof of sagacity, which affords no aid in tracing a labyrinth.

The gardens of Versailles, executed with infinite expense by the best artists that could be found, are a lasting monument of a taste the most depraved: the faults above mentioned, instead of being avoided, are chosen as beauties, and multiplied without end. Nature, it would seem, was deemed too vulgar to be imitated in the works of a magnificent monarch; and for that reason preference was given to things unnatural, which probably were mistaken for supernatural.

A straight road is the most agreeable, because it shortens the journey. But in an embellished field, a straight walk has an air of stiffness and confinement: and at any rate is less agreeable than a winding or waving walk; for in surveying the beauties of an ornamented field, we love to roam from place to place at freedom. Winding walks have another advantage: at every step they open new views. In short, the walks in a field intended to please the eye, ought not to have any appearance of a road. This rule excludes not long straight openings terminating upon distant objects; which openings, beside variety, never fail to raise an emotion of grandeur, by extending in appearance the size of the field: an opening without a terminating object, soon closes upon the eye; but an object, at whatever distance, continues the opening, and deludes the spectator into a conviction, that the trees which confine the view are continued till they join the object: and the object also, as observed above, seems to be at a greater distance than it is in reality. Straight walks also in recesses do extremely well: they vary the scenery, and are favourable to meditation.

An avenue ought not to be directed in a straight line upon a dwelling-house: better far an oblique approach in a waving line, with single trees and other scattered objects interposed. In a direct approach, the first appearance continues the same to the end: we see a house at a distance, and we see it all along in the same spot without any variety. In an oblique approach, the interposed objects put the house seemingly in motion: it moves with the passenger, and appears to direct its course so as hospitably to intercept him. An oblique approach contributes also to variety: the house, being seen successively in different directions, takes on at every step a new figure.

A garden on a flat ought to be highly and variously ornamented, in order to occupy the mind, and prevent its regretting the insipidity of an uniform plan. Artificial mounts in this view are common: but no person has thought of an artificial walk elevated high above the plain. Such a walk is airy, and tends to elevate the mind: it extends and varies the prospect: and it makes the plain, seen from a height, appear more agreeable.

Whether should a ruin be in the Gothic or Grecian form? In the former; because it exhibits the triumph of time over strength, a melancholy but not unpleasant thought: a Grecian ruin suggests rather the triumph of barbarity over taste, a gloomy and discouraging thought.

Fountains are seldom in a good taste. Statues of animals vomiting water, which prevail every where, stand condemned. A statue of a whale spouting water upward

from its head, is in one sense natural, as whales of a certain species have that power; but it is sufficient to make this design be rejected, that its singularity would make it appear unnatural: there is another reason against it, that the figure of a whale is in itself not agreeable. In the many fountains in and about Rome, statues of fishes are frequently employed to support a large basin of water. This unnatural conceit is not accountable, unless from the connection between water and the fish that swim in it; which, by the way, shows the influence of even the slightest relations.

Hitherto a garden has been treated as a work intended solely for pleasure; or, in other words, for giving impressions of intrinsic beauty. What comes next in order is the beauty of a garden declined for use, termed *relative beauty*; see BEAUTY: and this branch shall be dispatched in a few words. In gardening, luckily, relative beauty need never stand in opposition to intrinsic beauty: all the ground that can be requisite for use, makes but a small proportion of an ornamented field; and may be put in any corner without obstructing the disposition of the capital parts. At the same time, a kitchen-garden, or an orchard, is susceptible of intrinsic beauty; and may be so artfully disposed among the other parts, as by variety and contrast to contribute to the beauty of the whole.

Gardening being in China brought to greater perfection than in any other known country, we shall take a slight view of Chinese gardens, which will be found entirely obsequious to the principles that govern any one of the fine arts. In general, it is an indispensable law there, never to deviate from nature; but in order to produce that degree of variety which is pleasing, every method is used that is consistent with nature. Nature is strictly imitated in the banks of their artificial lakes and rivers; which sometimes are bare and gravelly, sometimes covered with wood quite to the brink of the water. To flat spots adorned with flowers and shrubs are opposed others steep and rocky. We see meadows covered with cattle; rice grounds that run into lakes; groves into which enter navigable creeks and rivulets: these generally conduct to some interesting object, a magnificent building, terraces cut in a mountain, a cascade, a grotto, an artificial rock, or such like. Their artificial rivers are generally serpentine; sometimes narrow, noisy, and rapid; sometimes deep, broad, and slow: and to make the scene still more active, mills and other moving machines are often erected. In the lakes are interspersed islands; some barren, surrounded with rocks and shoals; others enriched with every thing that art and nature can furnish. Even in their cascades they avoid regularity, as forcing nature out of its course: the waters are seen bursting from the caverns and windings of the artificial rocks, here an impetuous cataract, there many lesser falls: and the stream often impeded by trees and stones, that seem brought down by the violence of the current. Straight lines are sometimes indulged, in order to take the advantage of some interesting object at a distance, by directing openings upon it.

Sensible of the influence of contrast, the Chinese artists deal in sudden transitions, and in opposing to each other, forms, colours, and shades. The eye is conducted from

from limited to extensive views, and from lakes and rivers to plains, hills, and woods: to dark and gloomy colours, are opposed the more brilliant: the different masses of light and shade are disposed in such a manner, as to render the composition distinct in its parts, and striking on the whole. In plantations, the trees are artfully mixed according to their shape and colour; those of spreading branches with the pyramidal, and the light green with the deep green. They even introduce decayed trees, some erect, and some half out of the ground. In order to heighten contrast, much bolder strokes are risked: they sometimes introduce rough rocks, dark caverns, trees ill formed and seemingly rent by tempests or blasted by lightning, a building in ruins or half consumed by fire. But to relieve the mind from the harshness of such objects, they are always succeeded by the sweetest and most beautiful scenes.

The Chinese study to give play to the imagination. They hide the termination of their lakes: the view of a cascade is frequently interrupted by trees, through which are seen obscurely the waters as they fall. The imagination once roused, is disposed to magnify every object.

Nothing is more studied in Chinese gardens than to raise wonder or surprize. In scenes calculated for that end, every thing appears like fairy-land; a torrent, for example, conveyed under ground, puzzling a stranger by its uncommon sound to guess what it may be; and, to multiply such uncommon sounds, the rocks and buildings are contrived with cavities and interstices. Sometimes one is led insensibly into a dark cavern, terminating unexpectedly in a landscape enriched with all that nature affords the most delicious. At other times, beautiful walks insensibly conduct us to a rough uncultivated field, where bushes, briars, and stones interrupt the passage: when we look about for an outlet, some rich prospect unexpectedly opens to view. Another artifice is, to obscure some capital part by trees or other interposed objects: our curiosity is raised to know what lies beyond; and after a few steps, we are greatly surprized with some scene totally different from what was expected.

These curious observations upon gardening, shall be closed with some reflections. Rough uncultivated ground, dismal to the eye, inspires peevishness and discontent: may not this be one cause of the harsh manners of savages? A field richly ornamented, containing beautiful objects of various kinds, displays, in full lustre, the goodness of the Deity, and the ample provision he has made for our happiness; which must fill every spectator with gratitude to his Maker, and with benevolence to his fellow-creatures. Other fine arts may be perverted to excite irregular, and even vicious, emotions: but gardening, which inspires the purest and most refined pleasures, cannot but promote every good affection. The gaiety and harmony of mind it produceth, inclining the spectator to communicate his satisfaction to others, and to make them happy as he himself is, tend naturally to establish in him a habit of humanity and benevolence.

HAVING thus unfolded the general principles of gardening, that have an influence upon taste or manners; we

shall now subjoin the practical part, in the form of a calendar.

## J A N U A R Y.

### FLOWER-GARDEN.

THIS is the proper time for planting roots of the ranunculus; the soil should be rich and sandy, and they should be planted at least three inches deep. By laying a quantity of earth made of old thatch or straw, about seven inches beneath the surface of the ground, and then filling it up with rich mould, a prodigious number of these flowers may be produced. A fine earth may likewise be made of tanner's bark, or the bottom of a wood pile, well mixed with about a third of natural soil, which will prove peculiarly serviceable.

As the wind and frost are very prejudicial to carnations and auriculas, they should this month be kept covered.

Anemonies should be planted in beds of fine earth; no dung must be used in planting them. The roots of these flowers may be increased by breaking the knots, about the size of a small button, asunder, and letting them lie two or three days in the sun, before you plant them. It should be remembered, that the roots of the anemony are to be taken up about the end of June or the beginning of July; after being dried in the sun, they should be preserved in a dry cool place, or kept in sand for a month, and then put in papers till the season for planting them. When these roots are first transplanted, a thin layer of willow-earth, or rotten sally-wood, being put under them, forwards their growth.

### FRUIT-GARDEN.

THE pruning of pears, vines, and plumbs, is the chief employment of this month. In pruning the pear, those buds which appear fuller than the rest should be carefully preserved; all branches that proceed from the knob, whereon the stalk of a pear grew, are to be taken away, but the knob must remain; and the extremity of the last year's pruning is to be taken off.

As the large branches of a pear-tree are useless in bearing, care should be taken to extend the branches sideways, and none but small branches suffered to grow in the middle, and not even those to grow directly perpendicular, as, by that means, they would soon become what is called *great wood*.

A pear-tree that is vigorous and luxuriant should not be pruned till after it has begun to shoot. A languishing pear-tree may be restored to its former state by pruning and removal into better ground. Another very good method of treating pear-trees not in a bearing state, is to bark the luxuriant branches all round about a quarter of an inch wide, more or less, according to their strength. Apple-trees will likewise bear this operation, which should be done in April. Trees that are too vigorous may be made to bear by cutting off the sap roots, or taking them up, and re-setting them, for they are often planted

planted too deep. Plumbs and cherries may be pruned in the same manner as pears.

The winter-pruning of the vine (which requires a first, second, third, and sometimes a fourth pruning) should be done either in October, November, December, or this month. The vigour of the vine is to be regarded; the small weak shoots that never bear any fruit must be cleared away, and the other branches are to be so proportioned as not to occasion any confusion; such as are thickest and best placed should be preserved, and the strong short branches left nine inches or more, according to the size of the vine. When they have shot twelve or fifteen inches long, which will be in the summer, you must begin to nail them up; and when they have shot two or three feet, stop or cut off the ends of the shoots; those on the side should not be broke off till the fruit is set: and a fruit bearing branch should be cut within three or four eyes of the fruit.

All suckers should be cut off as soon as they have shot seven or eight inches. The vine should be kept thinner of wood than any other tree, though it puts forth the largest shoots. All the old wood should be cut out, and its place supplied with vigorous young shoots.

All dead or cankered branches should this month be cut from the standard fruit-trees, as also such as cross each other; but in doing this you must be careful to make the wounded part as smooth as possible, and sloping, that the wet may not enter and be detained there, to the great prejudice of the trees.

#### KITCHEN-GARDEN.

The management of hot-beds claims almost the sole attention of the kitchen-gardener this month. The place most exposed to the sun is best for making a hot-bed: when you have marked out the dimensions of the bed, drive stakes into the ground on every side, a yard above the ground, and a foot asunder; wind these round with bands made of hay or straw, and then fill them up with wet litter and new horse-dung, treading it down very hard as you fill; in doing which you must be careful to leave room for the earth and the shooting of your plants.

When you have thus laid the bed, fix your wooden frames fitted to the same, for the reception of the mould at top, and for the support of glass frames, which are to be fixed sloping.

The hot-bed should then be finished by putting in the earth; an old hot-bed, well rotted, affords excellent stuff for this purpose; but if that cannot be procured, some very rich mould well sifted will do.

Over the whole you must fix matts supported by short sticks, which must remain about a week; by which time the bed will abate of its extreme heat, and be of a proper temperature for use.

The bed should be warm, not hot; and when the heat lessens too much, by applying new dung to the sides, you may renew it.

When plants are come up in a hot bed, they should have air and the sun by degrees; and when strong enough, should be removed to a second hot-bed, of less heat than the former, or into very rich earth, where

they should be frequently watered gently, and kept from the meridian sun till well settled; and when the weather is cold, by covering the glasses a little before sun-set with litter and matts, they may easily be defended from it.

Gardeners in general make their seed-beds for cucumbers and melons in this month, for raising them before their natural season; but the better method is, to make hot-beds the latter end of October or beginning of November: about four feet square, and two feet high, is the proper size, wherein, after the heat is moderated, cucumbers and melons may be sown.

About a week after their coming up, plant them four inches apart in the same bed, after having well stirred up the earth. As the days in October are usually warm, the plants may be allowed to have air; but in January they must be kept covered up close. In this first raising of plants, a gardener may, with due care, make them as hardy as he pleases.

It is usual with some people to keep their melon seeds in milk four and twenty hours before they make use of them; others use them without that preparation: they should be set two or three in a hole, in the hot-bed, about an inch deep, and covered close up, to keep them warm. About the end of April is the time for planting melons, which should first be done in small baskets made of old willow-twigs, three inches deep, and eight or nine inches over.

Two or three plants should be planted in one basket; and when they will bear it, moved on another hot bed, covered with a sandy loam five or six inches thick, sifted fine, wherein they are to grow all the summer.

Cucumbers are propagated after the same manner as melons; but as a bad season may prevent their being successfully raised, it is highly necessary to put some seeds into the bed at three or four different times this month, that if some should fail, the others may supply their loss. In order to raise asparagus for hot-beds, make choice of a piece of ground that has been well dug and mellowed, then strike out lines seven or eight inches from each other, and plant the asparagus roots in them at six or seven inches apart when they are a twelvemonth old: let them be kept free from weeds, and remain in the nursery two years, in which time they will be fit for the hot-bed. The hot-bed for the reception of these roots should be made pretty strong, and covered with earth six inches thick, encompassed round with bands of straw. The asparagus-roots should be planted as close as they can be placed together without trimming; which being done, cover the buds of the plants two inches thick with earth; in which state let them remain five or six days before the frames and glasses are put over them; and then lay on over the whole three inches thick of fresh earth.

As soon as the buds appear, give them what air the season will permit, which will make them green, and of a good taste. The bed will last good about a month, producing daily fresh buds, if the weather be not too severe: when it begins to cool, warm horse-litter laid upon the glasses every night will contribute as much to facilitate the shoot of the buds as if new dung were applied to the roots.

It should be observed, that the time for this work is not only in this month, but from November till April; (making fresh buds every month to follow one another for a constant supply) and in April comes the natural crop.

A very moderate hot-bed made after the manner first directed, will serve to propagate early strawberries.

You may make a bed in two or three hours, with the use of hot lime and powdered dung, the dung being in the middle, and the lime underneath and at top; over which you should lay a quantity of fine rich mould.

To raise radishes in the hot-bed with success, you should have sufficient thickness of rich light mould, that they may have proper depth to root in before they reach the dung.

Radishes may be sowed all the year, but in hot-beds in the winter.

Mustard, lettuce, cresses, and other fallading, are generally raised from the seeds sown in drills or lines, in such an exposure as is required by the season of the year; in the winter-season, on moderate hot beds; in the spring, under glasses and frames; and in the summer, on natural beds of earth.

Cresses sown in the natural ground in August, resist the frosts of the winter, and help greatly to enrich the hot-bed fallads with the high taste they maintain by being exposed to the open air.

Small herbs should be drawn up by the roots from the hot beds; and, in sowing a second crop, seeds of another kind should be sown, and not the same kind in the same place.

The hotspur, charlton master, and other peas, must be sown in drills three feet asunder, that you may have room to go between them; and the lines should run from north to south.

When they have shot about six inches high, earth them about four inches on both sides of the lines, raising a little bank on the east side of them, to defend them from the blasting winds.

In February you may sow a second crop, and in March a third.

You must, in the beginning of the winter, sow twice the quantity of pease you need to do, if you stay till February or March; because the cold weather and the mice will destroy great part of them.

## F E B R U A R Y.

### FLOWER-GARDEN.

FOR the better management of the auricula, which is to be sown this month, prepare a box of oak or deal, four feet long, two feet wide, and six inches deep, with holes in the bottom, six inches distance from each other; in which, after laying two inches thick of cinders or sea-coals; and spreading over them some earth taken out of hollow willow-trees, till you have filled the box, sow the seeds on the top, without any covering of earth, pressing them into the mould with a flat board, in order to settle them below the edges of the box that the light seeds may not float over the brim in watering.

From the time of sowing to the beginning of April, this box must be placed where it will receive the sun; but after that time, it must be removed into a shady place; and the seeds must be continually refreshed with gentle waterings.

If the seedlings do not come up the first year, they will the second; and in July or August, after they appear above ground, will be strong enough to transplant; when you must set them in beds of light earth well sifted, at about four inches distance from each other, and place them where they may receive only the morning sun.

The April afterwards they will begin to shew themselves, when they should be transplanted into pots filled with soil made of one load of melon-earth, or dung well rotted, half a load of sea-sand, and half a load of sandy loam; or a load of melon earth, and the like of sandy loam; or one load of rotten wood, or the bottom of a wood-pile, the same quantity of loam, and half a load of melon earth, prepared as above.

These flowers must be carefully sheltered from the rains, which greatly impair their colours.

Provided the weather is mild, you may, toward the end of this month, plant out your choice carnations into the pots where they are to remain to flower; in doing which, you should not take too much of the earth from their roots; and when they are planted, it will be proper to place the pots in a warm situation (but not too near walls, or pales, which will draw them up weak); and arch them over with hoops, that in bad weather they may be covered with mats; for unless they acquire strength in the spring before the heat comes on, they will not produce large flowers.

The polyanthus seed must be sown upon a place prepared with earth taken out of decayed willows, often watered and kept shaded from the sun all April and May, till the young plants are come up.

The seedlings will be fit to transplant the July or August following into beds: the soil of which should be somewhat binding, and their exposure only to the morning sun.

You may have an annual supply of larkspurs without the trouble of sowing, by suffering the seeds of the flowers to drop, which will come up the ensuing spring: they are sown in spots, and flourish in variety of ground.

The single sort of Sweet William is raised by seeds sown in February or March; the double sorts, propagated from slips taken near the root about March or April, and planted in a loamy soil: they may also be laid down in the earth like carnation layers.

Holyhocks are raised by seeds sown in this month, removed in August or September to their proper places of vegetation, in rich earth.

The most agreeable disposition of this flower is, under some coarse wall, which they will handsomely fill, or in any other place guarded from the winds.

Pinks, and candy-tufts, are generally used in edgings in gardens, and insides of borders, where they are planted in spots, and have a very agreeable effect.

The seed is sown in lines in this month or March; or they may be propagated from slips planted very early in the spring, or in August.

Rose-



Rose-trees, of which there are various sorts, succeed best in a strong holding ground, tolerably moist; they may either be raised from layers or suckers, laid down and taken from the old roots in February or March, and transplanted immediately before the roots grow dry: should there be a necessity for keeping them out of the ground for some time, lay their roots in water five or six hours before they are planted.

The rose-tree does well in borders, or in the quarters of wilderness works, among other flowering shrubs; and some or other of them will be in flower for ten months in the year.

The laburnum tree is commonly planted among the other flowering shrubs of the wilderness, and will grow in the most open exposure, as well as under the shade of large trees: it may easily be raised from seeds sown in this month, and transplanted two years after it comes up.

The althæa may be raised from layers or seeds; there are several different colours of this flower, and they may be budded so as to have all the colours on one plant.

The pomegranate prospers most in a light soil; and being propagated by laying down the young shoots in this month or March, may be transplanted either in the spring or autumn season, when they may be put in pots, or against a south wall, where the fruit will ripen.

The pomegranate may also be raised from seed.

The syringa may be raised from seeds; but it is hardly thought worth the trouble, as it is very apt to put forth suckers; these, however, may with ease be taken off and transplanted at this time of the year, and in September.

It is a shady position which makes this shrub shoot, and the sun makes it flower; but it will grow almost any where.

The lilach is a plant which grows to a pretty large tree, bearing bunches of purple blossoms, likes plumes of feathers, in May; and is raised by laying down the young branches in this month or March, or by taking off the suckers, and planting them in a light soil, about the same time, or in September.

These trees are highly ornamental in the quarters of wilderness works, and small walks of them are very pleasant.

The Spanish broom is planted in wilderness works, and may be raised from seeds sown in light earth; also by laying down the tender branches, and cutting them at the joints, after the manner of the carnation; but the latter method is not so certain as the other, though it is far more troublesome.

The laurus tinus is greatly admired for producing its flower in the winter; and may be raised from the berries, managed as the holly; or from layers, which is the most expeditious way.

This plant is greatly hurt by frost, and succeeds best in moist shady places; it will flourish in loamy soil, without the help of any rich manure, which forwards its growth too much.

The laurus tinus, is often trained up as a headed plant, though it is best planted against a wall, or in wildernesses; and it is observable, that this plant, like all other exotics, is naturally inclined to blossom about the spring in its own

country, which is our autumn; for which reason, it should be pruned in our spring season after it has done blowing.

The phillyrea, may in general be propagated from the berries, or raised from layers, which will presently take root.

This plant, which succeeds best in a natural light soil, grows very fast; and being well supported with rails or stakes, a number of them makes a very thick and handsome hedge.

The yew-tree delights in a light barren soil, and is more plentifully produced on the coldest mountains than in the richest soils.

The berries of the yew may be laid in sand, as those of the holly, before they are sown; and there is no difficulty in propagating this plant, or removing it, if the roots are pruned from time to time, by digging about it while it stands in the nursery.

The holly will grow to a very large tree; but being a rooted plant, does not succeed well when transplanted, unless the roots have been often pruned in the nursery.

The berries of this plant, when ripe, are to be gathered; and after they have been laid to sweat some time, are to be put in sand or earth, till the autumn following, when, and likewise in this month, they may be sown in nursery beds.

They will lie in the ground for a long time before they begin to spring, and it will be four or five years before the young stocks will be fit to graft or inoculate upon.

The grafting must be done in March, and the inoculating in July; but for standard trees or hedges, they must be planted at their proper distances while very young, that they may be accustomed to the soil.

The bay tree, which is managed as the holly, is raised by berries sown in this month, on a bed of earth fresh dug, and covered with some fresh natural earth, well sifted, about two inches thick.

In about six weeks, the seeds thus sown will come up, should the weather prove moist; they should be covered with straw, or fern, for the three first winters, after which time they must be transplanted.

When these plants are discoloured by frost, cut off the top-branch in the spring, and they will shoot afresh.

The bay-tree may also be raised from layers laid down in the month of October, for cuttings, set in pots of fine earth, two or three inches deep; and from suckers taken up with as much root as may be, and planted in the shade, in a gravelly soil, being well watered to settle the earth about their roots.

The laurel is propagated in the same manner as the bay-tree, loves shade, resists the weather, and will thrive in almost every soil.

Towards the end of this month, if the season proves favourable, stir the surface of the ground of your flower-beds, and clear them from weeds, moss, and whatever filth may appear thereon, which will not only make your garden look neat, but be of peculiar service to the flowers.

#### FRUIT-GARDEN.

THE business of this month is chiefly pruning and grafting.

ing; and is more particularly the season for pruning fruit-trees.

When a tree has produced two well disposed branches with some weak ones intermixed, they should be shortened equally to the length of five or six inches; and if the position of the two branches be irregular, there must be only one left to begin the formation of your tree.

A tree will sometimes shoot five, six, or seven branches, the first year; when this happens, three or four only of the best branches are to be preserved.

A multitude of branches in the first year, is not always a sign of vigour; for they sometimes prove weak, occasioned by the infirmity of the roots: in pruning, generally a vigorous tree cannot have too many branches, if they are well disposed, nor a weak one too few.

The sap of all trees must be kept within due bounds, and a greater liberty is to be allowed to strong trees than to weak ones; for which reason strong and vigorous branches are left of a greater length than feeble ones: and it is best to prune weak sickly trees early, that the sap may not be too much wasted.

In the pruning of wall-fruit-trees, all the branches shooting directly forward are to be cut off close to the branch they spring from; and the utmost care must be taken to prevent their being too much crowded with wood, it being often necessary to take off even bearing branches, to preserve your trees in beauty and health; for it is impossible too great a number of branches should be supplied with juices as they ought; and if they are not, either the blossoms will drop off, or the fruit never ripen.

You should ever be careful to preserve a convenient space between one branch and another in all prunings; also that one branch does not cross another: a slender bearing branch may, notwithstanding, sometimes be permitted to steal behind the main body of the tree, and be no offence to the eye.

That a tree may be the better disposed to bear fruit, the branches should be carried horizontally as much as possible; for the more perpendicular the branches of a tree are led, the more they are inclined to run into great wood and barrenness.

Small weak branches, shooting from the like, should be cut away, as should all shoots put forth in autumn.

When an old tree shoots stronger branches towards the bottom than the top, and the top is sickly, it must be cut off, and a new figure formed from the lower branches; but if the top be in good health, you must cut off the lower ones, unless it be a few that are well placed.

Where old trees are in a weak condition, to preserve them, they are to be disburthened totally, leaving a few branches only shortened to five or six inches.

Having thus laid down the principal rules for pruning in general, we now come to the management of the peach and other fruit trees in particular.

When peach trees are vigorous, it is best to defer the first pruning till they are ready to blossom, when you may be at a certainty in preserving those branches which are most promising of fruit, and then to shorten them as they require.

You may soon discover the fruit-bearing branches by their swelling buds, and you should reduce them to the

length of five or six inches; the last year's shoots may be left ten or twelve inches long.

In the space of about three years, all the wood must at several prunings be taken away, but in the mean time the wall is to be furnished with other wood.

When you have reduced your tree to beauty and order, you have little to do but thinning your fruit till Midsummer, when the shoots are to be shortened and fastened to the wall, giving the fruit the advantage of the sun as much as possible.

If the peach-tree makes over-haste in its bearing, it is a sign of infirmity, and must be accordingly managed, by pruning the branches short, and plucking off all or most of the blossoms or fruit; which it is much less difficult to do than when a peach is over vigorous; for then nature is apt to make a confusion, which requires the greatest skill to know what branches are fit to be chosen, and what rejected.

The peach-tree requires a second, and sometimes a third pruning; the last of which is to be performed about the middle of May, or in June or July.

The apricot and nectarine may be pruned in the same manner as the peach; but it should be observed, that the apricot is more apt to run to wood than any other of these kind of wall-fruit trees.

The usual ways of grafting are, in the cleft—in the bark—by approach, and whip-grafting.

Grafting in the cleft, or slip-grafting, is performed on the cherry, pear, and plumb stocks, in the manner following.

When you have chosen a stock, in a smooth place cut off the head of it, sloping: then, with your knife make the top horizontally even; which being done, make a slit of near two inches deep down the middle of the stock; in which fix a cyon, sloped on each side from a bud; and closing the bark of both exactly, tie them round with bals.

When you have thus finished your grafting, put a quantity of clay and horse-dung, tempered together, round the stock and lower part of the cyon; in doing which, be careful not to disturb the latter.

Grafting in the bark is generally performed only on apples, by cutting the head of the stock as already directed; but instead of slitting it, slit only the bark a little above an inch on the south-west side, or as long as the sloped part of the cyon; then, loosening the top of the bark with your knife, put in your cyon (being prepared with a flat slope about an inch long, ending in a point, and begun from the back-side of an eye) and closing it as above, cover it also in the same manner with clay.

When either an apple, pear, plumb, or cherry tree, wants a branch to make the tree uniform, a graft may be put into the side without cutting the head of it.

Grafting by approach, or inarching, is performed when a stock grows so near another tree, the fruit of which you would propagate, that it may be joined with a branch of that tree, by cutting the sides of the branch and stock about three inches long, and fitting them, that the passages of the sap may meet; in which posture let them be bound and clayed.

When they are well cemented, cut off the head of the stock

Stock about four inches above the binding; and in March following, having cut off the stubb that was left of the stock, and the cyon underneath, close the grafted place, that it may subsist by the stock only.

This manner of grafting agrees best with vines, pomegranates, oranges, and such like shrubs.

When the stock and cyon are of the same bigness, the operation of whip-grafting is performed, by sloping the stock and cyon about an inch, so as to make them fit, and then tying them together, and claying the place.

#### KITCHEN GARDEN.

Hot-beds for radishes and spring carrots should now be made, according to the directions given for a common hot-bed in the preceding month; which, by proper management, will do for all sorts of seeds that are annual.

To make a mushroom bed, dig a trench five or six inches deep, and lay in it either the dung of horses, mules, or asses, in ridges, which dung must be the last covering before the earth is laid on.

The bed, when it is complete, must be three or four feet high; and after covering the dung about two or three inches deep with such earth as is taken from under a turf, put some mushroom-earth all over the bed on the last covering of dung.

Should the weather be severe, you may defend the bed with straw or dry litter, eight or ten inches thick, or cover it with mats fastened on hoops.

The bed must be kept properly watered, twice or thrice a-week, and the mushrooms will come up in two months time at farthest; sometimes in a month, when they must be immediately cut.

By putting some mushroom earth on your cucumber-beds, you will greatly forward their growth.

In the natural ground potatoes love a sandy soil; and the smaller roots, or knots of them, are commonly saved to raise a crop from, being set about four or five inches deep in the ground, and five or six inches apart; and when their haulms begin to decay, which is generally about Michaelmas, you may take them out of the ground with forks as you have occasion to use them.

The Jerusalem artichoke succeeds best in a stiff soil, and affords a root as large as an ordinary turnip, being in taste somewhat like a potatoe, but rather more watery.

The several sorts of cabbages, as the red cabbage, the Dutch cabbage, the Savoy cabbage, the Russia cabbage, the Battersea cabbage, and the two sorts of the sugar-loaf cabbage, should be planted at proper distances, according to their several statures.

The Savoy cabbages are for winter use, and towards the spring put forth sprouts preferable to the cabbages themselves.

Almost any ground will serve for cabbages; but if the weather be dry, it must be well watered before planting.

The hardest cabbages may be taken up before the great frosts come on; and after they have hung up by the roots about a fortnight, lay them in a cellar, where they will keep a long time; or plant them deep in the ground

close to one another, and cover them with haulm or straw, till you have occasion to use them.

Carrots are most prosperous in a light ground, in which their roots will grow to a great bigness.

Spring-carrots are sown in July or August; those intended for a winter-crop, in February or March, in dry weather

When your carrots are come up, and have been above ground about a month, they must be houghed, leaving the space of about five inches between the plants; and after the first houghing they should be kept as clean as possible till they are full grown, when they may be taken up for present use, and kept in sand during the winter.

Parsnips thrive best in a rich soil, and, excepting that they should not stand so thick, are to be managed in the same manner as carrots.

The skirret requires a light, moist, yet a rich soil; and is propagated either by sowing seeds, or by transplanting the offsets from the roots,

As soon as the leaves begin to put forth, they should be taken out of the ground, and parted into as many slips as can be conveniently taken off with the roots, so as only the fresh springing fibres remain on them; drills about four or five inches deep must then be prepared to plant them five or six inches apart, and they must be kept well watered till their roots are fully grown.

The usual time for sowing turnips is in July or August, but some people sow them in this month, by way of providing them for the summer. They thrive best in a sandy, loamy soil, but will grow in any ground: when the plants have two or three leaves, they should be houghed at the distance prescribed for parsnips and carrots.

Onions are sown in this month, and in March, in rich garden soil; and toward the latter end of April, being come up, they are houghed, when about three inches should be left between the plants till they begin to grow fit for fallads, and then they may be drawn, or thinned where they grow too close together.

In sowing onions you must not be sparing of seeds, as it often happens many of them, being bad, have no effect.

When the leaves begin to change their colour, they should be pulled up, (in dry weather;) and after being well dried without doors, they must be spread on some floor, to dry more thoroughly for winter use.

Such onions as spire in the house, may this month be planted in lines six inches apart, and two inches distance for seeds for another year.

The leek is sown in a well-wrought ground, and is to be kept free from weeds, and houghed like the onion; the plants are transplanted in July, in rich light soil, in lines about five inches apart.

Strawberries prosper most in ground inclining to clay; and the best way of managing them, is to provide a quantity of horse-dung and coal-ashes well mixed together, and lay it upon the land to be dug or trenched in this month; then make borders three feet wide, on which the slips are to be planted from eight to eighteen inches apart, according to the sorts: the chila strawberries being largest, should be set two feet asunder.

Afterwards you may set beans for a summer crop, and plant roses, sweet brier, currants or gooseberries, at every five or six feet distance, as the plants will not begin to bear fruit to any purpose till the following year, and it will be the third year after planting before there will be a full crop; in the mean time the roses, gooseberries, &c. turn to a good account, besides being serviceable to the plants by shading them.

The strawberries should be kept clear of weeds, and, if their blowing season be dry, well watered: early in the spring you must cleanse them, and sling loose earth among them to strengthen their roots.

Of strawberries there are five sorts, the chila strawberry, the hautboy, the scarlet, the red, and the white wood-strawberry.

There are two kinds of raspberries, the red and white; the latter is the greater rarity, and thrives in such ground as agrees best with strawberries, being propagated by slips taken from the roots the latter end of this month or in March.

Raspberries should be planted in single rows, about a foot or eighteen inches asunder, and three feet between every row, leaving the heads two feet high when planted.

The Muscovy clustered raspberry, planted against a wall between the trees where there is a vacancy, will ripen very soon; and their chief culture is to keep them clean from weeds in the spring; to prune the tops of the strongest shoots of the last year, leaving them about three feet high; and to cut away all dead and weak branches.

The gooseberry is propagated either by seeds, suckers, or cuttings; the first may be sown as soon as ripe, and will come up the spring following; the suckers are taken from the roots of old trees when their leaves are fallen, and transplanted in nurseries, in open weather; and the cuttings will take root, being planted in the months of September or October.

This tree requires a strong holding soil, and may be transplanted with more safety in October than at this time of the year.

Currants are to be raised in the same manner as the gooseberry, and thrive best in the same kind of soil.

Liquorice should be planted at this season of the year; and the ground made choice of for planting it should be trenched three feet deep, and the liquorice set at a foot distance every way.

## M A R C H.

### FLOWER-GARDEN.

THE rose campion is propagated either from seeds sown this month, or from slips taken from the roots: the double-blossom kind is raised from slips only, as it does not produce any seeds; the last-mentioned thrives best in a loamy soil, and open exposure.

In this month also off-sets of the white hellebore are planted in a rich light soil.

Seeds are now sown of the fox-glove, which succeed best in the shade and a loamy soil; this flower does not blow till two months from the time of sowing.

The poppy, which is an annual, is sown in spots; as is the Venus looking-glass: the latter is proper also for edgings.

The valerian is raised from seeds, and some kinds of it are increased by parting the roots.

The primrose tree will grow in any soil, and the seed of it is sown in the natural ground towards the end of this month: it is very proper for the middle of borders in large gardens; and the seedling plants, which will not blossom till the second year, are to be sown in the nursery, and the young plants removed to proper places in the August after they come up.

Slips of the gentianella are planted in a sandy soil in this month or August.

Cardinal flowers are raised by seeds sown in hot-beds, in fine sifted earth; and the seeds being small, are to be lightly covered with mould: these flowers, which are commonly cultivated in pots, may be increased by parting their roots in April, and planting them in places well exposed to the sun.

You should now sow the seeds of the stock-gilliflowers, and transplant them in the August following, in a light natural dry soil.

The double kinds of this flower may be increased by slips or cuttings planted in May, June, or July.

Sow the seeds of the acanthus, in a sandy soil, and in the shade.

A loamy soil is requisite for raising the double rocket flower, which is propagated from slips taken from about the root.

The scarlet lynchis is propagated either from seeds, or slips taken from the root; it is also cultivated in pots, and requires a loamy soil, and open exposure.

The several sorts of double wall-flowers may be raised from slips planted in shady places, either in March, April, May, or June; but the bloody wall-flower may be more easily raised from seeds sown in this month: and a sandy soil is requisite to make them thrive.

The monk's hood, a flower of a poisonous quality, is propagated by parting the roots, which should be done in this month, and will thrive best in a loamy soil, in the most shady place in your garden.

The sun-flower, which will grow in any soil, is raised from seeds sown in large borders; and also by parting the roots, either in this month or in August.

The asters, or starworts, will thrive in any soil, and are fit companions for the tallest flowers in your garden: they are propagated from slips taken from the root; and the best method is to plant them in pots, otherwise they will grow so numerous as to become a nuisance rather than an ornament.

Seeds or layers of the passion-tree may be sown this month; and every cutting of it, being planted in fine earth, will take root about May or June.

This tree is a prodigious quick grower, and very hardy; loves moist and cool places; and, if constantly watered, and dunged about the roots, it will bear fruit resembling lemons.

The arbutus, thrives in a light, gravelly soil, and may be raised either from seeds or layers; and the fruit (which must be gathered about Christmas, and laid to dry for

a month) is to be sown in pots of light earth, and covered about a quarter of an inch with fine mould in this month; and the gentle heat of a hot bed will greatly assist the germination of the seeds, which are to be frequently sprinkled with pond-water as they come up.

The layers of the arbutus are made of the most tender shoots about September; but will not be strong enough to transplant the spring following, though they will take root in a year's time.

The apocynum, or dog's-bane, is propagated from seeds sown this month in hot-beds, or from cuttings; a light natural soil agrees best with them; they should be watered but seldom, and then gently; and they should be set in the hot-house sooner or later, as they are more or less tender.

Set the stone of the fruit of the palm-tree this month in light earth, and give them the assistance of the hot-bed: it is a green-house plant, but might be made to stand abroad, after sheltering for three or four years.

The green privet, which is a plant of a quick growth, and makes an admirable hedge, is propagated by sowing the berries in light earth, about an inch deep, watering them frequently till they come up; a hot gravelly soil is the most proper for this tree; and they are to be transplanted from the seed-bed the second year after sowing.

The mezeron, should now be sown in a loamy soil, and care should be taken to preserve it from the birds.

The berries of the juniper-tree may be sown this month in rich ground without watering, or in any light manure, and in about two months they will come up; and they are to remain in the seed-bed two years, during which time they must be kept free from weeds, and then they may be transplanted.

You may now take off the suckers of the *Spiraea frutescens*, and plant them in a light soil.

Sow the seeds of the several kinds of firs ornamental in wilderness-works, which will flourish in any soil; in order to keep their bodies smooth and free from knots, you must break off their collateral buds while they are young and tender.

Upon the hot-bed, sow such exotic seeds as are less tender, and arrive sooner at perfection than those sown the last month; among which are the China or Indian pink, the *nasturtium Indicum*, *convolvulus*, and balsamines; and none of these must be planted in the natural ground till the middle of May: if you have no hot-bed, you may defer growing the marvel of Peru and the *nasturtium* till the next month, when they will come up in the natural ground.

Plant tube-roses in pots of fresh earth; giving them a gentle warmth, but no water till they sprout out of the ground.

The seeds of the *sampanula pyramidalis* should now be sown, and slips taken off from the roots; fresh air should be given to the pots of this flower, and they should be set in some pit where the sun may come at them, by which means they will grow tall.

Mend and repair your shelves and places of shelter for auriculas, which should now be guarded on all sides but the east from the sun, and defended from rain; put canvas coverings or mats over your tulips, to prevent their

being blighted; and transplant your carnation layers for blowing, if they were not planted out in autumn.

The seeds of the humble and sensitive plants may now be sown upon the hot-beds; and the *noti me tangere* in the natural ground.

You may transplant your evergreens; graft the Spanish white jessamin upon the common English sort; and slip or set box for edgings, or in figured works.

Such exotic plants as have suffered in the green-house, should be removed to the hot-house; where, to prevent the steam of the bed from being of bad consequence, the dung should be covered with a due thickness of earth.

#### FRUIT-GARDEN.

You may make layers of the vine either in this or the next month, and they will be fit to transplant at Michaelmas; this tree is also propagated by laying down the young branches as soon as the fruit is gathered, or by making plantations of cuttings at that time.

If the weather proves open in February, that is the best time for planting vines; and the soil in which they best succeed is rocky or gravelly.

A chalky hill, lying very open to the sun, will produce better grapes than any of the rich soils prepared with horse-dung; but a tolerable good compost, to mix with the earth about the roots, may be made with the rubbish of old buildings.

In planting a vine, let the places where your vines are to stand be open and prepared before any of the plants are taken out of the nursery, when great care should be taken in their removal; they are to be planted six or seven feet every way, and the best grapes for a vineyard are the marlmore, chiente, claret grape, and Burgundy black morellon.

These vines are to be pruned the September before transplanted, according to their strength, leaving not more than four buds on the strongest; and to cleanse them from weeds is all the care they will require the first summer.

Shorten the summer-shoots about the end of September, and the strongest of them will begin to shew a little fruit the summer following.

In May or June of this second year, the small shoots and superfluous branches are to be carefully broke off, and two or three shoots only preserved on each vine, which should be supported by stakes or poles, till the September following, (for the nearer the grapes grow to the ground, provided they do not touch it, the sweeter they will be) and then they may be shortened.

The vineyard, thus planted and managed, will, in five or six years time, produce a good crop of grapes.

The fig is raised either from layers, seeds, or suckers; the layers are ordered like those of the vine; the seeds are sown in rubbish, or such like soil; and the suckers are separated from the old roots the beginning of this month, and transplanted without cutting off their tops.

The fig tree thrives in the same sort of soil as the vine, and may be planted either against walls or in standards.

The pruning of this tree is very different from that of

of other fruit-trees; for as the practice is to take away the small branches in pruning other trees, so here it is to be avoided, because the fig puts forth its fruit chiefly at the extremities of the last year's shoots; but you may cut off some of the weak smaller shoots which do not promise to bear, so as you do it close to the great wood.

The branches must not be suffered to grow too high, as they are prevented by that means from being full; the new thick branches must be shortened yearly to about a foot, and the bud at the end of the branches broken off in the spring time, which will cause the figs to shoot out more early, and instead of a single branch there will be two.

The pruning season of the fig is towards the end of this month; and it is best in the summer to let this tree have some liberty from the wall, and not suffer it to continue close tacked to it like other fruit-trees; but in the winter some of the straggling branches should be cut off, and the best and biggest branches tacked to the wall in November, that they may be more effectually settled, and sheltered from the frost in the winter by the defence of a mat, or otherwise, especially when the season is very cold.

The suckers which this tree puts forth in great abundance, must be kept down, and whatever you cut away, must be as close to the great wood or roots as you can; and a whole tree may, after an unkind winter, be cut down for the recovery of its former state of health.

The following is the method of making the horizontal shelters for fruit trees: Lay rows of tiles in the structure of the wall, at certain distances one above another, the tiles jetting forward, and hanging over the plane of the wall about an inch and a half; this is neither a difficult nor a chargeable work, if the wall be of brick, to place between every two rows of bricks these horizontal shelters of tiles: and if the wall be of stone, and the joints be any thing regular, it is not less easy.

In order to avoid the inconvenience of branches riding over the edges of the tiles, in each row, at convenient distances, must be left void places or gaps, for the wood branches to pass through; which gaps are to be left wider at the bottom than at the top of the wall; and the rows of the tiles are not to be laid exactly horizontal, but rather a little sloping, the better to shoot off the water from the fruit.

Blossoms and tender fruit are more especially preserved by these horizontal shelters, than by mats, or coverings, of any kind whatsoever; and by their assistance a good quantity of the choicest fruit may be depended on in the most difficult and unseasonable year.

#### KITCHEN GARDEN.

DIRECTIONS have, in the month of January, been given how to sow pease in drills, or lines, and to earth them when they come out of the ground; when beans may be planted three feet asunder between the rows, and the large peas four feet, being set about five inches apart in a stiff soil, without any manure, kept clean and watered about the time of their blossom.

Thyme is raised either by seeds sown in this month or April, or from slips planted at the same time.

Sage is also propagated from seeds or slips, but most commonly from the latter, taken from the roots at the end of this month, or the beginning of the next, and planted, in light earth, a foot apart.

Of marjoram there are two sorts; one of which is called winter sweet marjoram, and propagated by planting the slips about March or April in moist ground; and the other sort is sown annually on hot-beds.

Camomile and penny-royal are propagated from slips planted in this or the next month, in stiff soil and in a shady part of the garden.

Fennel is raised from seeds sown in this month in the natural ground; as is parsley, dill, &c.

Mint and balm will grow any where, and are propagated by parting their roots in any time of the spring as well as by sowing.

Mint is more generally propagated than balm, and when it is about a foot high you may cut it in branches, and dry it in the shade for winter use.

Rue is a plant which is multiplied by slips set in a light soil, and should have a place in the shade.

Tansy is a plant, which should always be kept dry in winter, and is increased by parting the roots in the spring.

Sellery is a hot herb, and raised from seed sown in this month, or April; in some well exposed place in the garden; it must be planted out about six weeks after it is come up in beds, allowing six inches distance between the plants, and they may remain to the middle of June, at which time some of the first sowing will be fit to plant in trenches for blanching, in a light rich soil.

Your trenches must be eight or ten inches wide, and of the same depth; in which the plants are to be put as soon as made, after having pruned off their tops and roots; place them at five inches distance; as they increase in growth, earth them up within four or five inches of their tops. Endive may be sown in this month, but April is the more proper time; a light soil agrees best with it, and when it has been come up about six weeks, plant it in beds as directed for sellery, and about the middle of July plant it in rows about six inches apart.

When it is well grown, tie up some of it to whiten; which work should be continued every ten or twelve days.

Purslane is sown in this month, and glasses are used to help it forward; and in April it is sown in warm places.

Sorrel is sown in rows or drills, like other fallading.

Of spinach, in March, April and May, you are to sow several parcels of ground at different times, about a fortnight from each other, as a constant supply for the table, till there is plenty of other greens.

There are two sorts of spinach, the prickly sort, and the round spinach, both of which thrive in a light rich soil; and such as is intended for winter use must be sown in August.

Chives are raised by off sets from the roots, planted at six inches distance, cutting off their branches at the time of planting; they succeed best in a light, rich ground; and the oftener they are cut, the smaller and finer they are.

Tarragon

Tarragon is raised from slips and seeds; the slips are taken from the root, and planted in this month in as warm an exposure as possible.

Artichoke seeds are sown about the beginning of this month, and planted out in April; and the middle of this month is the most proper time to slip the roots for new plantations; for they are raised by suckers as well as seeds.

When you have severed the slips, three heads are to be left growing upon every old root; and these slips are to be planted two feet apart, in lines four feet distance from each other, and well watered after planting.

Artichokes thrive best in a strong rich ground, exposed to the sun, with dung well mellowed in it: when they blossom the first year, the roots are endangered; you may therefore break off the blossoms, and about the middle of July break off the stems of the old roots that have done blowing, by which means you will furnish yourselves with fresh shoots.

The seeds of the cabbage and lettuce of all kinds may now be sown in the open ground among the crops; a light rich ground and a warm exposure agrees best with them; and that there may not be wanting a supply of them, they are to be sown every month from March to August, when the winter crops are to be put in, which should be planted out three weeks after they come up, at about five inches distance.

Such as produce large cabbages early in the spring may be permitted to stand for seed, and are to be staked up and defended from the wind; the seeds will be fit to gather as soon as they begin to shew their down, and then the plants are to be pulled up and set to dry in a green-house.

The cauliflower seed is sown in some well-exposed corner of the garden, where the young plants may be sheltered; and about the middle of April, when they are in their first leaf, they are to be planted in a nursery about five or six inches asunder, and there continue till the latter end of May, or June, when they are to be transplanted abroad for your crop, which should be done in moist or rainy weather; or if it be a dry season, holes are to be made in the ground, about three feet apart, and to be well watered before you plant the cauliflowers, which will make the plants shoot, being also frequently watered afterwards.

In the autumn following they will bear large flowers; but some of them will not flower till after Michaelmas, and such plants may be taken up with the earth round their roots, and set together in the green-house, or some such place, where they will enlarge themselves, and be fit for use in the winter.

To raise summer cauliflowers, you must sow the seed the beginning of August, upon some decayed hot bed; and as soon as they have put out their leaf, transplant them about three inches distance, upon some other bed: in the middle of September draw out every other plant, and set them six inches apart under a south wall, to stand there till spring, when they are to be planted out for flowering; or you may set them in the places where they are to blossom, covering them with glass-bells in the winter.

If the weather is open, the first week in this month

Vol. II. No 54.

2

†

7 C

The

you may sow asparagus; and the seedlings will be fit for planting out the February or March following.

The following is the method used by the best gardeners to produce a natural crop.

After measuring out the ground, allowing four feet for the breadth of each bed, and two feet for the alleys between the beds; open a trench at one end, and lay into the bottom of it horse-dung about six or eight inches thick; then go on and trench the same quantity of ground lying next to the first trench, throwing the earth of the second trench upon the dung at the bottom of the first, and thus continue working till the whole is done.

Having finished your beds, plant asparagus, taken fresh out of the nursery, in lines at eight or ten inches distance, spreading their roots, and covering their buds with earth about four inches thick; each bed takes up four rows; and when they are all planted, sow the whole with onions, and rake it level, for the alleys will not be of any use till after Michaelmas, when the onions will be off, and the shoots of the asparagus plants made that summer are to be cut down, the alleys dug up, part of the soil thrown upon the beds, to raise the earth about five or six inches above the buds of the plants, and the alleys supplied with dung, or some rich soil.

In March following the earth must be raked down; and the alleys are to be turned up every winter, and now and then enriched with dung.

When Michaelmas is past, you may cut down the haulm, and give them their winter-dressing; and you should not be later than the middle of March in raking and laying down the beds.

It is a general rule, not to cut any of the asparagus till the fourth year after planting; but where the plants are strong, a few may be taken here and there in very-small quantities the third year.

The asparagus appears above ground the beginning of April, and may be cut till the beginning of June, when they have stood five years; but if they are younger, you must not cut them after the middle of May.

No buds that appear above ground should be suffered to grow in the cutting season, unless they proceed from fresh plants, to make good deficiencies; and those must be suffered to run up every year, till they have gathered strength: it is best to cut them downwards a little sloping with a knife made blunt at the point.

## A P R I L.

### FLOWER-GARDEN.

In this month, and the beginning of May, the seeds of the carnation are to be sown in a compost made of sandy loam, and well-consumed melon-earth, two loads of the former to one load of the latter; sift them well together, and let them lie in a heap for a time to mellow; then sift it a second time either to sow the carnation-seeds in, or to plant your layers or roots of them upon.

Having filled your pots with this earth, and smoothed them on the top, sprinkle on your seeds; and covering them with the same compost, press it gently with a board, and let them stand exposed to the weather.

The seed will come up in about three weeks; and in the July following the young plants will be big enough to transplant into beds, where they must be set about ten inches distant from one another, and shaded from the sun with mats for about three weeks.

You may find many varieties from the seedling plants in the second year; and whatever rarities appear, they must be laid down as soon as possible, by cutting half through a joint, and splitting the internode upwards, half way to the other joint above it; then the wounded part must be buried in the earth, and fastened down till it takes root, which, provided the earth is light, will be in about two months.

The most proper season for laying down the layers of the seedlings is in July; and when planted they must be carefully guarded, both from the intense heat in summer, and the chilling frosts in winter.

The flower stems will begin to put forth about April, when each flower must be supported by its stem being eyed to a stick about four feet long; and as soon as the flower-buds appear, leave only one or two of the largest upon each flower stem, to blossom; and about ten days before the flowers open, the round poded kinds will begin to crack their husks on one side, when you should split or open the husk on the opposite side to the natural fraction with a fine needle; and three or four days before the complete opening of the flower, you must cut off the points on the top of the flower-pod, and supply the vacancies on each side of the husk with two small pieces of vellum, which may be easily slipped between the flower-leaves and the inside of the husk, by which means the flower will make an equal display of its parts, and the form of it, consequently, be entirely regular.

When the blossom begins to shew its colour, you should fix a piece of flat board upon the sticks, to shelter it from the sun's extreme heat.

The seeds of the carnation must be gathered towards the end of September, in dry weather, and be exposed for a month or two, through a glass, without opening the husks till the time of sowing the seeds comes round again.

The seeds of the columbine are sown in the nursery this month, from whence you may remove the choice plants to the garden, and next year they will yield flowers: the roots of this flower will hold good for three or four years, when you must have a supply of fresh ones.

The seed of the scarlet bean is annually sown in good ground, well exposed to the sun; and sticks should be fixed in the ground, round which they will twine, and make a very agreeable shew.

The amaranthus is an annual, sown on a hot-bed; and the seeds being sown in this or the preceding month, in the hottest part of your garden, are to be raised under glasses.

The African marygold is also an annual, raised on a hot-bed.

#### FRUIT-GARDEN.

You should now carefully weed your beds of strawberries, and take off their runners; and if the season is

dry, it will be proper to water them, for they produce but little fruit when this is neglected.

Lay the branches of the peach-tree horizontally, and keep them free from great wood, and perpendicular shoots in the middle, that the sap may be carried in such due proportion as is necessary; and it should be ever observed, that too much vigour is as pernicious as too little, with respect to the tree bearing a sufficient quantity of fruit.

When a pear or apple-tree is ungovernable, and will not bear fruit, strip off the bark of the strongest branches half an inch, or an inch, according to the bigness of the tree, and take it entirely away to the wood.

These branches will continue to bear fruit for several years; and when they die, there are always in a pear-tree a sufficient number of others to succeed them, especially in the middle of the tree; which, if ungovernable, ought to undergo the same kind of discipline.

This work, which should be practised only on low dwarfs, or wall-trees, is best done in March or April.

Cherry-trees, not in a thriving condition, should now be slit perpendicularly down with the point of a knife, just entering the bark of the stem of the tree, to prevent being hide-bound; after which operation they will thrive and prosper wonderfully, when, for want of it, they will continue almost barren for ten or fifteen years.

At this time you should look carefully to your young fruit-trees which were planted in the spring, observing to water them in dry weather; and if you observe the leaves beginning to curl up, you should water them gently all over their branches; which may also be practised to great advantage on old trees; but it must not be done in the heat of the day, lest the sun should scorch their leaves, nor too late in the evening, especially if the nights are cold.

Where you observe the fruit-trees to be greatly infested with insects, you should wash the branches with water, in which a great quantity of tobacco-stalks have been steeped; which, if carefully done, will infallibly destroy the insects, and not do any injury to the trees; or if the leaves which are curled are taken off, and some tobacco-dust thrown on the branches, it will destroy the insects, and may, in a day or two, be washed off again.

Towards the end of this month, you must look over your espaliers and walls of fruit-trees, training in the regular kindly shoots in their proper situation, and displacing all fore-right and luxuriant ones.

In the middle of this month uncover those fig-trees which were screened from the frost in the winter; but do it with caution, as the young fruit, which now begins to appear, may be greatly hurt by being exposed to the air too suddenly.

#### KITCHEN-GARDEN.

The middle of this month is the proper time to plant out melons, which are to be raised under paper; in making these ridges, if the ground is dry, the dung should be but a half a foot higher than the surface of the ground, and the earth should be laid at least a foot and a half thick upon the dung, that the plants may have depth enough to root; they will require no watering, after they are well



well rooted, and hereby a choicer sort of melons may be generally obtained; which, in the common method, frequently miscarry, or produce but little fruit.

The alleys between these beds should be afterwards raised with dung and earth to the level of the beds, that the roots may have room to extend on each side, for the roots of these plants spread as far in the ground as their branches extend on the surface.

Of kidney-beans we have two sorts; the one, which is called the Battersea-bean, bears early, and near the root, without running high; and the other, grows near six feet high.

We sow these beans, the first week in this month, about four inches apart, in drills from north to south, in a light fresh soil, covering them with earth, raised in a ridge, to keep the wet from them: the lines of the Battersea-beans should be two feet apart; and the other sort are to be sown in rows like rounceval-peas, having alleys between them two feet and a half wide; the former kind need not be staked, but the others will not bear well unless they are staked.

From the first sowing in this month, you may, once every three weeks till the middle of July, continue to sow fresh ground with kidney-beans to succeed one another; observing, that when the ground is very dry, as in June and July, and the weather hot, you must water the drills as soon as you have opened them, before you put in the seed, which will contribute to their vegetation; but after they are sown, you must avoid watering them.

Toward the end of this month, you may sow the nonpareils, and the Spanish morotto-peas, about two or three inches apart in lines, leaving a space of three or four feet for alleys, till the whole is sown; and when they are grown up six inches high, earth them up, and set one row of sticks or boughs about six feet high, on each side, for them to run up, and you will have a plentiful crop.

The charlton, or mallow-hotspur, should be sown in December, for the first crop, in drills about two or three feet asunder, the lines running from north to south: a second crop of the same kind of peas should be sown in February; and in March we may put in a third crop of the same sort.

Some ground may be prepared about the beginning of April for the dwarf-peas, which seldom rise higher than half a foot, and are to be set four or five inches apart, in lines about eighteen inches distant from one another; and in order to have a constant supply of young peas, there is a sort of dwarf peas which may be sown in May or June, in edgings upon a gentle hot-bed, the first week in September, and will produce peas in the winter.

Spanish chardons may now be sown in the natural ground; you are to make holes for the seeds about five or six feet distance, and put four or five seeds in each hole: and when they are come up, leave growing only one strong plant in a hole for blanching.

Lavender and rosemary are raised from slips planted in this month, which take root almost immediately if they are shoots of the last year, but if they are older they will not grow: these plants should be set in a light sandy soil, in the warmest and driest part of the garden.

## M A Y.

## FLOWER-GARDEN.

The ficoiles, which is propagated by the cuttings, being planted abroad in a natural bed of earth in this month, will be fit to put in pots in August, where it may remain in open air till the latter end of September; some kinds of this plant being annual, must be raised from seeds every year; and one sort of it will stand the winter, if we raise young plants of it about July or August, that do not blossom in three or four months.

The shrub-kinds, which have their stalks woody, will bear moderate waterings; but the others, which are more succulent, must have very little water. These plants must be exposed to the sun, which will open their blossoms, unless it be two kinds, which only flower in the night. The cuttings of these plants should not be planted before the wounded parts have been dried a day or two in the sun.

The torch-thistle is a succulent plant, raised from cuttings planted between May and the end of July, upon a little hill in the middle of the pot, for they can hardly endure water: and before they are put into the hot bed, they must stand abroad about twenty days to take root; their waterings must be seldom, and gentle: and the best compost for this plant is, the rubbish of old walls, mixed with about one third of sandy soil. The sidums, especially the tree-kind, are easily propagated from branches set in the earth in a light sandy soil, either in this or any of the summer-months, giving them a little water, and as much air and shade as possible in the summer; and in the winter no water at all.

There are several sorts of the geranium, which are raised by planting the cuttings, this month, in natural ground, where they will become proper for transplanting the August following; and from seeds sown in March on hot-beds. Those planted in the natural ground require a medium soil without dung, must be frequently watered, and housed with the orange-trees.

The animum Plinii is raised from cuttings planted this month in the natural ground: during the summer it must stand in some place defended from the sun, and be constantly supplied with water.

Cuttings of the Arabian jessamin may this month be planted in a sandy soil, and is more injured by wet than cold. At the time the cuttings are taken from this plant, it should be pruned to within six inches of the last year's shoot, and have fresh earth put to the roots; by which means it will shoot near a foot in the ensuing summer.

Layers of the myrtle-tree should be made this month: the youngest shoots must be bent into the earth, after it is well stirred; and being often refreshed with water, will take root, and be fit to take off from the mother-plant in the spring following. In July, the cuttings of this tree are planted, stripping off the leaves, two inches from each cutting, and setting them that depth, about an inch apart, in pots of fine light earth, watering them frequently till they have taken root, which will be about the latter end of August; and this young plantation is to remain till

the second of March before they are to be transplanted into pots. About the middle of April you may prune, and put earth about the roots of such old myrtle-trees as are in a bad state, and cut the branches off their heads within three or four inches of the stem.

The melianthus is a plant propagated with ease from slips taken about the roots any time between this month and August, planted in a sandy soil, and frequently watered.

The pyracantha is raised from cuttings, planted in May or June, in pots of fine earth, and watered frequently, keeping them from the sun till the following winter, when a warm exposure will be serviceable to them. This tree may also be raised from layers and seeds, and thrives best in a dry gravelly soil, unmixed with dung or any other rich manure.

The oleander plant has many varieties; the most common of which is the scarlet oleander, which being of a hardy nature, may be kept abroad all the winter under a south wall; but the sweet-scented oleander is more tender, and should be housed with the orange-tree. These shrubs are raised by layers in this month or the next, in a medium soil, and with moderate watering, and will take root to transplant the August following.

Orange and lemon trees may this month be removed and transplanted without danger, as well as brought out of the conservatory: upon bringing out your exotics, and other plants, brush and cleanse them from the dust they have contracted in the house, give them fresh earth on the surface of their pots, and water them well, when they are placed in the order they are to stand. When you transplant or remove orange-trees, you are to do it carefully, without injuring their bodies; let the cases for your trees be filled with a composition of two parts in sandy loam, one part rotten dung, and one part white sand; and when your orange-trees are so removed, give them frequent waterings, but without wetting either the stem or the leaves; set them in the shade for a fortnight, and let them have the sun by degrees; as, when it is too hot upon them, it turns their leaves yellow.

#### FRUIT-GARDEN.

In the beginning of this month, look carefully over your wall and espalier trees, and take off all fore-right shoots, and such as are luxuriant and ill-placed; and train such kindly branches as you would preserve regularly to the wall or espalier, which will prevent your trees from growing into confusion.

Fruit-trees may be transplanted in the summer months, from May to August, even when the trees are in blossom: the method of transplanting them is, by preparing holes for them before you begin to take them up; and the earth taken out of the holes you are to make very fine, and mix with water in large tubs to the consistence of thin batter, with which each hole is to be filled for the tree to be planted in, before the earthy parts have time to settle or fall to the bottom. A tree, thus planted in batter, has its roots immediately closed, and guarded from the air; and as the season now disposes every part of the tree for growth and shooting, it loses very little of

its vigour if you are careful of its roots, observing to wound but few of them at the taking the tree out of the ground, and not let them dry in the passage from one place to another. Though this way is of use in summer-plantations, yet in the usual winter-plantations it is pernicious, as it will then chill and rot the root of your trees.

As the cutting and wounding some roots of a tree, and among them of the capital ones, cannot be avoided, a mixture of gum has been contrived to plaster over the wounded parts of the great roots, and prevent the air and wet penetrating too much into the vessels of the roots; and if the root be very large, you may at the same time mark its corresponding limb or branch in the head, to be cut off about a fortnight afterwards in the same proportion, and then to be plastered in the same manner as the root was done before.

In the removal of trees, care must be taken that it be sudden; for if the roots are permitted to grow the least dry, we may presently discern a failure in the top-branches, which will require time to redress; for which reason, it has been thought impossible to remove a large tree to any considerable distance.

There is one convenience in this last way of planting, which is not in the common way; and that is, that the tree may be taken up without any earth about the roots, which makes the transportation more easy; and by this method, and the assistance of prepared gums, peach trees, nectarines, pear-trees, plumb-trees, and cherry-trees, with fruit upon them, either green or ripe, may be removed, though the trees are six or seven years old; and trees of all sorts may be thus transplanted in the summer.

#### KITCHEN-GARDEN.

You may now give your melons air in the middle of the day, and look to your melon-ridges, weeding them, and carefully pruning off the water-branches, which are known by their flatness and extraordinary breadth; it is also necessary to pinch off the tops of the runners that have fruit upon them, having three or four joints above the fruit, and taking care that the fruit be well sheltered with leaves from the power of the sun, otherwise their growth will be spoiled; but when the growth is perfected, you cannot expose them too much to the sun for ripening. If the season be dry, rather float the alleys between the melon-ridges, than pour water upon the plant, or near the stems.

About the beginning of this month, sow cucumbers in the natural ground, both for salad and pickling: in sowing those for salads, put about twelve seeds in each hole; but leave only four or five when they come up; let the earth be fresh, and well worked with a spade, rather light than stiff; and a plantation of this kind will produce twice as much fruit as one of the same quantity of ground forced with dung.

To raise cucumbers for pickling, sow them in a drill, as you do pease or French beans; and put a row of bushy sticks on each side of them: the rows must be four or five feet asunder; and if sowed in the south border, where

where there is a vacancy, and nailed against the wall, they will grow straiter and finer flavoured than those on the ground.

Replant imperial and Silesia lettuce: sow some of the white and brown Dutch cos-lettuce, to be planted out for cabbaging in June: sow radishes and endive very thin, to be branched without transplanting; and you may also sow purslane and cabbage-seed; transplant cauliflowers; make your first drills for sellery, if your plants are large enough. Plant out cabbages and beet-chard; and you may yet sow thyme, sweet marjoram, and gilly-flowers.

You should now be very careful to destroy weeds before they shed their seeds; destroy also the nests of caterpillars and other insects which annoy your trees; prune off all crumpled leaves, for they harbour the worst of vermin; and if the weather be dry, water new planted trees, asparagus, &c.

## J U N E.

### FLOWER-GARDEN.

THE leaves of the saffron crocus appear as soon as the flower is past, and remain all winter, which in the spring should be tied together in knots to help the increase of the roots; and these will be fit to remove or transplant about Midsummer. This plant delights in chalky ground, but it will prosper also in a sandy soil; and the pistillum contains the saffron used in medicine. The roots of the several kinds of crocus may be taken out of the ground in this month, and replanted with other bulbs; they love a light soil, and may be increased by off-sets.

The cyclamen is propagated from seeds sown as soon as ripe, in a light soil, and transplanted in Midsummer when their leaves are decayed; and it is a general rule, that all bulbs may be safely transplanted, when their flowers and leaves are decayed.

The colchicum thrives best in a sandy soil, and will only bear transplanting about Midsummer, when the roots are entirely at rest. There are many sorts of aloes, the most common whereof are brought from America; but Africa produces the greatest variety, where they grow upon rocky ground; therefore the earth proper for them is to be made with one half sandy soil, and the other rubbish of old walls, mixed and sifted together; you should plant them shallow in the pots, raising the earth about them, so that the plant may, as it were, stand on a hill; and when you water them, do it without touching any part of the plant, otherwise they will be in danger of rotting; the off-sets of the aloe may be planted in the latter end of this month, and the beginning of July, when they should be suffered to stand abroad for about nine days; and they may be helped with a hot-bed as soon as they begin to take root; if the weather be fair while the aloes are abroad, their earth being dry, will require watering once a week; and from the time of their being housed till the middle of October, gentle refreshments may be given them while the sun is upon them in the morning; but from October to March, they must be kept very dry. In May they should be transplanted,

without disturbing the roots; the seeds of many kinds of aloes ripen in Britain, and may be sown in April upon hot-beds. The fritillaria is propagated by planting their branches in a natural bed of earth any time between June and August, and they will soon be fit to plant into pots; they succeed best in the same sort of earth as the aloe.

The Indian fig is raised by planting its leaves singly about two inches deep, in pots of earth composed of lime, rubbish, and sandy soil, after their wounds are dried, and letting them stand abroad till they take root, and then they may have the help of the hot-bed; you must give these plants a good deal of the sun, and the leaves should be planted during the summer-months.

### FRUIT-GARDEN.

THE inoculation of fruit-trees now demands the attention of the gardener, and the following is the most approved method of performing the operation. About Midsummer take off a vigorous shoot from any tree you would propagate; and after having made choice of a stock of about three or four years growth, in a smooth part of it make a downright slit in the bark, a little above an inch in length, and another crosswise at the top of that, to give way to the opening of the bark; then gently loosen the bark from the wood on both sides, beginning at the top; which being done, cut off your bud with a penknife, entering pretty deep into the wood, as much above as below the bud, to the length of the slit in the stock: after the bud is thus prepared, take out the woody part of it (carefully preserving the eye of the bud) then put it in between the bark and the wood of the stock at the cross slit, putting it downward by the stalk, where the leaf grew, till it exactly closes; then bind it about with coarse woolen yarn, the better to make all parts regularly close, and the bud incorporate with the stock: in three weeks time the bud will be incorporated with the stock, when you must loosen the yarn, that it may not gall the place too much: the quicker this operation is performed, the better; and you must put two buds into one stock, in inoculating nectarines and peaches. If the buds inoculated this month do not hit, you may make another attempt in the same year, and on the same stock. The proper time for inoculating is from the beginning of this month to the latter end of August; and care must be taken that the branch and shoot made choice of for inoculation, do not lie by, but that they be used as soon as cut.

You may upon one tree, bud peaches, nectarines, apricots, plumbs, and almonds.

### KITCHEN-GARDEN.

KIDNEY-BEANS, radishes, lettuces for cabbaging, and endive, may now be sown; as may also the large sort of peas, about five or six inches apart, allowing three or four feet distance between the lines, and they will in September afford a good crop.

Replant cabbage-lettuces; transplant-leeks in light rich ground, and at six inches distance from each other; and if the weather be dry, you may gather herbs for drying a-

gainst the winter, such as lavender, rosemary, sage, mint, sweet marjoram, thyme, &c.

Take especial care to preserve your plants from the scorching sun; stir up stiff ground; continue to destroy weeds; and give your plants gentle waterings about their extreme fibres, which should be done at the close of day.

## J U L Y.

### FLOWER-GARDEN.

THERE is little to be done in the flower-garden this month: the berries of the coffee-tree which are now ripe, may be sown, first cleaning their seeds from the pulp, in pots of fine earth, about an inch deep; and if you give them the help of a hot-bed, in less than six weeks time they will sprout.

The fruit of the ananas being ripe in this month, if you cut off the crown of the leaves which grows on the top of it, and plant it in a light sandy earth, it will, with the assistance of a hot-bed, presently take root.

Anemony seeds, now sown, must be sprinkled with water frequently and gently.

### FRUIT-GARDEN.

THE management of the vine should this month be chiefly attended to: it is to be observed, that from a vigorous shoot of a vine already once pruned, there will push again several Midsummer shoots weaker than the former, from the first, second, and third bud towards the extremity; which shoots are to be taken off, only remembering that it is proper to spare the last of such shoots so far as to leave one bud upon it, from whence, in Autumn, nature may a third time exert herself; for if those shoots were all entirely removed, the vine would push at those bearing buds which lie at the bottom of the shoots; in consequence of which, there would be either a want of fruit at those places next year, or a necessity of pruning the branch shorter than was intended, or is in the winter convenient.

There is no danger in exposing the grapes this month to the sun; for though the vines appear thin of wood and leaves, the Autumn shoots will recover that fault.

Put nets over your grapes to preserve them from the birds; and you should also guard against wasps and other insects, which now destroy the peaches, apricots, and other fruit; by placing phials of honey and ale near the trees, you may soon entrap a great number of them.

### KITCHEN-GARDEN.

You may now sow kidney-beans, and some peas, to bear in September and October; sow cucumbers upon a bed made with dry horse-litter, and covered with light earth ten inches thick; they must be covered at night in September with a common frame and glass, to keep them from frost and rain, and by this method you may have some cucumbers till Christmas.

Make a bed for mushrooms as directed in February; and be sure to cover it very thin with earth.

About the middle of this month sow royal Silisia, and brown Dutch, white goss, and other sorts of lettuces, chervil, carrots, and turnips.

Plant cabbages, and favoys; transplant endive for blanching against winter; earth up fellery in drills, and plant out a new crop to succeed the former; take up shallots, garlick; and water plentifully all herbs that are feeding.

## A U G U S T.

### FLOWER-GARDEN.

THE tulip-tree being a plant of the wood, should be among such trees as are designed for groves, where it will rise to a great height: the seeds of this tree come from Virginia, and are to be sown in pots this month, and sheltered the winter, and they will come up all in the spring following.

At two years growth the young plants may be transplanted into single pots, and must have shelter in the winter for the first nine years at least, till they have gathered strength enough to resist the severity of the frosts, when they may be planted in the natural ground, rather a sandy soil than any other.

The iris flower has many varieties, some with bulbous and some with tuberosus-roots: the roots of the bulbous iris may be taken up as soon as the leaves begin to wither, and planted in August; and they may be increased by off-sets taken from their roots when their stalks are decayed: the best of the tuberosus kind is the the chalcedonian iris, commonly called the toad-flag, which requires a warm and rich soil, and must be carefully ordered, or it will not thrive well.

The narcissus, or daffodil, is a flower of a hardy nature, and thrives greatly in any ground; these flowers are propagated from off-sets from their roots, planted in this month, and may be raised by seeds sown in September, which will produce great varieties: the seedling plants are to remain without removal two or three years, when they are to be taken up in June, and replanted in good ground at a proper distance.

The jonquil is of the same kind with the daffodil, and flowers much about the same time; the roots, which are bulbous, are to be taken out of the ground, and replanted like other bulbs.

The bulbous violet, or snow-drop, is reckoned amongst the daffodils, and is one of the earliest flowers in the spring.

You may now plant off-sets of the hyacinth, in beds of sandy soil; the tuberosus hyacinth is a plant of an aspiring head, and very tender nature; the roots of it must be taken up in April, and replanted in pots of prepared earth; and, like other shrubs, it requires the assistance of a hot-bed: you may take up the bulbs of this plant in September, and preserve them in dry sand.

This is the proper time for parting the roots of the lily, which succeeds best in an open sandy soil: the striped

ped white lily is so great a rarity as to deserve a place in the nicest garden, and the orange-lily is a proper companion for it; the lily of the valley is easily raised from plants, and thrives best in shady ground.

The crown-imperial may be raised from seeds, but is commonly propagated from off sets that spring yearly from old roots, which are to be taken up in June when the stalks are dry, and replanted in August.

The work to be done this month, in the fruit and kitchen-garden, is the same as directed in the preceding month.

## S E P T E M B E R.

## FLOWER-GARDEN.

THE tulip is propagated in the following manner: the stems of this flower being left remaining upon the root, will perfect their seeds about July, which will be fit to gather when the seed-vessels begin to burst; and then they are to be cut close to the ground in a dry day, and laid in some dry place till September, when they are to be sown, in a soil composed of natural black earth and sand; and after their second appearance above ground, they may be taken from the pots they were sown in, and put in a bed of natural sandy soil, well sifted, where the thickness of half an inch of the same earth should be spread over them; and thus they are to continue, without any other culture than every year adding half an inch for their covering, till they begin to blow, which will be in five or six years time: in this manner tulip-seeds are every year to be sown for new varieties.

In planting tulips, all the forward blowers should be planted in a bed together; and of the late flowering tulips the tallest sorts should be placed in the middle line of the bed, with two rows of the shorter on each side.

Tulips planted in this month need no shelter till March, when, the flower buds appearing, they should be defended from blights with mats, or other covering; which covering will also serve to shelter them, when blown from the too powerful heat of the sun, and pernicious damps.

There are two classes of tulips; the præcocc tulips or early blowers, and the serotine or later blowers; and these are distinguished by their double and single flowers: they have also different denominations, from their colour and stature, as bagats, which are the tallest flowers, commonly purple and white marbled: agates, which grow shorter, and are veined with two colours; and beazarts, which have four colours, tending to yellow and red, of several sorts.

You may now take up the roots of the peony, part and plant them; they will prosper in any soil.

The seed of the mullein may now be sown, in a sandy soil, and a shady part of the garden; it is a beautiful plant, and blossoms four feet high.

Violets are increased by transplanting their runners either in this month or in February, which will of themselves take root at every joint; they thrive best in a binding soil, shady situation, and should be planted in the most rural parts of the garden.

You may now increase daisies by parting their roots; and they make very pretty edgings for flower beds.

Layers of the honeysuckle may now be put down; they thrive best in the shade, and are most easily trained up in pots.

There are seven sorts of the jessamine: the common white, the yellow, and the Persian jessamine, are propagated from layers or cuttings, and will grow in any soil; the layers are made in this month, and the cuttings may at the same time be planted, which should always be a foot long, and two joints be under ground. The jessamine should be planted against walls or trees, or mixed in hedges. There are jessamines of a more tender nature, which require to be sheltered in the conservatory in the winter, as the Spanish jessamine, the Portugal jessamine, the Indian jessamine, and the Arabian jessamine: these are propagated by grafting on the common white jessamine in March, or by inarching in May, or cuttings planted at the same time: the inarched plants are to be cut off the middle of August following, and in February you are to cut off the branches within four or five inches of the stem; and, after they have fresh earth put to their roots, they may be set near the glasses or windows of the green-house: they succeed best in a medium soil between sand and clay, without dung, and should not be watered too frequently.

The virgin's bower is raised from layers in this month, and from cuttings also: it is of a twining nature, must be supported with stakes: it may either be planted against a wall, or set in the wilderness; and it thrives best in a light soil.

The Virginia dog-wood blossoms early in the spring; and the flowers are succeeded by red berries, which hang a long time upon the tree: the seeds are sown in pots of light earth in autumn, and they are to stand the winter in the green-house, giving them the assistance of the hot-bed the following spring.

The Virginia myrtle, which bears berries, from which is drawn the green wax whereof candles are made, is propagated by sowing the berries in pots of black sandy earth, which should be kept continually moist.

The saffras-tree is a plant of Virginia, which loses its leaves in winter, and in the spring puts forth its yellow flowers in clusters, which are succeeded by blue berries, like those of the laurus tinus; these berries are sown in autumn, in a sandy soil.

You may now make layers or slips of the box tree; and the seeds may be sown as soon as ripe, or laid in sand during the winter, to be sown in the spring following; this plant thrives best in a chalky soil.

The dwarf or Dutch box, is of great use for edging of flower-beds, or making scroll-works; it will remain good, without renewing, a long time; and so great is the increase of it, that being earthed up every year, in four or five years after the planting, it may be taken up, parted, or slipped, and be made to plant four times the ground it stood upon.

## FRUIT GARDEN.

You may now gather the different sorts of fruit as they ripen; for those which are in eating this month, seldom continue long good.

Transplant

Transplant strawberries, gooseberries, raspberries, and currants, towards the end of this month, if the weather proves moist, otherwise it will be better to defer it till the beginning of the next month; and this is the best season to plant cuttings of gooseberries and currants, which will take root, and make better plants than those which are propagated by suckers.

Your fruit-trees against the wall of your forcing-frame, must now be pruned and trained close to the wall or espalier, that their buds may be preparing before the season for applying the heat; and you should also prepare for the ground where the fruit-trees are designed to be planted the next month, that it may lie to mellow and sweeten.

#### KITCHEN-GARDEN.

Sow Spanish radishes for the winter, and spinach to be cut in February; make plantations of the Dutch brown lettuce to stand the winter; sow sorrel, chervil, and small herbs for sallads, in some well-exposed place, observing to provide such mixtures for this season as are hotter to the taste, than in the former months.

You may now replant endive, and all sorts of fibrous-rooted herbs; continue to earth up fellery; raise the banks of earth about chardones for blanching; transplant asparagus-roots; make plantations of cabbages and coleworts; transplant young cauliflower plants in places where they are to flower; transplant strawberries; make beds for mushrooms; cover mushrooms sown in July every night; earth up your winter-plants; prepare composts; and, if the weather be dry, water your plants and herbs in the morning, and give your turnips the first houghing.

Such cucumbers as are now ripe, must be cut open, and the seed or pulp taken out of them, which should lie three or four days together before they are washed, and ten days in the sun before it is laid up; and it should ever be observed, that if seeds are not thoroughly dry before they are laid up, they will rot, and be good for nothing.

#### O C T O B E R.

##### FLOWER-GARDEN.

You should now plant anemones, and ranunculuses; and as soon as they appear, defend them from winds and frosts, with saw-dust, dry straw, or mats; and make an end of putting tulips into the ground: and likewise put *h* acinths, tulips, narcissuses, &c. in glasses made for that purpose, to blow early in the house.

Continue to transplant and lay roses, and such like flowering shrubs; and to plant the cuttings of jessamines and honeysuckles in shady borders. Sow the berries of yew, holly, and other evergreens, prepared in earth or sand; and prune these kinds of plants if the season be mild.

This is a proper time to remove your ananas or pine-apples out of the bark-beds into the stove; and always keep a tub of water in the stove to water them when it is

wanted, which should stand twenty-four hours before it is used.

Set your pots of carnations, which are now blowing, into your green-house near the door; and the beginning of this month you are to house your myrtles, amomum Plinii, melianthus, and such tender greens as remain yet abroad. Tie up those plants that grow disorderly, and place the aloes, torch-thistles, euphorbiums, &c. nearest the sun; and the other plants, which are more hardy, towards the back of the house.

When you water your housed greens, let it be in the morning, when the sun shines upon them; but you are to give no more waterings to your tender succulent plants after the middle of the month.

The windows of the green-house are to be kept open day and night till about the fifteenth of this month; after that, in the day-time only.

##### FRUIT-GARDEN.

You may now plant peaches, apricots, and other fruit-trees; and as nothing is more prejudicial to them than dung, this should be done in untried earth.

Should this month be a wet one, you must raise the borders, and the trees planted high; for it is certain death to peaches and apricots, to stand where the water stagnates in the winter.

Vines should now be planted against walls seven or eight feet asunder, in a soil composed of sea coal ashes, drift sand, or the rubbish of old buildings, with an equal quantity of natural earth mixed with rotten dung.

About the middle of this month sow cyder-pressings in beds of fresh earth, to raise stocks for grafting, or even making of orchards without grafting; and from a nursery of this kind we may have as many different sorts of apples as we raise plants, although the seeds come all from the same tree.

You may now have plantations of apples, grafted upon paradise stocks, in pots; they will bear when the trees are very small, and very greatly set off an entertainment, being placed growing upon a table among dishes of fruit.

Transplant trees of all sorts, and lay up acorns and mast in sand; lay bare the roots of old unthriving forward blowing trees; stir up new-planted ground; and lay in a good stock of untried earth to be ready upon all occasions, for fruit-trees, ever-greens, and flowers.

##### KITCHEN-GARDEN.

This is the proper season to lay up roots for winter-store, such as carrots and parsnips; take the roots of turnips out of the ground, and lay them up in sand; make plantations of currants and gooseberries, from the suckers or cuttings.

The first week of this month sow cucumbers on the natural ground, to be afterwards transplanted into pots, for the convenience of sheltering from cold nights, till a hot-bed is prepared for them. This is better than to begin after the usual method in December or January.

Make plantations of lettuce, for winter-use: transplant cabbages

cabbages and cauliflower plants. Take up those cauliflower plants which begin to flower, tie their leaves together, and bury their roots and stalks in sand, in a cellar, or some cool place. Cut artichokes with long stalks, and preserve them in the house by setting their stalks in sand. Earth up and dress such artichokes as have done blowing: and continue to earth up fellery for blanching.

Sow kidney beans in baskets under a south wall, to be afterwards forwarded by hot-beds, for early beans; and hot-spur peas, and Spanish beans, in some well exposed border, under a wall or a hedge. Sow also radishes in some warm place, to draw early in the spring; and cresses, lettuce, mustard, spinach, &c. upon a decayed hot-bed: Put likewise some roots of mint upon a gentle hot-bed for winter fallads.

## N O V E M B E R.

### FLOWER-GARDEN.

You may now cut down the stalks of such tall blowing flowers as have done blossoming, within three inches of the root. Tie up all trees and shrubs to stakes, otherwise by their being loose, and at liberty, the winds will destroy them. Lay up heaps of earth for your several sorts of flowers, and make the proper mixtures for exotics; observing, that where the ground is too stiff, it may be brought to a state of loam, by adding to it a sufficient quantity of drift or sea-sand.

Peonies, and some fibrous roots, may now be planted. If the weather be open, you may yet transplant roses, jessamines, honeysuckles, syringa, and lilac. Unnail your passion-trees from the wall, and lay them upon the ground, that in case of severe frosts they may be covered with straw.

Plant hyacinths, jonquils, narcissus's, and polyanthus's, in pots, and plunge them into hot-beds, to blossom about Christmas: lay down your auricula pots upon their sides, the plants towards the sun, to drain them from moisture, and preserve them from frosts; and shelter young seedling bulbs from the frost, but give them daily airings.

### FRUIT GARDEN.

THE business of this month being principally planting, it may be necessary to give the reader directions for bringing fruits to perfection in the winter, so as to have, by a particular management in planting, ripe fruit throughout the year.

Apricots, cherries, early peaches, nectarines, currants, gooseberries, are to be planted in the following manner, against a paling of five feet high: the stakes to support this paling must be set about four feet distance from one another; to which you are to nail whole deal-boards of twelve feet long, well-jointed to one another, and ploughed on the edges, so as to set in laths, that thereby the steam of the dung, which is to lie at the back, may not get among the plants; because wherever such steam comes, it will cause mildews.

The deals are to be an inch in thickness; for if they

are not quite so thick, the trees will be apt to be scorched upon the first application of the hot dung; and if they are thicker, the artificial heat applied to their backs, upon the time it begins to decline, will not be powerful enough to warm thoroughly, and then the dung must be oftener refreshed.

When the paling is up, you are to mark out a border on the south side of it, about four feet wide; and on the outside of the border, fasten to the ground, in a straight line, some scantlings of wood about four inches thick, to rest glass lights upon, which are to slope back to the paling, to shelter the fruit as occasion requires: between these glass-lights, there must be bars cut of whole deal, about four inches wide, for the glasses to rest upon; and the bars must always remain fixed, as in a frame for a hot-bed.

There must be a door, shaped to the profile of the frame, at each end, to be opened, either the one or the other, as the wind happens to blow, ever observing that the door be opened on that side only which is most free from the wind.

You may plant fruit-trees in a frame of this sort the same summer it is made, and the trees will take very good root before winter, and be so well stored with sap against the following spring, that they will shew no sign of their removal, but bear extremely. Besides, by this summer planting, the trees seldom or never throw away their strength in autumn-shoots, or make any attempts towards it, till September and October, when the frosts prevent their design.

The trees planted must have time allowed for the juices to digest, before you begin to force them: therefore the hot dung is not to be applied to the back of the paling before November.

About the middle of this month, or towards the end, is the time to bring ripe cherries in February: and at the same time likewise the heat may be used for apricots, so as to make the masculine apricots as large as duke cherries by February, and ripen them the beginning of April. The Anne peach will ripen about the end of April, as will also several sorts of forward plumbs.

The early nectarine thus forced will ripen with the masculine apricot: we may have green gooseberries fit for tarts in January and February; and ripe gooseberries and currants in March and April; but cherries do not bear this alteration in nature so well.

The grapes that do best for this sort of work, are, the royal muscadine, marlmore, black sweet water, and black morillon: the best sorts of the forward peaches, nectarines, cherries, and plumbs, and the Dutch raspberry, should be ever fixed on for forcing in the above manner. A row or two of strawberries may also be planted in this frame, which would ripen at the end of February, or beginning of March; and amongst the fruit you may mix here and there a monthly rose tree; and have a border planted with early tulips, hyacinths, jonquils, narcissus's, and other flowers, which by the forcing heats would make a kind of summer all the winter.

The trees planted in these frames must be close to the paling, contrary to the methods of planting against walls;

for the roots will run under the pales, and draw nourishment equally from the earth about them; but with walls it is otherwise.

The trees need not be planted at a greater distance than four or five feet; and those that have stood seven or eight years against walls, may be removed to these forcing-frames without any danger: as to pruning these trees, the same method is to be followed as recommended for other trees in February; but the season for doing it is not the same; for in the forcing frames our spring begins in November; but in the other case it does not begin till the end of January, or beginning of February.

The trees are to be pruned and nailed to pales about a week before the forcing heat is applied, and all the glasses put up as soon as they are pruned.

The hot-dung intended to be laid at the back of the pales, should be tossed up in an heap some days before it is used, that it may yield an heap every where alike: when it is fit to be applied to the pales, lay it four feet wide at the base; and let it slope to two feet at the top, the height in all being at first within four inches of the top of the pales, and in about six weeks time it will sink to four feet, when you are to apply fresh dung. The blossoming of the tree is very much helped by covering them with the glass lights in frosty weather: but they should not be denied the rain, if the weather be tolerably mild, till the buds begin to stir; after that, the glasses to remain over them constantly, till the sun begins to have some power.

When the sun shines warm, and the wind is not too sharp, give the air at the front of your frame; and if this does not happen during a fortnight's space, then give air at the end, and put up mats or canvases to correct the winds, and cause the air to circulate in the frames.

About three changes of dung will be sufficient to bring your cherries to ripeness in February, allowing each parcel to remain a month at the back of the pales: but if April proves cold, the forcing heat is to be continued till May, for plumbs, peaches, nectarines, and apricots.

#### KITCHEN-GARDEN.

HOT BEDS for asparagus should now be made; also gentle hot-beds for the cucumbers and kidney-beans sown in October: continue to sow radishes, lettuce, cresses, spinach, &c. on a hot-bed; and if your nursery is without roots, provide them from some old plantations.

Sow pease, and beans of the hotspur and Spanish kinds, in open ground; and if the weather be fair, earth up those sown in September. Earth up sellery, and tie up endive plants for blanching: and this is the best time to cut down asparagus haulm, when it is turned yellow; it must be cut within two or three inches of the ground, and the earth of the alleys flung up upon the beds; or if the asparagus be worn, you are to give it a covering of rich dung, not quite rotten: and cover well your artichokes with long dung, to defend them from frosts, otherwise they will be destroyed in a severe winter. House, and cover with sand, carrots, parsnips, &c. and house-cabbages.

You must now trench your ground, and lay it up in

ridges to mellow; and in a frosty season wheel on dung and other manures upon such places as want to be enriched.

Plants are to be guarded against frosts, and sheltered against cold rains; and trees must be staked, to defend them against violent winds, common in this month.

## D E C E M B E R.

#### FLOWER-GARDEN.

You should now cover the beds of choice anemones, hyacinths, and ranunculus's; pick off dead and rotten leaves from all exotic plants; lay mulch about the roots of new-planted trees and shrubs; cover the pots of seedling flowers; turn over the earth prepared for the flower garden, that the frost may make it mellow; and mix up some new heaps, that there may be a sufficient quantity ready for use eight or ten months before it is wanted.

You must not be too hasty in warming your green-house with artificial heats, but let in as much sun as possible, which being a natural heat, is the most agreeable to your tender plants. The chief business is to keep out frosts; to effect which, the doors and windows of your green-house must be well matted, and guarded from the piercing air.

But as no plant can live without air, therefore to recruit it in the house, and feed the plants therewith without pinching them, it is advisable, that at the end of your green-house there should be an antichamber, through which you are to pass to the house; which chamber will have fresh air from abroad every time you go into it; and upon opening the door of it into the green-house, the air will there mix with the other that has been pent up, and impregnate it with new parts, by which means, it will contribute to the vegetation of plants, without coming upon them too suddenly.

#### FRUIT-GARDEN.

CONTINUE to prune vines; prune and nail wall-fruit trees, also such standards as are hardy; examine orchard trees, and take away such branches as make confusion; covering every considerable wound with a mixture of bees wax, rosin, and tar, in equal quantities, and of tallow about half the quantity of any of the others; which are to be melted together in an earthen vessel well glazed; and, with a painting brush dipped into it, the wound is to be covered: destroy snails in every part of your garden; and you may, if the weather proves mild, remove or plant most sorts of hardy trees that in the winter shed their leaves.

#### KITCHEN-GARDEN.

If the season proves mild, you may earth up those artichokes which were in the former months neglected; in doing which, if the ground is not very good, bury some rotten dung in it, which will greatly promote the growth of your artichokes in the spring following.

Towards the middle of the month, make a hot-bed for asparagus,





*Fig. 1. SEA GAGE*



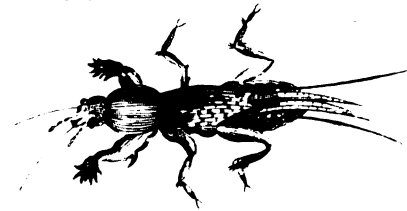
*Fig. 5.*  
GRYLLUS LAURIFOLIUS



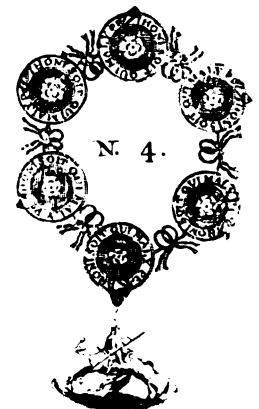
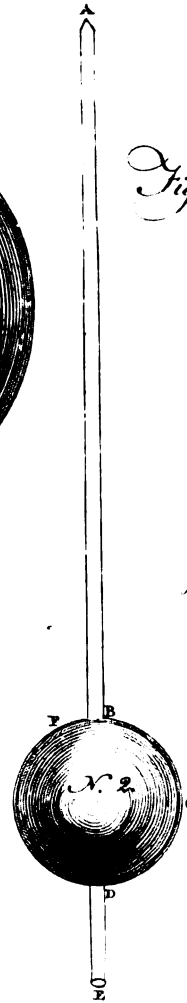
*Fig. 4.*  
GRYLLUS ACUMINATUS



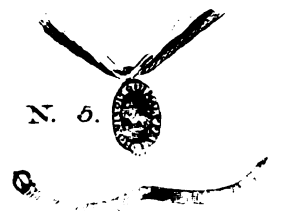
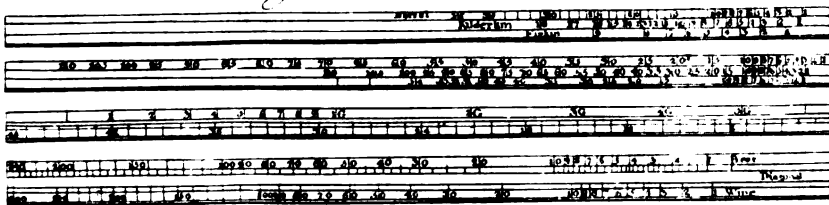
*Fig. 6.*  
GRYLLUS GRYLLOTALPA



*Fig. 2. Order of the GARTER.*



*Fig. 3. GAUGING ROD.*



asparagus, in like manner as that made in November. Sow upon hot-beds, lettuce, radish, cresses, mustard, and other herbs which are hot, to cut for small fallads.

In open weather you may sow early peas and beans of the same kinds, and in the same manner, as directed in November and the preceding months; and as vermin now very much destroy your roots and seeds, you are to set traps to catch them.

You should, when the weather is not too severe, uncover the cauliflower plants every day, that they may enjoy

the benefit of the air, otherwise they will be very weakly; and in dry weather take up sellery, and endive to blanch.

Great care must now be taken of the mushroom-beds; they should be covered with fresh dry straw, so thick as to keep out the wet; for as, where proper care is taken, there will be a constant supply of them for the table in the most rigorous season, so, when they are neglected, the produce will be small in proportion.

## G A R

**GARGARISM**, in medicine, is sometimes taken, in a large sense, for every collution of the mouth; but, strictly speaking, it signifies a liquid medicine, appropriated to affections of the mouth, gums, fauces, larynx, and sometimes of the head, received into the mouth, and there used by way of collution, without deglutition.

**GARLAND**, a sort of chaplet made of flowers, feathers, and sometimes precious stones, worn on the head, in manner of a crown.

**GARLAND** also denotes ornaments of flowers, fruits, and leaves, intermixed; anciently much used at the gates of temples, where feasts and solemn rejoicings were held; or at any other place where marks of public joy or gaiety were required, as at triumphal arches, tournaments, &c.

**GARNET**, in natural history, a very beautiful gem, of a red colour, with an admixture of bluish.

When pure and free from blemishes, it is little inferior, in appearance, to the oriental ruby, though only of a middle degree of hardness between the sapphire and common crystal. It is found of various sizes, from that of a pin's head to an inch in diameter.

Among our lapidaries and jewellers, genuine garnets are known by different names according to their different degrees of colour. 1. The garnet, simply so called, is the finest and most valuable kind, being of a very deep blood red, with a faint admixture of blue. 2. The rock-ruby, a name very improperly given to the garnet, when it is of a very strong but not deep red, and has a fairer cast of the blue: this is a very beautiful gem. 3. The serane or serain garnet, that of a yet brighter red, approaching to the colour of native cinnabar, with a faint blue tinge. 4. The almandine, a garnet only a little paler than that called the rock-ruby.

Garnets are very properly distinguished into the oriental and occidental kinds, as being found in Europe as well as the East Indies. The oriental ones are principally brought from Calicut, Cananor, and Cambay; and the European ones are common in Italy, Hungary, and Bohemia.

Some authors have supposed the deeper-coloured garnet to be the same with the carbuncle of the ancients; from which it really differs; since, on receiving the sun's beams, it never gives so true a fire-colour as the carbuncle.

**GARONNE**, a large river of France, which taking its

## G A R

rise in the Pyrenean mountains, runs north-west by the city of Tholouse, divides the provinces of Guienne and Gascony, and, visiting the city of Bordeaux, falls into the bay of Biscay, about sixty miles below that city. It has also a communication with the Mediterranean, by means of the royal canal of Lewis XIV. The tide flows up this river twenty miles above Bordeaux.

**GARTER**, a ligature for tying up the stocking; but particularly used for the badge of a noble order of knights, hence denominated the

*Order of the GARTER*, a military order of knighthood, the most noble and ancient of any lay-order in the world, instituted by Edward III. This order consists of twenty-six knights-companions, generally princes and peers, whereof the king of England is the sovereign or chief. They are a college or corporation, having a great and little seal.

Their officers are a prelate, chancellor, register, king at arms, and usher of the black rod. They have also a dean with twelve canons, and petty canons, vergers, and twenty-six pensioners or poor knights. The prelate is the head. This office is vested in the bishop of Winchester, and has ever been so. Next to the prelate is the chancellor; which office is vested in the bishop of Salisbury, who keeps the seals, &c. The next is the register, who by his oath is to enter upon the registry, the serutinies, elections, penalties, and other acts of the order, with all fidelity. The fourth officer is garter, and king at arms, being two distinct offices united in one person. Garter carries the rod and sceptre at the feast of St George, the protector of this order, when the sovereign is present. He notifies the elections of new knights, attends the solemnity of their installations, carries the garter to the foreign princes, &c. He is the principal officer within the college of arms, and chief of the heralds. See *KING at arms*.

All these officers, except the prelate, have fees and pensions. The college of the order is seated in the castle of Windsor, with the chapel of St George, and the charter-house, erected by the founder for that purpose. The habit and ensign of the order are, a garter, mantle, cape, george, and collar. The four first were assigned the knights-companions by the founder; and the george and collar by Henry VIII. The garter (Plate LXXXVI. fig. 2. N<sup>o</sup> 1.) challenges pre-eminence

nence over all the other parts of the dress, by reason that from it the noble order is denominated; that it is the first part of the habit presented to foreign princes, and absent knights, who, and all other knights-elect, are therewith first adorned; and it is of so great honour and grandeur, that by the bare investiture with this noble ensign, the knights are esteemed companions of the greatest military order in the world. It is worn on the left leg between the knee and calf, and is enamelled with this motto, *HONI SOIT QUI MAL Y PENSE*; i. e. *Shame to him that thinks evil hereof*: The meaning of which is, that king Edward having laid claim to the kingdom of France, retorted shame and defiance upon him that should dare to think amiss of the just enterprize he had undertaken, for recovering his lawful right to that crown; and that the bravery of those knights whom he had elected into this order, was such as would enable him to maintain the quarrel against those that thought ill of it.

The mantle (*ibid.* N<sup>o</sup> 2.) is the chief of these vestments made use of upon all solemn occasions. The colour of the mantle is by the statutes appointed to be blue. The length of the train of the mantle only distinguishes the sovereign from the knights-companions. To the collar of the mantle is fixed a pair of long strings, anciently wove with blue silk only, but now twisted round, and made of Venice gold and silk, of the colour of the robe, with knobs, or buttons, and tassels at the end. The left shoulder of the mantle has, from the institution, been adorned with a large garter, with the device, *HONI SOIT, &c.* within this is the cross of the order, which was ordained to be worn at all times by king Charles I. At length the star was introduced, being a sort of cross irradiated with beams of silver. (*ibid.* N<sup>o</sup> 3.)

The collar (*ibid.* N<sup>o</sup> 4) is appointed to be composed of pieces of gold in fashion of garters, the ground enamelled blue, and the mot o gold.

The manner of electing a knight companion into this most noble order, and the ceremonies of investiture are as follow. When the sovereign designs to elect a companion of the garter, the chancellor belonging to this order draws up the letters, which, passing both under the sovereign's sign-manual and signet of the order, are sent to the person by garter principal king at arms; and are in this manner, or to the same effect: "We, with the companions of our most noble order of the garter, assembled in chapter, holden this present day at our castle at Windsor, considering the virtuous fidelity you have shewn, and the honourable exploits you have done in our service, by vindicating and maintaining our right, &c. have elected and chosen you one of the companions of our order. Therefore, we require you to make your speedy repair unto us, to receive the ensigns thereof, and be ready for your installation upon the — day of this present month, &c."

The garter, which is of blue velvet bordered with fine gold-wire, having commonly the letters of the motto of the same, is, at the time of election, buckled

upon the left leg, by two of the senior companions, who receive it from the sovereign, to whom it was presented upon a velvet cushion, by garter king at arms, with the usual reverence, whilst the chancellor reads the following admonition, enjoined by the statutes: "To the honour of God omnipotent, and in memorial of the blessed martyr St George, tie about thy leg, for thy renown, this noble garter; wear it as the symbol of the most illustrious order, never to be forgotten or laid aside; that thereby thou mayest be admonished to be courageous; and, having undertaken a just war, in which thou shalt be engaged, thou mayest stand firm, valiantly fight, and successively conquer."

The princely garter being then buckled on, and the words of its signification pronounced, the knight elect is brought before the sovereign, who puts about his neck, kneeling, a sky-coloured ribbon, (*ibid.* N<sup>o</sup> 5.) whereunto is appendant, wrought in gold within the garter, the image of St George on horseback, with his sword drawn, encountering with the dragon. In the mean time, the chancellor reads the following admonition: "Wear this ribbon about thy neck, adorned with the image of the blessed martyr and soldier of Christ, St George, by whose imitation provoked, thou mayst so overpass both prosperous and adverse adventures, that having stoutly vanquished thy enemies, both of body and soul, thou mayst not only receive the praise of this transient combat, but be crowned with the palm of eternal victory."

Then the knight elected kisses the sovereign's hand, thanks his majesty for the great honour done him, rises up, and salutes all the companions severally, who return their congratulations. N<sup>o</sup> 2. (*ibid.*) exhibits a view of a knight of the garter in the habit of this order.

Since the institution of this order, there have been eight emperors, and twenty-eight kings, besides numerous sovereign princes, enrolled as companions thereof. Its origin is somewhat differently related: the common account is, that it was erected in honour of a garter of the countess of Salisbury, which the dropped dancing with king Edward, and which that prince picked up; but our best antiquaries think it was instituted on account of the victory over the French at Cressy, where the king ordered his garter to be displayed as a signal of the battle.

**GASCOIN**, or **GASCOIGN**, denotes the hinder thigh of a horse, which begins at the stifle, and reaches to the ply or bending of the ham.

**GASCONY**, the most south-west province of France, bounded by Guienne, on the north; by Languedoc, on the east; by the Pyrenees, which separate it from Spain, on the south; and by the Bay of Biscay, on the west.

**CASSENHOVEN**, or **GUTZENHOVEN**, a town of the Aultrian Netherlands, fifteen miles east of Louvain: E long. 50°, and N. lat. 55'.

**GASTEROSTEUS**, in ichthyology, a genus of fishes belonging to the order of thoraici. There are three

rays

- rays in the membrane of the gills; the body is carinated; and there are some distinct prickles before the back-fin. There are eleven species, distinguished by the number of prickles on the back.
- GASTRIC**, in general, something belonging to the stomach.
- GASTROCNEMIUS**, in anatomy. See **ANATOMY**, p. 209.
- GASTROCNEMIUS** is also the name of one of the extensor-muscles of the foot.
- GASTROMANCY**, a method of divination by water, practised by the ancient Greeks.
- GASTRORAPHY**, in surgery, the operation of sewing up wounds of the abdomen. See **SURGERY**.
- GATE**, in architecture. See **ARCHITECTURE**, p. 356.
- GATTON**, a borough-town of Surry, sixteen miles south of London, which sends two members to parliament.
- GAVEREN**, or **WAVVERN**, a town of the Austrian Netherlands, situated on the east bank of the river Scheld: E. long.  $3^{\circ} 35'$ , N. lat.  $51^{\circ}$ .
- GAUGE-POINT** of a solid measure, the diameter of a circle whose area is equal to the solid content of the same measure.
- GAUGER**, a king's officer, who is appointed to examine all tuns, pipes, hogheads, and barrels of wine, beer, ale, oil, honey, &c. and give them a mark of allowance, before they are sold in any place within the extent of his office.
- GAUGING**. See **GEOMETRY**.
- GAUNT-BELLIED**, in the menage, is said of a horse whose belly shrinks up towards his flanks.
- GAWSE**, or **GAWZS**, in commerce, a very slight, thin, open kind of stuff, made of silk, and sometimes of thread; there are also figured gawzes, and some with gold or silver flowers on a silk ground.
- GAZELLA**, in zoology. See **CAPRA**.
- GAZETTE**, a news-paper, or printed account of the transactions of all the countries in the known world, in a loose sheet, or half-sheet. This name is with us confined to that paper of news published by authority. The word is derived from *gazetta*, a Venetian coin, which was the usual price of the first news-papers printed there, and which was afterwards given to the paper itself.
- GELATINOUS**, in pharmacy and medicine, any thing approaching to the glutinous consistence of a gelatina or jelly. See **JELLY**.
- GELDERLAND**, comprehending Zutphen, is a province of the United Netherlands, bounded by the Zuider-sea and Overijssel on the north, by Westphalia on the east, by Brabant on the south, and by the province of Utrecht on the west.
- GELDING**, the operation of castrating any animal.
- GELDERS**, a city of Gelderland, situated twenty-three miles south of Nimeguen: E. long.  $6^{\circ} 8'$ , and N. lat.  $51^{\circ} 35'$ .
- GELENHAUSEN**, an imperial city of Germany, governed by its own magistrates; it is situated nine miles north of Hanau: E. long.  $8^{\circ} 50'$ , and N. lat.  $50^{\circ} 15'$ .
- GEM**, in natural history, a common name for all precious stones; of which there are two classes, the pellucid and semi-pellucid. The bodies composing the class of pellucid gems are bright, elegant, and beautiful fossils, naturally and essentially compound, ever found in small detached masses, extremely hard, pellucid, and of great lustre; composed of a very firm and pure matter, without any admixture of earthy substance, giving fire without steel, not fermenting with acid menstruums, and very difficultly calcinable in the fire. The bodies composing the class of semi-pellucid gems are, stones naturally and essentially compound; not inflammable nor soluble in water, found in detached masses, and composed of crystalline matter, debased by earth: however, they are but slightly debased; and are of great beauty and brightness, of a moderate degree of transparency, and are usually found in small masses.
- GEMARA**, in Jewish antiquity, a collection of decisions and determinations on the law, written after the Misna was completed. It was called *gemara*, or *perfection*, because it was considered as so perfect an explication of the law, that after it no further additions could be made, or any thing more desired. It is otherwise called the talmud. See **TALMUD**.
- GEMBLOURS**, a town of the Austrian Netherlands, in the province of Brabant, situated on the river Orne, ten miles north-west of Namur: E. long.  $4^{\circ} 30'$ , and N. lat.  $50^{\circ} 30'$ .
- GEMELLUS**, in anatomy. See **ANATOMY**, p. 205.
- GEMINI**, the **TWINS**, in astronomy, one of the twelve signs of the zodiac, the third in order, beginning with aries. See **ASTRONOMY**.
- GEMMA**, in natural history. See **GEM**.
- GEMUND**, a town of Germany, in the circle of Westphalia, and dukedom of Juliers, situated on the river Roer: E. long.  $6^{\circ} 15'$ , and N. lat.  $50^{\circ} 34'$ .
- GEMUND**, a town of Germany, in the circle of Swabia, and county of Rechlsberg, situated on the river Rems: E. long.  $9^{\circ} 40'$ , and N. lat.  $48^{\circ} 45'$ .
- GEMUND**, a town of Germany, in the circle of Franconia, situated on the river Maine: E. long.  $9^{\circ} 45'$ , and N. lat.  $50^{\circ} 8'$ .
- GENDARMES**, or **GENS D'ARMES**, in the French armies, a denomination given to a select body of horse, on account of their succeeding the ancient gendarmes, who were thus called from their being completely clothed in armour. The king's body-guards, the light horse of the royal house, and the musqueteers, are at present reputed to belong to the gendarmerie. The grand gendarmes are a troop composed of about 250 gentlemen, who guard the king's person. The king himself is their captain, and one of the prime peers their captain-lieutenant, who has under him two lieutenants, three ensigns, three guidons, and other officers. There are, besides these, gendarmes of the queen, the dauphin, &c.

**GENDER**, among grammarians, a division of nouns, or names, to distinguish the two sexes.

This was the original intention of gender; but, afterwards, other words which had no proper relation, either to the one sex or the other, had genders assigned them, rather out of caprice than reason; which is at length established by custom. Hence genders vary according to the languages, or even according to the words introduced from one language into another. Thus *arbor*, in Latin, is feminine; but *arbre*, in French, is masculine; and *dens*, in Latin, is masculine; but *dent*, in French, is feminine.

**GENEALOGY**, an enumeration of a series of ancestors; or a summary account of the relations and alliances of a person or family, both in the direct and collateral line.

**GENEP**, a town in the dutchy of Clevee, in Germany, situated on the Nierse and Maese, ten miles west of Clevee: E. long.  $5^{\circ} 30'$ , and N. lat.  $51^{\circ} 40'$ .

**GENERAL**, an appellation given to whatever belongs to a whole genus. See **GENUS**.

**GENERAL CHARGE**, in law. See *CHARGE to enter heir*.

**GENERAL TERMS**, among logicians, those which are made the signs of general ideas.

**GENERAL of an army**, in the art of war, he who commands in chief.

The office of a general is, to regulate the march and encampment of the army; in the day of battle to chuse out the most advantageous ground; to make the disposition of the army; to post the artillery; and where there is occasion, to send his orders by his aids de camp. At a siege, he is to cause the place to be invested; to order the approaches and attacks; to visit the works; and to send out detachments to secure his convoys.

**GENERATING LINE**, or **FIGURE**, in geometry, is that which by its motion produces any other plane or solid figure.

**GENERATION**, in physiology, the act of procreating and producing a being similar to the parent.

According to Aristotle, the male animals contain the principle, and the female the matter of generation: for though both were furnished indeed with a seminal liquor, yet the semen of the males alone was prolific. The moderns, on the other hand, as well those who contend for the system of generation from eggs, as they who adopt that of the animalcules in the male-feed, pretend that females have no such seminal liquor at all, and that what was commonly taken for it was some other animal fluid.

Harvey is of opinion, that all females are furnished with eggs, and that the embryos, or young animals, are formed in the same manner as a chick in the egg of any bird. Generation, according to this celebrated physician, is effected wholly by means of the uterus, or womb; which conceives the fœtus by a kind of contagion communicated to it by the male-feed, much in the same way as the load-stone communicates magnetism to iron. This contagion, he thinks, acts not only on the uterus, but is communicated to the whole body of the female, which is altogether prolific; tho' the uterus, he acknowledges, is the only part that is

capable of conceiving the fœtus, just as the brain is alone capable of forming ideas and notions. Agreeable to this doctrine of Harvey, Steno and other anatomists have pretended to discover certain eggs in the ovaries or testicles of women; which Mr Buffon denies to be the case, assuming, that there are no such eggs to be found in the ovaries or testicles of women.

We cannot enter into a detail of the reasonings for and against the system of generation from eggs; and shall therefore only observe, that its advocates pretend to have discovered eggs in all the females on which they made observations; that the largest of those found in women did not exceed the bigness of a pea; that they are extremely small in young girls under fourteen, but that age and commerce with men makes them grow larger; that there are more than twenty such eggs in each ovary or testicle; that they are fecundated in the ovary by the spirituous and volatile part of the male-feed; that they afterwards are detached and fall into the uterus through the Fallopian tubes; that here the fœtus is formed of the internal substance of the egg, and the placenta of the exterior part.

Leewenhock is the author of another system of generation, from animalcules in the male feed. He tells us, he discovered many thousands of these in a drop less than a grain of sand. They are found in the semen of all males whatever, but not in that of females; and are so small, that 3,000,000,000 of them are not equal to a grain of sand, whose diameter is but the hundredth part of an inch. When any of these animalcules gets into an egg, fit to receive it, and this falls into the womb through the Fallopian tubes, the humours which distil through the vessels of the womb, penetrating the coats of the egg, swell and dilate it, as the sap of the earth does seed thrown into it. The placenta begins to appear like a little cloud, upon one side of the external coat of the egg; and, at the same time the spine of the embryo-animalcule is grown so big, as to become visible; and a little afterwards, the cerebrum and cerebellum appear like two bladders; and the eyes stand next goggling out of the head; then the beating of the heart, or punctum saliens, is plainly to be seen; and the extremities discover themselves last of all.

These animalcules are of different figures, some like tadpoles, and others like eels. In the semen of a man, and in that of a dog, there have been discovered two different kinds of them, the one supposed to be males and the other females. Some even pretend to have seen animalcules disengage themselves from the membranes that surround them; and that they then appeared perfectly like men, with legs, arms, &c. like those of the human body!

All the advocates for the system of generation from animalcules strongly oppose that from eggs. They contend, that these animalcules cannot be looked upon as the inhabitants of the semen, since they were of greater extent than the liquor itself; not to mention, that no such animals are found in any other liquors of the body; and since females have nothing similar to these animals, they think it manifest that the prolific principle



*neva*. It is a republic, governed by a council of 200, and a senate of twenty five members; and is said to contain 30,000 inhabitants.

**GENEVA**, or **GIN**, among distillers, an ordinary malt spirit, distilled a second time, with the addition of some juniper-berries.

Originally, the berries were added to the malt in the grilling; so that the spirit thus obtained was flavoured with the berries from first, and exceeded all that could be made by any other method. At present, they leave out the berries entirely, and give their spirits a flavour by distilling them with a proper quantity of oil of turpentine; which, though it nearly resembles the flavour of juniper-berries, has none of their valuable virtues.

**GENIAL**, an epithet given by the Pagans to certain gods who were supposed to preside over generation.

The genial gods, says Festus, were earth, air, fire, and water. The twelve signs, together with the sun and moon, were sometimes also ranked in the number.

**GENICULI**, among botanists, the knots or joints in the stalks of plants; whence they are denominated geniculate plants.

**GENIOGLOSSI**, in anatomy. See **ANATOMY**, p. 304.

**GENIOHYOIDÆUS**, in anatomy. See **ANATOMY**, p. 304.

**GENIS**, a town of Savoy, situated on the river Guier, twelve miles west of Chambery.

**GENISTA**, **GREEN-WEED**, or **DYER'S WEED**, a genus of the diadelphia decandria class. The calix is bilabiated; the vexillum is oblong, and reflected. There are 14 species, two of which are natives of Britain, *viz.* the tinctoria, or dyer's weed; and the anglica, or needle-furze.

**GENITAL**, an appellation given to whatever belongs to the parts of generation. See **GENERATION**.

**GENITES**, among the Hebrews, those descended from Abraham, without any mixture of foreign blood.

The Greeks distinguished by the name of genites such of the Jews as were issued from parents, who, during the Babylonish captivity, had not allied with any gentile family.

**GENITIVE**, in grammar, the second case of the declension of nouns. The relation of one thing considered as belonging in some manner to another, has occasioned a peculiar termination of nouns, called the genitive case: But in the vulgar tongues, they make use of a sign to express the relation of this case. In English they prefix the particle *of*, in French *de* or *du*, &c. Though in strictness there are no cases in either of these languages; inasmuch as they do not express the different relations of things by different terminations, but by additional prepositions, which is otherwise in the Latin.

**GENIUS**, a good or evil spirit, or dæmon, whom the ancients supposed set over each person, to direct his birth, accompany him in life, and be his guard. See **DÆMON**.

The rank and office of the genii were inferior to those of the lares; for the latter were the tutelar

gods of a family, whereas the genii had the care or government only of single persons, or places.

**GENIUS**, in matters of literature, &c. a natural talent or disposition to do one thing more than another; or the aptitude a man has received from nature to perform well and easily that which others can do but indifferently and with a great deal of pains.

To know the bent of nature is the most important concern. Men come into the world with a genius determined not only to a certain art, but to certain parts of that art, in which only they are capable of success. If they quit their sphere, they fall even below mediocrity in their profession. Art and industry add much to natural endowments, but cannot supply them where they are wanting. Every thing depends on genius. A painter often pleases without observing rules, whilst another displeases though he observes them, because he has not the happiness of being born with a genius for painting.

**GENOA**, a city and archbishop's see of Italy, and capital of a republic of the same name, is built on a strand near the sea, and rises gradually to the top of a hill; the houses, which are lofty and well built, rising like the seats of a theatre, afford a fine prospect at sea. The harbour is large and deep, and the principal street, from one end to the other, resembles a double row of palaces: E. long. 9° 30', and N. lat. 44° 30'.

**GENTIANA**, in botany, a genus of the pentandria digynia class. The corolla consists of one petal; the capsule has two valves, and one cell. There are twenty-eight species, five of which are natives of Britain, *viz.* the pneumoanthe, or calathian violet; the amarella, or autumnal gentian; the centaurium, or lesser centaury; the campestris, or vernal dwarf gentian; and the filiformis, or marsh centaury.

The root of this plant is large, remarkably tough, and of a firm texture. It is brought to us from Germany, where it is in many places cultivated as liquorice is amongst us; and it is to be chosen fresh, tough, of a middle size, free from the small fibres, and well dried; tho' if it be scorched, it is to be rejected. This root is one of the best stomachics.

**GENTILE**, in matters of religion, a pagan, or worshipper of false gods.

**GENTILE**, in the Roman law and history, a name which sometimes expresses what the Romans otherwise called barbarians, whether they were allies of Rome or not; but this word was used in a more particular sense for all strangers and foreigners not subject to the Roman empire.

**GENTLEMAN-USHER** of the black rod. See **ROD**.

**GENTLEMEN** of the chapel, officers whose duty and attendance is in the royal chapel, being in number thirty-two, whereof twelve are priests; the other twenty, commonly called clerks of the chapel, assist in the performance of divine service. One of the first twelve is chosen for confessor of the household, whose office it is to read prayers every morning to the household servants, to visit the sick, examine and prepare communicants, and administer the sacrament.

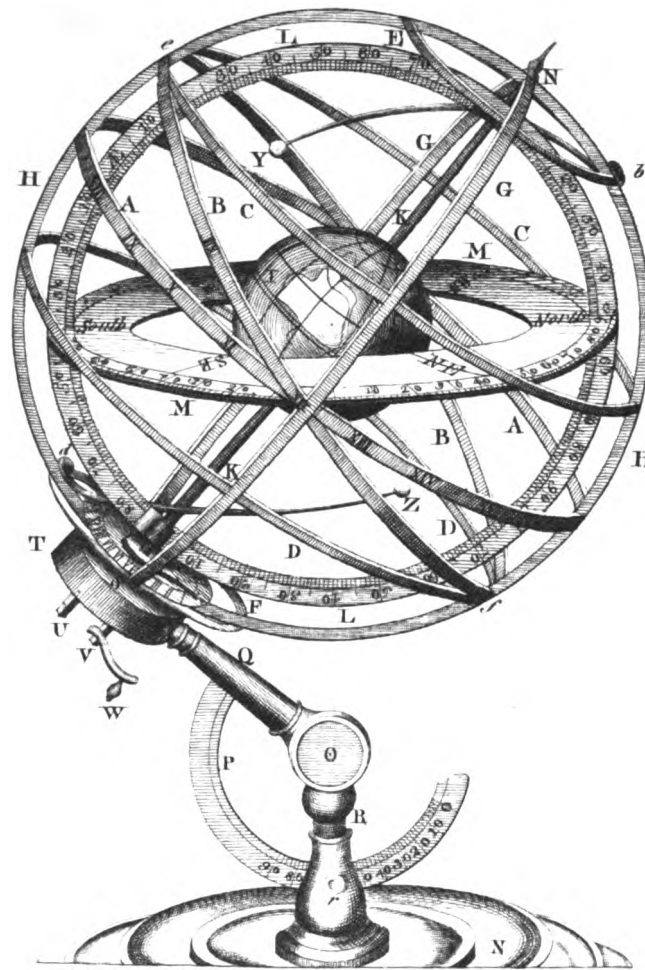
One of twenty clerks, well versed in music, is chosen first





ARMILLARY

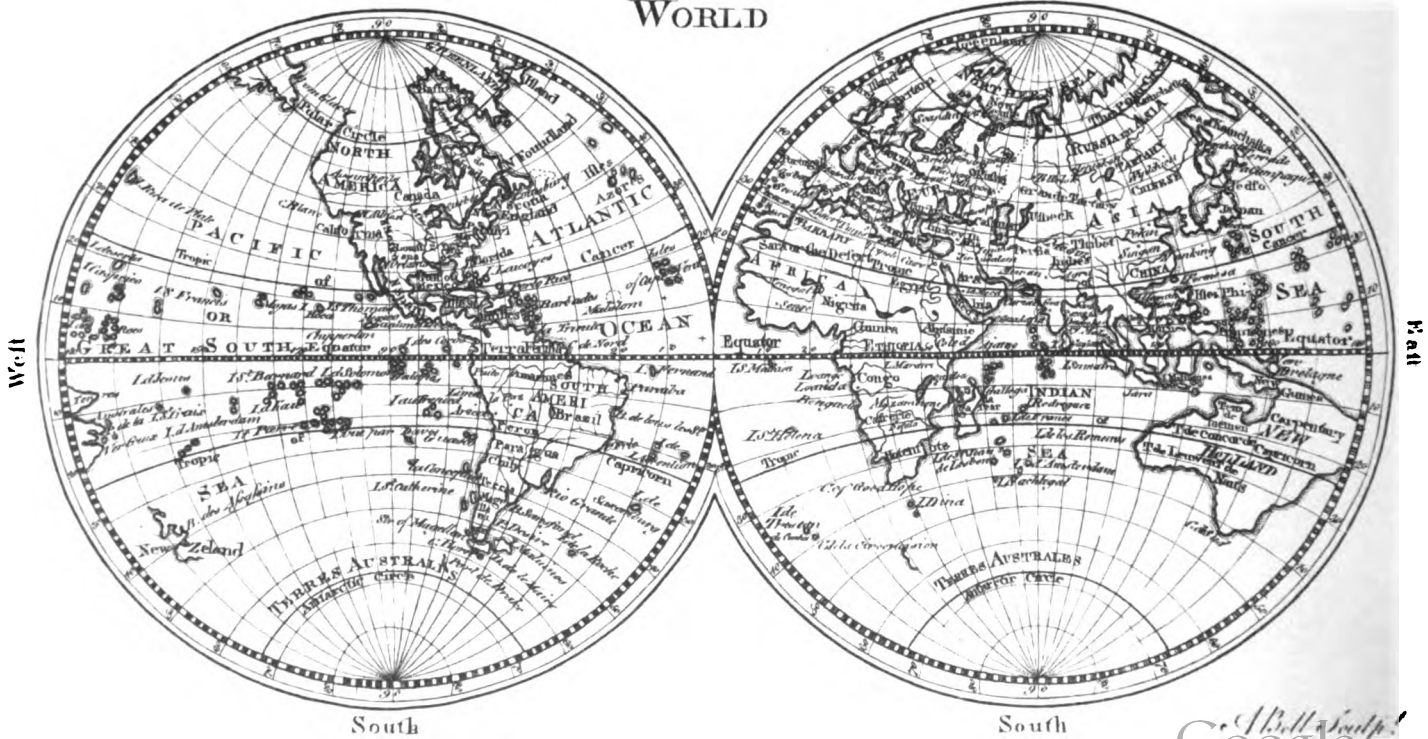
SPHERE



North

North

WORLD



South

South

first organist, who is master of the children, to instruct them in music, and whatever else is necessary for the service of the chapel; a second is likewise an organist; a third, a lutanist; and a fourth, a violist.

There are likewise three vergers, so called from the silver-rods they carry in their hands; being a serjeant, a yeoman, and groom of the vestry; the first attends the dean and sub-dean, and finds surplices and other necessaries for the chapel; the second has the whole care of the chapel, keeps the pews, and seats the nobility and gentry; the groom has his attendance within the chapel-door, and looks after it.

**GENUS**, among metaphysicians and logicians, denotes a number of beings, which agree in certain general properties common to them all; so that a genus is nothing else but an abstract idea, expressed by some general name or term.

It is plain, therefore, that by a genus we do not barely signify one particular thing, nor yet a plurality of things; but a sort or kind of things, all agreeing in certain general properties.

Thus animal is said to be a genus in respect of man and brute, in regard man and brute agree in the common nature and character of animal: so a right-lined figure of four sides, is a genus in respect of a parallelogram, and a trapezium; and so likewise is substance,

in respect of substance extended which is body, and thinking substance which is mind.

**GENUS** is also used for a character or manner applicable to every thing of a certain nature or condition: in which sense it serves to make capital divisions in divers sciences, as rhetoric, anatomy, and natural history.

**GENUS**, in rhetoric. Authors distinguish the art of rhetoric, as also orations or discourses produced thereby, into three genera or kinds, demonstrative, deliberative, and judiciary.

To the demonstrative kind belong panegyrics, genethliacons, epithalamiums, funeral harangues, &c.

To the deliberative kind belong persuasions, dissuasions, commendations, &c. To the judiciary kind belong defences and accusations.

**GENUS**, in natural history, a sub-division of any class or order of natural beings, whether of the animal, vegetable, or mineral kingdoms, all agreeing in certain common characters. See **NATURAL HISTORY**.

**GEOCENTRIC**, in astronomy, is applied to a planet or its orbit, to denote it concentric with the earth, or as having the earth for its centre, or the same centre with the earth.

**GEOGRAPHICAL MILE**, the same with the sea-mile; being one minute, or the sixtieth part of a degree of a great circle on the earth's surface.

## G E O G R A P H Y.

**GEOGRAPHY**, the doctrine or knowledge of the terrestrial globe; or the science that teaches and explains the properties of the earth, and the parts thereof which depend upon quantity.

### THE DESCRIPTION AND USE OF THE GLOBES AND ARMILLARY SPHERE.

**I**F a map of the world be accurately delineated on a spherical ball, the surface thereof will represent the surface of the earth: for the highest hills are so inconsiderable with respect to the bulk of the earth, that they take off no more from its roundness than grains of sand do from the roundness of a common globe; for the diameter of the earth is 8000 miles, in round numbers, and no known hill upon it is three miles in perpendicular height.

For the proof of the earth's being spherical, see **ASTRONOMY**, p. 440.

With regard to what we call *up* and *down*, see **ASTRONOMY**, p. 445.

To an observer placed any where in the indefinite space, where there is nothing to limit his view, all remote objects appear equally distant from him; and seem to be placed in a vast concave sphere, of which his eye is the centre. The moon is much nearer to us than the sun; some of the planets are sometimes nearer, and sometimes farther from us, than the sun; others of them never come so near us as the sun always is; the remotest planet in our system, is beyond comparison nearer to us than any

of the fixed stars are. And yet all these celestial objects appear equally distant from us. Therefore, if we imagine a large hollow sphere of glass to have as many bright studs fixed to its inside, as there are stars visible in the heaven, and these studs to be of different magnitudes, and placed at the same angular distances from each other as the stars are; the sphere will be a true representation of the starry heaven, to an eye supposed to be in its centre, and viewing it all around. And if a small globe, with a map of the earth upon it, be placed on an axis in the centre of this starry sphere, and the sphere be made to turn round on this axis, it will represent the apparent motion of the heavens round the earth.

If a great circle be so drawn upon this sphere, as to divide it into two equal parts or hemispheres, and the plane of the circle be perpendicular to the axis of the sphere, this circle will represent the *equinoctial*, which divides the heaven into two equal parts, called the *northern* and the *southern hemispheres*; and every point of that circle will be equally distant from the *poles*, or ends of the axis in the sphere. That pole which is in the middle of the northern

northern hemisphere, will be called the *north pole of the sphere*; and that which is in the middle of the southern hemisphere, the *south pole*.

If another great circle be drawn upon the sphere, in such a manner as to cut the equinoctial at an angle of  $23\frac{1}{2}$  degrees in two opposite points, it will represent the *ecliptic*, or circle of the sun's apparent annual motion: one half of which is on the north side of the equinoctial, and the other half on the south.

If a large stud be made to move eastward in this ecliptic, in such a manner as to go quite round it, in the time that the sphere is turned round westward 366 times upon its axis; this stud will represent the *sun*, changing his place every day a 365th part of the ecliptic; and going round westward, the same way as the stars do; but with a motion so much slower than the motion of the stars, that they will make 366 revolutions about the axis of the sphere, in the time that the sun makes only 365. During one half of these revolutions, the sun will be on the north side of the equinoctial; during the other half, on the south; and at the end of each half, in the equinoctial.

If we suppose the terrestrial globe in this machine to be about one inch in diameter, and the diameter of the starry sphere to be about five or six feet, a small insect on the globe would see only a very little portion of its surface; but it would see one half of the starry sphere; the convexity of the globe hiding the other half from its view. If the sphere be turned westward round the globe, and the insect could judge of the appearances which arise from that motion, it would see some stars rising to its view in the eastern side of the sphere, whilst others were setting on the western: but as all the stars are fixed to the sphere, the same stars would always rise in the same points of view on the east side, and set in the same points of view on the west side. With the sun it would be otherwise, because the sun is not fixed to any point of the sphere, but moves slowly along an oblique circle in it. And if the insect should look towards the south, and call that point of the globe, where the equinoctial in the sphere seems to cut it on the left side, the *east point*; and where it cuts the globe on the right side, the *west point*; the little animal would see the sun rise north of the east, and set north of the west, for  $182\frac{1}{2}$  revolutions; after which, for as many more, the sun would rise south of the east, and set south of the west. And in the whole 365 revolutions, the sun would rise only twice in the east point, and set twice in the west. All these appearances would be the same, if the starry sphere stood still (the sun only moving in the ecliptic) and the earthly globe were turned round the axis of the sphere eastward. For, as the insect would be carried round with the globe, he would be quite insensible of its motion; and the sun and stars would appear to move westward.

We may imagine as many circles described upon the earth as we please; and we may imagine the plane of any circle described upon the earth to be continued, until it marks a circle in the concave sphere of the heavens.

The *horizon* is either *sensible* or *rational*. The *sensible horizon* is that circle which a man standing upon a large plane observes to terminate his view all around, where the heaven and earth seem to meet. The plane of our

sensible horizon continued to the heaven, divides it into two hemispheres; one visible to us, the other hid by the convexity of the earth.

The plane of the *rational horizon*, is supposed parallel to the plane of the sensible; to pass through the centre of the earth, and to be continued to the heavens. And although the plane of the sensible horizon touches the earth in the place of the observer, yet *this* plane, and that of the rational horizon, will seem to coincide in the heaven, because the whole earth is but a point compared to the sphere of the heaven.

The earth being a spherical body, the horizon, or limit of our view, must change as we change our place.

The *poles of the earth*, are those two points on its surface in which its axis terminates. The one is called the *north pole*, and the other the *south pole*.

The *poles of the heaven*, are those two points in which the earth's axis produced terminates in the heaven; so that the *north pole* of the heaven is directly over the north pole of the earth; and the *south pole* of the heaven is directly over the south pole of the earth.

The *equator* is a great circle upon the earth, every part of which is equally distant from either of the poles. It divides the earth into two equal parts, called the *northern* and *southern hemispheres*. If we suppose the plane of this circle to be extended to the heaven, it will mark the *equinoctial* therein, and will divide the heaven into two equal parts, called the *northern* and *southern hemispheres* of the heaven.

The *meridian* of any place is a great circle passing through that place and the poles of the earth. We may imagine as many such meridians as we please, because any place that is ever so little to the east or west of any other place, has a different meridian from that place; for no one circle can pass through any two such places and the poles of the earth.

The *meridian* of any place is divided by the poles into two semicircles: that which passes through the place is called the *geographical*, or *upper meridian*; and that which passes through the opposite place, is called the *lower meridian*.

When the rotation of the earth brings the plane of the geographical meridian to the sun, it is *noon* or *mid-day* to that place; and when the lower meridian comes to the sun, it is *mid-night*.

All places lying under the same geographical meridian, have their noon at the same time, and consequently all the other hours. All those places are said to have the same *longitude*, because no one of them lies either eastward or westward from any of the rest.

If we imagine 24 semicircles, one of which is the geographical meridian of a given place, to meet at the poles, and to divide the equator into 24 equal parts; each of these meridians will come round to the sun in 24 hours, by the earth's equable motion round its axis in that time. And, as the equator contains 360 degrees, there will be 15 degrees contained between any two of these meridians which are nearest to one another: for 24 times 15 is 360. And as the earth's motion is eastward, the sun's apparent motion will be westward, at the rate of 15 degrees each hour. Therefore,

Their whose geographical meridian is 15 degrees eastward

ward from us, have noon, and every other hour, an hour sooner than we have. They whose meridian is fifteen degrees westward from us, have noon, and every other hour, an hour later than we have: and so on in proportion, reckoning one hour for every fifteen degrees.

For the ecliptic circle, signs, and degrees, see АСТРОНОМІЯ, p. 435.

The *tropics* are lesser circles in the heaven, parallel to the equinoctial; one on each side of it, touching the ecliptic in the points of its greatest declination; so that each tropic is  $23\frac{1}{2}$  degrees from the equinoctial, one on the north side of it, and the other on the south. The northern tropic touches the ecliptic at the beginning of Cancer, the southern at the beginning of Capricorn; for which reason the former is called the *tropic of Cancer*, and the latter the *tropic of Capricorn*.

The *polar circles* in the heaven, are each  $23\frac{1}{2}$  degrees from the poles, all around. That which goes round the north pole, is called the *arctic circle*. The south polar circle, is called the *antarctic circle*, from its being opposite to the arctic.

The ecliptic, tropics, and polar circles, are drawn upon the terrestrial globe, as well as upon the celestial. But the ecliptic, being a great fixed circle in the heavens, cannot properly be said to belong to the terrestrial globe; and is laid down upon it only for the conveniency of solving some problems. So that, if this circle on the terrestrial globe was properly divided into the months and days of the year, it would not only suit the globe better, but would also make the problems thereon much easier.

For the earth's motion round its axis every 24 hours; its motion in the ecliptic round the sun every year; and the vicissitude of seasons; see АСТРОНОМІЯ, p. 452.

#### *Description of the Terrestrial Globe.*

[See Plate XLIV. fig. 2.]

The equator, ecliptic, and tropics, polar circles, and meridians, are laid down upon the globe in the manner already described. The ecliptic is divided into 12 signs, and each sign into 30 degrees. Each tropic is  $23\frac{1}{2}$  degrees from the equator, and each polar circle  $23\frac{1}{2}$  degrees from its respective pole. Circles are drawn parallel to the equator, at every ten degrees distance from it on each side to the poles: these circles are called *parallels of latitude*. On large globes there are circles drawn perpendicularly through every tenth degree of the equator, intersecting each other at the poles: but on globes of or under a foot diameter, they are only drawn through every fifteenth degree of the equator; these circles are generally called *meridians*, sometimes *circles of longitude*, and at other times *hour-circles*.

The globe is hung in a brass-ring, called the *brazen meridian*; and turns upon a wire in each pole sunk half its thickness into one side of the meridian ring; by which means, that side of the ring divides the globe into two equal parts, called the *eastern and western hemispheres*; as the equator divides it into two equal parts, called the *northern and southern hemispheres*. The ring is divided

into 360 equal parts or degrees, on the side wherein the axis of the globe turns. One half of these degrees are numbered, and reckoned, from the equator to the poles, where they end at 90: their use is to shew the latitudes of places. The degrees on the other half of the meridian ring are numbered from the poles to the equator, where they end at 90: their use is to shew how to elevate either the north or south pole above the horizon, according to the latitude of any given place, as it is north or south of the equator.

The brazen meridian is let into two notches made in a broad flat ring, called the *wooden horizon*; the upper surface of which divides the globe into two equal parts, called the *upper and lower hemispheres*. One notch is in the north point of the horizon, and the other in the south. On this horizon are several concentric circles, which contain the months and days of the year, the signs and degrees answering to the sun's place for each month and day, and the 32 points of the compass.—The graduated side of the brass meridian lies towards the east side of the horizon, and should be generally kept towards the person who works problems by the globes.

There is a small *horary circle*, so fixed to the north part of the brazen meridian, that the wire in the north pole of the globe is in the centre of that circle; and on the wire is an *index*, which goes over all the 24 hours of the circle, as the globe is turned round its axis. Sometimes there are two horary circles, one between each pole of the globe and the brazen meridian.

There is a thin slip of brass, called the *quadrant of altitude*, which is divided into 90 equal parts or degrees, answering exactly to so many degrees of the equator. It is occasionally fixed to the uppermost point of the brazen meridian by a nut and screw. The divisions end at the nut, and the quadrant is turned round upon it.

#### *The Description and Use of the Armillary Sphere.*

[See Plate LXXXVII. Fig. 1.]

THE exterior parts of this machine are, a compages of brass rings, which represent the principal circles of the heaven, viz. 1. The equinoctial *AA*, which is divided into 360 degrees (beginning at its intersection with the ecliptic in Aries) for shewing the sun's right ascension in degrees; and also into 24 hours, for shewing his right ascension in time. 2. The ecliptic *BB*, which is divided into 12 signs, and each sign into 30 degrees, and also into the months and days of the year; in such a manner, that the degree or point of the ecliptic in which the sun is, on any given day, stands over that day in the circle of months. 3. The tropic of Cancer *CC*, touching the ecliptic at the beginning of Cancer in *e*, and the tropic of Capricorn *DD*, touching the ecliptic at the beginning of Capricorn in *f*; each  $23\frac{1}{2}$  degrees from the equinoctial circle. 4. The arctic circle *E*, and the antarctic circle *F*, each  $23\frac{1}{2}$  degrees from its respective pole at *N* and *S*. 5. The equinoctial colure *GG*, passing through the north and south poles of the heaven at *N* and *S*, and through the equinoctial points Aries and Libra, in the ecliptic. 6. The solstitial colure *HH*, passing through the poles of the heaven,

heaven, and through the solstitial points Cancer and Capricorn, in the ecliptic. Each quarter of the former of these colures is divided into 90 degrees, from the equinoctial to the poles of the world, for shewing the declination of the sun, moon, and stars; and each quarter of the latter, from the ecliptic at *e* and *f*, to its poles *b* and *d*, for shewing the latitude of the stars.

In the north pole of the ecliptic is a nut *b*, to which is fixed one end of a quadrantal wire, and to the other end a small sun *Y*, which is carried round the ecliptic *B B*, by turning the nut: and in the south pole of the ecliptic is a pin *d*, on which is another quadrantal wire, with a small moon *Z* upon it, which may be moved round by hand: but there is a particular contrivance for causing the moon to move in an orbit which crosses the ecliptic at an angle of  $5\frac{1}{2}$  degrees, in two opposite points called the *moon's nodes*; and also for shifting these points backward in the ecliptic, as the *moon's nodes* shift in the heaven.

Within these circular rings is a small terrestrial globe *J*, fixt on an axis *KK*, which extends from the north and south poles of the globe at *n* and *s*, to those of the celestial sphere at *N* and *S*. On this axis is fixt the flat celestial meridian *LL*, which may be set directly over the meridian of any place on the globe, and then turned round with the globe, so as to keep over the same meridian upon it. This flat meridian is graduated the same way as the brass meridian of a common globe, and its use is much the same. To this globe is fitted the moveable horizon *MM*, so as to turn upon two strong wires proceeding from its east and west points to the globe, and entering the globe at the opposite points of its equator, which is a moveable brass ring let into the globe in a groove all around its equator. The globe may be turned by hand within this ring, so as to place any given meridian upon it, directly under the celestial meridian *LL*. The horizon is divided into 360 degrees all around its outermost edge, within which are the points of the compass, for shewing the amplitude of the sun and moon, both in degrees and points. The celestial meridian *LL* passes through two notches in the north and south points of the horizon, as in a common globe: but here, if the globe be turned round, the horizon and meridian turn with it. At the south pole of the sphere is a circle of 24 hours, fixt to the rings, and on the axis is an index which goes round that circle, if the globe be turned round its axis.

The whole fabric is supported on a pedestal *N*, and may be elevated or depressed upon the joint *O*, to any number of degrees from 0 to 90, by means of the arc *P*, which is fixed in the strong brass arm *Q*, and slides in the upright piece *R*, in which is a screw at *r*, to fix it at any proper elevation.

In the box *T* are two wheels (as in Dr Long's sphere) and two pinions, whose axes come out at *V* and *U*; either of which may be turned by the small winch *W*. When the winch is put upon the axis *V*, and turn backward, the terrestrial globe, with its horizon and celestial meridian, keep at rest; and the whole sphere of circles turns round from east, by south, to west, carrying the sun *Y*, and moon *Z*, round the same way, and causing

them to rise above and set below the horizon. But when the winch is put upon the axis *U*, and turned forward, the sphere with the sun and moon keep at rest; and the earth, with its horizon and meridian, turn round from west, by south, to east; and bring the same points of the horizon to the sun and moon, to which these bodies came when the earth kept at rest, and they were carried round it; shewing that they rise and set in the same points of the horizon, and at the same times in the hour circle, whether the motion be in the earth or in the heaven. If the earthly globe be turned, the hour-index goes round its hour-circle; but if the sphere be turned, the hour-circle goes round below the index.

And so, by this construction, the machine is equally fitted to shew either the real motion of the earth, or the apparent motion of the heaven.

To rectify the sphere for use, first slacken the screw *r* in the upright stem *R*, and taking hold of the arm *Q*, move it up or down until the given degree of latitude for any place be at the side of the stem *R*; and then the axis of the sphere will be properly elevated, so as to stand parallel to the axis of the world, if the machine be set north and south by a small compass: this done, count the latitude from the north pole, upon the celestial meridian *LL*, down towards the north notch of the horizon, and set the horizon to that latitude; then, turn the nut *b* until the sun *Y* comes to the given day of the year in the ecliptic, and the sun will be at its proper place for that day: find the place of the moon's ascending node, and also the place of the moon, by an Ephemeris, and set them right accordingly: lastly, turn the winch *W*, until either the sun comes to the meridian *LL*, or until the meridian comes to the sun (according as you want the sphere or earth to move) and set the hour-index to the XII, marked noon, and the whole machine will be rectified.——Then turn the winch, and observe when the sun or moon rise and set in the horizon, and the hour-index will shew the times thereof for the given day.

As those who understand the use of the globes will be at no loss to work many other problems by this sphere, it is needless to enlarge any farther upon it.

#### *Directions for using Globes.*

In using globes, keep the east side of the horizon towards you (unless your problem require the turning of it), which side you may know by the word East upon the horizon; for then you have the graduated side of the meridian towards you, the quadrant of altitude before you, and the globe divided exactly into two equal parts, by the graduated side of the meridian.

In working some problems, it will be necessary to turn the whole globe and horizon about, that you may look on the west side thereof; which turning will be apt to jog the ball so, as to shift away that degree of the globe which was before set to the horizon or meridian: to avoid which inconvenience, you may thrust in the feather-end of a quill between the ball of the globe and the brass meridian; which, without hurting the ball, will keep it

from turning in the meridian, whilst you turn the west side of the horizon towards you.

**PROB. I.** *To find the latitude and longitude of any given place upon the globe.*—Turn the globe on its axis, until the given place comes exactly under that graduated side of the brazen meridian, on which the degrees are numbered from the equator; and observe what degree of the meridian the place then lies under; which is its latitude, north or south, as the place is north or south of the equator.

The globe remaining in this position, the degree of the equator, which is under the brazen meridian, is the longitude of the place which is east or west, as the place lies on the east or west side of the first meridian of the globe.—All the Atlantic Ocean, and America, is on the west side of the meridian of London; and the greatest part of Europe, and of Africa, together with all Asia, is on the east side of the meridian of London, which is reckoned the *first meridian* of the globe by the British geographers and astronomers.

**PROB. II.** *The longitude and latitude of a place being given, to find that place on the globe.*—Look for the given longitude in the equator (counting it eastward or westward from the first meridian as it is mentioned to be east or west;) and bring the point of longitude in the equator to the brazen meridian, on that side which is above the south point of the horizon: then count from the equator, on the brazen meridian, to the degree of the given latitude, towards the north or south pole, according as the latitude is north or south; and under that degree of latitude on the meridian, you will have the place required.

**PROB. III.** *To find the difference of longitude, or difference of latitude, between any two given places.*—Bring each of these places to the brazen meridian, and see what its latitude is: the lesser latitude subtracted from the greater, if both places are on the same side of the equator, or both latitudes added together, if they are on different sides of it, is the difference of latitude required. And the number of degrees contained between these places, reckoned on the equator, when they are brought separately under the brazen meridian, is their difference of longitude; if it be less than 180: but if more, let it be subtracted from 360, and the remainder is the difference of longitude required. Or,

Having brought one of the places to the brazen meridian, and set the hour-index to XII, turn the globe until the other place comes to the brazen meridian, and the number of hours and parts of an hour, past over by the index, will give the longitude in time; which may be easily reduced to degrees, by allowing 15 degrees for every hour, and one degree for every four minutes.

*N B.* When we speak of bringing any place to the brazen meridian, it is the graduated side of the meridian that is meant.

**PROB. IV.** *Any place being given, to find all those places that have the same longitude or latitude with it.*—Bring the given place to the brazen meridian, then all those places which lie under that side of the meridian, from pole to pole, have the same longitude with the given place. Turn the globe round its axis, and all those pla-

ces which pass under the same degree of the meridian that the given place does, have the same latitude with that place.

Since all latitudes are reckoned from the equator, and all longitudes are reckoned from the first meridian, it is evident, that the point of the equator which is cut by the first meridian, has neither latitude nor longitude.—The greatest latitude is 90 degrees, because no place is more than 90 degrees from the equator. And the greatest longitude is 180 degrees, because no place is more than 180 degrees from the first meridian.

**PROB. V.** *To find the antæci, pericæci, and antipodes, of any given place.*—Bring the given place to the brazen meridian; and having found its latitude, keep the globe in that situation, and count the same number of degrees of latitude from the equator towards the contrary pole; and where the reckoning ends, you have the *antæci* of the given place upon the globe. Those who live at the equator have no *antæci*.

The globe remaining in the same position, set the hour-index to the upper XII on the horary circle, and turn the globe until the index comes to the lower XII; then, the place which lies under the meridian, in the same latitude with the given place, is the *pericæci* required. Those who live at the poles have no *pericæci*.

As the globe now stands (with the index at the lower XII) the *antipodes* of the given place will be under the same point of the brazen meridian where its *antæci* stood before. Every place upon the globe has its *antipodes*.

**PROB. VI.** *To find the distance between any two places on the globe.*—Lay the graduated edge of the quadrant of altitude over both the places, and count the number of degrees intercepted between them on the quadrant; then multiply these degrees by 60, and the product will give the distance in geographical miles: but to find the distance in miles, multiply the degrees by 69½, and the product will be the number of miles required. Or, take the distance betwixt any two places with a pair of compasses, and apply that extent to the equator; the number of degrees, intercepted between the points of the compasses, is the distance in degrees of a great circle; which may be reduced either to geographical miles, or to English miles, as above.

**PROB. VII.** *A place on the globe being given, and its distance from any other place, to find all the other places upon the globe which are at the same distances from the given place.*—Bring the given place to the brazen meridian, and screw the quadrant of altitude to the meridian, directly over that place; then keeping the globe in that position, turn the quadrant quite round upon it, and the degree of the quadrant that touches the second place will pass over all the other places which are equally distant with it from the given place.

This is the same as if one foot of a pair of compasses was set in the given place, and the other foot extended to the second place, whose distance is known; for if the compasses be then turned round the first place as a centre, the moving foot will go over all those places which are at the same distance with the second from it.

**PROB. VIII.** *The hour of the day at any place being given, to find all those places where it is noon at that*

*time*—Bring the given place to the brazen meridian, and set the index to the given hour; this done, turn the globe until the index points to the upper XII, and then all the places that lie under the brazen meridian have noon at that time.

*N. B.* The upper XII always stands for noon; and when the bringing of any place to the brazen meridian is mentioned, the side of that meridian on which the degrees are reckoned from the equator is meant, unless the contrary side be mentioned.

**PROB. IX.** *The hour of the day at any place being given, to find what o'clock it then is at any other place.*—Bring the given place to the brazen meridian, and set the index to the given hour; then turn the globe, until the place where the hour is required comes to the meridian, and the index will point out the hour at that place.

**PROB. X.** *To find the sun's place in the ecliptic, and his declination, for any given day of the year.*—Look on the horizon for the given day, and right against it you have the degree of the sign in which the sun is (or his place) on that day at noon. Find the same degree of that sign in the ecliptic line upon the globe, and having brought it to the brazen meridian, observe what degree of the meridian stands over it; for that is the sun's declination, reckoned from the equator.

**PROB. XI.** *The day of the month being given, to find all those places of the earth over which the sun will pass vertically on that day.*—Find the sun's place in the ecliptic for the given day, and having brought it to the brazen meridian, observe what point of the meridian is over it; then, turning the globe round its axis, all those places which pass under that point of the meridian, are the places required; for as their latitude is equal, in degrees and parts of a degree, to the sun's declination, the sun must be directly over head to each of them at its respective noon.

**PROB. XII.** *A place being given in the torrid zone, to find those two days of the year on which the sun shall be vertical to that place.*—Bring the given place to the brazen meridian, and mark the degree of latitude that is exactly over it on the meridian; then turn the globe round its axis, and observe the two degrees of the ecliptic which pass exactly under that degree of latitude: lastly, find on the wooden horizon, the two days of the year in which the sun is in those degrees of the ecliptic, and they are the days required: for on them, and none else, the sun's declination is equal to the latitude of the given place; and consequently, he will then be vertical to it at noon.

**PROB. XIII.** *To find all those places of the north frigid zone, where the sun begins to shine constantly without setting, on any given day, from the 21st of March to the 23d of September.*—On these two days, the sun is in the equinoctial, and enlightens the globe exactly from pole to pole: therefore, as the earth turns round its axis, which terminates in the poles, every place upon it will go equally through the light and the dark, and so make equal day and night to all places of the earth. But as the sun declines from the equator, towards either pole, he will shine just as many degrees round that pole, as are equal to his declination from the equator; so that no

place within that distance of the pole will then go through any part of the dark, and consequently the sun will not set to it. Now, as the sun's declination is northward, from the 21st of March to the 23d of September, he must constantly shine round the north pole all that time; and on the day that he is in the northern tropic, he shines upon the whole north frigid zone; so that no place within the north polar circle goes through any part of the dark on that day. Therefore,

Having brought the sun's place for the given day to the brazen meridian, and found his declination (by Prob. IX.) count as many degrees on the meridian, from the north pole, as are equal to the sun's declination from the equator, and mark that degree from the pole where the reckoning ends: then, turning the globe round its axis, observe what places in the north frigid zone pass directly under that mark; for they are the places required.

The like may be done for the south frigid zone, from the 23d of September to the 21st of March, during which time the sun shines constantly on the south pole.

**PROB. XIV.** *To find the place over which the sun is vertical at any hour of a given day.*—Having found the sun's declination for the given day (by Prob. IX.) mark it with a chalk on the brazen meridian: then bring the place where you are (suppose Edinburgh) to the brazen meridian, and set the index to the given hour; which done, turn the globe on its axis, until the index points to XII at noon; and the place on the globe, which is then directly under the point of the sun's declination marked upon the meridian, has the sun that moment in the zenith, or directly over head.

**PROB. XV.** *The day and hour of a lunar eclipse being given; to find all those places of the earth to which it will be visible.*—The moon is never eclipsed but when she is full, and so directly opposite to the sun, that the earth's shadow falls upon her. Therefore, whatever place of the earth the sun is vertical to at that time, the moon must be vertical to the antipodes of that place: so that the sun will be then visible to one half of the earth, and the moon to the other.

Find the place to which the sun is vertical at the given hour (by Prob. XIV.) elevate the pole to the latitude of that place, and bring the place to the upper part of the brazen meridian, as in the former problem: then, as the sun will be visible to all those parts of the globe which are above the horizon, the moon will be visible to all those parts which are below it, at the time of her greatest obscuration.

**PROB. XVI.** *To rectify the globe for the latitude, the zenith, and the sun's place.*—Find the latitude of the place (by Prob. I.) and if the place be in the northern hemisphere, raise the north pole above the north point of the horizon, as many degrees (counted from the pole upon the brazen meridian) as are equal to the latitude of the place. If the place be in the southern hemisphere, raise the south pole above the south point of the horizon, as many degrees as are equal to the latitude. Then, turn the globe till the place comes under its latitude on the brazen meridian, and fasten the quadrant of altitude so, that the chamfered edge of its nut (which is even with the graduated edge) may be joined to the zenith.

or



or point of latitude. This done, bring the sun's place in the ecliptic for the given day (found by Prob X.) to the graduated side of the brazen meridian, and set the hour-index to XII at noon, which is the uppermost XII on the hour-circle; and the globe will be rectified.

PROB. XVII. *The latitude of any place, not exceeding  $66\frac{1}{2}$  degrees, and the day of the month, being given; to find the time of sun rising and setting, and consequently the length of the day and night.*—Having rectified the globe for the latitude, and for the sun's place on the given day (as directed in the preceding problem) bring the sun's place in the ecliptic to the eastern side of the horizon, and the hour-index will shew the time of sun rising; then turn the globe on its axis, until the sun's place comes to the western side of the horizon, and the index will shew the time of sun-setting.

The hour of sun-setting doubled, gives the length of the day; and the hour of sun rising doubled, gives the length of the night.

PROB. XVIII. *The latitude of any place, and the day of the month being given; to find when the morning twilight begins, and the evening twilight ends, at that place.*—This problem is often limited: for, when the sun does not go 18 degrees below the horizon, the twilight continues the whole night; and for several nights together in summer, between 49 and  $66\frac{1}{2}$  degrees of latitude; and the nearer to  $66\frac{1}{2}$ , the greater is the number of these nights. But when it does begin and end, the following method will shew the time for any given day.

Rectify the globe, and bring the sun's place in the ecliptic to the eastern side of the horizon; then mark that point of the ecliptic with a chalk which is in the western side of the horizon, it being the point opposite to the sun's place: this done, lay the quadrant of altitude over the said point, and turn the globe eastward, keeping the quadrant at the chalk mark, until it be just 18 degrees high on the quadrant; and the index will point out the time when the morning twilight begins: for the sun's place will then be 18 degrees below the eastern side of the horizon. To find the time when the evening twilight ends, bring the sun's place to the western side of the horizon, and the point opposite to it, which was marked with the chalk, will be rising in the east: then, bring the quadrant over that point, and keeping it thereon, turn the globe westward, until the said point be 18 degrees above the horizon on the quadrant, and the index will shew the time when the evening twilight ends; the sun's place being then 18 degrees below the western side of the horizon.

PROB. XIX. *To find on what day of the year the sun begins to shine constantly without setting, on any given place in the north frigid zone; and how long he continues to do so.*—Rectify the globe to the latitude of the place, and turn it about until some point of the ecliptic, between aries and cancer, coincides with the north point of the horizon where the brazen meridian cuts it: then find, on the wooden horizon, what day of the year the sun is in that point of the ecliptic; for that is the day on which the sun begins to shine constantly on the given place, without setting. This done, turn the globe until some point of the ecliptic, between cancer and libra, coincides

with the north point of the horizon, where the brazen meridian cuts it; and find, on the wooden horizon, on what day the sun is in that point of the ecliptic; which is the day that the sun leaves off constantly shining on the said place, and rises and sets to it as to other places on the globe. The number of natural days, or complete revolutions of the sun about the earth, between the two days above found, is the time that the sun keeps constantly above the horizon without setting: for all that portion of the ecliptic, which lies between the two points which intersect the horizon in the very north, never sets below it: and there is just as much of the opposite part of the ecliptic that never rises; therefore, the sun will keep as long constantly below the horizon in winter, as above it in summer.

PROB. XX. *To find in what latitude the sun shines constantly without setting, for any length of time less than  $182\frac{1}{2}$  of our days and nights.*—Find a point in the ecliptic half as many degrees from the beginning of cancer (either toward aries or libra) as there are natural days in the time given; and bring that point to the north side of the brazen meridian, on which the degrees are numbered from the pole towards the equator: then, keep the globe from turning on its axis, and slide the meridian up or down, until the foresaid point of the ecliptic comes to the north point of the horizon, and then the elevation of the pole will be equal to the latitude required.

PROB. XXI. *The latitude of a place, not exceeding  $66\frac{1}{2}$  degrees, and the day of the month being given; to find the sun's amplitude, or point of the compass on which he rises or sets.*—Rectify the globe, and bring the sun's place to the eastern side of the horizon; then observe what point of the compass on the horizon stands right against the sun's place, for that is his amplitude at rising. This done, turn the globe westward, until the sun's place comes to the western side of the horizon, and it will cut the point of his amplitude at setting. Or, you may count the rising amplitude in degrees, from the east point of the horizon, to that point where the sun's place cuts it; and the setting amplitude, from the west point of the horizon, to the sun's place at setting.

PROB. XXII. *The latitude, the sun's place, and his altitude, being given; to find the hour of the day, and the sun's azimuth, or number of degrees that he is distant from the meridian.*—Rectify the globe, and bring the sun's place to the given height upon the quadrant of altitude; on the eastern side of the horizon, if the time be in the forenoon; or the western side, if it be in the afternoon: then the index will shew the hour; and the number of degrees in the horizon, intercepted between the quadrant of altitude and the south point, will be the sun's true azimuth at that time.

PROB. XXIII. *The latitude, hour of the day, and the sun's place, being given; to find the sun's altitude and azimuth.*—Rectify the globe, and turn it until the index points to the given hour; then lay the quadrant of altitude over the sun's place in the ecliptic, and the degree of the quadrant cut by the sun's place is his altitude at that time above the horizon; and the degree of the horizon cut by the quadrant is the sun's azimuth, reckoned from the south.

PROB. XXIV. *The latitude, the sun's altitude, and*

his azimuth being given; to find his place in the ecliptic, the day of the month, and hour of the day, though they had all been lost.—Rectify the globe for the latitude and zenith, and set the quadrant of altitude to the given azimuth in the horizon; keeping it there, turn the globe on its axis until the ecliptic cuts the quadrant in the given altitude: that point of the ecliptic which cuts the quadrant there, will be the sun's place; and the day of the month answering thereto, will be found over the like place of the sun on the wooden horizon. Keep the quadrant of altitude in that position; and, having brought the sun's place to the brazen meridian, and the hour-index to XII at noon, turn back the globe, until the sun's place cuts the quadrant of altitude again, and the index will shew the hour.

Any two points of the ecliptic, which are equidistant from the beginning of Cancer or of Capricorn, will have the same altitude and azimuth at the same hour, though the months be different; and therefore it requires some care in this problem, not to mistake both the month and the day of the month; to avoid which, observe, that from the 20th of March to the 21st of June, that part of the ecliptic which is between the beginning of Aries and beginning of Cancer is to be used: from the 21st of June to the 23d of September, between the beginning of Cancer and beginning of Libra: from the 23d of September to the 21st of December, between the beginning of Libra and the beginning of Capricorn; and from the 21st of December to the 20th of March, between the beginning of Capricorn and beginning of Aries. And as one can never be at a loss to know in what quarter of the year he takes the sun's altitude and azimuth, the above caution with regard to the quarters of the ecliptic will keep him right as to the month and day thereof.

PROB. XXV. *To find the length of the longest day at any given place.*—If the place be on the north side of the equator (find its latitude by Prob. I.) and elevate the north pole to that latitude; then, bring the beginning of Cancer to the brazen meridian, and set the hour-index to XII at noon. But if the given place be on the south side of the equator, elevate the south pole to its latitude, and bring the beginning of Capricorn to the brazen meridian, and the hour-index to XII. This done, turn the globe westward, until the beginning of Cancer or Capricorn (as the latitude is north or south) comes to the horizon; and the index will then point out the time of sun-setting, for it will have gone over all the afternoon hours, between mid-day and sun set; which length of time being doubled, will give the whole length of the day from sun-rising to sun-setting. For, in all latitudes, the sun rises as long before mid day, as he sets after it.

PROB. XXVI. *To find in what latitude the longest day is, of any given length, less than 24 hours.*—If the latitude be north, bring the beginning of Cancer to the brazen meridian, and elevate the north pole to about  $66\frac{1}{2}$  degrees; but if the latitude be south, bring the beginning of Capricorn to the meridian, and elevate the south pole to about  $66\frac{1}{2}$  degrees; because the longest day in north latitude is, when the sun is in the first point of Cancer; and in south latitude, when he is in the first point of Capricorn. Then set the hour-index to XII at

noon, and turn the globe westward, until the index points at half the number of hours given; which done, keep the globe from turning on its axis, and slide the meridian down in the notches, until the aforesaid point of the ecliptic (*viz.* Cancer or Capricorn) comes to the horizon; then, the elevation of the pole will be equal to the latitude required.

PROB. XXVII. *The latitude of any place, not exceeding  $66\frac{1}{2}$  degrees, being given; to find in what climate the place is.*—Find the length of the longest day at the given place, by Prob. XXV. and whatever be the number of hours whereby it exceedeth twelve, double that number, and the sum will give the climate in which the place is.

PROB. XXVIII. *The latitude, and the day of the month, being given; to find the hour of the day when the sun shines.*—Set the wooden horizon truly level, and the brazen meridian due north and south by a mariner's compass: then, having rectified the globe, stick a small sewing-needle into the sun's place in the ecliptic, perpendicular to that part of the surface of the globe: this done, turn the globe on its axis, until the needle comes to the brazen meridian, and set the hour-index to XII at noon; then, turn the globe on its axis, until the needle points exactly towards the sun (which it will do when it casts no shadow on the globe), and the index will shew the hour of the day.

#### *The Use of the Celestial Globe.*

HAVING done for the present with the terrestrial globe, we shall proceed to the use of the celestial; first premising, that as the equator, ecliptic, tropics, polar-circles, horizon, and brazen meridian, are exactly alike on both globes, all the former problems concerning the sun are solved the same way by both globes. The method also of rectifying the celestial globe is the same as rectifying the terrestrial.

*N. B.* The sun's place for any day of the year stands directly over that day on the horizon of the celestial globe, as it does on that of the terrestrial.

The *latitude* and *longitude* of the stars, or of all other celestial phenomena, are reckoned in a very different manner from the latitude and longitude of places on the earth: for all terrestrial latitudes are reckoned from the equator; and longitudes from the meridian of some remarkable place, as of London by the British, and of Paris by the French. But the astronomers of all nations agree in reckoning the latitudes of the moon, stars, planets, and comets, from the ecliptic; and their longitudes from the equinoctial colure, in that semi-circle of it which cuts the ecliptic at the beginning of Aries; and thence eastward, quite round, to the same semi-circle again. Consequently those stars which lie between the equinoctial and the northern half of the ecliptic, have north declination and south latitude; those which lie between the equinoctial and the southern half of the ecliptic, have south declination and north latitude; and all those which lie between the tropics and poles, have their declinations and latitudes of the same denomination.

There are six great circles on the celestial globe, which

cut the ecliptic perpendicularly, and meet in two opposite points in the polar circles; which points are each ninety degrees from the ecliptic, and are called its poles. These polar points divide those circles into 12 semicircles; which cut the ecliptic at the beginnings of the 12 signs. They resemble so many meridians on the terrestrial globe; and as all places which lie under any particular meridian-semicircle on that globe, have the same longitude, so all those points of the heaven, through which any of the above semicircles are drawn, have the same longitude.— And as the greatest latitudes on the earth are at the north and south poles of the earth, so the greatest latitudes in the heaven are at the north and south poles of the ecliptic.

For the division of the stars into constellations, &c. see *ASTRONOMY*, p. 486.

**PROB. I.** *To find the right ascension and declination of the sun, or any fixed star.*—Bring the sun's place in the ecliptic to the brazen meridian; then that degree in the equinoctial which is cut by the meridian, is the sun's *right ascension*; and that degree of the meridian which is over the sun's place, is his *declination*. Bring any fixed star to the meridian, and its right ascension will be cut by the meridian in the equinoctial; and the degree of the meridian that stands over it, is its declination.

So that the right ascension and declination, on the celestial globe, are found in the same manner as longitude and latitude on the terrestrial.

**PROB. II.** *To find the latitude and longitude of any star.*—If the given star be on the north side of the ecliptic, place the 90th degree of the quadrant of altitude on the north pole of the ecliptic, where the twelve semicircles meet, which divide the ecliptic into the 12 signs: but if the star be on the south side of the ecliptic, place the 90th degree of the quadrant on the south pole of the ecliptic; keeping the 90th degree of the quadrant on the proper pole, turn the quadrant about, until its graduated edge cuts the star: then, the number of degrees in the quadrant, between the ecliptic and the star, is its latitude; and the degree of the ecliptic, cut by the quadrant, is the star's longitude, reckoned according to the sign in which the quadrant then is.

**PROB. III.** *To represent the face of the starry firmament, as seen from any given place of the earth, at any hour of the night.*—Rectify the celestial globe for the given latitude, the zenith, and sun's place, in every respect, as taught by the XVIth problem, for the terrestrial; and turn it about, until the index points to the given hour: then, the upper hemisphere of the globe will represent the visible half of the heaven for that time: all the stars upon the globe being then in such situations, as exactly correspond to those in the heaven. And if the globe be placed duly north and south, by means of a small sea-compass, every star in the globe will point toward the like star in the heaven: by which means, the constellations and remarkable stars may be easily known. All those stars which are in the eastern side of the horizon, are then rising in the eastern side of the heaven; all in the western, are setting in the western side; and all those under the upper part of the brazen meridian, between the south point of the horizon and the north pole, are at their greatest altitude, if the latitude of the place be north:

but if the latitude be south, those stars which lie under the upper part of the meridian, between the north point of the horizon and the south pole, are at their greatest altitude.

**PROB. IV.** *The latitude of the place, and day of the month, being given; to find the time when any known star will rise, or be upon the meridian, or set.*—Having rectified the globe, turn it about until the given star comes to the eastern side of the horizon, and the index will shew the time of the star's rising; then turn the globe westward, and when the star comes to the brazen meridian, the index will shew the time of the star's coming to the meridian of your place; lastly, turn on, until the star comes to the western side of the horizon, and the index will shew the time of the star's setting.

**N. B.** In northern latitudes, those stars which are less distant from the north pole, than the quantity of its elevation above the north point of the horizon, never set; and those which are less distant from the south pole, than the number of degrees by which it is depressed below the horizon, never rise: and *vice versa* in southern latitudes.

**PROB. V.** *To find at what time of the year a given star will be upon the meridian, at a given hour of the night.*—Bring the given star to the upper semicircle of the brazen meridian, and set the index to the given hour; then turn the globe, until the index points to XII at noon, and the upper semicircle of the meridian will then cut the sun's place, answering to the day of the year sought; which day may be easily found against the like place of the sun among the signs on the wooden horizon.

**PROB. VI.** *The latitude, day of the month, and azimuth of any known star, being given; to find the hour of the night.*—Having rectified the globe for the latitude, zenith, and sun's place, lay the quadrant of altitude to the given degree of azimuth in the horizon: then turn the globe on its axis, until the star comes to the graduated edge of the quadrant; and when it does, the index will point out the hour of the night.

**PROB. VII.** *The latitude of the place, the day of the month, and altitude of any known star, being given; to find the hour of the night.*—Rectify the globe as in the former problem, guess at the hour of the night, and turn the globe until the index points at the supposed hour; then lay the graduated edge of the quadrant of altitude over the known star, and if the degree of the star's height in the quadrant upon the globe, answers exactly to the degree of the star's observed altitude in the heaven, you have guessed exactly: but if the star on the globe is higher or lower than it was observed to be in the heaven, turn the globe backwards or forwards, keeping the edge of the quadrant upon the star, until its centre comes to the observed altitude in the quadrant; and then, the index will shew the true time of the night.

**PROB. VIII.** *An easy method for finding the hour of the night by any two known stars, without knowing either their altitude or azimuth; and then, of finding both their altitude and azimuth, and thereby the true meridian.*—Tie one end of a thread to a common musket-bullet; and, having rectified the globe as above, hold the other end of the thread in your hand, and carry it slowly

slowly round betwixt your eye and the starry heaven, until you find it cuts any two known stars at once. Then guessing at the hour of the night, turn the globe until the index points to that time in the hour circle; which done, lay the graduated edge of the quadrant over any one of these two stars on the globe, which the thread cut in the heaven. If the said edge of the quadrant cuts the other star also, you have guessed the time exactly; but if it does not, turn the globe slowly backwards or forwards, until the quadrant (kept upon either star) cuts them both through their centres: and then, the index will point out the exact time of the night; the degree of the horizon, cut by the quadrant, will be the true azimuth of both these stars from the south; and the stars themselves will cut their true altitude in the quadrant. At which moment, if a common azimuth-compass be so set upon a floor or level pavement, that these stars in the heaven may have the same bearing upon it (allowing for the variation of the needle) as the quadrant of altitude has in the wooden horizon of the globe, a thread extended over the north and south points of that compass will be directly in the plane of the meridian: and if a line be drawn upon the floor or pavement, along the course of the thread, and an upright wire be placed in the southmost end of the line, the shadow of the wire will fall upon that line, when the sun is on the meridian, and shines upon the pavement.

PROB. IX. *To find the place of the moon, or of any planet; and thereby to shew the time of its rising, setting, and setting.*—Seek in Parker's or Weaver's ephemeris the geocentric place of the moon or planet in the ecliptic, for the given day of the month; and, according to its longitude and latitude, as shewn by the ephemeris, mark the same with a chalk upon the globe. Then, ha-

ving rectified the globe, turn it round its axis westward; and as the said mark comes to the eastern side of the horizon, to the brass meridian, and to the western side of the horizon, the index will shew at what time the planet rises, comes to the meridian, and sets, in the same manner as it would do for a fixed star.

For an explanation of the harvest moons by a globe, see *ASTRONOMY*, p. 463.

For the description and use of a planetary globe, see *ASTRONOMY*, p. 498.

For the equation of time, see *ASTRONOMY*, p. 458.

HAVING thus explained the use of the globes, and general principles of geography, we must refer to the maps for the situation of each particular country, with regard to longitude, latitude, &c. The use of maps is obvious from their construction. The degrees of the meridian, and parallels, shew the longitudes and latitudes of places; and the scale of miles annexed, their distances. The situation of places, with regard to each other, as well as the cardinal points, appears by inspection; the top of the map being always the north, the bottom the south, the right-hand the east, and the left the west, unless the compass usually annexed shew the contrary.

The brevity, which we are necessarily obliged to observe, prevents us from taking any notice of many particulars, which are to be found in large treatises on this subject. A general account of countries, cities, rivers, mountains, &c. is given under their respective names, as they occur in the order of the alphabet. We shall therefore conclude this article with the following table, which will serve to give an idea of the general division of the habitable earth; and at the same time serve to explain the maps in Plates 87. 88. 89. 90. 91. and 92.

*The Division of the Habitable Earth, the square Miles of each Division and Subdivision, Capital Cities, with the Distance and Bearing of each from London; also the Time of each Country compared with that of England.*

THE terraqueous globe is divided into	I. EUROPE	2,749,349	} Square miles, 60 miles in length to a degree.
	II. ASIA	10,257,487	
	III. AFRICA	8,506,208	
	IV. AMERICA	9,153,762	
	Habitable earth	30,666,806	
	Seas, and unknown parts	117,843,821	
	Superficies of the whole globe	148,510,627	

Division and subdivision.	Square miles.	Capital cities.	Distance and bearing from London.	Diff. of time from London.
<b>I. EUROPE.</b>				
1. Spain	150,243	Madrid	690 S	*H.M. 0 16 W
2. Portugal	27,851	Lisbon	840 S W	0 38 W
3. France	138,837	Paris	203 E	0 9 E

4. Italy

\* A degree of longitude being 4 minutes in time, therefore by having the longitude we have the time. A watch that is set to time at London would be 16 minutes too fast at Madrid, as it lies to the west of the meridian at London: and Vienna being 16 degrees and 20 minutes to the east of the meridian of London, consequently a watch set at London would be 1 hour and 5 minutes too slow at Vienna.



Plate LXXVIII.









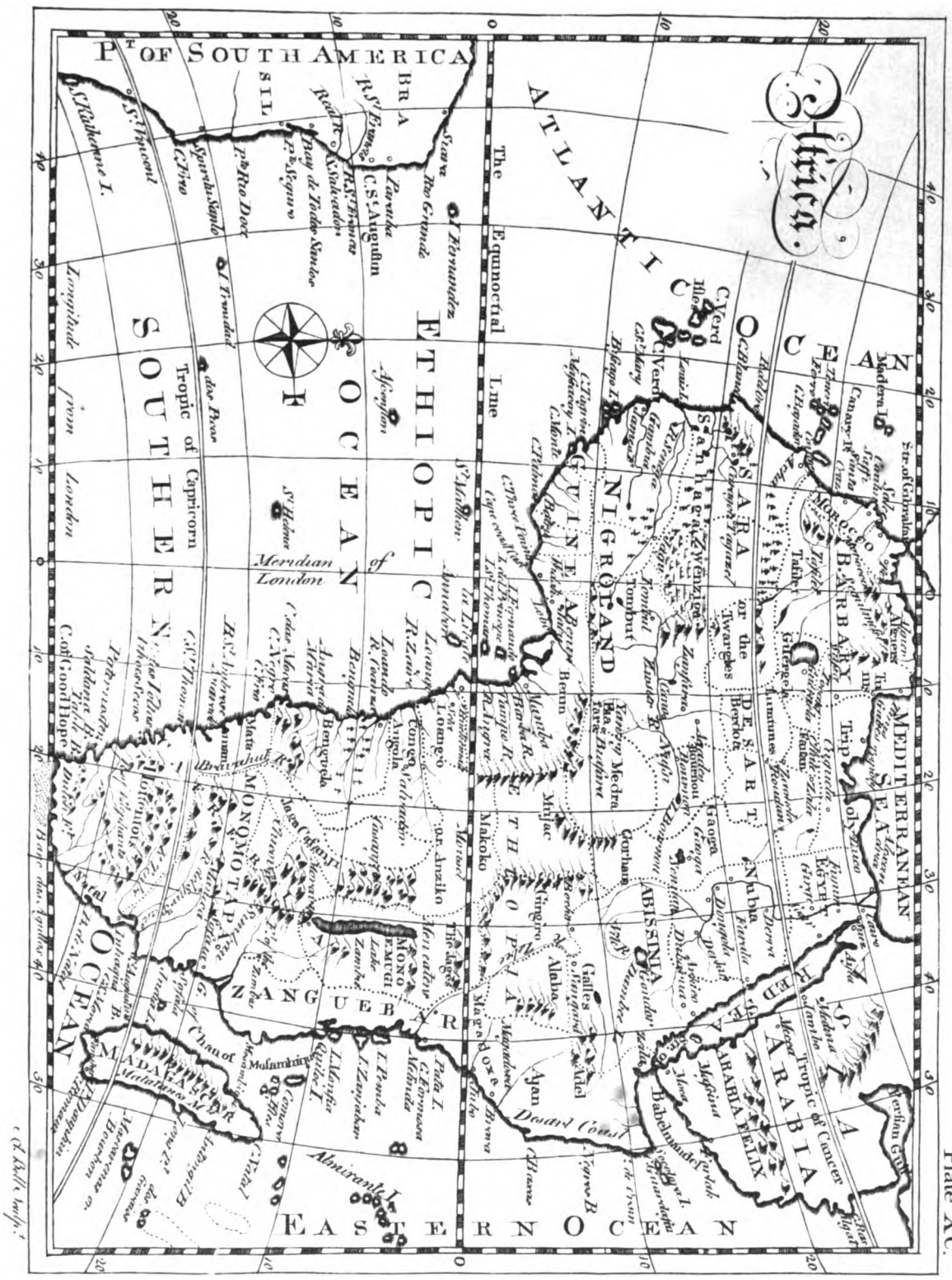
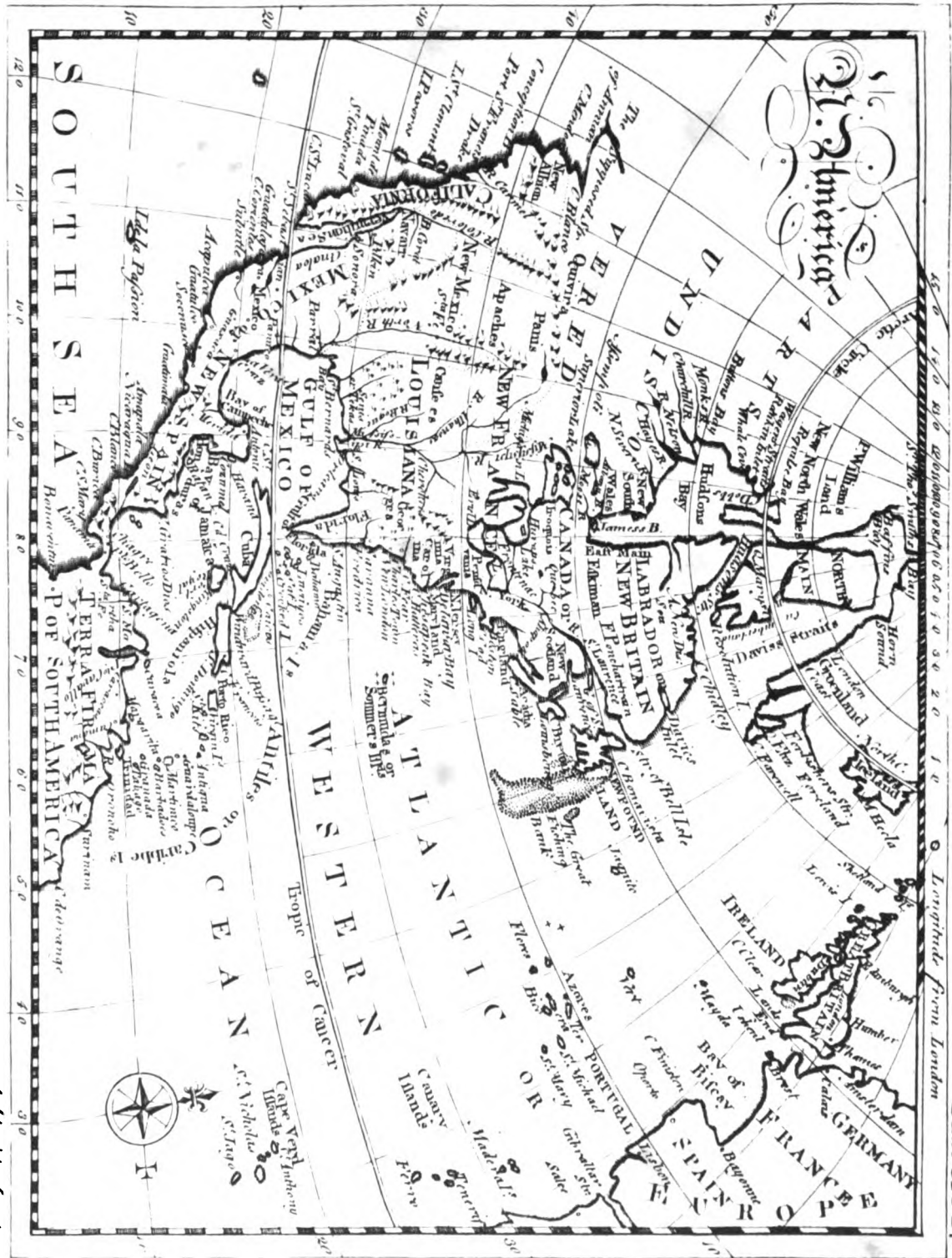


Plate XC.





Longitude from London

Plate XXI.

W. Blount's Copy







Division and subdivision.	Square miles.	Capital cities.	Distance and bearing from London.	Difference of time from London.
				H. M.
4. Italy	75,576	Rome	780 SE	0 52 E
5. Germany	131,621	Vicenna	650 E	1 5 E
6. Holland	9,540	Amsterdam	132 E	0 18 E
7. Denmark	162,001	Copenhagen	480 NE	0 50 E
8. Sweden	223,715	Stockholm	720 NE	1 10 E
9. Russia	1,103,485	Petersburgh	1080 NE	2 2 E
10. Poland	226,414	Warsaw	766 SE	1 23 E
11. Turkey in Europe	212,240	Constantinople	1300 SE	1 56 E
12. British isles	105,034	London		First meridian.
<b>II. ASIA.</b>				
1. Turkey in Asia	510,717	Bursa	1396 SE	1 58 E
2. Arabia	700,000	Mecca	2240 SE	
3. Persia	800,000	Isfahan	2550 E	3 21 E
4. India	1,857,500	Agra	3730 E	5 15 E
5. China	1,105,000	Pekin	4380 NE	7 24 E
6. Asiatic isles	811,980			
7. Tartary				
1. Chinese	644,000	Chinyan	4480 NE	8 4 E
2. Independent	778,290	Samarchand	2800 E	4 26 E
3. Muscovite	3,050,000	Tobolsky	2412 NE	4 10 E
<b>III. AFRICA.</b>				
1. Egypt	140,700	Grand Cairo	1920 SE	2 10 E
2. Barca	66,400	Tolmeta	1440 SE	1 26 E
3. Abex	30,000	Erquicke	3590 SE	2 36 E
4. Fez and Morocco	111,800	Fez and Morocco	1080 S	0 21 W
5. Taflet and Segelmesse.	100,600	Taflet and Segelmesse.	1290 S	0 30 W
			1376 S	0 30 W
			1240 S	0 19 W
6. Algier	143,600	Algier.	920 S	0 13 E
7. Tunis	54,400	Tunis	990 SE	0 39 E
8. Tripoli	75,000	Tripoli	1260 SE	0 66 E
9. Bilodalgerid	485,000	Dara	1565 S	0 36 W
10. Zaara	739,200	Tegassa	1240 S	0 24 W
11. N. groland	1,026,000	Madinga	2500 S	0 38 W
12. Guinea	510,000	Benin	2700 S	0 20 E
13. Loango	49,400	Loango	3300 S	0 43 E
14. Congo	172,800	St Salvador	3480 S	1 0 E
15. Angola	38,400	Mocbina	3750 S	0 58 E
16. Bengucla	64,000	Bengucla	3400 S	0 58 E
17. Mataman	144,000			
18. Monomotapa	222,500	Monomotapa	4500 S	1 18 E
19. Monomugi	310,000	Chicova	4260 S	1 44 E
20. Caffers	200,340	Cape of Good Hope	5200 S	1 4 E
21. S. f. ila	27,500	S. f. ila	4600 SE	2 17 E
22. Zanguabar	275,000	Mozambique	4440 SE	2 38 E
23. Anian	234,000	Brava	3702 SE	2 40 E
24. Abyssinia	378,000	Guxuma		
25. Nubia	264,000	Dancala	2418 SE	2 13 E
26. Desert of Barca	184,400	Angela	1680 SE	1 33 E
27. Ethiopia	1,200,000			
28. African isles	181,668			
<b>IV. AMERICA.</b>				
<b>1. BRITISH empire</b>				
1. Carolina	57,500	Charles-Town	3450 W	5 2 W
2. Virginia	29,750	James-Town	3210 W	5 W
3. Maryland	12,100	Baltimore	5000 W	4 45 W

4. Possessions.

Division and subdivision.	Square miles.	Capital cities.	Distance and bearing from London.	Difference of time from London.
				H. M.
4. <i>Pensylvania</i>	12,500	<i>Philadelphia</i>	3100 W	4 55 W
5. <i>New-Jersey</i>	10,000	<i>Elizabeth-Town</i>	3040 W	4 50 W
6. <i>New-York</i>	8,100	<i>New-York</i>	3000 W	4 53 W
7. <i>New England and Scotland</i> }	115,000	<i>Boston</i>	2790 W	4 40 W
8. <i>Isles</i>	42,972	<i>Annapolis</i>	2580 W	4 24 W
2. <b>SPANISH empire</b>		<i>Kingston</i>	4080 W	5 6 W
1. <i>Old Mexico</i>	571,240	<i>Mexico</i>	4800 N W	6 54 W
2. <i>New Mexico</i>	300,000	<i>Sanctu Fe</i>	4320 N W	7 17 W
3. <i>Florida</i>	113 000	<i>St Augustine</i>	3690 W	5 25 W
4. <i>Terra Firma</i>	828,000	<i>Carthagena</i>	4320 W	5 6 W
5. <i>Peru</i>	970,000	<i>Lima</i>	5700 S W	5 4 W
6. <i>Chili</i>	206,000	<i>St Jago</i>	7200 S W	5 6 W
7. <i>Paragua</i>	1,150,000	<i>Assumption</i>	5460 S W	3 52 W
8. <i>Land of Amazons</i>	993,600	Unknown		
9. <i>Magellanica</i>	325,000	Unknown		
10. <i>California</i>	240,000	Unknown		
11. <i>Isles</i>	143,196	<i>Havanna</i>		5 26 W
3. <b>FRENCH empire</b>				
1. <i>Louisiana</i>	516,000	<i>Port Louis</i>	4080 N W	6 5 W
2. <i>Canada and New France</i>	1,059,100	<i>Quebec</i>		5 46 W
3. <i>French isles</i>	21,520			
4. <b>DUTCH dominions</b>				
1. <i>Curassow</i>	342			.
2. <i>Bonair</i>	168			.
5. <b>PORTUGUESE dominions are</b>				
<i>Brazil</i>	940,000	<i>St Salvador</i>	2260 S W	4 42 W
6. <i>Ter de Labrador</i>	318,750	Unknown		

## G E O M E T R Y.

**G**EOMETRY originally signified no more than the art of measuring the earth, or any distances or dimensions within it: but at present, it denotes the science of magnitude in general; comprehending the doctrine and relations of whatever is susceptible of augmentation or diminution, considered in that light.

Hence to geometry may be referred the consideration not only of lines, surfaces, and solids; but also of time, velocity, number, weight, &c.

This science had its rise among the Egyptians, who were in a manner compelled to invent it, to remedy the confusion which generally happened in their lands, from the inundations of the river Nile, which carried away all boundaries, and effaced all the limits of their possessions. Thus this invention, which at first consisted only in measuring the lands, that every person might have what belonged to him, was called Geometry, or the art of measuring land; and it is probable that the draughts and schemes, which they were annually compelled to make, helped them to discover many excellent properties of

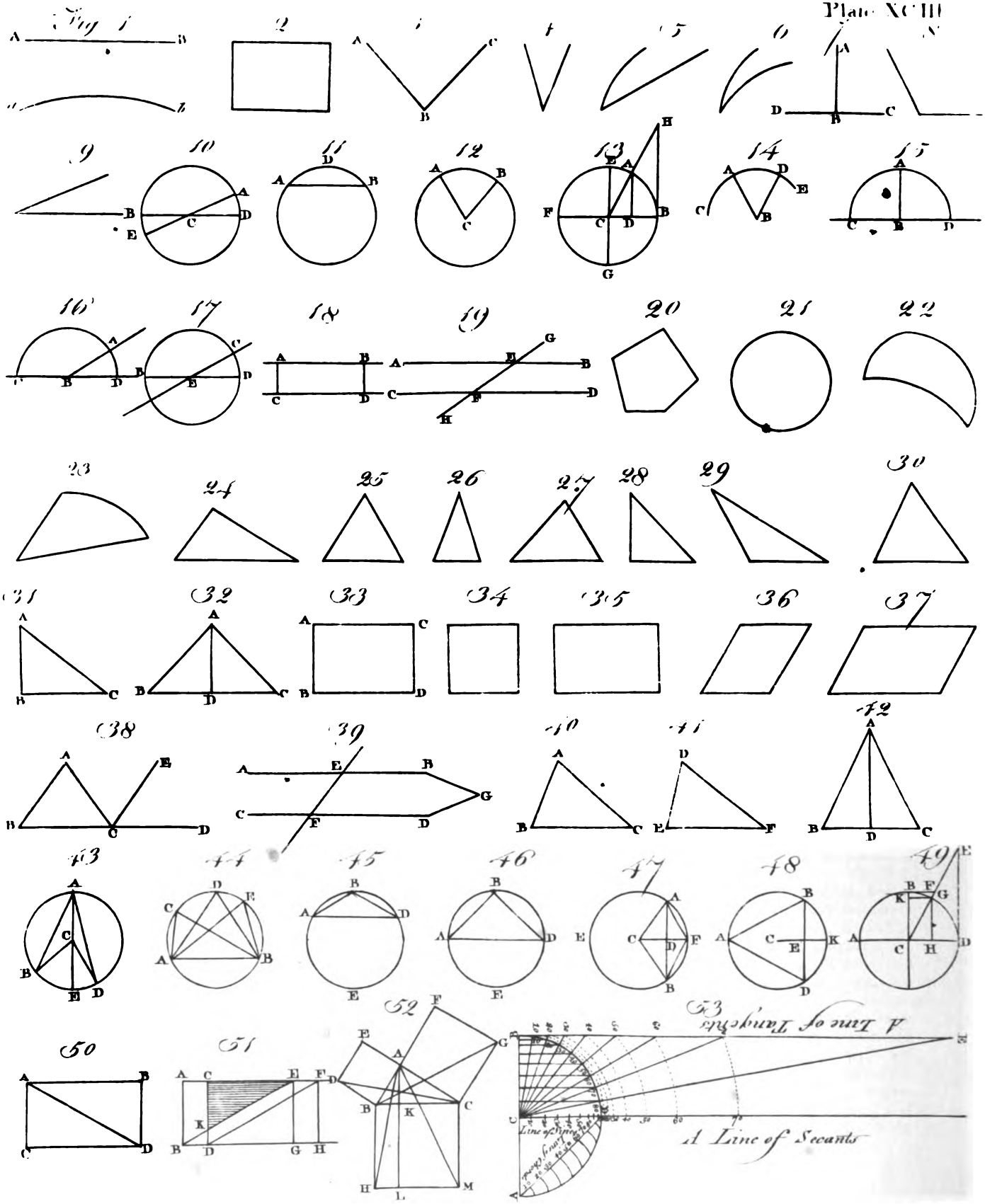
these figures; which speculations continued to be gradually improved, and are so to this day.

From Egypt geometry passed into Greece; where it continued to receive new improvements in the hands of Thales, Pythagoras, Archimedes, Euclid, &c. The Elements of Geometry, written by this last in fifteen books, are a most convincing proof to what perfection this science was carried among the ancients. However, it must be acknowledged, that it fell short of modern geometry; the bounds of which, what by the invention of fluxions, and the discovery of the almost infinite orders of curves, are greatly enlarged.

We may distinguish the progress of geometry into three ages; the first of which was in its meridian glory at the time when Euclid's Elements appeared; the second, beginning with Archimedes, reaches to the time of Des Cartes, who, by applying algebra to the elements of geometry, gave a new turn to this science, which has been carried to its utmost perfection by Sir Isaac Newton and Mr Leibnitz.







In treating this useful subject, we shall divide it into two parts; the first containing the general principles; and

the second, the application of these principles to the measurement of surfaces, solids, &c.

P A R T I.

GENERAL PRINCIPLES OF GEOMETRY.

Art. 1. **A** point is that which is not made up of parts, or which is of itself indivisible.

2. A line is a length without breadth, as B—

3. The extremities of a line are points; as the extremities of the line AB, are the points A and B, fig. 1. Plate XCIII.

4. If the line AB be the nearest distance between its extremes A and B, then it is called a *strait line*, as A B; but if it be not the nearest distance, then it is called a *curve line*, as AB; fig. 1.

5. A surface is that which is considered as having only length and breadth, but no thickness, as B, fig. 2.

6. The terms or boundaries of a surface are lines.

7. A plain surface is that which lies equally between its extremes.

8. The inclination between two lines meeting one another (provided they do not make one continued line,) or the opening between them, is called an *angle*; thus the inclination of the line AB to the line CB (fig. 3.) meeting one another at B. or the opening between the two lines AB and CB, is called an angle.

9. When the lines forming the angle are right lines, then it is called a *right-lined angle*, as A, fig. 4. if one of them be right and the other curved, it is called a *mixed angle*, as B, fig 5. if both if them be curved, it is called a *curve-lined angle*, as C, fig. 6.

10. If a right line AB fall upon another DC, (fig. 7.) so as to incline neither to one side nor to the other; but make the angles ABD, ABC, on each side equal to one another; then the line AB is said to be *perpendicular* to the line DC, and the two angles are called *right-angles*.

11. An obtuse angle is that which is greater than a right one, as A, fig. 8; and an acute angle, that which is less than a right one, as B, fig. 9.

12. If a right line DC be fastened at one of its ends C, and the other end D be carried quite round, then the space comprehended is called a *circle*; the curve line described by the point D, is called the *periphery* or *circumference* of the circle; the fixed point C is called the *centre* of it. Fig. 10.

13. The describing line CD is called the *radius*, viz. any line drawn from the centre to the circumference; whence all radii of the same or equal circles are equal.

14. Any line drawn through the centre, and terminated both ways by the circumference, is called a *diameter*, as BD is a diameter of the circle BADE. And the diameter divides the circle and circumference into two equal parts, and is double the radius.

15. The circumference of every circle is supposed to be divided into 360 equal parts, called *degrees*; and each degree is divided into 60 equal parts, called *minutes*; and each minute into 60 equal parts called, *seconds*; and

these into *thirds*, *fourths*, &c. these parts being greater or less according as the radius is.

16. Any part of the circumference is called an *arch*, or *arc*; and is called an arc of as many degrees as it contains parts of the 360, into which the circumference was divided: Thus if AD be the  $\frac{1}{4}$  of the circumference, then the arc AD is an arc of 45 degrees.

17. A line drawn from one end of an arc to the other, is called a *chord*, and is the measure of the arc; thus the right line AB is the chord of the arc ADB, fig. 11.

18. Any part of a circle cut off by a chord, is called a *segment*; thus the space comprehended between the chord AB and circumference ADB (which is cut off by the chord AB) is called a segment. Whence it is plain,

1<sup>st</sup>, That all chords divide the circle into two segments.

2<sup>dly</sup>, The less the chord is, the more unequal are the segments, and *e contra*.

3<sup>dly</sup>, When the chord is greatest, viz. when it is a diameter, then the segments are equal, viz. each a semicircle.

19. Any part of a circle (less than a semicircle) contained between two radii and an arc, is called a *sector*; thus the space contained between the two radii, AC, BC, and the arc AB, is called the sector; fig. 12.

20. The right line of any arc, is a line drawn perpendicular from one end of the arc, to a diameter drawn through the other end of the same arc; thus (fig. 13.) AD is the right sine of the arc AB, it being a line drawn from A, the one end of the arc AB, perpendicular to CB, a diameter passing through B, the other end of the arc AB.

Now the lines standing on the same diameter, still increase till they come to the centre, and then becoming the radius, it is plain that the radius EC is the greatest possible sine, and for that reason it is called the *whole sine*.

Since the whole-sine EC must be perpendicular to the a diameter FB (by def. 20.) therefore producing the diameter EG, the two diameters FB, EG, must cross one another at right angles, and so the circumference of the circle must be divided by them into four parts EB, BG, GF, and FE, and these four parts are equal to one another (by def. 10.) and so EB a quadrant, or fourth part of the circumference; therefore the radius EC is always the sine of the quadrant, or fourth part of the circle EB.

Sines are said to be of so many degrees, as the arc contains parts of the 360, into which the circumference is supposed to be divided; so the radius being the sine of a quadrant, or fourth part of the circumference, which contains 90 degrees (the fourth part of 360), therefore the radius must be the sine of 90 degrees.

21. The part of the radius comprehended between the extremity of the right line and the lower end of the arc, *viz.* DB, is called the *versed line* of the arc AB.

22. If to any point in the circumference, *viz.* B, there be drawn a diameter FCB, and from the point B, perpendicular to that diameter, there be drawn the line BH; that line is called a *tangent* to the circle in the point B; which tangent can touch the circle only in one point B, else if it touched it in more, it would go within it, and so not be a tangent but a chord, (by art. 17.)

23. The tangent of any arc AB, is a right line drawn perpendicular to a diameter through the one end of the arc B, and terminated by a line CAH, drawn from the centre through the other end A; thus BH is the tangent of the arch AB.

24. And the line which terminates the tangent, *viz.* CH, is called the *secant* of the arc AB.

25. What an arc wants of a quadrant is called the *complement* of that arc; thus AE, being what the arc AB wants of the quadrant EB, is called the complement of the arc AB.

26. And what an arc wants of a semicircle is called the *supplement* of that arc; thus since AF is what the arc AB wants of the semicircle BAF, it is the supplement of the arc AB.

27. The sine, tangent, &c. of the complement of any arc, is called the *co-sine*, *co-tangent*, &c. of that arc; thus the sine, tangent, &c. of the arc AE is called the co-sine, co-tangent, &c. of the arc AB.

28. The sine of the supplement of an arc is the same with the sine of the arc itself; for, drawing them according to the definitions, there results the self-same line.

29. A right-lined angle is measured by an arc of a circle described upon the angular point as a centre, comprehended between the two legs that form the angle; thus (fig. 14.) the angle ABD is measured by the arc AD of the circle CADE that is described upon the point B as a centre; and the angle is said to be of as many degrees as the arc is; so if the arc AD be 45 degrees, then the angle ABD is said to be an angle of 45 degrees.

Hence the angles are greater or less, according as the arc described about the angular point and terminated by the two legs contain a greater or a less number of degrees.

30. When one line falls perpendicularly on another, as AB on CD, fig. 15. then the angles are right (by the 10th def.); and describing a circle on the centre B, since the angles ABC ABD are equal, their measures must be so too, *i. e.* the arcs AC AD must be equal; but the whole CAD is a semicircle, since CD, a line passing through the centre B, is a diameter; therefore each of the parts AC AD is a quadrant, *i. e.* 90 degrees; so the measure of a right angle is always 90 degrees.

31. If one line AB fall any way upon another, CD, then the sum of the two angles ABC ABD is always equal to the sum of two right angles; fig. 16. For on the point B, describing the circle CAD, it is plain, that CAD is a semicircle (by the 14th); but CAD is equal to CA and AD the measure of the two angles; therefore the sum of the two angles is equal to a semicircle, that is, to two right angles, (by the last).

*Cor. 1.* From whence it is plain, that all the angles which can be made from a point in any line, towards one side of the line, are equal to two right angles.

2. And that all the angles which can be made about a point, are equal to four right ones.

32. If one line AC cross another BD in the point E, then the opposite angles are equal, *viz.* BEA to CED, and BEC equal to AED; fig. 17. For upon the point E, as a centre, describing the circle ABCD, it is plain ABC is a semicircle, as also BCD (by the 14th); therefore the arc ABC is equal to the arc BCE; and from both taking the common arc BC, there will remain AB equal to CD, *i. e.* the Angle BEA equal to the angle CED (by art. 29.). After the same manner we may prove, that the angle BEC is equal to the angle AED.

33. Lines which are equally distant from one another, are called *parallel lines*; as AB, CD, fig. 18.

34. If a line GH cross two parallels AB, CD, (fig. 19.) then the external opposite angles are equal, *viz.* GEB equal to CFH and AEG equal to HFD. For since AB and CD are parallel to one another, they may be considered as one broad line, and GH crossing it; then the vertical or opposite angles GEB CFG are equal (by art. 32.), as also AEG and HFD by the same.

35. If a line GH cross two parallels AB CD, then the alternate angles, *viz.* AEF and EFD, or CFE and FEB, are equal; that is, the angle AEF is equal to the angle EFD, and the angle CFE is equal to the angle FEB, for GEB is equal to AEF (by art. 32.), and CFH is equal to EFD (by the same); but GEB is equal to CFH (by the last); therefore AEF, is equal to EFD. The same way we may prove FEB equal to EFC.

36. If a line GH cross two parallel lines AB, CD, then the external angle GEB is equal to the internal opposite one EFD, or GEA equal to CFE. For the angle AEF is equal to the angle EFD (by the last); but AEF is equal to GEB (by art. 32.), therefore GEB is equal to EFD. The same way we may prove AEG equal to CFE.

37. If a line GH cross two parallel lines AB CD, then the sum of the two internal angles, *viz.* BEF and DFE, or AEF and CFE, are equal to two right angles; for since the angle GEB is equal to the angle EFD (by art. 36.), to both add the angle FEB, then GEB and BEF are equal to BEF and DFE; but GEB and BEF are equal to two right angles (by art. 31.) therefore BEF and DFE are also equal to two right angles. The same way we may prove that AEF and CFE are equal to two right angles.

39. A figure is any part of space bounded by lines or a line. If the bounding lines be strait, it is called a *rectilinear figure*, as A, fig. 20. if they be curved, it is called a *curvilinear figure*, as B or C, fig. 21. and fig. 22. if they be partly curve lines and partly strait, it is called a *mixt figure*, as D, fig. 23.

35. The most simple rectilinear figure is that which is bounded by three right lines, and is called a *triangle*, as A, fig. 24.

40. Triangles are divided into different kinds, both with respect to their sides and angles: with respect to their sides they are commonly divided into three kinds, *viz.*

41. A triangle having all its three sides equal to one another, is called an *equilateral triangle*, as A, fig. 25.

42. A triangle having two of its sides equal to one another, and the third side not equal to either of them, is called an *isosceles triangle*, as B, fig. 26.

43. A triangle having none of its sides equal to one another, is called a *scalene triangle*, as C, fig. 27.

44. Triangles, with respect to their angles, are divided into three different kinds, *viz.*

45. A triangle having one of its angles right, is called a *right-angled triangle*, as A, fig. 28.

46. A triangle having one of its angles obtuse, or greater than a right angle, is called an *obtuse-angled triangle*, as B, fig. 29.

47. Lastly, a triangle having all its angles acute, is called an *acute-angled triangle*, as C, fig. 30.

48. In all right-angled triangles, the sides comprehending the right angle are called the *legs*, and the side opposite to the right angle is called the *hypotenuse*. Thus in the right-angled triangle ABC, fig. 31. (the right angle being at B) the two sides AB and BC, which comprehend the right angle ABC, are the legs of the triangle; and the side AC, which is opposite to the right angle ABC, is the *hypotenuse* of the right-angled triangle ABC.

49. Both obtuse and acute angled triangles are in general called *obliquely-angled triangles*; in all which any side is called the *base*, and the other two the *sides*.

50. The perpendicular height of any triangle is a line drawn from the vertex to the base perpendicularly; thus if the triangle ABC (fig. 32.) be proposed, and BC be made its base, then A will be the vertex, *viz.* the angle opposite to the base; and if from A you draw the line AD perpendicular to BC, then the line AD is the height of the triangle ABC standing on BC as its base.

Hence all triangles standing between the same parallels have the same height, since all the perpendiculars are equal by the nature of parallels.

51. A figure bounded by four sides is called a *quadrilateral* or *quadrangular figure*, as ABDC, fig. 33.

52. Quadrilateral figures whose opposite sides are parallel, are called *parallelograms*. Thus in the quadrilateral figure ABDC, if the side AC be parallel to the side BD which is opposite to it, and AB be parallel to CD, then the figure ABDC is called a parallelogram.

53. A parallelogram having all its sides equal and angles right, is called a *square*, as A, fig. 34.

54. That which hath only the opposite sides equal and its angles right, is called a *rectangle*, as B, fig. 35.

55. That which hath equal sides but oblique angles, is called a *rhombus*, as C, fig. 36. and is just an inclined square.

56. That which hath only the opposite sides equal and the angles oblique, is called a *rhomboides*, as D, fig. 37. and may be conceived as an inclined rectangle.

57. When none of the sides are parallel to another, then the quadrilateral figure is called a *trapezium*.

58. Every other right lined figure, that has more sides than four, is in general called a *polygon*. And figures are called by particular names according to the number of their sides, *viz.* one of five sides is called a *pentagon*, of

six a *hexagon*, of seven a *heptagon*, and so on. When the sides forming the polygon are equal to one another, the figure is called a regular figure or polygon.

59. In any triangle ABC (fig. 28.) one of its legs, as BC, being produced towards D, the external angle ACD is equal to both the internal opposite ones taken together, *viz.* to ABC and BAC. In order to prove this, through C draw CE parallel to AB; then since CE is parallel to AB, and the lines AC and BD cross them, the angle ECD is equal to ABC (by art. 36.) and the angle ACE equal to CAB (by art. 35.); therefore the angles ECD and ECA are equal to the angles ABC and CAB; but the angles ECD and ECA are together equal to the angle ACD; therefore the angle ACD is equal to both the angles ABC and CAB taken together.

*Cor.* Hence it may be proved, that if two lines AB and CD (fig. 39.) be crossed by a third line EF, and the alternate angles AEF and EFD be equal, the lines AB and CD will be parallel; for if they are not parallel, they must meet one another on one side of the line EF (suppose at G) and so form the triangle EFG, one of whose sides GE being produced to A, the exterior angle AEF must (by this article) be equal to the sum of the two angles EFG and EGF; but, by supposition, it is equal to the angle EFG alone; therefore the angle AEF must be equal to the sum of the two angles EFG and EGF, and at the same time equal to the angle EFG alone, which is absurd; so the lines AB and CD cannot meet, and therefore must be parallel.

60. In any triangle ABC, all the three angles taken together are equal to two right angles. To prove this, you must produce BC, one of its legs, to any distance, suppose to D; then by the last proposition, the external angle, ACD, is equal to the sum of the two internal opposite ones CAB and ABC; to both add the angle ACB, then the sum of the angles ACD and ACB will be equal to the sum of the angles CAB and CBA and ACB. But the sum of the angles ACD and ACB, is equal to two right ones (by art. 32.); therefore the sum of the three angles CAB and CBA and ACB, is equal to two right angles; that is, the sum of the three angles of any triangle ACB is equal to two right angles.

*Cor.* 1. Hence in any triangle given, if one of its angles be known, the sum of the other two is also known: for since (by the last) the sum of all the three is equal to two right angles, or a semicircle, it is plain, that taking any one of them from a semicircle or 180 degrees, the remainder will be the sum of the other two. Thus (in the former triangle ABC) if the angle ABC be 40 degrees, by taking 40 from 180 we have 140 degrees; which is the sum of the two angles BAC, ACB: the converse of this is also plain, *viz.* the sum of any two angles of a triangle being given, the other angle is also known by taking that sum from 180 degrees.

2. In any right-angled triangle, the two acute angles must just make up a right one between them; consequently, any one of the oblique angles being given, we may find the other by subtracting the given one from 90 degrees, which is the sum of both.

61. If in any two triangles, ABC (fig. 40.) DEF (fig. 41.) two legs of the one, *viz.* AB and AC, be equal to

two legs in the other, *viz.* to DE and DF, each to each respectively, *i. e.* AB to DE, and AC to DF; and if the angles included between the equal legs be equal, *viz.* the angle BAC equal to the angle EDF; then the remaining leg of the one shall be equal to the remaining leg of the other, *viz.* BC to EF; and the angles opposite to equal legs shall be equal, *viz.* ABC equal to DEF (being opposite to the equal legs AC and DF), also ACB equal to DFE (which are opposite to the equal legs AB and DE). For if the triangle ABC be supposed to be lifted up and put upon the triangle DEF, and the point A on the point D; it is plain, since BA and DE are of equal length, the point E will fall upon the point B; and since the angles BAC EDF are equal, the line AC will fall upon the line DF; and they being of equal length, the point C will fall upon the point F; and so the line BC will exactly agree with the line EF, and the triangle ABC will in all respects be exactly equal to the triangle DEF; and the angle ABC will be equal to the angle DEF, also the angle ACB will be equal to the angle DFE.

*Cor. 1.* After the same manner it may be proved, that if in any two triangles ABC, DEF, (see the preceding figure) two angles ABC and ACB of the one, be equal to two angles DEF and EFD of the other, each to each respectively, *viz.* the angle ABC to the angle DEF, and the angle ACB equal to the angle DFE, and the sides included between these angles be also equal, *viz.* BC equal to EF, then the remaining angles and the sides opposite to the equal angles, will also be equal each to each respectively; *viz.* the angle BAC equal to the angle BDF, the side AB equal to DE, and AC equal to DF: for if the triangle ABC be supposed to be lifted up and laid upon the triangle DEF, the point B being put upon the point E, and the line BC upon the line EF, since BC and EF are of equal lengths, the point C will fall upon the point F, and since the angle ACB is equal to the angle DFE, the line CA will fall upon the line FD, and by the same way of reasoning the line BA will fall upon the line ED; and therefore the point of intersection of the two lines BA and CA, *viz.* A, will fall upon the point of intersection of the two lines ED and FD, *viz.* D, and consequently BA will be equal to DE, and AC equal to DF, and the angle BAC equal to the angle EDF.

*Cor. 2.* It follows likewise from this article, that if any triangle ABC (fig. 42.) has two of its sides AB and AC equal to one another, the angles opposite to these sides will also be equal, *viz.* the angles ABC equal to the angle ACB. For suppose the line AD, bisecting the angle BAC, or dividing it into two equal angles BAD and CAD, and meeting BC in D, then the line AD will divide the whole triangle BAC into two triangles ABD and DAC; in which BA and AD two sides of the one, are equal to CA and AD two sides of the other, each to each respectively, and the included angles BAD and DAC are by supposition equal; therefore (by this article) the angle ABC must be equal to the angle ACB.

*62. Any angle, as BAD, (fig. 43.) at the circumference of a circle BADE, is but half the angle BCD at the centre standing on the same arch BED.* To demonstrate this, draw through A and the centre C, the right

line ACE, then the angle ECD is equal to both the angles DAC and ADG (by art. 59.); but since AC and CD are equal (being two radii of the same circle) the angles subtended by them must be equal also, (by art. 62. cor. 2.) *i. e.* the angle CAD equal to the angle CDA; therefore the sum of them is double any one of them, *i. e.* DAC and ADC is double of CAD, and therefore ECD is also double of DAC: the same way it may be proved, that ECB is double of CAB; and therefore the angle BCD is double of the angle BAD, or BAD the half of BCD, which was to be proved.

*Cor. 1.* Hence an angle at the circumference is measured by half the arc it subtends; for the angle at the centre (standing on the same arc) is measured by the whole arc (by art. 29); but since the angle at the centre is double that at the circumference, it is plain the angle at the circumference must be measured by only half the arc it stands upon.

*Cor. 2.* Hence all angles, ACB, ADB, AEB, &c. (fig. 44.) at the circumference of a circle, standing on the same chord AB, are equal to one another; for by the last corollary they are all measured by the same arc, *viz.* half the arc AB which each of them subtends.

*Cor. 3.* Hence an angle in a segment greater than a semicircle is less than a right angle: thus, if ADB be a segment greater than a semicircle, (see the last figure) than the arc AB, on which it stands, must be less than a semicircle, and the half of it less than a quadrant or a right angle; but the angle ADB in the segment is measured by the half of AB, therefore it is less than a right angle.

*Cor. 4.* An angle in a semicircle is a right angle. For since ABD (fig. 45.) is a semicircle, the arc AED must also be a semicircle: but the angle ABD is measured by half the arc AED, that is, by half a semicircle or quadrant; therefore the angle ABD is a right angle.

*Cor. 5.* Hence an angle in a segment less than a semicircle, as ABD, (fig. 46.) is greater than a right angle: for since the arc ABD is less than a semicircle, the arc AED must be greater than a semicircle, and so it is half greater than a quadrant, *i. e.* than the measure of a right angle; therefore the angle ABD, which is measured by half the arc AED, is greater than a right angle.

*63. If from the centre C of the circle ABE, (fig. 47.) there be let fall the perpendicular CD on the chord AB, then that perpendicular will bisect the chord AB in the point D.* To demonstrate this, draw from the centre to the extremities of the chord the two lines CA, CB; then since the lines CA and CB are equal, the angles CAB, CBA, which they subtend must be equal also, (by art. 62. cor. 2.) but the perpendicular CD divides the triangle ACB into two right-angled triangles ACD and CDB, in which the sum of the angles ACD and CAD in the one, is equal to the sum of the angles DCB and CBD in the other, each being equal to a right angle, (by cor. 2. of art. 61.) but CAD is equal to CBD, therefore ACD is equal to BCD. So in the two triangles ACD and BCD, the two legs AC and CD in the one, are equal to the two legs BC and CD in the other, each to each respectively, and the included angles ACD and BCD are equal; therefore the remaining legs AD and BD are equal (by art. 61.) and consequently AB bisected in D.

83. If from the centre C of a circle ABE, there be drawn a perpendicular CD on the chord AB, and produced till it meet the circle in F, then the line CF bisects the arch AB in the point F; for (see the foregoing figure) joining the points A and F, F and B by the straight lines AF, FB, then in the triangles ADF, BDF, AD is equal to DB (by art. 63.) and DF common to both; therefore AD and DF, two legs of the triangle ADF, are equal to BD and DF, two legs of the triangle BDF, and the included angles ADF, BDF are equal, being both right; therefore (by art. 61) the remaining legs AF and FB are equal; but in the same circle equal lines are chords of equal arches, therefore the arches AF and FB are equal. So the whole arch AFB is bisected in the point F by the line CF.

Cor. 1. From art. 63. it follows, that any line bisecting a chord at right angles is a diameter; for since (by art. 63.) a line draw from the centre perpendicular to a chord, bisects that chord at right angles; therefore, conversely, a line bisecting a chord at right angles, must pass thro' the centre, and consequently be a diameter

Cor. 2. From the two last articles it follows, that the sine of any arc is the half of the chord of twice the arc; for (see the foregoing scheme) AD is the sine of the arc AF, by the definition of a sine, and AF is half the arc AFB, and AD half the chord AB (by art. 63.); therefore the cor. is plain.

65. In any triangle, the half of each side is the sine of the opposite angle; for if a circle be supposed to be drawn through the three angular points A, B, and D of the triangle ABD, fig. 48. then the angle DAB is measured by half the arch BKD (by cor. 1. of art. 62.) but the half of BD, viz. BE, is the sine of half the arch BKD, viz. the sine of BK (by cor. 2. of the last) which is the measure of the angle BAD; therefore the half of BD is the sine of the angle BAD; the same way it may be proved, that the half of AD is the sine of the angle ABD, and the half of AB is the sine of the angle ADB.

66. The sine, tangent, &c. of any arch is called also the sine, tangent, &c. of the angle whose measure the arc is: thus because the arc GD (fig. 49.) is the measure of the angle GCD; and since GH is the sine, DE the tangent, HD the versed sine, CE the secant, also GK the co-sine, BF the co-tangent, and CF the co-secant, &c. of the arch GD; then GH is called the sine, DE the tangent, &c. of the angle GCD, whose measure is the arch GD.

67. If two equal and parallel lines, AB and CD (fig. 50.) be joined by two others, AC and BD; then these shall also be equal and parallel. To demonstrate this, join the two opposite angles A and D with the line AD; then it is plain this line AD divides the quadrilateral, ACDB, into two triangles, viz. ABD, ACD, in which AB a leg of the one, is equal to DC a leg of the other, by supposition, and AD is common to both triangles; and since AB is parallel to CD, the angle BAD will be equal to the angle ADC, (by art. 36.) therefore in the two triangles BA and AD; and the angle BAD is equal to CD and DA; and the angle ADC, that is, two legs and the included angle in the one, is equal to two legs and the included angle in the other; therefore (by art. 61) BD is equal to AC, and since the angle DAC

is equal to the angle ADB, therefore the lines BD AC are parallel (by cor. art. 59.)

Cor. 1. Hence it is plain, that the quadrilateral ABDC is a parallelogram, since the opposite sides are parallel.

Cor. 2. In any parallelogram the line joining the opposite angles (called the diagonal) as AD, divides the figure into two equal parts, since it has been proved that the triangles ABD ACD are equal to one another.

Cor. 3. It follows also, that a triangle ACD on the same base CD, and between the same parallels with a parallelogram ABDC, is the half of that parallelogram.

Cor. 4. Hence it is plain, that the opposite sides of a parallelogram are equal; for it has been proved, that ABDC being a parallelogram, AB will be equal to CD, and AC equal to BD.

68. All parallelograms on the same or equal bases, and between the same parallels, are equal to one another; that is, if BD and GH (fig. 51.) be equal, and the lines BH and AF be parallel, then the parallelograms ABDC, BDFE, and EFHG, are equal to one another. For AC is equal to EF, each being equal to BD, (by cor. 4. of 67.) To both add CE, then AE will be equal CF. So in the two triangles ABE CDF, AB a leg of the one, is equal to CD a leg in the other; and AE is equal to CF, and the angle BAE is equal to the angle DCF (by art. 36.); therefore the two triangles ABE CDF are equal (by art. 61.); and taking the triangle CKE from both, the figure ABKC will be equal to the figure KDFE; to both which add the little triangle KBD, then the parallelogram ABDC will be equal to the parallelogram BDFE. The same way it may be proved, that the parallelogram EFHG is equal to the parallelogram EFDB; so the three parallelograms ABDC, BDFE, and EFHG will be equal to one another.

Cor. Hence it is plain, that triangles on the same base, and between the same parallels, are equal; since they are the half of the parallelograms on the same base and between the same parallels. (by cor. 3. of last art.)

69. In any right-angled triangle, ABC, (fig. 52.) the square of the hypotenuse BC, viz. BCMH, is equal to the sum of the squares made on the two sides AB and AC, viz. to ABDE and ACGF. To demonstrate this, through the point A draw AKL perpendicular to the hypotenuse BC, join AH, AM, DC, and BG; then it is plain that DB is equal to BA (by art. 53.), also BH is equal to BC (by the same); so in the two triangles DBC ABH, the two legs DB and BC in the one are equal to the two legs AB and BH in the other; and the included angles DBC and ABH are also equal; (for DBA is equal to CBH, being both right; to each add ABC, then it is plain that DBC is equal to ABH) therefore the triangles DBC ABH are equal (by art. 61.) but the triangle DBC is half of the square ABDE (by cor. 3. of 67th) and the triangle ABH is half the parallelogram BKLIH (by the same), therefore half the square ABDE is equal to half the parallelogram BKLIH. Consequently the square ABDE is equal to the parallelogram BKLIH. The same way it may be proved, that the square ACGF is equal to the parallelogram KCML. So the sum of the squares ABDE and ACGF is equal the sum of the parallelograms BKLIH and KCML, but the sum of these parallelograms is equal to the square BCMH, therefore the

sum of the squares on  $AB$  and  $AC$  is equal to the square on  $BC$ .

*Cor. 1.* Hence in a right-angled triangle, the hypotenuse and one of the legs being given, we may easily find the other, by taking the square of the given leg from the square of the hypotenuse, and the square root of the remainder will be the leg required.

*Cor. 2.* Hence, the legs in a right-angled triangle being given, we may find the hypotenuse, by taking the sum of the squares of the given legs, and extracting the square root of that sum.

70. If upon the line  $AB$  (fig. 53.) there be drawn a semicircle  $ADB$ , whose centre is  $C$ , and on the point  $C$  there be raised a perpendicular to the line  $AB$ , *viz.*  $CD$ ; then it is plain the arc  $DB$  is a quadrant, or contains 90 degrees; suppose the arc  $DB$  to be divided into 9 equal arcs, each of which will contain 10 degrees, then on the point  $B$  raising  $BE$  perpendicular to the line  $AB$ , it will be a tangent to the circle in the point  $B$ , and if to every one of the divisions of the quadrant, *viz.*  $B 10$ ,  $B 20$ ,  $B 30$ ,  $B 40$ , &c. you draw the sine, tangent, &c. (as in the scheme) we shall have the sine, tangent, &c. to every ten degrees in the quadrant: and the same way we may have the sine, tangent, &c. to every single degree in the quadrant, by dividing it into 90 equal parts beginning from  $B$ , and drawing the sine, tangent, &c. to all the arcs beginning at the same point  $B$ . By this method they draw the lines of sines, tangents, &c. of a certain circle on the scale; for after drawing them on the circle, they take the length of them, and set them off in the lines drawn for that purpose. The same way, by supposing the radius of any number of equal parts, (suppose 1000, or 10,000, &c.) it is plain the sine, tangent, &c. of every arc must consist of some number of these equal parts; and by computing them in parts of the radius, we have tables of sines, tangents, &c. to every arc in the quadrant, called natural sines, tangents, &c. and the logarithms of these give us tables of logarithmic sines, tangents, &c. See LOGARITHMS.

71. In any triangle,  $ABC$ , (Plate XCIV. fig. 1.) if one of its sides, as  $AC$ , be bisected in  $E$ , (and consequently  $AC$  double of  $AE$ ) and through  $E$  be drawn  $ED$ , parallel to  $BC$ , and meeting  $AB$  in  $D$ , then  $BC$  will be double of  $ED$ , and  $AB$  double of  $AD$ , through  $D$  draw  $DF$ , parallel to  $AC$ , meeting  $BC$  in  $F$ : for since, by construction,  $DF$  is parallel to  $AC$ , and  $DE$  parallel to  $BC$ ; therefore, (by art. 36.) the angle  $BFD$  will be equal to the angle  $BCA$ , (and by the same article) the angle  $BCA$  will be equal to the angle  $DEA$ , consequently the angle  $BFD$  will be equal to the angle  $DEA$ ; also, (by art. 36.) the angle  $BDF$  will be equal to the angle  $DAE$ ; and since  $DF$  is parallel to  $EC$ , and  $DB$  parallel to  $FC$ , the quadrilateral  $DFCE$  will be a parallelogram; and therefore, (by art. 59. cor. 4.)  $DF$  will be equal to  $EC$ , which, by construction, is equal to  $AE$ ; so in the two triangles  $BDF$   $DAE$ , the two angles  $BFD$  and  $BDF$  in the one, are equal to the two angles  $DBA$  and  $DAE$  in the other, each to each respectively; and the included side  $DF$ , is equal to the included side  $AE$ ; therefore, (by art. 61. cor. 1.)  $AD$  will be equal to  $DB$ , and consequently  $AB$  double of  $AD$ ;

also (by the same)  $DE$  will be equal to  $BF$ ; but  $DE$  is also (by art. 67. cor. 4.) equal to  $FC$ ; therefore  $BF$  and  $FC$  together, or  $BC$ , will be double of  $DE$ .

After the same manner it may be proved, that if in the triangle  $AKG$ , (fig. 2.)  $AE$  be taken equal to a third part of  $AK$ , and through  $E$  be drawn  $ED$ , parallel to  $KG$ , and meeting  $AG$  in  $D$ ; then  $ED$  will be equal to a third part of  $GK$ , and  $AD$  equal to a third part of  $AG$ .

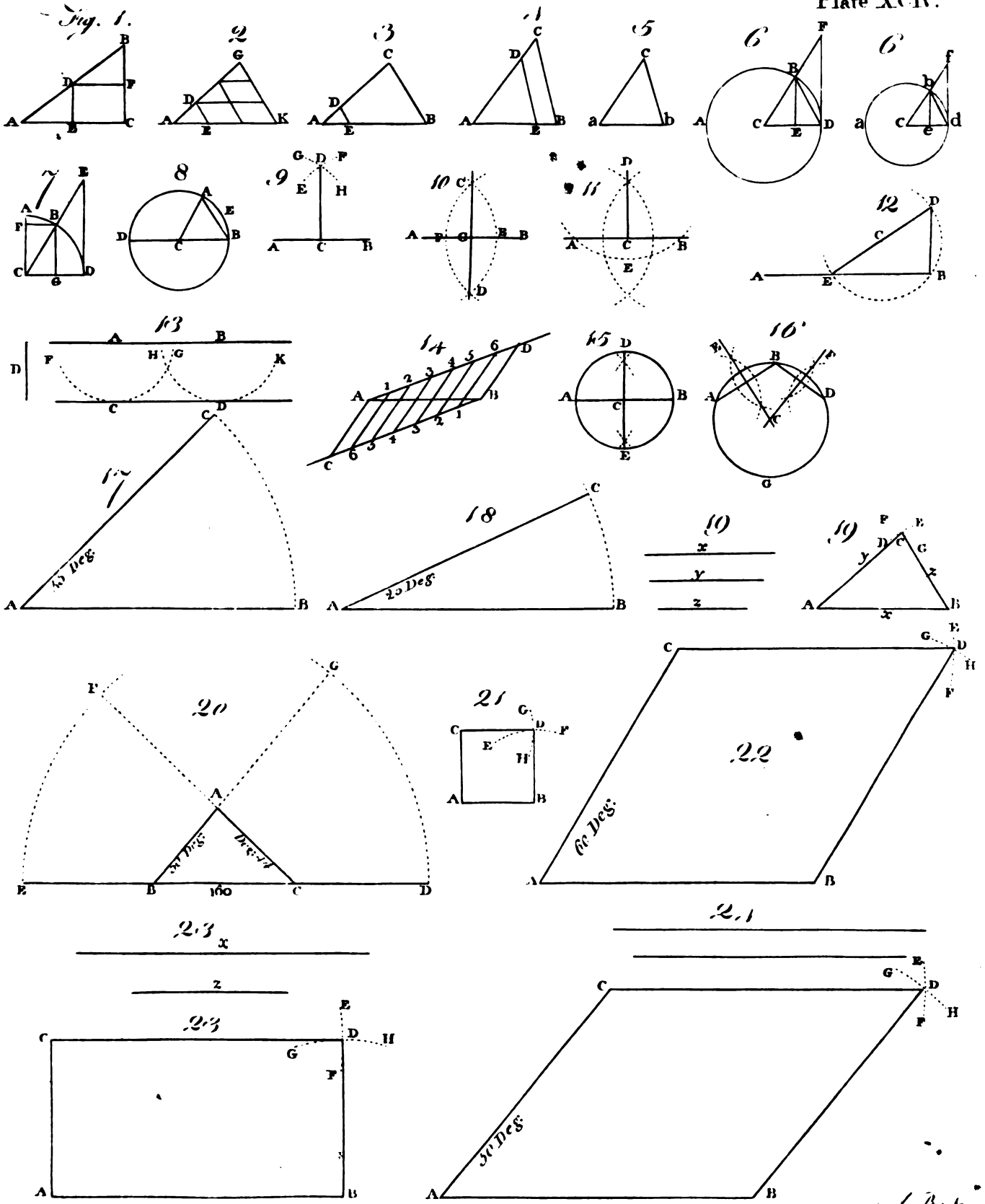
Likewise if in any triangle  $ABC$ , (fig. 3.) upon the side  $AB$ , be taken  $AE$ , equal to one fourth, one fifth, one sixth, &c. of  $AB$ , and through  $E$  be drawn  $ED$  parallel to  $BC$  and meeting  $AC$  in  $D$ ; then  $DE$  will be one fourth, one fifth, one sixth, &c. of  $BC$ , and  $AD$  the like part of  $AC$ ; and, in general, if in any triangle  $ABC$ , there be assumed a point  $E$  on one of its sides  $AB$ , and through that point be drawn a line  $ED$ , parallel to one of its sides  $BC$ , and meeting the other side  $AC$  in  $D$ ; then whatever part  $AE$  is of  $AB$ , the same part will  $ED$  be of  $BC$ , and  $AD$  of  $AC$ .

*Cor.* Hence it follows, that if in any triangle  $ABC$ , there be drawn  $ED$ , parallel to one of its sides  $BC$ , and meeting the other two in the points  $E$  and  $D$ , then  $AE : AB :: ED : BC :: AD : AC$ ; that is,  $AE$  is to  $AB$ , as  $ED$  is to  $BC$ , and that as  $AD$  to  $AC$ .

72. If any two triangles  $ABC$ , fig. 4.  $abc$ , fig. 5. are similar, or have all the angles of the one equal to all the angles of the other, each to each respectively; that is, the angle  $CAB$  equal to the angle  $cab$ , and the angle  $ABC$  equal to the angle  $abc$ , and the angle  $ACB$  equal to the angle  $acb$ ; then the legs opposite to the equal angles are proportioned, *viz.*  $AB : ab :: AC : ac ::$  and  $AB : ab :: BC : bc ::$  and  $AC : ac :: BC : bc$ . On  $AB$  of the largest triangle set off  $AE$  equal to  $ab$ , and through  $E$  draw  $ED$  parallel to  $BC$ , meeting  $AC$  in  $D$ ; then since  $DE$  and  $BC$  are parallel, and  $AB$  crossing them, the angle  $AED$  will (by art. 36.) be equal to the angle  $ABC$ , which (by supposition) is equal to the angle  $abc$ , also the angle  $DAE$  is (by supposition) equal to the angle  $cab$ ; so in the two triangles  $AED$ ,  $abc$ , the two angles  $DAE$   $AED$  of the one, are equal to two angles  $cab$   $abc$  of the other, each to each respectively, and the included side  $AE$  is (by construction) equal to the included side  $ab$ ; therefore, (by art. 61. cor. 1.)  $AD$  is equal to  $ac$ , and  $DE$  equal to  $cb$ ; but since, in the triangle  $ABC$ , there is drawn  $DE$  parallel to  $BC$  one of its sides, and meeting the two other sides in the points  $D$  and  $E$ , therefore (by cor. art. 71.)  $AB : AE :: AC : AD$ , and  $AB : AE :: BC : DE$ , and  $AC : AD :: BC : DE$ ; and in the three last proportions, instead of the lines  $AE$ ,  $DE$ , and  $AD$ , putting in their equals  $ab$ ,  $bc$ , and  $ac$ , we shall have  $AB : ab :: AC : ac$ , and  $AB : ab :: BC : bc$ , and lastly,  $AC : ac :: BC : bc$ .

73. The chord, sine, tangent, &c. of any arc in one circle, is to the chord, sine, tangent, &c. of the same arc in another, as the radius of the one is to the radius of the other, fig. 6. 6. Let  $ABD$   $abd$  be two circles,  $BD$   $bd$  two arcs of these circles, equal to one another, or consisting of the same number of degrees;  $FD$   $fd$  the tangents,  $BD$   $bd$  the chords,  $BE$   $be$  the sines, &c.





L. B. C. C.



∴ of these two arcs  $BD$   $bd$ , and  $CD$   $cd$  the radii of the circles; then say,  $CD : cd :: FD : fd$ , and  $CD : cd :: BD : bd$ , and  $CD : cd :: BE : be$ , &c. For since the arcs  $BD$   $bd$  are equal, the angles  $BCD$   $bcd$  will be equal; and  $FD$   $fd$ , being tangents to the points  $D$  and  $d$ , the angles  $CDF$   $cdf$  will be equal, being each a right angle (art. 22.) so in the two triangles  $CDF$   $cdf$ , the two angles  $FCD$   $CDf$  of the one, being equal to the two angles  $fcd$   $cd f$  of the other, each to each, the remaining angle  $CFD$ , will be equal to the remaining angle  $cf d$ , (by art. 60.); therefore the triangles  $CFD$   $cf d$  are similar, and consequently (by art. 73)  $CD : cd :: FD : fd$ . In the same manner it may be demonstrated, that  $CD : cd :: BD : bd$ , and  $CD : cd :: BE : be$ , &c.

74. Let  $ABD$  (fig. 7.) be a quadrant of a circle described by the radius  $CD$   $BD$  any arc of it, and  $BA$  its complement,  $BG$  or  $CF$  the sine,  $CG$  or  $BF$  the cosine,  $DE$  the tangent, and  $CE$  the secant of that arc  $BD$ . Then since the triangles  $CDE$   $CGB$  are similar or equiangular, it will be (by art. 72.)  $DE : EC :: GB : BC$ , *i. e.* the tangent of any arc, is to the secant of the same, as the sine of it is to the radius. Also since  $DE : EC :: GB : BC$ ; therefore, by inverting that proportion, we have  $EC : DE :: BC : GB$ , *i. e.* the secant is to the tangent, as the radius is to the sine of any arc.

Again, since the triangles  $CDE$   $CGB$  are similar, therefore (by art. 72.) it will be  $CD : CE :: CG : CB$ , *i. e.* as the radius is to the secant of any arc, so is the cosine of that arc to the radius. And by inverting the proportion we have this, *viz.* As the secant of any arc is to the radius, so is the radius to the co-sine of that arc.

75. In all circles the chord of 60 is always equal in length to the radius. Thus in the circle  $AEBD$ , (fig. 8.) if the arc  $AEB$  be an arc of 60 degrees, then drawing the chord  $AB$ , I say  $AB$  shall be equal to the radius  $CB$  or  $AC$ ; for in the triangle  $ACB$ , the angle  $ACB$  is 60 degrees, being measured by the arc  $AEB$ ; therefore the sum of the other two angles is 120 degrees, (by *cor.* 1. of 60.); but since  $AC$  and  $CB$  are equal to the two angles  $CAB$ ,  $CBA$  will also be equal; consequently each of them half their sum 120, *viz.* 60 degrees; therefore all the three angles are equal to one another, consequently all the legs, therefore  $AB$  is equal to  $CB$ .

*Cor.* Hence the radius from which the lines on any scale are formed, is the chord of 60 on the line of chords.

### Geometrical Problems.

**PROB. 1.** From a point  $C$  (fig. 9.) in a given line  $AB$  to raise a perpendicular to that line.

*Rule.* From the point  $C$  take the equal distances  $CB$ ,  $CA$  on each side of it. Then stretch the compasses to any distance greater than  $CB$  or  $CA$ , and with one foot of them in  $B$ , sweep the arc  $EF$  with the other; again, with the same opening, and one foot in  $A$ , sweep the arc  $GH$  with the other, and these two arcs will intersect one another in the point  $D$ ; then join the given points  $C$  and  $D$  with the line  $CD$ , and that shall be the perpendicular required.

2. To divide a given right line  $AE$  (fig. 10.) into two equal parts; that is, to bisect it.

*Rule.* Take any distance with your compasses that you are sure is greater than half the given line; then setting one foot of them in  $B$ , with the other sweep the arc  $DFC$ ; and with the same distance, and one foot in  $A$ , with the other sweep the arc  $CLD$ ; these two arcs will intersect one another in the points  $C$   $D$ , which joined by the right line  $DC$  will bisect  $AB$  in  $G$ .

3. From a given point  $D$ , (fig. 11.) to let fall a perpendicular on a given line  $AB$ .

*Rule.* Set one foot of the compasses in the point  $D$ , and extend the other to any distance greater than the least distance between the given point and the line, and with that extent sweep the arc  $AEB$ , cutting the line in the two points  $A$  and  $B$ , then (by the last prob.) bisect the line  $AB$  in the point  $C$ , lastly join  $C$  and  $D$ , and that line  $CD$  is the perpendicular required.

4. (Fig. 12.) Upon the end  $B$  of a given right line  $BA$ , to raise a perpendicular.

*Rule.* Take any extent in your compasses, and with one foot in  $B$  fix the other in any point  $C$  without the given line; then with one point of the compasses in  $C$ , describe with the other the circle  $EBD$ , and thro'  $E$  and  $C$  draw the diameter  $ECD$  meeting the circle in  $D$ ; join  $D$  and  $B$ , and the right line  $DB$  is that required; for  $EBD$  is a right angle (by *cor.* 4. of 63.).

5. (Fig. 13.) To draw one line parallel to another given line  $AB$ , that shall be distant from one another by any given distance  $D$ .

*Rule.* Extend your compasses to the given distance  $D$ ; then setting one foot of them in any point of the given line (suppose  $A$ ), with the other sweep the arc  $FCG$ ; again, at the same extent, and one foot in any other point of the given line  $B$ , sweep the arc  $HDK$ , and draw the line  $CD$  touching them, and that will be parallel to the given line  $AB$ , and distant from it by the line  $D$  as was required.

6. (Fig. 14.) To divide a given line  $AB$  into any number of equal parts, suppose 7.

*Rule.* From the point  $A$  draw any line  $AD$ , making an angle with the line  $AB$ , then through the point  $B$ , draw a line  $BC$  parallel to  $AD$ ; and from  $A$ , with any small opening of the compasses, set off a number of equal parts (on the line  $AD$ ), less by one than the proposed number (here 6); then from  $B$  set off the same number of the same parts (on the line  $BC$ ); lastly, join 6 and 1, 2 and 5, 3 and 4, 4 and 3, 5 and 2, 6 and 1, and these lines will cut the given line as required.

7. (Fig. 15.) To quarter a given circle, or to divide it into four equal parts.

*Rule.* Thro' the centre  $C$  of the given circle, draw a diameter  $AB$ , then upon the point  $C$  raise a perpendicular  $DCE$  to the line  $AB$ ; and these two diameters  $AB$  and  $DE$  shall quarter the circle.

8 (Fig. 16.) Thro' three given points  $A$ ,  $B$ , and  $D$ , to draw a circle. (*Note.* The three points must not lie in the same straight line.)

*Rule.* Join  $A$  and  $B$ , also  $B$  and  $D$ , with the straight lines  $AB$   $BD$ ; then (by prob. 2.) bisect  $AB$  with the

line

line EC, also BD with the line FC, which two-lines will cut one another in some point C; that is the centre of the circle required: then fixing one point of your compasses in D, and stretching the other to A, describe the circle ABDG, which will pass thro' the three points given. The reason of this is plain from cor. 1. of art. 64.

9. (Fig. 17.) From the point A of the given line AB, to draw another line (suppose AC) that shall make with AB an angle of any number of degrees, suppose 45.

*Rule.* Let the given line AB be produced, then take off your scale the length of the chord of 60 degrees, which is equal to the radius of the circle the scale was made for (by art. 75.); and setting one foot in A, with the other sweep of the arc BC; then with your compasses take from your scale the chord of 45 degrees, and set off that distance from B to C. Lastly, join A and C, and the line AC is that required. For the angle CAB, which is measured by the arc BC, is an angle of 45 degrees, as was required.

10. An angle BAC (fig. 18.) being given, to find how many degrees it contains.

*Rule.* With your compasses take the length of your chord of 60 from your scale. Then, setting one foot of them in A, with the other sweep the arc BC, which is the arc comprehended between the two legs AB, AC produced if needful. Lastly, take with your compasses the distance BC, and applying it to your line of chords on the scale, you will find how many degrees the arc BC contains, and consequently the degrees of the angle BAC which was required.

11. Three lines  $x$ ,  $y$ , and  $z$  being given, (fig. 19 19.) to form a triangle of them; but any two of these lines taken together must always be greater than the third.

*Rule.* Make any one of them, as  $x$ , the base; then with your compasses take another of them, as  $z$ , and setting one foot in one end of the line  $x$ , as B, with the other sweep the arc DE; and taking with your compasses the length of the other  $y$ , set one foot of them in A, the other end of the line  $x$ , and with the other sweep the arc FG, which will cut the other in C; lastly, join CA and CB, and the triangle CAB is that required.

12. To make a triangle, having one of its legs of any number of equal parts (suppose 160), and one of the angles at that leg 50 degrees, and the other 44 degrees.

*Rule.* Draw an indefinite line ED, (fig. 20) then take off the line of equal parts with your compasses, 160 of them, and set them on the indefinite line, as BC; then (by prob. 9.) draw BA, making the angle ABC of 50 degrees, and (by the same) draw from C the line AC, ma-

king the angle ACB of 44 degrees; which two lines will meet one another in A, and the triangle ABC is that required. See TRIGONOMETRY.

13. Upon a given line AB (fig. 21.) to make a square.

*Rule.* Upon the extremity A of the given line AB, raise a perpendicular AC (by prob. 4.); then take AC equal to AB, and with that extent, setting one foot of the compasses in C, sweep with the other foot the arc GH; then with the same extent, and one foot in B, with the other sweep the arc EF, which will meet the former in some point D; lastly, join C and D, D and B, and the figure ABDC will be the square required.

14. On a given line AB (fig. 22.) to draw a rhomb that shall have one of its angles equal to any number of degrees, suppose 60 degrees.

*Rule.* From the point A of the given line AB, draw the line AC, making the angle CAB of 60 degrees, (by prob. 9.) then take AC equal to AB, and with that extent, fixing one foot of the compasses in B, with the other describe the arc GH; and at the same extent, fixing one foot of the compasses in C, with the other describe the arc EF cutting the former in D; lastly, join CD and DB, and the figure ACDB is that required.

15. Given two lines  $x$  and  $z$ , of these two to make a rectangle.

*Rule.* Draw a line, as AB, (fig. 23 23.) equal in length to one of the given lines  $x$ ; and on the extremity A of that line, raise a perpendicular AC, on which take AC equal to the other line  $z$ ; then take with your compasses the length of the line AB, and at that extent, fixing one foot of them in C, with the other sweep the arc EF; and also taking with your compasses the extent of the line AC, fix one foot of them in B, and with the other sweep the arc GH, which will meet the former in D; lastly, join CD and BD, and the figure ABDC will be that required.

16. Two lines  $x$  and  $z$  being given, of these to form a rhomboides that shall have one of its angles any number of degrees, suppose 50.

*Rule.* Draw a line AB (fig. 24 24.) equal in length to one of the lines, as  $x$ ; then draw the line AC, making with the former the angle BAC equal to the proposed, suppose 50 degrees, and on that line take AC equal to the given line  $z$ , then with your compasses take the length of AB, and fixing one foot in C, sweep the arc EF; also, taking the length of AC, and setting one foot in B, with the other sweep the arc GH, which will cut the former in D; then join CD and DB, so the figure ACDB will be that required.

## P A R T II.

### THE APPLICATION OF THE FOREGOING PRINCIPLES TO THE MENSURATION OF SURFACES, SOLIDS, &c.

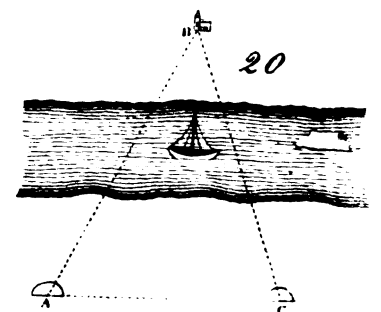
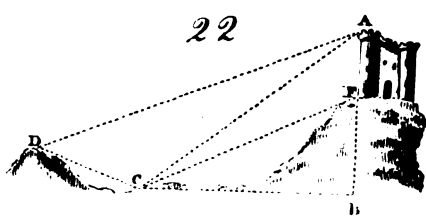
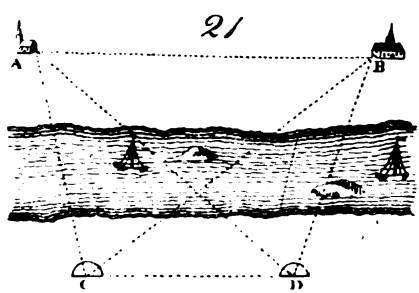
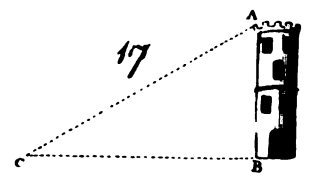
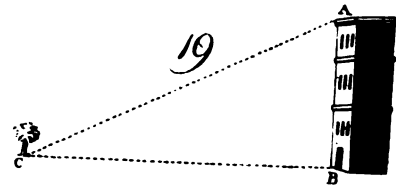
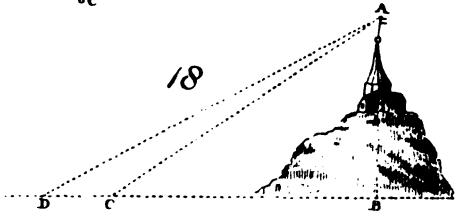
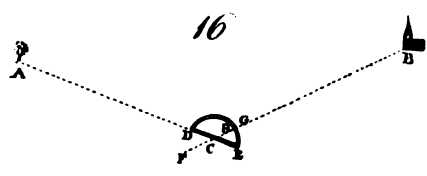
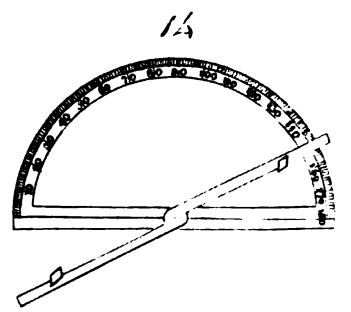
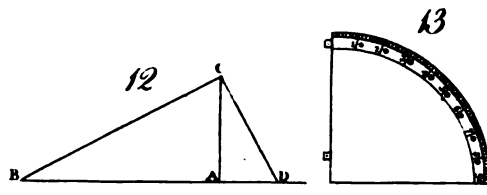
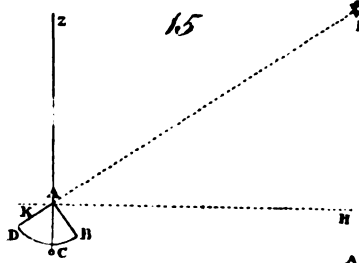
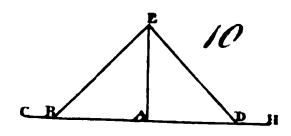
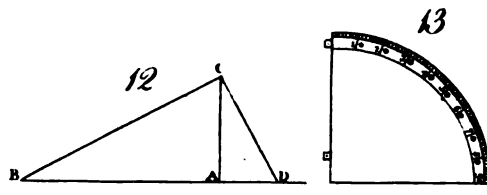
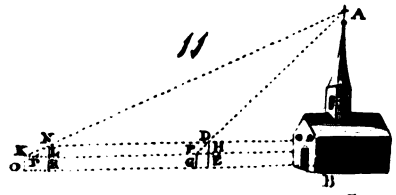
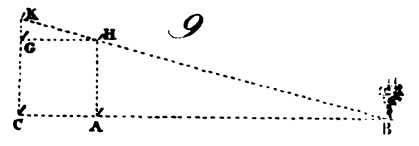
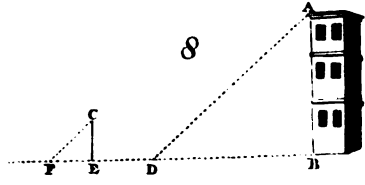
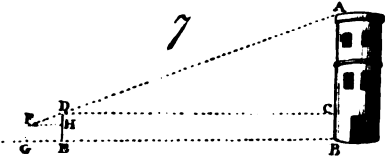
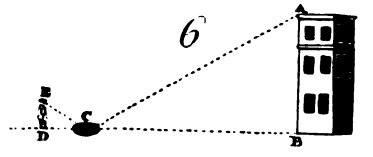
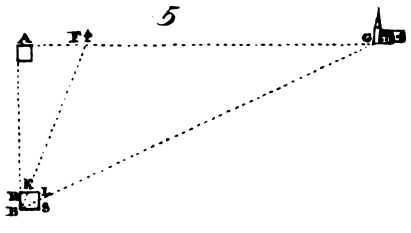
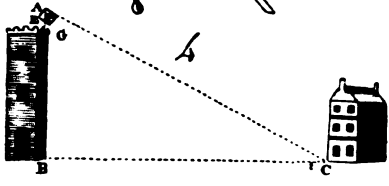
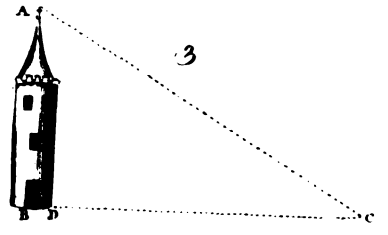
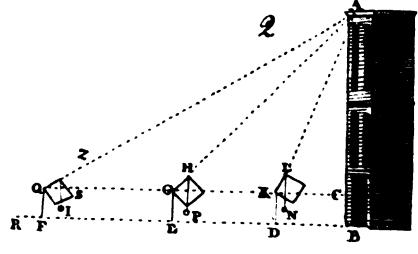
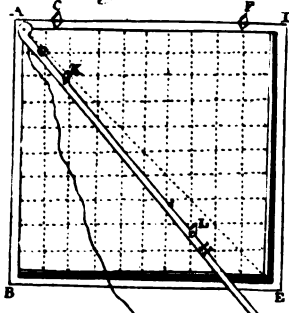
#### *Of the Mensuration of Lines and Angles.*

A Line, or length, to be measured, whether it be distance, height, or depth, is measured by a line less than it. With us the least measure of length is an inch

not that we measure no line less than it, but because we do not use the name of any measure below that of an inch; expressing lesser measures by the fractions of an inch: and in this treatise we use decimal fractions as the easiest. Twelve inches make a foot; three feet and an



Fig. 1.



each make the Scots ell; six ells make a fall; forty falls make a furlong; eight furlongs make a mile: so that the Scots miles is 1184 paces, accounting every pace to be five feet. These things are according to the statutes of Scotland; notwithstanding which, the glaziers use a foot of only eight inches; and other artists for the most part use an English foot, on account of the several scales marked on the English foot-measure for their use. But the English foot is somewhat less than the Scots; so that 185 of these make 186 of those.

Lines, to the extremities and any intermediate point of which you have easy access, are measured by applying to them the common measure a number of times. But lines, to which you cannot have such access, are measured by methods taken from geometry; the chief whereof we shall here endeavour to explain. The first is by the help of the geometrical square.

“As for the English measures, the yard is three feet, or thirty-six inches. A pole is sixteen feet and a half, or five yards and a half. The chain, commonly called *Gunter's chain*, is four poles, or twenty-two yards, that is, sixty six feet. An English statute-mile is four-score chains, or 1760 yards, that is, 5280 feet.

“The chain (which is now much in use, because it is very convenient for surveying) is divided into a hundred links, each of which is  $7\frac{2}{3}$  of an inch: whence it is easy to reduce any number of those links to feet, or any number of feet to links.

“A chain that may have the same advantages in surveying in Scotland, as *Gunter's chain* has in England, ought to be in length seventy-four feet, or twenty-four Scots ells, if no regard is had to the difference of Scots and English foot above mentioned. But, if regard is had to that difference, the Scots chain ought to consist of  $74\frac{3}{4}$  English feet, or 74 feet 4 inches and  $\frac{4}{7}$  of an inch. This chain being divided into an hundred links, each of those links is 8 inches and  $7\frac{2}{3}$  of an inch. In the following table, the most noted measures are expressed in English inches and decimals of an inch.”

	English inch.	Dec.
The English foot, is	12	000
The Paris foot,	12	788
The Rhindland foot, measured by Mr Picart,	12	362
The Scots foot,	12	065
The Amsterdam foot, by Snellius and Picart,	11	172
The Dantzick foot, by Hevelius,	11	297
The Danish foot, by Mr Picart,	12	465
The Swedish foot, by the same,	11	692
The Brussels foot, by the same,	10	828
The Lyons foot, by Mr Auzout,	13	458
The Bononian foot, by Mr Cassini,	14	938
The Milan foot, by Mr Auzout,	15	631
The Roman palm used by merchants, according to the same,	9	791
The Roman palm used by architects,	8	779
The palm of Naples, according to Mr Auzout,	10	314
The English yard,	36	000
The English ell,	45	000
The Scots ell,	37	200

	Inch.	Dec.
The Paris aune used by mercers, according to Mr Picart,	46	786
The Paris aune used by drapers, according to the same,	46	680
The Lyons aune, by Mr Auzout,	46	570
The Geneva aune,	44	760
The Amsterdam ell,	26	800
The Danish ell, by Mr Picart,	24	930
The Swedish ell,	23	380
The Norway ell,	24	510
The Brabant or Antwerp ell,	27	170
The Brussels ell,	27	260
The Bruges ell,	27	550
The brace of Bononia, according to Auzout,	25	200
The brace used by architects in Rome,	30	730
The brace used in Rome by merchants,	34	270
The Florence brace used by merchants, according to Picart,	22	910
The Florence geographical brace,	21	570
The vara of Seville,	33	127
The vara of Madrid,	39	166
The vara of Portugal,	44	031
The cavado of Portugal,	27	354
The ancient Roman foot,	11	632
The Persian arish, according to Mr Græves,	38	364
The shorter pike of Constantinople, according to the same,	25	576
Another pike of Constantinople, according to Mess. Mallet and De la Porte,	27	920

PROPOSITION I.

PROB. To describe the structure of the geometrical square.—The geometrical square is made of any solid matter, as brass or wood, or of any four plain rulers joined together at right angles, (as in Plate XCV. fig. 1.) where A is the centre, from which hangs a thread with a small weight at the end, so as to be directed always to the centre. Each of the sides BE and DE is divided into an hundred equal parts, or (if the sides be long enough to admit of it) into a thousand parts; C and F are two sights, fixed on the side AD. There is moreover an index GH, which, when there is occasion, is joined to the centre A, in such manner as that it can move round, and remain in any given situation. On this index are two sights perpendicular to the right line going from the centre of the instrument: these are K and L. The side DE of the instrument is called the upright side; E the reclining side.

PROPOSITION II.

FIG. 2. To measure an accessible height, AB, by the help of a geometrical square, its distance being known.—Let BR be an horizontal plane, on which there stands perpendicularly any line AB: let BD, the given distance of the observer from the height, be 96 feet; let the height of the observer's eye be supposed 6 feet: and let the instrument, held by a steady hand, or rather leaning on a support, be directed towards the summit A, so that one eye (the other being shut) may see it clearly through the sights; the perpendicular or plumb line meanwhile hanging free, and touching the surface of the instrument.

strument: let now the perpendicular be supposed to cut off on the right side KN 80 equal parts. It is clear that LKN, ACK, are similar triangles; for the angles LKN, ACK are right angles, and therefore equal; moreover LN and AC are parallel, as being both perpendicular to the horizon; consequently, (by art. 60. cor. 1. part 1.) the angles KLN, KAC, are equal; wherefore, (by art. 60. cor. 2. of part 1.) the angles LNK, and AKC, are likewise equal: so that in the triangles NKL, KAC, (by art. 72. of part 1.) as NK : KL :: KC (i. e. BD) : CA; that is, as 80 to 100, so is 96 feet to CA. Therefore, by the rule of three, CA will be found to be 120 feet; and CB, which is 6 feet, being added, the whole height is 126 feet.

But if the distance of the observer from the height, as BE, be such, that, when the instrument is directed as formerly toward the summit A, the perpendicular falls on the angle P, opposite to H, the centre of the instrument, and BE or CG be given of 120 feet; CA will also be 120 feet. For in the triangles HGP, ACG, equiangular, as in the preceding case, as PG : GH :: GC : CA. But PG is equal to GH; therefore GC is likewise equal to CA: that is, CA will be 120 feet, and the whole height 126 feet as before.

Let the distance BF be 300 feet, and the perpendicular or plumb line cut off 40 equal parts from the reclining side: Now, in this case, the angles QAC, QZI, are equal, and the angles QZI, ZIS, are equal; therefore the angle ZIS is equal to the angle QAC. But the angles ZSI, QCA are equal, being right angles; therefore, in the equiangular triangles ACQ, SZI, it will be, as ZS : SI :: CQ : CA; that is, as 100 to 40, so is 300 to CA. Wherefore, by the rule of three, CA will be found to be of 102 feet. And, by adding the height of the observer, the whole BA will be 126 feet. Note, that the height is greater than the distance, when the perpendicular cuts the right side, and less if it cut the reclined side; and that the height and distance are equal, if the perpendicular fall on the opposite angle.

#### S C H O L I U M.

If the height of a tower, to be measured as above, end in a point, (as in fig. 3.) the distance of the observer opposite to it, is not CD, but is to be accounted from the perpendicular to the point A; that is, to CD must be added the half of the thickness of the tower, viz. BD: which must likewise be understood in the following propositions, when the case is similar.

#### P R O P O S I T I O N III.

FIG. 4. From the height of a tower AB given, to find a distance on the horizontal plane BC, by the geometrical square.—Let the instrument be so placed, as that the mark C in the opposite plane may be seen through the sights; and let it be observed how many parts are cut off by the perpendicular. Now, by what hath been already demonstrated, the triangles AEF, ABC, are similar; therefore, it will be as EF to AE, so AB (composed of the height of the tower BG, and of the height of the centre of the instrument A, above the tower BG) to the distance BC. Wherefore, if, by the rule of three, you

say, as EF to AE, so is AB to BC, it will be the distance sought.

#### P R O P O S I T I O N IV.

FIG. 5. To measure any distance at land or sea, by the geometrical square.—In this operation, the index is to be applied to the instrument, as was shown in the description; and, by the help of a support, the instrument is to be placed horizontally at the point A; then let it be turned till the remote point F, whose distance is to be measured, be seen through the fixed sights; and bringing the index to be parallel with the other side of the instrument, observe by the sights upon it any accessible mark B, at a sensible distance: then carrying the instrument to the point B, let the immoveable sights be directed to the first station A, and the sights of the index to the point F. If the index cut the right side of the square, as in K, in the two triangles BRK, and BAF, which are æquiangular, it will be as BR to RK, so BA (the distance of the stations to be measured with a chain) to AF; and the distance AF sought will be found by the rule of three. But if the index cut the reclined side of the square in any point L, where the distance of a more remote point is sought; in the triangles BLS, BAG, the side LS shall be to SB, as BA to AG, the distance sought; which accordingly will be found by the rule of three.

#### P R O P O S I T I O N V.

FIG. 6. To measure an accessible height by means of a plain mirror.—Let AB be the height to be measured; let the mirror be placed at C, in the horizontal plane BD, at a known distance BC; let the observer go back to D, till he see the image of the summit in the mirror, at a certain point of it, which he must diligently mark; and let DE be the height of the observer's eye. The triangles ABC and EDC are equiangular; for the angles at D and B are right angles; and ACB, ECD, are equal, being the angles of incidence and reflexion of the ray AC, as is demonstrated in optics; wherefore the remaining angles at A and E are also equal: therefore it will be, as CD to DE, so CB to BA; that is, as the distance of the observer from the point of the mirror in the right line betwixt the observer and the height, is to the height of the observer's eye, so is the distance of the tower from that point of the mirror, to the height of the tower sought; which therefore will be found by the rule of three.

Note 1. The observation will be more exact, if, at the point D, a staff be placed in the ground perpendicularly, over the top of which the observer may see a point of the glass exactly in a line, betwixt him and the tower.

Note 2. In place of a mirror may be used the surface of water contained in a vessel, which naturally becomes parallel to the horizon.

#### P R O P O S I T I O N VI.

FIG. 7. To measure an accessible height AB by means of two staffs.—Let there be placed perpendicularly in the ground a longer staff DE, likewise a shorter one FG, so as the observer may see A, the top of the height to be measured, over the ends DF of the two staffs; let FH and DC, parallel to the horizon, meet DE and AB in H and C; then the triangles FHD, DCA, shall be equiangular;



equiangular; for the angles at C and H are right ones; likewise the angle A is equal to the angle FDH; wherefore the remaining angles DFH, and ADC, are also equal: Wherefore, as FH, the distance of the staffs, to HD, the excess of the longer staff above the shorter; so is DC, the distance of the longer staff from the tower, to CA, the excess of the height of the tower above the longer staff. And thence CA will be found by the rule of three.

To which if the length DE be added, you will have the whole height of the tower BA.

S C H O L I U M.

FIG. 8. Many other methods may be occasionally contrived for measuring an accessible height. For example, from the given length of the shadow BD, to find out the height AB, thus: Let there be erected a staff CE perpendicularly, producing the shadow EE. The triangles ABD, CEF, are equiangular; for the angles at B and E are right; and the angles ADB and CFE are equal, each being equal to the angle of the sun's elevation above the horizon: Therefore, as EF, the shadow of the staff, to EC, the staff itself; so BD, the shadow of the tower, to BA, the height of the tower. Though the plane on which the shadow of the tower falls be not parallel to the horizon, if the staff be erected in the same plane, the rule will be the same.

P R O P O S I T I O N VII.

To measure an inaccessible height by means of two staffs.—Hitherto we have supposed the height to be accessible, or that we can come at the lower end of it; now if, because of some impediment, we cannot get to a tower, or if the point whose height is to be found out be the summit of a hill, so that the perpendicular be hid within the hill; if, for want of better instruments, such an inaccessible height is to be measured by means of two staffs, let the first observation be made with the staffs DE and FG, (as in prop. 6.); then the observator is to go off in a direct line from the height and first station, till he come to the second station; where (fig. 11.) he is to place the longer staff perpendicularly at RN, and the shorter staff at KO, so that the summit A may be seen along their tops; that is, so that the points KNA may be in the same right line. Through the point N, let there be drawn the right line NP parallel to FA: Wherefore in the triangles KNP, KAF, the angles KNP, KAF are equal, also the angle AKF is common to both; consequently the remaining angle KPN is equal to the remaining angle KFA. And therefore,  $PN : FA :: KP : KF$ . But the triangles PNL, FAS are similar; therefore,  $PN : FA :: NL : SA$ . Therefore, (by the 11. 5. Encl.)  $KP : KF :: NL : SA$ . Thence, alternately, it will be, as KP (the excess of the greater distance of the short staff from the long one above its lesser distance from it) to NL, the excess of the longer staff above the shorter; so KF, the distance of the two stations of the shorter staff to SA the excess of the height sought above the height of the shorter staff. Wherefore SA will be found by the rule of three. To which let the height of the shorter staff be added, and the sum will give the whole inaccessible height BA.

Note 1. In the same manner may an inaccessible

height be found by a geometrical square, or by a plain speculum. But we shall leave the rules to be found out by the student, for his own exercise.

Note 2. That by the height of the staff we understand its height above the ground in which it is fixed.

Note 3. Hence depends the method of using other instruments invented by geometricians; for example, of the geometrical cross: And if all things be justly weighed, a like rule will serve for it as here. But we incline to touch only upon what is most material.

P R O P O S I T I O N VIII.

FIG. 9. To measure the distance AB, to one of whose extremities we have access, by the help of four staffs.—Let there be a staff fixed at the point A; then going back at some sensible distance in the same right line, let another be fixed in C, so as that both the points A and B be covered and hid by the staff C: likewise going off in a perpendicular from the right line CB, at the point A, (the method of doing which shall be shown in the following scholium), let there be placed another staff at H; and in the right line CKG (perpendicular to the same CB, at the point B), and at the point of it K, such that the points K, H, and B may be in the same right line, let there be fixed a fourth staff. Let there be drawn, or let there be supposed to be drawn, a right line GH parallel to CA. The triangles KGH, HAH, will be equiangular; for the angles HAB, KGH are right angles. Also the angles AHK, KHG are equal; wherefore, as KH (the excess of CK above AH) to GH, or to CA, the distance betwixt the first and second staff; so is AH, the distance betwixt the first and third staff, to AB the distance sought.

S C H O L I U M.

FIG. 10. To draw on a plane a right line AE perpendicular to CH, from a given point A; take the right lines AB, AD, on each side equal; and in the points B and D, let there be fixed stakes, to which let there be tied two equal ropes BE, DE, or one having a mark in the middle, and holding in your hand their extremities joined, (or the mark in the middle, if it be but one), draw out the ropes one the ground; and then, where the two ropes meet, or at the mark, when by it the rope is fully stretched, let there be placed a third stake at E; the right line AE will be perpendicular to CH in the point A (prob. 1. of part. i.). In a manner not unlike to this, may any problems that are resolved by the square and compasses, be done by ropes and a cord turned round as a radius.

P R O P O S I T I O N IX.

FIG. 12. To measure the distance AB, one of whose extremities is accessible.—From the point A, let the right line AC of a known length be made perpendicular to AB, (by the preceding scholium); likewise draw the right line CD perpendicular to CB, meeting the right line AB in D: then as DA : AC :: AC : AB. Wherefore, when DA and AC are given, AB will be found by the rule of three.

S C H O L I U M.

All the preceding operations depend on the equality of some angles of triangles, and on the similarity of the triangles arising from that equality. And on the same principles

cles depend innumerable other operations which a geometrician will find out of himself, as is very obvious. However, some of these operations require such exactness in the work, and without it are so liable to errors, that, *ceteris paribus*, the following operations, which are performed by a trigonometrical calculation, are to be preferred; yet could we not omit those above, being most easy in practice, and most clear and evident to those who have only the first elements of geometry. But if you are provided with instruments, the following operations are more to be relied upon. We do not insist on the easiest cases to those who are skilled in plain trigonometry, which is indeed necessary to any one who would apply himself to practice. See TRIGONOMETRY.

#### PROPOSITION X.

FIG. 13. *To describe the construction and use of the geometrical quadrant.*—The geometrical quadrant is the fourth part of a circle divided into ninety degrees, to which two sights are adapted, with a perpendicular or plumb line hanging from the centre. The general use of it is for investigating angles in a vertical plane, comprehended under right lines going from the centre of the instrument, one of which is horizontal, and the other is directed to some visible point. This instrument is made of any solid matter as wood, copper, &c.

#### PROPOSITION XI.

FIG. 14. *To describe and make use of the graphometer.*—The graphometer is a semicircle made of any hard matter, of wood, for example, or brass, divided into 180 degrees; so fixed on a *fulcrum*, by means of a brass ball and socket, that it easily turns about, and retains any situation; two sights are fixed on its diameter. At the centre there is commonly a magnetical needle in a box. There is likewise a moveable ruler, which turns round the centre, and retains any situation given it. The use of it is to observe any angle, whose vertex is at the centre of the instrument in any plane, (though it is most commonly horizontal, or nearly so), and to find how many degrees it contains.

#### PROPOSITION XII.

FIG. 15. and 16. *To describe the manner in which angles are measured by a quadrant or graphometer.*—Let there be an angle in a vertical plane, comprehended between a line parallel to the horizon HK, and the right line RA, coming from any remarkable point of a tower or hill, or from the sun, moon, or a star. Suppose that this angle RAH is to be measured by the quadrant: let the instrument be placed in the vertical plane, so as that the centre A may be in the angular point: and let the sights be directed towards the object at R, (by the help of the ray coming from it, if it be the sun or moon, or by the help of the visual ray, if it is any thing else), the degrees and minutes in the arc BC cut off by the perpendicular, will measure the angle RAH required. For, from the make of the quadrant, BAD is a right angle; therefore BAR is likewise right, being equal to it. But, because HK is horizontal, and AC perpendicular, HAC will be a right angle; and therefore equal also to BAR. From those angles subtract the part HAB that is common to both; and there will remain the angle BAC equal to the angle RAH. But the arc BC is the measure of the

angle BAC; consequently, it is likewise the measure of the angle RAH.

Note, That the remaining arc on the quadrant DC is the measure of the angle RAZ, comprehended between the foresaid right line RA and AZ which points to the zenith.

Let it now be required to measure the angle ACB (fig. 16) in any plane, comprehended between the right lines AC and BC, drawn from two points A and B, to the place of station C. Let the graphometer be placed at C, supported by its *fulcrum* (as was shown above); and let the immoveable sights on the side of the instrument DE be directed towards the point A; and likewise (while the instrument remains immoveable) let the sights of the ruler FG (which is moveable about the centre C) be directed to the point B. It is evident, that the moveable ruler cuts off an arc DH, which is the measure of the angle ACB sought. Moreover, by the same method, the inclination of CE, or of FG, may be observed with the meridian line, which is pointed out by the magnetic needle inclosed in the box, and is moveable about the centre of the instrument, and the measure of this inclination or angle found in degrees.

#### PROPOSITION XIII.

FIG. 17. *To measure an accessible height by the geometrical quadrant.*—By the 12th prop. of this part, let the angle C be found by means of the quadrant. Then in the triangle ABC, right-angled at B, (BC being supposed the horizontal distance of the observator from the tower), having the angle at C, and the side BC, the required height BA will be found by the 3d case of plain trigonometry. See TRIGONOMETRY.

#### PROPOSITION XIV.

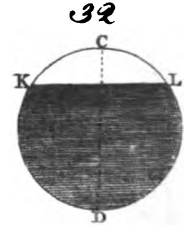
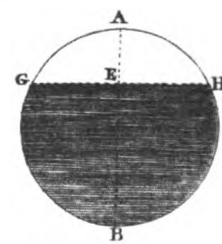
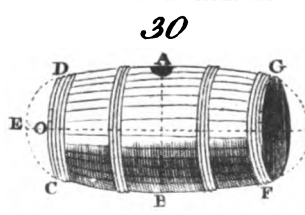
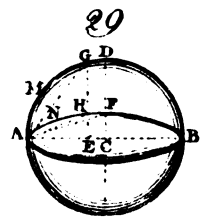
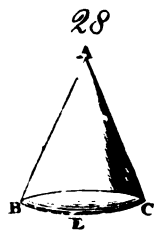
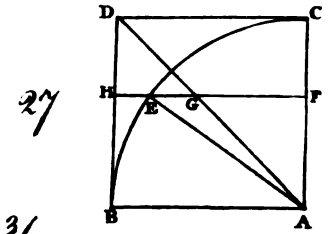
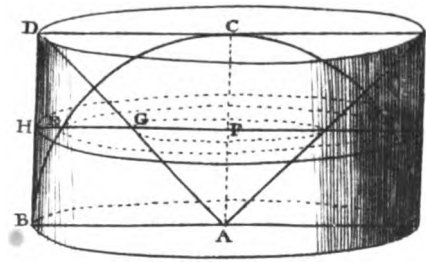
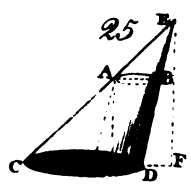
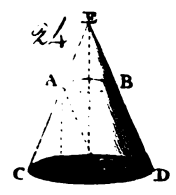
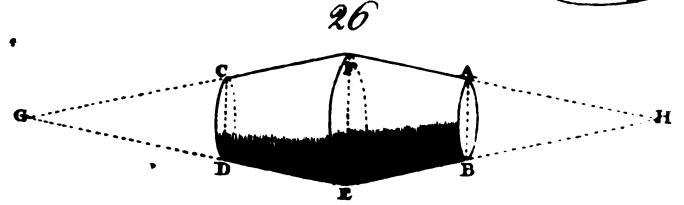
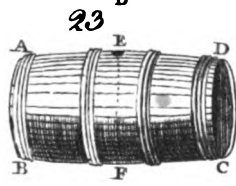
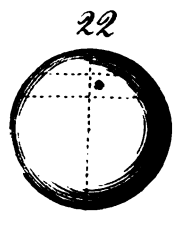
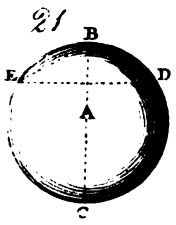
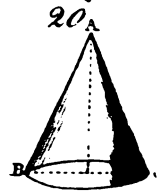
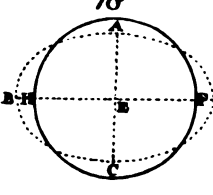
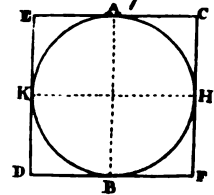
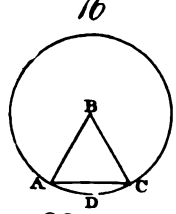
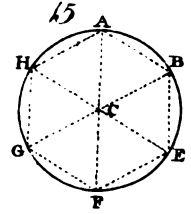
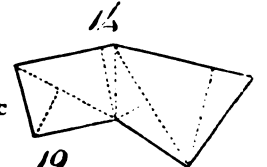
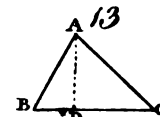
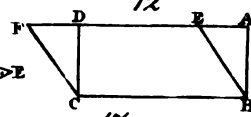
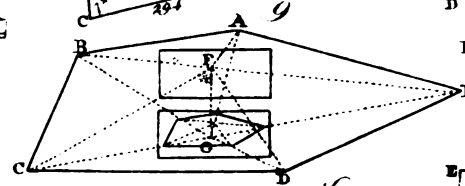
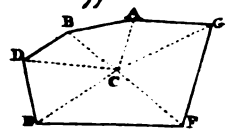
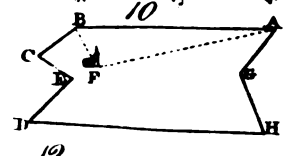
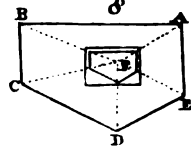
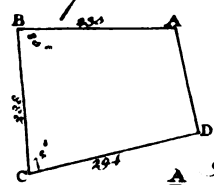
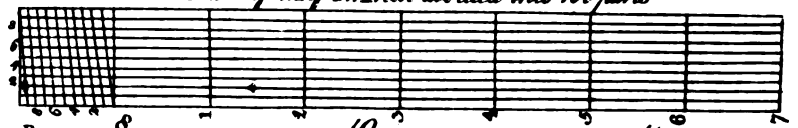
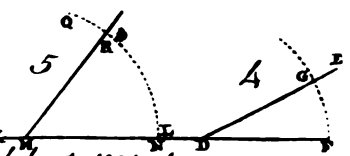
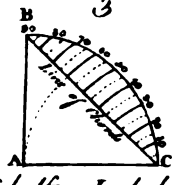
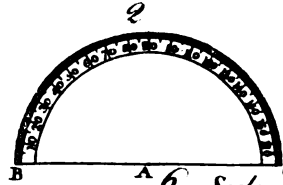
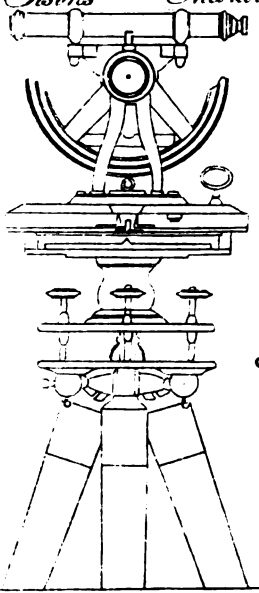
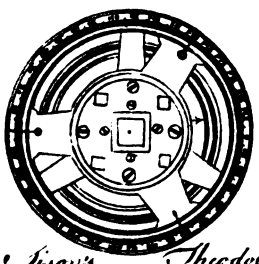
FIG. 18. *To measure an inaccessible height by the geometrical quadrant.*—Let the angle ACB be observed with the quadrant (by the 12th prop. of this part;) then let the observer go from C to the second station D, in the right line BCD (provided BCD be a horizontal plane); and after measuring this distance CD, take the angle ADC likewise with the quadrant. Then, in the triangle ACD, there is given the angle ADC, with the angle ACD; because ACB was given before: therefore (by art. 59. of Part I.) the remaining angle CAD is given likewise. But the side CD is likewise given, being the distance of the station C and D; therefore (by the first case of oblique-angled triangles in trigonometry) the side AC will be found. Wherefore, in the right-angled triangle ABC, all the angles and the hypotenuse AC are given; consequently, by the fourth case of trigonometry, the height sought AB will be found; as also (if you please) the distance of the station C, from AB the perpendicular within the hill or inaccessible height.

#### PROPOSITION XV.

FIG. 19. *From the top of a given height, to measure the distance BC.*—Let the angle BAC be observed by the 12th prop. of this; wherefore in the triangle ABC, right-angled at B, there is given by observation the angle at A; whence (by the 59th art. of Part I.) there will also be given the angle BCA: moreover the side AB (being the height of the tower) is supposed to be given.

Wherefore





Abell's

Wherefore, by the 3d case of trigonometry, BC, the distance sought; will be found.

P P O S I T I O N X V I.

FIG. 20. *To measure the distance of two places A and B, of which one is accessible, by the graphometer.*—Let there be erected at two points A and C, sufficiently distant, two visible signs; then (by the 12th prop. of this part) let the two angles BAC, BCA be taken by the graphometer. Let the distance of the stations A and C be measured with a chain. Then the third angle B being known, and the side AC being likewise known; therefore, by the first case of trigonometry, the distance required, AB, will be found.

P R O P O S I T I O N X V I I.

FIG. 21. *To measure by the graphometer, the distance of two places, neither of which is accessible.*—Let two stations C and D be chosen, from each of which the places may be seen whose distance is sought: let the angles ACD, ACB, BCD, and likewise the angles BDC, BDA, CDA, be measured by the graphometer; let the distance of the stations C and D be measured by a chain, or (if it be necessary) by the preceding practice. Now, in the triangle ACD, there are given two angles ACD and ADC; therefore, the third CAD is likewise given; moreover the side CD is given; therefore, by the first case of trigonometry, the side AD will be found. After the same manner, in the triangle BCD, from all the angles and one side CD given, the side BD is found. Wherefore, in the triangle ADB, from the given sides DA and DB, and the angle ADB contained by them, the side AB (the distance sought) is found by the 4th case of trigonometry of oblique-angled triangles.

P R O P O S I T I O N X V I I I.

FIG. 22. *It is required by the graphometer and quadrant, to measure an accessible height AB, placed so on a steep, that one can neither go near it in an horizontal plane, nor recede from it, as was supposed in the solution of the 14th Prop.*—Let there be chosen any situation as C, and another D; where let some mark be erected: let the angles ACD and ADC be found by the graphometer; then the third angle DAC will be known. Let the side CD, the distance of the stations, be measured with a chain, and thence (by trigon.) the side AC will be found. Again, in the triangle ACB, right angled at B, having found by the quadrant the angle ACB, the other angle CAB is known likewise: but the side AC in the triangle ADC is already known; therefore the height required AB will be found by the 4th case of right-angled triangles. If the height of the tower is wanted, the angle BCF will be found by the quadrant; which being taken from the angle ACB already known, the angle ACF will remain: but the angle FAC was known before; therefore the remaining angle AFC will be known. But the side AC was also known before; therefore, in the triangle AFC, all the angles and one of the sides AC being known, AF, the height of the tower above the hill, will be found by trigonometry.

S C H O L I U M.

It were easy to add many other methods of measuring heights and distances; but, if what is above be understood, it will be easy (especially for one that is versed in

the elements) to contrive methods for this purpose, according to the occasion: so that there is no need of adding any more of this sort. We shall subjoin here a method by which the diameter of the earth may be found out.

P R O P O S I T I O N X I X.

PLATE CXVI. FIG. 1. *To find the diameter of the earth from one observation.*—Let there be chosen a high hill AB, near the sea-shore, and let the observator on the top of it, with an exact quadrant divided into minutes and seconds by transverse divisions, and fitted with a telescope in place of the common sights, measure the angle ABE contained under the right line AB, which goes to the centre, and the right line BE drawn to the sea, a tangent to the globe at E; let there be drawn from A perpendicular to BD, the line AF meeting BE in F. Now in the right-angled triangle BAF all the angles are given, also the side AB, the height of the hill; which is to be found by some of the foregoing methods, as exactly as possible; and (by trigonometry) the sides BF and AF are found. But, by cor. 36th 3. Eucl. AF is equal to FE; therefore BE will be known. Moreover, by 36th 3. Eucl. the rectangle under BA and BD is equal to the square of BE. And thence, by 17th 6. Eucl. as AB : BE :: BE : BD. Therefore, since AB and BE are already given, BD will be found by 11th, 6. Eucl. or by the rule of three; and subtracting BA, there will remain AD the diameter of the earth sought.

S C H O L I U M.

Many other methods might be proposed for measuring the diameter of the earth. The most exact is that proposed by Mr Picart of the academy of sciences at Paris.

“ According to Mr Picart, a degree of the meridian at the latitude of 49° 21', was 57,060 French toises, each of which contains six feet of the same measure; from which it follows, that, if the earth be an exact sphere, the circumference of a great circle of it will be 123,249,600 Paris feet, and the semidiameter of the earth 19,615,800 feet: but the French mathematicians, who of late have examined Mr Picart's operations, assure us, That the degree in that latitude is 57,183 toises. They measured a degree in Lapland, in the latitude of 66° 20', and found it of 57,438 toises. By comparing these degrees, as well as by the observations on pendulums, and the theory of gravity, it appears that the earth is an oblate spheroid; and (supposing those degrees to be accurately measured) the axis or diameter that passes through the poles will be to the diameter of the equator, as 177 to 178; or the earth will be 22 miles higher at the equator than at the poles. A degree has likewise been measured at the equator, and found to be considerably less than at the latitude of Paris; which confirms the oblate figure of the earth. But an account of this last mensuration has not been published as yet. If the earth was of an uniform density from the surface to the centre, then, according to the theory of gravity, the meridian would be an exact ellipsis, and the axis would be to the diameter of the equator as 230 to 231; and the difference of the semidiameter of the equator and semiaxis about 17 miles.”

In what follows, a figure is often to be laid down on paper, like to another figure given; and because this likeness consists in the equality of their angles, and in the sides having the same proportion to each other (by the definitions of the 6th of Eucl.) we are now to shew what methods practical geometers use for making on paper an angle equal to a given angle, and how they constitute the sides in the same proportion. For this purpose they make use of a protractor, (or, when it is wanting, a line of chords), and of a line of equal parts.

PROPOSITION XX.

FIG. 2. 3. 4. 5. and 6. *To describe the construction and use of the protractor, of the line of chords, and of the line of equal parts.*—The protractor is a small semicircle of brass, or such solid matter. The semicircumference is divided into 180 degrees. The use of it is, to draw angles on any plane, as on paper, or to examine the extent of angles already laid down. For this last purpose, let the small point in the centre of the protractor be placed above the angular point, and let the side AB coincide with one of the sides that contain the angle proposed; the number of degrees cut off by the other side, computing on the protractor from B, will show the quantity of the angle that is to be measured.

But if an angle is to be made of a given quantity on a given line, and at a given point of that line, let AB coincide with the given line, and let the centre A of the instrument be applied to that point. Then let there be a mark made at the given number of degrees; and a right line drawn from that mark to the given point, will constitute an angle with the given right line of the quantity required; as is manifest.

This is the most natural and easy method, either for the extent of an angle on paper, or for describing on paper an angle of a given quantity.

But when there is scarcity of instruments, or because a line of chords is more easily carried about, (being described on a ruler on which there are many other lines besides), practical geometers frequently make use of it. It is made thus: let the quadrant of a circle be divided into 90 degrees; (as in fig. 4.) The line AB is the chord of 90 degrees; the chord of every arc of the quadrant is transferred to this line AB, which is always marked with the number of degrees in the corresponding arc.

Note, that the chord of 60 degrees is equal to the radius, by corol. 15. 4th Eucl. If now a given angle EDF is to be measured by the line of chords from the centre D, with the distance DG, (the chord of 60 degrees,) describe the arch GF; and let the points G and F be marked where this arch intersects the sides of the angle. Then if the distance GF, applied on the line of chords from A to B, gives (for example) 25 degrees, this shall be the measure of the angle proposed.

When an obtuse angle is to be measured with this line, let its complement to a semicircle be measured, and thence it will be known. It were easy to transfer to the diameter of a circle the chords of all arches to the extent of a semicircle; but such are rarely found marked upon rules.

But now, if an angle of a given quantity, suppose of 50 degrees, is to be made at a given point M of the right line KL (fig. 6.) From the centre M, and the di-

stance MN, equal to the chord of 60 degrees, describe the arc QN. Take off an arc NR, whose chord is equal to that of 50 degrees on the line of chords: join the points M and R; and it is plain that MR shall contain an angle of 50 degrees with the line KL proposed.

But sometimes we cannot produce the sides, till they be of the length of a chord of 60 degrees on our scale; in which case it is fit to work by a circle of proportions (that is a sector), by which an arc may be made of a given number of degrees to any radius.

The quantities of angles are likewise determined by other lines usually marked upon rules, as the lines of sines, tangents, and secants; but, as these methods are not so easy or so proper in this place, we omit them.

To delineate figures similar or like to others given, besides the equality of the angles, the same proportion is to be preserved among the sides of the figure that is to be delineated, as is among the sides of the figures given. For which purpose, on the rules used by artists, there is a line divided into equal parts, more or less in number, and greater or lesser in quantity, according to the pleasure of the maker.

A foot is divided into inches; and an inch, by means of transverse lines, into 100 equal parts: so that with this scale, any number of inches, below twelve, with any part of an inch, can be taken by the compasses, providing such part be greater than the one hundredth part of an inch. And this exactness is very necessary in delineating the plans of houses, and in other cases.

PROPOSITION XXI.

FIG. 7. *To lay down on paper, by the protractor or line of chords, and line of equal parts, a right-lined figure like to one given, providing the angles and sides of the figure given be known by observation or mensuration.*

—For example, suppose that it is known that in a quadrangular figure, one side is of 235 feet, that the angle contained by it and the second side is of  $84^\circ$ , the second side of 288 feet, the angle contained by it and the third side of  $72^\circ$ , and that the third side is 294 feet. These things being given, a figure is to be drawn on paper like to this quadrangular figure. On your paper, at a proper point A, let a right line be drawn, upon which take 235 equal parts, as AB. The part representing a foot is taken greater or lesser, according as you would have your figure greater or less. In the adjoining figure, the 100th part of an inch is taken for a foot. And accordingly an inch divided into 100 parts, and annexed to the figure, is called a scale of 100 feet. Let there be made at the point B (by the preceding prop.) an angle ABC of  $85^\circ$ , and let BC be taken of 288 parts like to the former. Then let the angle BCD be made of  $72^\circ$ , and the side CD of 294 equal parts. Then let the side AD be drawn; and it will complete the figure like to the figure given. The measures of the angle A and D can be known by the protractor or line of chords, and the side AD by the line of equal parts; which will exactly answer to the corresponding angles and to the side of the primary figure.

After the very same manner, from the sides and angles given, which bound any right-lined figure, a figure like to it may be drawn, and the rest of its sides and angles be known.

C O R O L-

C O R O L L A R Y.

Hence any trigonometrical problem in right-lined triangles, may be resolved by delineating the triangle from what is given concerning it, as in this proposition. The unknown sides are examined by a line of equal parts, and the angles by a protractor or line of chords.

P R O P O S I T I O N XXII.

*The diameter of a circle being given, to find its circumference nearly.*—The periphery of any polygon inscribed in the circle is less than the circumference, and the periphery of any polygon described about a circle is greater than the circumference. Whence Archimedes first discovered that the diameter was in proportion to the circumference, as 7 to 22 nearly; which serves for common use. But the moderns have computed the proportion of the diameter to the circumference to greater exactness. Supposing the diameter 100, the periphery will be more than 314, but less than 315. The diameter is more nearly to the circumference, as 113 to 355. But Ludolphus van Cuelen exceeded the labours of all; for by immense study he found, that, supposing the diameter 100,000,000,000,000,000,000,000,000,000, the periphery will be less than

314,159,265,358,979,323,846,264,338,327,951,  
but greater than

314,159,265,358,979,323,846,264,338,327,950;  
whence it will be easy, any part of the circumference being given in degrees and minutes, to assign it in parts of the diameter.

Of Surveying and Measuring of LAND.

HITHERTO we have treated of the measuring of angles and sides, whence it is abundantly easy to lay down a field, a plane, or an entire country: for to this nothing is requisite but the protraction of triangles, and of other plain figures, after having measured their sides and angles. But as this is esteemed an important part of practical geometry, we shall subjoin here an account of it with all possible brevity; suggesting withal, that a surveyor will improve himself more by one day's practice, than by a great deal of reading.

P R O P O S I T I O N XXIII.

*To explain what surveying is, and what instruments Surveyors use.*—First, it is necessary that the surveyor view the field that is to be measured, and investigate its sides and angles, by means of an iron chain (having a particular mark at each foot of length, or at any number of feet, as may be most convenient for reducing lines or surfaces to the received measures), and the graphometer described above. Secondly, It is necessary to delineate the field *in plano*, or to form a map of it; that is, to lay down on paper a figure similar to the field; which is done by the protractor (or line of chords) and of the line of equal parts. Thirdly, It is necessary to find out the area of the field so surveyed and represented by a map. Of this last we are to treat below.

The sides and angles of small fields are surveyed by the help of a plain table; which is generally of an oblong rectangular figure, and supported by a *fulcrum*, so as to turn every way by means of a ball and socket. It has a

moveable frame, which surrounds the board, and serves to keep a clean paper put on the board close and tight to it. The sides of the frame facing the paper are divided into equal parts every way. The board hath besides a box with a magnetic needle, and moreover a large index with two sights. On the edge of the frame of the board are marked degrees and minutes, so as to supply the room of a graphometer.

P R O P O S I T I O N XXIV.

*FIG. 8. To delineate a field by the help of a plain-table, from one station whence all its angles may be seen, and their distances measured by a chain.*—Let the field that is to be laid down be ABCDE. At any convenient place F, let the plain-table be erected; cover it with clean paper, in which let some point near the middle represent the station. Then applying at this place the index with the sights, direct it so as that through the sights some mark may be seen at one of the angles, suppose A; and from the point F, representing the station, draw a faint right line along the side of the index: then, by the help of the chain, let FA the distance of the station from the foresaid angle be measured. Then taking what part you think convenient for a foot or pace from the line of equal parts, set off on the faint line the parts corresponding to the line FA that was measured; and let there be a mark made representing the angle of the field A. Keeping the table immovable, the same is to be done with the rest of the angles; then right lines joining those marks shall include a figure like to the field, as is evident from 5. 6. Eucl.

C O R O L L A R Y.

The same thing is done in like manner by the graphometer: for having observed in each of the triangles, AFB, BFC, CFD, &c. the angle at the station F, and having measured the lines from the station to the angles of the field, let similar triangles be protracted on paper (by the 21. prop. of this) having their common vertex in the point of station. All the lines, excepting those which represent the sides of the field, are to be drawn faint or obscure.

Note 1. When a surveyor wants to lay down a field, let him place distinctly in a register all the observations of the angles, and the measures of the sides, until, at time and place convenient, he draw out the figure on paper.

Note 2. The observations made by the help of the graphometer are to be examined: for all the angles about the point F ought to be equal to four right ones. (by cor. 2. art. 30. of part I.)

P R O P O S I T I O N XXV.

*FIG. 9. To lay down a field by means of two stations, from each of which all the angles can be seen, by measuring only the distance of the stations.*—Let the instrument be placed at the station F: and having chosen a point representing it upon the paper which is laid upon the plain table, let the index be applied at this point, so as to be moveable about it. Then let it be directed successively to the several angles of the field: and when any angle is seen through the sights, draw an obscure line along the side of the index. Let the index, with the sights, be directed after the same manner to the station G: on the obscure line drawn along its side, pointing to A,

A, set off from the scale of equal parts a line corresponding to the measured distance of the stations, and this will determine the point G. Then remove the instrument to the station G, and applying the index to the line representing the distance of the stations, place the instrument so that the first station may be seen through the sights. Then the instrument remaining immovable, let the index be applied at the point representing the second station G, and be successively directed by means of its sights, to all the angles of the field, drawing (as before) obscure lines; and the intersection of the two obscure lines that were drawn to the same angle from the two stations will always represent that angle on the plan. Care must be taken that those lines be not mistaken for one another. Lines joining those intersections will form a figure on the paper like to the field.

#### SCHOLIUM.

It will not be difficult to do the same by the graphometer, if you keep a distinct account of your observations of the angles made by the line joining the stations, and the lines drawn from the stations to the respective angles of the field. And this is the most common manner of laying down whole countries. The tops of two mountains are taken for two stations, and their distance is either measured by some of the methods mentioned above, or is taken according to common repute. The sights are successively directed towards cities, churches, villages, forts, lakes, turnings of rivers, woods, &c.

Note, The distance of the stations ought to be great enough, with respect to the field that is to be measured; such ought to be chosen as are not in a line with any angle of the field. And care ought to be taken likewise that the angles, for example, FAG, FDG, &c. be neither very acute, nor very obtuse. Such angles are to be avoided as much as possible; and this admonition is found very useful in practice.

#### PROPOSITION XXVI.

FIG. 10. *To lay down any field, however irregular its figure may be, by the help of the graphometer.*—Let ABCEDHG be such a field. Let its angles (in going round it) be observed with a graphometer (by the 12. of this) and noted down; let its sides be measured with a chain; and (by what was said on the 21. of this) let a figure like to the given field be protracted on paper. If any mountain is in the circumference, the horizontal line hid under it is to be taken for a side, which may be found by two or three observations according to some of the methods described above; and its place on the map is to be distinguished by a shade, that it may be known a mountain is there.

If not only the circumference of the field is to be laid down on the plan, but also its contents, as villages, gardens, churches, public roads, we must proceed in this manner.

Let there be (for example) a church F; to be laid down in the plan. Let the angles ABF BAF be observed and protracted on paper in their proper places, the intersection of the two sides BF and AF will give the place of the church on the paper: Or, more exactly, the lines BF AF being measured, let circles be described from the centres B and A, with parts from the

scale corresponding to the distances BF and AF, and the place of the church will be at their intersection.

Note 1. While the angles observed by the graphometer are taken down, you must be careful to distinguish the external angles, as E and G, that they may be rightly protracted afterwards on paper.

Note 2. Our observations of the angles may be examined by computing if all the internal angles make twice as many right angles, four excepted, as there are sides of the figure: (for this is demonstrated by 32. 1. Eucl.) But in place of any external angle DEC, its complement to a circle is to be taken.

#### PROPOSITION XXVII.

FIG. 11. *To lay down a plain field without instruments.*—If a small field is to be measured, and a map of it to be made, and you are not provided with instruments; let it be supposed to be divided into triangles, by right-lines, as in the figure; and after measuring the three sides of any of the triangles, for example of ABC, let its sides be laid down from a convenient scale on paper, (by the 22. of this) Again, let the other two sides BD CD of the triangle CBD be measured and protracted on the paper by the same scale as before. In the same manner proceed with the rest of the triangles of which the field is composed, and the map of the field will be perfected; for the three sides of a triangle determine the triangle; whence each triangle on the paper is similar to its correspondent triangle in the field, and is similarly situated; consequently the whole figure is like to the whole field.

#### SCHOLIUM.

If the field be small, and all its angles may be seen from one station, it may be very well laid down by the plain-table, (by the 24. of this). If the field be larger, and have the requisite conditions, and great exactness is not expected, it likewise may be plotted by means of the plain-table, or by the graphometer, (according to the 25. of this; but in fields that are irregular and mountainous, when an exact map is required, we are to make use of the graphometer, (as in the 26. of this,) but rarely of the plain-table.

Having protracted the bounding lines, the particular parts contained within them may be laid down by the proper operations for this purpose, (delivered in the 26th proposition; and the method described in the 27th proposition may be sometimes of service;) for we may trust more to the measuring of sides, than to the observing of angles. We are not to compute four-sided and many sided figures till they are resolved into triangles: for the sides do not determine those figures.

In the laying down of cities, or the like, we may make use of any of the methods described above that may be most convenient.

The map being finished, it is transferred on clean paper, by putting the first sketch above it, and marking the angles by the point of a small needle. These points being joined by right lines, and the whole illuminated by colours proper to each part, and the figure of the mariners compass being added to distinguish the north and south, with a scale on the margin, the map or plan will be finished and neat.

We



We have thus briefly and plainly treated of surveying, and shown by what instruments it is performed; having avoided those methods which depend on the magnetic needle, not only because its direction may vary in different places of a field (the contrary of this at least doth not appear,) but because the quantity of an angle observed by it cannot be exactly known; for an error of two or three degrees can scarcely be avoided in taking angles by it.

As for the remaining part of surveying, whereby the area of a field already laid down on paper is found in acres, roods, or any other superficial measures; this we leave to the following section, which treats of the mensuration of surfaces.

“ Besides the instruments described above, a surveyor ought to be provided with an off-set staff equal in length to ten links of the chain, and divided into ten equal parts. He ought likewise to have ten arrows or small straight sticks near two feet long, shod with iron ferrils. When the chain is first opened, it ought to be examined by the off-set staff. In measuring any line, the leader of the chain is to have the ten arrows at first setting out. When the chain is stretched in the line, and the near end touches the place from which you measure, the leader sticks one of the ten arrows in the ground, at the far end of the chain. Then the leader leaving the arrow, proceeds with the chain another length; and the chain being stretched in the line, so that the near end touches the first arrow, the leader sticks down another arrow at his end of the chain. The line is preserved straight, if the arrows be always set so as to be in a right line with the place you measure from, and that to which you are going. In this manner they proceed till the leader have no more arrows. At the eleventh chain, the arrows are to be carried to him again, and he is to stick one of them into the ground, at the end of the chain. And the same is to be done at the 21. 31. 41. &c. chains, if there are so many in a right line to be measured. In this manner you can hardly commit an error in numbering the chains, unless of ten chains at once.

“ The off-set staff serves for measuring readily the distances of any things proper to be represented in your plan, from the station-line while you go along. These distances ought to be entered into your field-book, with the corresponding distances from the last station, and proper remarks, that you may be enabled to plot them justly, and be in no danger of mistaking one for another when you extend your plan. The field-book may be conveniently divided into five columns. In the middle column the angles at the several stations taken by the theodolite are to be entered, with distances from the stations. The distances taken by the off-set staff, on either side of the station-line, are to be entered into columns on either side of the middle column, according to their position with respect to that line. The names and characters of the objects, with proper remarks, may be entered in columns on either side of these last.

“ Because, in the place of the graphometer described by our author, surveyors now make use of the theodolite. we shall subjoin a description of Mr Sisson's latest

“ improved theodolite from Mr Gardner's practical surveying improved. See a figure of it in Plate XCVI.

“ In this instrument, the three staffs, by brass ferrils at top, screw into bell-metal joints, that are moveable between brass pillars, fixed in a strong brass plate; in which, round the centre, is fixed a socket with a ball moveable in it, and upon which the four screws press, that set the limb horizontal: Next above is another such plate, through which the said screws pass, and on which, round the centre, is fixed a frustum of a cone of bell-metal, whose axis (being connected with the centre of the bell) is always perpendicular to the limb, by means of a conical brass ferril fitted to it, whereon is fixed the compass box; and on it the limb, which is a strong bell-metal ring, whereon are moveable three brass indexes; in whose plate are fixed four brass pillars, that, joining at top, hold the centre pin of the bell-metal double sextant, whose double index is fixed on the centre of the same plate: Within the double sextant is fixed the spirit-level, and over it the telescope. The compass box is graved with two diamonds for north and south, and with 20 degrees on both sides of each, that the needle may be set to the variation, and its error also known.

“ The limb has two *fleurs de luce* against the diamonds in the box, instead of 180 each; and is curiously divided into whole degrees, and numbered to the left hand at every ten to twice 180, having three indexes distant 120, (with Nonius's divisions on each for the decimals of a degree), that are moved by a pinion fixed below one of them, without moving the limb; and in another is a screw and spring under, to fix it to any part of the limb. It has also divisions numbered, for taking the quarter girt in inches of round timber at the middle height, when standing ten feet horizontally distant from its centre; which at 20 must be doubled, and at 30 tripled; to which a shorter index is used, having Nonius's divisions for the decimals of an inch; but an abatement must be made for the bark, if not taken off.

“ The double sextant is divided on one side from under its centre (when the spirit-tube and telescope are level) to above 60 degrees each way, and numbered at 10, 20, &c. and the double index (through which it is moveable) shews on the same side the degree and decimal of any altitude or depression to that extent by Nonius's divisions: On the other side are divisions numbered, for taking the upright height of timber, &c. in feet, when distant 10 feet; which at 20 must be doubled, and at 30 tripled; and also the quantities for reducing hypothenusal lines to horizontal. It is moveable by a pinion fixed in the double index.

“ The telescope is a little shorter than the diameter of the limb, that a fall may not hurt it; yet it will magnify as much, and shew a distant object as perfect, as most of triple its length. In its focus are very fine cross wires, whose intersection is in the plane of the double sextant; and this was a whole circle, and turned in a lathe to a true plane, and is fixed at right angles to the limb; so that, whenever the limb is set horizontal, (which is readily done by making the spirit-tube

“ level over two screws, and the like over the other two),  
 “ the double sextant and telescope are moveable in a vertical plane; and then every angle taken on the limb  
 “ (though the telescope be never so much elevated or depressed) will be an angle in the plane of the horizon.  
 “ And this is absolutely necessary in plotting a horizontal plane.

“ If the lands to be plotted are hilly, and not in any one plane, the lines measured cannot be truly laid down on paper, without being reduced to one plane, which must be the horizontal, because angles are taken in that plane.—

“ In viewing your objects, if they have much altitude or depression, either write down the degree and decimal shewn on the double sextant, or the links shewn on the back side; which last subtracted from every chain in the station-line, leaves the length in the horizontal plane. But if the degree is taken, the following table will shew the quantity.

*A table of the links to be subtracted out of every chain in hypobensusal lines of several degrees altitude, or depression, for reducing them to horizontal.*

Degrees. Links.	Degrees. Links.	Degrees. Links.
4,05 — $\frac{1}{4}$	14,07 — 3	23,074 — 8
5,73 — $\frac{1}{2}$	16,26 — 4	24,495 — 9
7,02 — $\frac{3}{4}$	18,195 — 5	25,84 — 10
8,11 — 1	19,95 — 6	27,13 — 11
11,48 — 2	21,565 — 7	28,36 — 12

“ Let the first station line really measure 1107 links, and the angle of altitude or depression be  $19^{\circ}, 95'$ ; looking in the table you will find against  $19^{\circ}, 95'$  is 6 links. Now 6 times 11 is 66; which subtracted from 1107, leaves 1041, the true length to be laid down in the plan.

“ It is useful in surveying, to take the angles, which the bounding lines form, with the magnetic needle, in order to check the angles of the figure, and to plot them conveniently afterwards.”

*Of the Surfaces of Bodies.*

THE smallest superficial measure with us is a square inch; 144 of which make a square foot. Wrights make use of these in the measuring of deals and planks; but the square foot which the glaziers use in measuring of glass, consists only of 64 square inches. The other measures are, first, the ell square; secondly, the fall, containing 36 square ells; thirdly, the rood, containing 40 falls; fourthly, the acre, containing 4 roods. Slaters, masons, and paviers, use the ell square and the fall; surveyors of land use the square ell, the fall, the rood, and the acre.

The superficial measures of the English are, first, the square foot; secondly, the square yard, containing 9 square feet; for their yard contains only 3 feet; thirdly, the pole, containing  $30\frac{1}{2}$  square yards; fourthly, the rood, containing 40 poles; fifthly, the acre, containing

4 roods. And hence it is easy to reduce our superficial measures to the English, or theirs to ours.

“ In order to find the content of a field, it is most convenient to measure the lines by the chains described above, p. 693. that of 22 yards for computing the English acres, and that of 24 Scots ells for the acres of Scotland. The chain is divided into 100 links, and the square of the chain is 10,000 square links; ten squares of the chain, or 100,000 square links, give an acre. Therefore, if the area be expressed by square links, divide by 100,000, or cut off five decimal places, and the quotient shall give the area in acres and decimals of an acre. Write the entire acres apart; but multiply the decimals of an acre by 4, and the product shall give the remainder of the area in roods and decimals of a rood. Let the entire roods be noted apart after the acres; then multiply the decimals of a rood by 40, and the product shall give the remainder of the area in falls or poles. Let the entire falls or poles be then writ after the roods, and multiply the decimals of a fall by 36, if the area is required in the measures of Scotland; but multiply the decimals of a pole by  $30\frac{1}{2}$ , if the area is required in the measures of England, and the product shall give the remainder of the area in square ells in the former case, but in square yards in the latter. If, in the former case, you would reduce the decimals of the square ell to square feet, multiply them by 9.50694; but, in the latter case, the decimals of the English square yard are reduce to square feet, by multiplying them by 9.

“ Suppose, for example, that the area appears to contain 12.65842 square links of the chain of 24 ells; and that this area is to be expressed in acres, roods, falls, &c. of the measures of Scotland. Divide the square links by 100,000, and the quotient 12.65842 shows the area to contain 12 acres  $\frac{65842}{100000}$  of an acre: Multiply the decimal part by 4, and the product 2.63368 gives the remainder in roods and decimals of a rood. Those decimals of the rood being multiplied by 40, the product gives 25.3472 falls. Multiply the decimals of the fall by 36, and the product gives 12.4992 square ells. The decimals of the square ell multiplied by 9.50994 give 4.7458 square feet. Therefore the area proposed amounts to 12 acres, 2 roods, 25 falls, 12 square ells, and  $47\frac{458}{1000}$  square feet.

“ But if the area contains the same number of square links of Gunter's chain, and is to be expressed by English measures, the acres and roods are computed in the same manner as in the former case. The poles are computed as the falls. But the decimals of the pole, viz.  $\frac{458}{1000}$ , are to be multiplied by  $30\frac{1}{2}$  (or 30.25), and the product gives 10.5028 square yards. The decimals of the square yard, multiplied by 9, give 4.5252 square feet; therefore, in this case, the area is in English measure 12 acres, 2 roods, 25 poles, 10 square yards, and  $47\frac{5252}{1000}$  square feet.

“ The Scots acre is to the English acre, by statute, as 100,000 to 78,694. if we have regard to the difference betwixt the Scots and English foot above mentioned. But it is customary in some parts of England

“ to have 18, 21 &c. feet to a pole, and 160 such poles  
 “ to an acre; whereas, by the statute,  $16\frac{1}{2}$  feet make a  
 “ pole. In such cases the acre is greater in the dupli-  
 “ cate ratio of the number of feet to a pole.

“ They who measure land in Scotland by an ell of 37  
 “ English inches, make the acre less than the true Scots  
 “ acre by  $593\frac{1}{16}$  square English feet, or by about  $\frac{1}{77}$  of  
 “ the acre.

“ An husband-land contains 6 acres of sock and sythe-  
 “ land, that is, of land that may be tilled with a plough,  
 “ and mown with a sythe; 13 acres of arable land make  
 “ an oxgang or oxengate; four oxengate make a pound-  
 “ land of old extent (by a decree of the Exchequer,  
 “ March 11. 1585), and is called *librata terra*. A  
 “ forty-shilling land of old extent contains eight oxgang,  
 “ or 104 acres.

“ The arpent, about Paris, contains 32400 square Pa-  
 “ ris feet, and is equal to  $2\frac{1}{2}$  Scots roods, or  $3\frac{1}{3}$  Eng-  
 “ lish roods

“ The *actus quadratus*, according to Varro, Collu-  
 “ mella, &c. was a square of 120 Roman feet. The  
 “ *jugurum* was the double of this. It is to the Scots a-  
 “ cre as 10,000 to 20,456, and to the English acre as  
 “ 10,000 to 16,097. It was divided (like the *as*) into  
 “ 12 *uncia*, and the *uncia* into 24 *scrupula*.”—This,  
 with the three preceding paragraphs, are taken from an  
 ingenious manuscript, written by Sir Robert Stewart  
 professor of natural philosophy. The greatest part of  
 the table in p. 693. was taken from it likewise.

PROPOSITION XXVIII.

FIG. 12. To find out the area of a rectangular paral-  
 lelogram ABCD—Let the side AB, for example, be  
 5 feet long, and BC (which constitutes with BA a right  
 angle at B) be 17 feet. Let 17 be multiplied by 5, and  
 the product 85 will be the number of square feet in the area  
 of the figure ABCD. But if the parallelogram proposed  
 is not rectangular as BEFC, its base BC multiplied into  
 its perpendicular height AB (not into its side BE) will  
 give its area. This is evident from art. 68. of part 1.

PROPOSITION XXIX.

FIG. 13. To find the area of a given triangle.—Let  
 the triangle BAC be given, whose base BC is supposed 9  
 feet long; let the perpendicular AD be drawn from the  
 angle A opposite to the base, and let us suppose AD to  
 be four feet. Let the half of the perpendicular be multi-  
 plied into the base, or the half of the base into the per-  
 pendicular, or take the half of the product of the whole  
 base into the perpendicular, the product gives 18 square  
 feet for the area of the given triangle.

But if only the sides are given, the perpendicular is  
 found either by protracting the triangle, or by 12th and  
 13th 2 Eucl. or by trigonometry. But how the area of  
 a triangle may be found from the given sides only,  
 shall be shewn in the 31st prop.

PROPOSITION XXX.

FIG. 14. To find the area of any rectilinear figure—  
 If the figure be irregular, let it be resolved into triangles;  
 and drawing perpendiculars to the bases in each of them,  
 let the area of each triangle be found by the preceding  
 prop. and the sum of these areas will give the area of the  
 figure.

SCHOLIUM 1.

In measuring boards, planks, and plats, their sides are  
 to be measured by a foot-rule divided into 100 equal parts;  
 and after multiplying the sides, the decimal fractions are  
 easily reduced to lesser denominations. The mensuration  
 of these is easy, when they are rectangular parallelo-  
 grams.

SCHOLIUM 3.

If a field is to be measured, let it first be plotted on  
 paper, by some of the methods above described, and let  
 the figure so laid down be divided into triangles, as was  
 shown in the preceding proposition.

The base of any triangle, or the perpendicular upon  
 the base, or the distance of any two points of the field, is  
 measured by applying it to the scale according to which  
 the map is drawn.

SCHOLIUM 3.

But if the field given be not in a horizontal plane, but  
 uneven and mountainous, the scale gives the horizontal  
 line between any two points, but not their distance mea-  
 sured on the uneven surface of the field. And indeed it  
 would appear, that the horizontal plane is to be account-  
 ed the area of an uneven and hilly country. For if such  
 ground is laid out for building on, or for planting with  
 trees, or bearing corn, since these stand perpendicular to  
 the horizon, it is plain, that a mountainous country can-  
 not be considered as of greater extent for those uses than  
 the horizontal plane; nay, perhaps, for nourishing of  
 plants, the horizontal plane may be preferable.

If, however, the area of a figure, as it lies regularly on  
 the surface of the earth, is to be measured, this may be  
 easily done by resolving it into triangles as it lies. The  
 sum of their areas will be the area sought; which ex-  
 ceeds the area of the horizontal figure more or less, ac-  
 cording as the field is more or less uneven.

PROPOSITION XXXI.

FIG. 13. The sides of a triangle being given, to find the a-  
 rea, without finding the perpendicular.—Let all the sides of  
 the triangle be collected into one sum; from the half of  
 which let the sides be separately subtracted, that three  
 differences may be found betwixt the foresaid half sum  
 and each side; then let these three differences and the  
 half sum be multiplied into one another, and the square  
 root of the product will give the area of the triangle. For  
 example, let the sides be 10, 17, 21; the half of their  
 sum is 24; the three differences betwixt this half sum  
 and the three sides, are 14, 7, and 3. The first being  
 multiplied by the second, and their product by the third,  
 we have 294 for the product of the differences; which  
 multiplied by the foresaid half sum 24, gives 7056; the  
 square root of which 84 is the area of the triangle. The  
 demonstration of this, for the sake of brevity, we omit.  
 It is to be found in several treatises, particularly in Cla-  
 vius's Practical Geometry.

PROPOSITION XXXII.

FIG. 15. The area of the ordinate figure ABFGH  
 is equal to the product of the half circumference  
 of the polygon, multiplied into the perpendicular  
 drawn from the centre of the circumscribed circle to the  
 side of the polygon.—For the ordinate figure can be resol-  
 ved into as many equal triangles, as there are sides of the  
 figure;

figure; and since each triangle is equal to the product of half the base into the perpendicular, it is evident that the sum of all the triangles together, that is the polygon, is equal to the product of half the sum of the bases (that is the half of the circumference of the polygon) into the common perpendicular height of the triangles drawn from the centre C to one of the sides; for example, to AB.

P R O P O S I T I O N XXXIII.

FIG. 16. *The area of a circle is found by multiplying the half of the periphery into the radius, or the half of the radius into the periphery*—For a circle is not different from an ordinate or regular polygon of an infinite number of sides, and the common height of the triangles into which the polygon or circle may be supposed to be divided is the radius of the circle.

Were it worth while, it were easy to demonstrate accurately this proposition, by means of the inscribed and circumscribed figures, as is done in the 5th prop. of the treatise of Archimedes concerning the dimensions of the circle.

C O R O L L A R Y.

Hence also it appears, that the area of the sector ABCD is produced by multiplying the half of the arc into the radius, and likewise that the area of the segment of the circle ADC is found by subtracting from the area of the sector the area of the triangle ABC.

P R O P O S I T I O N XXXIV.

FIG. 17. *The circle is to the square of the diameter, as 11 to 14 nearly*.—For if the diameter AB be supposed to be 7, the circumference AHBK will be almost 22 (by the 22d prop. of this part), and the area of the square DC will be 49; and, by the preceding prop. the area of the circle will be  $38\frac{1}{2}$ ; therefore the square DC will be to the inscribed circle as 49 to  $38\frac{1}{2}$ , or as 98 to 77, that is, as 14 to 11. *Q. E. D.*

If greater exactness is required, you may proceed to any degree of accuracy: for the square DC is to the inscribed circle, as  $1$  to  $1 - \frac{1}{7} + \frac{1}{7} - \frac{1}{7} + \frac{1}{7} - \frac{1}{7} + \frac{1}{7}$ , &c. *in infinitum*.

“ This series will be of no service for computing the area of the circle accurately, without some further artifice, because it converges at too slow a rate. The area of the circle will be found exactly enough for most purposes, by multiplying the square of the diameter by 7854, and dividing by 10,000, or cutting off four decimal places from the product; for the area of the circle is to the circumscribed square nearly as 7854 to 10,000.”

P R O P O S I T I O N XXXV.

FIG. 18. *To find the area of a given ellipse*—Let ABCD be an ellipse, whose greater diameter is BD, and the lesser AC, bisecting the greater perpendicularly in E. Let a mean proportional HF be found (by 13th 6. Eucl.) between AC and BD, and (by the 33d of this) find the area of the circle described on the diameter HF. This area is equal to the area of the ellipse ABCD. For because, as BD to AC, so the square of BD to the square of HF, (by 2. cor 20th 6. Eucl.): but (by the 12. Eucl.) as the square of BD to the square of HF, so is the circle of the diameter BD to the circle of the diameter HF: therefore as BD to AC, so is the circle of

the diameter BD to the circle of the diameter HF. And (by the 5th prop. of Archimedes of spheroids) as the greater diameter BD to the lesser AC, so is the circle of the diameter BD to the ellipse ABCD. Consequently (by the 11th 5. Eucl.) the circle of the diameter BD will have the same proportion to the circle of the diameter HF, and to the ellipse ABCD. Therefore, (by 9th 5. Eucl.) the area of the circle of the diameter HF will be equal to the area of the ellipse ABCD. *Q. E. D.*

S C H O L I U M.

From this and the two preceding propositions, a method is derived of finding the area of an ellipse. There are two ways: 1st, Say, as one is to the lesser diameter, so is the greater diameter to a fourth number, (which is found by the rule of three.) Then again say, as 14 to 11, so is the 4th number found to the area sought. But the second way is shorter. Multiply the lesser diameter into the greater, and the product by 11; then divide the whole product by 14, and the quotient will be the area sought of the ellipse. For example, Let the greater diameter be 10, and the lesser 7; by multiplying 10 by 7, the product is 70; and multiplying that by 11, it is 770; and dividing 770 by 14, the quotient will be 55, which is the area of the ellipse sought.

“ The area of the ellipse will be found more accurately, by multiplying the product of the two diameters “ by 7854.”

We shall add no more about other plain surfaces, whether rectilinear or curvilinear, which seldom occur in practice; but shall subjoin some propositions about measuring the surfaces of solids.

P R O P O S I T I O N XXXVI.

*To measure the surface of any prism*.—By the 14th definition of the 11th Eucl. a prism is contained by planes, of which two opposite sides (commonly called the bases) are plain rectilinear figures; which are either regular and ordinate, and measured by prop. 32. of this; or however irregular, and then they are measured by the 38th prop. The other sides are parallelograms, which are measured by prop. 28th; and the whole superficies of the prism consists of the sum of those taken altogether.

P R O P O S I T I O N XXXVII.

*To measure the superficies of any pyramid*.—Since its basis is a rectilinear figure, and the rest of the planes terminating in the top of the pyramid are triangles; these measured separately, and added together, give the surface of the pyramid required.

P R O P O S I T I O N XXXVIII.

*To measure the superficies of any regular body*.—These bodies are called regular, which are bounded by equilateral and equiangular figures. The superficies of the tetraedron consists of four equal and equiangular triangles; the superficies of the hexaedron, or cube, of six equal squares; an octedron, of eight equal equilateral triangles; a dodecaedron, of twelve equal and ordinate pentagons; and the superficies of an icosaedron, of twenty equal and equilateral triangles. Therefore it will be easy to measure these surfaces from what has been already shown.

In the same manner we may measure the superficies of a solid contained by any planes.

P R O -

PROPOSITION XXXIX.

FIG. 19. *To measure the superficies of a cylinder.*—Because a cylinder differs very little from a prism, whose opposite planes (or bases) are ordinate figures of an infinite number of sides, it appears that the superficies of a cylinder, without the bases, is equal to an infinite number of parallelograms; the common altitude of all which is the same with the height of the cylinder, and the bases of them all differ very little from the periphery of the circle which is the base of the cylinder. Therefore this periphery multiplied into the common height, gives the superficies of the cylinder, excluding the bases; which are to be measured separately by the help of the 33d prop.

This proposition concerning the measure of the surface of the cylinder (excluding its basis) is evident from this, that when it is conceived to be spread out, it becomes a parallelogram, whose base is the periphery of the circle of the base of the cylinder stretched into a right line, and whose height is the same with the height of the cylinder.

PROPOSITION XL.

FIG. 20. *To measure the surface of a right cone.*—The surface of a right cone is very little different from the surface of a right pyramid, having an ordinate polygon for its base of an infinite number of sides; the surface of which (excluding the base) is equal to the sum of the triangles. The sum of the bases of these triangles is equal to the periphery of the circle of the base, and the common height of the triangles is the side of the cone AB; wherefore the sum of these triangles is equal to the product of the sum of the bases (*i. e.* the periphery of the base of the cone) multiplied into the half of the common height, or it is equal to the product of the periphery of the base.

If the area of the base is likewise wanted, it is to be found separately by the 33d prop. If the surface of a cone is supposed to be spread out on a plane, it will become a sector of a circle, whose radius is the side of the cone; and the arc terminating the sector is made from the periphery of the base. Whence, by corol. 3d prop. of this, its dimension may be found.

COROLLARY.

Hence it will be easy to measure the surface of a frustum of a cone cut by a plane parallel to the base.

PROPOSITION XLI.

FIG. 21. *To measure the surface of a given sphere.*—Let there be a sphere, whose centre is A, and let the area of its convex surface be required. Archimedes demonstrates (37 prop. 1. book of the sphere and cylinder) that its surface is equal to the area of four great circles of the sphere; that is, let the area of the great circle be multiplied by 4, and the product will give the area of the sphere; or, (by the 20th 6. and 2d 12 of Eucl.) the area of the sphere given is equal to the area of a circle whose radius is the right line BC, the diameter of the sphere. Therefore having measured (by 33d prop) the circle described with the radius BC, this will give the surface of the sphere.

PROPOSITION XLII.

FIG. 22. *To measure the surface of a segment of a sphere.*—Let there be a segment cut off by the plane

ED. Archimedes demonstrates (49, and 50. 1 *De sphaera*) that the surface of this segment, excluding the circular base, is equal to the area of a circle whose radius is the right line BE drawn from the vertex B of the segment to the periphery of the circle DE. Therefore, (by the 33d prop.) it is easily measured.

COROLLARY 1.

Hence that part of the surface of a sphere that lieth between two parallel planes is easily measured, by subtracting the surface of the lesser segment from the surface of the greater segment.

COROLLARY 2.

Hence likewise it follows, that the surface of a cylinder, described about a sphere (excluding the basis) is equal to the surface of the sphere, and the parts of the one to the parts of the other, intercepted between planes parallel to the basis of the cylinder.

*Of Solid Figures and their Mensuration, comprehending likewise the Principles of gauging Vessels of all Figures.*

As in the former part of this treatise we took an inch for the smallest measure in length, and an inch square for the smallest superficial measure; so now, in treating of the mensuration of solids, we take a cubical inch for the smallest solid measure. Of these 109 make a Scots pint; other liquid measures depend on this, as is generally known.

In dry measures, the firloft, by statute, contains 19½ pints; and on this depend the other dry measures: therefore, if the content of any solid be given in cubical inches, it will be easy to reduce the same to the common liquid or dry measures, and conversely to reduce these to solid inches. The liquid and dry measures, in use among other nations, are known from their writers.

“As to the English liquid measures, by act of parliament 1706, any round vessel, commonly called a cylinder, having an even bottom, being seven inches in diameter throughout, and six inches deep from the top of the inside to the bottom, (which vessel will be found by computation to contain 230  $\frac{2}{3}$  cubical inches), or any vessel containing 231 cubical inches, and no more, is deemed to be a lawful wine-gallon. An English pint therefore contains 28  $\frac{1}{2}$  cubical inches; two pints make a quart; four quarts a gallon; 18 gallons a roundlet; three roundlets and an half, or 63 gallons, make a hoghead; the half of a hoghead is a barrel; one hoghead and a third, or 84 gallons, make a puncheon; one puncheon and a half, or two hogheads, or 126 gallons, make a pipe or butt; the third part of a pipe, or 42 gallons, make a tierce; two pipes, or three puncheons, or four hogheads, make a ton of wine. Though the English wine gallon is now fixed at 231 cubical inches, the standard kept in Guildhall being measured, before many persons of distinction, May 25th 1688, it was found to contain only 224 such inches.

“In the English beer measure, a gallon contains 282 cubical inches; consequently 35½ cubical inches make a pint, two pints make a quart, four quarts make a gallon,

“gallon, nine gallons a firkin, four firkins a barrel. In ale, eight gallons make a firkin, and 22 gallons make a barrel. By an act of the first of William and Mary, 34 gallons is the barrel, both for beer and ale, in all places, except within the weekly bills of mortality.

“In Scotland it is known that four gills make a mutchkin, two mutchkins make a chopin; a pint is two chopins; a quart is two pints; and a gallon is four quarts, or eight pints. The accounts of the cubical inches contained in the Scots pint vary considerably from each other. According to our author, it contains 109 cubical inches. But the standard-jugs kept by the dean of guild of Edinburgh (one of which has the year 1555, with the arms of Scotland, and the town of Edinburgh, marked upon it) having been carefully measured several times, and by different persons, the Scots pint, according to those standards, was found to contain about  $103\frac{4}{5}$  cubic inches. The pewterers jugs (by which the vessels in common use are made) are said to contain sometimes betwixt 105 and 106 cubic inches. A cask that was measured by the brewers of Edinburgh, before the commissioners of Excise in 1707, was found to contain  $46\frac{7}{8}$  Scots pints; the same vessel contained  $18\frac{1}{8}$  English ale-gallons. Supposing this mensurating to be just, the Scots pint will be to the English ale-gallon as 289 to 750; and if the English ale-gallon be supposed to contain 282 cubical inches, the Scots pint will contain 108.664 cubical inches. But it is suspected, on several grounds, that the experiment was not made with sufficient care and exactness.

“The commissioners appointed by authority of parliament to settle the measures and weights, in their act of February 19. 1618, relate, That having caused fill the Linlithgow firloot with water, they found that it contained  $21\frac{1}{2}$  pints of the just Stirling jug and measure. They likewise ordain that this shall be the just and only firloot; and add, *That the wideness and breadtness of the which firloot, under and above even over within the buirds, shall contain nineteen inches and the sixth part of an inch, and the deepness seven inches and a third part of an inch.* According to this act (supposing their experiment and computation to have been accurate) the pint contained only 99.56 cubical inches; for the content of such a vessel as is described in the act, is 2115.85, and this divided by  $21\frac{1}{2}$  gives 99.56. But, by the weight of water said to fill this firloot in the same act, the measure of the pint agrees nearly with the Edinburgh standard above mentioned.

“As for the English measures of corn, the Winchester gallon contains  $272\frac{1}{4}$  cubical inches; two gallons make a peck; four pecks, or eight gallons (that is 2178. cubical inches) make a bushel; and a quarter is eight bushels.

“Our author says, that  $19\frac{1}{2}$  Scots pints make a firloot. But this does not appear to be agreeable to the statute above mentioned, nor to the standard-jugs. It may be conjectured that the proportion assigned by him has been deduced from some experiment of how many pints, according to common use, were contained in the firloot. For if we suppose those pints to have been each of 108 664 cubical inches, according to the experiment

“made in the 1707 before the commissioners of excise. described above; then  $19\frac{1}{2}$  such pints will amount to 2118.94, cubical inches; which agrees nearly with 2115.85, the measure of the firloot by statute above mentioned. But it is probable, that in this he followed the act 1587, where it is ordained, That the wheat-firloot shall contain 19 pints and two joucattes. A wheat-firloot marked with the Linlithow stamps being measured, was found to contain about 2211 cubical inches. By the statute of 1618 the barley-firloot was to contain 31 pints of the just Stirling-jug.

“A Paris pint is 48 cubical Paris inches, and is nearly equal to an English wine-quart. The *Boisseau* contains 644 68099 Paris cubical inches, or 780.36 English cubical inches.

“The Roman *amphora* was a cubical Roman foot, the *congius* was the eighth part of the *amphora*, the *sextarius* was one sixth of the *congius*. They divided the *sextarius* like the *as* or *libra*. Of dry measures, the *medimnus* was equal to two *amphoras*, that is, about  $1\frac{1}{2}$  English legal bushels; and the *modius* was the third part of the *amphora*.”

#### PROPOSITION XLIII.

*To find the solid content of a given prism.*—By the 29th prop. let the area of the base of the prism be measured, and be multiplied by the height of the prism, the product will give the solid content of the prism.

#### PROPOSITION XLIV.

*To find the solid content of a given pyramid.*—The area of the base being found, (by the 30th prop.) let it be multiplied by the third part of the height of the pyramid, or the third part of the base by the height, the product will give the solid content, by 7th 12. Eucl.

#### COROLLARY.

If the solid content of a *frustum* of a pyramid is required, first let the solid content of the entire pyramid be found; from which subtract the solid content of the part that is wanting, and the solid content of the broken pyramid will remain.

#### PROPOSITION XLV.

*To find the content of a given cylinder.*—The area of the base being found by prop. 33. if it be a circle, and by prop. 35. if it be an ellipse, (for in both cases it is a cylinder,) multiply it by the height of the cylinder, and the solid content of the cylinder will be produced.

#### COROLLARY.

FIG. 23. And in this manner may be measured the solid content of vessels and casks not much different from a cylinder, as ABCD. If towards the middle EF it be somewhat grosser, the area of the circle of the base being found (by 33d prop.) and added to the area of the middle circle EF, and the half of their sum (that is, an arithmetical mean between the area of the base and the area of the middle circle) taken for the base of the vessel, and multiplied into its height, the solid content of the given vessel will be produced.

Note, That the length of the vessel, as well as the diameters of the base, and of the circle EF, ought to be taken within the staves; for it is the solid content within the staves that is sought.

#### PROPOSITION XLVI.

*To find the solid content of a given cone.*—Let the

area

area of the base (found by prop. 33.) be multiplied into  $\frac{1}{3}$  of the height, the product will give the solid content of the cone; for by the 10th 12 Eucl. a cone is the third part of a cylinder that has the same base and height.

PROPOSITION XLVII.

FIG. 24. 25. To find the solid content of a frustum of a cone cut by a plane parallel to the plane of the base.—First, let the height of the entire cone be found, and thence (by the preceding prop.) its solid content; from which subtract the solid content of the cone cut off at the top, there will remain the solid content of the frustum of the cone.

How the content of the entire cone may be found, appears thus: Let ABCD be the frustum of the cone (either right or scalenous, as in the figures 2. and 3.) let the cone ECD be supposed to be completed; let AG be drawn parallel to DE, and let AH and EF be perpendicular on CD; it will be (by 2d 6. Eucl.) as CG:CA:: CD:CE; but (by art. 72. of part. 1.) as CA:AH::CE:EF; consequently (by 22d 5. Eucl.) as CG:AH::CD:FF; that is, as the excess of the diameter of the lesser base is to the height of the frustum, so is the diameter of the greater base to the height of the entire cone.

COROLLARY.

FIG. 26. Some casks whose staves are remarkably bended about the middle, and flrait towards the ends, may be taken for two portions of cones, without any considerable error. Thus ABEF is a frustum of a right cone, to whose base EF, on the other side, there is another similar frustum of a cone joined, EDCF. The vertices of these cones, if they be supposed to be completed, will be found at G and H. Whence, (by the preceding prop.) the solid content of such vessels may be found.

PROPOSITION XLVIII.

FIG. 27. A cylinder circumscribed about a sphere, that is, having its base equal to a great circle of the sphere, and its height equal to the diameter of the sphere, is to the sphere as 3 to 2.

Let ABEC be the quadrant of a circle, and ABDC the circumscribed square; and likewise the triangle ADC; by the revolution of the figure about the right line AC, as axis, a hemisphere will be generated by the quadrant, a cylinder of the same base and height by the square, and a cone by the triangle. Let these three be cut any how by the plane HF, parallel to the base AB; the section in the cylinder will be a circle whose radius is FH, in the hemisphere a circle of the radius EF, and in the cone a circle of the radius GF.

By (art. 69. of part 1.) EAq, or HFq=EFq and FAq taken together, (but AFq=FGq, because AC=CD); therefore the circle of the radius HF is equal to a circle of the radius EF together with a circle of the radius GF; and since this is true every where, all the circles together described by the respective radii HF (that is, the cylinder) are equal to all the circles described by the respective radii EF and FG (that is, to the hemisphere and the cone taken together); but, (by the 10th 12. Eucl.) the the cone generated by the triangle DAC is one third part of the cylinder generated by the square BC. Whence it follows, that the hemisphere generated by the rotation of the quadrant ABEC is equal to the remaining two third

parts of the cylinder, and that the whole sphere is  $\frac{2}{3}$  of the double cylinder circumscribed about it.

This is that celebrated 39th prop. 1. book of Archimedes of the sphere and cylinder; in which he determines the proportion of the cylinder to the sphere inscribed to be that of 3 to 2.

COROLLARY.

Hence it follows, that the sphere is equal to a cone whose height is equal to the semidiameter of the sphere, having for its base a circle equal to the superficies of the sphere, or to four great circles of the sphere, or to a circle whose radius is equal to the diameter of the sphere, (by prop. 41. of this.) And indeed a sphere differs very little from the sum of an infinite number of cones that have their bases in the surface of the sphere, and their common vertex in the centre of the sphere; so that the superficies of the sphere, (of whose dimension see prop. 41. of this) multiplied into the third part of the semidiameter, gives the solid content of the sphere.

PROPOSITION XLIX.

FIG. 28. To find the solid content of a sector of the sphere.—A spherical sector ABC (as appears by the cor. of the preceding prop.) is very little different from an infinite number of cones, having their bases in the superficies of the sphere BEC, and their common vertex in the centre. Wherefore the spherical superficies BEC being found (by prop. 42. of this), and multiplied into the third part of AB the radius of the sphere, the product will give the solid content of the sector ABC.

COROLLARY.

It is evident how to find the solidity of a spherical segment less than a hemisphere, by subtracting the cone ABC from the sector already found. But if the spherical segment be greater than a hemisphere, the cone corresponding must be added to the sector, to make the segment.

PROPOSITION L.

FIG. 29. To find the solidity of the spheroid, and of its segments cut by planes perpendicular to the axis.—

In prop. 44. of this, it is shewn, that every where EH:EG::CF:CD; but circles are as the squares described upon their rays, that is, the circle of the radius EH is to the circle of the radius EG, as CFq to CDq. And since it is so every where, all the circles described with the respective rays EH, (that is, the spheroid made by the rotation of the semi-ellipses AFB around the axis AB) will be to all the circles described by the respective radii EG, (that is, the sphere described by the rotation of the semicircle ADB on the axis AB) as FCq to CDq; that is, as the spheroid to the sphere on the same axis, so is the square of the other axis of the generating ellipse to the square of the axis of the sphere.

And this holds, whether the spheroid be found by a revolution around the greater or lesser axis.

COROLLARY 1.

Hence it appears, that the half of the spheroid, formed by the rotation of the space AHFC around the axis AC, is double of the cone generated by the triangle AFC about the same axis; which is the 32d prop. of Archimedes of conoids and spheroids.

COROLLARY 2.

Hence, likewise, is evident the measure of segments of the

the spheroid cut by planes perpendicular to the axis. For the segment of the spheroid made by the rotation of the space ANHE, round the axis AE, is to the segment of the sphere having the same axis AC, and made by the rotation of the segment of the circle AMGE, as CF to CD.

But if the measure of this solid be wanted with less labour, by the 24th prop. of Archimedes of conoids and spheroids, it will be as BE to AC+EB; so is the cone generated by the rotation of the triangle AHE round the axis AE, to the segment of the sphere made by the rotation of the space ANHE round the same axis AE; which could easily be demonstrated by the method of indivisibles.

COROLLARY 3.

Hence it is easy to find the solid content of the segment of a sphere or spheroid intercepted between two parallel planes, perpendicular to the axis. This agrees as well to the oblate as to the oblong spheroid; as is obvious.

COROLLARY 4.

FIG. 30. If a cask is to be valued as the middle piece of an oblong spheroid, cut by the two planes DC and FG; at right angles to the axis: first, let the solid content of the half spheroid ABCED be measured by the preceding prop. from which let the solidity of the segment DEC be subtracted, and there will remain the segment ABCD; and this doubled will give the capacity of the cask required.

The following method is generally made use of for finding the solid content of such vessels. The double area of the greatest circle, that is, of that which is described by the diameter AB at the middle of the cask, is added to the area of the circle at the end, that is, of the circle DC or FG (for they are usually equal), and the third part of this sum is taken for a mean base of the cask; which therefore multiplied into the length of the cask OP, gives the content of the vessel required.

Sometimes vessels have other figures, different from those we have mentioned; the easy methods of measuring which may be learned from those who practise this art. What hath already been delivered, is sufficient for our purpose.

PROPOSITION LI.

FIG. 31 and 32. To find how much is contained in a vessel that is in part empty, whose axis is parallel to the horizon.—Let AGBH be the great circle in the middle of the cask, whose segment GBH is filled with liquor, the segment GAH being empty; the segment GBH is known, if the depth EB be known, and EH a mean proportional between the segments of the diameter AB and EB; which are found by a rod or ruler put into the vessel at the orifice. Let the basis of the cask, at a medium, be found, which suppose to be the circle CKDL; and let the segment KCL be similar to the segment GAH (which is either found by the rule of three, because as the circle AGBH is to the circle CKDL, so is the segment GAH to the segment KCL; or is found from the tables of segments made by authors); and the product of this segment multiplied by the length of the cask will give the liquid content remaining in the cask.

PROPOSITION LII.

To find the solid content of a regular and ordinate

body.—A tetraedron being a pyramid, the solid content is found by the 44th prop. The hexaedron, or cube, being a kind of prism, it is measured by the 43d prop. An octaedron consists of two pyramids of the same square base and of equal heights; consequently its measure is found by the 44th prop. A dodecaedron consists of twelve pyramids having equal equilateral and equiangular pentagonal bases; and to one of these being measured (by the 44th prop. of this) and multiplied by 12, the product will be equal to the solid content of the dodecaedron. The icosaedron consists of 20 equal pyramids having triangular bases; the solid content of one of which being found (by the 44th prop.) and multiplied by 20, gives the whole solid. The bases and heights of these pyramids, if you want to proceed more exactly, may be found by trigonometry. See TRIGONOMETRY.

PROPOSITION LIII.

To find the solid content of a body however irregular.—Let the given body be immersed into a vessel of water, having the figure of a parallelepipedon or prism, and let it be noted how much the water is raised upon the immersion of the body. For it is plain, that the space which the water fills, after the immersion of the body, exceeds the space filled before its immersion, by a space equal to the solid content of the body, however irregular. But when this excess is of the figure of a parallelepipedon or prism, it is easily measured by the 43d prop. of this, viz. by multiplying the area of the base, or mouth of the vessel, into the difference of the elevations of the water before and after immersion. Whence is found the solid content of the body given.

In the same way the solid content of a part of a body may be found, by immersing that part only in water.

There is no necessity to insist here on diminishing or enlarging solid bodies in a given proportion. It will be easy to deduce these things from the 11th and 12th books of Euclid.

The following rules are subjoined for the ready computation of the contents of vessels, and of any solids in the measures in use in Great Britain.

I. To find the content of a cylindric vessel in English wine gallons, the diameter of the base and altitude of the vessel being given in inches and decimals of an inch.

Square the number of inches in the diameter of the vessel; multiply this square by the number of inches in the height; then multiply the product by the decimal fraction .0034; and this last product shall give the content in wine gallons and decimals of such a gallon. To express the rule arithmetically; let D represent the number of inches and decimals of an inch in the diameter of the vessel, and H the inches and decimals of an inch in the height of the vessel; then the content in wine gallons shall be  $DDH \times \frac{1}{29420}$ , or  $DDH \times .0034$ . Ex. Let the diameter D = 51.2 inches, the height H = 62.3 inches, then the content shall be  $51.2 \times 51.2 \times 62.3 \times .0034 = 555.27.342$  wine-gallons. This rule follows from prop. 33. and 45. for, by the former, the area of the base of the vessel is in square inches  $DD \times .7854$ ; and by the latter, the content of the vessel in solid inches



inches is DDHX.7854; which divided by 231 (the number of cubical inches in a wine-gallon) gives DDH X 0034, the content in wine-gallons. But though the charges in the excise are made (by statute) on the supposition that the wine-gallon contains 231 cubical inches; yet it is said, that in sale, 224 cubical inches, the content of the standard measured at Guildhall (as was mentioned above) are allowed to be a wine-gallon.

II. Supposing the English ale gallon to contain 282 cubical inches, the content of a cylindric vessel is computed in such gallons, by multiplying the square of the diameter of a vessel by its height as formerly, and their product by the decimal fraction .0,027,851: that is, the solid content in ale-gallons is DDHX.0,027,851.

III. Supposing the Scots pint to contain about 103.4 cubical inches, (which is the measure given by the standards at Edinburgh, according to experiments mentioned above), the content of a cylindric vessel is computed in Scots pints, by multiplying the square of the diameter of the vessel by its height, and the product of these by the decimal fraction .0076. Or the content of such a vessel in Scots pints is DDHX.0076.

Supposing the Winchester bushel to contain 2187 cubical inches, the content of a cylindric vessel is computed in those bushels by multiplying the square of the diameter of the vessel by the height, and the product by the decimal fraction .0,003,606. But the standard bushel having been measured by Mr Everard and others in 1696, it was found to contain only 2145 6 solid inches; and therefore it was enacted in the act for laying a duty upon malt, *That every round bushel, with a plain and even bottom, being 18½ inches diameter throughout, and 8 inches deep, should be esteemed a legal Winchester bushel.* According to this act (ratified in the first year of Queen Anne) the legal Winchester bushel contains only 2150.42 solid inches. And the content of a cylindric vessel is computed in such bushels, by multiplying the square of the diameter by the height, and their product by the decimal fraction .0,003,625. Or the content of the vessel in those bushels is DDH X .0,003,625.

V. Supposing the Scots wheat firloft to contain 21½ Scots pints, (as is appointed by the statute 1618), and the pint to be conform to the Edinburgh standards above mentioned, the content of a cylindric vessel in such firlots is computed by multiplying the square of the diameter by the height, and their product by the decimal fraction .00,358. This firloft, in 1426, is appointed to contain 17 pints; in 1457, it was appointed to contain 18 pints; in 1587, it is 19½ pints; in 1628, it is 21½ pints: and though this last statute appears to have been founded on wrong computations in several respects; yet this part of the act that relates to the number of pints in the firloft seems to be the least exceptionable; and therefore we suppose the firloft to contain 21½ pints of the Edinburgh standard, or about 2107 cubical inches; which a little exceeds the Winchester bushel, from which it may have been originally copied.

VI. Supposing the bear-firloft to contain 31 Scots pints, (according to the statute 1618), and the pint

conform to the Edinburgh standards the content of a cylindric vessel in such firlots is found by multiplying the square of the diameter by the height, and this product by .000,245.

When the section of the vessel is not a circle, but an ellipsis, the product of the greatest diameter by the least, is to be substituted in those rules for the square of the diameter.

VII. To compute the content of a vessel that may be considered as a *frustum* of a cone in any of those measures.

Let A represent the number of inches in the diameter of the greater base, B the number of inches in the diameter of the lesser base. Compute the square of A, the product of A multiplied by B, and the square of B, and collect these into a sum. Then find the third part of this sum, and substitute it in the preceding rules in the place of the square of the diameter; and proceed in all other respects as before. Thus, for example, the content in wine gallons is  $AA \times AB \times BB \times \frac{1}{3} \times H \times .0034$ .

Or, to the square of half the sum of the diameters A and B, add one third part of the square of half their difference, and substitute this sum in the preceding rules for the square of the diameter of the vessel; for the square of  $\frac{1}{2} A \times \frac{1}{2} B$  added to  $\frac{1}{3}$  of the square of  $\frac{1}{2} A - \frac{1}{2} B$ , gives  $\frac{1}{3} AA \times \frac{1}{3} AB \times \frac{1}{3} BB$ .

VIII. When a vessel is a *frustum* of a parabolic conoid, measure the diameter of the section at the middle of the height of the *frustum*; and the content will be precisely the same as of a cylinder of this diameter, of the same height with the vessel.

IX. When a vessel is a *frustum* of a sphere, if you measure the diameter of the section at the middle of the height of the *frustum*, then compute the content of a cylinder of this diameter of the same height with the vessel, and from this subtract  $\frac{1}{3}$  of the content of a cylinder of the same height, on a base whose diameter is equal to its height; the remainder will give the content of the vessel. That is, if D represent the diameter of the middle section, and H the height of the *frustum*, you are to substitute  $DD - \frac{1}{3} HH$  for the square of the diameter of the cylindric vessel in the first six rules.

X. When the vessel is a *frustum* of a spheroid, if the bases are equal, the content is readily found by the rule in p. 708. In other cases, let the axis of the solid be to the conjugate axis as  $n$  to 1; let D be the diameter of the middle section of the *frustum*, H the height or length of the *frustum*; and substitute in the first six rules  $DD - \frac{D^2}{3n^2}$  for the square of the square of the diameter of the vessel.

XI. When the vessel is an hyperbolic conoid, let the axis of the solid be to the conjugate axis as  $n$  to 1, D the diameter of the section at the middle of the *frustum*, H the height or length: compute  $DD \times \frac{1}{3n^2} \times HH$ , and substitute this sum for the square of the diameter of the cylindric vessel in the first six rules.

XII. In general, it is usual to measure any round vessel, by dividing it into several *frustums*, and taking

“ taking the diameter of the section at the middle of each *frustum*; thence to compute the content of each, as if it was a cylinder of that mean diameter; and to give their sum as the content of the vessel. From the total content, computed in this manner, they subtract successively the numbers which express the circular areas that correspond to those mean diameters, each as often as there are inches in the altitude of the *frustum* to which it belongs, beginning with the uppermost; and in this manner calculate a table for the vessel, by which it readily appears how much liquor is at any time contained in it, by taking either the dry or wet inches; having regard to the inclination or drip of the vessel, when it has any

“ This method of computing the content of a *frustum* from the diameter of the section at the middle of its height, is exact in that case only when it is a portion of a parabolic conoid; but in such vessels as are in common use, the error is not considerable. When the vessel is a portion of a cone or hyperbolic conoid, the content by this method is found less than the truth; but when it is a portion of a sphere or spheroid, the content computed in this manner exceeds the truth. The difference or error is always the same, in the different parts of the same or of similar vessels, when the altitude of the *frustum* is given. And when the altitudes are different, the error is in the triplicate ratio of the altitude. If exactness be required, the error in measuring the *frustum* of a conical vessel, in this manner, is  $\frac{1}{2}$  of the content of a cone similar to the vessel, of an altitude equal to the height of the *frustum*. In a sphere, it is  $\frac{2}{3}$  of a cylinder of a diameter and height equal to the *frustum*. In the spheroid and hyperbolic conoid, it is the same as in a cone generated by the right-angled triangle, contained by the two semi-axes of the figure, revolving about that side which is the semi-axis of the *frustum*.

“ In the usual method of computing a table for a vessel, by subtracting from the whole content the number that expresses the uppermost area, as often as there are inches in the uppermost *frustum*, and afterwards the numbers for the other areas successively; it is obvious that the contents assigned by the table, when a few of the uppermost inches are dry, are stated a little too high, if the vessel stands on its lesser base, but too low when it stands on its greater base; because, when one inch is dry, for example, it is not the area at the middle of the uppermost *frustum*, but rather the area at the middle of the uppermost inch, that ought to be subtracted from the total content, in order to find the content in this case.

“ XIII. To measure round timber: Let the mean circumference be found in feet and decimals of a foot; square it; multiply this square by the decimal .079,577, and the product by the length. Ex. Let the mean circumference of a tree be 103 feet, and the length 24 feet. Then  $103 \times 103 \times .079,577 \times 24 = 202,615$ , is the number of cubical feet in the tree. The foundation of this rule is, that when the circumference of a circle is 1, the area is .0795771715, and that the

“ areas of circles are as the squares of their circumferences.

“ But the common way used by artificers for measuring round timber, differs much from this rule. They call one fourth part of the circumference the *girt*, which is by them reckoned the side of a square, whose area is equal to the area of the section of the tree; therefore they square the *girt*, and then multiply by the length of the tree. According to their method, the tree of the last example would be computed at 159,13 cubical feet only.

“ How square timber is measured, will be easily understood from the preceding propositions. Fifty solid feet of hewn timber, and forty of rough timber, make a load.

“ XIV. To find the burden of a ship, or the number of tons it will carry, the following rule is commonly given. Multiply the length of the keel taken within board, by the breadth of the ship within board, taken from the midship beam from plank to plank, and the product by the depth of the hold, taken from the plank below the keelson to the under part of the upper deck plank, and divide the product by 94, the quotient is the content of the tonnage required. This rule however cannot be accurate; nor can one rule be supposed to serve for the measuring exactly the burden of ships of all sorts. Of this the reader will find more in the Memoirs of the Royal Academy of Sciences at Paris, for the year 1721.

“ Our author having said nothing of weights, it may be of use to add briefly, that the English Troy-pound contains 12 ounces, the ounce 20 penny-weight, and the penny weight 24 grains; that the Averdupois pound contains 16 ounces, the ounce 16 drams, and that 112 pounds is usually called the hundred weight. It is commonly supposed, that 14 pounds Averdupois are equal to 17 pounds Troy. According to Mr Everard's experiments, 1 pound Averdupois is equal to 14 ounces 12 penny weight and 16 grains Troy, that is, to 7000 grains; and an Averdupois ounce is 437  $\frac{1}{2}$  grains. The Scots Troy pound (which, by the statute 1718, was to be the same with the French) is commonly supposed equal to 15  $\frac{1}{2}$  ounces English Troy, or 7560 grains. By a mean of standards kept by the Dean of Guild at Edinburgh, it is 7599  $\frac{1}{4}$  or 7600 grains. They who have measured the weights which were sent from London, after the union of the kingdoms, to be the standards by which the weights in Scotland should be made, have found the English Averdupois pound (from a medium of the several weights) to weigh 7000 grains, the same as Mr Everard; according to which, the Scots, Paris, or Amsterdam-pound, will be to the pound Averdupois as 38 to 35. The Scots Troy stone contains 16 pounds, the pound 2 marks or 16 ounces, an ounce 16 drops, a drop 20 grains. Twenty Scots ounces make a Tiron pound; but because it is usual to allow one to the score, the Tiron pound is commonly 21 ounces. Sir John Skeer, however, makes the Tiron stone to contain only 10  $\frac{1}{2}$  pounds.”

GEORGE

**GEORGE**, or *Knights of St GEORGE*, has been the denomination of several military orders, whereof that of the garter is one of the most illustrious. See **CARTER**.

**St GEORGE-del Mina**, the capital of the Dutch settlements, on the gold-coasts of Guinea, situated seven or eight miles west of Cape-coast castle, the capital of the British settlements there: W. long. 5', and N. lat. 5°.

**Fort St GEORGE**, a town and fort on the coast of Comandul, in the Hither India: E. long. 80°, and N. lat. 12°.

The town is divided into the White and Black town. The fort, and White-town, which adjoins to it, are inhabited only by British; the whole circumference, which is not above half a mile, being surrounded by a stone wall. The outward, or Black town, called Madras, has been lately encompassed by a stone-wall and ballions and is about a mile and a half in circumference; the whole being almost environed by a river and the sea.

**St GEORGE'S**, the largest of the Bermuda, or Summer-islands.

**Crofs of St GEORGE**, a red one in a field argent, which makes part of the British standard.

**GEORGIA**, in Asia, a province bounded by Circassia and Dagestan on the north, by the Caspian sea on the east, by Armenia or Turcomania on the south, and by Mingrelia on the west.

**GEORGIA**, in America, one of the British plantations, taken out of South-Carolina, from which it is separated by the river Savannah on the north, and bounded by the Atlantic ocean on the east, by the river of St John, which divides it from Spanish Florida, on the south and west.

**GEORGIC**, a poetical composition upon the subject of husbandry, containing rules therein, put into a pleasing dress, and set off with all the beauties and embellishments of poetry.

Hesiod and Virgil are the two greatest masters in this kind of poetry.

The moderns have produced nothing in this kind, except Rapin's book of Gardening and the celebrated poem entitled Cyder by Mr Philips, who, if he had enjoyed the advantage of Virgil's language, would have been second to Virgil in a much nearer degree.

**GERANITES**, in natural history, an appellation given to such of the semipellucid gems as are marked with a spot resembling a crane's eye.

**GERANIUM**, **CRANE'S BILL**, in botany, a genus of the monodelphia decandria class. It has but one stylus; the stigmata are five; and the capsule is shaped like the bill of a crane. There are fifty-seven species, sixteen of which are natives of Britain, viz. the cicutarium, or hemlock-leaved crane's bill; the malchatum, or musked crane's bill; the maritimum, or sea crane's bill; the nodosum, or knotty crane's bill; the phœcum, or spotted crane's bill; the sylvaticum, or mountain crane's bill; the pratense, or crowfoot crane's bill; the robertianum, or herb Robert; the lucidum, or shining dove's foot crane's bill; the ro-

tundifolium, or round-leaved crane's bill; the perenne, or perennial dove's-foot crane's bill; the molle, or common dove's-foot crane's bill; the pusillum, or small flowered dove's-foot crane's bill; the columbinum, or long stalked dove's foot crane's bill; the dissectum, or jagged leaved dove's-foot crane's bill; and the sanguineum, or bloody crane's bill. The leaves of the robertianum and pratense were formerly used as astringents, but are now left out both of the London and Edinburgh dispensatories.

**GERARDIA**, in botany, a genus of the didynamia angiosperma class. The calix consists of five segments; the corolla is bilabiated, the inferior lip being divided into three parts; the lobes are emarginated, the middle one being divided into two segments; and the capsule is bilocular, and opens at the base. There are five species, none of them natives of Britain.

**GERFALCON**, or **GYRFALCON**. See **FALCO**.

**GERGENTUM**, a town of Sicily, the Agrigentum of the ancients, about fifty five miles south east of Palermo: E. long. 13° 30', N. lat. 37° 20'.

**GERMAINS**, or **St GERMAINS**, a town and royal palace of France, fourteen miles north-west of Paris.

**St GERMAINS** is also a borough of Cornwall, eight miles west of Plymouth. It sends two members to parliament.

**GERM**, among gardeners. See **BUD**.

**GERMAN**, in genealogy, denotes entire or whole; thus, a brother german is one both by the father's and mother's side; and cousins german are the children of brothers or sisters.

**GERMAN**, or **GERMANIC**, also denotes any thing belonging to Germany; as the German empire, German flute, &c.

**GERMANDER**, in botany. See **TEUCRIUM**.

**GERMANY**, an extensive empire of Europe, situated between 5° and 19° E. long. and between 45° and 55° N. lat.; bounded by Denmark and the Baltic sea on the north, by Poland and Hungary on the east, by Switzerland and the Alps on the south, and by France, Holland, &c. on the west.

It is divided into ten circles, three of which lie on the north, viz. Upper and Lower Saxony, and Westphalia; three on the south, viz. Austria, Bavaria, and Swabia; three about the middle, viz. Franconia, and the Upper and Lower Rhine; the tenth, which consisted of the duchy of Burgundy and the seventeen provinces of the Netherlands, have long been detached from the empire.

There are in Germany upwards of three hundred sovereign princes and states, most of them arbitrary in their respective territories.

**GERMEN**, or **GERM**. See **BUD**.

**GERMERSHEIM**, a town of Germany, subject to France, about ten miles east of Landau: E. long. 8° 15', and N. lat. 49° 12'.

**GERMINATION**, the first sprouting of the seeds of plants. See **AGRICULTURE**, Part I.

**GERONTES**, in Grecian antiquity, a sort of magistrates of ancient Sparta, answering to the areopagites at Athens.

GER-

**GERTRÜDENBURG**, a fortified town of the united Netherlands, in the province of Holland, nine miles north of Breda; subject to the prince of Orange.

**GERUND**, in grammar, a verbal noun of the neuter gender, partaking of the nature of a participle, declinable only in the singular number, through all the cases except the vocative; as, nom. *amandum*, gen. *amandi*, dat. *amando*, accus. *amandum*, abl. *amando*.

**GESNERIA**, in botany, a genus of plants, of the didynamia class. The calix rests upon the germen, and consists of five segments; the corolla is bent inwards and backwards; the capsule is below the flower, and bilocular. There are three species, none of them natives of Britain.

**GESTATION**, among physicians. See **PREGNANCY**.

**GESTRICIA**, a province of Sweden, bounded by Helsingia on the north, by the Bothnic gulph on the east, by Upland on the south, and by Dalecarlia on the west.

**GESTURE**, in rhetoric, consists chiefly in the proper action of the hands and face.

**CETHYLLIS**, in botany, a genus of the decandria-monogynia class. The calix is a spathe; the corolla consists of six segments; and the capsule has three cells. There is but one species, a native of Africa.

**GEVAUDAN**, a territory of Languedoc, adjoining to the Cevennes.

**GEUM**, in botany, a genus of the icofandria-pentagynia class. The calix has eight segments; the petals are eight; and the seeds are hairy and caudated. There are five species, two of which are natives of Britain, viz. the urbanum, or common avens; and the rivale, or water avens. The root of the avens is sometimes used as a stomachic.

**GHEENT**, or **GAUNT**, a city and capital of Flanders, thirty miles north west of Brussels: E. long.  $3^{\circ} 36'$ , N. lat.  $51^{\circ}$ .

It is a large fortified town, twelve miles in circumference, and defended by a citadel; and yet is a place of no great strength, by reason of the vast extent of ground it takes in.

**GIAGH**, in chronology, a cycle of twelve years; in use among the Turks and Cathayans.

Each year of the giagh bears a name of some animal: the first, that of a mouse; the second, that of a bullock; the third, of a lynx or leopard; the fourth, of a horse; the fifth, of a crocodile; the sixth, of a serpent; the seventh, of a horse; the eighth, of a sheep; the ninth, of a monkey; the tenth, of a hen; the eleventh, of a dog; and the twelfth, of a hog.

They also divide the day into twelve parts, which they call giaghs, and distinguish them by the name of some animals. Each giagh contains two of our hours, and is divided into eight kehs, as many as there are quarters in our hours.

**GIALLOLINO**, in natural history, a heavy, friable, fine, yellow ochre, called Naples yellow, and much used among painters, who esteem it a very fine colour.

**GIANT'S CAUSEWAY**, a vast collection of a black kind of marble, called basaltus, in the county of Antrim, in Ireland. See **BASALTUS**.

**GIBBOUS**, a term in medicine, denoting any protuberance or convexity of the body, as a person haunched, or hump backed.

**GIBBOUS**, in astronomy, a term used in reference to the enlightened parts of the moon, whilst she is moving from the first quarter to the full, and from the full to the last quarter: for all that time the dark part appears horned, or falcated; and the light one hunched out, convex, or gibbous.

**GIBELINS**, **GIBELLINS**, a famous faction in Italy, opposite to another called the Guelphs.

These two factions ravaged and laid waste Italy for a long series of years, so that the history of that country, for the space of two centuries, is no more than a detail of their mutual violences and slaughters. The Gibelins stood for the emperor against the pope: but concerning their origin and the reason of their names, we have but a very obscure account. According to the generality of authors, they rose about the year 1240, upon the emperor Frederick II.'s being excommunicated by the pope Gregory IX. Other writers maintain, that the two factions arose ten years before, though still under the same pope and emperor. But the most probable opinion is that of Maimbourg, who says, that the two factions of Guelphs and Gibelins arose from a quarrel between two ancient and illustrious houses on the confines of Germany, that of the Henries of Gibeling, and that of the Guelphs of Adorf.

**GIBRALTAR**, a port-town of Andalusia, in Spain, subject to Great Britain: W. long.  $6^{\circ}$ , and N. lat.  $36^{\circ}$ .

It stands at the foot of mount Calpe, one of Hercules's pillars, about sixteen miles north of Ceuta, in Africa, from which it is divided by the Streights, to which it gives name. It is built on a rock, in a peninsula, and can only be approached on the land-side by a very narrow passage between the mountain and the sea: cross this passage the Spaniards have drawn a line, and fortified it, to prevent the garrison's having any communication with the country.

The Straits of Gibraltar are about twenty-four miles long, and fifteen broad.

**GIFT**, in Scots law. See **DONATION**.

**GIGG**, or **JIGG**, in music, denotes a brisk and lively air; or an airy kind of dance to a sprightly measure.

**GILAN**, a province of Persia, bounded by the Caspian Sea on the north. Its capital is a city of the same name: E. long.  $48^{\circ}$ , and N. lat.  $37^{\circ}$ .

**GILBERTINES**, a religious order founded in England by St Gilbert, in the reign of Henry I. The nuns followed the rule of St Benedict, and the monks that of Augustin. There were many monastries of this order in different parts of England.

**GILDING**, the art of spreading or covering a thing with gold, either in leaf or liquid.

We have this advantage over the ancients, in the manner of using and applying the gold, that the secret of painting in oil, lately discovered, furnishes us with means of gilding works, capable of enduring all the violence of time and weather, which theirs could not.

There

There are several methods of gilding in use among us, as gilding in water, gilding in oil, gilding by fire, &c.

*The method of water-gilding.* Water-gilding requires more preparation than oil gilding, and is chiefly on wooden works, and those made of stucco; and these too must be sheltered from the weather. A size is used for this way of gilding made of shreds, &c. of parchment or gloves boiled in water to the consistence of a jelly. If the thing to be gilt be of wood, it is first washed with this size, boiling hot, and then set to dry; and afterwards with white paint mixed up with the same size. Some use Spanish white for this purpose, and others plaster of Paris, well beaten and sifted. This sized paint must be laid on with a stiff brush; which is to be repeated seldomer or oftener according to the nature of the work, as ten or twelve times in flat or smooth works; but seven or eight times will be sufficient in pieces of sculpture. In the former case they are applied by drawing the brush over the work, in the latter by daubing it. When the whole is dry, they moisten it with fair water, and rub it over with several pieces of coarse linen, if it be on the flat; if not, they beat or switch it with several slips of the same linen, tied to a little stick, to make it follow and enter all the cavities and depressures thereof.

Having thus finished the white, the next thing to be done, is to colour it with yellow ochre: but if it be a piece of sculpture in relievo, they first touch it up, and prepare the several parts, which may have happened to have been disfigured, by the small iron instruments, as gouges, chissels, &c. The ochre used for this purpose must be well ground and sifted, and mixed up with the size before-mentioned. This colour is to be laid on hot; and in works of sculpture, supplies the place of gold, which sometimes cannot be carried into all the depressures and cavities of the foliages and ornaments. A lay is also applied over this yellow, which serves for the ground on which the gold is to be laid: this lay is usually composed of Armenia bole, blood-stone, black-lead, and a little fat; to which some add soap, and oil of olives; others, burnt bread, bistre, antimony, glass of tin, butter, and sugar-candy. These ingredients being all ground down together with hot size, three lays of this composition is applied upon the yellow, the one after the other has been dried; being cautious not to put any into the cavity of the work to hide the yellow.

The brush used for this purpose, must be a soft one; and when the matter is become very dry, they go over it again with a stronger brush, to rub it down, and take off the small grains that stick out, in order to facilitate the burnishing of the gold.

To be prepared for gilding, you must have three sorts of pencils; one to wet, another to touch up and amend, and a third to flatten; also a gilding cushion, for spreading the leaves of gold on when taken out of the book; a knife to cut them, and a squirrel's tail fitted with a handle; or else a piece of fine soft stuff on a slick, to take them up directly and apply them. You

Vol. II. No. 56.

2

are first to begin with wetting your pencils; by which the last lay laid on with water is moistened, that it may the better receive and retain the gold. Then you are to lay the leaves of gold on the cushion; and if whole, you must take up with the squirrel's tail, but, if in pieces, with the other instrument, or the knife wherewith they are cut, and lay and spread them gently on the parts of the work you had moistened before. If the leaves, as they frequently do, happen to crack or break in laying on, these breaches must be made up with small bits of leaf, taken up upon the repairing pencil, and the whole work is to be smoothed either with the same pencil, or another something larger; the gold being pressed into the dents, into which it could not be so easily carried by the squirrel's tail.

The work having been thus far gilded, must be set to dry, in order to be burnished and flatted. See BURNISHING.

The last operation is the applying the vermeil in all the little lines and cavities; and to stop and amend any little faults with shell-gold. The composition called of vermeil is made of gum gutta, vermilion, and a little of some ruddy-brown, ground together with venetian varnish and oil of turpentine. Some gilders, instead of this, make shift with fine lacca, or dragon's blood, with gum-water.

Sometimes, instead of burnishing the gold, they burnish the ground or composition laid on the last before it, and only afterwards wash the part over with the size. This method is chiefly practised for the hands, face, and other nudities in relievo: which, by this means, do not appear so very brilliant as the parts burnished, though much more so than the parts perfectly flat.

To gild a piece of work, and yet preserve white grounds, they apply a lay of Spanish white, mixed with a weak fish-glue, on all the parts of the ground, whereon the yellow or the last lay might run.

*The method of GILDING in oil.* This operation requires much less apparatus than that before-mentioned. The basis or matter whereon the gold is laid, in this method, is the remains of colours found settled to the bottom of the pots in which painters wash their pencils. This matter, which is very viscid or sticky, is first ground, and then passed through a linen-cloth, and thus laid on the matter to be gilt, after it is washed once or twice over with size; and if it be wood, with some white paint.

When this is almost dry, but yet is still unctuous enough to catch and retain the gold, the leaf-gold is laid on, either whole, if the work be large, or cut to pieces, if smaller: the leaves of gold are taken up and laid on with a piece of fine, soft, well carded cotton; or sometimes by a pallet for the purpose, or sometimes with the knife with which the leaves were cut, according to the parts of the work that are to be gilded, or the breadth of the gold that is to be laid on. As the gold is laid on, they pass over it a coarse stiff pencil brush, to make it stick and as it were incorporate with the ground; and after this they mend any cracks that may

†

7 R

may

may have happened in it, either with the same pencil or one that is smaller, as has been shown before in water gilding.

This kind of gilding is chiefly used for domes and roofs of churches, courts, banqueting-houses, &c. and for figures of plates of Paris, lead, &c.

*The method of GILDING with liquid gold.* This is performed by gold reduced to a calx and amalgamated with mercury, in the proportion of about an ounce of mercury to a dram of gold. To perform this, they heat a crucible red hot, and then put the gold and mercury into it, stirring them gently about till the gold be found melted, and incorporated into a mass with the mercury. When this is done, they cast them into water, to wash and purify them; and out of that into other waters, where the amalgama, which is almost as liquid as if there were nothing but quicksilver in it, may be preserved a long time for use.

Before they proceed to lay this amalgamated gold on the metal, they first render the metal rough, by washing it over with aqua fortis, or aqua secunda; and afterwards rinse the metal in fair water, and scour it a little with fine sand, and then it is ready for the gold.

They next cover over the metal with the mixture of gold and mercury, taking it up with a slip of copper, or a brush made of brass-wire, spreading it as even as possible, to do which they wet the brush from time to time in fair water. Then they set the metal to the fire, upon a grate, or in a sort of cage, under which stands a pan of coals; and in proportion as the mercury, evaporating and flying off, discovers the places where gold is wanting, they take care to supply them by adding new parcels of amalgama.

Then the work is rubbed over with the wire brush, dipt in beer or vinegar, which leaves it in a condition to be brought to a colour which is the last part of the process, and which the gilders keep to themselves as a mighty secret.

*The method of GILDING by fire on metal.* To prepare the metal, they scratch it well, or rake it; then polish it with a polisher; and afterwards set it to the fire to blue, *i. e.* to heat, till it appear of a blue colour. When this has been done, they clap on the first lay of leaf gold, rubbing it lightly down with a polisher; and expose it thus to a gentle fire. They usually give it but three such lays, or four at the most, each lay consisting of a single leaf for common works, and of two for extraordinary ones: after each lay, it is set a-fresh to the fire; and after the last lay, the gold is in condition to be burnished.

*To gild paper.* Grind bole-armoniac (with rain-water, and give one laying of it; when it is dry, take glair of eggs, and add to it a little sugar candy and gum-water, which lay over the former; and upon this, when it is dry enough, lay leaf-silver, or leaf-gold.

*To gild the covers of books.* Take bole armoniac, eight penny-weight; sugar-candy, two penny-weight; mix and grind them with glair of eggs: then on a bound book (while it is in the press, after it hath been linear-

ed with glair of eggs, and is dried) linear the said composition; let it dry, then rub it well and polish it; then with fair water wet the edges of the book, and suddenly lay on the gold, press it down gently with cotton, let it dry, and then polish it with a tooth.

**GILL**, a measure of capacity, containing a quarter of an English pint.

**GILLS**, in ichthyology. SEE BRANCHIAE.

**GILOLO**, a large island of the pacific ocean, lying between 1° S. lat. and 2° N. lat. and between 125° and 128° E. long.

**GILOLO** is also the name of the capital of the above island, situated in 40' N. lat.

**GIN**, in mechanics, a machine for driving piles, fitted with a windlass and winches at each end, where eight or nine men heave, and round which a rope is reeved that goes over the wheel at the top: one end of this rope is seized to an iron monkey, that hooks to a beetle of different weights, according to the piles they are to drive, being from eight to thirteen hundred weight; and when hove up to a cross piece, near the wheel, it unhooks the monkey, and lets the beetle fall on the upper end of the pile, and forces the same into ground: then the monkey's own weight over-hauls the windlass, in order for its being hooked again to the beetle.

**GINGEN**, an imperial city of Germany, twenty miles E. of Ulm: E. long. 10°, and north lat. 48° 36'.

**GINGER**, the root of a species of animum, too well known to need any description: It is a very useful spice in cold flatulent colics, and in laxity and debility of the intestines.

**GINGLYMUS**, in anatomy. See ANATOMY, p. 149.

**GINSENG**, a small root brought from North America, and sometimes from China. It has a sweet taste, accompanied with a slight bitterness and warmth. The Chinese look upon it as an universal restorative in all decays.

**GIRONNE**, a large city and bishop's see of Spain, in the province of Catalonia, forty five miles north-east of Barcelona: E. long. 2° 35', and N. lat. 32°.

**GIRONNE**, or **GIRONNY**, in heraldry, a coat of arms divided into girones, or triangular figures, meeting in the centre of the shield, and alternately colour and metal. See Plate XCVII. fig. 5.

**GISBORN**, a market-town of Yorkshire, fifty miles west of York.

**GISBOROUGH**, another market town of Yorkshire, thirty-seven miles north of York.

**GISORS**, a city of Normandy in France, twenty-eight miles south-east of Rouen: E. long. 1° 25', N. lat. 50° 10'.

**GLACIS**, in building, an easy insensible slope or declivity.

The descent of the glacis is less steep than that of the talus. In girding, a descent sometimes begins in talus, and ends in glacis.

The glacis of the corniche, is an easy imperceptible slope in the cymatium, to promote the descent and draining off the rain water.

**GLACIS**, in fortification, that mass of earth which serves

as a parapet to the covered way, sloping easily towards the champain or field.

**GLADDON.** See **LUIS.**

**GLADE**, in gardening and agriculture, an opening and light passage made through a wood, by lopping off the branches of trees along that way.

**GLADIATORS**, in antiquity, persons who fought generally in the arena at Rome, for the entertainment of the people.

The gladiators were usually slaves, and fought out of necessity; though sometimes freemen made profession thereof, like our prize fighters, for a livelihood. The Romans borrowed this cruel diversion from the Asiatics; and we find that the very high-priests had their *ludi pontificales*, and *ludi sacerdotales*. As from the earliest ages of antiquity we read that it was customary to sacrifice prisoners of war to the manes of the great men that fell in the engagement; in process of time they came to sacrifice slaves at the funerals of all persons of condition; but as it would have appeared barbarous to cut their throats like beasts, they were appointed to fight with each other, and do their best to save their own lives by killing their adversary.

Hence arose the masters of-arms called *lanistæ*, and men learned to fight. These *lanistæ* bought slaves to train up to this cruel trade, whom they afterwards sold to such as had occasion to exhibit shows. Junius Brutus, who expelled the kings, was the first that honoured the funeral of his father with these inhuman diversions at the sepulchre of the deceased; but afterwards they were removed to the circus and amphitheatres; and other persons, besides slaves, would hire themselves to this infamous office.

They were all first sworn that they would fight till death; and if they failed, they were put to death, either by fire, swords, clubs, whips, &c. It was usual with the people, or emperor, to grant them life when they shewed no signs of fear. Augustus decreed that it should always be granted them.

From slaves and freed men, the wanton sport spread to persons of rank, as we find in Nero's time. And Domitian exhibited combats of women in the nighttime; we also read, that dwarfs encountered with one another. Constantine the Great first prohibited these combats in the East; but the practice was not entirely abolished in the West before Theodoric king of the Ostrogoths, in the year 500.

When any person designed to entertain the people with a show of gladiators, he set up bills in the public places, giving an account of the time, the number and names of the combatants, and the circumstances whereby they were to be distinguished; each having his several badge, which generally was a peacock's feather: they also gave notice what time the show would last; and sometimes gave representations of these things in painting, as is practised among us, by those who have any thing to show at fairs, &c.

Upon the day appointed for the show, in the first place the gladiators were brought out all together, and obliged to take a circuit round the arena in a very so-

lemn and pompous manner. After this they proceeded, *paria componere*, to match them by pairs, in which great care was taken to make the matches equal. The first sort of weapons they made use of were staves, or wooden files, called *rudis*; and the second were effective weapons, as swords, poinards, &c.

The first were called *arma lusoria*, or *exercitoria*; the second, *decretoria*, as being given by decree or sentence of the prætor, or of him at whose expence the spectacle was exhibited.

They began to fence or skirmish with the first, which was to be the prelude to the battle; and from these, when well warmed, they advanced to the second, with which they fought naked. The first part of the engagement was called *ventilare, præludere*; and the second *dimicare ad certum, or versus armis pugnare*.

When any received a remarkable wound, either his adversary or the people used to cry out, *Habet, or, Hoc habet*. If the vanquished surrendered his arms, it was not in the victor's power to grant him life: it was the people during the time of the republic, and the prince or people during the time of the empire, that were alone empowered to grant this boon. The two signs of favour and dislike given by the people were, *premere pollicem*, and *vertere pollicem*; the former of which M. Dacier takes to be a clenching of the fingers of both hands between one another, and to holding the two thumbs upright close together, was a sign of the people's admiration of the courage shewn by both combatants; and at the same time for the conqueror to spare his antagonist's life: but the contrary motion, or bending back of the thumbs, signified the dissatisfaction of the spectators, and authorised the victor to kill the other combatant downright for a coward. The emperor saved whom he liked, if he was present at the solemnity, in the same manner.

After the engagement, several marks of favour were conferred on the victor, particularly a branch of palm-tree; and oftentimes a sum of money, perhaps gathered up among the spectators: but the most common rewards were the *pileus* and the *rudis*; the former being given only to such gladiators as were slaves, for a token of obtaining their freedom; but the *rudis* seems to have been bestowed both on slaves and freemen, with this difference, that it procured the former no more than a discharge from any further performance in public, upon which they commonly turned *lanista*: but the *rudis*, when given to such persons as, being free, had hired themselves out for these shows, restored them to a full enjoyment of their liberty. See **PILEUS**, **RUDIS**, and **LANISTA**.

**GLADIOLUS**, in botany, a genus of the triandria monogynia class. The corolla is ringent, and divided into six parts. There are ten species, none of them natives of Britain.

**GLAMA.** See **CAMELUS**.

**GLAMORGANSHIRE**, a county of South Wales, bounded by Brecknockshire on the north, and by the Bristol channel on the south. Its capital is Landaff.

**GLAND**, in anatomy. See **ANATOMY**, p. 307.

**GLANDERS,**

GLANDERS. See FARRIERY, p. 557.

GLANS. in anatomy. See ANATOMY, p. 270.

GLARIS, the capital of one of the cantons of Switzerland, of the same name, the inhabitants of which are both protestant and popish: it is situated thirty-five miles south-east of Zurich, in E. long. 9°, and N. lat. 47°.

GLASGOW, a large city of Scotland, in the shire of Lanerkshire, or Clydesdale, situated on the river Clyde, twenty miles north-west of Lanerk, and forty miles west of Edinburgh, in 4° 8', W. long. and 55° 5', N. lat.

This is one of the most elegant towns in Scotland. It has an university, and a good foreign trade.

GLASS, a transparent, brittle, facitious body, produced by the action of fire upon a fixt salt and sand, or stone, that readily melts.

The chemists hold, that there is no body but may be vitrified, or converted into glass; being the last effect of fire, as all its force is not able to carry the change of any natural body beyond its vitrification.

When or by whom the art of making glass was first found out is uncertain: some will have it invented before the flood; but without any proof. Neri traces the antiquity of this art as far back as the time of Job: but Dr Merret will have it as ancient as either pottery, or the making of bricks: because that a kiln of bricks can scarce be burnt, or a batch of pottery be made, but some of the bricks and the ware will be at least superficially turned to glass; so that it must have been known at the building of Babel, and as long before as the making of bricks was used. It must have been known, consequently, among the Egyptians, when the Israelites were employed by them in making bricks. Of this kind, no doubt, was that fossil glass mentioned by Ferrant. Imperat. to be found under-ground in places where great fires had been. The Egyptians indeed boast, that this art was taught them by the great Hermes. Aristophanes, Aristotle, Alexander Aphrodisæus, Lucretius, and John the divine, put us out of all doubt that glass was in use in their days.

Pliny relates, that it was first discovered accidentally in Syria, at the mouth of the river Belus, by certain merchants driven thither by a storm at sea, who, being obliged to continue there, and dress their vicals, by making a fire on the ground, where there was great plenty of the herb kali; that plant burning to ashes, its salts mixed and incorporated with sand, or stones fit to vitrify, and produced glass: that this accident being known, the people of Sidon, in that neighbourhood, assayed the work, improved the hint, and brought it into use; and that this art has been improving ever since.

Venice, for many years, excelled all Europe in the fineness of its glasses; but of late the French and English have excelled in the Venetians, so that we are no longer supplied with this commodity from abroad.

*Nature and characters of GLASS.* Naturalists are divided in what class of bodies to rank glass: some making it a concrete juice; others a stone; others again rank it among semi-metals; but Dr Merret observes,

that these are all natural productions, whereas glass is a facitious compound, produced by fire, and never found in the earth, but only the sand and stone that form it: that metals are formed by nature into certain species; and that fire only produces them, by its faculty of separating heterogeneous, and uniting homogeneous bodies: whereas it produces glass, by uniting heterogeneous matter, viz. salt and sand, of both which it evidently consists; 100 lb weight of sand yielding above 150 lb of glass.

The same learned doctor gives us a precise and accurate enumeration of the several characters, or properties of glass, whereby it is distinguished from all other bodies, viz. 1. That it is an artificial concrete of salt and sand, or stones. 2. Fusible by strong fire. 3. When fused, tenacious and coherent. 4. It does not waste nor consume in the fire. 5. When melted, it cleaves to iron. 6. When it is red hot, it is ductile, and may be fashioned into any form; but not malleable; and capable of being blown into a hollowness, which no mineral is. 7. Frangible when thin, without annealing. 8. Friable, when cold. 9. Diaphanous, whether hot or cold. 10. Flexible and elastic. 11. Dissoluble by cold and moisture. 12. Only capable of being graven or cut with a diamond, or other hard stone and emery. 13. Receives any dye or colour both externally and internally. 14. Not dissoluble by aqua fortis, aqua regia, or mercury. 15. Neither acid juices nor any other matter extract either colour, taste, or any other quality from it. 16. Admits of polishing. 17. Neither loses weight nor substance by the longest and most frequent use. 18. Gives fusion to other metals, and softens them. 19. The most pliable thing in the world, and that which best retains the fashion given it. 20. Not capable of being calcined. 21. An open glass being filled with water in the summer-time, will gather drops of water on the outside, just so far as the water on the inside reaches; and a person's breath blown on it will manifestly moisten it. 22. Little glass balls filled with water, mercury, and other liquor, and thrown into the fire, as also drops of green glass being broken, will fly asunder with a great noise. 23. Neither wine, beer, nor any other liquor, will make it misty, or change its colour, or rust it. 24. It may be cemented, as stones and metals. 25. A drinking glass, partly filled with water, and rubbed on the brim with a wet finger, yields musical notes, higher or lower as the glass is more or less full, and will make the liquor frisk and leap.

*Materials for making of GLASS.* The materials whereof glass is made, we have already mentioned to be salt and sand, or stones. The salt here used, is procured from a sort of ashes, brought from the Levant, called pulverine, or rochetta; which ashes are those of a sort of water-plant, called kali, cut down in summer, dried in the sun, and burnt in heaps, either on the ground, or on iron grates; the ashes falling into a pit, grow into a hard mass, or stone, fit for use.

To extract the salt, these ashes, or pulverine, are powdered and sifted, then put into boiling water, and there kept till one third of the water be consumed: the whole

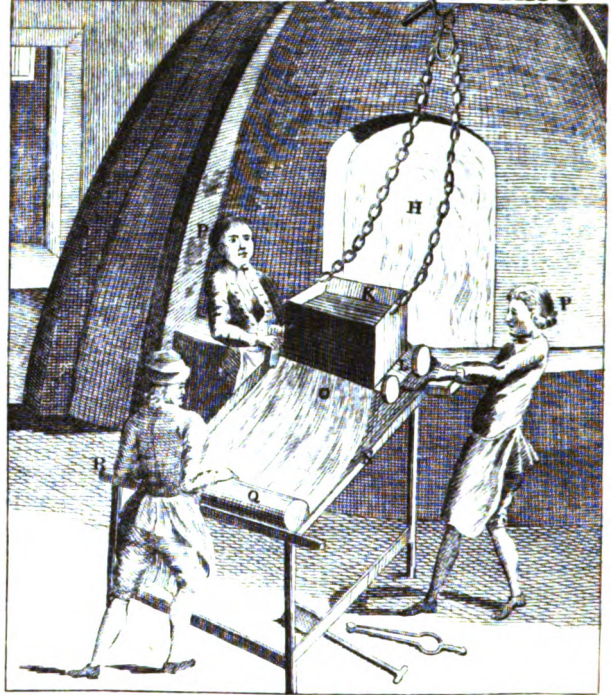




*Fig. 1.* GLASS MAKERS at work

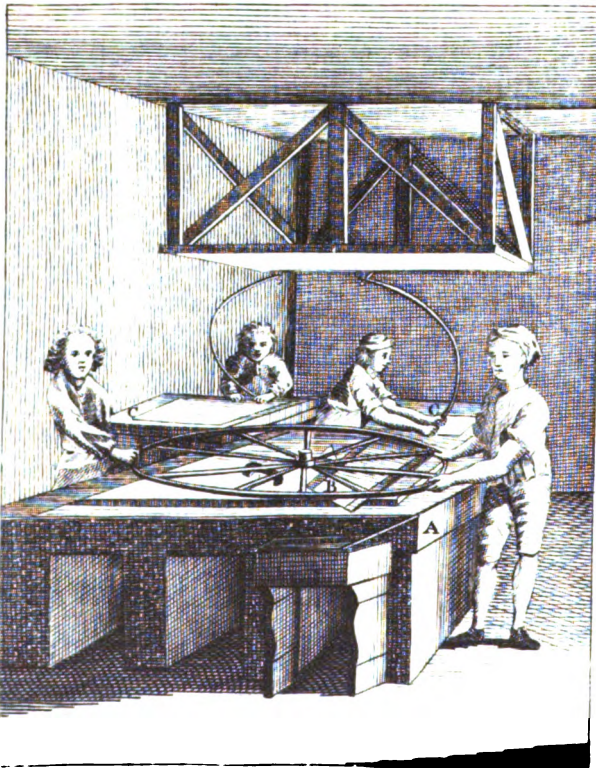


*Fig. 2.* Casting and Running of PLATE GLASS Plate XC VII

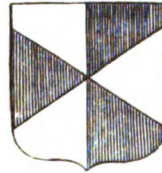


*Fig. 3.*

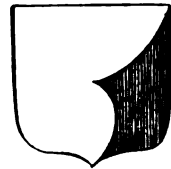
Grinding and Polishing of PLATE GLASS.



*Fig. 4.*  
GIROUETTE.



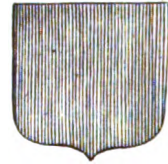
*Fig. 5.*  
GORE.



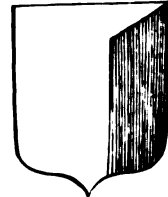
*Fig. 6.*  
GARDANT



*Fig. 7.*  
GULES



*Fig. 8.*  
GUSSET



*Wells, sculp.*

whole being stirred up, from time to time, that the ashes may incorporate with the fluid, and all its salts be extracted: then the vessel is filled up with new water, and boiled over again, till one half be consumed; what remains is a sort of lee, strongly impregnated with salt. This lee, boiled over again in fresh coppers, thickens in about twenty-four hours, and shoots its salt; which is to be ladled out, as its shoots, into earthen pans, and thence into wooden fats to drain and dry. This done, it is grossly pounded, and thus put in a sort of oven, called calcar, to dry. It may be added, that there are other plants, besides kali, which yield a salt fit for glass: such are the alga, or sea weed, the common way-thistle, bramble, hops, wormwood, woad, tobacco, fern, and the whole leguminous tribe, as pease, beans, &c.

The sand or stone, called by the artists Tarso, is the second ingredient in glass, and that which gives it the body and firmness. These stones, Agricola observes, must be such as will fuse; and of these such as are white and transparent are best; so that crystal challenges the precedence of all others.

At Venice they chiefly use a sort of pebble, found in the river Tefino, resembling white marble, and called cuogolo. Indeed Ant. Neri assures us, that all stones which will strike fire with steel, are fit to vitrify: but Dr Merret saith, that there are some exceptions from this rule. Flints are admirable; and when calcined, powdered, and searched, make a pure white crystalline metal: but the expence of preparing them makes the masters of our glass-houses sparing of their use. Where proper stones cannot be so conveniently had, sand is used; which should be white, and small, and well washed, before it be applied: such is usually found in the mouths and sides of rivers. Our glass-houses are furnished with a fine sand for crystal, from Maidstone; the same with that used for sand boxes, and in scouring; and with a coarser for green glass from Woolwich. For crystal glass, to 200 lb of tarso, pounded fine, they put 130 lb of salt of polverine; mix them together, and put them into the calcar, a sort of reverberatory furnace, being first well heated. Here they remain baking, frying, and calcining, for five hours, during which the workman keeps mixing them with a rake, to make them incorporate: when taken out, the mixture is called frit, or bollito.

It may be further observed, that glass might be made by immediately melting the materials without thus calcining, and making them frit: but the operation would be much more tedious.

A glass much harder than any prepared in the common way may be made by means of borax, in the following manner. Take four ounces of borax, and an ounce of fine white sand, reduced to powder, and melt them together in a large close crucible set in a wind furnace, keeping a strong fire for half an hour: then take out the crucible, and, when cold, break it; and there will be found at the bottom a hard, pure glass, capable of cutting common glass almost like a diamond. This experiment duly varied, says Dr Shaw, may lead

to some considerable improvements in the art of glass, enamels, and artificial gems. It shows us an expeditious method of making glass without the use of fixed salts, which has generally been thought an essential ingredient in glass, and which is the ingredient that gives common glass its softness; and it is not yet known, whether calcined crystal, or other substances being added to this salt, instead of sand, it might not make a glass approaching to the nature of a diamond.

*Kinds of GLASS.* Of these materials we have many sorts of glass made, which may principally be distinguished according to their beauty: as the crystal blue glass, the crystal white glass, the green glass, and the bottle glass. Again these several sorts are distinguished by their several uses: as plate or coach glasses, looking glasses, optic glasses, &c. which are made of the first sort. The second sort includes crown glass, toys, phials, drinking-glasses, &c. The third sort is well known by its colour, and the second by its form.

*Balas coloured GLASS* is made thus: Put into a pot crystal frit, thrice washed in water; tinge this with manganese prepared into a clear purple: to this add alumen cativum sifted fine in small quantities, and at several times; this will make the glass grow yellowish, and a little reddish, but not blackish, and always dissipates the manganese. The last time you add manganese, give no more of the alumen cativum, unless the colour be too full. Thus will the glass be exactly of the colour of the balas-ruby.

*Red GLASS.* A blood-red glass may be made in the following manner: Put six pounds of glass of lead, and ten pounds of common glass, into a pot glazed with white glass: when the whole is boiled and refined, add, by small quantities, and at small distances of time, copper calcined to a redness, as much as, on repeated proofs, is found sufficient: then add tartar in powder by small quantities at a time, till the glass is become as red as blood; and continue adding one or other of the ingredients till the colour is quite perfect.

*Yellow GLASS.* It is a necessary remark in glass-making, that the crystal glass made with salt that has an admixture of tartar will never receive the true gold yellow, though it will all other colours: for yellow glass, therefore, a salt must be prepared from polverine, or pot ashes alone, to make the glass.

*Furnaces for the making GLASS.* In this manufacture, there are three sorts of furnaces; one, called calcar, is for the frit; the second is for working the glass; the third serves to anneal the glass, and is called the leer. See FURNACE.

The calcar A (Plate XCVII. fig. 1.) resembles an oven ten feet long, seven broad, and two deep: the fuel, which in England is sea coal, is put into a trench on one side of the furnace; and the flame reverberating from the roof upon the frit, calcines it. The glass-furnace, or working furnace B, is round, of three yards diameter, and two high; or thus proportioned. It is divided into three parts, each of which is vaulted. The lower part C is properly called the crown,

and is made in that form. Its use is to keep a brisk fire of coal and wood, which is never put out. The mouth of it is called the bocca. There are several holes in the arch of this crown, through which the flame passes into the second vault, or partition, and reverberates into the pots filled with the ingredients above mentioned. Round the insides are eight or more pots placed, and piling pots on them. The number of pots is always double that of the boccas D, or mouths, or of the number of workmen, that each may have one pot refined to work out of, and another for metal to refine in while he works out of the other. Through the working holes the metal is taken out of the pots, and the pots are put into the furnace; and these holes are stopped with moveable covers made of lute and brick, to screen the workmens eyes from the scorching flames. On each side of the bocca, or mouth, is a bocarella, or little hole, out of which coloured glass, or finer metal, is taken from the piling pot. Above this oven, there is the third oven or leer, about five or six yards long, where the vessels, or glass, is annealed, or cooled: this part consists of a tower, besides the leer F, into which the flame ascends from the furnace. The tower has two mouths, through which the glasses are put in with a fork, and set on the floor or bottom: but they are drawn out on iron pans, called fraches, through the leer, to cool by degrees; so that they are quite cold by the time they reach the mouth of the leer, which enters the sarosel, or room where the glasses are to be stowed.

But the green glass furnace is square; and at each angle it has an arch for annealing, or cooling glasses. The metal is wrought on two opposite sides, and on the other two they have their colours, into which are made linnen holes, for the fire to come from the furnace to bake the frit, and to discharge the smoke. Fires are made in the arches to anneal the work, so that the whole process is done in one furnace.

These furnaces must not be of brick, but of hard sandy stones. In France, they build the outside of brick, and the inner part to bear the fire is made of a sort of fuller's earth, or tobacco-pipe clay, of which earth they also make their melting pots.

Mr Blancourt observes, that the worst and roughest work in this art, is the changing the pots, when they are worn out, or cracked. In this case the great working hole must be uncovered; the faulty pot must be taken out with iron hooks and forks, and a new one must be speedily put in its place, through the flames, by the hands only. For this work, the man guards himself with a garment made of skins, in the shape of a pantaloon, that covers him all but his eyes, and is made as wet as possible: the eyes are defended with a proper sort of glass.

*Instruments for making of GLASS.* The instruments made use of in this work, may be reduced to these that follow. A blowing pipe, made of iron, about two feet and a half long, with a wooden handle. An iron rod to take up the glass, after it is blown, and to cut off the former. Scissors to cut the glass when it comes out from the first hollow iron. Shears to cut and shape

great glasses, &c. an iron Ladle, with the end of the handle cased with wood, to take the metal out of the refining pot, to put it into the workmens pots. A small iron ladle, cased in the same manner, to skim the alkaline salt that swims at top. Shovels, one like a peel, to take up the great glasses; another, like a fire-shovel, to feed the furnace with coals. A hooked iron fork, to stir the matter in the pots. An iron rake for the same purpose, and to stir the frit. An iron fork, to change or pull the pots out of the furnace, &c.

*Working or blowing round GLASS.* The tools thus provided, the workman dips his blowing pipe into the melting-pot; and by turning it about, the metal sticks to the iron more firmly than turpentine. This he repeats four times, at each time rolling the end of his instrument, with the hot metal thereon, on a piece of iron G, over which is a vessel of water which helps to cool, and so to consolidate, and to dispose that matter to bind more firmly with what is to be taken next out of the melting pot. But after he has dipped a fourth time, and the workman perceives there is metal enough on the pipe, he claps his mouth immediately to the other end of it H, and blows gently through the iron tube, till the metal lengthens like a bladder about a foot. Then he rolls it on a marble stone I, a little while, to polish it, and blows a second time, by which he brings it to the shape of a globe of about eighteen or twenty inches diameter. Every time he blows into the pipe, he removes it quickly to his cheek, otherwise he would be in danger, by often blowing, of drawing the flame into his mouth; and this globe may be flattened by returning it to the fire, and brought into any form by stamp-irons, which are always ready. When the glass is thus blown, it is cut off at the collet, or neck, which is the narrow part that stuck to the iron. The method of performing this is as follows: the pipe is rested on an iron bar, close by the collet; then a drop of cold water being laid on the collet, it will crack about a quarter of an inch, which, with a slight blow, or cut of the shears K, will immediately separate the collet.

After this is done, the operator dips the iron rod into the melting-pot, by which he extracts as much metal as serves to attract the glass he has made, to which he now fixes this rod at the bottom of his work, opposite to the opening made by the breaking of the collet. In this position the glass is carried to the great bocca, or mouth of the oven, to be heated and scalded, by which means it is again put into such a soft state, that, by the help of an iron instrument, it can be pierced, opened, and widened without breaking. But the vessel is not finished till it is returned to the great bocca; where it being again heated thoroughly, and turned quickly about with a circular motion, it will open to any size, by the means of the heat and motion. And by this means we come to learn the cause why the edge of all bowls and glasses, &c. are thicker than the other parts of the same glasses; because in the turning it about in the heat, the edge thickens; and the glass being as it were doubled in that part, the circumference appears like a selvage.

If

If there remains any superfluities, they are cut off with the shears L; for till the glass is cool, it remains in a soft, flexible state. It is therefore taken from the bocca, and carried to an earthen bench, covered with brands, which are coals extinguished, keeping it turning; because that motion prevents any settling, and preserves an evenness in the face of the glass, where, as it cools, it comes to its consistency; being first cleared from the iron rod by a slight stroke by the hand of the workman.

If the vessel conceived in the workman's mind, and whose body is already made, require a foot, or a handle, or any other member or decoration, he makes them separate; and now assays to join them with the help of hot metal, which he takes out of the pots with his iron rod: but the glass is not brought to its true hardness, till it has passed the leer, or annealing oven, described before.

*Working, or blowing, of window or table GLASS.* The method of working round glass, or vessels of any sort, is in every particular applicable to the working of window or table-glass, till the blowing iron has been dipped the fourth time. But then, instead of rounding it, the workman blows, and so manages the metal upon the iron plate, that it extends two or three feet in the form of a cylinder. This cylinder is put again to the fire, and blown a second time, and is thus repeated till it is extended to the dimensions required, the side to which the pipe is fixed diminishing gradually till it ends in a pyramidal form; so that, to bring both ends nearly to the same diameter, while the glass is thus flexible, he adds a little hot metal to the end opposite the pipe, and draws it out with a pair of iron pinchers, and immediately cuts off the same end with the help of a little cold water, as before.

The cylinder being now open at one end, is carried back to the bocca, and there, by the help of cold water, it is cut about eight or ten inches from the iron pipe or rod; and the whole length at another place, by which also it is cut off from the iron rod. Then it is heated gradually on an earthen table, by which it opens in length, while the workman, with an iron tool, alternately lowers and raises the two halves of the cylinder, which at last will open like a sheet of paper, and fall into the same flat form in which it serves for use; in which it is preserved by heating it over again, cooling it on a table of copper, and hardening it twenty-four hours in the annealing furnace, to which it is carried upon forks. In this furnace an hundred tables of glass may lie at a time, without injury to each other, by separating them into tens, with an iron shiver between, which diminishes the weight by dividing it, and keeps the tables flat and even.

This was the method formerly made use of for blowing plate-glass, looking glasses, &c.; but the workmen, by this method, could never exceed fifty inches in length, and a proportional breadth, because what were larger were always found to warp, which prevented them from reflecting the objects regularly, and wanted substance to bear the necessary grinding. These imperfections have been remedied by an invention of

the Sieur Abraham Thevert, in France, about the year 1688, of casting or running large plates of glass in the following manner.

*Casting, or running of large looking GLASS plates.* The furnace G, fig. 2. is of a very large dimension, environed with several ovens, or annealing furnaces, called carquailles, besides others for making of frit, and calcining old pieces of glass. This furnace, before it is fit to run glass, costs 3500*l*. It seldom lasts above three years, and even in that time it must be refitted every six months. It takes six months to rebuild it; and three months to refit it. The melting-pots are as big as large hogheads, and contain about 2000 weight of metal. If one of them bursts in the furnace, the loss of the matter and time amounts to 250*l*. The heat of this furnace is so intense, that a bar of iron laid at the mouth thereof becomes red hot in less than half a minute. The materials in these pots are the same as described before; and A is the man breaking the frit for that purpose. When the furnace is red-hot, these materials are put in at three different times, because that helps the fusion; and in twenty-four hours they are vitrified, refined, settled, and fit for casting. H is the bocca, or mouth of the furnace; K is the cistern that conveys the liquid glass it receives out of the melting-pots in the furnace to the casting table. These cisterns are filled in the furnace, and remain therein six hours after they are filled; and then are hooked out by the means of a large iron chain, guided by a pulley marked I, and placed upon a carriage with four wheels marked L, by two men P P. This carriage has no middle piece; so that when it has brought the cistern to the casting-table M, they slip off the bottom of the cistern, and cut rushes a torrent of flaming matter O, upon the table: this matter is confined to certain dimensions by the iron rulers N, N, N, which are moveable, retain the fluid matter, and determine the width of the glass; while a man R, with the roller Q resting on the edge of the iron rulers, reduceth it as it cools to an equal thickness, which is done in the space of a minute. This table is supported on a wooden frame, with trusses for the convenience of moving to the annealing furnace; into which, strewed with sand, the new plate is shovelled, where it will harden in about ten days. After this, the glass needs only be ground, polished, and solated for use.

*Grinding and polishing of plate-GLASS.* Glass is made transparent by fire, but it receives its lustre by the skill and labour of the grinder and polisher, the former of whom takes it rough out of the hands of the maker.

In order to grind plate glass, they lay it horizontally upon a flat stone-table, (fig. 3.) made of a very fine-grained free stone; and for its greater security they plaster it down with lime, or flucco: for otherwise the force of the workmen, or the motion of the wheel with which they grind it, would move it about.

This stone-table is supported by a strong frame A, made of wood, with a ledge quite round its edges, rising about two inches higher than the glass. Upon this glass to be ground, is laid another rough glass not above half so big, and so loose as to slide upon it; but

continued

cemented to a wooden plank, to guard it from the injury it must otherwise receive from the scraping of the wheel, to which this plank is fastened; and from the weights laid upon it, to promote the grinding, or friture, of the glasses. The whole is covered with a wheel, B, made of hard light wood, about six inches in diameter; by pulling of which backwards and forwards alternately, and sometimes turning it round, the workmen who always stand opposite to each other, produce a constant attrition between the two glasses, and bring them to what degree of smoothness they please, by first pouring in water and coarse sand; after that, a finer sort of sand, as the word advanceth, till at last they must pour in the powder of smalt. As the upper or incumbent glass polishes, and grows smoother, it must be taken away, and another from time to time put in its place.

This engine is called a mill by the artists, and is used only in the largest size glasses; for in the grinding of the lesser glasses, they are content to work without a wheel, and to have only four wooden handles fastened to the four corners of the stone which loads the upper plank, by which they work it about.

When the grinder has done his part, who finds it very difficult to bring the glass to an exact plainness, it is turned over to the care of the polisher, who with the fine powder of tripoli-stone, or emery, brings it to a perfect evenness and lustre. The instrument made use of in this branch, is a board, *c, c*, furnished with a felt, and a small roller, which the workman moves by means of a double handle at both ends. The artist in working this roller, is assisted with a wooden hoop or spring, to the end of which it is fixed: for the spring, by constantly bringing the roller back to the same points, facilitates the action of the workman's arm.

**Painting in Glass.** The ancient manner of painting in glass was very simple; it consisted in the mere arrangement of pieces of glass of different colours in some sort of symmetry, and constituted what is now called Mosaic. See MOSAIC.

In process of time they came to attempt more regular designs, and also to represent figures heightened with all their shades: yet they proceeded no farther than the contours of the figures in black with water-colours, and hatching the draperies after the same manner on glasses of the colour of the object they designed to paint. For the carnation, they used glass of a bright red colour; and upon this they drew the principal lineaments of the face, &c. with black.

But in time, the taste for this sort of painting improving considerably, and the art being found applicable to the adorning of churches, basilics, &c. they found out means of incorporating the colours in the glass itself, by heating them in the fire to a proper degree; having first laid on the colours. The colours used in painting or staining of glass are very different from those used in painting either in water or oil colours.

For black, Take scales of iron, one ounce; scales of copper, one ounce; jet, half an ounce; reduce them to powder, and mix them. For blue, Take powder of blue, one pound; sal nitre, half a pound; mix

them and grind them well together, For carnation, Take red chalk, eight ounces; iron scales and litharge of silver, of each two ounces; gum arabic, half an ounce; dissolve in water; grind altogether for half an hour as stiff as you can; then put it in a glass and stir it well, and let it stand to settle fourteen days. For green, Take red lead, one pound; scales of copper, one pound; and flint, five pounds; divide them into three parts; and add to them as much sal nitre; put them into a crucible, and melt them with a strong fire; and when it is cold, powder it, and grind it on a porphyry. For gold colour, Take silver an ounce; antimony, half an ounce; melt them in a crucible; then pound the mass to powder; and grind it on a copper plate; add to it yellow oker, or brick-dust calcined again, fifteen ounces; and grind them well together with water. For purple, Take minium, one pound; brown stone, one pound; white flint, five pounds; divide them into three parts, and add to them as much sal nitre as one of the parts; calcine, melt, and grind it as you did the green. For red, Take jet, four ounces; litharge of silver, two ounces; red chalk, one ounce; powder them fine, and mix them. For white, Take jet, two parts; white flint, ground on a glass very fine, one part; mix them. For yellow, take Spanish brown, ten parts; leaf silver, one part; antimony, half a part; put all into a crucible, and calcine them well.

In the windows of ancient churches, &c. there are to be seen the most beautiful and vivid colours imaginable, which far exceed any of those used by the moderns, not so much because the secret of making those colours is entirely lost, as that the moderns will not go to the charge of them, nor be at the necessary pains, by reason that this sort of painting is not now so much in esteem as formerly. Those beautiful works which were made in the glass-houses were of two kinds.

In some, the colour was diffused through the whole substance of the glass. In others, which were the more common, the colour was only on one side, scarce penetrating within the substance above one third of a line; though this was more or less according to the nature of the colour; the yellow being always found to enter the deepest. These last, though not so strong and beautiful as the former, were of more advantage to the workmen, by reason that on the same glass, though already coloured, they could shew other kind of colours where there was occasion to embroider draperies, enrich them with foliage, or represent other ornaments of gold, silver, &c.

In order to this, they made use of emery, grinding or wearing down the surface of the glass, till such time as they were got through the colour to the clear glass. This done, they applied the proper colours on the other side of the glass. By these means, the new colours were hindered from running and mixing with the former, when they exposed the glasses to the fire, as will appear hereafter.

When indeed the ornaments were to appear white, the glass was only bared of its colour with emery, without tinging the place with any colour at all; and this

this was the manner by which they wrought their lights, and heightnings, on all kinds of colour.

The first thing to be done, in order to paint or stain glass, in the modern way, is to design, and even colour the whole subject on paper. Then they chuse such pieces of glass as are clear, even, and smooth, and proper to receive the several parts, and proceed to distribute the design itself, or papers it is drawn on, into pieces suitable to those of the glass; always taking care that the glasses may join in the contours of the figures, and the folds of the draperies; that the carnations, and other finer parts, may not be impaired by the lead with which the pieces are to be joined together. The distribution being made, they mark all the glasses as well as papers, that they may be known again: which done, applying every part of the design upon the glass intended for it, they copy, or transfer, the design upon this glass with the black colour diluted in gum water, by tracing and following all the lines and strokes as they appear through the glass with the point of a pencil.

When these strokes are well dried, which will happen in about two days, the work being only in black and white, they give a slight wash over with urine, gum arabic, and a little black; and repeat it several times, according as the shades are desired to be heightened, with this precaution, never to apply a new wash till the former is sufficiently dried.

This done, the lights and risings are given by rubbing off the colour in the respective places with a wooden point, or the handle of the pencil.

As to the other colours above-mentioned, they are used with gum water, much as in painting in miniature; taking care to apply them lightly, for fear of effacing, the out-lines of the design; or even, for the greater security, to apply them on the other side; especially yellow, which is very pernicious to the other colours, by blending therewith. And here too, as in pieces of black and white, particular regard must always be had not to lay colour on colour, or lay on a new lay, till such time as the former are well dried.

It may be added, that the yellow is the only colour that penetrates through the glass, and incorporates therewith by the fire; the rest, and particularly the blue, which is very difficult to use, remaining on the surface, or at least entering very little. When the painting of all the pieces is finished, they are carried to the furnace, or oven, to anneal, or bake the colours.

The furnace here used is small, built of brick, from eighteen to thirty inches square. At six inches from the bottom is an aperture to put in the fuel, and maintain the fire. Over this aperture is a grate, made of three square bars of iron, which traverse the furnace, and divide it into two parts. Two inches above this partition, is another little aperture, through which they take out pieces to examine how the coction goes forward. On the grate is placed a square earthen pan, six or seven inches deep; and five or six inches less every way than the perimeter of the fur-

nace. On the one side hereof is a little aperture, through which to make trials, placed directly opposite that of the furnaces destined for the same end. In this pan are the pieces of glass to be placed, in the following manner. First, the bottom of the pan is covered with three strata, or layers, of quick lime pulverised; those strata being separated by two others of old broken glass, the design whereof is to secure the painted glass from the too intense heat of the fire. This done, the glasses are laid horizontally on the last or uppermost layer of lime.

The first row of glass they cover over with a layer of the same powder, an inch deep; and over this they lay another range of glasses, and thus alternately till the pan is quite full; taking care that the whole heap always end with a layer of the lime-powder.

The pan being thus prepared, they cover up the furnace with tiles, on a square table of earthen ware, closely luted all round; only leaving five little apertures, one at each corner, and another in the middle, to serve as chimneys. Things thus disposed, there remains nothing but to give the fire to the work. The fire for the first two hours must be very moderate, and must be increased in proportion as the coction advances, for the space of ten or twelve hours; in which time it is usually completed. At last the fire, which at first was charcoal, is to be of dry wood, so that the flame covers the whole pan, and even issues out at the chimneys.

During the last hours, they make essays, from time to time, by taking out pieces laid for the purpose through the little aperture of the furnace, and pan, to see whether the yellow be perfect, and the other colours in good order. When the annealing is thought sufficient, they proceed with great haste to extinguish the fire, which otherwise would soon burn the colours, and break the glasses.

*Glass of lead.* See CHEMISTRY, p. 136.

*Glass porcelain,* the name given by many to a modern invention of imitating the china-ware with glass.

The method of making it, as given by Mr Reamur, who was the first that carried the attempt to any degree of perfection, is as follows.

The glass vessels to be converted into porcelain, are to be put into large vessels, such as the common fine earthen dishes are baked in; or into sufficiently large crucibles: the vessels are to be filled with a mixture of fine white sand, and of fine gypsum; or plaster stone, burnt into what is called plaster of Paris; and all the interstices are to be filled up with the same powder, so that the glass vessels may no where touch either one another, or the sides of the vessels they are baked in.

The vessel is to be then covered down, and luted, and the fire does the rest of the work: for this is only to be put into a common potter's furnace, and when it has stood there the usual time of baking the other vessels, it is to be taken out, and the whole contents will be found no longer glass, but converted into a white opake substance, which is a very elegant porcelain, and has almost the properties of that of china.

**GLASS** of *antimony*. See **CHEMISTRY**, p. 87.

**GLASTONBURY**, a market town of Somersetshire, five miles south of Wells.

**GLATZ**, the capital of a county of the same name in Bohemia, 100 miles east of Prague: E. long. 16° 8', N. lat. 50° 25'.

**GLAUBER'S SALT**. See **CHEMISTRY**, p. 127.

**GLAUCION**, in ornithology. See **ANAS**.

**GLAUCIUM**, in botany. See **CHELIDONIUM**.

**GLAUCOMA**, in medicine, the change of the crystalline humour of the eye into an azure-colour. See **MEDICINE**.

**GLAUCUS**, in ichthyology. See **SQUALUS**.

**GLAUX**, in botany, a genus of the pentandria monogynia class. The calix consists of one leaf; it has no corolla; the capsule has one cell, 5 valves, and 5 seeds. There is but one species, *viz.* the maritima, sea-milkwort, or glass-wort, a native of Britain.

**GLAZIER**, an artificer who works in glass. See **GLASS**.

The principal part of a glazier's business consists in fitting panes and plates of glass to the sashes and window-frames of houses, pictures, &c. and in cleaning the same.

**GLAZING**, the polishing or crusting over earthen ware, by running melted lead or litharge over it.

The common ware is glazed with a composition of 50 lb. clean sand, 70 lb. lead ashes, 30 lb. wood ashes, and 12 lb. salt, all melted into a cake. With this mixture they glaze it over, and then set it in an earthen glazing pan; taking care that the vessels do not touch one another. As several colours are used for this purpose, we shall give the following receipts, from Smith's laboratory. 1. For a black, take lead-ashes, 18 parts; iron-slings, 3; copper-ashes, 3; and zaffer, 2: this, when melted, will make a brown black; and if you would have it blacker, put some more zaffer to it. 2. For blue, take lead-ashes, 1 lb. clear sand or pebble, 2 lb. salt, 2 lb. white calcined tartar, 1 lb. Venice or other glass, 16 lb. and zaffer, half a pound: mix them well together; and after melting, quench them in water, and then melt them again; which operation is to be repeated several times; and if you would have it fine and good, it will be proper to put the mixture into a glass furnace for a day or two. 3. A brown glazing may be given with a mixture of lead-glass, 12 parts, and common glass and manganese, of each one part. 4. A citron-yellow may be made of 6 parts of red-lead, 7 parts of fine red brick-dust, and 2 parts of antimony, all melted together. 5. A flesh-colour, with 12 parts of lead-ashes, and one of white glass. 6. For a green-colour, take 8 parts of litharge, 8 parts of Venice-glass, 4 parts of brass-dust, and melt them together for use; or melt together two parts yellow glass, with as much copper-dust. 7. For a gold-yellow, take of antimony, red lead, and sand, an equal quantity, and melt them into a cake. 8. For a fine purple brown, take lead-ashes, 15 parts; clear sand, 18; manganese, 1; white glass, 15 measures; and 1 of zaffer. 9. For a fine red, take antimony, 2 lb. litharge, 3 lb. rust of iron calcined, 1 lb. and grind them to a fine powder. 10. For a fine white

glazing, take 2 lb. of lead, 1 lb. of tin, and calcine them to ashes; of which take 2 parts; of calcined flint or pebble, 1 part; of salt, 1 part; and mixing them well together, melt them into a cake. At Rotterdam, they make a fine shining white glazing, by melting together 2 lb. clean tin-ashes, 10 lb. lead ashes, 2 lb. fine Venice-glass, and  $\frac{1}{2}$  lb. tartar. 11. A yellow glazing is made of 4 ounces of red lead, and 2 ounces of antimony, melted together. 12. For a fine yellow, take red lead, 3 pints; antimony and tin, of each 2 lb. then melting them into a cake, grind it fine; and repeating this several times, you will have a good yellow.

**GLEBE**, among miners, signifies a piece of earth, wherein is contained some mineral ore.

**GLEBE**, in law, the land belonging to a parish-church, besides the tithes.

**GLECHOMA**, in botany, a genus belonging to the didynamia gymnospermia class. The calix consists of five segments; and each pair of antheræ are disposed in the form of a cross. There are three species, two of which are natives of Britain, *viz.* the hederacea, or ground-ivy; and the arvensis, or upright ground-ivy. The leaves of the hederacea are corroborant, aperient, and detergent.

**GLEDITZIA**, in botany, a genus of the polygamia dioecia class. The calix of the hermaphrodite has four segments; the corolla four petals; there are six stamina, and one pistillum. The calix of the male consists of three leaves, and the corolla of three petals; and it has six stamina. The calix of the female consists of five leaves, and the corolla of five petals; it has but one pistillum; and the capsule is a legumen. There are two species, none of them natives of Britain.

**GLEET**, in medicine, the flux of a thin limpid humour from the urethra. See **MEDICINE**.

**GLIRES**, the name of Linnæus's fourth order of mammalia. See **NATURAL HISTORY**.

**GLENOIDES**, the name of two cavities, or small depressions, in the inferior part of the first vertebra of the neck.

**GLIS**, in zoology. See **SCIURUS**.

**GLISCHROMICTHES**, in natural history, the name by which Dr Hill calls the tougher and more viscid loams.

**GLISTER**, in surgery. **CLYSTER**.

**GLOBE**, in practical mathematics, an artificial spherical body, on the convex surface of which are represented the countries, seas, &c. of our earth; or the face of the heavens, the circles of the sphere, &c. See **GEOGRAPHY**.

**GLOBULARIA**, in botany, a genus of the tetrandria monogynia class. The common calix is imbricated; and the proper calix is tubular and below the fruit; the upper labium of the corollulæ is divided into two parts, and the under one into three; and the receptacle is paleaceous. There are seven species, none of them natives of Britain.

**GLOBULE**, a diminutive of globe, frequently used by physicians in speaking of the red spherical particles of the blood.

**GLOCESTER**,



**GLOCESTER**, the capital of Gloucester-shire, ninety miles west of London: W. long.  $2^{\circ} 16'$ , and N. lat.  $51^{\circ} 50'$ .

It is a bishop's see, and sends two members to parliament.

**GLOGAW**, a city of Silesia, situated on the river Oder; forty five miles north west of Breslaw: E. long  $16^{\circ} 8'$ , and N. lat  $51^{\circ} 40'$ .

*See* **GLOGAW**, a town of Silesia, fifty miles south of Breslaw.

**GLORIOSA**, **SUPERB LILY**, in botany, a genus of the hexandria monogynia class. The corolla consists of six undulated and reflected petals; and the stylus is oblique. There is but one species, a native of Malabar.

**GLOSSARY**, a sort of dictionary, explaining the obscure and antiquated terms in some old author.

**GLOSSOPETRA**, in natural history, a genus of extraneous fossils, so called from their having been supposed the tongues of serpents turned into stone, though they are really the teeth of sharks, and are daily found in the mouths of those fishes, where ever taken.

**GLOTTIS**, in anatomy. See **ANATOMY**, p. 300.

**GLOW WORM** See **CICINDELA**.

**GLUCKSTAT**, a fortified town of Germany, situated on the east side of the river Elbe, thirty miles north-west of Hamburgh: E. long.  $9^{\circ}$ , and N. lat.  $54^{\circ} 20'$ .

**GLUE**, among artificers, a tenacious viscid matter, which serves as a cement to bind or connect things together.

Glues are of different kinds, according to the various uses they are designed for, as the common glue, glove-glue, and parchent glue; whereof the two last are more properly called size.

The common or strong glue is chiefly used by carpenters, joiners, cabinet makers, &c. and the best kind is that made in England, in square pieces of a ruddy brown colour; and, next to this, the Flanders glue. It is made of the skins of animals, as oxen, cows, calves, sheep, &c. and the older the creature is, the better is the glue made of its hide. Indeed, whole skins are but rarely used for this purpose, but only the shavings, parings, or scraps of them; or the feet-sinews, &c. That made of whole skins, however, is undoubtedly the best; as that made of sinews is the very worst.

*The method of making GLUE.* In making glue of parings, they first steep them two or three days in water; then washing them well out, they boil them to the consistence of a thick jelly; which they pass, while hot, through ozier-baskets, to separate the impurities from it, and then let it stand some time, to purify it further: when all the filth and ordures are settled to the bottom of the vessel, they melt and boil it a second time. They next pour it into flat frames or moulds, whence it is taken out pretty hard and solid, and cut into square pieces or cakes. They afterwards dry it in the wind, in a sort of coarse net; and at last string it, to finish its drying.

The glue made of sinews, feet, &c. is managed after the same manner; only with this difference, that they bone and scour the feet, and do not lay them to steep.

The best glue is that which is oldest; and the surest way to try its goodness, is to lay a piece to steep three or four days, and if it swell considerably without melting, and when taken out resumes its former driness, it is excellent.

A glue that will hold against fire or water, may be made thus: mix a handful of quicklime with four ounces of linseed oil; boil them to a good thickness, then spread it on tin-plates in the shade, and it will become exceeding hard, but may be easily dissolved over a fire, as glue, and will effect the business to admiration.

*Method of preparing and using GLUE.* Set a quart of water on the fire, then put in about half a pound of good glue, and boil them gently together till the glue be entirely dissolved and of a due consistence. When glue is to be used, it must be made thoroughly hot; after which, with a brush dipped in it, besmear the faces of the joints as quick as possible; then clapping them together, slide or rub them lengthwise one upon another, two or three times, to settle them close; and so let them stand till they are dry and firm.

**GLUME**, among botanists. See **BOTANY**, p. 637.

**GLUTÆUS**, in anatomy. See **ANATOMY**, p. 204.

**GLYCINE**, in botany, a genus of the diadelphia decandria class. The calix is bilabiated: and the pod consists of two cells. There are nine species, none of them natives of Britain.

**GLYCYRRHIZA**, **LIQUORICE**, in botany, a genus of the diadelphia decandria class. The calix is bilabiated; and the pod is oval and compressed. There are three species, none of them natives of Britain.

The common liquorice is cultivated in most countries of Europe for the sake of its root. That which is cultivated in Britain is preferable to such as comes from abroad; this last being generally mouldy, which this root is very apt to become, unless kept in a dry place. The powder of liquorice usually sold is often mingled with flour, and probably too often with substances not quite so wholesome: the best sort is of a brownish yellow colour (the fine pale yellow being generally sophisticated) and of a very rich sweet taste, much more agreeable than that of the fresh root. Liquorice is almost the only sweet that quenches thirst; whence it was called by the Greeks *asipson*. Galen takes notice, that it was employed in this intention in hydroptic cases, to prevent the necessity of drinking. Mr Fuller, in his *Medicina gymnastica*, recommends this root as a very useful pectoral, and says it excellently softens acrimonious humours, at the same time that it proves gently detergent: and this account is warranted by experience.

**GLYPH**, in sculpture and architecture, denotes any canal or cavity used as an ornament.

**GRELINA**, in botany, a genus of the didynamia angiospermia class. The calix has four teeth; the corolla is bell-shaped, and divided into four segments; the antheræ are divided into two parts; and the fruit is a bicellular drupa. There is but one species, a native of the Indies.

**GRAPHILLUM**, **CUBBERED**, in botany, a genus of the Syngentia

*Syngenesia polygamia superflua* class. The receptacle is naked; the pappus is plumose; and the calix is imbricated. There are 41 species, five of them natives of Britain, *viz.* the dioicum, mountain cudweed, or cat's foot; the margaritaceum, or American cudweed; the luteo-album, or Jersey cudweed; the sylvaticum, or upright cudweed; and the uliginosum, or black-headed cudweed.

**GNAT**, in zoology. See **MUSCA**.

**GNESNA**, the capital city of great Poland, situated one hundred and ten miles west of Warsaw: E. long. 18°, and N. lat. 53°.

It is the see of an archbishop, who is always primate of Poland. See **POLAND**.

**GNIDIA**, in botany, a genus of the octandria monogynia class. The calix is funnel shaped, and consists of four segments; the petals are four, and inserted into the calix; and the berry contains but one seed. There are three species, none of them natives of Britain.

**GNOMON**, in dialling, the style, pin, or cock of a dial; which, by its shadow, shews the hour of the day. See **DIALLING**.

**GNOMON**, in astronomy, a style erected perpendicular to the horizon, in order to find the altitude of the sun.

**GNOMON** of a globe, the index of the hour-circle. See **GEOGRAPHY**.

**GNOMONICS**, the art of dialling. See **DIALLING**.

**GNOSTICS**, in church-history, Christian heretics so called, it being a name which almost all the ancient heretics affected to take, to express that new knowledge and extraordinary light to which they made pretensions; the word gnostic signifying a learned or enlightened person.

**GOA**, a city and sea-port of the hither India, situated in an island of the river Mandoua, and subject to the Portuguese: E. lon. 73° 20', and N. lat. 15° 20'.

**GOAT**, in zoology. See **CAPRA**.

**GOAT'S BEARD**, in botany. See **TRAGOPOGON**.

**GOAT'S RUE**, in botany. See **GALEGA**.

**GOAT-SUCKER**, in ornithology. See **CAPRIMULGUS**.

**GOBIUS**, in ichthyology, a genus of fishes belonging to the order of thoracici. They have two holes between the eyes, four rays in the membrane of the gills; and the belly-fins are united in an oval form. There are eight species, principally distinguished by the number of rays in their fins.

**GOD**, one of the many names of the Supreme Being. See **RELIGION**.

**GODDESS**, a heathen deity of the female sex.

The ancients had almost as many goddesses as gods; such were Juno, the goddess of air; Diana, the goddess of woods, &c. And under this character were represented the virtues, graces, and principal advantages of life; Truth, Justice, Piety, Liberty, Fortune, Victory, &c.

It was the peculiar privilege of the goddesses to be represented naked on medals; for it was supposed that the imagination must be awed and restrained by the consideration of the divine character.

**GOLCONDA**, the capital of a province of the same

name in the hither India: E. long. 77°, and N. lat. 16°.

**GOLD**. See **CHEMISTRY**, p. 78, and 129.

**GOLD-WIRE**, a cylindrical ingot of silver, superficially gilt, or covered with gold at the fire, and afterwards drawn successively through a great number of little, round holes, of a wire-drawing iron, each less than the other, till it be sometimes no bigger than a hair of the head.

It may be observed, that before the wire be reduced to this excessive fineness, it is drawn through above an hundred and forty different holes; and that each time they draw it, it is rubbed afresh over with new wax, both to facilitate its passage, and to prevent the silver's appearing through it.

**GOLD-WIRE flatted**, is the former wire flatted between two rollers of polished steel, to fit it to be spun on a stick, or to be used flat, as it is, without spinning, in certain stuffs, laces, embroideries, &c. See **STUFF**, &c.

**GOLD-THREAD**, or **SPUN-GOLD**, is a flatted gold, wrapped or laid over a thread of silk, by twisting it with a wheel and iron bobbins.

*Manner of forming GOLD-WIRE, and GOLD-THREAD, both round and flat.* First, an ingot of silver, of twenty-four pounds, is forged into a cylinder, of about an inch in diameter: then it is drawn through eight or ten holes, of a large, coarse, wire-drawing iron, both to finish the roundness, and to reduce it to about three fourths of its former diameter. This done, they file it very carefully all over, to take off any filth remaining on the forge; then they cut it in the middle; and thus make two equal ingots thereof, each about twenty six inches long, which they draw through several new holes, to take off any inequalities the file may have left, and to render it as smooth and equable as possible.

The ingot thus far prepared, they heat it in a charcoal fire; then taking some gold leaves, each about four inches square, and weighing twelve grains, they join four, eight, twelve, or sixteen of these, as the wire is intended to be more or less gilt; and when they are so joined, as only to form a single leaf, they rub the ingots reeking hot with a burnisher. These leaves being thus prepared, they apply over the whole surface of the ingot, to the number of six, over each other, burnishing or rubbing them well down with the blood-stone, to close and smoothe them. When gilt, the ingots are laid anew in a coal fire; and when raised to a certain degree of heat, they go over them a second time with the blood-stone, both to folder the gold more perfectly, and to finish the polishing. The gilding finished, it remains to draw the ingot into wire.

In order to this, they pass it through twenty holes of a moderate drawing iron, by which it is brought to the thickness of the tag of a lace: from this time the ingot loses its name, and commences gold-wire. Twenty holes more of a lesser iron leaves it small enough for the least iron; the finest holes, of which last scarce exceeding the hair of the head, finish the work.

To dispose the wire to be spun on silk, they pass it between

between two rollers of a little mill: these rollers are of nicely polished steel, and about three inches in diameter. They are set very close to each other, and turned by means of a handle fastened to one of them, which gives motion to the other. The gold wire in passing between the two, is rendered quite flat, but without losing any thing of its gilding, and is rendered so exceedingly thin and flexible, that it is easily spun on silk thread, by means of a hand wheel, and so wound on a spool or bobin.

**GOLD-LEAF, or BEATEN GOLD,** is gold beaten with a hammer into exceeding thin leaves, so that it is computed, that an ounce may be beaten into sixteen hundred leaves, each three inches square, in which state it takes up more than 159052 times its former surface.

This gold they beat on a block of black marble, about a foot square, and usually raised three feet high: they make use of three sorts of hammers, formed like mallets, of polished iron: the first, which weighs three or four pounds, serves to chase, or drive; the second, of eleven or twelve pounds, to close; and the third, which weighs fourteen or fifteen pounds, to stretch and finish. They also make use of four moulds of different sizes, *viz.* two of vellum, the smallest whereof consists of forty or fifty leaves, and the larger of two hundred; the other two, consisting each of five hundred leaves, are made of bullocks guts well scoured, and prepared. See **MOULD**.

*Method of preparing and beating GOLD.* They first melt a quantity of pure gold, and form it into an ingot: this they reduce, by forging, into a plate about the thickness of a sheet of paper; which done, they cut the plate into little pieces about an inch square, and lay them in the first or smallest mould to begin to stretch them: after they have been hammered here a while with the smallest hammer, they cut each of them into four, and put them into the second mould, to be extended further.

Upon taking them hence, they cut them again into four, and put them into the third mould; out of which they are taken, divided into four, as before, and laid in the last, or finishing mould, where they are beaten to the degree of thinness required.

The leaves thus finished, they take them out of the mould, and dispose them into little paper-books, prepared with a little red bole, for the gold to stick to; each book ordinarily contains twenty-five gold leaves. There are two sizes of these books; twenty-five leaves of the smallest only weigh five or six grains, and the same number of the largest nine or ten grains.

It must be observed, that gold is beaten more or less, according to the kind or quality of the work it is intended for; that for the gold-wire drawers to gild their ingots withal, is left much thicker than that for gilding the frames of pictures, &c. withal. See **GILDING**.

**GOLD-FINCH,** in ornithology. See **FRINGILLA**.

**GOLDSMITH,** or, as some chuse to express it, *silver-smith*, an artist who makes vessels, utensils, and ornaments, in gold and silver.

The goldsmith's work is either performed in the

mould, or beat out with the hammer or other engine: All works that have raised figures, are cast in a mould, and afterwards polished and finished: plates, or dishes, of silver or gold, are beat out from thin flat plates; and tankards, and other vessels of that kind, are formed of plates soldered together, and their mouldings are beat, not cast. The business of the goldsmiths formerly required much more labour than it does at present; for they were obliged to hammer the metal from the ingot to the thinness they wanted: but there are now invented flattening-mills, which reduce metals to the thinness that is required, at a very small expence. The goldsmith is to make his own moulds, and for that reason ought to be a good designer, and have a taste in sculpture: he also ought to know enough of metallurgy, to be able to assay mixed metals, and to mix the alloy.

**GOLDEN,** something that has a relation to gold, or consists of gold.

**GOLDEN number.** See **ASTRONOMY**, p. 492.

**GOLDEN rule.** See **ARITHMETICK**, p. 381.

**GOLDINGEN,** a city of Poland, in the duchy of Courland, sixty miles west of Mittau: E. long. 22°, N. lat. 57°.

**GOMBRON,** the greatest sea-port town in Persia, situated on the strait at the entrance of the gulph of Persia, opposite to the island of Ormus: E. long. 55° 30', N. lat. 27° 30'.

**GOMERA,** one of the Canary islands, subject to Spain, and situated west of Teneriff: W. long. 18°, N. lat. 28°.

**GOMORRO islands,** situated between 10° and 13° S. lat. on the eastern coast of Africa.

**GOMPHOSIS,** in anatomy. See **ANATOMY**, p. 148.

**GOMPHRENA,** the *purple everlasting flower*, in botany, a genus of the pentandria digynia class. The calix consists of three coloured leaves; and the nectarium is cylindrical, with ten teeth; and the capsule contains one seed. There are seven species, none of them natives of Britain.

**GONDOLA,** in naval architecture, a flat kind of boat, very long and narrow, chiefly used on the canals at Venice.

**GONORRHOEA,** in medicine, an involuntary efflux of the seminal juices, and some other recrementitious matter. See **MEDICINE**.

**GOOD,** in general, whatever is apt to cause or increase pleasure, or diminish pain in us; or, which amounts to the same, whatever is able to procure or preserve to us the possession of agreeable sensations, and remove those of an opposite nature.

*Moral Good,* denotes the right conduct of the several senses and passions, or their just proportion and accommodation to their respective objects and relations. See **MORALS**.

**GOOD-HOPE,** or *Cape of GOOD-HOPE*, the most southern promontory of Africa, where the Dutch have built a good town and fort: E. long. 16° and N. lat. 34° 15'.

**GOOSE,** in ornithology. See **ANAS**.

**GOOSEBERRY,** in botany. See **PIBES**

† 7 U

**GOOSE-NECK;**

**GOOSE-NECK**, in a ship, a piece of iron fixed on the one end of the tiller, to which the laniard of the whip-staff or the wheel-rope comes, for steering the ship.

**GOOSE-WING**, in the sea-language. When a ship fails before, or with a quarter wind on a fresh gale, to make the more haste, they launch out a boom, and fail on the lee side; and a sail so fitted, is called a goose-wing.

**GOR**, the capital of a province of the same name, in the East-Indies, subject to the Mogul: E. long. 85°, N. lat. 31° 15'.

**GORCUM**, a city of the United Provinces, situated in that of Holland, on the river Waal, twenty two miles east of Rotterdam: E. long. 4° 50', N. lat. 51° 50'.

**GORDIAN**  $\kappa\nu\omicron\tau$ , in antiquity, a knot made in the leathers or harness of the chariot of Gordius, king of Phrygia, so very intricate, that there was no finding where it began or ended.

The inhabitants had a tradition, that the oracle had declared, that he who untied this knot, should be master of Asia. Alexander having undertaken it, was unable to accomplish it; when fearing lest his not untying it should be deemed an ill augury, and prove a check in the way of his conquests, he cut it asunder with his sword, and thus either accomplished or eluded the oracle.

**GORE**, in heraldry, one of the abatements, which, according to Guillim, denotes a coward. It is a figure consisting of two arch lines drawn one from the sinister chief, and the other from the sinister base, both meeting in an acute angle in the middle of the fess point. See Plate XCVII. fig. 4.

**GORGE**, in architecture, the narrowest part of the Tuscan and Doric capitals, lying between the astragal, above the shaft of the pillar, and the annulets.

**GORGE**, in fortification, the entrance of the platform of any work. See FORTIFICATION.

**GORGED**, in heraldry, the bearing of a crown, coronet, or the like, about the neck of a lion, a swan, &c. and in that case it is said, the lion or cygnet is gorged with a ducal coronet, &c.

Gorged is also used when the gorge or neck of a peacock, swan, or the like bird, is of a different colour or metal from the rest.

**GORGONA**, the name of two islands; one in the Pacific Ocean on the coast of Peru, W. long. 79°, N. lat. 3°; the other in the Mediterranean, twenty-five miles west of Leghorn.

**GORGONS**, in antiquity, a warlike female nation of Lybia, in Africa, who had frequent quarrels with another nation of the same sex, called Amazons.

**GORLITZ**, a city of Upper Saxony, in Germany, fifty miles east of Dresden: E. long. 15° 6', N. lat. 51° 12'.

**GOSHAWK**. See FALCO.

**GOSLAR**, an imperial city of Lower Saxony, in Germany, thirty miles south of Brunswick: E. long. 10° 30', N. lat. 52°.

**GOSPEL**, the history of the life, actions, death, resurrection, ascension and doctrine of Jesus Christ.

The word is Saxon, and of the same import with the

Latin term *evangelium*, which signifies glad tidings, or good news.

This history is contained in the writings of St Matthew, St Mark, St Luke, and St John; who from thence are called evangelists. The Christian church never acknowledged any more than these four gospels as canonical; notwithstanding which, several apocryphal gospels are handed down to us, and others are entirely lost.

**GOSSYPIMUM**, in botany, a genus of the monodelphia polyandria class. The calix is double, the exterior one consisting of three leaves; the capsule has four cells; and the seeds are covered with down. There are four species, none of them natives of Britain.

**GOTHA** the capital of the duchy of Saxe Gotha, in Upper Saxony; E. long. 10° 36', N. lat. 51°.

It is subject to the duke of Saxe Gotha, brother of her royal highness the princess dowager of Wales.

**GOTHIC**, in general, whatever has any relation to the Goths: thus, we say, Gothic customs, Gothic architecture, &c.

**GOTHLAND**, the most southern province of Sweden, being a peninsula surrounded on three sides by the Baltic Sea. It is subdivided into East and West Gothland, Smaland, Halland, Bleken, and Schonen.

**GOTHLAND**, is also an island of the Baltic, situated without the province of Gothland and Livonia.

**GOTTENBURG**, a port-town of Sweden, situated between the Sound, on the coast of the Schaggerack Sea, near the entrance of the Baltic.

**GOTTINGEN**, a city of Germany, in the circle of Lower Saxony and dukedom of Brunswick: E. long. 9° 45', N. Lat. 51° 32'.

**GOTTORP**, a city of the dukedom of Sleswic, in Denmark, and capital of the territories of the duke of Holstein Gottorp: E. long. 10°, N. lat. 54° 40'.

**GOUDE**, a city of the United Netherlands, in the province of Holland, ten miles north-east of Rotterdam.

**GOVERNMENT**, in general, is the polity of a state, or an orderly power constituted for the public good.

Civil government was instituted for the preservation and advancement of mens civil interests, and for the better security of their lives, liberties, and properties. The use and necessity of government is such, that there never was an age or country without some sort of civil authority: but as men are seldom unanimous in the means of attaining their ends, so their difference in opinion in relation to government, has produced a variety of forms of it. To enumerate them, would be to recapitulate the history of the whole earth. But they may, in general, be reduced to one of these heads: either the civil authority is delegated to one or more, or else it is still reserved to the whole body of the people; whence arises the known distinction of government into monarchy, aristocracy, and democracy.

Mr Hooker thinks, that the first government was arbitrary, and administered by a single person; till it was found by experience, that to live by one man's will, was the cause of all mens misery: and this, he concludes, was the original of inventing laws. The Roman and most of the Grecian states were built up-

on

on the republican plan; but when the Goths, and other northern nations, destroyed the Roman empire, and extended their conquests into far distant countries, they established, where-ever they came, a mixed form of government. The preservation of this constitution depending upon the balance between the king, nobility, and people, the legislative power was lodged in these three states, called by different names in different countries; in the north, diets; in Spain, cortes; in France, estates; and in Britain, parliaments. The excellency of this mixed government, consists in that due poise or balance between rule and subjection, so justly observed in it, that by the necessary concurrence of the nobility and commons, in making and repealing all laws, it has the main advantage of an aristocracy, and a democracy, and yet is free from the disadvantages and evils of either of them. This mixed form of government is, however, now driven almost out of Europe, in some parts of which we can hardly find the shadow of liberty left, and in many there is no more than the name of it remaining. France, Spain, Portugal, Denmark, and part of Germany, were all, an age or two ago, limited monarchies, governed by princes, well advised by parliaments or courts, and not by the absolute will of one man. But now all their valuable rights and liberties are swallowed up by the arbitrary power of their princes: whilst we in great Britain have still happily preserved this noble and ancient Gothic constitution, which all our neighbours once enjoyed. There is such a due balance of property, power, and dominion in our constitution, that, like the ancient government of Sparta, it may be called an empire of laws, and not of men; being the most excellent plan of limited monarchy in the world.

Governments are commonly divided into two classes, arbitrary and free governments; but there are many differed sorts of each. Thus the governments of France and Spain are generally called arbitrary; tho' they differ as much from the governments of Turkey and other eastern empires, where absolute despotism prevails, as they do from the government of England, and other European nations, where liberty is said to flourish in its fullest perfection.

**GOVERNMENT** is also a post or office which gives a person the power or right to govern or rule over a place, a city, or province, either supremely or by deputation.

**GOVERNMENT** is also used for the city, country, or place to which the power of governing is extended.

**GOURD**, in botany. See **CUCURBITA**.

**GOUT**, in medicine. See **MEDICINE**.

**GRABOW**, or **GRUBOW**, a town of Lower Saxony and duchy of Mecklenburg: E. long. 11° 36', N. lat. 53° 32'.

**GRACE**, among divines, is taken, 1st, For the free love and favour of God, which is the spring and source of all the benefits which we receive from him. 2dly, For the work of the spirit, renewing the soul after the image of God, and continually guiding and strengthening the

believer to obey his will, to resist and mortify sin, and to overcome it.

**GRACE**, in geography, a city of Provence, in France, fifteen miles south-west of Nice: E. long. 6° 50', N. lat. 43° 40'.

*Act of GRACE*, the appellation given to the act of parliament 1696, c. 32. which allows prisoners for civil debts to be set at liberty, upon making oath, that they have not wherewithal to support themselves in prison, unless they are alimeted by the creditors upon whose diligences they were imprisoned, within ten days after intimation made for that purpose. See **SCOTS LAW**, tit. 32.

*Days of GRACE*, three days immediately following the term of payment of a bill, within which the creditor must protest it, if payment is not obtained, in order to intitle him to recourse against the drawer. See **SCOTS LAW**, tit. 21.

**GRACE** is also a title of dignity given to dukes, archbishops, and in Germany to barons and other inferior princes.

**GRACES**, in heathen mythology, three goddesses, whose names were Agla, Thalia, and Euphrosyne; that is, shining, flourishing, and gay; or, according to some authors, Pasithae, Euphrosyne, and Ægiale. Some make them the daughters of Jupiter, and Eurypome, or Eunomia, the daughter of Oceanus; but the most common opinion is, that they were the daughters of Bacchus and Venus.

They are sometimes represented dressed, but more frequently naked; to shew, perhaps, that whatever is truly graceful, is so in itself, without the aid of exterior ornaments. They presided over mutual kindness and acknowledgment; bestowed liberality, eloquence, and wisdom, together with a good grace, gaiety of disposition, and easiness of manners.

**GRACULA**, in ornithology, a genus belonging to the order of picæ. The bill is convex, cultrated, and bare at the point; the tongue is not cloven, but is fleshy and sharpish; it has three toes before, and one behind. There are eight species, principally distinguished by their colour.

**GRACULUS**, in ornithology. See **CORVUS**.

**GRADATION**, in general, the ascending step by step, or in a regular and uniform manner.

**GRADISKA**, a city of Sclavonia, situated on the river Save, twenty-five miles west of Pofega: E. long. 18°, N. lat. 45° 33'.

**GRADUATE**, a person who has taken a degree in the university. See **DEGREE**.

**GRAFT**, or **GRAFF**, in gardening, a cion or shoot of a tree inserted into another, so as to make it yield fruit of the same nature with that of the tree from whence the graft was taken. See **GARDENING**.

**GRAIES**, a market-town of Essex, situated on the river Thames, sixteen miles east of London.

**GRAIN**, all sorts of corn, as wheat, barley, oats, rye, &c. See **CORN**, **WHEAT**, &c.

**GRAMMAR**.

# G R A M M A R.

**G**RAMMAR is the art of speaking or of writing any language with propriety.

Grammar considered as an *Art*, necessarily supposes the previous existence of language; and as its design is to teach any language to those who are ignorant of it, it must be adapted to the genius of that particular language of which it treats.—A just method of grammar, therefore, supposing a language introduced by custom, without attempting any alterations in it, furnishes certain observations called rules, to which the methods of speaking used in this language may be reduced; this collection of rules is what is called a grammar of any particular language. For the greater distinctness with regard to these rules, grammarians have usually divided this subject into four distinct heads, *viz.* ORTHOGRAPHY, or the art of combining letters into syllables, and syllables into words; ETYMOLOGY, or the art of deducing one

word from another, and the various modifications by which the sense of any one word can be diversified; SYNTAX, or what relates to the construction or due disposition of the words of a language into sentences or phrases; and PROSODY, or that which treats of the quantities and accents of syllables, and the art of making verses.

But grammar considered as a *Science*, views language in itself: neglecting particular modifications, or the analogy which words may bear to each other, it examines the analogy and relation between words and things; distinguishes between those particulars which are *essential* to language, and those which are only *accidental*; and thus furnishes a certain standard by which different languages may be compared, and their several excellencies or defects pointed out. This is what is called PHILOSOPHIC or UNIVERSAL GRAMMAR.

## OF UNIVERSAL GRAMMAR.

**I**T is not necessary here to inquire how language was originally invented, to trace the various changes it may have undergone, or to examine whether any one language may be considered as the original from which all others have been derived: it is sufficient for our purpose to observe, that all mankind, however diversified in other respects, agree in the common use of language; from which it appears, that language is not merely accidental and arbitrary, but founded in the nature of things, and within the reach of all mankind. It is therefore an object worthy of a philosophic inquiry to discover the foundations upon which this universal fabric has been raised.

The design of speech is to publish to others the thoughts and perceptions of our mind. The most acute feelings of man, as well as of every other animal, are expressed by simple inarticulate sounds, which, as they tend to the preservation of the individual, are universally understood. These inarticulate but significant sounds, therefore, constitute a natural and universal language, which man, as a mere sensitive being, partakes in common with the other animals. But as man is not only endowed with sensation, but with the faculty of reasoning, simple inarticulate sounds are insufficient for expressing all the various modifications of thought, or for communicating to others a chain of argumentation: it was therefore necessary to call in the aid of *articulation*; which by modifying these simple sounds, and by fixing a particular meaning to these modifications, forms the language peculiar to man, and which distinguishes him from all other animals, and enables him to communicate with facility all that diversity of ideas with which his mind is stored. These sounds, thus modified and having a determinate meaning, are called **WORDS**; and as all language is composed of significant words variously combined, a knowledge of them is necessary previous to our acquiring an adequate idea of language.

But, as it is by words that we express the various ideas which occur to the mind, it is necessary to examine how ideas themselves are suggested, before we can ascertain the various classes into which words may be distributed. With this view, therefore, let us suppose a reasonable being, devoid of every prepossession whatever, placed upon this globe. His attention would, in the first place, be directed to the various objects which he saw existing around him: these he would naturally endeavour to distinguish from one another, and give them names, by means of which the idea of them might be recalled when the objects themselves were absent. This is one copious source of words, and forms a natural class which must be common to every language; and which is distinguished by the name of **NOUNS**. And as these nouns are the names of the several substances which exist, they have likewise been called **SUBSTANTIVES**.

It would likewise be early discovered, that every one of these substances were endowed with certain qualities or attributes, to express which another class of words would be requisite. Thus, *to be weighty*, is a quality of matter; *to think*, is an attribute of man. Therefore, in every language, words have been invented to express the various qualities of the several objects which exist. These may all be comprehended under the general denomination of **ATTRIBUTIVES**.

These two classes of words must comprehend all things that exist; for whatever exists, must of necessity be either a substance, or the attribute of some substance; and hence these two classes must comprehend all those words which are significant of themselves, and may be called **WORDS SIGNIFICANT OF THEMSELVES**. If any other words occur, they can only be significant in so far as they tend to explain or connect the words of the two former classes.

But, although these words form the basis or matter of a language, in the same manner as stones form the matter

of a building; yet, as stones cannot be arranged into a regular structure without a cement to bind and connect them, so these original words stand in need of others to connect them, before they can be made to express all the variety of our ideas. Another order of words, therefore, were necessary, which, although not of themselves significant, yet, when joined with others, might acquire a meaning. These form a second general class of words that may be called WORDS NOT OF THEMSELVES SIGNIFICANT, and which cannot acquire any meaning but so far as they serve either to EXPLAIN or CONNECT the others.

Hence, therefore, all words which can possibly be invented, may be divided into two general classes; those that are SIGNIFICANT OF THEMSELVES, and those that are NOT. Words which are significant of themselves, are either expressive of the names of substances, and therefore called SUBSTANTIVES; or, of qualities, which we call ATTRIBUTIVES. Words which are not significant of themselves, must acquire a meaning either as defining or connecting others, which we shall arrange under the two classes of DEFINITIVES and CONNECTIVES, each of which shall be examined in their order.

## CHAPTER I.

### OF SUBSTANTIVES.

SUBSTANTIVES may be divided into two classes, *viz.* those which are primary, commonly called NOUNS; and those of a secondary order, which are often substituted for nouns, and are hence called PRONOUNS: each of which we shall consider separately.

#### Section I. Of Substantives of the First Order, called NOUNS.

NOUNS are all those words by which objects or substances are denominated, and which distinguish them from one another, by names applicable to each, without marking either quantity, quality, action, or relation. And as all the objects which exist must be either in the same state that they were produced by nature, or changed from their original state by art, or abstracted from substances by the powers of imagination, this naturally suggests a division of nouns into NATURAL, as *man, vegetable, tree, &c.*; ARTIFICIAL, as *house, ship, watch, &c.*; or ABSTRACT, as *whiteness, temperance, &c.*

But the diversity of objects being so great as to render it impossible for any person to know the distinct names of every individual, therefore it has been found expedient to arrange them under certain general classes, the names of which may be more easily acquired, so that by referring any unknown object to the class to which it belongs, we in some measure supply the want of proper names. Hence, therefore, each of the above species of nouns are divided into those which denote genera, species, and individuals. Thus, in natural substances, *animal, vegetable, and fessile*, denote genera; *man, dog, tree, metal*, are species; and *Alexander, Cæsar, oak, gold*,

Vol. II. N<sup>o</sup> 57.

are individuals. In artificial substances, *edifice* is a genus; *house, tower, church*, are species; and the *Vatican, Tron-church, and Herriot's hospital*, are individuals. In abstract substances, *motion* is a genus; *flight and course*, are species; the *flight of Mahomet, the course of a greyhound*, are individuals. Each of these general classes might be subdivided into many smaller; but as these lesser divisions can only relate to the particular genius of different languages, it does not fall within our plan to consider them. We therefore proceed to take notice of the accidents which accompany nouns. Of which kind may be reckoned *number and gender*.

As nouns are the names of substances, and as there may be many substances of the same kind, therefore nouns must be adapted to express whether there is one or more of those objects of which we speak. Nouns, therefore, in every language, admit of a certain variation to denote this circumstance, which is called *number*. Thus, in the English language, when we speak of a single place of habitation, we call it *a house*; but if of more, we call them *houses*. In the first of these cases the noun is said to be in the *singular*, and in the last case, the *plural* number: nor does the English, or any other language except the Greek, admit of any other variation but these two: and although the Greek language admits of a particular variation of the noun called the *dual* number, which is a plural limited to two objects; yet this cannot be considered as to language; and it is perhaps doubtful whether this variation ought to be considered as an elegance or a defect in that language.

But although number be a natural accident of nouns, it can only be considered as essential to those which denote genera or species, as it does not descend to individuals. Thus we say, *animal, or animals, vegetables, and fossils*; as also, *man, or men, dogs, trees, &c.* But we only say, *Xenophon, Cæsar, Rucephalus, &c.* in the singular. Nor do these admit of a plural, excepting when we consider any proper name, as a general appellation under which many others are arranged, when it is no longer the name of an individual, but that of a species, and as such admits of a plural; as the *Alexanders, the Ptolemies, the Howards, the Pelhams, the Montagues, &c.* The reason of all which will be obvious, if we consider, that every genus may be found whole and entire in each of its *species*; for *man, horse, and dog*, are each of them an entire and complete *animal*: and every species may be found whole and entire in each of its individuals; for *Socrates, Plato, and Xenophon*, are each of them completely and entirely a *man*. Hence it is, that every *genus*, though ONE, is multiplied into MANY; and every *species*, though ONE, is also multiplied into MANY, by reference to those beings which are their subordinates: But as no individual has any such subordinates, it can never in strictness be considered as MANY, and so is truly an INDIVIDUAL as well in nature as in name, and therefore cannot admit of number.

Besides number, another accident of nouns is *gender*, the nature of which may be thus explained: As nouns are the names of the various objects in nature; and as the distinctions of sex is perceptible among all those objects which are animated; and as those which are inanimate

† 7 X

cannot

cannot admit of any sex at all; therefore all the beings which can become the objects of our speculation, may be considered as either *males*, or *females*, or such as admit of *no* sex, and therefore may be said to be neuter, or of *neither* sex. Hence, therefore, grammarians have made a threefold distinction of nouns, into *masculine genders*, or those which denote *males*; *feminine*, or those which denote *females*; and *neuters*, which denote those substances that admit of no sex. But, although the origin of genders is thus so clear and obvious; yet every language that we know of, except the English, deviates from the order of nature, and often attributes sex to those substances which are totally incapable of any; nay, some languages are so particularly defective in this respect, as to class every object inanimate as well as animate under either the *masculine* or *feminine genders*, as they admit of no gender for those that are of neither sex. This is the case with the French, Italian, and Spanish. But the English, strictly following the order of nature, puts every noun which denotes a male animal, and no others, in the *masculine* gender; every name of a female animal, in the *feminine*; and every animal whose sex is not obvious, or known, as well as every inanimate object whatever, in the *neuter* gender. Nor does this rule admit of any exceptions; although poets take the liberty of personifying any objects they think proper, and endow them with whatever sex suits their purpose best; which serves admirably to distinguish between the cool language of philosophy, and the enthusiasm of poetry.

Although *Cases* are not necessary accidents of nouns; yet as they have been often considered as such, it will perhaps be deemed proper to take some notice of them.—As natural objects remain the same, although viewed from many different points of view, they are not in their own nature altered, although they may be connected with others in many different ways: their names therefore ought to remain unchanged, although their relations to other words may be varied. However, there are certain circumstances in which nouns may be considered with respect to their relation *to*, and connection *with* other words, which occur more frequently than others. Some languages, (particularly the Greek and Latin) express *some* of these circumstances, by a variation of the original noun, which variations are called *CASES*. But the English, and almost all the modern languages of Europe, have followed the order of nature, and allow the noun to remain the same, expressing its relation and connection with other words by the help of distinct words called *prepositions*.—Which of these methods is best, it is not our present purpose to inquire. See *LANGUAGE*.

It has been supposed the English nouns admit of one variation which answers to the genitive case of the Latins.—Thus the word *Alexander* is an English noun in its proper form, and in that case which in Latin would be called the *Nominative*. The variation which they called the *Genitive Case*, is expressed in English by adding the preposition *of* before the noun; thus, *of Alexander*. But the same meaning may be conveyed by the word *Alexander's*; for the meaning is the same if I say the house of *Alexander*, or *Alexander's* house. This, therefore, has been called a true inflection of the original noun. How-

ever, although this opinion has been adopted by all grammarians, it appears to have been adopted without sufficient examination, as will be evident from the following considerations.

There are certain circumstances in which this supposed genitive cannot be substituted instead of the other: for I may say, I speak *of Alexander*. I write *of Caesar*, I think *of Pompey*; but I cannot say, I speak *Alexander's*, I write *Caesar's*; or I think *Pompey's*. Hence these two are not in all cases synonymous terms; and therefore one of them must be considered as only accidentally coinciding with the other in particular circumstances.

Again, every one of these supposed genitives can with propriety assume all the various signs of the different *Cases* in the English language: for we may say simply, as in the nominative case, *Alexander's* house; but we can also say, *of Alexander's* house, *to*, *with*, *from*, *in*, *by*, or *for Alexander's* house, &c. If this then be a real genitive, it requires the sign of the genitive, as well as of the other cases, to explain it; which would be an absurdity too great to be admitted.—But it may be asked, if these are not genitives, to what class of words can they be referred?

In answer to this, it has been already observed, that the variety of substances is so great, that it is impossible for any person to know the names of every one of them; and therefore they have been arranged under the several orders of genera and species. We now further observe, that as the individuals are so exceedingly numerous, it would be impossible even to invent proper names for each, and far less would it be possible to make these names be known to every person who might accidentally see them: therefore when we want to ascertain any individual object, and distinguish it from all the other individuals of the same species, we are obliged to have recourse to particular epithets, or definitives, to ascertain that individual.—Thus, I see a particular house which I want to distinguish from other houses; this has no particular name of its own; I must therefore ascertain it in the best manner I can; and as the shortest is always the best, we most naturally denominate it from its owner or possessor if we know him, and therefore call it *Alexander's*, *James's*, or *John's* house.—Here then we see, that the words *Alexander's*, *James's*, and *John's*, do not stand as nouns, but as *articles* or *definitives* serving to ascertain and point out the individuality of the noun with which they are joined, and are much nearer allied to adjectives than to substantives. These, therefore, like other articles, do not alter the case of the noun; so that the term *Alexander's* house, is as much the proper name of a particular house, as *Alexander* or *James* are the proper names of particular men, and of consequence may be varied thro' the different cases as well as the other.—It is surprising, that this idea never occurred to grammarians; for *St Peter's* at Rome, and *St Paul's* at London, are as truly the proper names of these two noble edifices, as the *Rectundo* or the *Circus* are the proper names of two other structures.—We may therefore safely conclude, that the English language admits of no cases at all, and that the only essential accidents of nouns are gender and number.



Section II. Of Substantives of the Second Order, called PRONOUNS.

All conversation passes between individuals. When these individuals are unknown to each other, how shall the one speaker address the other, when he knows not his name; or how explain himself by his own name, of which the other is wholly ignorant? This might perhaps have been at first effected by pointing; but as this method behoved to be extremely inconvenient and defective, it was necessary that a particular class of words should be invented for this purpose; and as these words always supply the place of a noun, they have been called PRONOUNS;—the nature of which may be explained as follows.

Suppose the parties conversing to be wholly unacquainted, and the subject of the conversation to be the speaker himself: here, to supply the place of pointing, the inventors of language have furnished the speaker with the pronoun *I*; *I write, I desire*; and as the speaker is always principal with respect to his own discourse, they have therefore called this the *pronoun of the first person*.

Again, suppose the subject of the conversation to be the party addressed: here, for similar reasons, they invented the pronoun *THOU*, *THOU writest, THOU walkest*; and as the party addressed is next in dignity to the speaker, or at least comes next with reference to the discourse, they therefore called this the *pronoun of the second person*.

But as the subject of the conversation may be some third object different from either the speaker or the party addressed, another pronoun was necessary; and as this object might be either a *male* or a *female*, or a *neuter*, it was necessary to have one pronoun for each of the genders, *HE* for the *masculine*, *SHE* for the *feminine*, and *IT* for the *neuter*: and this, in distinction to the former, was called the *pronoun of the third person*.—Hence the distribution of pronouns into *persons*.

We have already seen that nouns admit of number; pronouns, which are their substitutes, likewise admit of number. There may be many speakers of the same sentiment, as well as one who including himself speaks the same sentiment with *MANY*; speech may likewise be addressed to *MANY* at a time as well as to *ONE*; and the subject of the discourse may likewise be *MANY*; therefore the pronoun of every one of the *persons* must admit of number, to express this singularity or plurality. Hence, therefore, the pronoun of the first person *I*, has the plural *WE*; that of the second person *THOU*, has the plural *YOU*; and that of the third person *HE, SHE, or IT*, has the plural *THEY*, which is equally applied to all the three genders.

With regard to gender, we do not find in any language that the pronouns of the *First* or *Second* persons admit of any distinction in this respect: nor was it necessary that they should; as the speaker and party addressed are usually present with one another, this distinction is generally obvious from dress and external appearance. But this is not the case with regard to the pronoun of the *Third* person; of whose character and distinctions we often know no more than what we learn from the discourse itself; and hence it is, that in almost all languages the pronoun of the third person admits of genders, as we have already seen the English admits of the triple distinction of masculine, fe-

minine, and neuter.—The utility of which threefold distinction will be best shewn by an example. Supposing there was no such distinction, and that we should read in any history *HE* caused *HIM* to destroy *HIM*, and were told that the pronoun which is here thrice repeated stood each time for something different; that is to say, for a man, for a woman, and for a city, whose names were Alexander, Thais, and Persepolis. Taking the pronoun thus divested of its genders, it does not appear which of the three was destroyed, which the destroyer, or which the cause that moved to the destruction. But there is no ambiguity when we hear the genders distinguished; and when, instead of the ambiguous sentence, *he* caused *him* to destroy *him*, we are told with the proper distinctions that *she* caused *him* to destroy *it*. Then we know with certainty, that the promoter was the *woman*, that her instrument was the *hero*, and that the subject of her cruelty was the unfortunate *city*—From this example we could be surprised how the *Italian, French* and *Spanish* could express themselves with precision or elegance, with no more than two variations of this person.

From the same causes as a distinction of gender is unnecessary in the pronouns of the first and second persons, we see the reason why a single pronoun to each person, an *I* for the first, and a *THOU* for the second, are sufficient for all the purposes of language, as these are always supposed present and obvious. But it is not so with respect to the third person, as the various relations of different objects made it necessary to have not *one*, but *many*; such as, *HE, SHE, IT, THIS, THAT, OTHER, SOME, ALL, ANY, &c.*

Although we have said that there is only one pronoun for each of the first and second persons, yet the English reader may perhaps be puzzled with finding two distinct words applied to each; *I* and *ME*, for the first person; *THOU* and *THEE*, for the second. The learned reader will at once see that these two words *ME* and *THEE* are equivalent to the *accusative* case of the Latin pronoun: but, in order to make the meaning of this as plain as possible without embarrassing ourselves about unnecessary terms, we shall only observe, no effect can be produced without a cause, and no action can be performed without producing some effect. The same person may in different circumstances be either the active and efficient cause *of*, or the passive subject who suffers *by* an action: some languages have therefore formed different words to express the same object in these different circumstances. Thus in the Latin sentences, *Brutus amavit Cassium*, Brutus loved Cassius; and *Cassius amavit Brutum*, Cassius loved Brutus; the word *Brutus* in the first, and *Cassius* in the second, is the form which the noun assumes when it is used as the efficient cause; and *Brutum* and *Cassium* the forms which the same nouns assume when they are represented as the passive subjects. This last then was what was called the *accusative* case of the noun, and the first was called the *nominative*. We have already seen that the English noun admits of no cases, the active subject always preceding the verb, and the passive following it, as is plain from the above sentences, where *Brutus* and *Cassius* remain changed in both situations; and this same might be observed of all other modern languages.

yet

Yet the English and all modern languages admit of a different word to express the different state of the pronouns. Thus, we say, I esteem THEE, I admire HIM, I love HER: in all of which sentences I, the pronoun of the first person, is the *active*, and THEE of the second person, and HE and HER of the third, are the *passive* subjects, and are therefore expressed by the words THEE, HIM, and HER. But if the case be reversed, and the pronoun of the first person becomes the passive subject, and the others the active, they assume a different form; thus, THOU esteeme'st, HE admires, SHE loves—ME. Hence, therefore, it appears that we have two distinct words for each of these pronouns to express the different states in which they may be represented, exactly analogous to the nominative and accusative cases of the Romans—Whether these are to be admitted as cases of our pronouns, or whether they may not rather be considered as distinct words formed for that particular purpose, is of little consequence for us to enquire; as, in whatever light they may be considered, this variation cannot be looked upon as an essential part of language, but only as a particular refinement, invented to prevent the disagreeable repetition of the pronoun, which behoved frequently to have happened without this contrivance. This seems to be the only reason why pronouns have been endowed with this variety, and not nouns. For as nouns are in themselves greatly diversified, the sameness of sounds does not here so often occur as it would have done in the pronouns, where the same I, THOU, HE, SHE, or IT, answers for the name of every object which occurs in nature; but, by this diversity in the form of the words, this circumstance is in some measure obviated. And it is probably for the same reason, that the plural of each of these pronouns is so very different from the singular. Thus, from I of the first person is formed WE in the plural, and from ME the plural US; from THOU and THEE the plurals YE and YOU; from HE, SHE,—HIM, HER, and IT, the plurals THEY, and THEM. In all of which there is not the least resemblance between the singular and plural of any one word; and, except in HE and HIM, THEE and THEM, there is not any similarity between what may by some be thought to be the different cases of the same word.

We have seen that the same object may sometimes be the cause of an action, and sometimes the object which suffers by it. We now observe, that the same object may sometimes be, with regard to the same action, both the active cause and passive subject; as when we say, Brutus killed himself. In which case it is evident, that Brutus was both the cause that produced, and the object that suffered by the action; the pronoun himself being put for his name; for, were it not for the sameness of the sound, and the ambiguity which would be occasioned by it, we might surely say, Brutus killed Brutus. It was therefore necessary to have a particular pronoun for the passive subject, in all those cases where the same object was the agent; and on this account the word SELF has been invented, having the plural SELVES. This pronoun therefore, which serves on all occasions to represent the action as returning upon the agent that produced it, may be call-

ed the reciprocal pronoun; which has this peculiarity, that it can never stand by itself, but must always have the assistance of the pronoun in whose place it is substituted; as, MYSELF, THYSELF, HIMSELF, HERSELF, ITSELF, with their plurals. But although this seems to have been the original use of this pronoun; yet, in the English language, its use has been extended further; and, from its always having a reference to the agent of any action, it has been employed to denote that agent by way of emphasis, as performing the action without the aid or assistance of any other; as, *he himself went*. And from this circumstance it has been further extended to denote any object as performing or suffering any thing which we would not naturally have expected from its known character or nature; as in this sentence: "The most daring of mankind are sometimes startled before they venture upon the commission of any extraordinary crime; even Cæsar HIMSELF felt the utmost perturbation of mind before he dared to pass the Rubicon."

These are all that can be properly called *personal pronouns*; but there are others which are derived from them, called *possessive pronouns*, as, MY, THY, MINE, HIS, HERS, ITS, &c. the nature of which it will be necessary here to explain. We have already shewn how nouns, when they came to denote possession, were no longer to be considered as nouns, but rather as definitives or articles; so the pronouns which we here consider, being the real substitutes of *nominal* articles, ought also to be considered as a distinct class of pronomial articles; for as these never, in any case, can be substituted for a noun, they cannot be considered as pronouns. Grammarians have been led into the mistake of placing them under this head, because they are the substitutes of these words, which, altho' they assume the appearance of nouns, only perform the part of definitives. Thus we have seen, that when we say, *Alexander's house*; the word *Alexander's* can only be considered as a definitive: and, in the same manner, if Alexander was the speaker, he might say, *my house*; or if the party addressed, it would be *thy house*; or if any third person, *his*, and in the same manner *hers* or *its house*. In all which cases this possessive pronoun is substituted for that word which only serves to define and ascertain the identity of the noun, and not for the noun itself, which must always be either expressed or understood. Hence the reason why one pronoun becomes the substitute of this noun and its proper definitive, whether that definitive appears in the form of a noun or pronoun: for I can say, "*Alexander's house* is more elegant than *Mary's*, or *his house* is more elegant than *hers*, although IT neither is so commodious nor agreeable to live in." In which example it is plain, that the words *his* and *hers* are strictly the substitutes only of *Alexander's* and *Mary's*, and nothing more; whereas the pronoun IT is the substitute of the whole noun with its definitive *Alexander's house*. The other class of pronouns possessive, MINE, THINE, &c. as they do not so much serve to distinguish individuals, as to ascertain the property of the thing spoken of, which may, in a certain sense, be considered as an attribute thereof, are more nearly allied to attributives, and have therefore by some been called adjectives. And

it must be acknowledged, that these two classes of words are so nearly allied to one another, that it is difficult to ascertain, in all cases, the precise boundary between them.

Besides these, there are other words which sometimes assume the province of pronouns, and are generally considered as belonging to this class, although in many cases improperly; such as, *THIS, THAT, ANY, SOME, THESE, THOSE, ALL*, and some others; which may be called *improper pronouns*. To distinguish when they may be considered as pronouns, we may observe, that when they stand by themselves, and supply the place of a noun, as when we say, *THIS is virtue, give me THAT*, then are they pronouns. But when they are associated to some noun, as when we say, *THIS HABIT is virtue, or THAT MAN defrauded me*; then, as they do not supply the place of a noun, but only serve to ascertain one, they fall rather under the species of *definitives, or articles*. And indeed it must be confessed, that these, as well as the possessive pronouns, are more properly adapted to define and ascertain individuals among nouns, than to supply their place; and therefore are oftener to be considered as articles than as pronouns. The best rule to distinguish when they are to be considered as the one or the other, is this. The genuine PRONOUN always stands by itself, assuming the power of a NOUN, and supplying its place. The genuine ARTICLE never stands by itself, but appears at all times associated to something else, requiring a noun for its support, as much as *attributives or adjectives*.

The three orders of pronouns already mentioned, may be called *prepositive*; because they are capable of introducing or leading a sentence, without having reference to any thing previous. But there is another order of pronouns which can never be employed but to connect sentences, and must therefore always have a reference to some sentence that precedes them; as, *WHO, WHICH, WHAT*. The nature of which may be explained as follows.

Suppose I say, *LIGHT is a body; LIGHT moves with great celerity*; these would apparently be two distinct sentences. But if, instead of the second *LIGHT*, I were to place the prepositive pronoun *IT*, and say, *LIGHT is a body, IT moves with great celerity*; the sentences would still be distinct, and two. But if I add a *connective* (as for example *AND*) saying, *LIGHT is a body, AND IT moves with great celerity*; I then, by connection, make the two into one. Now it is in the united powers of a *connective and another pronoun*, that we may see the force and character of the pronoun here treated of. For if, instead of the words *AND IT*, we substitute *THAT* or *WHICH*; saying, *LIGHT is a body WHICH moves with great celerity*; the sentence still retains its unity, and becomes, if possible, more compact than before. We may therefore call this pronoun the *subjunctive*; because it cannot introduce an original sentence, but only serves to *subjoin one to some other which is previous*.

The application of this *subjunctive*, like the other pronouns, is universal. It may be the substitute of all kinds of substantives, natural, artificial, or abstract; general, special, or particular: for we may say, *The man who, the ship which; Alexander who, virtue which, &c.* Nay,

it may even be the substitute of all the other pronouns, and is therefore of course expressive of all the three persons. Thus we say, *I WHO now write; THOU WHO now readest; HE WHO now hearst, &c.* And thus the *subjunctive* is truly a *pronoun* from its substitution; there being no substantive existing in whose place it may not stand. At the same time it is essentially distinguished from the other pronouns by this particular, that it is not only a *substitute*, but likewise a *connective* or.

As to the accidents of this pronoun: From its performing the part of a *connective*, it of course follows, that neither *gender* nor *number* can be considered as essential to it; because these are always expressed in the preceding parts of the sentence to which it refers; nor do we in fact find, that this pronoun, at least in modern languages, admits of any distinction to denote *number*, although the English language admits of one variation for the *gender*; as we employ *WHO* for the *masculine* and *feminine*, and *WHICH* for the *neuter* gender, thus: *The man, or the woman WHO went to Rome; the tree WHICH stands on yonder plain, &c.* It likewise admits of a variation similar to that of the accusative case; at least when applied to males or females. For when the object which it represents is the efficient cause of action, it is *WHO*; as, *the man WHO fell, &c.*; but when it is the passive subject, it then, in certain circumstances, takes the form of *WHOM*; as, *the man OF WHOM I speak*; although this is not universal; as we likewise say, *the man WHO was beaten*. But the neuter admits of no such distinctions, as we equally say, *the tree WHICH fell, or the tree OF WHICH I spoke*. But both of these admit of a variation to denote possession or qualities, which is the word *WHOSE* for all genders. Thus, we say, *Socrates WHOSE only study was virtue; Elizabeth WHOSE reign was glorious*.

To conclude: We have seen that substantives are either *primary* or *secondary*; or, in other words, *nouns* or *pronouns*. The *nouns* denote substances, either *natural, artificial, or abstract*; and these either *general, special, or particular*. The *pronouns*, their substitutes, are either *prepositive* or *subjunctive*: the *PREPOSITIVE* is distinguished into three orders, called the *first, the second, and the third* persons: the *SUBJUNCTIVE* includes the powers of all the three, having *superadded*, of its own, the peculiar force of a *connective*.

## CHAPTER II. OF ATTRIBUTIVES.

As all attributives must either be expressive of the attributes of *SUBSTANCES*, or of other *ATTRIBUTIVES*, we divide this class into two kinds; calling those of the first kind *ATTRIBUTIVES of the FIRST ORDER*; and those of the second kind, *ATTRIBUTIVES of the SECOND ORDER*.

### Section I. Attributives of the First Order.

Attributives are all those *principal* words that denote attributes considered as attributes. Such, for example,

are the words, *black, white, great, little, wise, eloquent, to write, to walk, to speak, &c.* all of which are the *attributes of substances*. Thus *black* is an attribute of *jett, white of snow*;—*wise and eloquent*, as also, *to write and speak*, are attributes of *men*.

In examining the different attributes of substances, we readily perceive that some of them have their essence in *motion*; such are, *to walk, to fly, to strike, to live, &c.* Others have it in the *privation of motion*; as, *to stop, to rest, to cease, to die, &c.* And others have it in subjects that have *nothing to do* with either *motion* or its *privation*; such are the attributes of *great and little, wise and foolish, white and black*, and, in a word, the *several quantities and qualities* of all things. This therefore furnishes a natural division of attributes of this order; and grammarians have called all those, whose essence consists in *motion* or its *privation*, **VERBS**; and all the others have been called **ADJECTIVES**; each of which we shall consider separately.

### I. OF VERBS.

**VERBS** are all those principal words which denote *attributes*, whose essence consists in *motion, or energies*, (for we chuse to make use of this last term, as it implies the exertions of the mind as well as those of the body), or their *privation*. This order of attributives differs from the other called *adjectives*; not only in the particular above-mentioned, but also because *adjectives* denote only qualities or quantities, which do not admit of any change of state; whereas the verbal attributives may be considered as in several different states, and therefore admit of several variations in the term employed to express these. It may, in the first place, be considered as a simple attribute or energy, without particularizing any circumstance relating to the state it may be in; as in the word *to write*. Or, in the second place, as these are all attributes which denote motions or energies, they may be represented as in the state of actual motion or exertion; as in the word *writing*. Or, lastly, the motion or energy may be finished, and its effect completed; as in the word *written*. Hence, therefore, every verb admits of a threefold variation in every language, in each of which languages they are distinguished by some particular names. Our grammarians have given the name of the **INFINITIVE MODE** to the original verb itself, and the other two variations of it are both distinguished by the name of **PARTICIPLES**; that variation which exhibits the verb in its state of energy being called the **PARTICIPLE PRESENT OR ACTIVE**, and the other variation is called the **PARTICIPLE PERFECT OR PAST**.

These variations of the verb are founded in the nature of things, and therefore must be found in every language under some form or other. As to the other supposed variations of verbs relating to person, number, time, &c. the slightest reflection on this subject will shew, that a verb, considered as a simple attributive, can admit of none of these affections, but must for ever remain the same at all times and in all situations whatever; for who does not see, that the attribute *to write* is the same whether

it is possessed by *you, by me, or by any number of different persons*? Nor does this attribute suffer any change, whether it is represented as having been exerted a *thousand years ago, or at this present moment, or at any other assignable period of duration*; but, like every other attribute, it must remain for ever the same. For however *substances* may vary with time, and be incessantly changing; yet *attributes* of every sort are altogether beyond its power. And we must easily perceive, that the attribute which is expressed by the word **GOOD**, is the same now as it was at the creation, or will be while the world exists. And in the same manner, *to walk, to write, to fly*, denote attributes, which must each of them preserve their own particular nature during all the successive ages of time. Hence therefore we see, that the verbal attribute must for ever remain in that state, or modification, in which it is at first represented. Nor can it suffer any change, however different the circumstances may be in which it can be applied in language. All, therefore, that can be said of these several variations with which grammarians have usually endowed verbs, is this, That, as an attributive, it hath such an intimate connection with a substantive, as necessarily to be united with one, before it can make a principal figure in language: And as that union may be represented as taking place at different times, and under different circumstances, the inventors of some languages have contrived to express these different connections by a single word, instead of doing it by different words, as the thing in itself would naturally require; in the same manner as those who use the short-hand method of writing, make a single character express a whole word, or sentence: And as it was most natural for the contrivers of these words to derive them from the verb itself of which they are compounded, they have each of them become a *real* variation of the original *word* which expresses the verbal attribute; and, from thus being a variation of the verbal *word*, they have at last come to be considered as an *essential* variation of the *verb itself*, which has occasioned those contradictory definitions, and that confusion of ideas which we meet with among all writers on this subject. But as we here consider language as in itself, without regarding the particular forms under which it may appear, we must reject all these variations of *persons, numbers, modes, and tenses*, which the verb itself has usually been supposed to undergo; and consider them, not as essential variations of the verb itself, but as variations produced in language by the combination of the verb with other parts of speech; and therefore relating to *syntax*, and of course belonging to those grammatical disquisitions alone which treat of the peculiarities of any particular language. But as these variations have been so universally considered as essential parts of the verb itself, and as the terms which this division of the verb have introduced into grammar are so frequently to be met with, it will be necessary to explain in some measure the meaning of these several terms.

In the natural world, no attribute can possibly exist without a substance to which it belongs, nor any substance without possessing certain attributes. So necessary and intimate is the connection between these, that it is as impossible

impossible to separate them, as to create or annihilate the several substances that possess these attributes. But although we are thus circumscribed as to our bodily powers, the mind admits not of such limitation; but can with the utmost facility separate every quality from every object whatever, and consider them apart; as, *colour* without *superficies*, *superficies* without *solidity*, or *weight* without *matter*, &c. and, when thus separated, apply them to what objects, and in what manner, it pleases. In this manner the mind abstracts those attributes which denote *motions* or *energies* from their *agents* or *energizers*, in the same way as it abstracts *qualities* from their *substances*. And it is these energies thus abstracted, which form that species of words called *verbs*; in the same manner as those attributes which denote *quantities* and *qualities* abstracted from their necessary substances, form *adjectives*. Thus, the term *to walk*, denotes a particular *energy* as considered perfectly apart from every *energizer*, in the same manner as the word *good* denotes a certain *quality* without regard to any particular *substance*.

Here then we discover a most essential difference between the order of nature, and that representation of it which man makes by means of words. For in *nature*, every quality must at all times be united with some substance, nor can ever be exhibited separate from it; but in *language*, every attributive, if it be considered at all, must be separated from the object to which it naturally belongs. Hence we see the reason why, in language, every *energy* and *energizer*, not only *may* be considered separately, but *must* for ever remain separate, unless they be united by some other power than what is necessarily their own. For the attribute *to write*, can no more be united to *man* its proper *energizer*, than a motion could commence without a cause; and till this attribute is united to its proper *energizer*, it must remain in a great measure dead and inefficacious in language.—To communicate life and energy, therefore, to this inert attribute, it must be united to its proper *energizer*; which can only be effected by the help of an assertion of the speaker himself; which may be considered as the same with regard to language, as life is in the natural world.

It is evident that, by the assistance of an assertion, the speaker is enabled to write any energy to any particular *energizer*, and thus, without making any change upon the attribute itself, represent a variety of changes produced upon other bodies by its means.—Thus, if I say, *I write*, what do I more than assert that I myself am possessed of that particular attribute denoted by the verb *to write*? If I say, *You write*, or *He writes*, what do I more than assert that another person is possessed of that particular attribute or energy?—If I say, *He did write*, I only assert that the same attribute was possessed at another time, by the same person, as before. Hence therefore, by the help of this assertion of the speaker, we are enabled to join this particular attribute to many different *energizers*, as well as to represent these different combinations as occurring at many different times; so that the same attribute may thus be made to appear under a great many different circumstances, and exhibit a great variety of changes upon other objects, although itself remains unchanged; the several variations

which we perceive, only relating to the objects with which it is combined, or the means by which that union is effected.—In the same manner it often happens, that any object in nature, a house for example, may appear extremely different when viewed from different situations.

From the intimate connection that takes place between the energy, the *energizer*, the *assertion*, and *time*, these several accessories have been considered as essential parts of the verb; and therefore some grammarians have defined a verb to be *A word denoting an energy, with time, and an assertion*. But if we were thus to confound things with those which may necessarily accompany them, we could never arrive at a clear perception of any subject whatever. But not to enter into the arguments that might be produced to shew the impropriety of this definition, we shall only observe, that by the universal acknowledgment of all grammarians this cannot be just. For they unanimously agree, that the *infinitive mode* is not only a part of every verb, but the *most essential part*; as it forms the root from which all the other parts are derived. But as this mode neither denotes either time or an assertion, it is evident that these, even by their own acknowledgment, can be at best but accessories, and not essential parts of the verb.

From these arguments, therefore, we must conclude, that the verb itself admits of no other variations but those already taken notice of;—that before it can produce any active effect in language, like every other attribute, it must be united to some proper *energizer*;—that this union in language can never be effected but by means of an exertion of the vital powers of the speaker, whereby he either publishes his perception thereof, or his will that it should be;—and that this union may be represented as taking place at all the different times that can be assigned. These, therefore, are each of them necessary accompaniments of a verb, but each of them separate and distinct in their own nature, not only from this verb, but from one another; and it becomes an essential part of the syntax of every language, to consider the various ways in which these can be combined and affect one another.—Nay, so intimate has this connection been thought to be by some, that the contrivers of certain languages have arranged them under particular classes, for the sake of distinctness and precision.—The form which a verb assumed, when thus varied in all the ways that their particular language would admit of, was called the CONJUGATION of the verb; the several parts of which may be understood from the following sketch.

When the verb is considered under the compound form of which we now speak, it can admit of variations chiefly in three respects. For, first, supposing the *attribute*, the *energizer*, and the *time* when that attribute was exerted by the *energizer*, to be the same; a variation may be occasioned by a change being produced in the *perception* or *volition* of the speaker, (which, for brevity, we will call the *assertion*;) as in these examples: *I write*, SCRIBO; *I may write*, SCRIBAM; *do you write*, SCRIBE. The variations produced by this means have been called *MODES*. Secondly, supposing the *attribute*, the *energizer*, and the *assertion*, to be the same; a change may be produced in the *time*, as in these examples: *I do*  
*write*,

*write*, SCRIBO; *I did write*, SCRIPSI; *I shall write*, SCRIBAM, &c. The variations produced from this cause have been called TENSES. And, thirdly, Supposing the attribute, the time, and the assertion, to remain unchanged, there may be a difference in the energizer; and this likewise admits of a division: for as the energizer may be only one or more persons, it must have a variation into singular and plural on these accounts; as in these examples: *I write*, SCRIBO; *thou writest*, SCRIBAS; *he writes*, SCRIBAT; and in the plural, *we write*, SCRIBAMUS; *ye write*, SCRIBATIS; *they write*, SCRIBANT. The variations produced from this cause have been called PERSON and NUMBER.—These are all the variations which have been made in the Latin or Greek languages; and therefore our grammarians, who have adopted every idea they have of grammar from these languages, mention no more: but it was not necessary that they should have stopt here, for an attribute is surely as susceptible of the distinction of sex as of person, so that they might have had a variation for Gender also; and instead of having one word SCRIBAT to answer for all the three genders, *he, she, or it wrote*, they might have had three different words.—The composers of the Hebrew language have adopted this plan, and admit of two variations on this account; and the Russian language admits of a like variation in their verb for these genders; as in this example: ON ZOHELAL, *he has done*; ONA ZOHELALA, *she has done*, &c. But as the two languages above mentioned do not admit of this distinction, therefore all the variations that our verbs are said to admit of are MODES, which include within them TENSES, which include under them PERSONS, under which head is included NUMBER; and these are all the parts into which a CONJUGATION has been divided.—As to what concerns the nature and lesser distinctions of each of these, the following general remarks may be sufficient.

With regard to MODES; as this relates solely to the perception or volition of the speaker, it necessarily follows, that there ought to be a distinct and particular MODE for each diversity that there can be in his manner of perceiving or willing any thing whatever, the principal of which are the following.

If we simply declare that we perceive any object, or that such a thing is or will be, without any limitation or contingency, it forms what has been called the DECLARATIVE or INDICATIVE MODE; as, *I write*—Again, if we simply represent it to be within our power, or to depend upon our choice, it forms two other modes, which may be called the POTENTIAL, as, *I can write*; or the ELECTIVE, as, *I may write*—In the same manner, if the speaker represents himself, or any other object, as determined to perform any action, or as compelled to it, or as it is his duty to perform it; these form so many distinct modes, which may be called the DETERMINATIVE, as, *I will write*; the COMPULSIVE, as, *I must write*; and OBLIGATIVE, as, *I should write*. But although each of these represents the speaker as perceiving the agent under a different light with respect to the action; yet as all of them, except the indicative, agree in this, that however much they may represent it as the duty or inclination, &c. of the agent to perform any action

with which they are associated, yet as they are still of the nature of contingents which may never take effect, they are frequently subjoined to any other verb; therefore the Latins have comprehended all of these under one mode, which they have called the SUBJUNCTIVE. We only take notice of this circumstance here, to shew, that however naturally sentences may be distinguished into modes, according to the different situation of the speaker; yet as the whole order of the variation of words in the conjugation of a verb is merely arbitrary, those who invent them may arrange them into what order they please, and call them by what names they may think most proper. But however they may vary the names or external arrangement, this does not affect the things themselves. For by whatever name the mode may be known which comprehends the words expressive of these several meanings, the sentences formed by these will be either *potential, obligative, compulsive*, &c. as above explained.

All these modes above mentioned only relate to the different perceptions of the speaker. But as man is not only endowed with the powers of perception, but those of volition also, he must have words to express these; which forms another order of modes. As he is not only dependent himself, but has others depending upon him, he may command, intreat, beg, pray, wish, inquire.—Hence, therefore, so many different orders of modes, the IMPERATIVE, REQUISITIVE, PRECATIVE, OPTATIVE, INTERROGATIVE, &c. to which may be added the VOCATIVE. But although each of these display a distinct affection of the speaker, yet grammarians have allotted only one variation of their verb for all of these purposes, called the IMPERATIVE MODE; all the other volitions being expressed by this, or some other mode, by the help of particular contrivances, which are different in different languages.

With regard to that variation of the verb which relates to time, called TENSES: As an action or event may be represented as happening at any assignable period of time, it is necessary to divide that duration into certain parts, that we may be able to represent the different relations which events bear to one another with respect to this particular. The first and most obvious division of time is into present, past, and future. But we may go farther still in our divisions of time. For as time past and future may be infinitely extended, we may in universal time past assume many particular times past, and in universal time future many particular times future, some more, some less remote, and corresponding to each other under different relations. Even present time, however, in strict physical truth, it may be incapable of it, is by the power of the imagination brought to admit of these differences, and as necessarily implies some degree of extension, as every given line however minute: And hence it is not sufficient for language to denote INDEFINITELY mere past, present, or future times; but on many occasions to DEFINE with more precision what kind of past, present, or future is meant.

Tenses, therefore, or those variations of a verb which denote a difference of time only, may be all divided into PRESENT, PAST, and FUTURE; each of which may be subdivided into DEFINITE and INDEFINITE. The

definite

*definite tenses* are those where the particular instant of time, whether present, past, or future, is pointed out. The *indefinite* are those where past, present, or future time is indicated in general, without confining it to a particular instant in either of these cases. These have been distinguished among grammarians by the name of **AORISTS**.— Thus when Milton makes Adam say,

*Millions of spiritual creatures walk the earth,  
Unseen, both when we wake and when we sleep,*

the verb **WALK** means not that they were walking at that instant only when Adam spoke, but *indefinitely* in any instant whatever. So likewise, when the same author calls hypocrisy,

— *the only evil which WALKS  
Invisible except to God alone.*

the verb **WALKS** has the like aoristical signification. *He went, he fell,* are *aorists* of the past, as they do not specify any particular instant, but refer to past time in general. So likewise in the legislative sentences, *thou shalt not kill, thou shalt not steal, &c.* the same aoristical meaning is perceived, as the prohibition does not relate to any particular time future, but is extended indefinitely to every time future.

But it is not sufficient for a language to denote time in this indefinite manner: it is necessary likewise that it should be capable of specifying any particular instant of time in an exact and definite manner. Thus, if, instead of the word **WALK** in the first sentence above quoted, we were to put **ARE WALKING**, it brings down the verb to denote a particular time, and specifies that these *spiritual creatures* are, at that very instant in which Adam speaks, walking upon the earth unseen. In like manner, in the second sentence, if the word **WALKS** were changed to **IS WALKING**, it denotes, that hypocrisy, at that particular instant in which the sentence was pronounced, was walking invisible upon the earth. And in the same manner, **WAS WALKING, OR WILL BE WALKING**, each of them denote, that these energies were or will be exerted at a particular specified time. These, therefore, form so many distinct definite tenses, under whatever technical name these may be known.

Here then we see the use of that distinction of the different states of the verb, into the *verb properly so called*, and *participles*. For as the verb itself exhibits the word as altogether *indefinite*; when this is joined to its proper energizer, it forms all these **INDEFINITE TENSES** which our language requires. Thus, *I write, I did write, I will write, I may write, I can write, &c.* each of them, although they represent the attribute as united to the energizer in some *past, present, or future* time, do not specify any particular instant, and are therefore so many aorists or indefinite tenses. Whereas in the *participle* the attribute is represented as in a state of exertion, it necessarily follows, that if it be ever united to its energizer, it must point out the particular instant when that union took effect, and of consequence form as great a variety of **DEFINITE TENSES** as the verb forms of indefinite. Thus, *I am writing*, necessarily implies that I am actually exerting this particular energy at the very instant that I declare it. So likewise if I say *I was writing*, it indicates, that at one particular instant of past duration, to which this has a reference, I was actu-

ally employed in that particular occupation. This instant is generally fixed by some collateral circumstance; as, "upon the twentieth day of August last, at 12 o'clock, *I was writing*;" or, "when the thunder broke upon the tower in my neighbourhood, *I was writing*," &c. And the same may be said of future time; as, "to-morrow at ten o'clock *I shall be writing*," &c. In all of which cases it is obvious, that a particular *now* or *instant* is pointed out, in which the attribute is represented as united to its proper energizer. We might here proceed to shew the various times that each of these different states of the verb might be made to indicate; the number of *tenses* that each mode admitted of; the several changes that might be produced by joining the *participle perfect* with any object; which cannot be here called the *energizer*, but the *subject*; for as the energy is by this participle represented as completed, if it has any connection with any person, as the attribute cannot be affected by any energizer after it is completed, it must of necessity affect the person, instead of being affected by it; and hence it is that the several variations produced by this participle perfect have been called the **PASSIVE VOICE** of the verb. But as all these particulars only relate to the construction of one particular language, it would lead us a great deal too far from the particular subject of which this article treats. We shall therefore only observe, that besides the above variations of the verb, which the Greeks and Romans have thought proper to make, the terms of which we have adopted; there are many others that they might with equal propriety have made, but which they rather chose to express by the help of other words called *adverbs*. But some other languages have gone further in this respect, and endowed their verbal word with several variations to express several other circumstances than they do. This is particularly the case with the Hebrew language, which, besides the variation for gender above mentioned, has allotted certain other variations of its verb to express several other circumstances. Thus, **PAKAD** in that language signifies *he visited*; **PAKEDA**, *she visited, &c.* **PIKED**, *he visited diligently*; **HEPKED**, *he made him visit*; and **HETHPEKED**, *he visited himself*. In this manner is every verb in that language varied; and each of these different conjugations of their verb admits of a particular variation for the passive of each— Hence, therefore, the conjugation of a verb in that language admits of a great many variations which neither the Greeks nor Romans were acquainted with: for besides the distinctions of *modes, tenses, persons, and numbers*, they have divided their verb into so many distinct divisions to answer for these distinctions above mentioned, which they have denominated **KAL, PIHEL, HIFHIL, and HITHPAHEL**, with their passives **NIPHAL, PUHAL, and HOPHAL**; each of which admits of variations through all the *modes, tenses, persons, numbers, and genders* which any of their verbs admit of.

The only use which we meant to make of these observations on the Hebrew verbs, is this: That as the authors, who have formed their idea of grammar from the forms which the several parts of speech admit of in the Greek and Latin languages, have supposed that every variation which these languages admitted of was a natural and necessary part of language; and that therefore every language which did not admit of the same number of variations,

tions with theirs in every part of speech, was in so far defective and incomplete. So, for the same reason, an author who had formed his idea of grammar upon the model of the Hebrew tongue, would as naturally suppose, that the several variations which the verb admitted of in his own favourite language, were essential and necessary; and that, of consequence, every language which did not admit of as many variations was imperfect and incomplete. But to any one who considers this matter with attention, it will appear, that there could be no end to these unnecessary discussions and groundless claims of fancied superiority: for if compound words have such an advantage over simple, the Chinese language, in which we are told almost every sentence has a particular compound character to express it, must be by far the most perfect in the world; but so far is this from being the case, that every one allows it to be the most imperfect and incomplete. The only method, therefore, which remains for us to consider this subject is, to disregard every particular form of language, and consider the words in themselves, as divested of every extraneous circumstance, and observe what variations they necessarily require, allowing every particular language to compound these with one another in what manner they shall think most proper. It is in this manner we have considered the verbal attributes, and endeavoured to disentangle them from these unnecessary fetters with which they have been loaded, and restore them to their own original freedom.

Besides the variations above-mentioned, verbs have been distinguished from one another in a different manner; the names and nature of which may be thus explained.

We have already seen, that all verbs, as they denote *energies*, necessarily have reference to certain *energizing substances*. For, how could there be such energies as *to love, to fly, to wound?* &c. were there not such beings as *men, birds, swords,* &c. Farther, every energy not only requires an energizer, but is necessarily conversant about some subject. For example, if we say, *Brutus loves*, we must needs supply—*loves Cato, Cassius, or some one*. And thus it is, that every energy is necessarily situated between two substantives, an energizer which is *active*, and a subject which is *passive*. If the energizer leads the sentence, the energy has been said to follow its character, and becomes what we call a **VERB ACTIVE**: thus we say, *BRUTUS AMAT, Brutus loves*. On the contrary, if the passive subject be principal, it is said to follow the character of this too, and becomes what we call a **VERB PASSIVE**: thus we say, *PORTIA AMATUR, Portia is loved*. But in some verbs it happens, that the energy always keeps within the energizer, and never passes out to any extraneous subject. Thus, when we say, *Cæsar walketh, Cæsar sitteth*, it is impossible that the energy should pass out, because both the energizer and the passive subject are united in the same person. For what is the cause of this walking or sitting? it is the will and vital powers belonging to Cæsar: and what is the subject made so to move or sit? it is the body and limbs belonging also to the same Cæsar. This species of verbs have been by grammarians distinguished by the name of **VERBS NEUTER**, as if they were void both of *action* and *passion*, when perhaps they may be rather said

to imply both. It is in this manner, that verbs have been distinguished into the three classes of *active, passive, and neuter*. These, however, might with more propriety be divided into two classes, which might be called verbs **TRANSITIVE**, and **NOT TRANSITIVE**; the first class including all those verbs which are usually called *active*, with the *passives* belonging to them; for it is evident, that these passives are not verbs themselves, but a variation only of a verb; and the second class including those verbs commonly called *neuter*.

Some languages, as the Greek and French, have another class of verbs, which are called by the first **VERBS MIDDLE**, and by the last **RECIPROCAL VERBS**; which are employed to denote that state of any transitive verb, when the energizer himself becomes the subject; as thus, *Brutus killed himself*, &c. But as these only express a slight variation of an accompaniment of a verb, they have no claim to be considered as a distinct species.

## II. OF ADJECTIVES.

**ADJECTIVES** are all those words which denote attributes whose essence does not consist in motion or its privation: or, in other words, they are those words which denote the attributes of quantity, quality, and relation; such as, *many, few, great and little, black and white, good and bad, double, treble, quadruple,* &c.

As these attributes admit of no change of state, nor can be effected by the variations of time, or any other accident, but are in their own nature perfectly fixed and invariable, the words which express them ought to be in all situations and on all occasions the same. For as the qualities *good or bad, black or white*, admit of no change in their own nature, whether they be applied to a *man, to a woman, to many, or to few*; neither ought the word which expresses any one of these attributes in strictness to admit of any alteration, whether it be joined to one or other of these substantives. So that although in some languages, from the particular construction of the other parts of speech, it has been found necessary to endow their adjectives with the threefold distinction of *gender, number, and case*; yet this must only be considered as an accidental variation occasioned by particular circumstances, and not in the least essential to language, but rather a deviation from the order of nature, which would require them to be kept invariably the same in all cases. This order, the English language (which in this and almost every other case is most strictly conformable to the nature of things than any other language we are acquainted with) most strictly observes; as we say equally, *a good man, or a good woman, a good house; or good men, good houses,* &c.

It has probably been from observing, that the adjectives in some particular languages are endowed with variations conformable to the *gender, number, and case* of their substantives, that grammarians have been led into the strange absurdity of ranging them with nouns, and separating them from verbs; though with respect to verbs they are perfectly homogeneous, and with respect to nouns they are quite the contrary. Adjectives are homogeneous with respect to verbs, as both sorts denote

*attributes;*



*attributor*; they are heterogeneous with respect to nouns, as *novet* properly denoting *substances*.

Besides original adjectives, there is another class which are formed from substantives. Thus when we say, *the party of Pompey*, *the style of Cicero*, *the philosophy of Socrates*; in these cases, the party, the style, and philosophy spoken of, receive a stamp and character from the persons they respect, and actually pass into attributives, and as such assume the form of *adjectives*. And hence we say *the Pompeian party*, *the Ciceronian style*, and *the Socratic philosophy*. In like manner, for a trumpet of brass, we say, *a brazen trumpet*; for a crown of gold, *a golden crown*, &c. Even pronomial substantives admit the like mutation; as, instead of saying *the book of me*, of *thee*, or of *him*, we say, *my book*, *thy book*, *his book*, &c. Yet it must be acknowledged, that these, as they often serve rather to define a noun than to denote any quality appertaining it, they partake more of the nature of *articles* than *adjectives*; so that it is in many cases difficult to ascertain exactly to which class they are to be referred. But of this we have already taken particular notice, p. 713. col. 2. & 716. col. 2.

The nature of these variations of adjectives which have been called *degrees of comparison*, will be more properly explained under the following section.

## Section II. Of *Attributives of the Second Order*, called *ADVERBS*.

As the attributives hitherto mentioned denote the *attributes of substances*, so there is an inferior class of them which denote the *attributes only of attributes*. To explain these by examples of either kind: when we say, *Cicero and Pliny were both of them eloquent*; *Statius and Virgil both of them wrote*; in these instances, the attributives *eloquent* and *wrote*, are immediately referable to the substantives *Cicero*, *Virgil*, &c.: As, therefore, denoting the *attributes of substances*, we call them *ATTRIBUTIVES OF THE FIRST ORDER*. But when we say, *Pliny was moderately eloquent*, but *Cicero exceedingly eloquent*; *Statius wrote indifferently*, but *Virgil wrote admirably*: in these instances, the attributives *moderately*, *exceedingly*, *indifferently*, and *admirably*, are not referable to *substantives*, but to *other attributes*; that is, to the words *eloquent* and *wrote*: As, therefore, denoting *attributes of attributes*, we call them *ATTRIBUTIVES OF THE SECOND ORDER*. These have been, by grammarians, called *ADVERBS*. And indeed, if we take the word *VERB* in its most comprehensive signification, as including all the words which denote the *attributes of substances*, (which was the sense in which Aristotle and many of the most ancient grammarians employed it) we shall find the name *ADVERB* to be a very just appellation, as denoting a *part of speech the natural appendage of verbs*. So great is this dependence in grammatical syntax, that an *adverb* can no more subsist without its *verb*, than a *verb* can subsist without its *substantive*.

Among the attributes of substances are reckoned quantities and qualities. Thus we say, *a white garment*, *a*

*high mountain*, &c. Now some of these quantities and qualities are capable of *intension* and *remission*. Thus we say, *a garment EXCEEDINGLY white*, *a mountain TOLERABLY or MODERATELY high*. Hence, then, one copious source of secondary attributives, or adverbs, to denote these two, that is, *intension* and *remission*; such as, *greatly*, *vastly*, *extremely*, *sufficiently*, *moderately*, *tolerably*, *indifferently*, &c.

But where there are different intensions of the same attribute, they may be compared together: thus, if the garment A be EXCEEDINGLY white, and the garment B be MODERATELY white, we may say, the garment A is MORE white than the garment B. In these instances, the adverb MORE not only denotes intension, but *relative intension*. Nay, we stop not here, as we not only denote intension merely relative, but *relative intension than which there is none greater*. Thus we not only say, the mountain A is MORE high than the mountain B, but that it is the MOST high of all mountains. Even verbs, properly so called, as they admit of *simple intensions*, so they admit also of these *comparative ones*. Thus, in the following example, *Fame he LOVETH MORE than riches*, but *virtue of all things he LOVETH MOST*; the words MORE and MOST denote the different *comparative intensions* of the verbal attribute *loveth*.

Hence the rise of COMPARISON of adjectives, and of its different degrees, which cannot well be more than the two species above-mentioned; one to denote *simple excess*, and one to denote *superlative*. Were we indeed to introduce more degrees than these, we ought perhaps to introduce *infinite*, which is absurd. For why stop at a limited number, when in all subjects susceptible of intension the intermediate excesses are in a manner infinite? There are infinite degrees of *more white*, between the *first simple white*, and the *superlative whitest*; and the same may be said of *more great*, *more strong*, *more minute*, &c. The doctrine of grammarians about three such degrees of comparison, which they call the *positive*, the *comparative*, and the *superlative*, must be absurd; both because in their positive there is no comparison at all, and because their superlative is a comparative as much as their comparative itself. Examples to evince this may be met with every where; *Socrates was the MOST WISE of all the Athenians*; *Homer was the MOST SUBLIME of all poets*, &c.

The authors of language have in some instances contrived a way to retrench these comparative adverbs, by expressing their force by an inflection of the primary attributive. Thus, instead of *more fair*, they say, *FAIRER*; instead of *most fair*, *FAIREST*: and the same method of composition takes place both in the Greek and Latin languages; with this difference however between the genius of these languages and ours, that we are at liberty to form the comparison, either in the one method or the other: but in these languages, the comparison is almost never formed by the assistance of the adverb, but always by the inflection of the adjective; and hence this inflection is always considered by them as a necessary accident of the adjective. But this method of expressing the power of the adverb has reached no farther than to adjectives,

adjectives, or to their participles, which were so nearly allied to adjectives. Verbs were perhaps thought to be too much diversified, to admit of more variations without perplexity.

Some qualities admit of comparison, others admit of none: such, for example, are those which denote *that quality of bodies arising from their figure*; as, when we say, a *circular table*, a *quadrangular court*, a *conical piece of metal*, &c. The reason is, that a million of things participating the same figure, participate it *equally* if they do it at all. To say, therefore, that while A and B are both quadrangular, that A is more or less quadrangular than B, is absurd. The same holds in all attributives denoting *definite quantities* of whatever nature. For, as there can be no *comparison* without *intension* or *remission*, and as there can be no intension and remission in things *always definite*, therefore these attributives can admit of no comparison. By the same method of reasoning, we discover the cause why *no substantive is susceptible of these degrees of comparison*. A mountain cannot be said *MORE TO BE OR TO EXIST* than a mole-hill; nor the lion A cannot be *more a lion* than the lion B: but the *more* or *less* must be sought for in their quantities or qualities; a mountain is *more bulky* than a mole-hill, and the lion A is *more fierce* than the lion B; the excess being always derived from their attributes.

Of the adverbs or secondary qualities already mentioned, those denoting intension and remission may be called adverbs of *QUANTITY CONTINUOUS*; as, *once, twice, thrice*, &c. are adverbs of *QUANTITY DISCRETE*; *more and most, less and least*, to which may be added *equally, proportionally*, &c. are adverbs of *RELATION*. There are others of *QUALITY*; as when we say, *HONESTLY industrious*, *PRUDENTLY brave*, *they fought BRAVELY*, *he painted FINELY*, &c.

The adverbs hitherto mentioned, are common to *verbs of every species*; but there are some which are confined to *verbs* properly so called, that is to say, to such as denote *motions* or *energies* with their *privations*. All *motion* and *rest* imply *time* and *place* as a kind of necessary coincidence. Hence, if we would express the *place* or *time* of either, we must needs have recourse to adverbs formed for this purpose; of *PLACE*, as when we say, *he stood THERE*, *he went HENCE*, *he travelled FAR*, &c.; or of *TIME*, as when we say, *he stood THEN*, *he went AFTERWARD*, *he travelled FORMERLY*, &c. Should it be asked, Why *adverbs of time*, when verbs have *tenses*? The answer is, though *tenses* may be sufficient to denote the greater distinctions of time, yet to denote them all by *tenses* would be a perplexity without end. What a variety of forms would be necessary to denote *yesterday, to-day, to-morrow, formerly, just now, now, immediately, presently, soon, hereafter*? &c.

To these adverbs just mentioned may be added those which denote the *intensions* and *remissions peculiar to MOTION*, such as *speedily, hastily, swiftly, slowly*, &c.; as also adverbs of *place* made out of *prepositions*, such as *upward* and *downward*, from *up* and *down*. In some instances the preposition suffers no change, but be-

comes an adverb by nothing more than its application; as when we say, *he rides ABOUT*, *he was NEAR sailing*, &c.

There are likewise adverbs of *INTERROGATION*; such as, *where, whence, whither, how*, &c. of which there is this remarkable, that when they lose their *interrogative power*, they assume that of a *relative*, as to represent the *relative* or *subjunctive pronoun*; as in this doggerel translation of a line from Virgil,

*And corn doth grow WHERE Troy town stood*;

that is to say, *corn groweth in that place in WHICH Troy stood*, the power of the relative being implied in the adverb. It is in like manner, that the *relative pronoun* becomes an *interrogative*; as in this line from Milton,

*WHO first seduc'd them to that foul revolt?*

The reason of this is as follows: the *pronoun* and *adverbs* here mentioned are all, in their original character, *RELATIVES*. Even when they become interrogatives, they lose not this character, but are still relatives as much as ever: the difference is, that *without* an interrogation they have reference to a subject which is *antecedent, definite, and known*; *with* an interrogation, to a subject which is *subsequent, indefinite, and unknown*, and which it is expected the answer should express and ascertain. *WHO first seduc'd them?* The question itself supposes a seducer, to which, though *unknown*, the pronoun *who* has a reference—*Th' infernal serpent*. Here, in the answer, we have the subject, which was *indefinite, ascertained*; so that we see *WHO*, in the *interrogation*, is as much a *relative* as if it had been said originally, without any interrogation at all, *It was the infernal serpent who first seduced them*: and thus interrogatives and relatives mutually pass into one another.

Having thus considered all those parts of speech which are *SIGNIFICANT OF THEMSELVES*, we proceed to those *AUXILIARY PARTS*, which are *ONLY SIGNIFICANT WHEN ASSOCIATED WITH OTHERS*, which we have already said are either *DEFINITIVES* or *CONNECTIVES*. Of which in their order.

### CHAPTER III.

#### Concerning *DEFINITIVES* commonly called *ARTICLES*.

THE knowledge of man is at best but limited and confined. Although we have invented words to denominate almost all the substances which exist, yet as it is impossible for any person to be acquainted with all of these, it was necessary to fall upon some contrivance in language to obviate the difficulties which would arise from this cause. With this view, we have already seen, that substances have been divided into general classes, each of which includes under it several lesser subdivisions; the names of which general classes, being but few, may be more easily retained, as *animal, edifice, motion*, &c. for by referring the several objects that we may accidentally see, and with which we are unacquainted, to the several classes to which they may belong, we are in some measure enabled to communicate our ideas without the know-

ledge of the particular names. But as this particular object must in some manner be distinguished from others of the same class to which it belongs, a particular class of words was found necessary to define and ascertain these individuals, which has given rise to this order of words of which we now treat, and which we have called *definitives*, because they serve to *define and ascertain any particular object, so as to separate it from the general class to which it does belong, and, of course, denote its individuality*. The principal of these definitives have been usually called **ARTICLES**, the nature of which may be explained as follows.

Supposing I see an object with which I am totally unacquainted, having a head and limbs, and appearing to possess the powers of self motion and sensation. If I know it not as an individual, I refer it to its proper species, and call it *a dog, a horse, a lion, or the like*; and if none of the names of any species with which I am acquainted fit it, I refer it to the genus, and call it *an animal*.

But this is not enough. The object at which we are looking, and want to distinguish, is perhaps an individual.—Of what kind? *Known or unknown? Seen now for the first time, or seen before and now remembered?* It is here we shall discover the use of the two articles **A** and **THE**; for the article **A** respects our *primary* perception, and denotes individuals as *unknown*; whereas **THE** respects our *secondary* perception, and denotes individuals as *known*. To explain this by an example, I see an object pass by which I never saw till then: What do I say? *There goes a beggar with a long beard*. The man departs, and returns a week after: What do I then say? *There goes the beggar with the long beard*. Here the article only is changed, the rest remains unaltered. Yet mark the force of this apparently minute change. The individual *once vague* is now recognized as *something known*, and that merely by the efficacy of this latter article, which tacitly insinuates a kind of *previous acquaintance*, by referring a present perception to a like perception already past. Hence therefore we see, that although the articles **A** and **THE** are both of them *definitives*, as they circumscribe the latitude of genera and species, by reducing them, for the most part, to denote individuals; yet they differ in this respect, that the article **A** leaves the individual itself *unascertained*, but the article **THE** *ascertains the individual also*, and is for that reason the more accurate definitive of the two. They differ likewise in this respect, that as the article **A** serves only to separate one particular object from the general class to which it belongs, it cannot be applied to plurals. But as the article **THE** serves to define objects, or refer to them as already known, without relation to number, or any other circumstances, it is applicable to both numbers indiscriminately, as well as nouns of every gender, without suffering any sort of change; for it is evident, that no variation of the nature of the noun can make any difference in those words which serve to define or denote a certain reference to them. So that although we find some modern languages which admit of a variation of their article, which relates to the gender of the noun with which it is associated, yet this cannot be considered

as essential to this species of words: and so far is this from being an improvement to the language, that it only serves to perplex and confuse, as it always presents a particular idea of *sex*, where in many cases it is not in the least necessary.

Of all the parts of speech which may be considered as essential to language, there is none in which we find so many languages defective as in this. For we know of no language, except our own, which has the particular article **A**; and the Latin language has no word of the same import with the word **THE**. The reason of which deficiency is, that as other parts of speech may be so easily converted from their original meaning, and be made to assume the character of definitives, they have made some of these perform both of these offices; and as the article **A** only separates a particular object, and is therefore so nearly allied to a *numeral*, many languages, as the *French, Italian, Spanish, and German*, have made the numeral word **ONE** supply its office, while others, as the *Greek*, have denoted this particular object by a mere negation of the other article; and as the article **THE** agrees with pronouns in this respect, that they both *denote reference*, the Latins made their pronoun, by a forced periphrasis, supply the place of this. But all of these methods of supplying the want of the genuine article are defective, as will appear more particularly by and by.

As articles are by their nature definitives, it follows of course, that they cannot be united with such words as are in their own nature *as definite as they may be*; nor with such words which, *being indefinite, cannot properly be made otherwise*; but only with those words which, *tho' indefinite, are yet capable, through the article, of becoming definite*. Hence we see the reason why it is absurd to say **THE I**, or **THE THOU**, because nothing can make these pronouns more *definite* than they are; and the same may be said of proper names. Neither can we say **THE BOTH**, because these words are *in their own nature each of them perfectly defined*. Thus, if it be said, "I have read **BOTH** poets," this plainly indicates a *definite pair*, of whom some mention has been made already. On the contrary, if it be said, "I have read **TWO** poets," this may mean *any pair* out of all that ever existed. And hence this numeral, being in this sense *indefinite*, (as indeed are all others as well as itself,) is forced to *assume the article* whenever it would become *definite*. Hence also it is, that as **TWO**, when taken alone, has reference to some *primary* and *indefinite* perception, while the article **THE** has reference to some perception *secondary* and *definite*, it is bad language to say **TWO THE MEN**, as this would be *blending of incompatibles*, that is to say, of a *defined substantive* with an *undefined attributive*. On the contrary, to say **BOTH THE MEN**, is good and allowable; because the substantive cannot possibly be less apt, by being defined, to coalesce with an attributive which is defined as well as itself. So likewise it is correct to say, **THE TWO MEN**; because here the article, being placed at the beginning, *extends its power* as well through substantive as attributive, and equally tends to *define* them both.

As some of the words above admit of no article, be-  
cause

cause they are by nature as definite as may be; so there are others which admit it not, because they are not be defined at all. Of this sort are all INTERROGATIVES. If we question about substances, we cannot say THE WHO IS THIS; but WHO IS THIS? And the same as to qualities, and both kinds of quantities: for we say, without an article, WHAT SORT OF, HOW MANY, HOW GREAT? The reason is, the article THE respects beings already known, and interrogatives respect beings about which we are ignorant; for as to what we know, interrogation is superfluous. In a word, the natural associators with articles are ALL THOSE COMMON APPELLATIVES WHICH DENOTE THE SEVERAL GENERA AND SPECIES OF BEINGS. It is these, which, by assuming a different article, serve either to explain an individual upon its first being perceived, or else to indicate, upon its return, a recognition or repeated knowledge.

But although proper names do not admit of the article, being in their own nature definite; yet as these often fall into *homonymic*, that is, different persons often go by the same name, it is necessary to distinguish these from one another, to prevent the ambiguity that this would occasion. For this purpose we are obliged to have recourse to *adjectives* or *epithets*. For example, there were two *Grecian chiefs* who bore the name of *Ajax*; and was it not without reason that *Mnestheus* uses *epithets*, when his intention was to distinguish the one from the other: "If both *Ajaxes* cannot be spared, (says he) "at least let mighty *Telamonian Ajax* come." But as epithets are in their own nature perfectly indefinite, seeing the same adjective may be applied to infinite subjects, it is necessary to define these when we want to apply them to any particular object; so that it is necessary to endow these with an article, that they may have a reference to some single person only. And thus it is we say, *Trypho* THE *grammarian*, *Appolodorus* THE *Cyrenian*, &c. It is with reason, therefore, that the article is here also added, as it brings the adjective to an individuality as precise as the proper name. Even common appellatives, by the help of an article, come to have the force of proper names, without the assistance of any epithet whatever. Thus, in English, *city* is a name common to many places, and *speaker* a name common to many men. Yet if we prefix the article, THE *CITY* means our metropolis; and the THE *SPEAKER*, a high officer in the British parliament. And hence, by an easy transition, the article, from denoting reference, comes to denote eminence also; that is to say, from implying an ordinary pre-acquaintance, to presume a kind of general and universal notoriety. Thus, among the Greeks, THE *POET* meant *Homer*, and THE *STAGYRITE* meant *Aristotle*; not, but that there were many poets beside *Homer*, and many *Stagyrites* besides *Aristotle*, but none equally illustrious.

The articles already mentioned are those strictly so called; but, besides these, there are the PRONOMIAL ARTICLES, such as *this*, *that*, *any*, *some*, *all*, *other*, *none*, &c. Of these we have already spoken in the chapter upon pronouns, where we have shewn when they may be taken as pronouns, and when as articles. Yet, in truth, if the office of an article be to define and ascer-

tain, they are much more strictly articles than any thing else, and ought to be considered as such in universal grammar. Thus, when we say, "THIS picture I approve, but THAT I dislike;" what do we perform by the help of these definitives, but bring down the common appellatives to denote individuals? So when we say, "SOME men are virtuous, but ALL men are mortal;" what is the natural effect of this ALL and SOME, but to define that *universality* and *particularity* which would remain indefinite were we to take them away? The same is evident in such sentences as these: "SOME substances have sensation, OTHERS want it; choose ANY way of acting, and SOME men will find fault, &c." For here, SOME, OTHER, and ANY, serve all of them to define different parts of a given whole; SOME, to denote a definite part; ANY, to denote an indefinite; and OTHER, to denote the remaining part, when a part has been already assumed. Even the attributive pronouns, *my*, *thy*, *his*, *her's*, &c. are, in strictness, more properly articles than any thing else, seeing each of them serve only to define and ascertain the individual object to which they are applied. As when we say, "MY house is less commodious than YOUR'S; HER form is more elegant than HIS, &c." For in these examples what do the words MY and YOUR'S do, but ascertain two individual houses; or the words HIS and HER'S, but ascertain two individual forms, which are compared with one another? In the same manner we have already seen nouns sometimes lay aside their own proper character, and become definitives, as in the words ALEXANDER'S, CÆSAR'S, POMPEY'S, &c. which may be said to form so many NOMIAL ARTICLES. But of these we have spoken so fully in the chapter of nouns, that it is unnecessary to say more of them in this place.

Before we leave this subject, we shall produce one example to shew the utility of this species of words; which, although of themselves insignificant, and seemingly of small importance; yet, when properly applied, serve to make a few general terms be sufficient for the accurate expression of a great variety of particulars, and thus makes language capable of expressing things infinite, without wandering into infinitude itself.—To explain this, let the general term be MAN, which I have occasion to employ for the denoting of some particular. Let it be required to express this particular, as unknown; I say, A man:—Known; I say, THE man:—Definite; A CERTAIN man:—Indefinite; ANY man:—Present and near; THIS man:—Present and distant; THAT man:—Like like to some other; SUCH a man:—Different from some other; ANOTHER man:—An indefinite multitude; MANY men:—A definite multitude; A THOUSAND men:—The ones of a multitude, taken throughout; EVERY man:—The same ones, taken with distinction; EACH man:—Taken in order; FIRST man, SECOND man, &c.—The whole multitude of particulars taken collectively; ALL men:—The negation of that multitude; NO man:—A number of particulars present, and at some distance; THESE men:—At a greater distance, or opposed to others; THOSE men:—A number present and near; THESE men:—A number of individuals different from another number;

ber; OTHER men:—A great number of individuals taken collectively; MANY men:—A small number; FEW men:—A proportionally greater number; MORE men:—Smaller number; FEWER men:—And so on we might go almost to infinitude. But not to dwell longer upon this article, we shall only remark, “that minute changes in PRINCIPLES, lead to mighty changes in EFFECTS; so that PRINCIPLES are well entitled to regard, however trivial they may appear.

## CHAPTER IV. OF CONNECTIVES.

CONNECTIVES, according as they connect either sentences or words, are called by the different names of CONJUNCTIONS, or PREPOSITIONS. Of these names, that of the *preposition* is taken from a mere accident, as it commonly stands in connection before the part which it connects. The *conjunction*, as is evident, has reference to its *essential character*. We shall treat of these two separately.

### Section I. Of CONJUNCTIONS.

A CONJUNCTION is a part of speech void of signification itself, but so formed as to help signification, by making two or more significant sentences to be ONE significant sentence. As, therefore, it is the essence of a conjunction to connect sentences; at the same time that they do this, they must either connect their meaning or not. For example, let us take these two sentences, *Rome was enslaved,—Caesar was ambitious*, and connect them together by the conjunction BECAUSE; *Rome was enslaved, BECAUSE Caesar was ambitious*. Here the meanings, as well as the sentences, appear to be connected. But if I say, *manners must be reformed, OR liberty will be lost*; here the conjunction OR, though it join the sentences, yet, as to their respective meanings, is a perfect *disjunctive*. And thus it appears, that though all conjunctions conjoin sentences, yet, with respect to the sense, some are CONJUNCTIVE, and others are DISJUNCTIVE.

Those conjunctions which conjoin both sentences and their meanings are either COPULATIVES or CONTINUATIVES. The principal copulative in English is AND. The continuatives are much more numerous; IF, BECAUSE, THEREFORE, WHEREFORE, HENCE, THAT, &c. The difference between these is this: The copulative does no more than barely couple sentences, and is therefore applicable to all subjects whose natures are not incompatible: Continuatives, on the contrary, by a more intimate connection, consolidate sentences into one continuous whole; and are therefore applicable only to subjects which have an essential coincidence: For example, it is no way improper to say, *Lysippus was a statuary, AND Priscian a grammarian; the sun shineth, AND the sky is clear*; because these are things that may co-exist, and yet imply no absurdity. But it would be absurd to say, *Lysippus was a statuary,*

*BECAUSE Priscian was a grammarian*; though not to say, *the sun shineth BECAUSE the sky is clear*. The reason is, with respect to the first, the co-incidence is merely accidental: with respect to the last, it is essential, and founded in nature.

As to the continuatives, they are SUPPOSITIVELY, such as *if*; or POSITIVELY, such as *because, therefore, as, &c.* Take examples of each:—*You will live happily if you live honestly*:—*You live happily BECAUSE you live honestly*:—*You live honestly, THEREFORE you live happily*. The difference between these continuatives is this: The suppositives denote connection, but do not assert actual existence; the positives imply both the one and the other.

These positives above-mentioned are either CASUAL, such as *because, since, as, &c.* or COLLECTIVE, such as *therefore, wherefore, &c.* The difference between which is this: The casuals subjoin causes to effects; “*the sun is in eclipse BECAUSE the moon intervenes*.” The collectives subjoin effects to causes; “*the moon intervenes, THEREFORE the sun is in eclipse*.” We therefore use casuals in those instances where the effect being conspicuous we seek for its cause; and collectives, in demonstrations and science, properly so called, where the cause being first known, by its help we discern effects.

All these continuatives are resolvable into copulatives: For, instead of saying, *BECAUSE it is day, it is light*; we may say, *It is day, AND it is light*. Instead of *IF it is day, it is light*; we may say, *It is at the same time necessary to be day, AND to be light*. The reason is, That the power of the copulative extends to all connections, as well to the essential as to the casual. Hence the continuative may be resolved into a copulative and something more; that is to say, into a copulative implying an essential coincidence in the subjects conjoined.

As to casual conjunctions, we may further observe, that there is no one of the four species of causes which they are not capable of denoting. For example, the MATERIAL cause; *The trumpet sounds, BECAUSE it is made of metal*. The FORMAL; *The trumpet sounds, BECAUSE it is long and hollow*. The EFFICIENT; *The trumpet sounds, BECAUSE an artist blows it*. The FINAL; *The trumpet sounds, THAT it may rouse our courage*. It is worth observing, that the three first causes are expressed by the strongest affirmation; because, if the effect actually be, that must be also. But this is not the case with respect to the last, which is only affirmed as a thing that may happen. The reason is, That however this may be the end which set the artist first to work, it may still be beyond his power to obtain, and which, like all other contingents, may either happen or not. Hence also it is connected by a particular conjunction, THAT, absolutely confined to this cause.

We now come to the DISJUNCTIVE CONJUNCTIONS; a species of words which bear this contradictory name, because, while they DISJOIN the sense, they CONJOIN the sentences.

With respect to these, we may observe, that as there is a principle of UNION diffused through all things by which THIS WHOLE is kept together and preserved from dissolution; so there is, in like manner, a principle of DIS-

VERSITY diffused through all, the source of *distinction*, of *number*, and of *order*. Now, it is to express in some degree the *modifications of this diversity*, that *DISJUNCTIVE CONJUNCTIONS* seem at first to have been invented.

Of these *disjunctives*, some are *SIMPLE*, some *ADVERSATIVE*. *Simple*; as when we say, *EITHER it is day, OR it is night*:—*Adversative*; as when we say, *It is not day, BUT it is night*. The difference between these is, that the *simple* do no more than *merely* disjoin; the *adversative* disjoin with a concomitant *opposition*. Add to this, that the *adversative* are *definite*; the *simple* *indefinite*. Thus, when we say, *the number three is not an even number, BUT an odd*; we not only *disjoin* two opposite attributes, but we *definitely* affirm one, and deny the other. But when we say, *the number of the stars is EITHER even OR odd*; though we assert *one* attribute *to be*, and the other *not to be*, yet the alternative is notwithstanding left *indefinite*.

As to *adversative disjunctives*, it has been already said, that they imply *OPPOSITION*. Now, there can be no opposition of the *same* attribute in the *same* subject; as when we say, *Nereus was beautiful*: but the opposition must be either of the *same* attribute in different subjects, as when we say, "*Brutus was a patriot, BUT Cæsar was not*;" or of *different* attributes in the *same* subject, as when we say, "*Gorgius was a sophist, BUT not a philosopher*;" or of *different* attributes in *different* subjects, as when we say, "*Plato was a philosopher, BUT Hippias was a sophist*." The conjunctions used for all these purposes may be called *absolute* adversatives.

But there are *other* adversatives besides these; as when we say, "*Nereus was more beautiful THAN Achilles*;"—*Virgil was as great a poet AS Cicero was an orator*." The character of these latter is, that they go farther than the former, by marking not only *opposition*, but that *equality* or *excess* which arises from the comparison of subjects; and therefore they may be called *adversatives of comparison*.

Besides the adversatives here mentioned, there are two other species, of which the most eminent are *UNLESS* and *ALTHOUGH*: For example, "*Troy will be taken, UNLESS the Palladium be preserved*;" *Troy will be taken, ALTHOUGH Hector defend it*." The nature of these adversatives may be thus explained. As every *event* is naturally allied to its *cause*, so, by parity of reason, it is opposed to its *preventive*; and as every cause is either *adequate* or *inadequate*; (inadequate, when it endeavours, without being effectual), so in like manner is every *preventive*. Now, *adequate* preventives are expressed by such adversatives—as *UNLESS*: "*Troy will be taken, UNLESS the Palladium be preserved*;" that is, that this alone is *sufficient* to prevent it. The *inadequate* are expressed by such adversatives as *ALTHOUGH*: "*Troy will be taken, ALTHOUGH Hector defend it*;" that is, *Hector's* defence will prove *ineffectual*. These may be called adversatives *ADEQUATE* and *INADEQUATE*.

Before we leave this subject, we may observe, that the words *when* and *where*, and all others of the same nature, such as *whence*, *whither*, *when-er*, *where-er*, *etc.* may be called *ADVERBIAL* conjunctions; because they

participate the nature both of adverbs and conjunctions; of *conjunctions*, as they *conjoin* sentences; of *adverbs*, as they denote the attributes either of *time* or *place*. And these *adverbial* conjunctions (contrary to the character of *accusatory* words, which have strictly no signification but when associated with other words) have a kind of *obscure* signification when taken alone, by denoting these attributives of time and place. And hence it is, that they appear in grammar like *zephyres* in nature, a kind of middle beings, of amphibious character, which, by sharing the attributes of the higher and the lower, conduce to link the whole together.

## Section II. Of those Connectives, called PREPOSITIONS.

A *PREPOSITION* is a part speech devoid itself of signification, but so formed as to unite two words that are significant and that refuse to coalesce of themselves. This connective power (which relates to words only, and not to sentences) will be better understood by the following observations.

Some things naturally coalesce and unite of themselves, while others refuse to do so *without help*, and as it were by compulsion. For example, all quantities and qualities coalesce immediately with their substances: thus it is we say, *a fierce lion, a vast mountain, &c.* In like manner actions coalesce with their agents, and passions with their patients: thus it is we say, *Alexander conquers, Darius is conquered*. Nay, as every energy is a kind of medium between its agent and patient, the whole three, agent, energy, and patient, coalesce with the same facility; as when we say, *Alexander conquers Darius*. Farther than this, as the greatest part of attributives themselves may be characterised, as when we say of such attributives as *ran, beautiful, learned, &c.* "*he ran swiftly, she was very beautiful, he was moderately learned*" &c. these must readily coalesce with the attributes which they thus characterise. From all which it appears, that *those parts of speech unite of themselves in grammar whose original archetypes unite of themselves in nature*. Hence, therefore, it is, that although substances naturally coincide with their attributes, yet they absolutely refuse doing so one with another: and hence those known maxims in physics, that *body is impenetrable, that two bodies cannot possess the same place, &c.*

From these principles it follows, that when we form a sentence, the substance without difficulty coincides with the verb, from the natural coincidence of substance with energy; *the SUN WARMETH*: so likewise the energy with the subject on which it operates; *WARMETH the EARTH*: so likewise both substance and energy with their proper attributes; *the SPLENDID SUN GENIALLY WARMETH the FERTILE EARTH*. But suppose we are to add other substantives, as, for instance, *air*, or *heavens*; how could these coincide, or under what character be introduced? not either as the *energizer* of the verb, nor as the *subject on which it operates*; for both of these places are already filled up, the first by the word *SUN*, and the last by the substance *EARTH*: not as *attributes* to these last, or to any other thing; for attributes by na-

ture

ture they neither *are* nor *can be made*. Here, then, we perceive the rise and use of *prepositions*: by these we connect those substantives to sentences, which, at the time, are unable to *coalesce of themselves*. Let us assume, for instance, a pair of these connectives, *THROUGH* and *WITH*, and mark their effect upon the substances here mentioned; *the splendid sun WITH his beams geniallly warmth THROUGH the air the fertile curth*: the sentence, as before, remains entire and one; the substantives required are both introduced, and not a word which was there before is displaced from its proper situation.

It must be here observed, that *most* if not *all* prepositions seem originally formed to denote the relations of *place*; because this is that grand *relation* which *bodies* or *natural substances* maintain at all times to one another, whether they are contiguous or remote, whether in motion or at rest; thus we have prepositions to denote the *contiguous relation of body*; as when we say, *Crius walked WITH a staff*; *the statue stood UPON a pedestal*; *the river ran OVER a precipice*; others for the *detached relation*; as when we say, *He is going TO Italy*; *the sun is risen ABOVE the hills*; *these figs came FROM Turkev*: So as to *motion* and *rest*; only with this difference, that here the preposition varies its character with the verb: thus if we say, *that lamp hangs FROM the ceiling*, the preposition *FROM* assumes the character of *quiescence*: but if we say, *that lamp is falling FROM the ceiling*, the preposition assumes a character of *motion*. So in Milton;

—To support uneasy steps

OVER the burning marle—

Again,

—He with looks of cordial love

Hung OVER her enamur'd.—

In the first of these examples, *OVER* denotes *motion*, and in the last it denotes *rest*.

But though the original use of prepositions was to denote the relations of *place*, they could not be confined to this office only; but by degrees extended themselves to subjects *incorporeal*, and came to denote relations as well *intellectual* as *local*. Thus because, in *place*, he who is *above* has commonly the advantage of him who is *below*, we transfer *OVER* and *UNDER* to *dominion* and *obedience*: of a king we say, *he ruled OVER his people*; of a common soldier, *he served UNDER such a general*: so too we say, *WITH thought*; *WITHOUT attention*; *thinking OVER a subject*; *UNDER anxiety*; *FROM fear*; *OUT of love*; *THROUGH jealousy*, &c. All which instances, with many of the like kind, shew, that the *first* words of men, like their *first* ideas, had an immediate reference to *sensible objects*; and that, in after days, when they began to discern with their *intellect*, they took these words which they found already made, and transferred them, by *metaphor*, to *intellectual conceptions*. There is indeed no method to express new ideas, but

either by *metaphor*, or by *joining new words*; both which have been practised by philosophers, according to the nature and exigence of the occasion.

In the foregoing use of prepositions, we have seen how they are employed by way of *junta-position*; that is to say, where they are prefixed to a word without becoming a part of it: but they may be also used by way of *composition*; that is, they may be prefixed to a word so as to become a part of it: thus, to *UNDERstand*, to *FORget*, to *OVERact*, to *UNDERvalue*, to *OUTgo*, &c. are so many distinct words formed by prepositions joined intimately with some other word: in all which cases, the prepositions commonly transfuse something of their own meaning into the word with which they are compounded; and this imparted meaning in most instances, will be found referable into some of the relations of *place*, as used either in its *proper* or *metaphorical* acceptation.

BESIDES the above parts of speech, there is another, which cannot be comprehended under any of the foregoing classes, called *INTERJECTIONS*: of this kind are the words, *AH! ALAS! FIE! &c.* *This species of words coincide with no part of speech, but are either uttered alone, or else thrown into a sentence, without altering its form either in syntax or signification.* It may be therefore objected, that as we say, that all language is divided into the several parts above enumerated, and this class cannot be comprehended in any of these divisions; of course, the analysis that we have made cannot be just, because it does not comprehend the whole. To this objection it may be answered, that the language of which we have been treating, is that which has been formed by mutual compact, for the purposes of reasoning and speculation; that besides this artificial language, man, like every other sensitive animal, is endowed with a natural language, by which he can express any strong sensation. This language does not owe its characteristical expression to the arbitrary form of articulation; but derives its whole force from the tone of voice, and modification of countenance and gesture: and of consequence these tones and gestures express the same meaning without any relation to the articulation which they may assume, and are therefore universally understood by all mankind. Now, *interjection* is the name by which we distinguish these natural expressions: these cannot be properly called words, or parts of speech; but certain adventitious sounds, or voices of nature, expressing those passions and natural emotions which spontaneously arise in the mind upon the view or narrative of interesting events. We must, therefore, still conclude, that all language properly so called is composed of *words*, all of which may be arranged into the several classes above mentioned; and as a recapitulation of the whole that we have said, we subjoin the following table, which presents at one view the several classes and subdivisions of words.

**GRAMMONT**, a town of the Austrian Netherlands, in the province of Flanders, situated on the river Dender: E. long.  $3^{\circ} 50'$ , and N. lat.  $50^{\circ} 55'$ .

**GRAMPOUND**, a borough-town of Cornwall, thirty-eight miles south-west of Launceston: W. long.  $5^{\circ} 25'$ , and N. lat.  $50^{\circ} 20'$ . It sends two members to parliament.

**GRAMPUS**, in ichthyology. See **DELPHINUS**.

**GRANADA**, a province of Spain, bounded by Andalusia on the north, by Murcia and the Mediterranean on the east, by the same sea on the south, and by Andalusia on the west.

**GRANADA**, the capital city of the province of Granada in Spain, situated two hundred miles south of Madrid: W. long.  $3^{\circ} 40'$ , and N. lat.  $37^{\circ} 15'$ .

**GRANADA**, a province of Terra Firma, in South America, bounded on the north by the provinces of Carthagena and St Martha, on the east by Zeneguella, by Popoyan on the south, and by Darien on the west.

**GRANADA**, a city of Mexico, in North America, situated on the side of the lake Nicaragua: W. long.  $89^{\circ}$ , and N. lat.  $11^{\circ} 8'$ .

**GRANADA** is also the most southerly of the Caribbee-islands, situated one hundred and fifty miles south-west of Barbadoes: W. long.  $61^{\circ} 30'$ , and N. lat.  $12^{\circ} 15'$ .

**GRANADIER**, a soldier armed with a sword, a fire-lock, a bayonet, and a pouch full of hand granadoes. They wear high caps, are generally the tallest and bravest fellows, and are always the first upon all attacks.

Every battalion of foot has generally a company of granadiers belonging to it, or else four or five granadiers belong to each company of the battalion; which, on occasion, are drawn out, and form a company of themselves. These always take the right of the battalion.

**GRANADILLA**. See **PASSIFLORA**.

**GRANADILLOS**, some of the Caribbee-islands, situated between the island of St Vincent and Granada; but so inconsiderable, that no nation has thought them worth possessing.

**GRANADO**, a hollow ball or shell, of iron or other metal, about two inches and a half in diameter; which, being filled with fine powder, is set on fire by means of a small fusee, fastened to the touch-hole, made of the same composition as that of a bomb: as soon as the fire enters the shell, it bursts into many pieces, much to the damage of all that stand near.

**GRANARY**, a building to lay or store corn in, especially that designed to be kept a considerable time.

Sir Henry Wotton advises, to make it look towards the north, because that quarter is the coolest and most temperate. Mr Wollidge observes, that the best granaries are built of brick, with quarters of timber wrought in the inside, to which the boards may be nailed, with which the inside of the granary must be lined so close to the bricks, that there may not be any room left for vermin to shelter themselves. There may be many stories one above another, which should be near the one to the other; because the shallower the corn lies, it is the better, and more easily turned.

**GRAND JURY**, in English law, is the jury who find bills of indictment before justices of peace and goal-delivery, or of oyer and terminer, &c. against any offenders that may be tried for the fact.

**GRANDE**, a branch of the river Niger in Africa, which discharges itself into the Atlantic ocean, in  $15^{\circ}$  W. long. and  $11^{\circ}$  N. lat.

**GRANDE**, is also a river of Brasil, in the province of Del Rey, in South America, which discharges itself into the Atlantic ocean, in  $51^{\circ}$  W. long. and  $32^{\circ}$  S. lat.

**GRANDEE**, a designation given to a nobleman of Spain or Portugal.

The grandees are suffered to be covered before the king, who treats them like princes, styling them Illustrious, in his letters; and in speaking to them, or of them, they are styled Eminences.

**GRANDENTZ**, or **GRAUDENTZ**, a city of Poland, forty-two miles south of Dantzick: E. long.  $19^{\circ}$ , and N. lat.  $53^{\circ} 30'$ .

**GRANDPRE**, a town of Champaign, in France, thirty miles east of Rheims: E. long.  $4^{\circ} 56'$ , and N. lat.  $49^{\circ} 18'$ .

**GRANICUS**, a little river near the Hellespont, in the Lesser Asia, where Alexander fought the first battle with the forces of Darius.

**GRANITE**, in natural history, a distinct genus of stones, composed of separate and very large concretions rudely compacted together; of great hardness, giving fire with steel, not fermenting with acids, and slowly and imperfectly calcinable in a great fire.

Of this genus there are three species: 1. The hard white granite, with black spots, commonly called moor-stone: this is a very valuable kind, consisting of a beautiful congeries of very variously constructed and differently coloured particles, not diffused among or running in one another, but each pure and distinct, though firmly adhering to whichever of the others it comes in contact with, and forming a very firm mass: it is much used in London for the steps of public buildings, and on other occasions where great strength and hardness are required. 2. The hard red granite, variegated with black and white, and common in Egypt and Arabia. 3. The pale whitish-granite, variegated with black and yellow. This is sometimes found in strata, but more frequently in loose nodules, and is used for paving the streets.

**GRANIVOROUS**, an appellation given to animals which feed on corn or seeds. These are principally of the bird-kind.

**GRANT**, in law, a conveyance in writing of such things as cannot pass or be conveyed by word only; such are rents, reversions, services, &c.

**GRANTHAM**, a borough-town of Lincolnshire, twenty-two miles south of Lincoln. It sends two members to parliament.

**GRANVILLE**, a port town of Normandy, from whence the noble family of Carteret take the title of earl.

**GRANULATED**, something that has undergone granulation. See the next article.

**GRANULATION**, according to Cramer, is the reducing



cing metals to small particles, in order to promote their fusion and mixture with other bodies.

**GRAPE**, the fruit of the vine. See **VINE**.

**GRAPHOMETER**, a mathematical instrument, otherwise called a semi-circle, the use of which is to observe any angle whose vertex is at the centre of the instrument in any plane (though it is most commonly horizontal, or nearly so), and to find how many degrees it contains. See **GEOMETRY**, p. 696. and Plate XCV. fig. 14.

**GRAPNELS**, a sort of anchors with four flooks, serving for boats to ride by.

There is also a kind called fire and chain grapnels, made with four barbed claws instead of flooks, and used to catch hold of the enemy's rigging, or any other part, in order for boarding them.

**GRASS**, in botany, &c. a name given to several distinct plants; as, the agrostis, or couch grass; the briza, or quaking grass, &c. Under the term grass are also comprehended all manner of herbaceous plants serving for the food of cattle, as clover, rye-grass, &c.

**GRASSHOPPER**, in zoology. See **GRYLLUS**.

**GRATIOLA**, in botany, a genus of the diandria monogynia class. The corolla is irregular; the capsule has two cells; and the calix consists of seven leaves.

There are four species, none of them natives of Britain.

**GRATZ**, a city of Germany, and capital of the duchy of Stiria, sixty-five miles south of Vienna: E. long. 15° 55', and N. lat. 47° 20'.

**GRAVE**, in music, is applied to a sound, which is of a low or deep tone.

**GRAVE**, in geography, a strong city of the Netherlands, in the province of Dutch Brabant, eight miles south of Nimegueu: E. long. 5° 45', N. lat. 51° 50'.

**GRAVEL**, in natural history and gardening, a congeries of pebbles, which, mixed with a stiff loam, makes lasting and elegant gravel walks; an ornament peculiar to our gardens, and which gives them the advantage over those of other nations.

**GRAVEL**, in medicine. See **MEDICINE**.

**GRAVESEND**, a port-town of Kent, situated on the southern shore of the river Thames, twenty miles east of London.

**GRAVINA**, a city and bishop's see of the kingdom of Naples, twenty-seven miles south-west of Barri: E. long. 17°, and N. lat. 41°.

**GRAVITATION**. See **MECHANICS**.

**GRAVITY**. See **MECHANICS**.

*Specific GRAVITY*. See **HYDROSTATICS**.

**GRAY**, in geography, a city of Franche Compté in France, twenty-two miles north-west of Belançon: E. long. 5° 22', N. lat. 47° 30'.

**GREASE**, a swelling and gourdiness of the legs of a horse. See **FARRIERY**.

**GREECE**, the present Rumelia, and the ancient Helias, is situated between 20° and 26° E. long. and between 36° and 44° N. lat.

It reaches from the Adriatic sea eastward to the Archipelago, and is generally a healthy and fruitful country.

**GREEK**, or **GRECIAN**, any thing belonging to ancient Greece.

The Greek language, as preserved in the writings of the celebrated authors of antiquity, as Homer, Hesiod, Demosthenes, Aristotle, Plato, Xenophon, &c. has a great variety of terms and expressions, suitable to the genius and occasions of a polite and learned people, who had a taste for arts and sciences.

**GREEK BIBLE**. See **BIBLE**.

**GREEK CHURCH**. See **CHURCH**.

**GREEK MONKS AND NUNS**, of whatever order, consider St Basil as their founder and common father, and esteem it the highest crime to deviate in the least from his constitutions. There are several beautiful convents with churches, in which the monks perform divine service day and night. Some of the monks are cœnobites, or live together, wear the same habit, eat at the same table, and pursue the same exercises and employments.

**GREEN**, one of the original colours, exhibited by the rays of light. See **OPTICS**.

**GREEN**, among painters. See **BOTANY**, p. 634.

Gamboge will give five or six sorts of green with verdigrease. But the yellow, which some prefer before all others, is made of French berries; which is either deeper or fainter, according as the liquor is more or less stained by them. In like manner, a yellow, drawn from the roots of the barberry or mulberry, will answer the same purpose, being mixed with transparent verdigrease. As to verdigrease itself, it produces a fine bluish green, flows readily in the pencil, and may even serve as an ink to write with; but is subject to decay. Mountain-green is used for a grass colour. Verditer is a light green, seldom used but to colour landscapes that seem afar off. Sap-green is dark and dirty, and therefore never used but to shadow over greens in the darkest places. Copper-green is an excellent transparent and shining grass-green, if thickened in the sun shine, or over a gentle fire. It is the most used of any green in washing of prints or maps.

**GREEN-CLOTH**, a board, or court of justice, held in the compting-house of the king's household, composed of the lord steward, and officers under him, who sit daily. To this court is committed the charge and oversight of the king's household in matters of justice and government, with a power to correct all offenders, and to maintain the peace of the verge, or jurisdiction of the court royal; which is every way about two hundred yards from the last gate of the palace where his majesty resides.

It takes its name, *board of green cloth*, from a green cloth spread over the board where they sit.

Without a warrant first obtained from this court, none of the king's servants can be arrested for debt.

*Clerks of the GREEN CLOTH*, are two officers of the board of green cloth, who appoint the diet of the king and his household; and keep all records, ledgers and papers relating thereto; make up bills, parcels and debentures for salaries, and provisions and necessaries for the officers of the pantry, buttery, cellar, &c.

They

They also wait upon foreign princes when entertained by his majesty.

**GREEN FINCH**, in ornithology, the English name of the greenish fringilla, with the wings and tail variegated with yellow. See **FRINGILLA**.

**GREEN-HOUSE**, or conservatory, a house in a garden contrived for sheltering and preserving the most tender and curious exotic plants, which, in our climate, will not bear to be exposed to the open air during the winter season. These are generally large and beautiful structures, equally ornamental and useful.

**GREENLAND**, or *W:ß* **GREENLAND**, extends from the meridian of London to 50° W. long. and from 60° to 80° N. lat.

The Danes have some colonies here, and pretend to the property of the whole. However, the Dutch make very free with the fishery on this coast, notwithstanding the representations and even menaces of the Danes on that head.

**GREENWICH**, a town of Kent, situated on the southern shore of the Thames, five miles east of London; remarkable for its royal and magnificent hospital, erected for decayed or disabled seamen who have served their country, and for its palace and most delightful park.

On the top of a steep hill in the park, stands the royal observatory, built by Charles II. and furnished with all manner of instruments for astronomical observations, and a deep dry well for observing the stars by day.

**GREGARIOUS**, among zoologists, a term applied to such animals as do not live solitary, but in herds, flocks, or coveys.

**GREGORIAN CALENDAR**, that which shews the new and full moon, with the time of Easter, and the moveable feasts depending thereon, by means of epacts, disposed through the several months of the Gregorian year. See **ASTRONOMY**, p. 490.

**GREGORIAN YEAR**. See **ASTRONOMY**, p. 490.

**GRENOBLE**, a city of France, capital of Dauphiny, forty-five miles south-east of Lyons, and thirty-five miles south-west of Chamberry: E. long. 5° 28', and N. lat. 45° 12'.

**GRENOCK**, or **GREENOCK**, a port-town of Scotland, near the mouth of the river Clyde; being the principal station for the herring-fishery.

**GREWIA**, in botany, a genus of the gynandria polyandria class. The calix consists of five leaves; the petals are five; at the base of each petal there is a nectariferous scale; and the berry has four cells. There are two species, none of them natives of Britain.

**GREY**, or **GRAY**, a mixed colour partaking of the two extremes, black and white.

**GRIFFON**, in heraldry, an imaginary animal, feigned by the ancients to be half eagle and half lion; by this form they intended to give an idea of strength and swiftness joined together, with an extraordinary vigilance in guarding the things intrusted to its care. Thus the heathen naturalists persuaded the ignorant, that gold mines were guarded by these creatures with incredible watchfulness and resolution.

**GRIMPERG**, a city of Germany, in the circle of the

Lower Rhine, and earldom of Tiers: E. long. 6° 35', N. lat. 49° 40'.

**GRIMSBY**, a borough and port-town of Lincolnshire, situated at the mouth of the Humber: E. long. 4° N. lat. 53° 34'. It sends two members to parliament.

**GRINDING**, the reducing hard substances to fine powders.

*Method of GRINDING optic glasses.* Mr Huygens directs, in general, to make the breadth of the concave tool, plate, dish, or form, in which an object-glass must be ground, almost three times the breadth of the glass. Though in another place he speaks of grinding a glass whose focal distance was 200 feet, and breadth 8½ inches, in a plate only fifteen inches broad. But for eye-glasses, and others of lesser spheres, the tools must be broader in proportion to the breadth of these glasses, to afford room enough for the motion of the hand in polishing. Mr Huygens made his tools of copper, or of cast brass, which, for fear they should change their figure by bending, can hardly be cast too thick: however, he found by experience, that a tool fourteen inches broad, and half an inch thick, was strong enough for the forming glasses to a sphere of thirty-six feet diameter; when the tool was strongly cemented upon a cylindrical stone an inch thick, with hard cement made of pitch and ashes.

In order to make moulds for casting such tools as are pretty much concave, he directs, that wooden patterns should be turned in a lathe, a little thicker and broader than the tools themselves; but for tools that belong to spheres above twenty or thirty feet diameter, he says it is sufficient to make use of flat boards turned circular to the breadth and thickness required. When the plates are cast, they must be turned in a lathe exactly to the concavity required; and for this purpose it is requisite to make a couple of brass gages in the manner following, according to the directions of Mr Molyneux.

Take a wooden pole, a little longer than the radius of the spherical surface of the glass to be formed; and through the ends of it strike two small steel points, at a distance from each other equal to the radius of the sphere intended; and by one of the points hang up the pole against a wall, so that this upper point may have a circular motion in a hole or socket made of brass or iron, fixed firmly to the wall. Then take two equal plates of brass or copper, well hammered and smoothed, whose length is somewhat more than the breadth of the tool of cast brass, whose thickness may be about a tenth or a twelfth of an inch, and whose breadth may be two or three inches. Then having fastened these plates flat against the wall in a horizontal position, with the moveable point in the pole, strike a true arch upon each of them. Then file away the brass on one side exactly to the arch struck, so as to make one of the brass edges convex, and the other concave; and to make the arches correspond more exactly, fix one of the plates flat upon a table, and grind the other against it with emery. These are the gages to be made use of in turning the brass tools exactly to the sphere required.

**GRINDSTEAD**, or *East GRINDSTEAD*, a borough-town of Suffex, twenty-four miles directly south of London, which sends two members to parliament.

**GRIPSWALD**, a town of Germany, in the circle of Upper Saxony, and province of Swedish Pomerania, situated on a bay of the Baltic sea: E. long.  $13^{\circ} 40'$ , N. lat.  $54^{\circ} 15'$ .

**GRISONS**, allies of Switzerland; their country is almost of a circular form, about sixty miles over every way, and is bounded on the north by Tyrol and part of Switzerland; on the east, by Tyrol and Trent; on the south, by Italy; and by the Swiss cantons on the west.

**GRIST**, in country-affairs, denotes corn-ground, or ready for grinding.

**GROATS**, in country-affairs, oats after the hulls are off, or great oat-meal.

**GROCERS**, anciently were such persons as engrossed all merchandize that was vendible; but now they are incorporated, and make one of the companies of the city of London, which deals in sugar, foreign fruits, spices, &c.

**GROENLAND**, or **SPITZBERGEN**, a cold miserable country without inhabitants, and with very few animals or vegetables, situated between  $10^{\circ}$  and  $30^{\circ}$  E. long. and between  $77^{\circ}$  and  $82^{\circ}$  N. lat.

**GROGRAM**, a kind of stuff, made of silk and mohair.

**GRONINGEN**, the capital of a province of the same name, which makes one of the seven united provinces: E. long.  $6^{\circ} 40'$ , N. lat.  $53^{\circ} 20'$ .

**GRONOVIA**, in botany, a genus of the pentandria monogynia class. The petals are five, inserted along with the stamina into a bell-shaped calix; and the berry is dry, contains one seed, and situate below the flower. There is but one species.

**GROOM**, a name particularly applied to several superior officers belonging to the king's household, as groom of the chamber, groom of the stole. See **STOLE**, and **WARDROBE**.

**GROOM** is more particularly used for a servant appointed to attend on horses in the stable.

**GROOVE**, among miners, is the shaft or pit sunk into the earth, sometimes in the vein, and sometimes not.

**GROOVE**, among joiners, the channel made by their plough in the edge of a moulding, style, or rail, to put their pannels in, in wainscotting.

**GROSS-BEAK**, in ornithology. See **LOXIA**.

**GROSSULARIA**. See **RIBES**.

**GROTESQUE**, or **GROTESK**, in sculpture and painting, something whimsical, extravagant, and monstrous; consisting either of things that are merely imaginary, and have no existence in nature; or of things so distorted, as to raise surprize and ridicule.

**GROTSKA**, a city of Silesia, and capital of a duchy of the same name, thirty miles south of Breslaw: E. long.  $17^{\circ}$ , N. lat.  $50^{\circ} 40'$ .

**GROTTO**, a large deep cavern or den in a mountain or rock.

Of these we find several remarkable ones in different parts of the world. The most celebrated one of our own country, is that called Oukley-hole, on the

south side of Mendip-hills. Its length is about two hundred yards, and its height various; being in some places very low, and in others eight fathoms. There is another at Puzzoli, about four leagues from Naples, called the Dog's Grotto; because a dog thrown into it is immediately killed, by a destructive vapour equally fatal to all animals within its reach. The milky grotto, *crypta lactea*, about a mile from the ancient village of Bethlehem, is said to have been thus called from the holy virgin's letting fall some drops of her milk in it; on which account the earth of this cavern has been supposed to possess the virtue of restoring women's milk.

**GROTTO** is also used for a small artificial edifice made in a garden, in imitation of a natural grotto.

The outsides of these grottos are usually adorned with rustic architecture, and their inside with shell-work, coral, &c. and also furnished with various fountains, and other ornaments.

The following is recommended as a good cement for grotto-work. Take two parts of white rosin, melt it clear, add to it four parts of bees-wax; when melted together, add some flower of the stone you design to cement, two or three parts, or so much as will give the cement the colour of the stone; to this add one part of the flower of sulphur: first incorporate all together over a gentle fire, and afterwards knead it with your hands in warm water. With this fasten the stones, shells, &c. after they are well dried, and warmed before the fire.

**GROVE**, in gardening, a small wood impervious to the rays of the sun.

Groves are not only great ornaments to gardens, but are also the greatest relief against the violent heats of the sun, affording shade to walk under in the hottest parts of the day, when the other parts of the garden are useless.

**GROUND**, in agriculture, is much the same with earth or soil. See **AGRICULTURE**, p. 50.

**GROUND-IVY**, in botany. See **GLECHOMA**.

**GROUND-PINE**, in botany. See **TEUCRIUM**.

**GROUP**, in painting and sculpture, is an assemblage of two or more figures of men, beasts, fruits, or the like, which have some apparent relation to each other.

**GROUSE**, or **GROWSE**. See **TETRAO**.

**GRUBS**, in medicine, certain unctuous pimples arising in different parts of the face, but chiefly in the alez of the nose.

**GRUBBING**, in agriculture, the digging or pulling up the stubs and roots of trees.

**GRUBENHAGEN**, a town and castle of Lower Saxony, and duchy of Brunswic, remarkable for its mines of silver, copper, iron, and lead: E. long.  $9^{\circ} 36'$ , and N. lat.  $51^{\circ} 45'$ .

**GRUME**, in medicine, denotes a concreted clot of blood, milk, or other substance. Hence grumous blood is that which approaches to the nature of grume, and by its viscosity, and stagnating in the capillary vessels, produces several disorders.

**GRUMOSE roots**, such as are knotty, and fastened to one head, like those of celandine and anemonies

**GRUS**,

**GRUS**, in ichthyology. See **ARDEA**.

**GRYLLUS**, in zoology, the name of the cricket and locust kind, which, together with the grasshoppers, make only one genus of insects, belonging to the order of hemiptera: the characters of which are these: the antennæ are setaceous and filiform; the exterior wings are membranaceous, narrow, and have much of the appearance of the wings of some of the fly kind; the thorax is compressed and angulated; and the legs are formed for leaping. There are no less than 64 species. See Plate LXXXVI. fig. 3. 4. 5.

**GRYPHITES**, in natural history, an English crow's stone, an oblong fossil shell, very narrow at the head, and becoming gradually wider to the extremity, where it ends in a circular limb; the head or beak of this is very hooked or bent inward.

**GUADALAJARA**, a city of Mexico, in North America, and the capital of Guadalupe, or New Galicia: W. long. 108°, and N. lat. 20° 45'.

**GUADALAVIAR**, a river of Spain, which rises in the province of Arragon, and runs south-east through the province of Valencia, falling into the Mediterranean a little below the city of Valencia.

**GUADALAXARA**, a city of Spain, in the province of New Castile, twenty eight miles north-west of Madrid: W. long. 2° 50', and N. lat. 40° 40'.

**GUADALUPE**, one of the largest of the Caribbee-islands, eighty miles north of Martinico, subject to France: W. long. 61°, and N. lat. 16° 30'.

**GUADIANA**, a river of Spain, which rises in the middle of New Castile, and running through Estremadura, enters Portugal; where, passing through the provinces of Alentejo and Algarva, it discharges itself into the Atlantic ocean.

**GUADILBARBAR**, a river of Africa, which rises in the mountains of Atlas, runs through the kingdom of Tunis, and falls into the Mediterranean sea near Bona.

**GUADILQUIVIR**, a river of Spain, which rises in the mountains of Segura in New Castile, runs the whole length of Andalusia, and passing by Cordova and Seville falls into the Atlantic ocean at St Lucar.

**GUADIX**, a city of Spain, in the province of Granada: W. long. 3°, and N. lat. 37° 15'.

**GUAJACUM**, in botany, a genus of the decandria-monogynia class. The calix consists of five unequal segments; the petals are five, and inserted into the calix; and the capsule is angular, and has from three to five cells. There are three species, all natives of the Indies.

The wood is very ponderous, of a close compact texture; the outer part is of a yellow colour, the heart of a deep blackish green, or variegated with black, green, pale, and brown colours: the bark is thin, smooth, externally of a dark greyish hue: both have a lightly aromatic, bitterish, pungent taste. The bark is somewhat the weakest. The resin (which exudes from incisions made in the trunk of the tree) is brought to us in irregular masses, usually friable, of a dusky greenish, and sometimes of a reddish cast, with pieces of the wood among them: its taste is more acrid and pungent than that of the wood or bark.

Their general virtues are those of a warm, stimulating medicine: they strengthen the stomach and other viscera; and remarkably promote the urinary and cuticular discharge: hence in cutaneous defecations, and other disorders proceeding from obstructions of the excretory glands, and where sluggish serous humours abound, they are eminently useful: rheumatic and other pains have often been relieved by them. The resin is the most active of these drugs; and the efficacy of the others depends upon the quantity of this part contained in them: the resin is extracted from the wood in part by watery liquors, but much more perfectly by spiritous ones; the watery extract of this wood, kept in the shops, proves not only less in quantity, but considerably weaker than one made with spirit. This last extract is of the same quality with the native resin, and differs from that brought to us only in being purer. The gum, or extracts, are given from a few grains to a scruple or half a dram; which last dose proves for the most part considerably purgative.

**GUALEOR**, a city of the Hither India, and the capital of the province of Gualeor, situated forty miles south of Agra: E. long. 79°, and N. lat. 26°.

**GUAM**, the chief of the Ladrone-islands, in the Pacific ocean: E. long. 140°, and N. lat. 14°.

**GUANIHANI**, or **St SALVADOR**, now called **Cattisland**, one of the Bahama islands in the Atlantic ocean, in North America: W. long. 76°, N. lat. 24°.

**GUANUCO**, a town of Peru, in South America, one hundred and eighty miles north-east of Lima: W. lon. 75° 15', and S. lat. 10°.

**GUARANTY**, in matters of polity, the engagement of mediatorial or neutral states, whereby they plight their faith, that certain treaties shall be inviolably observed, or that they will make war against the aggressor.

**GUARD**, in a general sense, signifies the defence or preservation of any thing; the act of observing what passes, in order to prevent surprize; or the care, precaution, and attention, we make use of, to prevent any thing happening contrary to our intention or inclinations.

**GUARD**, in the military art, is a duty performed by a body of men, to secure an army or place from being surprized by an enemy.

*Advanced GUARD*, is a party of either horse or foot, that marches before a more considerable body, to give notice of any approaching danger.

*Artillery GUARD*, is a detachment from the army, to secure the artillery: their corps de garde is in the front, and their centres round the park. This is a forty-eight hours guard: and upon a march, they go in the front and rear of the artillery, and must be sure to leave nothing behind; if a gun or waggon break down, the captain is to leave a part of his guard to assist the gunners and matrosses in getting it up again.

*Corps de GARDE*, are soldiers entrusted with the guard of a post, under the command of one or more officers.

*Forrage-GUARD*, a detachment sent out to secure the forragers, which are posted at all places, where either the enemy's party may come to disturb the forragers, or where they may be surprized too near the enemy, so

- as to be in danger of being taken. They consist both of horse and foot, and must stay at their posts till the foragers all come off the ground.
- Grant GUARD**, three or four squadrons of horse, commanded by a field officer, posted at about a mile and a half from the camp, on the right and left wings, towards the enemy, for the security of the camp.
- Main GUARD**, that from whence all the other guards are detached.
- Picquet-GUARD**, a good number of horse and foot always in readiness in case of an alarm: the horse are all the time saddled, and the riders booted. The foot draw up at the head of the battalion, at the beating of the tattoo; but afterwards return to their tents, where they hold themselves in readiness to march, upon any sudden alarm. This guard is to make resistance, in case of an attack, till the army can get ready.
- Quarter-GUARD**, a small guard, commanded by a subaltern officer, posted by each battalion, about an hundred yards before the front of the regiment.
- Rear-GUARD**, that part of the army which brings up the rear, which is generally the old grand-guards of the camp. The rear-guard of a party is six or eight horse, that march about four or five hundred paces behind the party. The advanced-guard of a party on its going out, make the rear-guard on its return.
- Standard-GUARD**, a small guard, under a corporal, out of each regiment of horse, and placed on foot, in the front of each regiment.
- Van-GUARD**, that part of the army which marches in the front.
- GUARD** is more particularly understood of a soldier detached from a company or corps, to protect, detain, or secure any person, &c.
- GUARDS**, are also troops kept to guard the king's person, called also royal-guards, life-guards, gardes du corps, &c. These are distinguished into horse, foot, grenadiers, and yeomen.
- The English horse-guards are distinguished by troops, and the foot-guards by regiments.
- Yeomen of the GUARDS**. See **YEOMAN**.
- The **French GUARDS** are divided into those within, and those without the palace: the first consists of the guards du corps, or body-guard, which consists of four companies of horse, the first of which companies was anciently Scotch, and still retains the name, though it now consists wholly of Frenchmen. The guards without, are the gens d'armes, light horse, musqueteers, and two other regiments, the one of which is French and the other Swiss. See **GENDARMES**.
- GUARD**, in fencing, is a posture proper to defend the body from an enemy's sword.
- GUARDIAN**, in law, a person who has the charge of any thing; but more commonly it signifies one who has the custody and education of such persons as have not sufficient discretion to take care of themselves and their own affairs, as children and idiots.
- GUBEN**, a town of Germany, in the circle of Upper Saxony: E. long. 15°, and N. lat. 51° 50'.
- GUDGEON**, in ichthyology. See **GOBIOUS**.
- GUENGA**, a great river of the Hither India, which rising in the mountains of Balagate, runs north-east, and falls into the west branch of the river Ganges in Bengal.
- GUERET**, a town of France, in the province of Lionois: E. long. 2°, and north lat. 46° 5'.
- GUERNSEY**, or **GARNSEY**, an island in the English channel, on the coast of Normandy, fifty-eight miles south of Portland, in Dorsetshire, and twenty two west of cape la Hogue, in Normandy; about ten miles long and as many broad, containing ten parishes. The natives, who speak French, are still governed by the Norman laws, but are subject to England.
- GUIAQUIL**, a city and port-town of Peru, situated near the Pacific ocean: W. long. 80°, and S. lat. 3°.
- GUIARA**, a port-town on the Caracoa-coast, in Terra Firma, in South America: W. long. 66°, and N. lat. 10° 35'.
- GUIDON**, a sort of flag or standard, borne by the king's life-guards; being broad at one extreme, and almost pointed at the other, and slit or divided into two.
- GUIDON**, also denotes the officer who bears the guidon. He is the same in the horse-guards that the ensign is in the foot. The guidon of a troop of horse takes place next below a cornet.
- GUIENNE**, a province of France, bounded by the Orleanois on the north, by Gascoiny, from which it is separated by the river Garonne, on the south, by Languedoc on the east, and by the bay of Biscay on the west.
- GUILANDINA**, in botany, a genus of the decandria monogynia class. The calix consists of one leaf; the petals are inserted into the neck of the calix; and the capsule is angular, and contains from three to six cells. There are five species, none of them natives of Britain.
- GUILD**, a fraternity or company. As to the original of these guilds or companies, it was a law among the Saxons, that every freeman of fourteen years of age should find sureties to keep the peace, or be committed; upon which the neighbours enter into an association, and become bound for each other, either to produce him who committed any offence, or to make satisfaction to the injured party; in order to which they raised a sum among themselves, which they put into a common stock; out of which they, upon occasion, made a pecuniary compensation according to the quality of the offence committed. These guilds are now companies joined together with laws and orders made by themselves, by the licence of the prince.
- Dean of Guild**, in Scots law, a magistrate of a royal borough, who is head of the merchant-company. See **SCOTS LAW**, title 4.
- GUILDFORD**, or **GULDEFORD**, a borough-town of Surry, situated on the river Wye, thirty miles south-west of London. It sends two members to parliament.
- GUILLESTRE**, a city of France, in the province of Dauphiny: E. long. 6° 20', and N. lat. 44° 45'.
- GUINEA**, a large country of Africa, situated between 15° E. and 15° W. long and between 4° and 10° N. lat.

**1st.** The British, Dutch, French, and other nations, have forts and factories on this coast.  
**GUINEA** is also the name of a British gold coin, value 1 l. 1s. Sterling.

**GUINEA-PIG**, in zoology. See **MUS**.

**GUIPUSCOA**, the north-east division of the province of Biscay, in Spain, situated on the confines of Navarre in France.

**GUIRA**, or **GUARA GUAINUMBI**, in ornithology, the Brazilian name of the green *ispida*, with a crested head and very long tail.

**GUISE**, a town of France, in the province of Picardy, situated on the river Oyse: E. long 3° 36', and N. lat. 49° 55'.

**GUITAR**, **GUITARRA**, a musical instrument of the string-kind, with five double rows of strings, of which those that are bass are in the middle, unless it be for the burden, an octave lower than the fourth.

This instrument was first used in Spain, and by the Italians.

**GULA**, or **GOLA**, in architecture, a wavy member, the contour of which resembles the letter S, which the Greeks call *cymatium*, and our architects an *ogee*. See **ARCHITECTURE**.

**GULES**, in heraldry signifies the colour red, which is expressed in engraving by perpendicular lines falling from the top of the escutcheon to the bottom. See **Plate Cl. fig. 6**.

It is the first of all colours in armory, and was formerly prohibited to be worn by any person in his coat-armour, unless he were a prince, or had a permission from him. This colour is a symbol of charity, valour, and generosity, and represents blood colour, and true scarlet.

The Romans, according to Spelman, painted the bodies of their gods, and generals that triumphed, with vermilion; and under the consuls, their soldiers were clad in red; hence called *ruffati*. And we are told, that the Lacedemonians wore scarlet, to prevent seeing the blood issue from their wounds. Those who bear this colour are obliged to relieve such as are in danger of being oppressed by injustice.

**GULL**. See **LARUS**

**GULPH**, or **GULF**, in geography, a part of the sea, almost surrounded by lands, the gulph of Mexico, gulph of Venice, of Lyons, &c.

**GUM**, in pharmacy, a concreted vegetable juice, which transudes through the bark of certain trees, and hardens upon the surface.

**GUM ARABIC**. See **Gum ARABIC**.

**GUM SENECA**, is a gum extremely resembling gum arabic. It is brought to us from the country through which the river Senega runs, in loose or single drops, but these are much larger than those of the gum arabic usually are; sometimes it is of the bigness of an egg, and sometimes much larger: the surface is very rough, or wrinkled, and appears much less bright than the inner substance, where the masses are broken. It has no smell, and scarce any taste. We are not acquainted with the tree which produces it. The virtues of it are the same with the gum arabic; but it is rarely used

in medicine, unless as mixed with the gum arabic: the dyers and other artificers consume the great quantities of it that are annually imported here. The negroes dissolve it in milk, and in that state make it a principal ingredient in many of their dishes; and often feed on it thus alone.

**GUM TRAGACANTH**. See **TRAGACANTH**.

**GUM MANNA**. See **MANNA**.

Other substances known by the name of gums, are as follow.

**GUM ALOES**, a preparation of aloes, as set down in the London Dispensatory.

It is made thus: Take of succotrine aloes, four ounces; of water, a quart: boil the aloes till it is dissolved as much as may be; and set all by for a night: the resin will be precipitated to the bottom of the vessel; the liquor poured off and strained, being evaporated, will have the gum. The intention of this separation of the resin, is to procure, in the gum, a medicine less purgative, but more agreeable to the stomach, than the crude aloes.

**GUM AMMONIAC**. See **AMMONIAC**.

**GUM ELEMI**. See **ELEMI**.

**GUM GUIAIACUM**. See **GUIAIACUM**.

**GUM LACCA**. See **LACCA**.

**GUMS**, in anatomy, See **ANATOMY**, p. 305.

**GUN**, a fire arm, or weapon of offence, which forcibly discharges a ball, shot, or other offensive matter, thro' a cylindrical barrel, by means of gun-powder. See **GUN-POWDER**.

Gun is a general name, under which are included divers or even most species of fire-arms. They may be divided into great and small.

Great guns, called also by the general name cannons, make what we also call ordinance, or artillery; under which come the several sorts of cannons, as cannon-royal, demi-cannon, &c. Culverins, demi-culverins, sakers, minions, falcons, &c. See **CANNON**.

Small guns include musquets, musquetoons, carabines, blunderbusses, fowling-pieces, &c. See **MUSQUET**, &c.

Pistols and mortars are almost the only sort of regular weapons, charged with gun-powder, that are excepted from the denomination of guns. See **PISTOL** and **MORTAR**.

The advantage of large guns, or cannons, over those of a smaller bore, is generally acknowledged. Robins observes, that this advantage arises from several circumstances, particularly in distant cannonading. The distance to which larger bullets fly with the same proportion of powder, exceeds the flight of the smaller ones, almost in proportion to their diameters; so that a thirty two pound shot, for instance, being somewhat more than six inches in diameter, and a nine pound shot but four inches; the thirty-two pound will fly near half as far again as that of nine pound, if both pieces are so elevated as to range to the farthest distance possible. Another and more important advantage of heavy bullets is, that with the same velocity they break holes in all solid bodies, in a greater proportion than their weight.

weight. Finally, large cannons, by carrying the weight of their bullet in grape or lead-shot, may annoy the enemy more effectually than could be done by ten times the number of small pieces. See GUNNERY.

The author here quoted, has proposed to change the fabric of all the pieces employed in the British navy, from the twenty four pounders downwards, so that they may have the same or less weight, but a larger bore. He thinks the thirty-two pounders in present use would be proper models for this purpose. These being of fifty-two or fifty-three hundred weight, have somewhat less than a hundred and two thirds for each pound of bullet. And that this proportion would answer in smaller pieces, in point of strength, seems clear from these considerations: 1. That the strength of iron or any other metal, is in proportion to its substance. 2. That the lesser quantity of powder fired in a space it fills, has proportionably less force than a larger quantity; so that if two pieces, a large and a small one, be made in the same proportion to their respective bullets, and fired with a proportionable quantity of powder, the larger piece will be more strained, will heat more, and recoil more than the smaller.

On this scheme our present twenty-four pounders will be eased of six or eight hundred weight of useless metal; and some pieces of a less caliber, as nine and six pounders, would be sometimes eased by fourteen hundred: hence much larger guns of the same weight might be borne. Thus, instead of six, nine, twelve, and eighteen pounders, our ships might carry twelve, eighteen, and twenty-four pounders: guns would be kept cooler and quieter, and would be of more service, in many respects, if their usual charge of powder were diminished.

**GUNELLUS**, in ichthyology. See **BLENNIVS**.

**GUNNER**, an officer appointed for the service of the cannon; or one skilled to fire the guns.

In the tower of London, and other garrisons, as well as in the field, this officer carries a field-staff, and a large powder-horn in a string over his left shoulder: he marches by the guns; and when there is any apprehension of danger, his field-staff is armed with match: his business is to lay the gun to pass, and to help to load and traverse her.

**Master-GUNNER**, a patent-officer of the ordnance, who is appointed to teach all such as learn the art of gunnery, and to certify to the master general the ability of any person recommended to be one of the king's gunners. To every scholar he administers an oath, not to serve, without leave, any other prince or state; or teach any one the art of gunnery, but such as have taken the said oath.

**GUNNERY**, is the art of charging, directing, and exploding fire-arms, as cannons, mortars, muskets, &c. to the best advantage.

To the ART of GUNNERY belongs the knowledge of the force and effects of gun-powder, (see GUN POWDER), the dimensions of cannon, &c. and the proportion of the powder and ball they carry, with the

method of *managing, charging, pointing, spunging, &c.*

A cannon is a military engine, or fire-arm, for throwing iron, lead, or stone bullets, by force of gun-powder, to a place exactly opposite to the axis of the cylinder whereof it consists.

Cannons are made cylindrical, that the motion of the ball might not be retarded in its passage; and that the powder, when on fire, might not slip between the ball and the surface of the cannon, which would hinder its effect. With regard to the names, dimensions, weight, &c. of cannons, see **CANNON**.

Each sort of ordnance is more or less fortified; which fortification is reckoned by the thickness of the metal at the touch-hole, at the trunnions, and at the muzzle, in proportion to the diameter of the bore.

There are three degrees used in fortifying each sort of ordnance, both cannons and culverines: First, such as are ordinarily fortified, which are called legitimate pieces; secondly, such whose fortifications are lessened, which are called bastard pieces; thirdly, double fortified pieces, or extraordinary pieces.

The cannons double fortified have full one diameter of their bore in thickness of metal at their touch-hole, and  $\frac{1}{2}$  at their trunnions, and  $\frac{1}{3}$  at their muzzle. The lessened cannons have, at their touch-hole, but  $\frac{1}{2}$  or  $\frac{1}{3}$  of the diameter of their bore in thickness of metal, and  $\frac{1}{3}$  at their trunnions, and  $\frac{1}{4}$  at their muzzle. The ordinary fortified cannons, have  $\frac{1}{3}$  at the touch hole,  $\frac{1}{4}$  at the trunnions, and  $\frac{1}{5}$  at the muzzle. All the double fortified culverines, and all lesser pieces of that kind, have one diameter and  $\frac{1}{2}$  at the touch-hole,  $\frac{1}{3}$  at the trunnions, and  $\frac{1}{4}$  at the muzzle. And all the ordinary fortified culverines, are fortified every way as the double fortified cannons; and the lessened culverines, as the ordinary cannons in all points.

With regard to bullets, or balls, wherewith cannons are loaded, they are of various kinds, viz. 1. Red-hot bullets, intended to set fire to places, where combustible matters are found. The bullet is made red-hot, by digging a place in the earth, and lighting in it a great quantity of charcoal, or sea coal, and placing over it a strong iron grate. When the fire is well lighted, the bullets are placed on the grate, where, in a very short time, they grow red hot; they are taken out with tongs, or iron ladles for the purpose, and carried into the piece; having before put some clay over the powder the cannon is loaded with, lest it should be set on fire by the red hot bullet: then the piece is fired. Where-ever the bullet passes, and meets with combustible matters, it sets them on fire. But when a trench is before the battery of red-hot bullets, hay is rammed over the powder; because, if it was clay, the pieces of it would wound and kill the workmen.

Red-hot bullets are never fired but with eight or four pounders. For if they were of a stronger caliber, the bullets could not be served easily.

2. Hollow bullets are shells made cylindrical, with an aperture and fusee at one end, which giving fire to the inside, when in the ground, it bursts, and has the same effect with a mine;

3. Chain

3. Chain-bullets consist of two balls joined by a chain, three or four foot a part.

4. Branch bullets are two balls joined by a bar of iron, five or six inches a-part.

5. Two-headed bullets, called also angels, being two halves of a bullet, joined by a bar or chain: these are chiefly used at sea, for cutting of cords, cables, sails, &c.

As bullets, as well as the pieces of ordnance, are of different caliber, which caliber, in a piece of ordnance, is the diameter of the mouth thereof; and in a bullet, its circumference; there are means found to proportion these two calibers to one another, *viz.* with an instrument called a caliber-rule, wherein a right line is so divided, as that the first part being equal to the diameter of an iron or leaden ball of one pound weight, the other parts are to the first, as the diameters of balls of two, three, four, &c. pounds, are to the diameter of one ball of one pound.

The caliber consists of two thin pieces of brass, six inches long, joined by a rivet, so as to move quite round each other: the head, or one end of the piece, is cut circular, and one half of its circumference divided into every second degree. On the other half are divisions from one to ten; each again subdivided into four: the use of which divisions and subdivisions, is when the diameter of a bullet, &c. not exceeding ten inches, is taken, the diameter of the semicircle will, among the divisions, give the length of the diameter, taken between the points of the calibers, in inches and fourth parts.

The degrees on the head serve to take the quantity of an angle, the method of which is obvious. If the angle be inward, apply the outward edges to the planes that form the angle; the degree cut by the diameter of the semicircle, shews the quantity of the angle sought. For an outward angle, open the branches till the points be outward, and applying the straight edges to the planes that form the angle, the degrees cut by the diameter of the semicircle shew the angle required; reckoning from 180 towards the right hand.

On one branch of the calibers, on the same side, are, first, six inches; and each of these subdivided into ten parts. Secondly, a scale of unequal divisions, beginning at two, and ending at ten, each subdivided into four parts. Thirdly, two other scales of lines, shewing, when the diameter of the bore of a piece is taken with the points of the calibers outwards, the name of the piece, whether of the iron or brass, *i. e.* the weight of the bullet it carries, or that it is such or such a pounder, from one to forty-two pounds.

On the other branch of the calibers, on the same side, is a line of cords to about three inches radius; and a line of lines on both branches, as on the sector; with a table of the names of the several pieces of ordnance. On the same face is a hand graved, and a right line drawn from the finger towards the centre of the river, shewing, by its cutting certain divisions made on the circle, the weight of an iron shot, when the diameter is taken by the points of the calibers. Lastly, on the circle or head, on the same side, are graved several geometrical figures, inscribed in each other, with numbers; as a cube, whose side is sup-

posed one foot; a pyramid on the same base or altitude, and the proportions of their weight, &c. a sphere inscribed in a cube; a cylinder, cone, circle, square, &c.

The outside of the caliber serves to take the diameter of the mouth of the piece; and the inside, called the heel, that of the bullet.

There is another method of taking the caliber of the pieces, which is to have a rule very well divided, on which are graved the calibers both of the pieces and bullets. That rule must be applied on the mouth of the piece, and the caliber is presently found.

Sometimes, in lieu of bullets, the pieces are charged with cartouches, which are cases loaded with musket-balls, nails, chains, and pieces of old iron; sometimes, also, with small cannon-balls. See Plate XCVIII.

There are cartouches made in form of grapes, which are musket-balls joined together with pitch, and disposed on a small board, in a pyramidal form round a wooden stick, which arises from the middle of the board. (*ibid.*)

The cartouches made of tin are the best, because they carry further.

There are also cartouches made in form of pine-apples, whose figure is pyramidal. Their base is equal to the caliber of a bullet, proposed for the piece they are to be fired with; their height is of a caliber and a half; they are dipped in tar, and afterwards rolled on musket-balls, and when well covered with those balls, dipped again in the same tar, after which they may be used, thrusting the biggest foremost into the piece. These pine-apples are very good at sea, because, besides that the musket-balls flying about wound a great number of people, the bullet which is at the bottom of the cartouch does also much execution.

There are several sorts of carriages for ordnance, *viz.*: ballard carriages, with low wheels, and high wheels. Sea-carriages, made in imitation of those for ship-guns: and carriages for field-pieces, of which there are two kinds

The carriages must be proportioned to the pieces mounted on them.—The ordinary proportion is, for the carriage to have  $1\frac{1}{2}$  of the length of the gun; the wheels to be half the length of the piece in height; four times the diameter or caliber, gives the depth of the planks the fore end, in the middle  $3\frac{1}{2}$ .

The piece thus mounted on its carriage, several instruments are employed, some to prepare the piece to be loaded, some to load it, others to point it, and others to cleanse it, &c. Those instruments have each their proper name, which are as follows:

The lantern or ladle (*ibid.*) which serves to carry the powder into the piece, and which consists of two parts. *viz.* of a wooden box, appropriated to the caliber of the piece for which it is intended, and of a caliber and a half in length with its vent; and of a piece of copper nailed to the box, at the height of a half caliber.

This lantern must have three calibers and a half in length, and two calibers in breadth, being rounded at the end to load the ordinary pieces.

The rammer, (*ibid.*) which is a round piece of wood, commonly called a box, fastened to a stick twelve foot long,



long, for the pieces from twelve to thirty three pounders; and ten for the eight and four pounders; which serve to drive home the powder and ball to the breech.

The sponge, (*ibid.*) which is a long staff or rammer, with a piece of sheep or lamb skin wound about its end, to serve for scouring the cannon when discharged, before it be charged with fresh powder; to prevent any spark of fire from remaining in her, which would endanger the life of him who should load her again.

Wad-screw, (*ibid.*) which are two points of iron turned serpent-wise, to extract the wad out of the pieces, when one wants to unload them, or the dirt which had chanced to enter into it.

The botefeux, (*ibid.*) which are sticks two or three feet long, and an inch thick, split at one end, to hold an end of the match twisted round it, to fire the cannon.

The priming iron, (*ibid.*) which is a pointed iron rod, to clear the touch-hole of the pieces of powder or dirt; and also to pierce the cartridge, that it may sooner take fire.

The primer, (*ibid.*) which must contain a pound of powder at least, to prime the pieces.

The quoins of mire, which are pieces of wood with a notch on the side to put the fingers on, to draw them back or push them forward, when the gunner points his piece. They are placed on the sole of the carriage.

Leaden plates, which are used to cover the touch-hole, when the piece is charged, lest some dirt should enter it and stop it.

Before you charge the piece, sponge it well, to clean it of all filth and dirt within-side; then the proper weight of gunpowder, which powder drive in and ram down; taking care that the powder be not bruised in ramming, which weakens its effect; run over it a little quantity of paper, hay, or the like; and then throw in the ball.

To point, level, or direct the piece, so as to play against any certain point, is done by the help of a quadrant with a plummet; which quadrant consists of two branches made of brass or wood; one about a foot long, eight lines broad, and one line in thickness; the other four inches long, and the same thickness and breadth as the former. Between these branches is a quadrant, divided into 90 degrees, beginning from the shorter branch, and furnished with thread and plummet.

Place the longest branch of this instrument in the cannon's mouth, and elevate or lower it till the thread cuts the degree necessary to hit the proposed object. Which done, prime the cannon, and then set fire to it.

To point a cannon well, so as to do the execution proposed, we must know the path of a bullet, or the line it describes, from the mouth of the piece to the point where it lodges, which path is commonly called range.

If the piece be laid in a line parallel to the horizon, it is called the right or level range; and if it be mounted to 45 degrees, the ball is said to have the utmost range, and so proportionably; all others between 00 degrees and 45, being called intermediate ranges.

A shot made when the muzzle of a cannon is raised above the horizontal line, and is not designed to shoot directly or point blank, is called random-shot.

The utmost random of any piece is about ten times as

far as the bullet will go point blank; and the bullet will go farthest when the piece is mounted to about 45 degrees above the level range.

Mr Norton observes, that

	Paces. Level.	Paces. Utmost Random.
A Basse shoots	60	600
A Rabinet,	70	700
A Falconet,	90	900
A Falcon,	130	1300
Minion ordinary	120	1200
Minion largest,	125	1250
Sacker least,	150	1500
Sacker ordinary,	160	1600
Sacker old fort,	163	1630
Demi-culverine least,	174	1740
Demi-culverine ordinary,	175	1750
Demi-culverine old fort,	178	1780
Culverine least,	180	1800
Culverine ordinary,	181	1810
Culverine largest,	183	1830
Demi-cannon least,	156	1560
Demi-cannon ordinary,	162	1620
Demi-cannon large,	180	1800
Cannon-royal,	185	1850

A 24 pounder may very well fire 90 or 100 shots, every day in summer; at 60 or 75 in winter. In case of necessity, it may fire more. And some French officers of artillery assure, that they have caused such a piece to fire every day 150 shots in a siege.

A 16 and a 12 pounder fire a little more, because they are easier served. There have even been some occasions, where 200 shots have been fired from these pieces, in the space of nine hours, and 138 in the space of five.

To range pieces in a battery, take care to reconnoitre well the ground where it is to be placed, and the road to convey it, in the night time, the cannon and the munitions.

The pieces must be armed, each with two lanterns, or ladles, a rammer, a sponge, and two priming-irons. The battery must also be provided with carriages, and other implements, necessary to remount the pieces which the enemy should chance to dismount.

To serve expeditiously and safely a piece in battery, it is necessary to have to each a sack of leather, large enough to contain about twenty pounds of powder to charge the lanterns or ladles, without carrying them to the magazine; and to avoid thereby making those trains of powder in bringing back the lantern from the magazine, and the accidents which frequently happen thereby.

A battery of 3 pieces must have 30 gabions, because six are employed on each of the two sides or epaulments, which make twelve, and nine for each of the two merlons.

There ought to be two gunners and six soldiers to each piece, and four officers of artillery.

The gunner, posted on the right of the piece, must take care to have always a pouch full of powder, and two priming-irons; his office is to prime the piece, and load

The Mouth or Caliber  
Cornish

The Muzzle  
Ring

The Frige

The Chancel

Trunnions

Ring

Trun

nions

Halfwidth

Ring

The field of

the Touch hole

Brass Ring  
The

Breach

12 Pounder

16 Pounder

Ladle

24 Pounder

33 Pounder

Capacated Deck

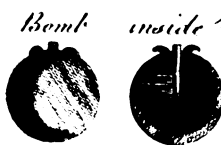
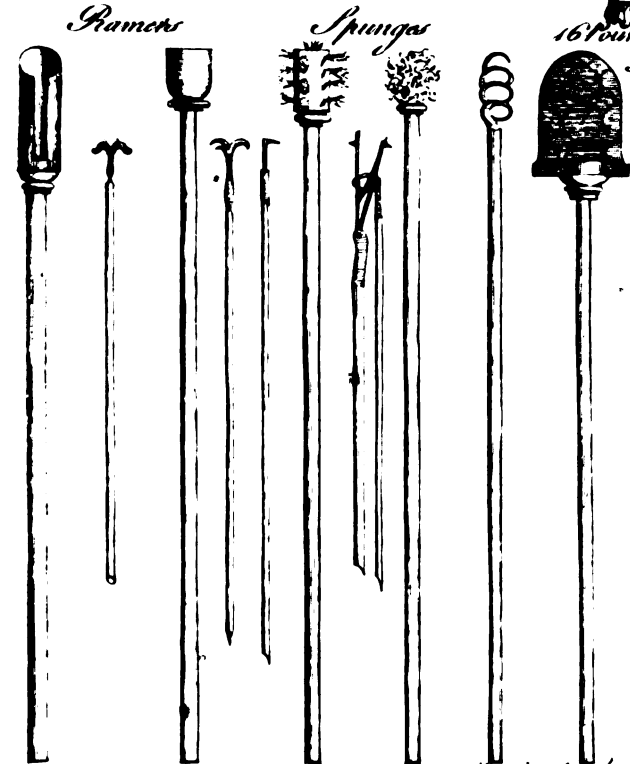
A Cannon mounted on  
its Carriage

A Mortar mounted  
on  
its Carriage

Pitard

Cartouches

The Inside of a Cannon  
Cham for the  
ber powder





it with powder. That on the left fetches the powder from the little magazine, and fills the lantern or ladle which his comrade holds; after which, he minds that the match be very well lighted, and ready to set fire to the piece at the first command of the officer.

There must be three soldiers on the right, and three on the left of the piece. The two first to take care to ram and sponge the piece, each on his side. The rammer and sponge must be placed on the left, and the lantern or ladle on the right. After having rammed well the wad put over the powder, and that put over the bullet, they then take each a handspike, which they pass between the foremost spokes of the wheel, the ends whereof will pass under the head of the carriage, to make the wheel turn round, leaning on the other end of the handspike, towards the embrasure.

It is the office of the second soldier on the right, to provide wad, and to put it into the piece, as well over the powder as over the bullet; and that of his comrade on the left, to provide 50 bullets, and every time the piece is to be charged, to fetch one of them and put it into the piece, after the powder has been rammed. Then they both take each an handspike, which they pass under the hind part of the wheel, to push it in battery.

The officer of artillery must take care to have the piece diligently served.

In the night he must employ the gunners and soldiers, who shall relieve those who have served 24 hours to repair the embrasures.

If there be no water near the battery, care must be taken to have a cask filled with it, to dip the sponges in it, and cool the pieces, every ten or twelve rounds.

The **MORTAR** is a short piece of ordnance, thick and wide, proper for throwing bombs, carcasses, shells, stones, &c.

There are chiefly two kinds of mortars: the one hung or mounted on a carriage with low wheels, after the manner of guns, called *pendent* or *hanging mortars*; the other fixed on an immoveable base, called *standing mortars*. (*ibid.*)

At the head of the bore, or chase of the mortar, is the chamber for the charge of the powder. This is usually made cylindrical, all but the base which they make hemispherical: though some of the later engineers prefer hemispherical chambers; as the surface of those being less, under equal capacities, make less resistance to the gun-powder.

The thickness of the mortar about the chamber, is to be much greater than about the chase, by reason the gun-powder makes a much greater effort about the chamber than elsewhere. The diameter of the chamber to be much less than that of the bore; by reason bombs, shells, &c. are much lighter than the bullets of equal diameters, and consequently less powder suffices.

The first mortar piece used for throwing stones, weighs commonly 1000 lb. and whose utmost range is 150 fathoms, loaded with two pounds of powder; it has 15 inches of diameter at its mouth, and 2 foot 7 inches in height.

The depth of its bore or chase is 1 foot 7 inches, and the depth of its chamber, without including the entrance

where the tampion is placed, 8 inches. The tourillons have 5 inches of diameter,

The chamber must enter an inch into the tourillons; the thickness of the metal about the chamber, 3 inches; the thickness of the belly, 2 inches; and the length of the chase, 1 inch and  $\frac{1}{2}$ ; about each ring, 1 inch and  $\frac{1}{2}$ .

Mortars, for throwing bombs, are of several kinds.

There are some in the ancient manner, of 6, 7, 8, 9, 10, 11, 12, and 18 inches diameter at their mouth, and which contain in their chambers 3, 4, 5, 6, and 12 pounds of powder.

The chamber where the powder is put is cylindrical, and a little rounded at bottom.

Those of new invention have a concave chamber. And of these there are some which have 12 inches and  $\frac{1}{2}$  at the mouth, and contain in their chambers 18 pounds of powder; others 12, and others 8.

The proportions of mortars are as follow: The mortar which throws a bomb of 19 inches 10 lines of diameter, has the bore 27 $\frac{1}{2}$  inches long, and 18 inches 4 lines of diameter: it has in thickness between the bourelet, and its small reinforced ring, 3 $\frac{1}{2}$  inches; its small reinforced ring, is 3 $\frac{1}{2}$  inches thick; its great one, 4 inches; the entrance of its chamber has 5 $\frac{1}{2}$  inches of diameter; the chamber, in form of a pear, is 13 inches long, and 7 $\frac{1}{2}$  inches of diameter at its greatest breadth; and also 7 $\frac{1}{2}$  thick, and contains 12 pounds of powder.

The tourillons of the mortar have 32 inches in length from one end to the other, and 9 of diameter. The mortar has in height 4 foot 4 inches.

The bomb has 17 inches 10 lines of diameter, is 2 inches thick every where, except the bottom, which has 2 inches 10 lines. The aperture of the touch-hole is of 20 lines within and without.

The bomb contains 48 lb. of powder, and weighs 490 lb. and a little more.

The bore of the concave mortar, whose chamber contains 18 pounds of powder, has 12 $\frac{1}{2}$  inches of diameter, and is 18 $\frac{1}{2}$  inches long. It has in thickness between the bourelet, and its reinforced ring, 3 $\frac{1}{2}$  inches; and its reinforced ring is 4 $\frac{1}{2}$  inches thick. Its chamber has 9 inches 7 lines of diameter at its greatest width: the higher part thereof has 6 inches of diameter, and 4 inches in height; and its lower part 2 $\frac{1}{2}$  inches. The thickness of the metal round the chamber is of 26 inches 9 lines. The tourillons have, from one end to the other, 8 inches of diameter. The mortar has in height 3 feet 5 inches 4 lines. It throws a bomb of 11 inches 8 lines diameter, which is 1 inch 4 lines thick every where, except at its cullet, which has 1 inch 8 lines. The aperture of its touch-hole is 16 lines inside and outside. The bomb contains 15 pounds of powder, and weighs 130 pounds, or thereabout.

The bore or chase of the concave mortar, whose chamber contains 12 pounds of powder, has 12 inches 6 lines of diameter, and 17 inches 6 lines in length. Its thickness between the bourelet and its reinforced ring, is of 2 $\frac{1}{2}$  inches. Its reinforced ring is 3 inches thick. Its chamber has of diameter, at its greatest width, 9 inches 6 lines. The portion of the chamber a-top has 5 inches 4 lines of diameter, and 2 inches at bottom. The thick-

ness of the metal round the chamber is 6 inches. The tourillons are, from one end to the other, 30 inches long, and 7 inches of diameter; and the mortar is in all 3 foot 2 inches high.

It throws a bomb 11 inches 8 lines of diameter, which is 1 inch 4 lines thick every where, except at its cullot, which has 1 inch 8 lines.

The aperture of its touch-hole outside and inside, is 16 lines.

The bomb contains 15 pounds of powder, and weighs 130.

The mortar, which has a concave chamber containing 8 pounds of powder, must throw a bomb of 11 inches 8 lines. Its diameter is of  $12\frac{1}{2}$  inches; its bore 18 inches long; its thickness at the chase  $2\frac{1}{2}$  inches; its reinforced ring 6 inches long, and 3 inches thick; its concave chamber 8 inches 8 lines long, and 7 inches in diameter; the thickness of the metal round it 5 inches; its tourillons 3 inches long from one end to the other, and 7 inches in diameter. The concave chamber contains 8 pounds of powder, and throws a bomb as above.

The ordinary mortar, which throws a bomb of 11 inches 8 lines, has a bore of 12 inches diameter, and 18 long; its thickness at the neck 2 inches; at its reinforced ring  $2\frac{1}{2}$  inches; its chamber  $9\frac{1}{2}$  inches in length, its diameter of  $5\frac{1}{2}$  inches, the thickness of the metal round the chamber 7 inches, which chamber contains 6 pounds of powder; the tourillons have in length, from one end to the other, 28 inches, and 3 inches of diameter.

The mortar, which throws a bomb of 8 inches, has the bore 12 inches long, and 8 inches 4 lines in diameter; its thickness 1 inch 4 lines at the chase; its reinforced rings 4 inches 8 lines long, and 1 inch 8 lines thick; its chamber 6 inches long, and 2 inches 8 lines of diameter; its tourillons 18 inches 8 lines in length, and 4 inches 8 lines of diameter. The bomb of 8 inches of diameter is 10 lines thick every where, except at the cullot, which is 13, and its touch-hole 1 inch of diameter inside and outside. The chamber contains 4 pounds of powder, and the bomb weighs 40 pounds.

The bore of the mortar, which is to throw a bomb of 6 inches, is of  $6\frac{1}{2}$  inches of diameter, and 9 inches long; its thickness at the chase 1 inch; its reinforced ring  $1\frac{1}{2}$  inch thick, and  $3\frac{1}{2}$  inches long; its chamber  $4\frac{1}{2}$  inches long, and 2 inches of diameter; the thickness of the metal 2 inches, and from the bottom of the chamber to behind the recoil of the mortar 4 inches thick.

Common mortars are very good for the bombardment of a place, when they can be carried near the place; throwing the bomb to 45 degrees of elevation, and to 700 fathoms distance: the chamber is charged with 5 or 6 pounds of powder, which is the greatest charge, and carries farther: the nearer a place a mortar is mounted, the less powder is wanted for its charge. The mortars, with a concave chamber of the same diameter, *i. e.* of 12 and  $12\frac{1}{2}$  inches, pointed at 45 degrees, are proper to bombard places afar off; they carry their bombs from 1200 to 1800 fathoms. Those whose chamber contains 8 pounds of powder, throw the bomb to 1200 fathoms, and weigh 2000 lb. Those of 12 pounds of powder will

carry their bombs to 1400 fathoms, and weigh 2500 lb. Those of 18 pounds of powder will carry to 1800 fathoms, and weigh 5000 lb.

The carriage for a mortar of 12 inches of diameter must be 6 foot long, the flasks 12 inches long and 10 thick. The trunnions are placed in the middle of the carriage.

The carriage of 18 must be 4 foot long; and the flasks 11 inches high, and 6 thick.

To mount the mortars of new invention, they use carriages of cast iron.

In Germany, to mount mortars from 8 to 9 inches, and carry them into the field, and execute them horizontally as a piece of cannon, they make use of a piece of wood 8 feet 2 inches long, with a hole in the middle to lodge the body of the mortar and its trunnions as far as their half diameter, and mounted on two wheels four feet high, to which they join a vantrain proportioned to it, and made like those which serve to the carriages of cannons.

Having mounted the mortar on its carriage, the next thing is to caliber the bomb, by means of a great caliber, the two branches whereof embrace the whole circumference of the bomb: these two branches are brought on a rule where the different calibers are marked, among which that of the bomb is found.

A bomb is a hollow iron ball, or shell, filled with gun-powder, and furnished with a vent for a fusee or wooden tube filled with combustible matter to be thrown out from a mortar. The method of preparing a bomb is as follows: A hollow iron globe is cast pretty thick, having a round aperture by which it may be filled and lighted; and circular ansæ for the commodiously putting it into the mortar. To prove whether it be staunch, after heating it red hot on the coals, it is exposed to the air so as it may cool gently; for, since fire dilates iron, if there be any hidden chinks or perforations, they will thus be opened and enlarged, and the rather because of the spring of the included air continually acting from within. This done, the cavity of the globe is filled with hot water, and the aperture well stopped, and the outer surface washed with cold water and soap; so that if there be the smallest leak, the air, rarified by the heat, will now perspire and form bubbles on the surface.

If no defect be found in the bomb, its cavity is filled, by means of a funnel, with whole gun-powder; a little space or liberty is left, that when a fusee or wooden tube, of the figure of a truncated cone, is driven through the aperture, (with a wooden mallet, not an iron one, for fear of accident), and fastened with a cement made of quick-lime, ashes, brick-dust, and steel filings worked together in a glutinous water, or of four parts of pitch, two of colophony, one of turpentine, and one of wax; the powder may not be bruised. This tube is filled with a combustible matter, made of two ounces of nitre, one of sulphur, and three of gun-powder-dust well rammed.

This fusee set on fire, burns slowly till it reaches the gun powder, which goes off at once, bursting the shell to pieces with incredible violence. Special care, however, must be taken, that the fusee be so proportioned, as

that

that the gun-powder do not take fire ere the shell arrives at the destined place; to prevent which, the fusee is frequently wound round with a wet clammy thread.

The mortar mounted on its carriage, and the bomb ready, let us place our piece in battery, which battery must consist,—1. Of an epaulment to shelter the mortars from the fire of the enemy. 2. Of platforms on which the mortars are placed. 3. Of small magazines of powder. 4. Of a boyau which leads to the great magazine. 5. Of ways which lead from the battery to the magazine of bombs. 6. Of a great ditch before the epaulment. 7. Of a berm or retraite.

The platforms for mortars of 12 inches must have 9 feet in length, and 6 in breadth.—The lambourds for common mortars must be four inches thick; those of a concave chamber of 8 lb. of powder, 5 inches; those of 12 lb. 6 inches; those of 18 lb. 7 inches, or thereabouts. Their length is at discretion, provided there be enough to make the platforms 9 feet long.—The fore-part of the platform will be situated at two foot distance from the epaulment of the battery.—The bombardiers, to shelter themselves in their battery, and not be seen from the town besieged, raised an epaulment of 7 foot or more high; which epaulment has no embrasures.

To serve expeditiously a mortar in battery are required,—five strong handspikes; a dame or rammer, of the caliber of the conic chamber, to ram the wad and the earth; a wooden knife a foot long, to place the earth round the bomb; an iron scraper two foot long, one end whereof must be 4 inches broad and roundwise, to clean the bore and the chamber of the mortar; and the other end made in form of a spoon to clean the little chamber; a kind of brancard to carry the bomb, a shovel, and pick ax.

The officer who is to mind the service of the mortar must have a quadrant to give the degrees of elevation.

Five bombardiers, or others, are employed in that service; the first must take care to fetch the powder to charge the chamber of the mortar, putting his priming-iron in the touch-hole before he charges the chamber; and never going to fetch the powder before he has asked his officer at what quantity of powder he designs to charge, because more or less powder is wanted, according to the distance where it is fired; the same will take care to ram the wad and earth, which another soldier shall put in the chamber.

That on the right will put again two shovels full of earth in the bottom of the bore, which should be likewise very well rammed down.

This done, the rammer or dame is returned into its place, against the epaulment on the right of the mortar: he takes an handspike in the same place to post himself behind the carriage of the mortar, in order to help to push it into battery: having laid down his handspike, he takes out his priming-iron, and primes the touch-hole with fine powder.

The second soldier on the right and left, will have by that time brought the bomb ready loaded, to be placed

in the mortar, which must be received in the mortar by the first soldier, and placed very strait in the bore or chafe of the mortar.

The first, on the right, shall furnish him with earth to put round the bomb, which he must take care to ram close with the knife given him by the second on the left.

This done, each shall take a handspike, which the two first, on the right and left, shall put under the pegs of retreat of the fore part, and the two behind under those of the hind-part; and they together shall push the mortar in battery.

Afterwards the officer shall point or direct the mortar.

During that time the first soldier shall take care to prime the touch hole of the mortar, without ramming the powder; and the last on the right, shall have the match ready to set fire on the fusee of the bomb on the right, while the first shall be ready with his on the left, to set fire to the touch-hole of the mortar; which he ought not to do till he sees the fusee well lighted.

The foremost soldiers will have their handspikes ready to raise the mortar upright, as soon as it has discharged; while the hindmost on the left shall, with the scraper, clean the bore and chamber of the mortar.

The magazine of powder for the service of the battery, shall be situated 15 or 20 paces behind, and covered with boards, and earth over it.—The loaded bombs are on the side of the said magazine, at five or six paces distance.

The officer who commands the service of the mortar, must take care to discover, as much as possible, with the eye, the distance of the place where he intends to throw his bomb, giving the mortar the degrees of elevation, according to the judgment he has formed of the distance. Having thrown the first bomb, he must diminish or increase the degrees of elevation, according to the place upon which it shall fall. Several make use of tables to discover the different distances according to the differences of the elevations of the mortar, especially the degrees of the quadrant from 1 to 45.

M. Blondel has wrote a large treatise on that subject, where he pretends to give a demonstration to throw bombs with great exactness.

They say then, (says M Blondel, speaking of bombardiers), that the mortar chafes more or less, according as it is more or less charged with powder; and that a mortar, for example, of 12 inches caliber, charged in its chamber with 2 lb. of powder, gives every degree 48 feet difference in the random, and for the greatest extent under the elevation of 45 degrees, 2160 feet.

The same mortar will give every degree 50 foot difference, if it be charged with  $2\frac{1}{2}$  of the same goodness, and 2700 foot for the greatest random.

Lastly, it will give 72 foot difference every degree, if the charge be of 3 lb. of the same powder; and at the elevation of 45 degrees, which, they say, is the greatest random, it will throw the bomb at the distance of 3240 feet.

On this foundation they have made the following tables.

TABLES

TABLES for Mortars of 12 inches of Caliber.

TABLES for Mortars of 8 inches Caliber.

First Table at two pounds of powder.

Degrees	Randoms	Degrees	Randoms
5	240 Feet	28	1344 Feet
10	480	29	1392
11	528	30	1440
12	576	31	1488
13	624	32	1536
14	672	33	1584
15	720	34	1632
16	768	35	1680
17	816	36	1728
18	864	37	1776
19	912	38	1824
20	960	39	1872
21	1008	40	1920
22	1056	41	1968
23	1104	42	2016
24	1152	43	2064
25	1200	44	2112
26	1248	45	2160
27	1296		

Note, That the difference is of 48 feet every degree.

First Table at half pound of powder.

Degrees	Randoms	Degrees	Randoms
5	210 Feet	28	1176 Feet
10	420	29	1218
11	460	30	1260
12	504	31	1302
13	546	32	1344
14	588	33	1386
15	630	34	1428
16	672	35	1470
17	714	36	1512
18	756	37	1554
19	798	38	1596
20	840	39	1638
21	882	40	1680
22	924	41	1722
23	966	42	1764
24	1008	43	1806
25	1050	44	1848
26	1092	45	1890
27	1134		

The difference is of 42 feet every degree.

Second Table at two pounds and half of powder.

Degrees	Randoms	Degrees	Randoms
36	2160 Feet	41	2460 Feet
37	2200	42	2520
38	2280	43	2580
39	2340	44	2640
40	2400	45	2700

Note, That the difference is of 60.

Second Table at three quarters of a pound of powder.

Degrees	Randoms	Degrees	Randoms
31	1922 Feet	39	2418 Feet
32	1984	40	2480
33	2046	41	2542
34	2108	42	2604
35	2170	43	2666
36	2232	44	2728
37	2294	45	2790
38	2356		

The difference is of 62.

Third Table at three pounds of powder.

Degrees	Randoms	Degrees	Randoms
37	2664 Feet	42	3024 Feet
38	2736	43	3096
39	2808	44	3168
40	2880	45	3240
41	2952		

The difference is of 72.

Third Table at one pound of powder.

Degrees	Randoms	Degrees	Randoms
35	2870 Feet	41	3362 Feet
36	2952	42	3444
37	3034	43	3526
38	3116	44	3608
39	3198	45	3690
40	3280		

Granadoes are charged like the bombs, and are very much like them, except that they have no *ansa*.

A granado is a hollow ball, or shell of iron, brass, or even glass, or potters earth, filled with gun powder, and fitted with a sufe to give it fire. (*ibid.*)

Of these there are two kinds; the one large for ditches, or fosses, called sometimes bombs, whose caliber is the same with that of the bullets of 33 lb. and which weigh 16 lb. of 24, and which weigh 12 lb. of 16, which weigh 8 lb.

These granadoes are rolled from the ramparts, or other works, into the ditch, or on a breach, and do much execution.

The other are hand-granadoes, of the bigness or caliber of a bullet of 4 lb. and weigh only 2 lb. containing 4 or 5 ounces of powder, or thereabout.

These serve to throw with the hand into the trenches, or retrenchments, in the middle of a troop or company, and they infallibly lame or kill.

Care is taken, as much as possible, that they be well emptied, shaved, and of brittle iron. Their aperture or orifice must have six lines, or thereabout.

Small lanterns or ladles of copper, and small rammers, are used to charge the granadoes.

As to the proportions of granadoes, those of the caliber of

of a bullet of 33, have 6 inches of diameter, and something more; they are 8 lines thick, and weigh 16 lb.

Those of the caliber of 24 have 5 inches 5 lines diameter, are 6 lines thick, and weigh 12 lb.

Those of the caliber of 16 have 4 inches 9 lines of diameter, are 5 lines thick, and weigh 8 lb.

Those which weigh 6 lb. have 3 inches 5 lines diameter, and 5 lines in thickness.

Those of 5 lb. weight have 3 inches 2½ lines diameter, and 5 lines in thickness.

Those which weigh 3 lb. have 2 inches 8 lines diameter, and are 4½ lines thick.

Those of 2 lb. weight, have 2 inches 4 lines diameter, and 4 lines in thickness.

Those of 1 lb. weight have 1 inch 10 lines diameter, and are 3 lines thick.

Those of ½ have 1 inch 8 lines diameter, and are 3 lines thick.

Those of ¼ have 1 inch 6 lines diameter, and are 3 lines thick.

Those of a ⅓ have 1 inch 2 lines diameter, and are 2½ lines thick.

All these granadoes must be thicker at bottom than any where else.

These different sorts of granadoes have also different sorts of fuses.

Those of the caliber of 33 24 16 12 8 4 are at the biggest end, of 12 lin. 11 10½ 10 9½ 8½

The diameter of the } 4 4 3 3 3 2 orifices,

The fuses are in } 5½ inch. 5 4 4 3½ 2½ length, in all, of }

And as the large granadoes, which are made to throw into the fosses, or ditches, or with small mortars, they must have fuses of different lengths; these are for small mortars; those for ditches must be shorter.

The Germans cover over the fusee with paper or parchment, tied with a thread round the fusee.

In France they use a composition of black pitch, mixed with a little tallow, with which they rub over the fusee, when fixed to the granado.

The fusee must burn so long, and no longer, as is the time of the motion of the bomb or granado, from the mouth of the mortar, &c. to the place where it is to fall, which time is about 27 seconds; so that the fusee must be contrived, either from the nature of the composition, or the length of the pipe which contains it, to burn just that time.

At Paris they charge the fusees for the bombs and granadoes with a composition made with powder-dust and charcoal, very well pounded, and sifted very fine, putting two ounces of charcoal on each pound of powder, and make several proofs, to know if the composition be not too quick.

There are several other compositions to charge the fusees for bombs or granadoes.

The first is of 4 lb. of powder, 2 lb. of saltpetre, and 1 lb. of sulphur.

The second is of 5 lb. of powder, 2 lb. of saltpetre, and 1 pound of sulphur.

The third, which is the best, is of 3 lb. of powder, 2 lb. of saltpetre, and 1 lb. of sulphur.

The fourth is of 3 lb. of powder, 2 lb. of saltpetre, and ½ lb. of sulphur.

The fusees must be charged even, *i. e.* they must burn without spitting.

The fusee of the hand-granado, which is of the caliber of 4, must be 2 inches 2 lines long, 9 lines of diameter, and 6 lines at the small end: the orifice of the fusee 2½ lines.

As soon as the fusee is placed to the granado, the head thereof must be sauced in melted pitch, and afterwards dipped in water, which hinders the composition from spoiling, and the wood from rotting.

The PETARD. (*ibid.*) is the next piece of artillery which deserves our attention, and is a kind of engine of metal, somewhat in shape of a high-crowned hat, serving to break down gates, barricades, draw-bridges, or the like works; which are intended to be surprized. It is very short, narrow at the breach, and wide at the muzzle, made of copper mixed with a little brass, or of lead with tin.

The petards are not always of the same height and bigness: they are commonly 10 inches high, 9 inches of diameter a-top, and 10 inches at bottom. They weigh commonly 40, 45, and 50 pounds.

The madrier, on which the petard is placed, and where it is tied with iron circles, is of two feet for its greatest width, and of 18 inches on the sides, and no thicker than a common madrier. Under the madrier are two iron bars passed cross-ways, with a hook, which serves to fix the petard.

To charge a petard 15 inches high, and 6 or 7 inches of caliber or diameter at the bore, the inside must be first very well cleaned and heated, so that the hand may bear the heat; then take the best powder that may be found, throw over it some spirit of wine, and expose it to the sun, or put it in a frying-pan; and when it is well dried, 5 or 6 lb. of this powder is put into the petard, which reaches within three fingers of the mouth: the vacancies are filled with tow, and stopped with a wooden tampion; the mouth being strongly bound up with cloth tied very tight with ropes; then it is fixed on the madrier, that has a cavity cut in it to receive the mouth of the petard, and fastened down with ropes.

Some, instead of gun powder for the charge, use one of the following compositions, *viz.* gun-powder seven pounds, mercury sublimate one ounce, camphor eight ounces; or gun-powder six pounds, mercury sublimate three ounces, and sulphur three; or gun-powder six, beaten glass ¼ an ounce, and camphor ½.

Before any of these pieces are appropriated for service, it is necessary they have each undergo a particular trial of its soundness, which is called a proof, to be made by or before one authorized for the purpose, called the *proof-master*.

To make a proof of the piece, a proper place is chosen, which is to be terminated by a mount of earth very thick to receive the bullets fired against it, that none of them may run through it. The piece is laid on the ground, supported



supported only in the middle by a block of wood. It is fired three times : the first with powder of the weight of the bullet, and the two others with  $\frac{1}{2}$  of the weight ; after which a little more powder is put in to singe the piece ; and after this water, which is impressed with a sponge, putting the finger on the touch-hole, to discover if there be any cracks ; which done, they are examined with the cat, which is a piece of iron with three grasps, disposed in the form of a triangle, and of the caliber of the piece ; then it is visited with a wax candle, but it is of very little service in the small pieces, because if they be a little long, the smoke extinguishes it immediately.

The proof of mortars is made in this manner : Where there are carriages of cast iron, the mortar is placed on one of those carriages. Under that carriage is made a platform of madriers 5 or 6 inches thick ; the mortar is charged with the best powder, and with as much of it as its chamber can contain, observing to leave no vacuity at the neck of the mortar, but what is necessary to put a little wad over the powder, and which is rammed with the end of an handspike, to keep the powder together as much as possible. A large green turf, with earth two fingers deep, is put over the wad, which must have width enough to fill up the bottom of the mortar. This turf and earth are very well rammed down, then the bomb is placed over it as upright as possible, leaving a small place round it, which is to be filled with clay as tight as possible, pressing it between the mortar and the bomb with a pointed stick ; and as it is not necessary to spend much powder in these sort of proofs, the bomb must be filled with as much earth as it would contain powder.

For want of carriages of cast iron, holes are dug in the earth where the mortars are buried as far as the touch-hole ; and in order that the mortars thus buried may find more resistance, and make a greater effort, large pieces of wood in form of joists are put under the mortar, chusing always the hardest ground, to resist better the recoil of the mortar.

A fusée for granadoes is put on the touch-hole of each mortar, that the gunner may have time to retire, in case the mortar was to burst in the proof ; which is also practised in the proof of the pieces.

This proof is made three times, without increasing or diminishing any thing.

Besides the large pieces mentioned throughout this treatise, invented for the destruction of mankind, there are others called small guns, *viz.* muskets of ramparts, common muskets, fusils, carabines, musketoons, and pistols.

A musket, or musquet, is a fire-arm borne on the shoulder, and used in war, formerly fired by the application of a lighted match, but at present with a flint and lock.

The common muskets are of the caliber of 20 leaden balls to the pound, and receive balls from 22 to 24 : its length is fixed to 3 feet 8 inches from the muzzle to the touch-pan.

A fusil, or fire-lock, has the same length and caliber ; and serves at present instead of a musket.

A carabine is a small sort of fire-arm, shorter than a fusil, and carrying a ball of 24 in the pound, borne by the left hand, hanging at a belt over the left shoulder.

The carabine is a kind of medium between the pistol and the musket ; and bears a near affinity to the arquebuss, only that its bore is smaller. It was formerly made with a match-lock, but of late only with a flint-lock.

The musketoon is of the same length of the carabine, the barrel polished, and clean within.

The musketoon carries five ounces of iron, or seven and a half of lead, with an equal quantity of powder.

The barrel of a pistol is generally 14 inches long.

As to the invention of cannon and gun powder, we are certain that they are discoveries of a modern date : but there is no depending upon the various accounts given of them by authors. All that can be said with certainty is, that there is mention made of gun-powder in the register of the chamber of accounts in France, in the year of Christ 1338 ; that Alphonfus XI. king of Castile, besieged the Moors with iron mortars, in the year of Christ 1343 ; and that our King Edward, in 1346, first carried those thundering machines of war and death into France, where he availed himself of five or six pieces of cannon at the battle of Cressy.

Before the invention of these instruments of war, the ancients made use of the aries, or battering-ram, the catapultæ, the ballista, scorpion, and testudo. See *RAM, &c.*

*For the mathematical principles of Gunnery, see PROJECTILES.*

**GUN-POWDER**, a composition of saltpetre, sulphur, and charcoal, mixed together, and usually granulated ; which easily takes fire, and, when fired, rarifies, or expands, with great vehemence, by means of its elastic force.

It is to this powder we owe all the action and effect of guns, ordnance, &c. so that the modern military art, fortification, &c. in a great measure depend thereon.

*Method of making GUN POWDER.* Dr Shaw's recipe for this purpose is as follows. Take four ounces of refined saltpetre, an ounce of brimstone, and six drams of small coal : reduce these to a fine powder, and continue beating them for some time in a stone mortar, with a wooden pestle, wetting the mixture between whiles with water, so as to form the whole into an uniform paste, which is reduced to grains, by passing it through a wire sieve fit for the purpose ; and in this form being carefully dried, it becomes the common gun-powder.

For greater quantities, mills are usually provided, by means of which more work may be performed in one day, than a man can do in a hundred.

The nitre or saltpetre is refined thus : dissolve four pounds of rough nitre as it comes to us from the Indies, by boiling it in as much water as will commodiously suffice for that purpose : then let it shoot for two or three days in a covered vessel of earth, with sticks laid across for the crystals to adhere to. These crystals being taken out, are drained and dried in the open air.

In order to reduce this salt to powder, they dissolve

a large quantity of it in as small a proportion of water as possible; then keep it constantly stirring over the fire, till the water exhales, and a white dry powder is left behind.

In order to purify the brimstone employed, they dissolve it with a very gentle heat; then scum and pass it through a double strainer. If the brimstone should happen to take fire in the melting, they have an iron cover that fits on close to the melting vessel, and damps the flame. The brimstone is judged to be sufficiently refined if it melts, without yielding any fetid odour, between two hot iron plates, into a kind of red substance.

The coal for the making of gun powder is either that of willow, or hazel, well charred in the usual manner, and reduced to powder. And thus the ingredients are prepared for making this commodity: but as these ingredients require to be intimately mixed, and as there would be danger of their firing if beat in a dry form, the method is to keep them continually moist, either with water, urine, or a solution of sal ammoniac: they continue thus stamping them together for twenty four hours, after which the mass is fit for corning and drying in the sun, or otherwise, so as sedulously to prevent its firing.

*Rationale of GUN-POWDER.* The explosive force of gun-powder is now a thing commonly known, but the physical reason thereof may not perhaps be hitherto sufficiently understood. In order to explain it, Dr Shaw proposes the following observations: 1. That saltpetre of itself is not inflammable; and though it melts in the fire, and grows red hot, yet does not explode, unless it comes in contact with the coals. 2. That brimstone easily melts at the fire, and easily catches flame. 3. That powdered charcoal readily takes fire, even from the sparks yielded by a flint and steel. 4. That if nitre be mixed with powdered charcoal, and brought in contact with the fire, it burns and flames. 5. That if sulphur be mixed with powdered charcoal, and applied to the fire, part of the sulphur burns slowly away, but not much of the charcoal; and, 6. That if a lighted coal be applied to a mixture of nitre and sulphur, the sulphur presently takes fire with some degree of explosion; leaving part of the nitre behind, as we see in making the sal puelle, and sal polychrestum.

These experiments duly considered, adds the doctor, may give us the chemical cause of the strange explosive force of gun-powder. For each grain of this powder consisting of a certain proportion of sulphur, nitre, and coal, the coal presently takes fire, upon contact of the smallest spark: at which time both the sulphur and the nitre immediately melt, and by means of the coal interposed between them, burst into flame; which, spreading from grain to grain, propagates the same effect almost instantaneously: whence the whole mass of powder comes to be fired: and as nitre contains both a large proportion of air and water, which are now violently rarified by the heat, a kind of fiery explosive blast is thus produced, wherein the nitre seems, by its aqueous and aerial parts, to act as bellows to the other inflammable bodies, sulphur and coal, to blow them

into a flame, and carry off their whole substance in smoke and vapour.

*Different kinds of GUN-POWDER.* The three ingredients of gun-powder are mixed in various proportions according as the powder is intended for muskets, great guns, or mortars; though these proportions seem not to be perfectly adjusted or settled by competent experience.

Semienowitz, for mortars, directs an hundred pounds of saltpetre, twenty-five of sulphur, and as many of charcoal; for great guns, an hundred pounds of saltpetre, fifteen pound of sulphur, and eighteen pound of charcoal; for muskets and pistols, an hundred pound of saltpetre, eight pound of sulphur, and ten pound of charcoal. Miethius extols the proportion of one pound of saltpetre to three ounces of charcoal, and two, or two and a quarter of sulphur; than which, he affirms, no gun-powder can possibly be stronger. He adds, that the usual practice of making the gun-powder weaker for mortars than guns, is without any foundation, and renders the expence needlessly much greater: for whereas to load a large mortar, twenty-four pound of common powder is required, and consequently, to load it ten times, two hundred and forty pound, he shews, by calculation, that the same effect would be had by one hundred and fifty pound of the strong powder.

To increase the strength of powder, Dr Shaw thinks it proper to make the grains considerably large, and to have it well sifted from the small dust. We see that gun-powder, reduced to dust, has little explosive force; but when the grains are large, the flame of one grain has a ready passage to another, so that the whole parcel may thus take fire nearly at the same time, otherwise much force may be lost, or many of the grains go away as shot unfired.

It should also seem that there are other ways of increasing the strength of powder, particularly by the mixture of salt of tartar; but perhaps, adds the last-mentioned author, it were improper to divulge any thing of this kind, as gun-powder seems already sufficiently destructive.

*Method of trying and examining GUN-POWDER.* There are two general methods of examining gun-powder; one with regard to its purity, the other with regard to its strength. Its purity is known by laying two or three little heaps near each other upon white paper, and firing one of them: for if this takes fire readily, and the smoke rises upright, without leaving any dross or sculent matter behind, and without burning the paper, or firing the other heaps, it is esteemed a sign that the sulphur and nitre were well purified, that the coal was good, and that the three ingredients were thoroughly incorporated together: but if the other heaps also take fire at the same time, it is presumed, that either common salt was mixed with the nitre, or that the coal was not well ground, or the whole mass not well beat, and mixed together; and if either the nitre or sulphur be not well purified, the paper will be black or spotted.

In order to try the strength of gun-powder, there are two kinds of instruments in use; but neither of them

them appear more exact than the common method of trying to what distance a certain weight of powder will throw a ball from a musket.

There has been much talk of a white powder, which, if it answered the character given it, might be a dangerous composition; for they pretend that this white powder will throw a ball as far as the black, yet without making a report; but none of the white powder we have seen, says Dr Shaw, answers to this character; being, as we apprehend, commonly made either with touchwood or camphor, instead of coal.

*Observations on the force of GUN-POWDER.* Gun-powder, fired either in vacuum, or in air, produces, by its explosion, a permanent elastic fluid. For if a red-hot iron be included in a receiver, after being exhausted, and gun powder be let fall on the iron, the powder will take fire, and the mercurial gage will suddenly descend upon the explosion; and though it immediately ascends again, yet it will never rise to the height it first stood at, but will continue depressed by a space proportioned to the quantity of gun powder which was let fall on the iron.

The same production likewise takes place, when gun powder is fired in the air: for if a small quantity of powder be placed in the upper part of a glass tube, and the lower part of the tube be immersed in water, and the water be made to rise so near the top, that only a small portion of air is left in that part where the gun-powder is placed; if in this situation the communication of the upper part of the tube with the external air be closed, and the powder be fired, which will easily be done by a burning-glass, the water will in this experiment descend upon the explosion as the quicksilver did in the last; and will always continue depressed below the place at which it stood before the explosion; and the quantity of this depression will be greater, if the quantity of powder be increased, or the diameter of the tube be diminished. From whence it is proved, that as well in air as in a vacuum, the explosion of fired powder produces a permanent elastic fluid. It also appears from experiment, that the elasticity or pressure of the fluid produced by the firing of gun powder, is, *ceteris paribus*, directly as its density. This follows from hence, that if in the same receiver a double quantity of powder be let fall, the mercury will subside twice as much as in the firing of a single quantity.

To determine the elasticity and quantity of this elastic fluid, produced from the explosion of a given quantity of gun powder, Mr Robins premises, that the elasticity of this fluid increases by heat, and diminishes by cold, in the same manner as that of the air; and that the density of this fluid, and consequently its weight, is the same with the weight of an equal bulk of air having the same elasticity, and the same temperature.

From these principles, and from his experiments, (for a detail of which we must refer the reader to his *New Principles of Gunnery*, in Scholium to prop. II.) he concludes, that the fluid produced by the firing of gun-powder will be  $\frac{1}{20}$  of the weight of the gun pow-

der, and the ratio of the respective bulks of the powder, and the fluid produced from it, will be in round numbers 1 to 244.

Hence we are certain, that any quantity of powder fired in any confined space, which it adequately fills, exerts, at the instant of its explosion, against the sides of the vessels containing it, and the bodies it impels before it, a force at least 244 times greater than the elasticity of common air; or, which is the same thing, than the pressure of the atmosphere; and this without considering the great addition which this force will receive from the violent degree of heat with which it is endued at that time, the quantity of which augmentation is the next head of Mr Robins's enquiry. He determines that the elasticity of the air is augmented when heated to the extremest heat of red hot iron, in the proportion of 796 to 194 $\frac{1}{2}$ ; and supposing that the flame of fired gun-powder is not less hot than red hot iron, and the elasticity of the air, and consequently of the fluid, generated by the explosion, being augmented by the extremity of this heat in the ratio of 796 to 194 $\frac{1}{2}$ , it follows, that if 244 be augmented in this ratio, the resulting number, which is 999 $\frac{1}{2}$ , will determine how many times the elasticity of the flame of fired powder exceeds the elasticity of common air, supposing it to be confined in the same space which the powder filled before it was fired.

Hence then, the absolute quantity of the pressure exerted by gun-powder at the moment of its explosion may be assigned: for since the fluid then generated has an elasticity of 999 $\frac{1}{2}$ , or, in round numbers, 1000 times greater than common air; and since common air, by its elasticity, exerts a pressure on any given surface equal to the weight of the incumbent atmosphere with which it is in *equilibrium*, the pressure exerted by fired powder, before it has dilated itself, is 1000 times greater than the pressure of the atmosphere; and consequently the quantity of this force on a surface of an inch square amounts to above six tun weight, which force however diminishes as the fluid dilates itself. The variations of the density of the atmosphere does not any way alter the action of powder by any experiment that can be made. But the moisture of the air has a very great influence on the force of it: for that quantity which in a dry season would communicate to a bullet a velocity of 1700 feet in one second, will not in damp weather communicate a velocity of more than 12 or 1300 feet in a second, or even less, if the powder be bad and negligently kept.

The velocity of expansion of the flame of gun-powder, when fired in a piece of artillery, without either bullet, or any other body before it, is prodigious. By the experiments of Mr Robins, it seems this velocity cannot be much less than 7000 feet in a second. This, however, must be understood of the most active part of the flame. For, as was observed before, the elastic fluid, in which the activity of gun-powder consists, is only  $\frac{1}{20}$  of the substance of the powder, the remaining  $\frac{19}{20}$  will in the explosion be mixed with the elastic part, and will by its weight retard

ward the activity of the explosion; and yet they will be so completely united, as to move with uncommon motion; but the unelastic part will be less accelerated than the rest, and some of it will not even be carried out of the barrel, as appears by the considerable quantity of unctuous matter, which adheres to the inside of all fire-arms, after they have been used. These inequalities in the expansive motion of the flame render it impracticable to determine its velocity, otherwise than from experiments.

*To recover damaged GUN POWDER.* The method of the powder-merchants is, to put part of the powder on a sail-cloth, to which they add an equal weight of what is really good; and with a shovel mingle it well together, dry it in the sun, and barrel it up, keeping it in a dry and proper place. Others again, if it be very bad, restore it by moistening it with vinegar, water, urine, or brandy: then they beat it fine, scarce it, and to every pound of powder add an ounce, an ounce and a half, or two ounces, according as it is decayed, of melted salt-petre. Afterwards, these ingredients are to be moistened and mixed well, so that nothing can be discerned in the composition, which may be known by cutting the mass; and then they granulate it as aforesaid. In case the powder be in a manner quite spoiled, the only way is to extract the salt-petre with water, according to the usual manner, by boiling, filtrating, evaporating, and crystallizing; and then with fresh sulphur and charcoal to make it up a-new again. In regard to the medical virtues of gun-powder, Boerhaave informs us, that the flame of it affords a very healthy fume in the height of the plague: because the explosive acid vapour of nitre and sulphur corrects the air; and that the same vapour, if received in a small close pent up place, kills insects.

It is enacted by 5 and 11 of Geo. I. and 5 Geo. II. c. 20. that gun-powder be carried to any place in a covered carriage; the barrels being close jointed; or in cases and bags of leather, &c. And persons keeping more than 200 pounds weight of gun-powder at one time, within the cities of London and Westminster, or the suburbs, &c. are liable to forfeitures if it be not removed; and justices of peace may issue warrants to search for, seize, and remove the same.

The invention of gun-powder is ascribed by Polydore Virgil to a chemist, who having accidentally put some of the ingredients in this composition in a mortar, and covered it over with a stone, it happened to take fire, and blew up the stone. Thuret says, the person here spoken of was a monk of Friburg, named Constantine Anlzen; but Belleforet and others hold it to be Bartholdus Schwartz, or the black; at least it is affirmed, that he first taught the use of it to the Venetians, in the year 1380, during the war with the Genoese. But what contradicts this account, and shews gun-powder to be of an older date, is, that Peter Mexia, in his *Variz Lectiones*, relates, that Alphonsus XI king of Castile, used mortars against the Moors in a siege in 1343. Ducange adds, that there is mention made of this powder in the registers of the chambers of accounts in France, as early as the year

1338; and frier Bacon, our countryman, mentions the composition in express terms, in his treatise *De nullitate magix*, published at Oxford, in the year 1216.

*GUN-SHOT-WOUNDS.* See *SURGERY*.

*GUNTSBERG*, a town of Germany in the circle of Swabia, situated on the east side of the Danube: E. long.  $10^{\circ} 15'$ , N. lat.  $48^{\circ} 35'$ .

*GUNTER'S LINE*, a logarithmic line, usually graduated upon scales, sectors, &c.

It is also called the line of lines, and line of numbers; being only the logarithms graduated upon a ruler, which therefore serves to solve problems instrumentally in the same manner as logarithms do arithmetically. It is usually divided into an hundred parts, every tenth whereof is numbered, beginning with 1, and ending with 10; so that, if the first great division, marked 1, stand for one tenth of any integer, the next division, marked 2, will stand for two tenths; 3, three tenths, and so on; and the intermediate divisions will, in like manner, represent 100th parts of the same integer. If each of the great divisions represent 10 integers, then will the lesser divisions stand for integers; and if the greater divisions be supposed each 100, the subdivisions will be each 10.

*Use of GUNTER'S LINE.* 1. *To find the product of two numbers.* From 1 extend the compasses to the multiplier; and the same extent, applied the same way from the multiplicand, will reach to the product. Thus if the product of 4 and 8 be required, extend the compasses from 1 to 4, and that extent laid from 8 the same way, will reach to 32, their product. 2. *To divide one number by another.* The extent from the divisor to unity, will reach from the dividend to the quotient: thus, to divide 36 by 4, extend the compasses from 4 to 1, and the same extent will reach from 36 to 9, the quotient sought. 3. *To three given numbers, to find a fourth proportional.* Suppose the numbers 6, 8, 9; extend the compasses from 6 to 8, and this extent, laid from 9 the same way, will reach to 12, the fourth proportional required. 4. *To find a mean proportional between any two given numbers.* Suppose 8 and 32; extend the compasses from 8, in the left hand part of the line, to 32 in the right; then bisecting this distance, its half will reach from 8 forward, or from 32 backward, to 16, the mean proportional sought. 5. *To extract the square root of any number.* Suppose 25; bisect the distance between 1 on the scale and the point representing 25; then the half of this distance, set off from 1, will give the point representing the root 5. In the same manner, the cube root, or that of any higher power, may be found by dividing the distance on the line, between 1 and the given number, into as many equal parts as the index of the power expresses; then one of those parts, set from 1, will find the point representing the root required.

*GUNTER'S QUADRANT.* one made of wood, brass, &c. containing a kind of stereographic projection of the sphere, on the plane of the equinoctial; the eye being supposed placed in one of the poles.

- GUNTER'S SCALE**, called by navigators simply the gunter, is a large plain scale, generally two foot long, and about an inch and a half broad, with artificial lines delineated on it, of great use in solving questions in trigonometry, navigation, &c.
- GUN-WALE**, or **GUNNEL**, is the uppermost wale of a ship, or that piece of timber which reaches on either side from the quarter-deck to the fore-castle, being the uppermost bend which finishes the upper works of the hull, in that part in which are put the stanchions which support the wale-trees.
- GURIEL**, a subdivision of Georgia in Asia, situated on the eastern coast of the Euxine sea.
- GURK**, a city of Carinthia, in Germany: E. long. 14°, N. lat. 47° 20'.
- GURNARD**, in ichthyology. See **TRIGLA**.
- GUSSET**, in heraldry, is formed by a line drawn from the dexter or sinister chief points, and falling down perpendicularly to the extreme base. See Plate XCVII. fig. 8.
- The gusset is an abatement of honour, denoting an effeminate person.
- GUSTROW**, a town of Germany, in the dutchy of Mecklenburg: E. long. 12° 15', N. lat. 54°.
- GUTS**. See **ANATOMY**, p. 257.
- GUTSKROW**, a city of Germany in the circle of Upper Saxony, and province of Swedish Pomerania: E. long. 13° 40', N. lat. 54°.
- GUTTÆ**, in architecture, are ornaments in the form of little cones, used in the plafond of the Doric cornice, or on the architrave underneath the triglyphs, representing a sort of drops or bells. See **ARCHITECTURE**.
- GUTTA SERENA**, a disease in which the patient, without any apparent fault in the eye, is entirely deprived of sight. See **MEDICINE**.
- GUTTERS**, in architecture, a kind of canals in the roofs of houses, serving to receive and carry off the rain.
- GUTTURAL**, a term applied to letters or sounds pronounced or formed as it were in the throat.
- GUTTY**, in heraldry, a term used when any thing is charged or sprinkled with drops. In blazoning, the colour of the drops is to be named; as, gutty of sable, of gules, &c.
- GUY**, in a ship, is any rope used for keeping off things from bearing or falling against the ship's side when they are hoisting in.
- That rope which at one end is made fast to the fore-mast, and seized to a single block at the pendant of the garnet, is called the guy of the garnet.
- GUZES**, in heraldry, roundles of a sanguine or murrey colour. These, from their bloody hue, are by some supposed to represent wounds.
- GYMNASIARCH**, in antiquity, the director of the gymnasium. He had two deputies under him; the one called xyltarch, who presided over the athletæ, and had the oversight of the wrestling; the other gymnastes, who had the direction of all the other exercises.
- GYMNASIUM**, in Grecian antiquity, a place fitted for performing exercises.

Gymnasia, according to Potter, were first used at Lacedæmon, but were afterwards very common in all the parts of Greece, and imitated, very much augmented, and improved at Rome. They were not single edifices, but a knot of buildings united, being so capacious as to hold many thousands of people at once; and having room enough for philosophers, rhetoricians, and the professors of all other sciences, to read their lectures; and wrestlers, dancers, and all others who would, to exercise at the same time without the least disturbance or interruption. They consisted of a great many parts, the chief of which were, the porticos, elæothesium, palestra, conister-um, &c.

Athens had several gymnasia, of which the lyceum, academia, and cynosarges, were those of most note.

The lyceum was situated on the banks of the river Ilissus, and received its name from Apollo, to whom it was dedicated.

The lyceum was the place where Aristotle taught philosophy, walking there every day till the hour of anointing; whence he and his followers got the name of peripatetics.

The academy was part of the ceramicus without the city, where Plato lectured. See **ACADEMY**.

**GYMNASTICS**, the art of performing the several bodily exercises, as wrestling, running, fencing, dancing, &c.

**GYMNOPYRUS**, in natural history, a name given by Dr Hill to the pyritæ of a simple internal structure, and not covered with a crust.

Of these there are only two species: 1. A green variously shaped kind. 2. A botryoide kind.

The first species is the most common of all the pyritæ, and appears under a great diversity of shapes. It is very hard and heavy, very readily gives fire with steel, but will not at all ferment with aquafortis. The second species is very elegant and beautiful, and its usual colour is a very agreeable pale green; but what most distinguishes it from all other pyritæ is, that its surface is always beautifully elevated into tubercles of various sizes, resembling a cluster of grapes.

**GYMNOSOPHISTS**, a sect of philosophers who clothed themselves no farther than modesty required. There was some of these sages in Africa; but the most celebrated clan of them was in India. The African gymnosophists dwelt upon a mountain in Ethiopia, near the Nile, without the accommodation either of house or cell. They did not form themselves into societies like those of India, but each had his private retirement, where he studied and performed his devotions by himself. If any person had killed another by chance, he applied to these sages for absolution, and submitted to whatever penances they enjoined. They observed an extraordinary frugality, and lived only upon the fruits of the earth. Lucan ascribes to these gymnosophists several new discoveries in astronomy.

As to the Indian gymnosophists, they dwelt in the woods, where they lived upon the wild products of the earth, and never drank wine, nor married. Some of them practised physic, and travelled from one place to another: these were particularly famous for their remedies

remedies against barrenness. Some of them, likewise, pretended to practise magic, and to foretell future events.

In general, the gymnosophists were wise and learned men: their maxims and discourses, recorded by historians, do not in the least favour of a barbarous education, but are plainly the result of great sense and deep thought. They keep up the dignity of their character to so high a degree, that it was never their custom to wait upon any body, not even upon princes themselves; for which reason Alexander, who would not condescend to visit them in person, sent some of his courtiers to them in order to satisfy his curiosity. Their way of educating their disciples is very remarkable: every day, at dinner, they examined them how they had spent the morning; and every one was obliged to shew, that he had discharged some good office, practised some virtue, or improved in some part of learning: if nothing of this appeared, he was sent back without his dinner. They held a transmigration of souls; and it is probable that Pythagoras borrowed his doctrine from them.

**GYMNOSPERMIA**, in botany. See **BOTANY**, p. 636.

**GYMNOTUS**, in ichthyology, a genus of fishes belonging to the order of apodes. They have two tentacula at the upper lip; the eyes are covered with the common skin; there are five rays in the membrane of the gills; the body is compressed, and carinated on the belly with a fin. There are five species.

**GYNÆCEUM**, among the ancients, the apartment of the women, a separate room in the inner part of the house where they employed themselves in spinning, weaving, and needle-work.

**GYNÆOCRACY**, denotes the government of women, or a state where women are capable of the supreme command. Such are Britain and Spain.

**GYNANDRIA**, in botany. See **BOTANY**, p. 635.

**GYPSIES**. See **EGYPTIANS**.

**GYPSUM**, or **PLASTER-STONE**, in natural history, a genus of fossils, naturally and essentially simple, not inflammable nor soluble in water, and composed of flat small particles, which form bright, glossy, and in some degree transparent masses, not flexible or elastic, not giving fire with steel, nor fermenting with, or being soluble in, acid menstrua, and very easily calcined in the fire.

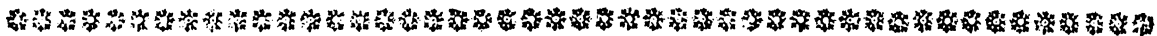
Of these gypsums, some are harder, others softer, and are of several colours; as, white, grey, red, green, &c. sometimes distinct, and sometimes variously blended together.

The texture of all the gypsums being ultimately the same, it may be sufficient to observe, that their origin is plainly from particles of a determinate nature and substance, and of a certain and invariable figure, an oblong, flat, and irregularly angular one. These we sometimes see, as indeed is most natural to them, disposed without order or regularity, into loose, complex, friable masses; at others, they are getting out of their native order, and emulating the structure of other classes of bodies, of which they are indeed properly the basis, and appearing somewhat in the figure of the fibrariz; and at other times, of the foliaceous composite flakes of the selenitiz: the species which have these structures, are truly varying from the gypsums into those bodies they emulate; for the fibrariz are only a peculiar arrangement of these very particles, and the selenitiz only more broad flakes of the same, like those of the foliaceous talcs.

The gypsums are much used in plaster, for stuccoing rooms, and casting busts and statues.

**GYRFALCON**. See **FALCO**.

**GYSHORN**, in the dutchy of Lunenburg, situated on the river Aller, forty-five miles north-east of Hanover: E. long. 10° 45', and N. lat. 52° 50'.



## H

### H A B

**HABAT**, the north-west province of the empire of Morocco, situated on the streights of Gibraltar.

**HABAKKUK**, or the prophecy of Habakkuk, a canonical book of the Old Testament.

There is no mention made in scripture, either of the time when this prophet lived, or of the parents from whom he was descended; but according to the authors of the lives of the prophets, he was of the tribe of Simeon, and a native of Bethzacar.

**HABEAS CORPUS**, in law, is a writ of two kinds; the one being the great writ of the English liberty, which lies where a person is indicted for any crime or trespass before justices of the peace, or in a court of any franchise, and on being imprisoned has offered sufficient bail, which has been refused, though the

### H A B

case be bailable; in which case he may have this writ out of the king's bench, in order to remove himself thither, to answer the cause at the bar of that court.

The practice in this case is, first to procure a certiorari out of the court of chancery, directed to all the justices for removing the indictment into the king's bench; and upon that to obtain this writ, directed to the sheriff, for causing the body of the party to be brought at a certain day.

The other kind of habeas corpus is used for bringing the body of a person into court, who is committed to any goal or prison, either in civil or criminal causes; which writ will remove the person and cause from one court and prison to another.

No habeas corpus, or other writ, to remove a cause from

from out of an inferior court, can be allowed, if the same be not delivered to the judge of the court, before the jury who are to try the cause have appeared, and before any of them are sworn, 43 Eliz. c. 5.

The habeas corpus act, 31 Car. II. c. 2. has ordained, that a person may have a habeas corpus from any judge, on complaint made and view of the warrant of commitment, (except such person is committed for treason or felony expressed in the warrant, or some other offence that is not bailable) which habeas corpus must be made returnable immediately; and on producing a certificate of the cause of commitment, the prisoner is to be discharged on bail given to appear in the court of king's bench the next term, or next assizes, &c. Persons committed, for either treason or felony, expressly mentioned in the warrant, upon a motion made in open court, in the first week of the term, or day of sessions, &c. after commitment, are to be brought to trial; and if they are not indicted the next term or sessions after commitment, on a motion made the last day of that term, they shall be let out upon bail, except it appear on oath, that the king's witnesses are not ready; and in case they are not indicted or tried the second term after commitment, they shall be discharged.

Judges denying a habeas corpus, shall forfeit 500 l. and if an officer refuse to obey it, or to deliver a true copy of the commitment-warrant, he forfeits 100 l. for the first offence.

**HABIT**, in philosophy, an aptitude or disposition either of mind or body, acquired by a frequent repetition of the same act.

**HABIT**, in medicine, denotes the settled constitution of the body, or the habitude of any thing else, as the structure or composition of a body, or the parts thereof.

**HABIT** is also used for a dress or garb, or the composition of garments, wherewith a person is covered; in which sense we say, the habit of an ecclesiastic, of a religious, &c. a military habit, &c.

**HABITE AND REPUTE**, in Scots law, the common opinion of the people, among whom a person lives, with respect to any circumstance relating to him.

**HABITUAL**, something grown to a habit by long use. See **HABIT**.

**HABITUDE**, among schoolmen, the respect or relation one thing bears to another. See **RELATION**.

**HACHA**, a town of terra firma, in South America, situated on the north sea, at the mouth of the river Hacha. in W. long. 72°, N. lat. 11° 0'.

**HACKNEY**, a village on the north-east side of London, with a handsome church, three meeting-houses, and seventeen alms-houses.

**HADDINGTON**, a parliament-town in Scotland, about thirteen miles east of Edinburgh.

**HADDOCK**, the English name of a well known fish of the gadus kind. See **GADUS**.

**HADRAMUT**, a city of Arabia Felix, the capital of the province of Hadramut, situated in E. long. 50° 30', N. lat. 16°, three hundred and sixty miles north-east of Mecho.

**HÆMAGOGOS**, among physicians, a compound medicine consisting of fetid and aromatic simples, mixed with black hellebore; and prescribed in order to promote the menstrual and hæmorrhoidal fluxes, as also to bring away the lochia.

**HÆMANTHUS**, in botany, a genus of the hexandria monogynia class. The involucre is large, and consists of six leaves; the corolla is above the fruit, and divided into six parts; and the berry has three cells. There are four species, none of them natives of Britain.

**HÆMATITES**, or **BLOOD-STONE**, in natural history, an extremely rich and fine iron.

It is very ponderous, and is either of a pale red, a deeper red, or a bluish colour; usually of a very glossy surface; and when broken, of a fine and regularly striated texture; the striz converging toward the centre of the body; and the masses thereof naturally breaking into fragments of a broad base and pointed end; appearing something pyramidal. The hæmatites is various in its degrees of purity and hardness, as well as in its figure: the finest and most pure is of a botryoid surface; the whole superficies rising into larger or smaller roundish tubercles: sometimes the hæmatites is of a coarse texture, and a laxer structure, in which state it is known to many by the name schistus.

**HÆMATOPUS**, the **SEA-PYE**, in ornithology, a genus belonging to the order of grallæ. The beak is compressed with an equal wedge-shaped point; the nostrils are linear; and the feet have three toes without nails. There is but one species, viz. the astrægus, a native of Europe and America. It feeds upon shell-fish near the sea-shores.

**HÆMATOXYLUM**, **CAMPECHE-WOOD**, in botany, a genus of the decandria monogynia class. The calix is divided into five parts; the petals are five; the capsule is lanceolated, and contains one cell with two boat-shaped valves. There is but one species, viz. the campechianum, campechy or logwood, a native of America, near Carthage. It is usually brought home in large logs, very hard, of a red colour, and an astringent sweet taste. It has been long used by the dyers, but not till very late as a medicine: an extracted decoction of it are said to be serviceable in diarrhœas.

**HÆMOPTOSIS**, **HÆMPTYSIS**, or **HÆMOPTOE**, in medicine, a spitting of blood. See **MEDICINE**.

**HÆMORRHAGE**, in medicine, a flux of blood from any part of the body. See **MEDICINE**.

**HÆMORRHOIDAL**, an appellation given by anatomists to the arteries and veins going to the intestinum rectum. See **ANATOMY**, Part III. and IV.

**HÆMORRHIDS**, or **PILES**, in medicine, an hæmorrhage, or flux of blood from the hæmorrhoidal vessels. See **MEDICINE**.

**HAERLEM**, a populous city of the United Provinces, in the province of Holland, situated near the lake which from this town is called Haerlem-Meer; four miles east of the ocean, and twelve west of Amsterdam: E. long. 4° 20'. N. lat. 52° 30'.

**HAGAI**, a canonical book of the Old Testament, so called

called from the prophet of that name, who, in all probability was born at Babylon, from whence he returned with Zerubbabel.

**HAGENAU**, a fortified town of Germany, in the Landgraviate of Alsace: E. long.  $7^{\circ} 40'$ , N. lat.  $48^{\circ} 45'$ .

**HAGUE**, a town of the United Provinces, in the province of Holland, situated two miles east of the sea, and fourteen north-west of Rotterdam. This is one of the finest towns in Europe; but though it enjoys all the privileges of a city of Holland, except that of sending representatives to the state, yet, as it has no walls, it is only esteemed a village. Here every city of the United provinces has a house for their respective deputies, and here the states of the province of Holland assemble, and all public affairs are transacted.

**HAIL**, in physiology, an aqueous concretion, in form of white or pellucid spherules, descending out of the atmosphere.

Hail is evidently no other than drops of rain congealed into ice. This happens when in their passage thro' the inferior air, they meet with nitrous particles, which are known to contribute greatly to freezing. Their magnitude is owing to a fresh accession of matter as they pass along. Hence we see the reason why hail is so frequent in summer, because at that time greater quantities of nitre are exhaled from the earth, and float up and down the air. See **RAIN** and **FROST**.

**HAIMSUCKEN**, in Scots law, the assaulting or beating a man in his own house. See **SCOTS LAW**, title 33.

**HAIR**, slender, oblong, and flexible filaments, growing out of the pores of animals, and serving most of them as a covering. See **ANATOMY**, p. 256.

**HAKE**, in ichthyology. See **GADUS**.

**HALBERSTAT**, a city of Germany, in the circle of Upper Saxony, the capital of the duchy of the same name; subject to the king of Prussia, E. long.  $11^{\circ} 6'$ , N. lat.  $51^{\circ} 55'$ .

**HALCRYPTIUM**, a name given by Dr Hill to the salt suspended in a fluid form, and in very small quantities in mineral waters, scarce discernable by the taste, and with much difficulty separable from them.

**HALCYON**, in ornithology, a name given by the ancients to the alcedo, or kingfisher. See **ALCEDO**.

**HALCYON DAYS**, in antiquity, a name given to seven days before and as many after the winter solstice; by reason the halycon, invited by the calmness of the weather, laid its eggs in nests-build in the rocks, close by the brink of the sea, at this season.

**HALE**, in the sea-language, signifies pull; as, to hale up, is to pull up; to hale in or out, is to pull in or out. To over-hale a rope, is to hale it too stiff, or to hale it the contrary way.

**Keel-HALE**. See **DUCKING**.

**HALEM**, a town of the Austrian Netherlands, in the province of Brabant, twenty-five miles west of Maestricht: E. long.  $5^{\circ} 5'$ , N. lat.  $51^{\circ} 5'$ .

**HALESWORTH**, a market town of Suffolk, thirty-five miles east of Bury: E. long.  $1^{\circ} 40'$ , N. lat.  $52^{\circ} 30'$ .

**HALF-BLOOD**, in law, is where a man marries a fe-

cond wife, the first being dead, and by the first venter has a son, and by his second venter has likewise a son, the two brothers, in this case, are but of half blood.

**HALF-MERK**, a noble, or 6 s. 8 d.

**HALF-MOON**, in fortification, an outwork composed of two faces, forming a salient angle, whose gorge is in form of a crescent, or half moon; whence the name. See **FORTIFICATION**.

**HALIÆTUS**, in ornithology. See **FALCO**.

**HALIOTIS**, the **EAR-SHELL**, a genus of insects belonging to the order of Vermes testacea. This is an animal of the snail-kind, with an open shell resembling an ear. There are seven species, distinguished by the figure of their shells.

**HALL**, in geography, a town of Germany, in the circle of Austria, and county of Tyrol, situated six miles north-east of Innsbruck: E. long.  $11^{\circ} 28'$ , N. lat.  $47^{\circ} 15'$ .

**HALL** is also a town of the Austrian Netherlands in the province of Brabant, seven miles south of Brussels: E. long.  $4^{\circ} 10'$ , N. lat.  $50^{\circ} 50'$ .

**HALL** is also a city of Germany, in the circle of Upper Saxony, in the capity of a duchy situated on the river Sالا, subject to the king of Prussia: E. long.  $12^{\circ} 5'$ , N. lat.  $51^{\circ} 35'$ .

**HALL** is also a town of Germany, in the circle of Swabia, twenty miles east of Hailbron; being an imperial city, or sovereign state: E. long.  $9^{\circ} 45'$ , N. lat.  $49^{\circ} 20'$ .

**HALLAGE**, a fee or toll paid for cloth brought to be sold in Blackwell-hall, London.

**HALLAMASS**. See **ALL-SAINTS**.

**HALLELUJA**, a word signifying, praise the Lord.

The singing halleluja was a sort of invitatory, or call to each other, to praise the Lord.

St Austin says, that in some churches, it was sung only on Easter-day, and the fifty days of Pentecost; but that even in those churches where it was most in use, it was never used in the time of lent.

**HALLEN**, a town of the Austrian Netherlands, in the province of Brabant: E. long.  $5^{\circ}$ , N. lat.  $50^{\circ} 55'$ .

**HALLEIN**, a town of Germany, in the archbishopric of Saltzburg: E. long.  $13^{\circ} 6'$ , N. lat.  $47^{\circ} 36'$ .

**HALLER**, a town in the Netherlands, in the province of Brabant: E. long.  $5^{\circ}$ , N. lat.  $50^{\circ} 40'$ .

**HALLERIA**, in botany a genus of the didynamia angiosperma class. The calix has three segments, and the corolla four, the filaments are longer than the corolla; and the berry has two cells. There is but one species, a native of Æthiopia.

**HALLIFAX**, a large market town in the west riding of of Yorkshire, thirty-four miles south-west of York: W. long.  $1^{\circ} 40'$ , N. lat.  $53^{\circ} 45'$ .

**HALMSTAT**, a port-town of Gothland in Sweden, eighty miles south of Gottenberg: E. long.  $13^{\circ} 5'$ , N. lat.  $56^{\circ} 45'$ .

**HALO**, a meteor in the form of a luminous ring or circle, of various colours, appearing round the bodies of the sun, moon, or stars.

Concerning the production of halos, Sir Isaac Newton intimates, that they are formed by the light



- which comes through the drops of rain, by two refractions, without any reflection; but how this may be, is not easy to conceive.
- HALTWESEL**, a market-town of Northumberland, thirty-two miles west of Newcastle: W. long. 2°, N. lat. 55°.
- HAM**, in anatomy, the part behind the knee.
- HAM**, in geography, a city in Germany, in the circle of Westphalia, and the capital of the county of Mark, subject to Prussia: E. long. 7° 15', N. lat. 51° 35'.
- HAMA**, or **APAMEA**. See **APAMEA**.
- HAMADAN**, a city of Persia, in the province of Eyrac Agem, 200 miles north-west of Ispahan; E. long. 47° 35', N. lat. 35°.
- HAMADRYADS**, in heathen theology, certain rural deities; being nymphs of the woods, whose fate depended upon certain trees, together with which they were supposed both to be born and to die.
- HAMAMELIS**, in botany, a genus of the tetrandria digynia class. The involucre consists of three leaves, and the proper calix of four; the petals are four; and the nut has two cells. There is but one species, a native of Virginia.
- HAMAXOBIANS**, *hamaxobii*, an ancient people of European Sarmatia, so called from their living together in chariots or waggons, for the conveniency of shifting the place of their abode at pleasure.
- HAMBURGH**, a large city and well fortified port-town of Germany, in the circle of Lower Saxony, and duchy of Holstein, situated on the north side of the river Elb, partly on islands, and partly on the continent. It is an imperial city, or sovereign state, governed by its own magistrates, and subject only to the general laws of the empire. Merchants from all parts of Europe resort to it, from whence their goods are sent into the heart of the empire: E. long. 9° 40', N. lat. 54°.
- HAMCHEU**, the capital of the province of Chekiam, in China, situated on the river Cienton, 160 miles south-east of Nanking: E. long. 120°, N. lat. 30°.
- HAMELIN**, a town of Germany, in the circle of lower Saxony, and duchy of Brunswic, subject to the elector of Hanover: E. long. 9° 12', N. lat. 52° 15'.
- HAMILTON**, a town of Scotland, in the county of Clydesdale, situated on the river Clyde, eleven miles south-east of Glasgow: W. long. 3° 50', N. lat. 55° 40'.
- HAMLE**, the name of the eleventh month of the Ethiopian year, beginning on the 25th of June, old style.
- HAMMONT**, a town of Germany, in the circle of Westphalia, and bishopric of Liege, situated near the confines of Brabant: E. long. 5° 32', N. lat. 51° 20'.
- HAMPSHIRE**, an English country, bounded by Berkshire, on the north; by Surry and Sussex, on the east; by the English channel, on the south; and by Wiltshire and Dorsetshire, on the west. It comprehends the isle of Wight. Its chief towns are Winchester, Southampton, and Portsmouth.
- New HAMPSHIRE**, a province of New England, in North America, bounded by Nova Scotia, on the north; by the Atlantic ocean, on the east; by the province of Massachusetts bay, on the south; and by New York, on the west: subject to Great Britain.
- HAMPSTEAD**, a pleasant village in Middlesex, four miles north of London.
- HAMPTON**, a market-town of Gloucestershire, twelve miles south of Gloucester: W. long. 2° 15', N. lat. 51° 38'.
- HAMPTON-COURT**, a town in Middlesex, situated on the north side of the Thames, twelve miles west of London, and two west of Kingston; in which is the finest palace belonging to the king of Britain.
- HANAU**, the capital of a county of the same name in Germany, is pleasantly situated on the river Kunts, thirteen miles east of Frankfort, and twelve north-west of Aschaffenburg: E. long. 8° 45', N. lat. 50° 12'.
- HAND**, in anatomy. See **ANATOMY**, Part I. II. &c.
- HAND**, in the manege, a measure of four inches, or of a clinched fist, by which the height of a horse is computed.
- HAND-BREADTH**, a measure of three inches.
- HANDS**, in heraldry, are borne in coat-armour dexter and sinister, that is, right and left, expanded or open. These are the most necessary parts of the human body, as they serve to express all sorts of actions, and even our very thoughts and designs; thus, joining of hands is an universal token of friendship, and clapping of hands a general mark of applause.
- HANOVER**, a city of Germany, in the circle of Lower Saxony, and dukedom of Brunswic, situated on the river Leina, thirty-six miles west of Brunswic: it is the capital of his Britannic majesty's German dominions, situated in E. long. 9° 45', N. lat. 52° 32'.
- HANSE**, or **HANS**, a company of merchants united for the promotion and advantage of trade.
- HANSE-TOWNS**, port-towns of Germany of which Lubeck and Hamburg were the chief. They were formerly all of them imperial cities, confederated for their mutual defence, and the protection of their trade.
- HAPPINESS**, among philosophers, consists in the prosecution or enjoyment of some good.
- HARBINGER**, an officer of the king's household, having four yeomen under him, who ride a day's journey before the court, when it travels, to provide lodgings, &c.
- HARBOROUGH**, a town of Leicestershire, thirteen miles south-east of Leicester: W. long. 1° N. lat. 52° 26'.
- HARBOUR**, a place where ships may ride safe at anchor, chiefly used in speaking of those secured by a boom and chain, and furnished with a mole.
- HARBURGH**, a port town of Germany, in the circle of Lower Saxony, and duchy of Lunenburg, situated on the river Elbe, opposite to Hamburg: E. long. 9° 30', N. lat. 53° 57'.
- HARCOURT**, a town of France, in the province of Normandy, twenty-three miles south-west of Rouen.
- HARDENING**, the giving a greater degree of hardness to bodies than they had before.
- There are several ways of hardening iron and steel, as by hammering them, quenching them when hot in cold water, &c. **CHEMISTRY**, p. 124.

HARDERWICK,

**HARDERWICK**, a town of Guelderland, in the United Netherlands, twenty-three miles north west of Zutphen: E. long.  $5^{\circ} 30'$ . N. lat.  $52^{\circ} 35'$ .

**HARDNESS**, in physiology, that quality in bodies whereby their parts cohere firmly together, so as not to give way to any external impulse, nor yield inwards, without breaking.

In this sense hardness coincides with what on other occasions we call firmness, in opposition to softness and fluidity.

**HARE**, in zoology. See **LEPUS**.

**HARE-LIP**, in surgery. See **SURGERY**.

**HARENGUS**. See **CEUPEA**.

**HARFLEUR**, a port-town of France, in the province of Normandy, situated near the mouth of the Seyne, four miles west of Havre de Grace: E. long.  $15^{\circ}$  N. lat.  $49^{\circ} 30'$ .

**HARIOT**, or **HERRIOT**, in law, a due belonging to a lord at the death of his tenant, consisting of the best beast, either horse, ox, or cow, which he had at the time of his death; and in some manors, the best goods, piece of plate, &c. are called hariots.

**HARLEBECK**, a town of the Austrian Netherlands, in the province of Flanders, situated on the river Lys, six miles north-east of Courtray: E. long.  $3^{\circ} 15'$ , N. lat.  $50^{\circ} 50'$ .

**HARLEQUIN**, a buffoon or merry andrew; but is now used for a person of extraordinary agility, dressed in party-coloured cloaths, the principal character in a pantomime entertainment. See **PANTOMIME**.

**HARLESTON**, a market-town of Norfolk, situated on the river Waveney, fourteen miles south of Norwich: E. long.  $1^{\circ} 25'$ , N. lat.  $52^{\circ} 35'$ .

**HARLINGEN**, a port-town of the United Netherlands, in the province of West Friesland, situated on the German sea: E. long.  $5^{\circ} 20'$ , N. lat.  $53^{\circ} 15'$ .

**HARLOW**, a market-town of Essex, situated fifteen miles west of Chelmsford: E. long.  $6'$ , N. lat.  $51^{\circ} 45'$ .

**HARMONICAL**, something belong to harmony. See **HARMONY**.

**HARMONICAL COMPOSITION**, in a general sense, includes both harmony and melody, *i. e.* of music or songs, both in a single part, and in several parts.

**HARMONICAL SERIES**, a series of many numbers in continual harmonical proportion. Thus, if there are four or more numbers, of which every three immediate terms are harmonical, the whole will make an harmonical series: such is  $30 : 20 : 15 : 12 : 10$ . Or, if every four terms immediately next each other are harmonical, it is also a continual harmonical series, but of another species, as  $3, 4, 6, 9, 18, 36$ , &c.

**HARMONICAL SOUNDS**, an appellation given, by Mr Sauveur, to such sounds as always make a determinate number of vibrations, in the time that one of the fundamentals, to which they are referred, makes one vibration.

Harmonical sounds are produced by the parts of chords, &c. which vibrate a certain number of times, while the whole chord vibrates once.

The relations of sounds had only been considered in the series of numbers,  $1 : 2, 2 : 3, 3 : 4, 4 : 5$ , &c. which produced the intervals called octave, fifth, fourth, third, &c. Mr Sauveur first considered them in the natural series,  $1, 2, 3, 4, 5$ , &c. and examined the relations of sounds arising therefrom. The result is, that the first interval,  $1 : 2$ , is an octave; the second,  $1 : 3$ , a twelfth; the third,  $1 : 4$ , a fifteenth, or double octave; the fourth,  $1 : 5$ , a seventeenth; the fifth,  $1 : 6$ , a nineteenth, &c.

This new consideration of the relations of sounds is more natural than the old one; and is, in effect, all the music that nature makes without the assistance of art.

**HARMONICS**, that part of music which considered the differences and proportions of sounds, with respect to acute and grave; in contradistinction to rythmica and metrica.

**HARMONY**, in music, the agreeable result or union of several musical sounds heard at one and the same time; or the mixture of divers sounds, which together have an effect agreeable to the ear.

**HARMONY of the spheres**, or **Celestial HARMONY**, a sort of music much talked of by many of the ancient philosophers and fathers, supposed to be produced by the sweetly tuned motions of the stars and planets. This harmony they attributed to the various proportionate impressions of the heavenly globes upon one another, acting at proper intervals. It is impossible, according to them, that such prodigious large bodies, moving with so much rapidity, should be silent; on the contrary, the atmosphere continually impelled by them, must yield a set of sounds proportionate to the impression it receives; consequently, as they do not all run the same circuit, nor with one and the same velocity, the different tones arising from the diversity of motions, directed by the hand of the Almighty, must form an admirable symphony, or concert.

They therefore supposed, that the moon, as being the lowest of the planets, corresponded to *mi*; mercury, to *fa*; venus, to *sol*; the sun, to *la*; mars, to *si*; jupiter, to *ut*; saturn, to *re*; and the orb of the fixed stars, as being the highest of all, to *mi*, or the octave.

**HARP**, a musical instrument of the string-kind, of a triangular figure, held upright between the legs of the person who plays upon it.

**HARPIES**, among the ancient poets, fabulous impure monsters, said to be the daughters of Neptune and Earth. Virgil mentions three of them, Aello, Ocypete, and Celæno; they are described to be fowls, with the face of a virgin, bears ears, their bodies like vultures, and hands like their crooked talons.

**HARPINEER**, or **HARPONEER**, the person who manages the harping-iron.

**HARPSICORD**, the most harmonious of all the musical instruments of the string-kind. It is played on after the manner of the organ, and is furnished with a set, and sometimes with two sets of keys; the touching or striking of these keys moves a kind of little jacks,

which

which also move a double row of chords or strings, of brass or iron, stretched over four bridges on the table of the instrument.

**HARQUEBUSS**, a piece of fire-arms, of the length of a mulket, usually cocked with a wheel. It carried a ball that weighed one ounce seven eighths.

There was also a larger sort, called the great harquebuss, used for the defence of strong places, which carried a ball of about three ounces and a half: but they are now but little used, except in some old castles, and by the French in some of their garrisons.

**HARRIER**, a kind of hound, endowed with an admirable gift of smelling, and very bold in the pursuit of his game.

**HARROW**, in agriculture. See **AGRICULTURE**, p. 58.

**HART**, a stag, or male deer, in the sixth year. See **CERVUS**.

**HART'S HORNS**, in pharmacy, the whole horns of the common male deer, as separated from the head, without farther preparation.

The chemical analysis of hart's-horn is sufficiently known: it yields a water highly impregnated with a volatile salt, which is called spirit of hart's-horn, with a fetid oil, and a volatile salt by the common distillation in a retort.

The salt of hart's horn is a great sudorific, and is given in fevers of many kinds with great success; the spirit has the same, and all the other virtues of volatile alkalis, and is used to bring people out of faintings by its pungency, on holding it under their nose, and at the same time pouring some drops of it in water down the person's throat.

**HART-WORT**, in botany. See **TORDYLLIUM**.

**HARTFORD**, the capital of Hertfordshire, situated twenty-one miles north of London: W. long. 7', and N. lat. 51° 45'.

**HARTFORD** is also a town of New England, in the province of Connecticut, situated 50 miles west of Boston: W. long. 71° 15', and N. lat. 42°.

**HARTLAND**, a market-town of Devon, situated near the Bristol channel; it gives name to a cape, called Hartland-point, at the entrance of the Bristol channel: W. long. 4° 45', and N. lat. 51° 9'.

**HARTLEPOOL**, a port-town of the county of Durham, situated on the German ocean; fourteen miles south-east of Durham: W. long. 55', and N. lat. 54° 40'.

**HARVEST**, the time or season that the corn is ripe, and fit to be reaped and taken into barns.

**HARWICH**, a borough and port-town of Essex, sixty-two miles north-east of London: E. long. 1° 25', N. lat. 52° 5'. It sends two members to parliament.

**HASLEM**, an island of Denmark, in the Categate-sea, north of the island of Zealand.

**HASLEMERE**, a borough-town of Surry, thirty eight miles south-west of London, and ten miles south-west of Guildford. It sends two members to parliament.

**HASSELT**, a town of Westphalia, in Germany, fifteen miles north-west of Mætricht.

**HASSIDEANS**, or **ASSIDEANS**, an appellation given

to those Jews who resorted to Mattathias, to fight for the law of God, and the liberties of their country.

**HASSOCK**, a bals made of rushes, to kneel or rest the feet upon in churches.

**HASP** and **STAPLE**, in Scots law, the symbol commonly used in burgage tenements for entering and infesting an heir, by delivering into his hands the hasp and staple of the door. See **SCOTS LAW**, title 27.

**HASTA**, among medallists, a kind of javelin, not shod or headed with iron; or rather an ancient sort of sceptre, longer than ordinary, occasionally given to all the gods.

**HASTATED LEAF**. See **BOTANY**, p. 639.

**HASTINGS**, a borough-town of Suffex, situated on the coast of the English channel, fifty miles south-east of London: E. long. 36', and N. lat. 50° 50'.

**HAT**, a covering for the head, worn by the men in most parts of Europe. Those most in esteem are made of the pure hair of the castor or beaver; for they are also made of the hair or wool of divers other animals, and that by much the same process.

*Method of making HATS.* To make the beaver-hats, they tear off the long and short hair from the skin, with knives suitable to the occasion: after which they proportion the quantity of the several sorts of beaver-hair, by mixing one third of the dry castor to two thirds of old-coat, which is a term for a skin that has been worn some time by the Indians of America; who catch and sell them to the Europeans. The hair, so mixed, is carded and weighed out into parcels, according to the size and thickness of the hat intended. The stuff is now laid on the hurdle, with an instrument called a bow, resembling that of a violin, but larger; whose string being worked with a small bow-stick, and made to play on the furs, they fly, and mix themselves together, the dust and filth at the same time passing through the chinks. Instead of a bow, some hat-makers use a scarce of hair, through which they pass the stuff. Thus hats are formed of an oval figure, ending with an acute angle at the top: with what stuff remains, they strengthen them where slenderest, yet designedly make them thicker in the brim near the crown, than towards the circumference, or in the crown itself. They next harden the stuff, so managed, into more compact flakes, by pressing down a hardened leather upon it. This done, they are carried to the bason, upon which laying one of the hardened hats, they sprinkle it over with water, and mould it; and the heat of the fire, with the water and pressing, embody the stuff into a slight hairy sort of felt; after which, turning up the edges all round over the mould, they lay it by, and proceed with another; which being in like manner reduced to the same consistence and form, they are both joined together, so as to make them meet in an angle at top, making only one conical cap. The next process is to remove the hat to a trough, resembling a mill-hopper, which is a copper kettle filled with water and grounds, kept hot for the purpose; and, after being dipped in the kettle, the hat is laid on the sloping side, called the plank. Here they proceed to work it, by rolling and unrolling it again

again and again, one part after another, first with the hand, and afterwards with a small wooden roller, taking care to dip it from time to time, till at length, by thus fulling and thickening it four or five hours, it is brought to the dimensions intended. In this violent labour, the workmen usually guard their hands with thick leather, which they call gloves. The hat thus wrought into the form of a conical cap, is reduced into proper shape on a block of the size of the intended crown, by tying it round with a string, called a commander; after which, with a bent iron, called a stamper, they gradually beat down the commander all round, till it has reached the bottom of the block, and what remains at the bottom below the string forms the brim. In this station it is set to dry, and afterwards singed, by holding it over the blaze of a fire, made of straw, or shavings: it is then rubbed with pumice-stone, to take off the coarser nap; then rubbed over with seal skin, to lay the nap still finer; and, lastly, carded with a fine card, to raise the fine cotton, with which the hat is to appear when finished: then fitting it to the block, they tie it, cut round the edges, and deliver it to the dyers. (See DYEING.) The dye being completed, the hat is dried by being hung in the roof of a stove heated with a charcoal-fire; and, when dry, it is stiffened with melted glue, or rather gum-senega, which is smeared over the hat with a brush, and rubbed in with the hand. Then, having spread a cloth over the steaming basin, which is a little fire-place raised about three feet high, with an iron plate laid over it, exactly covering the fire, the hat is laid upon the cloth, with the brim downwards, the cloth being first sprinkled with water, to raise a strong steam, to force in the stiffening. When it is moderately hot, the workman strikes gently on the brim, with the flat of his hand, to make the joinings incorporate and bind so as not to appear, turning it from time to time, and at last setting it on the crown. And when it has been sufficiently steamed and dried, it is put again on the block, brushed, ironed, well smoothed, and fitted for lining.

Hats make a considerable article in commerce: England supplies Spain, Portugal, Italy, and Germany, with extraordinary quantities of them; and as our manufacturers have the reputation of making the best hats in Europe, their importation is prohibited.

**HATS** are also made for womens wear, of chips, straw, or cane, by plating, and sewing the plats together; beginning with the centre of the crown, and working round till the whole is finished. Hats for the same purpose are also wove and made of horse-hair, silk, &c.

**HATCHEL**, or **HITCHEL**, a tool with which flax and hemp are combed into fine hairs. It consists of long iron pins, or teeth, regularly set in a piece of board.

**HATCHES**, in a ship, a kind of trap-doors between the main-mast and fore-mast, through which all goods of bulk are let down into the hold.

**HATCH WAY**, the place where the hatches are. Thus, to lay a thing in the hatch way, is to put it so, that the hatches cannot be come at, or opened.

**HATCHING**, the maturing fecundated eggs, whether

by the incubation and warmth of the parent-bird, or by artificial heat, so as to produce young chickens alive.

The art of hatching chickens by means of ovens has long been practised in Egypt; but it is there only known to the inhabitants of a single village named Berme, and to those that live at a small distance from it. Towards the beginning of autumn they scatter themselves all over the country, where each person among them is ready to undertake the management of an oven, each of which is of a different size, but in general they are capable of containing from forty to fourscore thousand eggs. The number of these ovens placed up and down the country is about three hundred and eighty-six, and they usually keep them working for about six months: as therefore each brood takes up in an oven, as under a hen, only twenty-one days, it is easy in every one of them to hatch eight different broods of chickens. Every Bermean is under the obligation of delivering to the person who intrusts him with an oven, only two thirds of as many chickens as there have been eggs put under his care; and he is a gainer by this bargain, as more than two thirds of the eggs usually produce chickens. In order to make a calculation of the number of chickens yearly so hatched in Egypt, it has been supposed, that only two thirds of the eggs are hatched, and that each brood consists of at least thirty thousand chickens; and thus it would appear, that the ovens of Egypt give life yearly to at least ninety-two millions six hundred and forty thousand of these animals.

This useful and advantageous method of hatching eggs has been lately discovered in France, by the ingenious Mr Reaumur, who, by a number of experiments, has reduced the art to certain principles. He found by experience that the heat necessary for this purpose is nearly the same with that marked 32 on his thermometer, or that marked 96 on Fahrenheit's. This degree of heat is nearly that of the skin of the hen, and, what is remarkable, of the skin of all other domestic fowls, and probably of all other kinds of birds. The degree of heat which brings about the development of the cygnet, the golling, and the turkey-pout, is the same as that which fits for hatching the canary-songster, and, in all probability, the smallest humming bird: the difference is only in the time during which this heat ought to be communicated to the eggs of different birds: it will bring the canary bird to perfection in eleven or twelve days, while the turkey-pout will require twenty-seven or twenty-eight.

After many experiments, Mr Reaumur found that stoves heated by means of a baker's oven, succeeded better than those made hot by layers of dung: and the furnaces of glass-houses, and those of the melters of metals, by means of pipes, to convey heat into a room, might, no doubt, be made to answer the same purpose. As to the form of the stoves, no great nicety is required; a chamber over an oven will do very well; nothing more will be necessary but to ascertain the degree of heat, which may be done by melting a lump of butter, of the size of a walnut, with half as much tal-

low, and putting it into a phial; this will serve to indicate the heat with sufficient exactness, for when it is too great, this mixture will become as liquid as oil, and when the heat is too small, it will remain fixed in a lump; but it will flow like a thick syrup, upon inclining the bottle, if the stove be of a right temper: great attention therefore should be given to keep the heat always at this degree, by letting in fresh air, if it be too great, or shutting the stove more close, if it be too small; and that all the eggs in the stove may equally share the irregularities of the heat, it will be necessary to shift them from the sides to the centre; thereby imitating the hens, who are frequently seen to make use of their bills, to push to the outer parts those eggs that were nearest to the middle of their nests, and to bring into the middle such as lay nearest the sides.

Mr Reaumur has invented a sort of low boxes, without bottoms; and lined with furs. These, which he calls artificial parents, not only shelter the chickens from the injuries of the air, but afford a kindly warmth, so that they presently take the benefit of their shelter as readily as they would have done under the wings of a hen. After hatching, it will be necessary to keep the chickens, for some time, in a room artfully heated and furnished with these boxes; but afterwards they may be safely exposed to the air in the court yard, in which it may not be amiss to place one of these artificial parents to shelter them if there should be occasion for it.

As to the manner of feeding the young brood, they are generally a whole day after being hatched, before they take any food at all; and then a few crumbs of bread may be given them for a day or two, after which they will begin to pick up insects and grass for themselves.

But to save the trouble of attending them, capons may be taught to watch them in the same manner as hens do. Mr Reaumur assures us, that he has seen above two hundred chickens at once, all led about and defended only by three or four such capons. Nay, cocks may be taught to perform the same office, which they, as well as the capons, will continue to do all their lives after.

**HATFIELD**, a market-town of Hertfordshire, situated twenty miles north west of London.

**HATHERLY**, a market-town of Devonshire, twenty miles north west of Exeter.

**HATTEM**, a town of Gelderland, one of the United Provinces: E. long 6°, N. lat. 52° 30'.

**HATTOCK**, a shock of corn containing twelve sheaves: others make it only three sheaves laid together.

**HATUAN**, a town of Upper Hungary, fifteen miles north east of Buda: E. long. 19° 35', and N. lat. 47° 48'.

**HAVANNA**, a port-town of the island of Cuba, in America, situated at the entrance of the gulph of Mexico: subject to Spain: W. long. 84°, and N. lat. 23°.

**HAVANT**, a market town of Hampshire, six miles north-east of Portsmouth.

**HAVEL**, a river of Brandenburg, in Germany, which

receives the river Spree, near Berlin, and discharges itself into the Elbe, a little below Havelburg.

**HAVELBURG**, a town of Germany, in the circle of Upper Saxony, and marquise of Brandenburg, subject to the king of Prussia: E. long. 12° 44', and N. lat. 53°.

**HAVEN**, a sea-port or harbour. See **HARBOUR**.

**HAVERFORD-WEST**, a borough-town of Pembroke-shire, in south Wales, situated twelve miles south east of St David's. It sends only one member to parliament.

**HAUNCH**, or **HANCH**, the hip, or that part of the body between the last ribs and the thigh.

**HAVRE DE GRACE**, is a port-town of France, in the province of Normandy, situated on the English channel, at the mouth of the river Seyne: E. long. 10', and N. lat. 49° 30'.

**HAUTBOY**, a musical instrument of the wind kind, shaped much like the flute, only that it spreads and widens towards the bottom, and is sounded through a reed. The treble is two feet long; the tenor goes a fifth lower, when blown open: it has only eight holes; but the bass, which is five feet long, has eleven.

**HAW**, a sort of berry, the fruit of several species of *mespilus*, thence denominated haw-thorns. See **MESPIBUS**.

**HAW**, among farriers, an excrescence resembling a gristle, growing under the nether eye-lid and eye of a horse, which, if not timely removed, will put it quite out. See **FARRIER**.

**HAWK**. See **FALCO**.

**HAWKING**, the exercise of taking wild-fowl by means of hawks.

**HAWSER**, in the sea-language, a large rope, or a kind of small cable, serving for various uses a-board a ship, as to fasten the main and fore shrouds, to warp a ship as she lies at anchor, and wind her up to it by a capstan, &c. The hawser of a man of war may serve for a cable to the sheet-anchor of a small ship.

**HAWSES**, in a ship, are two large holes under the bow, through which the cables run when she lies at anchor.

**HAY**, any kind of grass, cut and dried, for the food of cattle.

The time of mowing grass for hay, must be regulated according to its growth and ripeness; nothing being more prejudicial to the crop than mowing it too soon, because the sap is not then fully come out of the root, and when made into hay, it shrinks away to nothing. It must not, however, be let stand too long, till it have shed its seeds. When the tops of the grass look brown, and begin to bend down, and the red honey-suckle flowers begin to wither, you may conclude it ripe for mowing.

*St Foin Hay*. See **AGRICULTURE**, p. 65.

**HAY**, in geography, a market-town in Brecknockshire, south Wales, thirteen miles north-east of Brecknock.

**HAYNAULT**, a province of the Netherlands, bounded by Brabant and Flanders, on the north; by Namur and

and Liege, on the east; by the Cambresis, Picardy, and Champaign, on the south; and by Artois, and another part of Flanders, on the west: the north part is subject to the house of Austria, and the south part to France. Its capital is Mons.

**HAYWARD**, the person who keeps the common herd or cattle of a town.

**HAZARD**, a game on dice, without tables, is very properly so called; since it speedily makes a man, or undoes him.

It is played with only two dice; and as many may play at it as can stand round the largest round table.

Two things are chiefly to be observed, *viz.* main and chance; the latter belonging to the caster, and the former, or main, to the other gamblers. There can be no main thrown above nine, nor under five; so that five, six, seven, eight, and nine, are the only mains flung at hazard. Chances and nicks are from four to ten: thus four is a chance to nine, five to eight, six to seven, seven to six, eight to five; and nine and ten a chance to five, six, seven, and eight: in short, four, five, six, seven, eight, nine, and ten, are chances to any main, if any of these nick it not. Now nicks are either when the chance is the same with the main, as five and five, or the like; or six and twelve, seven and eleven, eight and twelve. Here observe, that twelve is out to nine, seven, and five; eleven is out to nine, eight, six, and five; and ames-ace and duce-ace, are out to all mains whatever.

**HAZLE**, in botany. See **CORYLUS**.

**HAZLE-EARTH**, or **HAZLEY EARTH**, a kind of red loam, which is said to be an excellent mixture with other sorts of earth; uniting what is too loose, cooling what is too hot, and gently entertaining the moisture.

**HEAD**, in anatomy. See **ANATOMY**, Part I. II &c.

**HEAD-ACH**, a most troublesome sensation in the head, produced by various causes, and attended with different symptoms, according to its different degrees, and the place where it is seated. See **MEDICINE**.

**Dragon's HEAD**, in astronomy, &c. is the ascending node of the moon, or other planet.

**HEADFORD**, a town of Galway, in Ireland, twelve miles north of the city of Galway.

**HEALTH** is a right disposition of the body, and of all its parts; consisting in a due temperature, a right conformation, just connection, and ready and free exercise of the several vital functions.

**HEAM**, in beasts, is the same with the secundines, or after-birth in women.

**HEARING**, the sense whereby we perceive sounds.

The organ of hearing is the ear, and particularly the auditory nerve and membrane. See **ANATOMY**, p. 295.

This membrane, in the various degrees of tension and relaxation, adapts itself to the several natures and states of sonorous bodies; becoming tense for the reception of acute sounds, and relaxed for the admission of grave sounds. In short, it is rendered tense and relaxed in a thousand different degrees, according to the various degrees of acuteness or gravity in sounds.

Sound, then, is in effect nothing out a certain mo-

dulation of the air, which being collected by the external ear, passes through the meatus auditorius, and beats upon the membrane of the tympanum, which moves the bones in the tympanum: these move the internal air, which finally communicates the motion to the auditory nerve, in the labyrinth and cochlea; and according as the vibrations are quick or slow, the sound is either acute or grave.

It deserves observation, that though the air be the usual matter of sounds; so that if a bell be hung in vacuo, it will not be heard at all; yet most other bodies, properly disposed, will do its office, only some more faintly than others. Thus a sound may be heard through water, or even through earth, of which there are various instances.

As the sight is assisted by spectacles, or other glasses; so the hearing is enlivened and rendered quick, by means of acoustic instruments; which are of various figures, but for the most part bear some resemblance to a trumpet, diverging and growing wider towards the external mouth.

**HEARSE**, among sportsmen, a hind of the second year of her age.

**HEART**, in anatomy. See **ANATOMY**, p. 278.

*Force of the HEART.* Several ingenious persons have, from time to time, attempted to make estimates of the force of the blood in the heart and arteries; who have as widely differed from each other, as they have from the truth, for want of a sufficient number of data to argue upon. This set the truly ingenious Dr Hales upon making proper experiments, in order to ascertain the force of the blood in the veins and arteries of several animals.

If, according to Dr Keil's estimate, the left ventricle of a man's heart throw out in each systole an ounce or 1.638 cubic inches of blood, and the area of the orifice of the aorta be = 0.4187: then dividing the former by this, the quotient 3.9 is the length of the cylinder of blood, which is formed in passing through the aorta in each systole of the ventricle; and in the seventy-five pulses of a minute, a cylinder of 292.5 inches in length will pass: this is at the rate of 1462 feet in an hour. But the systole of the heart being performed in one third of this time, the velocity of the blood in that instant will be thrice as much, *viz.* at the rate of 4386 feet in an hour, or 73 feet in a minute. And if the ventricle throws out one ounce in a pulse, then in the seventy-five pulses of a minute, the quantity of blood will be equal to 4.4 lb 11 oz. and, in thirty-four minutes, a quantity equal to a middle-sized man, *viz.* 158 lb. will pass through the heart. But if, with Dr Harvey and Dr Lower, we suppose two ounces of blood, that is, 3.276 cubic inches, to be thrown out at each systole of the ventricle, then the velocity of the blood in entering the orifice of the aorta, will be double the former, *viz.* at the rate of 146 feet in a minute, and a quantity of blood equal to the weight of a man's body will pass in half the time, *viz.* 17 minutes.

If we suppose, what is probable, that the blood will rise  $7\frac{1}{2}$  feet high in a tube fixed to the carotide artery

tery of a man, and that the inward area of the left ventricle of his heart is equal to fifteen square inches; these multiplied into  $7\frac{1}{2}$  feet, give 1350 cubic inches of blood, which presses on that ventricle, when it first begins to contract, a weight equal to 15.5 pounds.

What the doctor thus calculates, from supposition, with regard to mankind, he actually experimented upon horses, dogs, fallow does, &c. by fixing tubes, in

orifices opened in their veins and arteries; by observing the several heights, to which the blood rose in these tubes, as they lay on the ground; and by measuring the capacities of the ventricles of the heart, and orifices of the arteries. And, that the reader may the more readily compare the said estimates together, he has given a table of them, ranged in the following order.

The several animals.	Weight of each.		Height of the blood in the tube from the jugular vein.		Height of the blood in tubes fixed to arteries.		Capacity of the left ventricle of the heart.	Area of the orifice of the aorta.	Velocity of the blood in the aorta.	Quantities of blood equal to the weight of the animal, in what time.	How much in a minute.	Weight of the blood sustained by the left ventricle contracting.	N <sup>o</sup> of pulses in a minute.	Area of transverse section of descending aorta.	Area of the transverse section of ascending aorta.
	Pounds.	Ounces.	Inches.	Feet Inches.	Cubic inches.	Square inches.	Feet and inches in a minute.	Minutes.	Pounds.	Pounds.	Square inches.	Square inches.			
Man	160		On straining.	7 6	1.659 3.318	0.4187	56.55 113.3	34.18 17.5	4 38 9.36	51.5	75				
Horse 1ft. 2d. 3d.	825 1600		12 52	8 3 9 8 9 6	10 12.5	1.036 1.539	86.85 76.95	60 88	13.75 18.14	113.22	86 38	0.677 0.912	0.369 0.84		
Ox	91		5 $\frac{1}{2}$ 9	6 5 $\frac{1}{2}$ 4 2	1 85 9	0.172 0.476	174.5	20	4.593	36.56	65	0.094 0.383	0.07 0.246	right. left.	
Sheep Doe	52 24 18 12 8		0 6	6 8 2 8 4 8 3 3	1.172 1 0.633 0.5	0.196 0.185 0.118 0.101	144.77 130.9 130 120	11.9 6.48 7.8 6.7	4 34 3.7 2.3 1.85	33.61	97	0.106 0.102 0.07 0.061	0.041 0.031 0.022 0.015	0.034 0.009 0.009 0.007	

HEAT, in physiology, one of the secondary qualities of bodies, produced by fire, and opposed to cold.

Under the article fire, we considered the sun as the principal source of heat upon the earth's surface, and the confines of the earth and atmosphere: without this, all the bodies upon our globe would doubtless grow rigid, lifeless, and fixed. It is this that stirs within them, as the main spring of their actions. Hence vegetation and animalization are evidently promoted; and hence the ocean and the atmosphere continue in a fluid state.

Heat in us is properly a sensation, excited by the action of fire; or it is the effect of fire on our organs of feeling. Hence it follows, that what we call heat is a particular idea or modification of our own mind, and not any thing existing in that form in the body that occasions it. Heat, says Mr Locke, is no more in the fire that burns the finger, than pain is in the needle that pricks it. In effect, heat in the body that

gives it, is only motion; and in the mind, only a particular idea.

Heat in the hot body, according to 'S Gravesande, is an agitation of the parts of the body, made by means of the fire contained in it: by such an agitation a motion is produced in our bodies, which excites the idea of heat in our mind; so that heat in respect of us is nothing but that idea, and in the hot body nothing but motion. If such motion expel the fire in right lines, it gives us the idea of light; if in a various and irregular motion, only heat.

Heat, with respect to our sensations, or the effect produced on us by a hot body, is estimated by its relation to the organ of feeling; no object appearing to be hot, unless its heat exceed that of our body. Whence the same thing to different persons, or at different times to the same person, shall appear both hot and cold. The degree of heat is measured by the expansion of the air, or spirit in the thermometer.

It

It has been justly observed, by some of our modern philosophers, that actual or absolute heat, is to sensible or relative heat, the same as motion is to velocity: for absolute heat is nothing but the whole motion of all the parts of the ignited body; and sensible or relative heat, respects only the comparative velocity of the parts. Thus, equal bulks of mercury and water set in a sand-heat, where the heat of the fire may be uniformly communicated to both, will acquire in equal times equal degrees of absolute heat: but the relative heat of the water, or that which is sensible to the finger, will be near 14 times as great as that of the mercury, because the water, having 14 times a less quantity of matter, will admit of velocity so much in proportion greater.

Again, if mercury and water have the same relative or sensible heat, that is, if both are heated in such a manner as to cause an equal ascent in the thermometer, then a quantity of mercury will heat 14 times as much water as the same quantity of water will do; or it will make the same quantity of cold water 14 times hotter than the same quantity of hot water can. All which is easy to be shewn by experiment, and abundantly proves, that heat and fire are wholly owing to the velocity of the parts of the heated or ardent body: on which theory the various phenomena of heat, cold, fire, burning, &c. are rationally accounted for. For, first, we are to consider, that cold and heat are only comparative terms, or that the same thing may either be too hot, or too cold, according to the relative idea or standard degree. Thus, ice or snow is said to be cold with respect to the finger, but ice or snow is warm if compared to a freezing mixture; so that if (as we commonly do) we make the hand or any part of the body the standard of heat or cold, or the term of comparison; then it is evident, 1. If the parts of any body, applied to the hand, have the same velocity as the parts of the hand, such a body we naturally pronounce is neither hot nor cold. 2. If the particles of the body have a greater velocity than those of the hand, we pronounce it warm, if the excess be small; but hot, if it be great. 3. If the velocity of the parts of the body applied be less than that in the hand, the sensation then is what we call cold, which also may be in various degrees. 4. Hence it is plain, there can be no such thing as absolute cold, but where the particles of matter are absolutely quiescent or at rest. 5. Hence also, there can be no such thing as absolute heat, because no degree of velocity can be assigned but a greater is still assignable, till we come to infinity, where we are quite lost, as having no idea of infinite velocity or heat.

From this theory of heat and cold we may conclude, that there is no body in nature whose parts are not in motion, in some degree, since we have yet been able to discover no ultimate degree or limit of cold; and if any such thing were to be found in nature, it is likely that it would be as impossible to bear or endure the test, as any extreme degree of heat; both heat and cold naturally tending to destroy the animated part, or test, in the extreme degrees: cold, by destroying

the vital motion, and fixing the part rigid and inflexible; but heat, by putting the parts into too great an agitation, causing a greater velocity of the fluids, and dissipation and a force of tension in the solids beyond what the natural state of the body can bear; and therefore it will inevitably destroy it.

HEAT, in the animal œconomy, known by the several names of natural heat, vital heat, innate heat, and animal heat, is commonly supposed to be that generated by the attrition of the parts of the blood, occasioned by its circulatory motion, especially in the arteries.

To what organs or operations, the heat of the human body, and other animal bodies, is owing, is hitherto extremely doubtful. The opinions that at present prevail are, 1. That the heat of animal-bodies is owing to the attrition betwixt the arteries and the blood. 2. That the lungs are the fountain of this heat. 3. That the attrition of the parts of the solids on one another produce it. 4. That it is owing to the mechanical attrition of the particles of our fluids. To which opinions Dr Stevenfon of Edinburgh added a 5th, viz. That whole process by which our aliment and juices are constantly undergoing some alteration.

The reasonings in favour of these several opinions may be seen at large, as laid down by the above-mentioned author in an essay on the cause of animal-heat, in the Medical Essays, vol. vi. The chief arguments in favour of the first opinion, are, that if an artery is tied, or cut, the part to which it goes turns cold; and on the ceasing of the pulsation of the arteries, cold and death follow. An increase of heat attends a brisk circulation, and a languid circulation is accompanied with a small heat. One who burns in a fever, or is hot with exercise, has a full and frequent pulse. In cold faintings, chlorosis, &c. the pulse is small and slow. To these they add, that the thermometer shews the arterial blood to be a little hotter than that of the veins.

This is accounted for from the conical figure of the arteries, from their fluxes and branches into exquisitely small capillaries; whence the resistance, and consequently the attrition, must be great, from the number, strength, and elasticity of their coats, from the propelling power of the heart, and their strong resistance. From all these it is inferred, that the particles of blood perpetually getting new motions, directions, and rotations, are attenuated, condensed, have their angles grinded off, and are made homogeneous: hence, it is said, follows the fluidity, red colour, and heat of the mass, which is here perfected.

The second opinion is, that the lungs are the fountain of heat in the human body. All that has been said for the blood's being heated in the arteries is advanced to prove this hypothesis, with considerable additions, viz. that in the lungs the blood-vessels every where attend, divide, and subdivide, along with the ramifications of the wind-pipe; and as these are perpetually changing their situation and form, becoming longer or shorter, making more acute or more obtuse angles,



angles, so must the concomitant blood-vessels every moment make new angles, and give the blood new directions; that at last it enters into an exquisitely fine network, spreads every where on the vastly thin air-vesicles, where these air-bladders are perpetually changing their angles, points of contact, their form, volume, interstices, and so forth. From these and the elasticity of the air, and weight of the atmosphere, the blood is said to be churned, pressed backward and forward, broken and kneaded together, dissolved and condensed, made red and hot in respiration.

The third opinion is, that the cause of the animal heat is owing to the action of the solid parts upon one another. The reason in support of this opinion, is, that the heart and arteries move most; thence that it is natural to think, that the heat should be owing to this motion.

The fourth opinion is, the mechanical attrition of the particles of the fluids upon one another. Dr Stevenson observes, that those who support this hypothesis, must not only suppose that mechanical attrition begets heat, but begets itself without diminution; that they must not only shew what sets this attrition agoing, but what maintains it, because all mechanical force perpetually decreases in a resisting medium; in short, that they must shew the possibility of a perpetuum mobile, the impossibility of which they themselves demonstrate.

The fifth opinion is, what Dr Stevenson calls the animal process, or that process by which our aliment and fluids are perpetually undergoing some alteration. This process, according to that writer, may be one *sui generis*, somewhat of a middle nature betwixt fermentation and putrefaction; and he thinks it comes so near to the latter, that he chuses to call it by that name. In putrefaction, which is a most powerful solvent of bodies, the intestine action of their minute particles creates, collects, or some way or other is the cause or means of heat. The doctor thinks it probable that this process is constantly carried on in all our juices, especially where there is blood; and this is chiefly in the veins, so that the blood is both the fountain of heat and the first spring and motion.

The late Dr Mortimer, in the *Philos. Trans.* n<sup>o</sup> 476. gives it as his opinion, that the heat of animals is explicable from the phosphorus and air they contain. Phosphorus exists, at least in a dormant state, in animal fluids; and it is also known, that they all contain air: it is therefore only necessary to bring the phosphoreal and aerial particles into contact, and heat must of consequence be generated.

**HEATH**, in botany. See **ERICA**.

*Berry-bearing* **HEATH**. See **EMPETRUM**.

**HEATHENS**, in matters of religion. See **PAGANS**.

**HEAVEN**, literally signifies the expanse of the firmament, surrounding our earth, and extended every way to an immense distance.

The Hebrews acknowledged three heavens: the first the aerial heaven, in which the birds fly, the winds blow, and the showers are formed; the second, the firmament in which the stars are placed; the third,

the heaven of heavens, the residence of the Almighty, and the abode of saints and angels.

Heaven is considered by Christian divines and philosophers, as a place in some remote part of infinite space, in which the omnipresent Deity is said to afford a nearer and more immediate view of himself, and a more sensible manifestation of his glory, than in the other parts of the universe. This is often called the empyrean, from that splendor with which it is supposed to be invested; and of this place the inspired writers give us the most noble and magnificent descriptions.

The pagans considered heaven as the residence only of the celestial gods, into which no mortals were admitted after death, unless they were deified. As for the souls of good men, they were consigned to the *elysian fields*. See **ELYSIAN FIELDS**.

**HEBDOMARY**, a solemnity of the ancient Greeks, in honour of Apollo, in which the Athenians sung hymns in honour of that god, and carried in their hands branches of laurel: The word signifies the seventh day, this solemnity being observed on the seventh day of every lunar month.

**HEBENSTRETIA**, in botany, a genus of the didynamia angiospermia class. The calix is bilabiate; the corolla has but one labium, consisting of four segments; and the capsule contains two seeds. There are two species, both natives of Ethiopia.

**HEBRAISM**, an idiom or manner of speaking peculiar to the Hebrew language. See the next article.

**HEBREW**, or **HEBREW LANGUAGE**, that spoken by the ancient Jews, and wherein the Old Testament is wrote.

This appears to be the most ancient of all the languages in the world, at least we know of none older: and some learned men are of opinion, that this is the language in which God spoke to Adam in Paradise.

The books of the Old Testament are the only pieces to be found, in all antiquity, written in pure Hebrew; and the language of many of these is extremely sublime; it appears perfectly regular, and particularly so in its conjugations; indeed, properly speaking it has but one conjugation, but this is varied in each seven or eight different ways, which has the effect of so many different conjugations, and affords a great variety of expressions to represent by a single word the different modifications of a verb, and many ideas which in the modern and in many of the ancient and learned languages cannot be expressed without a periphrasis.

The primitive words, which are called roots, have seldom more than three letters or two syllables.

In this language there are twenty-two letters, only five of which are usually reckoned vowels, which are the same with ours, *viz.* *a, e, i, o, u*; but then each vowel is divided into two, a long and a short, the sound of the former being somewhat grave and long, and that of the latter short and acute: it must however be remarked, that the two last vowels have sounds that differ in other respects besides quantity, and a greater or less elevation. To these ten or twelve vowels may be added others called semi-vowels, which serve to connect the consonants, and to make the easier transitions from

from one another. The number of accents to this language are, indeed, prodigious: of these there are near forty, the use of some of which, notwithstanding all the inquiries of the learned, are not yet perfectly known. We know, in general, that they serve to distinguish the sentences like the points called commas, semicolons, &c. in our language; to determine the quantity of the syllables, and to mark the tone with which they are to be spoken or sung. It is no wonder then, that there are more accents in the Hebrew than in other languages, since they perform the office of three different things, which in other languages are called by different names.

**HEBREWS**, or *Epistle to the Hebrews*, a canonical book of the New Testament.

Though St Paul did not prefix his name to this epistle, the concurrent testimony of the best authors ancient and modern afford such evidence of his being the author of it, that the objections to the contrary are of little or no weight.

The Hebrews, to whom this epistle was wrote, were the believing Jews of Palestine; and its design was to convince them, and by their means all the Jewish converts wheresoever dispersed, of the insufficiency and abolishment of the ceremonial and ritual law.

**HEBRIDES**, islands on the west of Scotland, of which Sky, Mull, Isla, and Arran are some of the largest.

**HECATOMB**, among the ancient pagans, was the sacrifice of an hundred bulls or oxen; or, in a less confined sense, an hundred animals of any sort.

**HECATOMBÆON**, in ancient chronology, the first month of the Athenian year, consisting of thirty days, and answering to the latter part of our June.

**HECK**, an engine to take fish. A salmon heck is a grate for catching that sort of fish.

**HECTIC FEVER**. See **MEDICINE**.

**HEDERA**, in botany, a genus of the pentandria monogynia class. The corolla consists of five oblong petals, and the berry contains five seeds. There are two species; one of them, *viz.* the helix, is a native of Britain.

**HEDERA TERRESTRIS**. See **GLECHOMA**.

**HEDGES**, in agriculture, are either planted to make fences round inclosures, or to divide the several parts of a garden. When they are designed as outward fences, they are planted either with haw thorn, crabs, or black-thorn; but those hedges which are planted in gardens, either to surround wilderness-quarters, or to screen the other parts of a garden from sight, are planted according to the fancy of the owner, some preferring ever-greens, in which case the holly is best; next the yew, then the laurel, laurultinus, phillyria, &c. others prefer the beech, the hornbeam, and the elm.

**HEDMORA**, a city of Sweden, in the province of Westmania, situated on the river Dalcarlia, fifty miles north-west of Upsal: E. long. 15° 55', and N. lat. 60° 16'.

**HEDYOTIS**, in botany, a genus of the tetrandria monogynia class. The calix consists of one funnel shaped petal; and the capsule has two cells, and many seeds. There are three species, all natives of Ceylon.

**HEDYSARUM**, in botany, a genus of the diadelphia decandria class. The corolla is transversely carinated; and the pod is jointed, each joint containing one seed. There are 46 species, only one of which is a native of Britain, *viz.* the St Foin, or cocks-head.

**HEEL**, in anatomy. See **ANATOMY**, p. 185.

**HEEL**, in the sea language. If a ship leans on one side, whether she be a-ground or a-float, then it is said she heels a starboard, or a-port; or that she heels off-wards, or to the shore; that is, inclines more to one side than to another.

**HEELER**, or *Bloody heel-cock*, a fighting cock that strikes or wounds much with his spurs.

The masters know such a cock, even while a chicken, by the striking of his two heels together in his going.

**HEGIRA**, in chronology, a celebrated epocha among the Mahometans.

The event which gave rise to this epocha was the flight of Mahomet from Mecca, with his new profelytes, to avoid the persecution of the Coraichites; who, being then most powerful in the city, could not bear that Mahomet should abolish idolatry, and establish his new religion. This flight happened in the fourteenth year after Mahomet had commenced prophet: he retired to Medina, which he made the place of his residence.

**HEIDELBURG**, a city of Germany, in the circle of the lower Rhine, the capital of the Palatinate, situated on the river Neckar: E. long. 8° 40', and N. lat. 49° 20'.

**HEILA**, a port-town of regal Prussia, in the kingdom of Poland, situated on the point of a peninsula in the Baltic sea, twelve miles north of Dantzick: E. long. 19°, N. lat. 54° 30'.

**HEINUSE**, among hunters, a roe-buck of the fourth year.

**HEIR**, in Scots law, a generic term applicable to those who are intitled by law to take the possession of any subject which belonged to a person deceased.—For the different kinds of heirs, &c. see **LAW**, tit. 27. & 28.

**HEIRSHIP moveables**, in Scots law, the best of certain kinds of moveables, which the heir of line is intitled to take, besides the heretable estate. See **LAW**, tit. 27.

**HEIR-APPARENT**, is a person so called in the lifetime of his ancestor, at whose death he is heir at law.

**HEIRESS**, a female heir to one who has an estate in lands, &c. Stealing an heiress, and marrying her against her will, was declared felony by 3 Hen. VII.

**HELENA**, or *St HELENA*, an island in the Atlantic ocean, situated 1200 miles west of the coast of Africa, and 1800 east of the coast of South America: W. long. 6° 30', S. lat. 16°.

**HELENIMUM**, in botany, a genus of the syngenesia polygamia superflua class. The receptacle is naked; the calix is simple, and consists of many leaves; and the corollule of the radius are semitrid. There is but one species, a native of Austria.

**HELIAEA**,

**HELIAEA**, in Grecian antiquity, was the greatest and most frequented court in Athens for the trial of civil affairs. The judges who sat in it were at least fifty, but the more usual number was either two or five hundred. When causes of great moment were to be tried, it was customary to call in the judges of the other courts: sometimes a thousand were called in, and then two courts are said to have been joined; sometimes fifteen hundred or two thousand were called in, and then three or four courts met together.

They had cognizance of civil affairs of the greatest weight and importance, and were not permitted to give judgment till they had taken a solemn oath to do it with impartiality, and to give sentence according to the laws, &c.

**HELIACAL**, in astronomy, a term applied to the rising or setting of the stars; or, more strictly speaking, to their emersion out of, and immersion into, the rays and superior splendor of the sun.

A star is said to rise heliacally, when after having been in conjunction with the sun, and on that account invisible, it comes to be at such a distance from him, as to be seen in the morning before sun-rising; the sun, by his apparent motion, receding from the star towards the east: on the contrary, the heliacal setting is when the sun approaches so near a star, as to hide it with his beams, which prevent the fainter light of the star from being perceived; so that the terms apparition and occultation would be more proper than rising and setting.

**HELIANTHEMUM**, in botany, see the article **CISTUS**.

**HELIANTHUS**, the *Great Sun-Flower*, in botany, a genus of the syngenesia polygamia frutranca class. The receptacle is paleaceous and plane; the pappus consists of two leaves; and the calix is imbricated and squarrous. There are twelve species, none of them natives of Britain.

**HELIASTES**, in antiquity, one of the judges of the court heliaea. See **HELIAEA**.

**HELICTERES**, the *Srew-Tree*, in botany, a genus of the gynandria decandria class. It has five styli; the calix consists of one oblique leaf; the petals are five; the nectarium consists of five small leaves; and it has five twisted capsules. There are four species, none of them natives of Britain.

**HELIOCARPUS**, in botany, a genus of the dodecandria digynia class. The calix consists of four leaves; the petals are four; the styli are simple; and the capsule consists of two compressed cells, radiated on each side. There is but one species, a native of America.

**HELIOCENTRIC latitude of a planet**, the inclination of a line drawn between the centre of the sun and the center of a planet, to the plane of the ecliptic.

**HELIOCENTRIC place of a planet**, in astronomy, the place of the ecliptic wherein the planet would appear to a spectator placed at the centre of the sun.

**HELIOCOMETES**, a phenomenon sometimes observed about sun setting; being a large luminous tail, or column of light, proceeding from the body of the sun,

and dragging after it, not unlike the tail of a comet; whence the name.

**HELIOSCOPE**, in optics, a sort of telescope, peculiarly fitted for viewing the sun without hurting the eyes.

**HELIOSTATA**, in optics, an instrument invented by the late learned Dr S Gravesande; who gave it this name, from its fixing, as it were, the rays of the sun in an horizontal direction across the dark chamber all the while it is in use.

**HELIX**, in anatomy. See **ANATOMY**, p. 298.

**HELIX**, in zoology, a genus belonging to the order of vermes testacea. It is an animal of the snail-kind; the shell consists of one spiral, brittle, and almost diaphanous valve; and the aperture is narrow. There are 60 species, principally distinguished by the figure of their shells.

**HELL**, the place of divine punishment after death.

As all religions have supposed a future state of existence after this life; so all have their hell or place of torment, in which the wicked are supposed to be punished. The hell of the ancient heathens was divided into two mansions; the one called elysium, on the right hand, pleasant and delightful, appointed for the souls of good men; the other called tartara, on the left, a region of misery and torment, appointed for the wicked. The latter only was hell, in the present restrained sense of the word. See **ELYSIUM**.

The philosophers were of opinion, that the infernal regions were at an equal distance from all the parts of the earth; nevertheless it was the opinion of some, that there were certain passages which led thither, as the river Lethe near the Syrtis, and the Acherusian cave in Epirus. At Hermione it was thought, that there was a very short way to hell; for which reason the people of that country never put the fare into the mouths of the dead to pay their passage.

The Jews placed hell in the centre of the earth, and believed it to be situated under waters and mountains. According to them, there are three passages leading to it: the first is in the wilderness, and by that Korah, Dathan and Abiram descended into hell; the second is in the sea, because Jonah, who was thrown into the sea, cried to God out of the belly of hell; the third is in Jerusalem, because it is said the fire of the Lord is in Zion, and his furnace is in Jerusalem. They likewise acknowledged seven degrees of pain in hell, because they find this place called by seven different names in scripture. Though they believed that infidels, and persons eminently wicked, will continue for ever in hell; yet they maintained, that every Jew who is not infected with some heresy, and has not acted contrary to the points mentioned by the rabbins, will not be punished therein for any other crimes above a year at most.

The Mahometans believe the eternity of rewards and punishments in another life. In the Koran it is said, that hell has seven gates, the first for the Mussulmans, the second for the Christians, the third for the Jews, the fourth for the Sabians, the fifth for the Magians,

the

the sixth for the pagans, and the seventh for the hypocrites of all religions.

Among Christians, there are two controverted questions in regard to hell; the one concerns locality, the other the duration of its torments. The locality of hell, and the reality of its fire, began first to be controverted by Origen. That father, interpreting the scripture account metaphorically, makes hell to consist not in external punishments, but in a consciousness or sense of guilt, and a remembrance of past pleasures. Among the moderns, Mr Whiston advanced a new hypothesis. According to him, the comets are so many hells appointed in their orbits alternately to carry the damned into the confines of the sun, there to be scorched by its violent heat, and then to return with them beyond the orb of Saturn, there to starve them in these cold and dismal regions. Another modern author, not satisfied with any hypothesis hitherto advanced, assigns the sun to be the local hell. As to the second question, *viz.* the duration of hell-torments, we have Origen again at the head of those who deny that they are eternal; it being that father's opinion, that not only men, but devils, after a due course of punishment suitable to their respective crimes, shall be pardoned and restored to heaven. The chief principle upon which Origen built his opinion, was the nature of punishment, which he took to be emendatory, applied only as physic for the recovery of the patient's health. The chief objection to the eternity of hell torments among modern writers, is the disproportion between temporary crimes and eternal punishments. Those who maintain the affirmative, ground their opinions on scripture accounts, which represent the pains of hell under the figure of a worm which never dies, and a fire which is not quenched; as also upon the words, "These shall go away into everlasting punishment, but the righteous into life eternal."

**HELLEBORUS**, **HELLEBORE**, in botany, a genus of the polyandria polygynia class. It has no calix; the petals are five or more; the nectarium is tubular and bilabiate; and the capsule contains many seeds. There are five species, two of them natives of Britain, *viz.* the *fætidus*, or great bastard black hellebore; and the *viridis*, or wild black hellebore. The hellebore, when taken in large quantities, is poisonous; but the root, in small doses, is supposed to attenuate the humours, and to promote urinary and uterine discharges.

**HELLENISM**, in matters of language, a phrase in the idiom, genius, or construction of the Greek tongue.

This word is only used when speaking of the authors who, writing in a different language, express themselves in a phraseology peculiar to the Greek.

**HELLENISTIC**, or **HELENISTIC LANGUAGE**, that used by the Grecian Jews who lived in Egypt and other parts where the Greek tongue prevailed. In this language it is said the Septuagint was written, and also the books of the New Testament; and that it was thus denominated to shew that it was Greek filled with Hebraisms and Syriacisms.

**HELLESPONT**, the entrance of the streights which divides Asia from Europe, and passes from the Archi-

pelago to Constantinople. It is now called the Dardanelles, and is about two miles wide.

**HELM** of a ship, is a piece of timber fastened into the rudder, which comes forward into the steerage, or place where the person at the helm steers the ship, by holding the whipstaff in his hand, which is joined to the helm. They begin however to be left off, steerwheels being used in their room.

There are several terms in the sea-language relating to the helm; as, *bear up the helm*; that is, let the ship go more large before the wind. *Helm amid ship*, or *right the helm*; that is, keep it even with the middle of the ship. *Port the helm*, put it over the left side of the ship. *Starboard the helm*, put it on the right side of the ship.

**HELMET**, an ancient defensive armour worn by horsemen both in war and in tournaments. It covered both the head and face, only leaving an aperture in the front secured by bars, which was called the visor.

**HELMINTHOLITHUS**, in natural history, a name given by Linnæus to petrified bodies resembling worms.

Of these he reckons four genera. 1. Petrified lithophyta, found in the mountains of Sweden. 2. Petrified shells. 3. Petrified zoophytes. 4. Petrified reptiles.

**HELMONT**, a town of the Netherlands, in the province of Dutch Brabant, situated on the river Aa: E. long. 5° 40', N. lat. 51° 30'.

**HELMSTAT**, a town of Germany, in the circle of Lower Saxony, and dukedom of Brunwic: E. long. 11° 15', N. lat. 52° 20'.

**HELOTS**, in Grecian antiquity, the inhabitants of Helos, a town of Laconia, conquered by the Spartans; who made them all prisoners of war, and reduced them into the condition of slaves.

The freemen of Sparta were forbidden the exercise of any mean or mechanical employment, and therefore the whole care of supplying the city with necessaries devolved upon the Helots.

**HELSINGFORD** a port town of Sweden, situated on the gulph of Finland, in 24° 6' E. long. and 60° 8' N. lat.

**HELSINGIA**, a province of Sweden, bounded by the Bothnic gulph on the east, and by Dalecarlia on the west.

**HELSINGIC CHARACTER**, a peculiar kind of character, found inscribed on stones in the province of Helsingia: the Runic and Helsingic characters may be easily transformed into each other.

**HELSTON**, a borough of Cornwall, nine miles south-west of Falmouth: it sends two members to parliament.

**HELVOETSLUYS**, a port-town of the united Netherlands, situated in the island of Voorn, in the province of Holland, five miles south of the Briel: it is one of the best harbours in Holland, and that to which the English packet always goes.

**HEMEROBIOUS**, in zoology, a genus of insects of the neuroptera order, the characters of which are these: The mouth is furnished with two teeth; the palpi are four; the wings are destitute, but not plaited; and

the antennæ are bristly and longer than the breast. There are 15 species, principally distinguished by their colours.

**HEMEROCALLIS**, **DAY-LILLY**, in botany, a genus of the hexandria-monogynia class. The corolla is bell-shaped, with a cylindrical tube; and the stamina are declinated. There are two species, none of them natives of Britain.

**HEMI**, a word used in the composition of divers terms, signifying the same with semi, or demi, viz. one half.

**HEMINA**, in Roman antiquity, a liquid measure which, according to Arbutnot, was equal to half a wine-pint english measure; its contents being 2,818 solid inches.

**HEMIONITIS**, in botany, a genus of the cryptogamia silices class. The parts of fructification lie in decussating lines. There are three species, none of them natives of Britain.

**HEMIPLEGIA**, or **HEMIPLIXIA**, among physicians, a palsy of one half of the body.

**HEMISPHERE**, in geometry, the half of a globe or sphere, when it is supposed to be cut through its centre in the plane of one of its great circles.

**HEMISPHERE** is also used to denote a projection of half the terrestrial globe, or half the celestial sphere, on a plane, and frequently called planisphere.

**HEMISTICH**, in poetry, denotes half a verse, or a verse not completed.

**HEMITRITÆUS**, among physicians, a kind of intermitting fever, being a semitercian. See **MEDICINE**.

**HEMLOCK**, in botany. See **CICUTA**.

**HEMP**, in botany. See **CANNABIS**.

The raising and dressing of hemp scarcely differs from the raising and dressing of flax, but in the following particulars.

Hemp requires a light, free, dry, dusty, and even a sandy warm soil; which if not naturally rich, must be made so by manure. New broke up ground does not answer for hemp, producing it thin and poor upon the stalk. Hemp does well to follow beans. The ground should be ploughed and harrowed three or four times, a fortnight or three weeks intervening between each time. In some parts of Lincoln and Holland the soil is naturally so free and rich, that it will produce hemp constantly year after year without manure. The leaves which fall off the stalk help to manure the ground. It is frequently sown with a view to clear the ground of weeds; which it does most affectually, growing fast, and soon checking every weed but mugwort, which is picked out with a fork.

It is sown about the first of May; so thin, that about four pecks are sufficient for an English acre; and the ground must then be covered as much as possible to preserve the seed from the birds, who are very fond of it.

The *taper-topped* stalk which does not bear the pods, is called the *female*, though in fact it is the *male*, scattering from its bloom a small dust, which impregnates the pods of the *bushy-topped*; which last is commonly, though improperly, called the male or carle hemp.

When hemp is the object of the farmer more than

a crop of seed, the whole should be pulled when the stalk begins to grow yellow, and the earth remaining about the roots should be beat off to prevent more growth: but if the seed is wanted in its greatest perfection, the stalks bearing the pods must be pulled before the upmost pod begins to open; the earth should not be beat off from the roots; it should be stooked in sheaves upon the field, to dry and win as corn; and the top of these stooks should be covered with undergrowth, or the like, to preserve the seed from the birds.

Hemp is sooner watered than flax, and the canals must be deeper.

In keeping the seed, care must be taken to preserve it from rats, mice, and such like vermin, who are all fond of it.

It is dressed as coarse flax, but is sooner dressed; and its greater length requires more care, and renders it more troublesome in the handling, especially in the skutching of it by the water lint-mills with horizontal skutchers, when it must be folded double. What is too coarse and strong in the stalk for the hand or foot machines, may be broke and peeled by the hand.

See **FLAX**:

**HEMPSTEAD**, a market-town of Hartfordshire, twenty-four miles north-west of London.

**HEN**, in ornithology. See **PHASIANUS**.

**HEN-BANE**. See **HYOSCIAMUS**.

**HENDECAGON**, in geometry, a figure that hath eleven sides and as many angles.

**HENLEY**, a market-town of Oxfordshire, situated on the river Thames, twenty miles south-east of Oxford, and thirty-two west of London.

**HENNEBURG**, a town of Germany, in the circle of Franconia, and the capital of the county of Henneburgh: E. long 10° 27', and N. lat. 50° 46'.

**HENOTICON**, in church-history, a decree or edict of the emperor Zeno, made at Constantinople, in the year 482, by which he pretended to reconcile all parties under one faith. It is generally agreed that Peter, patriarch of Alexandria, and Acacius, patriarch of Constantinople, were the authors of this decree, and that their design was to compliment the emperor with a right of prescribing regulations in matters of faith. The emperor, by this decree, arrogated to himself the right of being head of the church. Pope Simplicius, however, in the year 483, condemned the henoticon, and cited Acacius, the chief promoter of it, to appear before him at Rome; but it was not entirely suppressed till the year 518.

**HENRICO**, a county of the colony of Virginia, in North America.

**HENRY**, or **CAPE-HENRY**, the south cape of Virginia, at the entrance of Chesapeake-bay: W. long. 74° 50', N. lat. 37°.

**HEPARSULPHURIS**, or **LIVER OF SULPHUR**. See **CHEMISTRY**.

**HEPATIC**, in medicine and anatomy, any thing belonging to the liver.

**HEPATICA**, in botany. See **ANEMONE**,

**HEPATITIS**, in medicine. See **MEDICINE**.

**HEPATUS**.

**HEPATUS**, in ichthyology. See **LABRUS**.

**HEPHÆSTIA**, in Grecian antiquity, an Athenian festival, in honour of Vulcan, the chief ceremony of which was a race with torches.

**HEPSETUS**, in ichthyology. See **ESOX**.

**HEPTACHORD**, in the ancient poetry, signified verses that were sung or played on seven chords, that is, on seven different notes. In this sense it was applied to the lyre, when it had but seven strings.

**HEPTAGON**, in geometry, a figure consisting of seven sides and as many angles.

**HEPTANDRIA**, in botany. See **BOTANY**, p. 635.

**HEPTANGULAR**, in geometry, an appellation given to figures which have seven angles.

**HEPTARCHY**, a government of seven persons: also a state or country divided into seven kingdoms, and governed by seven independent princes; in which sense it is particularly applied to the government of South Britain when divided amongst the Saxons.

**HEPTATEUCH**, the seven first books of the Old Testament, containing the pentateuch, or five books of Moses, and the books of Joshua and Judges.

**HEPHTHEMIMERIS**, in ancient poetry, a verse consisting of three feet and an half, or seven half feet. It likewise denotes a cæsura after the third foot of a verse.

**HERACLEA**, a port-town of Romania, in European Turkey, situated on the Propontis, sixty miles south-west of Constantinople; it was once a great city: E. long. 28°, and N. lat. 41°.

**HERACLEONITES**, a sect of christians, the followers of Heracleon, who refined upon the gnostic divinity, and maintained that the world was not the immediate production of the Son of God, but that he was only the occasional cause of its being created by the demi-urgus. The Heracleonites denied the authority of the prophecies of the Old Testament, maintaining that they were mere random sounds in the air; and that St. John the Baptist was the only true voice that directed to the Messiah.

**HERACLEUM**, in botany, a genus of the pentandria digynia class, the general flower of which is difform and radiated; the single flowers of the disc consist each of five equal petals, but those of the radius consist of five unequal petals: the fruit is elliptic, compressed, and striated on each side in the middle, and contains two oval compressed seeds. There are five species, one of which, viz. the spondylium, or cow-parfait, is a native of Britain.

**HERACLIDÆ**, or *Return of the HERACLIDÆ into Peloponnesus*, in chronology, a famous epocha, that constitutes the beginning of profane history; all the time preceding that period being accounted fabulous. This return happened in the year of the world 2862, an hundred years after they were expelled, and eighty after the destruction of Troy.

**HERALD**, an officer at arms, whose business it is to declare war, to proclaim peace, to marshal all the solemnities at the coronation, christening, marriage, and funeral of princes, to blazon and examine coats of arms, &c.

Heralds were formerly held in much greater esteem than they are at present, and were created and christened by the king, who pouring a gold-cup of wine on their head, gave them the herald-name; but this is now done by the earl-marshal. They could not arrive at the dignity of herald without having been seven years poursuivant; nor could they quit the office of herald, but to be made king at arms.

**HERALDRY**, is the art of armory and blazoning; or, the knowledge of what relates to the bearing of arms, and the laws and regulations thereof.

*Arms*, or *Armories*, are marks of dignity and honour, regularly composed of certain figures and colours, given or authorized by sovereigns, and borne in banners, shields, coats, &c. for the distinction of persons, families, and states, and passing by descent to posterity.

They are called *arms*, in regard they are borne principally on the buckler, cuirasse, banners, and other apparatus of war; and *coats of arms*, *coat-armour*, &c. because anciently embroidered on a cloak or habit, worn by the ancient knights over their arms, both in war and at tournaments, and still borne by the heralds at arms.

It was a kind of surcoat, reaching only as low as the navel, open at the sides, with short sleeves; sometimes furred with *ermine* and *vair*, wherein were applied the *armories* of the knight, embroidered with gold and silver, and enamelled with beaten tin, coloured *black*, *green*, *red*, and *blue*; whence the rule never to apply colour on colour, nor metal on metal.

The *coats of arms* were frequently open, and diversified with bands and fillets of several colours, alternately placed, as we still see cloths scarleted, watered, &c. Hence they were also called *devices* or *divises*; and being divided, or composed of several pieces sewed together, whence the words *fesse*, *pale*, *chevron*, *bend*, *cross*, *salter*, *lozenge*, &c. See these articles.

The surcoat being embroidered with *gold* and *silver*, was the occasion that those two metals have been since placed in the coats of arms, under their *French* name of *or* and *argent*; and their being coloured *black*, *green*, *red*, and *blue*, that those different colours have also been introduced in them: therefore,

There are two metals in *Heraldry*, viz. *or* and *argent*; and seven colours, which are, *gules*, *azure*, *sable*, *vert*, *purpure*, *tenne*, and *sanguine*. See these and all the other terms belonging to heraldry as they occur in the order of the alphabet.

**HERAT**, a city of Persia, in the province of Chorassan: E. long. 61°, and N. lat. 34° 30'.

**HERB**, in pharmacy, an appellation given to the stalks and leaves of plants, especially such as are fleshy and succulent, and die away every year; but is also frequently used to denote the leaves alone.

**HERBAL**, a book that treats of the classes, genera, species, and virtues of plants. See **BOTANY**.

**HERBIVOROUS ANIMALS**, those which feed only on vegetables.

**HERBOURG**, a town in the circle of the upper Rhine, and territory of Nassau: E. lon. 8° 15', and N. lat. 50° 36'.

**HERCINIAN**,

- HERCINIAN FOREST**, a forest which anciently extended the whole length of Germany and Bohemia, some remains of which are still in being, *viz.* the Black Forest, Odenwald near Heidelberg, Stigewald in Wurtzburg, and Bamberg, and Hartswald in Brunfwic.
- HERCOLE**, a port-town of Tuscany, on the coast called Stato del Presidii: E. lon. 12°, and N. lat. 42° 25'.
- HERCULES**, in astronomy. See **ASTRONOMY**. p. 436.
- HERCULES-PILLARS**, in antiquity, a name given to mount Calpe in Spain, near Gibraltar, on the European side of the streights, and mount Avila on the African side.
- HEREDITAMENTS**, whatever immoveable things a person may have to himself and his heirs by way of inheritance; and which, if not otherwise bequeathed, descend to him who is next heir, and not to the executor, as chattels do.
- HEREDITARY**, an appellation given to whatever belongs to a family by right of succession, from heir to heir.
- HEREDITAS JACENS**, in Scots law. An estate is said to be *in hereditate jacente*, after the proprietor's death, till the heir's entry.
- HEREFORD**, the principal city of Herefordshire, situated on the river Wye, twenty-four miles north-west of Gloucester, and one hundred and twenty west of London: W. lon. 2° 42', and N. lat. 52° 6'.  
It sends two members to parliament.
- HERESY**, the crime of obstinately persisting in opinions that are contrary to the fundamentals of religion.
- HERETABLE RIGHTS**, in Scots law, all rights affecting lands, houses, &c. or any immoveable subject. See **LAW**, tit. 9.
- HERETAGE**, in Scots law, lands, houses, or any immoveable subject, in contradistinction to moveables or moveable subjects. See **LAW**, tit. 9. It also sometimes signifies such immoveable property as a person succeeds to as heir to another, in contradistinction to that which he himself purchases or acquires in any other manner, called *conquest*. See **LAW**, tit. 27.
- HERETIC**, a general name for all such persons, under any religion, but especially the Christian, as profess or teach religious opinions contrary to the established faith, or to what is made the standard of orthodoxy.
- HERLING**, a market-town of Norfolk, twenty miles south-west of Norwich.
- HERMÆ**, among antiquarians, statues of the god Mercury, made of marble, and sometimes of brass, without arms or feet, and set up by the Greeks and Romans in the cross ways.
- HERMÆA**, in antiquity, ancient Greek festivals, in honour of the god Hermes or Mercury.
- HERMANIA**, in botany, a genus of the monadelphia pentandria class. It has but one stylus; the capsule has five cells; and the petals are semitubular at the base. There are nine species, none of them natives of Britain.
- HERMANASTAT**, the capital city of Transilvania, subject to the house of Austria: E. lon. 24°, N. lat. 46° 32'.
- HERMAPHRODITE**, a person of both sexes, or who has the parts of generation both of male and female. It is now generally allowed, that there is no such thing as a true hermaphrodite; most, if not all those who pass for such, being mere women, whose clitoris is grown to an enormous size, and the labia pudendi become unusually tumid.  
Among the insect-classes of animals, indeed, hermaphrodites are very frequent: such as worms, snails, leeches, &c.
- HERMAPHRODITE FLOWERS**, among botanists. See **BOTANY**.
- HERMATHENA**, among antiquarians; a statue representing Mercury and Minerva both in one.
- HERMES**. See **HERMÆ**.
- HERMETIC**, or **HERMETICAL**, an appellation given to whatever belongs to chemistry, from Hermes Trismegistus, who is supposed to have been its inventor.
- HERMETICAL PHILOSOPHY**, that which undertakes to solve the various phenomena of nature, from the chemical principles salt, sulphur, and mercury.
- HERMETICAL SEAL**, among chemists, a method of stopping glass-vessels, used in chemical operations, so closely, that the most subtil spirit cannot escape through them.  
It is commonly done by heating the neck of the vessel in a flame, till ready to melt, and then twisting it closely together with a pair of pincers. Or, vessels may be hermetically sealed, by stopping them with a glass plug, well luted; or, by covering the vessel with another ovum philosophicum.
- HERMIT**, a devout person retired into solitude to be more at leisure for contemplation, and to disencumber himself from the affairs of the world.
- HERMON**, a mountain on the east of Syria and Palestine, in Asia.
- HERNANDIA**, in botany, a genus of the monœcia triandria class. The calix of the male has three segments, and the corolla three petals. The calix of the female is entire and truncated; the corolla consists of six petals; and the drupa is hollow, with an open mouth, and a loose kernel. There are two species, both natives of the Indies.
- HERNGRUNT**, a town of Upper Hungary, situated north of Buda, near the Carpathian mountains: E. lon. 19° 20' lat. 48° 47'.
- HERNIA**, in medicine. See **MEDICINE** and **SURGERY**.
- HERNIARIA**, RUPTURE WORT, in botany, a genus of the pentandria digynia class. The calix consists of five segments; it has no corolla; and the capsule contains one seed. There are four species, three of them natives of Britain, *viz.* the glabra, or smooth rupture-wort; the hirsuta, or rough rupture-wort; and the lenticulata, or sea rupture-wort. The leaves may be used as a mild restraining; but have no title to their former reputation of curing ruptures.
- HERO**, in the ancient mythology, a great and illustrious person, of a mortal nature, though supposed by the populace

lace to partake of immortality; and, after his death, placed among the number of the gods.

**HEROIC POEM**, that which describes some extraordinary enterprize; being the fame with epic poem. See **COMPOSITION**.

**HEROIC VERSE**, that wherein heroic poems are usually composed; or it is that proper for such poems. In the Greek and Latin, hexameter verses are usually denominated heroic verses, as being alone used by Homer, Virgil, &c.

**HERON**, in ornithology. See **ARDEA**.

**HERPES**, in medicine, a bilious pustule, which breaking out in different manners upon the skin, accordingly receives different denominations. See **MEDICINE**.

**HERRING**, in ichthyology. See **CLUPEA**.

**HERSILLON**, in the art of war, is a strong plank or beam, about ten or twelve feet long, stuck full of spikes on both sides, and used to incommode the march of the infantry or cavalry.

**HESPER**, an appellation given to the planet Venus, when she sets after the sun.

**HESPERIDES**, in antiquity, the daughters of Hesperus, brother of Atlas, who kept a garden full of golden apples, guarded by a dragon: but Hercules having laid the dragon asleep stole away the apples.

**HESPERIS**, **DAME'S VIOLET**, in botany, a genus of the tetradynamia filiquosa class. The petals are obliquely bent; there is a gland betwixt the short stamina; and the stigma is forked at the base, and connivent at top. There are seven species, only one of which, viz. the marroonalis, or unfavoury dame's violet, is a native of Britain.

**HESSE-CASSEL** landgraviate, including Wetteravia, is a circle of the Upper Rhine, bounded by Westphalia and Brunwic on the north, by Franconia and Saxony on the east, by the river Maine on the south, and by another part of Westphalia and the eiectorate of Mentz and Triers on the west: it is subject to the king of Sweden.

**HESSE-DARMSTAT**, is bounded by the river Maine, which divides it from Hesse-Cassel, on the north, by the same river on the east, and by the Palatinate on the south and west.

**HETEROCLITE**, among grammarians, one of the three variations in irregular nouns, and defined by Mr Rudiman, a noun that varies in declension; as, *hoc vas, vasis: hæc vasa, vasorum*.

**HETERODOX**, in polemical theology, any thing contrary to the faith and doctrines of a church.

**HETERODOMUS VECTIS**, in mechanics, a lever, wherein the fulcrum, or point of suspension, is placed between the power and the weight. See **MECHANICS**.

**HETEROGENEITY**, in physiology, that quality or property of bodies which denominates a thing heterogeneous. See the next article.

**HETEROGENOUS**, or **HETEROGENEAL**, something that consists of parts of dissimilar kinds, in opposition to homogenous.

**HETEROSCI**, in geography, a term of relation, denoting such inhabitants of the earth as have their shadows

falling but one way, as those who live between the tropics and polar circles, whose shadows at noon in north latitude are always to the northward, and in south latitude to the southward.

**HEUCHERA**, in botany, a genus of the pentandria digynia class. The petals are five; and the capsule has a double beak, and two cells. There is but one species, a native of Virginia

**HEXACHORD**, in ancient music, a concord called by the moderns a sixth.

**HEXAGON**, in geometry, a figure of six sides and angles; and if these sides and angles be equal, it is called a regular hexagon. See **GEOMETRY**.

**HEXAHEDRON**, in geometry, one of the five Platonic bodies, or regular solids; being the same with a cube.

**HEXAMETER**, *carmen hexametrum*, in ancient poetry, a kind of verse consisting of six feet; the first four of which may be indifferently either spondees or dactyls, the fifth is generally a dactyl, and the sixth always a spondee. Such is the following verse of Horace:

1        2        3        4        5        6  
*Aur prolesse vult, aut delictare potera.*

**HEXANDRIA**, in botany See **BOTANY**, p. 635.

**HEXASTYLE**, in architecture, a building with six columns in front.

**HEXHAM**, a market-town of Northumberland, sixteen miles west of Newcastle.

**HEYDON**, a borough town in Yorkshire, thirty-seven miles south-east of York, and six miles west of Hull. It sends two members to parliament.

**HEYTSBURY**, a borough town of Wiltshire, fourteen miles north-west of Salisbury, sends two members to parliament.

**HIATICULA**, in ornithology. See **CHARADRIUS**.

**HIATUS**, properly signifies an opening, chasm, or gap; but it is particularly applied to those verses, where one word ends with a vowel, and the following word begins with one, and thereby occasions the mouth to be more open, and the sound to be very harsh.

The term hiatus is also used in speaking of manuscripts, to denote their defects, of the parts that have been lost or effaced.

**HIBISCUS**, in botany, a genus of the monadelphia polyandria class. The calix is double; the exterior one consists of many leaves; the capsule has five cells, and contains many seeds. There are twenty-five species, none of them natives of Britain.

**HICCUP**, or **HICCUGH**, in medicine, a spasmodic affection of the stomach and diaphragm, arising from any thing that irritates and vellicates their nervous coats. See **MEDICINE**.

**HIDE**, the skin of beasts, but particularly applied to those of large cattle, as bullocks, cows, horses, &c.

Hides are either raw or green, just as taken off the carcase; salted or seasoned with salt, alum, and saltpetre, to prevent their spoiling; or curried and tanned. See **TANNING**.

**HIDE of land**, was such a quantity of land as might be plowed with one plough within the compass of a year, or so much as would maintain a family; some  
† 8 M call



call it sixty, some eighty, and some an hundred acres.

**HIDE-BOUND.** See **FARRIERY**, p. 563.

**HIERACHIUM**, **HAWKWEED**, in botany, genus of the syngenesia polygama æqualis class. The receptacle is naked; the calix is oval and imbricated; and the pappus is simple and sessile. There are 28 species, 8 of them natives of Britain. The leaves of the pilosella, or common creeping mouse-ear, are recommended as astringents.

**HIERACITES** in church-history, Christian heretics in the third century, so called from their leader Hierax, a philosopher of Egypt; who taught that Melchisedek was the Holy Ghost, denied the resurrection, and condemned marriage.

**HIERARCHY**, among divines, denotes the subordination of angels.

Some of the rabbins reckon four, others ten, orders or ranks of angels; and give them different names, according to their different degrees of power and knowledge.

**HIERARCHY** likewise denotes the subordination of the clergy, ecclesiastical polity, or the constitution and government of the Christian church considered as a society.

**HIEROGLYPHICS**, in antiquity, mystical characters, or symbols, in use among the Egyptians, and that as well in their writings as inscriptions; being the figures of various animals, the parts of human bodies, and mechanical instruments.

But besides the hieroglyphics in common use among the people, the priests had certain mystical characters, in which they wrapped up and concealed their doctrines from the vulgar. It is said, that these something resembled the Chinese characters, and that they were the invention of Hermes. Sir John Marsham conjectures, that the use of these hieroglyphical figures of animals introduced the strange worship paid them by that nation: for as these figures were made choice of, according to the respective qualities of each animal, to express the qualities and dignity of the persons represented by them, who were generally their gods, princes and great men, and being placed in their temples, as the images of their deities; hence they came to pay a superstitious veneration to the animals themselves.

The meaning of a few of these hieroglyphics, has been preserved by ancient writers. Thus we are told they represented the supreme Deity by a serpent with the head of a hawk. The hawk itself was the hieroglyphic of Osiris; the river-horse, of Typhon; the dog, of Mercury; the cat, of the moon, or Diana; the beetle, of a courageous warrior; a new-born child, of the rising sun; and the like.

**HIEROGRAMMATISTS**, *i. e.* holy registers, were an order of priests among the ancient Egyptians, who presided over learning and religion.

They had the care of the hieroglyphics, and were the expostors of religious doctrines and opinions. They were looked upon as a kind of prophets, and it is pretended that one of them predicted to an Egyptian king, that an Israelite, (meaning Moses) eminent for his

qualifications and achievements, would lessen and depress the Egyptian monarchy.

**HIEROMANCY**, in antiquity, that part of divination which predicted future events from observing the various things offered in sacrifice. See **DIVINATION** and **SACRIFICE**.

**HEROMNEMON**, the name of an officer in the Greek church, whose principal function it was to stand behind the patriarch at the sacraments and other ceremonies of the church, and to shew him the prayers, psalms, &c. in the order in which they were to be rehearsed.

**HIEROPHANTES**, in Grecian antiquity, the name by which the Athenians called those priests and priestesses who were appointed by the state to have the supervisory of things sacred, and to take care of the sacrifices.

**HIEROPHYLAX**, an officer in the Greek church, who was guardian or keeper of the holy utensils, vestments, &c. answering to our sacrista or vestry-keeper.

**HIGH WAY**, a free passage for the king's subjects, on which account it is called the king's high-way, tho' the freehold of the soil belong to the owner of the land. Those ways that lead from one town to another, and such as are drift or cart-ways, and are for all travellers in great roads, or that communicate with them, are high-ways only; and as to their reparation, are under the care of surveyors.

**HIGHAM-FERRERS**, a borough town of Northamptonshire, twelve miles north-east of Northampton: it sends two members to parliament.

**HIGHNESS**, at title given to princes. Before king James I. the kings of England had no other title but that of highness; which was also the case of the kings of Spain before Charles V.

At present all the sons of crowned heads are styled royal highness, as the electors of Germany are electoral highness.

**HIGWORTH**, or **HIGWORTH**, a market-town of Wiltshire, situated thirty miles north of Salisbury.

**HILARIA**, an ancient Roman festival, observed on the eighth of the calends of April, or the twenty-fifth day of March, in honour of the goddess Cybele. It was so called from the various expressions of joy and mirth on this occasion.

**HILARODI**, in the ancient music and poetry, a sort of poets among the Greeks, who went about singing little gay poems or songs, somewhat graver than the Ionic pieces, accompanied with some instrument. From the streets they were at length introduced into tragedy, as the magodi were into comedy. They appeared dressed in white, and were crowned with gold. At first they wore shoes, but afterwards they assumed the crepida, being only a sole tied over with a strap.

**HILARY-TERM.** See **TERM**.

**HILDESHEIM**, the capital of a bishopric, surrounded by the territories of Brunswic, and subject to its own bishop: E. long. 10°, N. lat. 52° 17'.

**HILUM**, among botanists, denotes the eye of a bean.

**HIN**, a hebrew measure of capacity for things liquid, containing the sixth part of an ephah, or one gallon two pints, or 2.533 solid inches, English measure.

**HINO**,

**HIND**, a female stag in the third year of its age. See **CERVUS**.

**HINDON**, a borough town of Wiltshire, situated four-tendon miles west of Salisbury: it sends two members to parliament.

**HINDOWN**, or **HENDOWN**, the capital of the country of the Hindowns, in the hither India: E. long  $76^{\circ} 30'$ , N. lat.  $27^{\circ}$ .

**HINE**, or **HIND**, a husbandman's servant. Thus the person who oversees the rest, is called the master hine.

**HIPPOBOSCA**, or **HORSE-FLY**, in zoology, a genus of insects belonging to the order of diptera. The beak consists of two valves, is cylindrical, obtuse, and hanging; and the feet have several claws. There are four species, distinguished by their wings, &c. The equina is extremely troublesome to horses.

**HIPPOCAMPUS**, in ichthyology. See **SYNGNATHUS**.

**HIPPOCENTAUR**, in antiquity, a fabulous animal, half man half horse.

What gave rise to the fable of Hippocentaurs, was this. The Thessalians are said to have been the first inventors of the art of breaking horses; and being first seen on horseback, they seemed to make but one body with the horses; whence the origin of the fable.

**HIPPOCREPIS**, **COMMON HORSE SHOE VETCH**, in botany, a genus of the diadelphia decandria class. The pod is compressed and crooked. There are three species, only one of which, *viz.* the comosa, or tufted horse shoe vetch, is a native of Britain.

**HIPPODROME**, in antiquity, the course where horse-races were performed.

**HIPPOGLOSSUS**, in ichthyology, See **PLEURONECTES**.

**HIPPOMANES** signifies the expressed juice of the tithymallus; as also a juice distilling from the genitals of a mare, in the time of her covering: some again take it for the secundines of a mare; and, lastly, it signifies a fleshy substance adhering to the forehead of a colt newly foaled, which some imagine to have a virtue of procuring love, and promoting the birth.

**HIPPOPHAE**, in botany, a genus of the diœcia tetrandria class. The calix of the male has two segments; and the corolla is wanting. The calix of the female consists of two segments; it has no corolla; but one stylus; and the berry contains many seeds. There are three species, only one of which, *viz.* the rhamnoides, fallow-thorn, or sea buck-thorn, is a native of Britain.

**HIPPOPOTAMUS**, the **RIVER-HORSE**, a genus of quadrupeds, belonging to the order of belluæ; the characters of which are these: It has 6 foreteeth in the upper jaw, disposed in pairs at a distance from each other; and four prominent foreteeth in the under jaw, the intermediate ones being longest: the dog-teeth are solitary and obliquely truncated; and the feet are hoofed on the edges.

There is but one species of hippopotamus, *viz.* the amphibius, or river-horse. The history of this quadruped, though next to the elephant in magnitude, is far from being sufficiently delineated. The best description hitherto given of him is that of

Frederic Zerenghi, an Italian surgeon, published in the year 1603. Zerenghi killed two of them (a male and a female) on the banks of the Nile, preserved their skins, and brought them to Rome. Every skin took 400 pounds of salt in curing. He says, the skin of the hippopotamus is about an inch thick, extremely hard, impenetrable by a common musket-ball; and there are only a few short white hairs scattered very thin over it. The teeth are not protruded out of the mouth, as is commonly believed; for, when the mouth is shut, although the teeth be extremely large, they are entirely covered by the lips. The dimensions of the female, of which Zerenghi gives a figure, are as follow: From the point of the muzzle to the origin of the tail, between 11 and 12 feet; the circumference of the body about 10 feet; the height of the body,  $4\frac{1}{2}$  feet; the circumference of the leg, near the shoulder, 2 feet 9 inches, lower down 1 foot  $9\frac{1}{2}$  inches; the height of the legs about  $1\frac{1}{2}$  foot; the length of the feet from the extremity of the claws,  $4\frac{1}{2}$  inches; the claws are nearly of an equal length and breadth, and are somewhat more than two inches; each toe is furnished with a claw, and each foot with four toes. The tail is about one foot long, more than a foot in circumference near the origin, and about 3 inches near the point. The tail is not round, but flattish. The head, from the extremity of the lips to the neck, is about 2 feet 4 inches, and the circumference 5 feet 8 inches. The ears are about 3 inches long, and nearly as broad; they are a little pointed, and covered in the interior side with short white hair. The mouth, when open, is about  $1\frac{1}{2}$  foot wide, and furnished with 44 teeth of different figures. Their teeth are of such a hard substance, that they give fire with steel. These dimensions are taken from a female hippopotamus; but the male is generally about one third larger.

With such powerful arms, and such a prodigious strength of body, the hippopotamus might render himself formidable to every other animal. But he is naturally of a mild disposition; and besides, his body is so heavy, and his motions so slow, that he cannot overtake any other quadruped. He swims swifter than he runs, and preys upon fishes. He dives in the water, and can stay very long under. He has no membrane betwixt his toes, as the castor or the otter; and he only swims easily in consequence of the great bulk of his belly, which makes him nearly of an equal specific gravity with the water. Moreover, he often keeps himself at the bottom, and walks upon the channel with the same freedom as upon dry land. Besides preying upon fishes, crocodiles, &c. he frequently goes out of the water and feeds upon sugar-canes, rushes, millet, rice, roots, &c. These he devours in large quantities, and often does great damage in the cultivated field. But as he is more timid on land than in the water, he is easily drove away. His legs are so short, that he cannot escape by flight when at a distance from the river. He generally flies when approached by people in boats; but, if they wound him, he returns with fury, attacks the boats with his teeth, and frequently oversets them.

This animal seems to be confined principally to the rivers

- rivers of Africa. The male and female generally go together, and the female is said to produce but one at a birth.
- HIPPURIS**, in botany, a genus of the monandria monogynia class. It has neither calix nor corolla; the stigma is simple; and there is but one seed. There is only one species, *viz.* the *vulgaris*, a native of Britain.
- HIPPURIS**, in ichthyology. See **CORYPHÆNA**.
- HIRCANIA**, in geography, the provinces of Persia in Asia, which lie on the southern shore of the Caspian sea.
- HIRCHFELD**, a city of Germany, in the circle of the upper Rhine, and landgraviate of Hesse Cassel, situated on the river Fuld, in E. long.  $9^{\circ} 32'$ , N. lat.  $50^{\circ} 47'$ .
- HIRTELLA**, in botany, a genus of the triandria monogynia class. The calix is divided into five parts; the petals are five, and equal; the filaments are spiral, and the stylus is lateral. There is but one species, a native of Brazil.
- HIRUDO**, the **LEECH**, in zoology, a genus belonging to the order of vermes intestina. The body is flat, jointed, and moves either forward or backward. There are nine species, principally distinguished by that colour. This well known animal is used for bleeding children, &c. When they once fix, they seldom quit till they are glutted with blood. Salt makes them quit their hold, and throw up the blood.
- HIRUNDO**, in ornithology, a genus of birds, of the order of passeres. The bill is small, crooked, subulated, bent a little inward, and depressed at the base. There are 12 species, principally distinguished by their colour. This includes the common swallow, martin, &c.
- HISPANIOLA**, an island of America, in the Atlantic ocean, situated between  $67^{\circ}$  and  $74^{\circ}$  of W. long. and between  $18^{\circ}$  and  $20^{\circ}$  N. lat. being about 420 miles long from east to west, and 120 in breadth. It is frequently called St. Domingo, from the capital thereof.
- HISTORIOGRAPHER**, a professed historian, or writer of history.
- HISTORY**, a description or recital of things as they are, or have been, in a continued orderly narration of the principal facts and circumstances thereof.
- History, with regard to its subject, is divided into the history of Nature, (See **NAT. HIST.**) and the history of Actions. The history of Actions is a continued relation of a series of memorable events.
- HISTRIO**, in the ancient drama, signified an actor or comedian, but more especially a pantomime, who exhibited his part by gestures and dancing.
- HITCHING**, a market-town in Hartfordshire, fourteen miles north-west of Hartford, and thirty-two north-west of London.
- HITHE**, one of the Cinque Ports in the county of Kent, situated on the English channel, six miles west of Dover.
- HIVE**, in country affairs, a convenient receptacle for bees. See **APIS**.
- HIVING of Bees**. See **APIS**.
- HOACHE**, in natural history, a kind of earth approaching to the nature of chalk, but harder, and feeling like soap; whence some think, that it is either the same with our soap rock of Cornwall, or very like it. The Chinese dissolve it in water, till the liquor is of the consistence of cream, and then varnish their china-ware with it.
- HOAR-HOUND**, in botany. See **MARUBIUM**.
- HOARSENESS**, in medicine, a diminution of the voice, commonly attended with a preternatural asperity or roughness thereof.
- HOBBY**, in ornithology. See **FALCO**.
- HOE**, in country-affairs, a tool made like a cooper's adz, to cut upwards in gardens, field, &c. This tool is commonly called the hand-hoe. See **AGRICULTURE**.
- HOG**, in zoology. See **SUS**.
- HOGSHEAD**, in commerce, a measure of capacity, containing sixty-three gallons.
- HOGUE**, a town and cape on the north-west point of Normandy in France, near which admiral Rook burnt the French admiral's ship called the *Rising-sun*, with twelve more large men of war: W. lon.  $2^{\circ}$ , and N. lat.  $49^{\circ} 50'$ .
- HOHIO**, a river of North America; which rising in the Apalachian mountains, near the confines of Carolina and Virginia, runs south west, and falls into the river Mississippi.
- HOKE-DAY**, the Tuesday after easter-week; which was the day on which the English conquered and expelled the Danes: this was therefore kept as a day of rejoicing; and a duty, called hoke-tuesday money, was paid to the landlord, for giving his tenants and bondmen leave to celebrate it.
- HOLCUS**, in botany, a genus of the polygamia monœcia class. The calix of the hermaphrodite is a double-flowered glume; the corolla is a glume with an awn; and there are three stamina, two styli, and one seed. The calix of the male is a double-valved glume; it has no corolla, but three stamina. There are ten species, only two of them natives of Britain, *viz.* the *lanatus*, or meadow soft-grass; and the *mollis*, or creeping soft-grass.
- HOLDERNESS**, a peninsula in the east riding of Yorkshire, which has the German ocean on the east, and the river Humber on the south.
- HOLDING**, in Scots law, the tenor or terms upon which a proprietor of lands holds or enjoys them of his superior.—See **BLENCH**, **BURGAGE**, **FEE**, **WARD**.
- HOLLAND**, one of the United Provinces. It is about one hundred miles long from north to south, and scarce thirty miles broad: but enjoys the greatest trade of any province in the world, and in point of strength and riches is equal to the other six united provinces. It is situated one hundred miles east of England, and is bounded on the north and west by the German sea, on the east by the *Zuider sea*, and on the south by the provinces of Zealand and Utrecht.
- HOLLAND** is also the name of the south-east division of Lincolnshire.
- HOLLAND**, in commerce, a fine and close kind of linen,

linen, so called from its being first manufactured in Holland.

**HOLLY**, in botany. See **ILEX**.

*Sea-HOLLY*. See **ERYNGIUM**.

**HOLOCAUST**, a burnt-offering, or sacrifice, wholly consumed by fire: of this kind was the daily sacrifice in the Jewish church. This was done by way of acknowledgment, that the person offering and all that belonged to him, were the effects of the divine bounty.

**HOLOGRAPH**, among civilians, a will wholly written by the hand of the testator.

**HOLSTEIN**, a duchy of Germany, in the circle of lower Saxony, one hundred miles long, and fifty broad. It is bounded by Sleswic or south Judland on the north, by the Baltic sea and the duchy of Sax-Lawenburg on the east, by the river Elbe on the south, and by the German sea on the west.

**HOLY-GHOST**, one of the Persons of the Holy Trinity. *Order of the HOLY GHOST*, the principal military order in France, instituted by Henry III. in 1569. It consists of an hundred knights, who are to make proof of their nobility for three descents. The king is the grand-master, or sovereign; and as such, takes an oath on his coronation-day, to maintain the dignity of the order.

**HOLY-DAYS**. See **FESTIVAL**.

**HOLY-HEAD**, a cape and town in the isle of Anglesea, situated in the Irish channel: W. long.  $4^{\circ} 45'$ , and N. lat.  $53^{\circ} 26'$ .

**HOLY-ISLAND**, an island in the German sea, six miles south of Berwick upon Tweed: W. long.  $1^{\circ} 42'$ , and N. lat.  $55^{\circ} 45'$ .

**HOLY-WELL**, a town of north Wales, in Flintshire, ten miles east of St. Asaph.

**HOMAGE**, in law, is the submission, loyalty, and service which a tenant promised to his lord, when he was first admitted to the land which he held of the lord in fee: also that owing to a king, or to any superior.

**HOMBERG**, a town of Germany, in the circle of the upper Rhine, and landgraviate of Hesse, situated ten miles north of Francfort: E. long.  $8^{\circ} 24'$ , N. lat.  $50^{\circ} 20'$ .

**HOMBERG** is also a town of Germany, in the palatinate of the Rhine, and dukedom of Deuxponts: E. long.  $7^{\circ} 6'$ , and N. lat.  $49^{\circ} 20'$ .

**HOMER**. See **OMER**.

**HOMICIDE**, signifies in general the taking away of any person's life. See **SCOTS LAW**, tit. 33.

**HOMILY**, in ecclesiastical writers, a sermon, or discourse, upon some point of religion, delivered in a plain manner, so as to be easily understood by the common people.

**HOMO, MAN**, is ranked by Linnæus under the order of primates, and characterised by having four parallel foreteeth both in the upper and lower jaw, and two mammae on the breast. The species, according to this author, are two, *viz.* the homo sapiens, and the homo troglodytes. He subdivides the homo sapiens into five varieties, *viz.* the American, the European, the Asiatic, the African, and what he calls the monstrous. The troglodytes, or orang outang, is a native of Aethiopia, Java, and Amboina. His body is white; he

walks erect; and is about one half the ordinary human size. He generally lives about 25 years. He conceals himself in caves during the day, and searches for his prey in the night. He is said to be exceedingly sagacious, but is not endowed with the faculty of speech.

**HOMOLOGOUS**, in geometry, an appellation given to the corresponding sides and angles of similar figures, as being proportional to each other.

**HONAN**, a province of China, bounded by those of Xansi and Peking on the north, by Xantong and Nankin on the east, by Suchuen on the south, and by Xensi on the west; lying between  $33^{\circ}$  and  $37^{\circ}$  north latitude. Its capital is Caitum.

**HONDURAS**, a province of Mexico, in North America; which including the country of the Mosquito-Indians, is situated between  $85^{\circ}$  and  $94^{\circ}$  W. long. and between  $12^{\circ}$  and  $16^{\circ}$  N. lat.

**HONE**, a fine kind of whetstone, used for setting razors, pen-knives, and the like.

**HONEY**, is, in general, a thick, viscid, and more or less fluid substance, of a whitish or yellowish colour, sweet to the taste, soluble in water, becoming vinous in fermentation, inflammable, liquable by a gentle heat, and of a fragrant smell. See **APIS**.

**HONFLEUR**, a port-town of France, in the province of Normandy, situated on the south side of the river Seyne, near the English channel: E. long.  $15'$ , and N. lat.  $49^{\circ} 24'$ .

**HONITON**, a borough-town of Devonshire, twelve miles east of Exeter. It sends two members to parliament.

**HONOUR**, a testimony of esteem or submission, expressed by words, actions, and an exterior behaviour, by which we make known the veneration and respect we entertain for any one on account of his dignity or merit. The word honour is also used in general for the esteem due to virtue, glory, and reputation. It is also used for virtue and probity themselves, and for an exactness in performing whatever we have promised; and in this last sense we use the term, *a man of honour*. But honour is more particularly applied to two different kinds of virtue, bravery in men, and chastity in women.

*Maid of Honour*, are six young ladies in the household of the queen and princess-royal; the salary of those of a queen are 300 l. per ann. each, and those of the princess dowager of Wales, 200 l.

**HONOUR-POINT**, in heraldry, is that next above the centre of the escutcheon, dividing the upper part into two equal portions.

**HOOF**, the horny substance that covers the feet of divers animals, as oxen, horses, sheep, &c.

**HOOKS** are a necessary sort of utensils, and used for various purposes.

**HOOKER**, in naval architecture, a vessel much used by the Dutch, built like a pink, but rigged and masted like a hoy.

Hookers will lie nearer a wind than vessels with cross sails can do. They are from fifty to two hundred tons burden, and with a few hands will sail to the East Indies.

HOP, in botany. See HUMULUS.

New land is found to succeed better with hops than old; and on this principle they are very cautious in their plantations in Kent, and look forward for the after-produce. When they make a new hop-ground, they plant it with apple-trees at a large distance asunder, and with cherry-trees between; by this means, when the hops have grown ten years, which they judge as much as they will do well, they place their account in the cherry-trees, which bear large crops; these they gather for about thirty years, and then they cut them up, and depend upon their apple-trees only, which they find very large and strong by that time.

The dry stalks of hops should be burnt on the ground in winter, covering them with a little fresh earth as they burn. This makes together an excellent compost, to make the hills of. The land must be dug or plowed well, and laid very even, and then the places for the hills marked out by a line, and a stick put in every place where one is to be. A thousand hills may be made in an acre of ground, and six or seven plants set on every hill. From six to nine feet should be allowed between every hill, and the grounds in the hills should be better and richer than the common earth. Some plant hops in March and April, but the most experienced people prefer the month of October, because they will then strike firm roots, and be strong and vigorous against spring. The largest plants are to be chosen; and it is best to procure them from some rich ground, where the hills have been laid high; they should be about eight or ten inches long, and have three or four joints or buds a-piece; the holes for planting them are to be dug eight or ten inches deep, and about a foot over; and in each of these holes four plants are to be set, one in each corner: they may be covered an inch deep over the top, if planted in October; but in spring, when they have shot from the joints, then they must not be buried: after this, the ground must be carefully kept clear of weeds.

*Dressing of Hops.* This is preparing the ground in winter and spring for the making a good summer-crop. In doing this, the hills upon which the plants stand must be all pulled down, and undermined on every side, till the spade comes near the principal root; then shake off or remove with the hand the loose mould from the upper or loose roots, that you may see where the new roots grow out of the old sets. The old sets are to be carefully preserved, but the other roots may be cut away. Whatever time the hills are pulled down, the roots must not be cut till March. When the young hops are dressed for the first time, all the roots are to be cut away that grew the year before, and the sets are to be cut off within one inch of the same; and every year after, they must be cut as close as may be to the old roots; but to a weak hop, some of the shoots are to be left at the dressing. Those roots of the plant which grow downwards, are never to be injured, but only those which run horizontally are to be cut. The old roots and the young ones may be easily distinguished, in that the old ones are always red, and the young white. If there are by accident any wild hops got a-

mong the rest, the places where they grow are to be marked with sticks, or otherwise, at the time of their being gathered; and after this, at the time of dressing the ground, that whole hill is to be destroyed, and a new one made with new plants in the room of it. When the roots are cut and dressed, the rich compost is to be put to them; and the hills must not be made too high at first, lest they hinder the young shoots.

*Gathering and drying of Hops.* Hops blow in the latter end of July, in the beginning of August they bell; and they are sometimes ripe at the beginning of September, sometimes later. When they begin to change colour, are easily pulled to pieces, and their seeds look brown within them, they are ripe; and they are then to be gathered as quick as possible, for the least blast of wind will hurt them at this time.

The manner of gathering hops, is to take down four hills standing together in the midst of the garden, and to cut the roots even with the ground, then lay the ground level; and when it is swept clean, it makes a floor, on which the hops may be laid and picked. The hop-plants are first unwound from the poles, and then the people sit round and pick off the hops into baskets.

Care should be taken to dry the hops as fast as they are picked, for in lying undried they are apt to heat and change colour very quickly. If the quantity picked be so large, that the kiln in which they are to be dried is over-stocked, they must be spread thin upon a floor, and they will keep two or three days in that manner without any harm. Indeed, where the quantity is but small, there is no need to have recourse to the kiln at all, for they will dry much better than any other way, by being laid thin upon a floor, and often turned. The drying of hops is the most material part of their manufacture; for if they be ill dried, they lose all their agreeable flavour; and great caution should be used, that they be all equally dried.

*Bagging of Hops,* a term used by the farmers, who cultivate hops, for the last thing they have to do with them, in order to bring them to market; that is, the putting them up in large bags of coarse cloth, for carriage. When the hops have been picked and dried in the oost, or tin-floor, they are so brittle that they would break to pieces and be spoiled if they were immediately to be put up; they are therefore to lie together three weeks, or thereabouts, that they may become tough: if they are covered from the air by blankets in the heap, they may be bagged much sooner than if left open.

The manner of bagging them is this; a hole is made in an upper-floor, so large that a man may easily go up and down it; then a hoop is fitted to the mouth of the bag, and so firmly sewed on, that it cannot be torn off; the bag is then let down through the hole, and the hoop remaining above, stops it from being pulled quite through, being larger than the hole: a few hops are to be first thrown into the bag, and a person below is to take up a parcel of these in each corner of the bag, tying it with a packthread; this makes a sort of tassel, by which the bags are afterwards the easier managed  
and

and turned about. When this is done, one man must go down into the bag, and, while another calls in the hops, he must tread them down equally every way with his feet; when the bag is in this manner filled, it is to be ripped from the hoop, and sewed up, leaving two tassels at the corners, as at the bottom. A bag of hops thus prepared, may be kept for several years in a dry place.

The tops of this plant, being of a cooling quality, are eaten, when boiled, as an emollient. A decoction of hop-flowers is also accounted an antidote against poison, and cures the itch, as well as the syrup thereof, and is esteemed excellent in choleric and pestilential fevers. The heads and tendrils are good in the scurvy and most cutaneous diseases. Juleps and apozems are also prepared with hops for hypochondriacal and hysterical affections, and to promote the menses: but the chief use of this plant consists in preserving beer and other malt-liquors (in which the flower of this plant is a principal ingredient) from turning sour, and rendering it wholesome and grateful to the taste, &c.

**HORD**, in geography, is used for a company of wandering people, which have no settled habitation, but stroll about, dwelling in waggons, or under tents, to be ready to shift as soon as the herbage, fruit, and the present province is eaten bare: such are several tribes of the Tartars, particularly those who inhabit beyond the Wolga, in the kingdom of Astracan and Bulgaria.

**HORDEUM**, **BARLEY**, in botany, a genus of the triandria digynia class. The involucre consists of six leaves, and contains three flowers. There are eight species, only one of which, *viz.* the murinum, or wall-barley-grass, is a native of Britain. The native place of the vulgar, or common barley cultivated in our fields, is not known. For the culture, &c. of common barley, see **AGRICULTURE**, p. 61.

**HORDICALIA**, or **HORNICIDIA**, in antiquity, a religious feast held among the Romans, wherein they sacrificed cattle big with young. This feast fell on April 15. on which day they sacrificed thirty cows with calf to the goddesses Tellus, or the Earth; part of them were sacrificed in the temple of Jupiter. The calves taken out of their bellies were burnt to ashes at first by the

pontifices, afterwards by the eldest of the vestal virgins. **HOREHOUND**, **BALLOTA**, **STACHYS**, in botany. See **MARUBIUM**.

**HORIZON**, in astronomy and geography, that great circle which divides the heavens and the earth into two equal parts, or hemispheres, distinguishing the upper from the lower. See **ASTRONOMY** and **GEOGRAPHY**.

**HORIZONTAL**, something relating to the horizon; or that is taken in, or on a level with the horizon: thus we say, an horizontal plane, &c.

**HORMINUM**, **CLARY**, in botany, a genus of the didynamia gymnospermia class. The calix is bell-shaped, with four nearly equal segments, and a fifth larger and emarginated; and the upper labium of the corolla is concave. There are two species, none of them natives of Britain.

**HORN**, a hard substance growing on the heads of divers animals, particularly the cloven-footed quadrupeds; and serving them both as weapons of offence and defence.

**HORN-BEAM**, in botany. See **CARPINUS**.

**HORN-WORK**, in fortification, an out-work composed of two demi-bastions, joined by a curtain. See **FORTIFICATION**.

**HORNET**, in zoology. See **APIS**.

**HORNING**, in Scots law, a writing issuing from the signet, in his Majesty's name, at the instance of a creditor against his debtor, commanding him to pay or perform within a certain time. See **DENUNCIATION**, —and **LAW**, tit. 12. §. 13. 14.

**HORNSEY**, a market-town of the east riding of Yorkshire, thirty-five miles east of York.

**HOROGRAPHY**. See **DIALLING**.

**HOROLOGIUM**, a general name for instruments to measure the hours, as a watch, clock, dial, &c. See **WATCH**.

**HOROSCOPE**, in astrology, is the degree of the ascendent, or the star that rises above the horizon at a certain moment, which is observed in order to predict some future event, as the success of a design, the fortune of a person who was at that instant born, &c.

**HORSE**, in zoology. See **EQUUS**.

## H O R S E M A N S H I P;

Or, The Art of Riding, and of Training and Managing HORSES.

*The method of preparing horses to be mounted.*

**T**HOUGH all horses are generally bought at an age when they have already been backed, they should be begun and prepared for the rider with the same care, gentleness and caution, as if they had never been handled or backed, in order to prevent accidents, which might else arise from skittishness or other causes: and as it is proper that they should be taught the figure of the ground

they are to go upon, when they are at first mounted, they should be previously trotted in a *longe* on circles, without any one upon them.

The manner of doing this is as follows: Put an easy *cavesson* upon the horse's nose, and make him go forwards round you, standing quiet and holding the *longe*; and let another man, if you find it necessary, follow him with a whip. All this must be done very gently, and but a little at a time: for more horses are spoiled by over-much work, than by any other treatment whatever; and that

by

by very contrary effects; for sometimes it drives them into vice, madness and despair, and often stupifies and totally dispirits them.

The first obedience required in a horse is going forwards: Till he performs this duty freely, never even think of making him rein back, which would inevitably make him restive: As soon as he goes forwards readily, stop and carefs him. You must remember in this, and likewise in every other exercise, to use him to go equally well to the right and left; and when he obeys, carefs him and dismiss him immediately. If a horse, that is very young, takes fright and stands still, lead on another horse before him, which probably will induce him instantly to follow. Put a snaffle in his mouth; and when he goes freely, saddle him, girting him at first very loose. Let the cord, which you hold, be long and loose; but not so much, so as to endanger the horse's entangling his legs in it. It must be observed, that small circles, in the beginning, would constrain the horse too much, and put him upon defending himself. No bend must be required at first: never suffer him to gallop false; but whenever he attempts it, stop him without delay, and then set him off afresh. If he gallops of his own accord, and true, permit him to continue it; but if he does it not voluntarily, do not demand it of him at first. Should he fly and jump, shake the cord gently upon his nose without jerking it, and he will fall into his trot again. If he stands still, plunges or rears, let the man who holds the whip, make a noise with it; but never touch him, till it be absolutely necessary to make him go on. When you change hands, stop and carefs him, and entice him by fair means to come up to you: For by presenting yourself, as some do, on a sudden before horses, and frightening them to the other side, you run a great risk of giving them a shynefs. If he keeps his head too low, shake the *cavesson* to make him raise it: And in whatever the horse does, whether he walks, trots, or gallops, let it be a constant rule, that the motion be determined and really such as is intended, without the least shuffling, pacing, or any other irregular gait.

*The method of placing the rider and rendering him firm on horseback, with some occasional instructions for riders and the horses.*

IT is necessary that the greatest attention, and the same gentleness, that is used in teaching the horses, be observed likewise in teaching the rider, especially at the beginning. Every method and art must be practised to create and preserve, both in man and horse, all possible feeling and sensibility, contrary to the usage of most riding masters, who seem industriously to labour at abolishing these principles both in one and the other. As so many essential points depend upon the manner in which a man is at first placed on horseback, it ought to be considered and attended to with the strictest care and exactness.

The absurdity of putting a man, who perhaps has never before been upon a horse, on a rough trotting horse, on which he is obliged to stick with all the force of his arms and legs, is too obvious to need mentioning. This rough

work, all at once, is plainly as detrimental at first, as it is excellent afterwards in proper time. No man can be either well, or firmly seated on horseback, unless he be master of the balance of his body, quite unconstrained, with a full possession of himself, and at his ease; none of which requisites can he enjoy, if his attention be otherwise engaged; as it must wholly be in a raw, unsuspected, and unprepared lad, who is put at once upon a rough horse: in such a distressful state he is forced to keep himself on at any rate, by holding to the bridle, (at the expence of the sensibility both of his own hand, and the horse's mouth,) and by clinging with his legs, in danger of his life, and to the certain deprivation of a right feeling in the horse.

The first time a man is put on horseback, it ought to be upon a very gentle one. He never should be made to trot, till he is quite easy in the walk; nor gallop, till he is able to trot properly. The same must be observed in regard to horses: they should never be made to trot, till they are obedient, and their mouths are well formed on a walk; nor be made to gallop, till the same be effected on a trot. When he is arrived at such a degree of firmness in his seat, the more he trots, and the more he rides rough horses, the better. This is not only the best method, but also the easiest and the shortest: by it, a man is soon made sufficiently an horseman for a soldier; but by the other detestable methods, that are commonly used, a man, instead of improving, contracts all sorts of bad habits, and rides worse and worse every day; the horse too becomes daily more and more unfit for use. In proceeding according to the manner proposed, a man is rendered firm and easy upon the horse, both his own and the horse's sensibility is preserved, and each in a situation fit to receive and practise all lessons effectually.

Among the various methods that are used of placing people on horseback, few are directed by reason. Before you let the man mount, teach him to know, and always to examine, if the curb be well placed, (that is, when the horse has a bit in his mouth, which at first he should not; but only a snaffle, till the rider is firm in his seat, and the horse also somewhat taught;) and likewise if the nose-band be properly tight; the throat-band loose, and the mouth-piece neither too high nor too low in the horse's mouth, but rightly put so as not to wrinkle the skin, nor to hang lax; the girths drawn moderately, but not too tight; and the crupper and the breast-plate properly adjusted. A very good and careful hand may venture on a bit at first, and succeed with it full as well, as by beginning with a snaffle alone: on colts, indeed, it is better, in all schools whatsoever, to avoid any pressure on the bars just at first, which a curb, though ever so delicately used, must in some degree occasion. When the bridle, &c. have been well looked to, let the man approach the horse gently near the shoulder; then taking the reins and an handful of the mane in his left hand, let him put his foot softly in the left stirrup, by pulling it towards him, least he touch the horse with his toe, then raising himself up, let him rest a moment on it with his body upright, but not stiff: and after that passing his right leg clear over the saddle without rubbing against any thing, let him seat himself gently down. He must be

be cautious not to take the reins too short, for fear of making the horse rear, run, or fall back, or throw up his head; but let him hold them of an equal length, neither tight nor slack, and with the little finger betwixt them. It is fit that horses should be accustomed to stand still to be mounted, and not to stir till the rider pleases. All soldiers should be instructed to mount and dismount equally well on both sides, which may be of very great use in times of hurry and confusion. Then place the man in his saddle, with his body rather back, and his head held up with ease, without stiffness; seated neither forwards, nor very backwards, with the breast pushed out a little, and the lower part of the body likewise a little forwards; the thighs and legs turned in without constraint, and the feet in a straight line, neither turned in nor out: By this position, the natural weight of the thighs has a proper and sufficient pressure of itself, and the legs are in readiness to act, when called upon: they must hang down easy and naturally, and be so placed, as not to be wriggling about, touching and tickling the horse's sides, but always near them in case they should be wanted, as well as the heels.

The body must be carefully kept easy and firm, and without any rocking, when in motion; which is a bad habit very easily contracted, especially in galloping. The left elbow must be gently leant against the body, a little forwards; unless it be so rested, the hand cannot be steady, but will be always checking, and consequently have pernicious effects on the horse's mouth: and the hand ought to be of equal height with the elbow; if it were lower, it would constrain and confine the motion of the horse's shoulders; but, as the mouths of horses are different, the place of the hand also must occasionally differ: a leaning, low, heavy for hand requires a high hand; and a horse that pokes out his nose, a low one. The right hand arm must be placed in symmetry with the left; only let the right hand be a little forward or backward, higher or lower as occasions may require, in order that both hands may be free: both arms must be a little bent at the elbow, to prevent stiffness.

A soldier's right hand should be kept unemployed in riding; it carries the sword, which is a sufficient business for it.

There remains one farther observation, that ought not to be omitted, about the hand, that it must be kept clear of the body; *i. e.* about two inches and half forwards from it, with the nails turned opposite to the belly, and the wrist a little rounded with ease; a position not less graceful than ready for slackening, tightening, and moving the reins from on side to the other, as may be found necessary.

When the reins are well placed, the more rough trotting they have without stirrups, the better; but with a strict care always, that their position be preserved very exactly. In all cases, great care must be taken to hinder their clinging with their legs: In short, no sticking by hands or legs is ever to be allowed of at any time. If the motion of the horse be too rough, slacken it, till the rider grows by degrees more firm: and when he is quite firm and easy on his horse in every kind of motion, stir-

rups may be given him; but he must never leave off trotting often without any.

The stirrups must be neither short nor long; but of such a length, that when the rider, being well placed, puts his feet into them, (about one third of the length of each foot from the point of it,) the points may be between two and three inches higher than the heels. The rider must not bear upon his stirrups, but only let the natural weight of his legs rest on them: For if he bear upon them, he would be raised above and out of his saddle; which should never be, except in charging sword in hand, with the body inclined forwards at the very instant of attacking. Spurs may be given, as soon as the rider is grown familiar with stirrups, or even long before, if his legs are well placed.

A hand should always be firm, but delicate: a horse's mouth should never be surpris'd by any sudden transition of it, either from slack to tight, or from tight to slack. Every thing in horsemanship must be effected by degrees, but at the same time with spirit and resolution. That hand which, by giving and taking properly, gains its point with the least force, is the best; and the horse's mouth, under this same hand's directions, will also consequently be the best, supposing equal advantages in both from nature. This principle of gentleness should be observed upon all occasions in every branch of horsemanship. Sometimes the right hand may be necessary, upon some troublesome horses, to assist the left; but the seldomer this is done, the better; especially in a soldier, who has a sword to carry, and to make use of.

The snaffle must on all occasions be uppermost; that is to say the reins of it must be above those of the bridle, whether the snaffle or the bit be used seperately, or whether they be both used together. When the rider knows enough, and the horse is sufficiently prepared and settled to begin any work towards suppling, one rein must be shortened according to the side worked to; but it must never be so much shortened, as to make the whole strength rest on that rein alone; for, not to mention that the work would be false and bad, one side of the horse's mouth would by that means be always deadened; whereas on the contrary, it should always be kept fresh by its own play, and by the help of the opposite rein's acting delicately in a somewhat smaller degree of tension; the joint effect of which produces in a horse's mouth the proper, gentle and easy degree of *appui* or bearing.

A coward and a madman make alike bad riders, and are both alike discovered and confounded by the superior sense of the creature they are mounted upon, who is equally spoilt by both, though in very different ways. The coward, by suffering the animal to have his own way, not only confirms him in his bad habits, but creates new ones in him: and the madman, by false and violent motions and corrections, drives the horse, through despair, into every bad and vicious trick that rage can suggest.

It is very requisite in horsemanship, that the hand and legs should act in correspondence with each other in every thing; the latter always subservient and assistant to the former. Upon circles, in walking, trotting, or galloping, the outward leg is the only one to be used, and that only for a moment at a time, in order to set off the horse



Arue, or put him right, if he be false; and as soon as that is done, it must be taken away again immediately: but if the horse be lazy, or otherwise retains himself, both legs must be used, and pressed to his sides at the same time together. The leis the legs are used in general, the better. Very delicate good riders, with horses they have dressed themselves, will scarcely ever want their help. By the term *outward* is understood the side which is more remote from the centre; and by *inward* is meant the side next to the centre. In reining back, the rider should be careful not to use his legs, unless the horse backeth on his shoulders; in which case they must be both applied gently at the same time, and correspond with the hand. If the horse refuse to back at all, the riders legs must be gently approached, till the horse lifts up a leg, as if to go forwards; at which time, when that leg is in the air, the rein of the same side with that leg, which is lifted up, will easily bring that same leg backwards, and accordingly oblige the horse to back: but if the horse offers to rear, the legs must be instantly removed away. The inward rein must be the tighter on circles, so that the horse may bend and look inwards; and the outward one crossed over a little towards it; and both held in the left hand.

Let the man and horse begin on very slow motions, that they may have time to understand, and reflect on what is taught them; and in proportion as the effects of the reins are better comprehended, and the manner of working becomes more familiar, the quickness of motion must be increased. Every rider must learn to feel, without the help of the eye, when a horse goes false, and remedy the fault accordingly: this is an intelligence, which nothing but practice, application and attention can give, in the beginning on slow motions. A horse may not only gallop false, but also trot and walk false. If a horse gallops false, that is to say, if going to the right, he leads with the left leg; or if going to the left, he leads with the right; or in case he is disunited, *i. e.* if he leads with the opposite leg behind to that which he leads with before; stop him immediately, and put him off again properly: the method of effecting this, is by approaching your outward leg and putting your hand outwards, still keeping the inward rein the shorter, and the horse's head inwards, if possible; and if he should still resist, then bend and pull his head outwards also, but replace it again, bent properly inwards, the moment he goes off true. A horse is said to be disunited to the right, when going to the right, and consequently leading with the right leg before, he leads with the left behind; and is said to be disunited to the left, when going to the left, and consequently leading with the left leg before, he leads with the right behind. A horse may at the same time be both false and disunited; in correcting both which faults, the same method must be used. He is both false and disunited to the right, when in going to the right he leads with the left leg before, and the right behind; notwithstanding that hinder leg be with propriety more forward under his belly than the left, because the horse is working to the right: and he is false and disunited to the left, when in going to the left he leads with the right leg before, and the left behind; notwithstanding,

as above, that hinder leg be with propriety more forward under his belly than the right, because the horse is working to the left.

In teaching men a right seat on horseback, the greatest attention must be given to prevent stiffness, and sticking by force in any manner upon any occasion: stiffness disgraces every right work; and sticking serves only to throw a man (when displaced) a great distance from his horse by the spring he must go off with: whereas by a proper equilibrating position of the body, and by the natural weight only of the thighs, he cannot but be firm, and secure in his seat.

As the men become more firm, and the horses more supple, it is proper to make the circles less, but not too much so, for fear of throwing the horses forwards upon their shoulders.

Some horses, when first the bit is put into their mouths, if great care be not taken, will put their heads very low. With such horses, raise your right hand with the *bridoon* in it, and play at the same time with the bit in the left hand, giving and taking.

On circles, the rider must lean his body inwards; unless great attention be given to make him do it, he will be perpetually losing his seat outwards. It is scarce possible for him to be displaced if he leans his body properly inwards.

*The method of suppling horses with men upon them, by the EPAULE en dedans, &c. with and without a longe, on circles and on straight lines.*

WHEN a horse is well prepared and settled in all his motions, and the rider firm, it will be proper then to proceed on towards a farther suppling and teaching of both.

In setting out upon this new work, begin by bringing the horse's head a little more inwards than before, pulling the inward rein gently to you by degrees. When this is done, try to gain a little on the shoulders, by keeping the inward rein the shorter, as before, and the outward one crossed over towards the inward one. The intention of these operations is this; the inward rein serves to bring in the head, and procures the bend; whilst the outward one, that is a little crossed, tends to make that bend perpendicular, and as it should be, that is to say, to reduce the nose and the forehead to be in a perpendicular line with each other: it also serves, if put forwards, as well as also crossed, to put the horse forwards, if found necessary, which is often requisite, many horses being apt in this and other works rather to lose their ground backwards than otherwise, when they should rather advance: if the nose were drawn in towards the breast beyond the perpendicular, it would confine the motion of the shoulders, and have other bad effects. All other bends, besides what are above specified, are false. The outward rein, being crossed, not in a forward sense, but rather a little backwards, serves also to prevent the outward shoulder from getting too forwards, and makes it approach the inward one; which facilitates the inward leg's crossing over the outward one; which is the motion that so admirably supples the shoulders. Care must be taken, that the inward leg pass over the outward one,

one, without touching it; this inward leg's crossing over must be helped also by the inward rein, which you must cross towards and over the outward rein every time the outward leg comes to the ground, in order to lift and help the inward leg over it: at any other time, but just when the outward leg comes to the ground, it would be wrong to cross the inward rein, or to attempt to lift up the inward leg by it; nay, it would be demanding an absolute impossibility, and lugging about the reins and horse to no purpose; because in this case, a very great part of the horse's weight resting then upon that leg, would render such an attempt, not only fruitless, but also prejudicial to the sensibility of the mouth, and probably oblige him to defend himself: and moreover, it would put the horse under a necessity of straddling before, and also of leading with the wrong leg, without being productive of any suppling motion whatsoever.

When the horse is thus far familiarly accustomed to what you have required of him, then proceed to effect by degrees the same crossing in his hinder legs. By bringing in the fore-legs more, you will of course engage the hinder ones in the same work: if they resist, the rider must bring both reins more inwards; and, if necessary, put back also, and approach his inward leg to the horse; and if the horse throws out his croup too far, the rider must bring both reins outwards, and if absolutely necessary, he must also make use of his outward leg, in order to replace the horse properly; observing that the croup should always be considerably behind the shoulders, which in all actions must go first; and the moment that the horse obeys, the rider must put his hand and leg again into their usual position.

Nothing is more ungraceful in itself, more detrimental to a man's seat, or more destructive of the sensibility of a horse's sides, than a continual wriggling unsettledness in a horse's legs, which prevents the horse from ever going a moment together true, steady, or determined.

A horse should never be turned, without first moving a step forwards; and when it is doing, the rider must not lift up his elbow, and displace himself; a motion only of the hand from the one side to the other being sufficient for that purpose. It must also be a constant rule never to suffer a horse to be stopped, mounted or dismounted, but when he is well placed. The slower the motions are, when a man or horse is taught any thing, the better.

At first, the figures worked upon must be great, and afterwards made less by degrees, according to the improvement which the man and horse make; and the cadenced pace also, which they work in, must be accordingly augmented. The changes from one side to the other, must be in a bold determined trot, and at first quite straight forwards, without demanding any side motion on two paces, which is very necessary to require afterwards, when the horse is sufficiently suppled. By two paces is meant, when the fore-parts and hinder-parts do not follow, but describe two different lines.

In the beginning, a *longe* is useful on circles, and also on straight lines, to help both the rider and the horse; but afterwards, when they are grown more intelligent, they should go alone. At the end of the lesson, rein back; and then put the horse, by a little at a time, for-

wards, by approaching both legs gently to his sides, and playing with the bridle: if he rears, push him out immediately into a full trot. Shaking the *cavesson* on the horse's nose, and also putting one's self before him and rather near to him, will generally make him back, though he otherwise refuse to do it: and moreover a slight use and approaching of the rider's legs, will sometimes be necessary in backing, in order to prevent the horse from doing it too much upon his shoulders; but the pressure of the legs ought to be very small, and taken quite away the moment that he puts himself enough upon his haunches. If the horse does not back upon a straight line properly, the rider must not be permitted to have recourse immediately to his leg, and so distort himself by it, but first try, if crossing over his hand and reins to which ever side may be necessary, will not be alone sufficient; which most frequently it will; if not, then employ the leg.

After a horse is well prepared and settled, and goes freely on in all his several paces, he ought to be in all his works kept, to a proper degree, upon his haunches, with his hinder legs well placed under him; whereby he will be always pleasant to himself and his rider, will be light in hand, and ready to execute whatever may be demanded of him, with facility, vigour, and quickness.

The common method that is used, of forcing a horse sideways, is a most glaring absurdity, and very hurtful to the animal in its consequences; for instead of suppling him, it obliges him to stiffen and defend himself, and often makes a creature, that is naturally benevolent, restless, frightened and vicious.

For horses, who have very long and high fore-hands, and who poke out their noses, a running snaffle is of excellent use; but for such as bore and keep their heads low, a common one is preferable; though any horse's head indeed may be kept up also with a running one, by the rider's keeping his hands very high and forwards: but whenever either is used alone without a bridle upon horses that carry their heads low and that bore, it must be sawed about from one side to the other.

This lesson of the *epaul en dedans*, should be taught to such people as are likely to become useful in helping to teach men and to break horses; and the more of such that can be found, the better: none others should ever be suffered upon any occasion to let their horses look any way besides the way they are going. But all horses whatever, as likewise all men, who are designed for the teaching others, must go thoroughly and perfectly through this excellent lesson, under the directions of intelligent instructors, and often practise it too afterwards, and when that is done, proceed to, and be finished by the lessons of the head and tail to the wall.

#### *Of the head to the wall, and of the croup to the wall.*

THIS lesson should be practised immediately after that of the *epaule en dedans*, in order to place the horse properly the way he goes, &c. The difference between the head to the wall, and the croup to the wall, consists in this: in the former, the fore parts are more remote from the centre, and go over more ground; in the latter, the hinder-parts are more remote from the center, and consequently

requently go over more ground : in both, as likewise in all other lessons, the shoulders must go first. In riding-houses, the head to the wall is the easier lesson of the two at first, the line to be worked upon being marked by the wall, not far from his head.

The motion of the legs to the right, is the same as that of the *epaule en dedans* to the left, and so *vice versa*; but the head is always bent and turned differently : in the *epaule en dedans*, the horse looks the contrary way to that which he goes ; in this he looks the way he is going.

In the beginning, very little bend must be required ; too much at once would astonish the horse and make him defend himself : it is to be augmented by degrees. If the horse absolutely refuses to obey, it is a sign, that either he or his rider has not been sufficiently prepared by previous lessons. It may happen, that weakness or a hurt in some part of the body, or sometimes temper, though seldom, may be the cause of the horse's defending himself : it is the rider's business to find out from whence the obstacle arises ; and if he finds it to be from the first mentioned cause, the previous lessons must be resumed again for some time ; if from the second, proper remedies must be applied ; and if from the last cause, when all fair means that can be tried have failed, proper corrections with coolness and judgment must be used.

In practising this lesson to the right, bend the horse to the right with the right rein ; helping the left leg over the right (at the time when the right leg is just come to the ground,) with the left rein crossed towards the right, and keeping the right shoulder back with the right rein towards your body, in order to facilitate the left legs crossing over the right ; and so likewise *vice versa* to the left, each rein helping the other by their properly mixed effects. In working to the right, the rider's left leg helps the hinder parts on to the right, and his right leg stops them, if they get too forwards ; and so *vice versa* to the left ; but neither ought to be used, till the hand being employed in a proper manner has failed, or finds that a greater force is necessary to bring what is required about than it can effect alone ; for the legs should not only be corresponding with, but also subservient to the hand ; and all unnecessary aids, as well as all force, ought always to be avoided, as much as possible.

In the execution of all lessons, the equilibrium of the rider's body is of great use to the horse : it ought always to go with and accompany every motion of the animal ; when to the right, to the right ; and when to the left, to the left.

Upon all horses, in every lesson and action, it must be observed, that there is no horse but has his own peculiar appui or degree of bearing, and also a sensibility of mouth, as likewise a rate of his own, which it is absolutely necessary for the rider to discover and make himself acquainted with. A bad rider always takes off at least the delicacy of both, if not absolutely destroys it. The horse will inform his rider when he has got his proper bearing in the mouth, by playing pleasantly and steadily with his bit, and by the spray about his chaps. A delicate and good hand will not only always preserve a light appui, or bearing, in its sensibility ; but also of a heavy one, whether naturally so or acquired, make a light one. The

lighter this appui can be made, the better ; provided that the rider's hand corresponds with it ; if it does not, the more the horse is properly prepared, so much the worse. Instances of this inconvenience of the best of appuis, when the rider is not equally taught with the horse, may be seen every day in some gentlemen, who try to get their horses bitted as they call it, without being suitably prepared themselves for riding them : the consequence of which is, that they ride in danger of breaking their necks ; till at length after much hauling about, and by the joint insensibility and ignorance of themselves and their grooms, the poor animals gradually become mere senseless, unfeeling posts ; and thereby grow, what they call, settled. When the proper appui is found, and made of course as light as possible, it must not be kept duly fixed without any variation, but be played with ; otherwise one equally continued tension of reins would render both the rider's hand and the horse's mouth very dull. The slightest, and frequent giving and taking, is therefore necessary to keep both perfect.

Whatever pace or degree of quickness you work in, (be it ever so fast, or ever so slow,) it must be cadenced ; time is as necessary for an horseman as for a musician.

This lesson of the head and of the tail to the wall, must be taught every soldier : scarce any manœuvre can be well performed without it. In closing and opening of files, it is almost every moment wanted.

*The method of teaching horses to stand fire, noises, alarms, fights, &c.*

In order to make horses stand fire, the sound of drums, and all sorts of different noises, you must use them to it by degrees in the stable at feeding-time ; and instead of being frightened at it, they will soon come to like it as a signal for eating.

With regard to such horses as are afraid of burning objects, begin by keeping them still at a certain distance from some lighted straw : caress the horse ; and in proportion as his fright diminishes, approach gradually the burning straw very gently, and increase the size of it. By this means he will very quickly be brought to be so familiar with it, as to walk undaunted even through it.

As to horses that are apt to lie down in the water, if animating them, and attacking them vigorously, should fail of the desired effect, then break a straw bottle full of water upon their heads, and let the water run into their ears, which is a thing they apprehend very much.

All troop-horses must be taught to stand quiet and still when they are shot off from, to stop the moment you present, and not to move after firing, till they are required to do it ; this lesson ought especially to be observed in light-troops ; in short, the horses must be taught to be so cool and undisturbed, as to suffer the rider to act upon him with the same freedom as if he was on foot. Patience, coolness, and temper, are the only means requisite for accomplishing this end. Begin by walking the horse gently, then stop and keep him from stirring for some time, so as to accustom him by degrees not to have the least idea of moving without orders : if he does, then back him ;

and

and when you stop him, and he is quite still, leave the reins quite loose.

To use a horse to fire-arms, first put a pistol or carbine in the manger with his feed; then use him to the sound of the lock and the pan; after which, when you are upon him, shew the piece to him, presenting it forwards, sometimes on one side, sometimes on the other: when he is thus far reconciled, proceed to flash in the pan; after which, put a small charge into the piece, and so continue augmenting it by degrees to the quantity which is commonly used: if he seems uneasy, walk him forwards a few steps slowly; and then stop, back and caress him. Horses are often also disquieted and unsteady at the flash, and drawing, and returning of swords, all which they must be familiarized to by little and little, by frequency and gentleness.

It is very expedient for all cavalry in general, but particularly for light cavalry, that their horses should be very ready and expert in leaping over ditches, hedges, gates, &c. The leaps, of whatever sort they are, which the horses are brought to in the beginning, ought to be very small ones; the riders must keep their bodies back, raise their hands a little in order to help the foreparts of the horse up, and be very attentive to their equilibrium. It is best to begin at a low bar covered with furze, which pricking the horse's legs, if he does not raise himself sufficiently, prevents his contracting a sluggish and dangerous habit of touching, as he goes over, which any thing yielding and not pricking would give him a custom of doing. Let the ditches you first bring horses to, be narrow; and in this, as in every thing else, let the increase be made by degrees. Accustom them to come up to every thing which they are to leap over, and to stand coolly at it for some time; and then to raise themselves gently up in order to form to themselves an idea of the distance. When they leap well standing, then use them to walk gently up to the leap, and to go over it without first halting at it; and after that practice is familiar to them, repeat the like in a gentle trot, and so by degrees faster and faster, till at length it is as familiar to them to leap flying on a full gallop, as any other way: all which is to be acquired with great facility by calm and soft means without any hurry.

As horses are naturally apt to be frightened at the sight and smell of dead horses, it is advisable to habituate them to walk over, and leap over carcases of dead horses: and as they are particularly terrified at this sight, the greater gentleness ought consequently to be used.

Horses should also be accustomed to swim, which often may be necessary upon service; and if the men and horses both are not used to it, both may be frequently liable to perish in the water. A very small portion of strength is sufficient to guide a horse, any where indeed, but particularly in the water, where they must be permitted to have their heads, and be no ways constrained in any shape.

The unreasonable rage in Britain of cutting off all extremities from horses, is in all cases a very pernicious custom. It is particularly so in regard to a troop-horse's tail. It is almost incredible, how much they suffer at the picket for want of it: constantly fretting, and sweating,

kicking about and laming one another, tormented, and stung off their meat, miserable, and helpless; whilst other horses, with their tails on, brush off all flies, are cool and at their ease, and mend daily, whilst the docked ones grow every hour more and more out of condition.

*The method of reining back,—and of moving forwards immediately after,—of piafing,—of pillars, &c.*

NEVER finish your work by reining back with horses that have any disposition towards retaining themselves; but always move them forwards and a little upon the haunches also after it, before you dismount, (unless they retain themselves very much indeed, in which case nothing at all must be demanded from the haunches.) This lesson of reining back, and piafing, is excellent to conclude with, and puts an horse well and properly on the haunches: It may be done, according as horses are more or less supplied, either going forwards, backing, or in the same place: if it is done well advancing, or at most on the same spot, it is full sufficient for a soldier's horse: For to piafe in backing, is rather too much to be expected in the hurry, which cannot but attend such numbers both of men and horses as must be taught together in regiments. This lesson must never be attempted at all, till horses are very well supplied, and somewhat accustomed to be put together; otherwise it will have very bad consequences, and create restiveness. If they refuse to back, and stand motionless, the rider's legs must be approached with the greatest gentleness to the horse's sides; at the same time as the hand is acting on the reins to sollicit the the horse's backing. This seldom fails of procuring the desired effect, by raising one of the horse's fore-legs, which being in the air, has no weight upon it, and is consequently very easily brought backwards by a small degree of tension in the reins. When this lesson is well performed, it is very noble, and useful, and has a pleasing air; it is an excellent one to begin teaching scholars with.

The lesson is particularly serviceable in the pillars, for placing scholars well at first. Very few regimental riding-houses have pillars, and it is fortunate they have not; for though, when properly made use of with skill, they are one of the greatest and best discoveries in horsemanship; they must be allowed to be very dangerous and pernicious, when they are not under the direction of a very knowing person.

*The method of curing restivenesses, vices, descences, starting, &c.*

WHENEVER a horse makes resistance, one ought, before a remedy or correction is thought of, to examine very minutely all the tackle about him, if any thing hurts or tickles him, whether he has any natural or accidental weakness, or in short any the least impediment in any part. For want of this precaution, many fatal disasters happen: the poor dumb animal is frequently accused falsely of being restive and vicious; is used ill without reason, and, being forced into despair, is in a manner obliged to act accordingly, be his temper and inclination ever so

well disposed. It is very seldom the case, that a horse is really and by nature vicious; but if such be found, he will despise all caresses, and then chastisements become necessary.

Correction, according as you use it, throws a horse into more or less violent action, which, if he be weak, he cannot support: but a vitious strong horse is to be considered in a very different light, being able both to undergo and consequently to profit by all lessons; and is far preferable to the best natured weak one upon earth. Patience and science are never-failing means to reclaim such a horse: in whatsoever manner he defends himself, bring him back frequently with gentleness (not however without having given him proper chastisement, if necessary,) to the lesson which he seems most averse to. Horses are by degrees made obedient, through the hope of recompence and the fear of punishment: how to mix these two motives judiciously together, is a very difficult matter; it requires much thought and practice; and not only a good head, but a good heart likewise. The coolest, and best natured rider, will always succeed best. By a dextrous use of the incitements above mentioned, you will gradually bring the horse to temper and obedience; mere force and want of skill and coolness, would only tend to confirm him in bad tricks. If he be impatient or choleric, never strike him, unless he absolutely refuses to go forwards; which you must resolutely oblige him to do, and which will be of itself a correction, by preventing his having time to meditate, and put in execution any defence by retaining himself. Resistance in horses, you must consider, is sometimes a mark of strength and vigour, and proceeds from spirits, as well as sometimes from vice and weakness. Weakness frequently drives horses into viciousness, when any thing wherein strength is necessary is demanded from them; nay, it inevitably must: great care therefore should always be taken to distinguish from which of these two causes any remedy or punishment is thought of. It may sometimes be a bad sign, when horses do not at all defend themselves, and proceed from a sluggish disposition, a want of spirit, and of a proper sensibility. Whenever one is so fortunate as to meet with a horse of just the right spirit, activity, delicacy of feeling, with strength and good-nature, he cannot be cherished too much; for such a one is a rare and inestimable jewel, and, if properly treated, will in a manner do every thing of himself. Horses are oftener spoiled by having too much done to them, and by attempts to dress them in too great an hurry, than by any other treatment.

If after a horse has been well suppled, and there are no impediments, either natural or accidental, if he still persists to defend himself, chastisements then become necessary: but whenever this is the case, they must not be frequent, but always firm, though always as little violent as possible: for they are both dangerous and very prejudicial, when frequently or slightly played with; and still more so, when used too violently.

It is impossible, in general, to be too circumspect in lessons of all kinds, in aids, chastisements, or caresses. Some have quicker parts, and more cunning, than others. Many will imperceptibly gain a little every day on their

rider. Various, in short, are their dispositions and capacities. It is the rider's business to find out their different qualities, and to make them sensible how much he loves them, and desires to be loved by them; but at the same time that he does not fear them, and will be master.

Plunging is a very common defence among restive and vicious horses: if they do it in the same place, or backing, they must, by the rider's legs and spurs firmly applied, be obliged to go forwards, and their heads kept up high. But if they do it flying forwards, keep them back, and ride them gently and very slow for a good while together. Of all bad tempers and qualities in horses, those which are occasioned by harsh treatment and ignorant riders, are the worst.

Rearing is a bad vice, and, in weak horses especially, a very dangerous one. Whilst the horse is up, the rider must yield his hand, and when the horse is descending, he must vigorously determine him forwards: if this be done at any other time but whilst the horse is coming down, it may add a spring to his rearing, and make him fall backwards. With a good hand on them, horses seldom persist in this vice; for they are themselves naturally much afraid of falling backwards. If this method fails, you must make the horse kick up behind, by getting somebody on foot to strike him behind with a whip; or, if that will not effect it, by pricking him with a goad.

Starting often proceeds from a defect in the sight; which therefore must be carefully looked into. Whatever the horse is afraid of, bring him up to it gently; if you caress him every step he advances, he will go quite up to it by degrees, and soon grow familiar with all sorts of objects. Nothing but great gentleness can correct this fault: for if you inflict punishment, the apprehension of chastisement becomes prevalent, and causes more starting than the fear of the object. If you let him go by the object, without bringing him up to it, you increase the fault, and confirm him in his fear: the consequence of which is, he takes his rider perhaps a quite contrary way from what he was going, becomes his master, and puts himself and the person upon him every moment in great danger.

With such horses as are to a very great degree fearful of any objects, make a quiet horse, by going before them, gradually entice them to approach nearer and nearer to the thing they are afraid of. If the horse, thus alarmed, be undisciplined and head-strong, he will probably run away with his rider; and if so, his head must be kept up high, and the snaffle sawed backwards and forwards from right to left, taking up and yielding the reins of it, as also the reins of the bit: but this latter must not be sawed backwards and forwards, like the snaffle, but only taken up, and yielded properly. No man ever yet did, or ever will stop a horse, or gain any one point over him, by main force, or by pulling a dead weight against him.

#### *Remarks and hints on Shoeing.*

As feet differ, so should shoes accordingly. The only system of farriers, is to shoe in general with excessive heavy and

and clumsy ill-shaped shoes, and very many nails, to the total destruction of the foot. The cramps they annex, tend to destroy the bullet; and the shoes made in the shape of a walnut-shell prevent the horse's walking upon the firm basis which God has given him for that end, and thereby oblige him to stumble and fall. They totally pare away also, and lay bare the inside of the animal's foot with their detestable butteris, and afterwards put on very long shoes, whereby the foot is hindered from having any pressure at all upon the heels, which pressure otherwise might still perchance, notwithstanding their dreadful cutting, keep the heels properly open, and the foot in good order. The frog should never be cut out; but as it will sometimes become ragged, it must be cleaned every now and then, and the ragged pieces cut off with a knife. In one kind of foot indeed a considerable cutting away must be allowed of, but not of the frog; we mean that very high feet must be cut down to a proper height; because if they were not, the frog, though not cut, would still be so far above the ground, as not to have any bearing on it, whereby the great tendon must inevitably be damaged, and consequently the horse would go lame.

The weight of shoes must greatly depend on the quality and hardness of the iron. If the iron be very good, it will not bend; and in this case, the shoes cannot possibly be made too light: care however must be taken, that they be of a thickness so as not to bend; for bending would force out the nails, and ruin the hoof. That part of the shoe which is next the horse's heel, must be narrower than any other, (as is seen in the draught, plate 101. fig. 4.) that stones may be thereby prevented from getting under it, and sticking there; which otherwise would be the case; because the iron, when it advances inwardly beyond the bearing of the foot, forms a cavity, wherein stones being lodged would remain, and, by pressing against the foot, lame the horse. The part of the shoe, which the horse walks upon, should be quite flat, and the inside of it likewise; only just space enough being left next the foot, to put in a picker, (which ought to be used every time the horse comes into the stable,) and also to prevent the shoe's pressing upon the sole. Four nails on each side hold better than a greater number, and keep the hoof in a far better state. The toe of the horse must be cut short, and nearly square. (the angles only just rounded off,) nor must any nails be driven there; this method prevents much stumbling, especially in descents, and serves, by throwing nourishment to the heels, to strengthen them; on them the horse should in some measure walk, and the shoe be made of a proper length accordingly; by this means, narrow heels are prevented, and many other good effects produced. Many people drive a nail at the toe, but it is an absurd practice. Leaving room to drive one there causes the foot to be of an improper length; and moreover that part of the hoof is naturally so brittle, that even when it is kept well greased, the nail there seldom stays in, but tears out and

damages the hoof. That the directions for shoeing a proper length may be the more clear and intelligible, we have annexed (plate 101.) a draught of a foot shod a proper length standing on a plain surface, and with it a draught of the right kind of shoe.

In wet, spongy, and soft ground, where the foot sinks in, the pressure upon the heels is of course greater, than on hard ground; and so indeed it should be upon all accounts. The hinder feet must be treated in the same manner as the fore-ones; and the shoes the same: except in hilly and slippery countries, they may not improperly be turned up a little behind: but turning up the fore-shoes is of no service, and is certain ruin to the fore-legs, especially to the bullets. In descending hills, cramps are apt to throw horses down, by stopping the fore-legs, out of their proper basis and natural bearing when the hinder ones are rapidly pressed; which unavoidably must be the case, and consequently cannot but push the horse upon his nose. With them on a plain surface, a horse's foot is always thrown forwards on the toe, out of its proper bearing, which is very liable to make the horse stumble. The notion of their utility in going up hills is a false one. In ascending, the toe is the first part of the foot, which bears on, takes hold of the ground, and whether the horse draws or carries; and consequently the business is done before the part where the cramps are comes to the ground. Ice nails are preferable to any thing to prevent slipping, as also to help horses up hill, the most forward ones taking hold of the ground early, considerably before the heels touch the ground: they must be so made, as to be, when driven in, scarce half inch above the shoe, and also have four sides ending at the top in a point. They are of great service to prevent slipping on all kinds of places, and by means of them a horse is not thrown out of his proper basis. They must be made of very good iron. If they are not, the heads of them will be perpetually breaking off. From the race-horse to the cart-horse, the same system of shoeing should be observed. The size, thickness, and weight of them only should differ. The shoe of a race-horse must of course be lighter than that of a saddle horse; that of a saddle horse lighter than that of a coach or bāt horse; and these last more so than a cart, waggon, or artillery horse. At present all shoes in general are too heavy; if the iron is good, shoes need not be so thick as they are now generally made. The utmost severity ought to be insisted upon all those who clap shoes on hot: This unpardonable laziness of farriers in making feet thus fit shoes, instead of shoes fitting feet, dries up the hoof, and utterly destroys them. Frequent removals of shoes are detrimental and tear the foot, but sometimes they are very necessary: this is an inconvenience which half-shoes are liable to: for the end of the shoe, being very short, is apt to work soon into the foot, and consequently must often be moved.

For the *Natural History and Treatment of the Diseases of Horses*, see EQUUS, and FARRIERY.

## H O R

**HORSHAM**, a market-town and borough of Sussex, situated twenty miles north west of Lewia, in W. long.

## H O R

22', N. lat. 51° 10'. It sends two members to parliament.

**HORTAGILERS**,

**HORTAGILERS**, in the grand seignior's court, upholsterers, or tapestry-hangers. The grand seignior has constantly four hundred in his retinue when he is in the camp: these go always a day's journey before him, to fix upon a proper place for his tent, which they prepare first; and afterwards those of the officers, according to their rank.

**HORTULANUS**, in ornithology. See **EMBERIZA**.  
**HORTUS SICCUS**, a **DRY-GARDEN**, an appellation given to a collection of specimens of plants, carefully dried and preserved.

Take a specimen of a plant in flower, and with it one of its bottom-leaves, if it have any; bruise the stalk, if too rigid; slit it, if too thick; spread out the leaves and flowers on paper; cover the whole with more paper, and lay a weight over all. At the end of eighteen hours take out the plants, now perfectly flattened; lay them on a bed of dry common sand; sift over them more dry sand, to the depth of two inches, and thus let them lie about three weeks: the less succulent dry much sooner, but they take no harm afterwards. If the floor of a garret be covered in spring with sand two inches deep, leaving space for walking to the several parts, it will receive the collection of a whole summer, the covering of sand being sifted over every parcel as laid in. They need no farther care, from the time of laying them, till they are taken up to be stuck on paper. The cement used is a solution of gum-arabic in water.

Plants may be dried very well without sand, by only putting them frequently into fresh quires of paper, or a few by only pressing them between the leaves of a book; but the sand-method preserves the colour best, and is done with least trouble.

**HOSANNA**, a Hebrew word, signifying *Save now, or Save, we beseech thee*; from the frequent use of which, during the feast of tabernacles, the whole solemnity got the appellation of *Hosanna Rabbi*.

**HOSEA**, a canonical book of the Old Testament, so called from the prophet of that name, its author, who was the son of Beri, and the first of the lesser prophets. He lived in the kingdom of Samaria, and delivered his prophecies under the reign of Jeroboam II. and his successors, kings of Israel; and under the reigns of Uzziah, Jotham, Ahaz, and Hezekiah, kings of Judah. His principal design is to publish the gross idolatries of the people of Israel and Judah, to denounce the divine vengeance against them, and to foretel the captivity in Assyria.

**HOST**, denotes either a person who entertains another, or the person so entertained; but it is now generally used in the first of these senses.

**Host**, in the church of Rome, a name given to the elements used in the eucharist, or rather to the consecrated wafer; which they pretend to offer up every day, a new host or sacrifice, for the sins of mankind.

They pay adoration to the host, upon a false presumption that the elements are no longer bread and wine, but transubstantiated into the real body and blood of Christ. See **TRANSUBSTANTIATION**.

**HOSTAGE**, a person given up to an enemy as a security for the performance of the articles of a treaty.

**HOT-BEDS**, in gardening, beds made with fresh horse-dung, or tanner's bark, and covered with glasses to defend them from cold winds.

**HOTTONIA**, **WATER-VIOLET**, in botany, a genus of the pentandria monogynia class. The corolla is shaped like a jug; the stamina are fixed to the tube of the corolla; and the capsule has but one cell. There are two species, none of them natives of Britain.

**HOVINGHAM**, a market-town of the east riding of Yorkshire, seventeen miles north-east of York.

**HOULSWORTHY**, a market-town of Devonshire, thirty-eight miles north-west of Exeter.

**HOUND**. See **CANIS**.

**HOUR**, in chronology, an aliquot part of a natural day, usually a 24th, sometimes a 12th. See **ASTRONOMY**, **DIALING**, **GEOGRAPHY**.

**HOUSE**, a habitation, or place built with conveniencies for dwelling in. See **ARCHITECTURE**.

**HOUS**, in astrology, denotes the twelfth part of the heavens.

**HOUSTONIA**, in botany, a genus of the tetrandria-monogynia class. The corolla consists of one bell-shaped petal; and the seeds are two, and furrowed. There are two species, none of them natives of Britain.

**HOY**, in naval architecture, a small vessel, fitted only with one mast.

**HOYE**, a town of Westphalia, capital of a county of the same name, and subject to the elector of Hanover: E. long. 9°, N. lat. 53° 5'.

**HUDSON'S BAY**, a large mediterranean sea of north America, situated between 51° and 63° of N. lat. and of unequal breadth from 130 to 35 leagues.

**HUDSON'S streights**, giving entrance into Hudson's bay, lie between 65° and 75° of W. lon.

**HUDSON'S river**, rises near the lake Champlain, in Canada, and falls into the Atlantic, a little below the city of New-York.

**HUE AND CRY**, in law, the pursuit of a person who has committed felony on the highway.

**HUEGLY**, a large town in the East Indies, situated on an island in the most westerly branch of the river Ganges, in the province of Bengal: E. long. 87° N. lat. 25°.

**HUETTE**, a city of Spain, in the province of New Castile, sixty-seven miles east of Madrid: W. lon. 2° 45', N. lat. 40° 35'.

**HUGUENOTS**, a name given by way of contempt to the Calvinists of France.

The name had its rise in the year 1560; but authors are not agreed as to its origin. The most plausible opinion, however, is that of Pasquier, who observes, that at Tours, the place where they were first thus denominated, the people had a notion, that an apparition or hobgoblin, called king Hugon, strolled about the streets in the night-time; from whence as those of the reformed religion met chiefly in the night to pray, &c. they called them Huguenots, that is, the disciples of king Hugon.

**HULKS**,

**HULKS**, large vessels used in setting the masts of ships.

**HULL**, in the sea-language, is the main body of a ship, without either masts, yards, sails, or rigging. Thus to strike a hull in a storm is to take in her sails, and to lash the helm on the lee-side of the ship; and to hull, or lie a-hull, is said of a ship whose sails are thus taken in, and helm lashed a lee.

**HULL**, in geography, a strong sea port town in the east riding of Yorkshire, situated on the river Hull, near the mouth of the Humber, thirty-two miles south-east of York.

**HULPEN**, a town of the Austrian Netherlands, in the province of Brabant, situated nine miles south east of Brussels: E long.  $4^{\circ} 22'$ . N lat.  $50^{\circ} 42'$ .

**HUMAN**, in general, is an appellation given to whatever relates to mankind: thus we say, the human soul, human body, human laws, &c.

**HUMANIFY**, the peculiar nature of man, whereby he is distinguished from all other beings.

**HUMANITIES**, in the plural, signify grammar, rhetoric, and poetry, known by the name of *literæ humaniores*; for teaching of which, there are professors in the universities of Scotland, called humanists.

**HUMBER**, a river formed by the Trent, the Ouse, and several other streams united. It divides Yorkshire from Lincolnshire, and falls into the German Sea at Holderness.

**HUMBLE BEE**. See **APIS**.

**HUMERUS**, in anatomy See **ANAT.** p. 176.

*Luxation of the HUMERUS* See **SURGERY**.

**HUMIDITY**, that quality in bodies whereby they are capable of wetting other bodies. This differs very much from fluidity, and seems to be merely a relative thing, depending upon the congruity of the component particles of the liquor to the pores of such particular bodies, as it is capable of adhering to, penetrating a little into, or wetting. Thus, for instance, quicksilver is not a moist thing with regard to our hands or clothes, but may be called so in reference to gold, tin, or lead, to whose surfaces it will perfectly adhere, and render them soft and moist.

**HUMMING-BIRD**. See **TROCHILUS**.

**HUMOUR**, in a general sense, denotes much the same with liquid or fluid. See **FLUID**.

**HUMOUR**. See **WIT**.

**HUMULUS** in botany, a genus of the triëcia pentandria class. The calix of the male is divided into five parts, and it has no corolla. The calix of the female consists of one entire leaf opening at one side; the corolla is wanting; it has two styli; and the nut has two valves, and is inclosed within the calix. There is but one species, viz. the lupulus, or hop, a native of Britain. See **HOP**.

**HUNDRED**, *hundredum*, or *centuria*, a part or division of a county, which was anciently so called from its containing an hundred families, or from its furnishing an hundred able men for the king's wars. After king Alfred's dividing this kingdom into counties, and giving the government of each county to a sheriff, these counties were divided into hundreds, of which the constable was the chief officer. The grants of hundreds

were at first made by the king to particular persons but they are not now held by grant or prescription; their jurisdiction being devolved to the county court; a few of them only excepted, that have been by privilege annexed to the crown, or granted to some great subjects, and still remain in the nature of a franchise.

**HUNGARY**, a kingdom bounded by the Carpathian mountains, which divide it from Poland, on the north; by Transilvania and Walachia on the east; by the river Drave, which separates it from Sclavonia, on the south; and by Aultria and Moravia on the west. It is one continued plain of 300 miles long, and is situated between  $16^{\circ}$  and  $23^{\circ}$  of E lon. and between  $45^{\circ}$  and  $49^{\circ}$  of N. lat. It is now subject to the empress queen.

**HUNGARY WATER**, a distilled-water, so denominated from a queen of Hungary, for whose use it was first prepared

Quincy gives the following directions for making it. Take of fresh gathered flowers of rosemary, two pounds; rectified spirits of wine, two quarts; put them together, and distil them immediately in balneo.

Or, Take of fresh tops of rosemary, one pound and a half; proof spirit, one gallon; and distil in balneo till five pints are obtained

**HUNGER**, an uneasy sensation, which creates an appetite or desire of food.

Hunger is by some attributed to a sharp acrimonious humour, which vellicates the coats of the stomach; others, who deny the existence of any such liquor, attribute it to the attrition or rubbing of the coats of the stomach; and others, again, account for it from the acidity of the blood.

**HUNGERFORD**, a market-town of Berkshire, situated on the river Kennet, twenty-four miles west of Reading.

**HUNNINGHEN**, a town of Germany, in the langraviate of Alsace, situated on the Rhine, three miles north of Basil: E. long.  $7^{\circ} 35'$ , N. lat.  $47^{\circ} 37'$ .

**HUNNOBY**, a market-town in the east riding of Yorkshire, situated thirty four miles north east of York.

**HUNTING** the exercise or diversion of pursuing four-footed beasts of game.

Four-footed beasts are hunted in the fields, woods, and thickets, and that both with guns and greyhounds.

Birds, on the contrary, are either shot in the air, or taken with nets and other devices, which exercise is called fowling; or they are pursued and taken by birds of prey, which is called hawking.

The pursuing of four-footed beasts, as badgers, deer, does, roebucks, foxes, hares, &c. properly termed hunting, is a noble exercise, serving not only to recreate the mind, but to strengthen the body, whet the stomach, and cheer the spirits.

**HUNTINGDON**, the capital of Huntingdonshire, situated on the river Ouse, fifty six miles north of London: W lon.  $15'$ , and N. lat.  $52^{\circ} 23'$ .

It sends two members to parliament.

**HUQUAM**, a province of China, bounded by Honan



on the north, and by Quamsi and Canton on the south; lying between 25° and 30° of north latitude.

**HURA**, the SAND BOX TREE, in botany, a genus of the monoecia monadelphica class. The male has no calix; the corolla consists of four petals; it has eight stamina, and four glandular bearded nectaria; the calix and corolla of the female are the same as in the male; the stylus is filiform; the stigma is peltated; the capsule has four valves, and but one seed. There is only one species, a native of Mexico.

**HURDLES**, in fortification, twigs of willows or osiers interwoven close together, sustained by long stakes, and usually laden with earth.

**HURDLES**, in husbandry, certain frames, made either of split timber, or of hazel-rods, watted together, to serve for gates in inclosures, or to make sheep-folds, &c.

**HURDS**, or **HORDS**, of flax, or hemp, the coarser parts separated in the dreelings from the tear or fine stuff. See FLAX.

**HURLE-BONE**, in a horse, a bone near the middle of the buttock, very apt to go out of its sockets with a hurt or strain.

**HURON**, a vast lake of North America, situated between 84° and 89° W. long. and between 43° and 46° N. lat. from whence the country contiguous to it is called the country of the Hurons, whose language is spoken over a great extent in the southern parts of North America.

**HURRICANE**, a furious storm of wind, owing to a contrariety of winds. See WIND and WHIRLWIND.

Hurricanes are frequent in the West-indies, where they make terrible ravages, by rooting up trees, destroying houses and shipping, and the like.

**HUSBAND**, a man joined or contracted with a woman in marriage.

**HUSBANDRY**. See AGRICULTURE.

**HUSK**, the same with what botanists call the calix, or cup of a flower. See BOTANY, p. 636, &c.

**HUSO** in ichthyology. See ACCIPENSER.

**HUSSARS**, a kind of irregular cavalry armed with the sabre and bayonet, are retained in the service of most princes or the continent.

They are very resolute partisans, and better in an invasion or hasty expedition than in a set battle.

**HUSSITES**, the disciples of John Hus, a Bohemian, and curate of the chapel of Bethlehem at Prague; who, about the year 1414, embraced and defended the opinions of Wickliff of England, for which he was cited before the council of Constance, and, refusing to renounce his supposed errors, he was condemned to be burnt alive, which sentence was accordingly executed upon him at Constance.

It is evident in what the pretended heresy of John Hus and Jerom of Prague, who suffered with him, consisted, from the answer they made to the council, when they were admonished to conform to the sentiments of the church: They were lovers, they said, of the holy gospel, and true disciples of Christ that the church of Rome, and all other churches of the world, were widely departed from the apostolical tradition;

that the clergy ran after pleasures and riches, larded it over the people, affected the highest seats at entertainments, bred horses and dogs; and the revenues of the church, which belonged to the poor members of Christ, were consumed in vanity and wantonness; and that the priests were ignorant of the commandments of God, or, if they did know them, paid but little regard to them. The followers of Hus were also called Calixtins, Taberites, and Bohemian brethren.

**HUSTINGS**, a court held in Guildhall before the lord-mayor and aldermen of London, and reckoned the supreme court of the city. Here deeds may be enrolled, recoveries passed, out-lawries sued out, and replevins and writs of error determined. In this court also is the election of aldermen, of the four members of parliament for the city, &c.

This court is very ancient, as appears by the laws of Edward the Confessor.

Some other cities have likewise had a court bearing the same name, as Winchester, York, &c.

**HUSUM**, a port-town of Sleswic or south Jutland, situated on the German sea; subject to the duke of Holstein Gottorp: E. long. 8° 30', N. lat. 54° 40'.

**HUTHERFIELD**, a market-town in the west riding of Yorkshire: W. long. 1° 34', N. lat. 53° 37'.

**HUY**, a strong town in the bishopric of Liege, situated on the Maes, sixteen miles north-east of Namur: E. long. 5° 15', N. lat. 50° 35'.

**HYACINTH**, in botany. See HYACINTHUS.

**HYACINTH**, in natural history, a genus of pellucid gems, whose colour is red with an admixture of yellow.

The hyacinth, though less striking to the eye than any other red gems, is not without its beauty in the finest specimens. It is found of various sizes, from that of a pin's head to the third of an inch in diameter. Like common crystal, it is sometimes found columnar, and sometimes in a pebble-form; and is always hardest and brightest in the larger masses.

Its colour is a dull or deadish red, with an admixture of yellow in it; and this mixed colour is found in all the variety of tints that a prevalence of the red or of the yellow in different degrees is capable of giving it.

Our jewelers allow all those gems to be hyacinths or jacinths, that are of a due hardness with this mixed colour; and as they are of very different beauty and value in their several degrees and mixture of colours, they divide them into four kinds; three of which they call hyacinths, but the fourth, very improperly, a ruby. 1. When the stone is in its most perfect state, and of a pure and bright flame-colour, neither the red nor the yellow prevailing, in this state they call it hyacintha la belle. 2. When it has an over proportion of the red, and that of a duskier colour than the fine high red in the former, and the yellow that appears in a faint degree in it is not a fine, bright, and clear, but a dusky brownish-yellow, then they call it the saffron hyacinth. 3. Such stones as are of a dead whitish yellow, with a very small proportion of red in them, they call amber-hyacinths. And, 4. When the

the stone is of a fine deep red, blended with a dusky and very deep yellow, they call it a rubacelle. But though the over-proportion of a strong red in this gem has made people refer it to the class of rubies, its evident mixture of yellow shews that it truly belongs to the hyacinths.

The hyacinth la belle is found both in the East and West Indies. The oriental are the harder but the American are often equal to them in colour. The rubacelle is found only in the East Indies, and is generally brought over among the rubies, but it is of little value: the other varieties are found in Silesia and Bohemia.

**HYACINTHUS**, in botany, a genus of the hexandria monogynia class. The corolla is bell shaped; and there are three melliferous pores in the germen. There are 13 species, only one of which, *viz.* the non-scriptus, English hyacinth, or hare bells, is a native of Britain.

**HYADES**, in astronomy, seven stars in the bull's head, famous among the poets for the bringing of rain. See **ASTRONOMY**, p. 487.

**HYATIDES**, in medicine, little transparent vesicles or bladders, full of water, sometimes found solitary, and sometimes in clusters, upon the liver, and various other parts, especially in hydropical constitutions.

**HYDATOSCOPIA**, called also hydromancy, a kind of divination or method of foretelling future events by means of water.

**HYDNUM**, in botany, a genus of the cryptogamia fungi class: it is an horizontal fungus, echinated or beset with sharp-pointed fibres on its under part. There are four species, only one of which, *viz.* the imbricatum, or common hydnum, is a native of Britain.

**HYDRA**, in astronomy See **ASTRONOMY**, p. 487.

**HYDRAGOGUES**, among physicians, remedies which evacuate a large quantity of water in dropsies.

Quincy observes, that the strongest cathartics chiefly answer to the character of hydragogues, in that by their forcibly shaking and vellicating the bowels and their appendages, they squeeze out water enough to make the stools appear little else.

The principal hydragogues, in the common opinion, are the juices of elder, of the root of iris, of soldanella, mechoacan, jalop, &c.

**HYDRANGÆA**, in botany, a genus of the decandria digynia class. The capsule has two cells, and a double beak. There is but one species, a native of Virginia.

**HYDRAULICS**, the science of the motion of fluids, and the construction of all kinds of instruments and machines relating thereto.

As the construction of hydraulic engines depends upon the knowledge of the general laws of fluids it will be better to give the description of them under the article hydraulics. See **HYDROSTATICS**.

**HYDRENTEROCELE**, in surgery, a species of hernia wherein the intestines descend into the scrotum, together with a quantity of water.

**HYDROCELE**, in surgery denotes any hernia arising from water; but is particularly used for such a one of the scrotum which sometimes grows to the size of one's

head, without pain, but exceeding troublesome to the patient. See **SURGERY**.

**HYDROCEPHALUS**, in surgery, a preternatural distention of the head, to an uncommon size, by a stagnation and extravasation of the lymph, which, when collected within side of the bones of the cranium, the hydrocephalus is then termed internal; as it is external, when retained betwixt the common integuments and the cranium. See **SURGERY**.

**HYDROCHARIS**, the LITTLE WATER-LILY, in botany, a genus of the diœcia decandria class. The spathe of the male consists of two leaves, the calix of three segments, and the corolla of three petals. The calix of the female consists of three segments, and the corolla of three petals; it has six styli; and the capsule has six cells and many seeds. There is but one species, *viz.* the morsus ranæ, or frog bit, a native of Britain.

**HYDROCORAX**, in ornithology. See **BUCEROS**.

**HYDROCOTYLE**, in botany, a genus of the pentandria digynia class. The umbella is simple; the involucre consists of four leaves; the petals are entire, and the seeds are roundish and compressed. There are five species, only one of them, *viz.* the vulgaris, march penny wort, or white rot, is a native of Britain.

**HYDROGRAPHY**, the art of measuring and describing the sea, rivers, lakes, and canals.

With regard to the sea, it gives an account of its tides, counter tides, soundings, bays, gulphs, creeks, &c. as also of the rocks, shelves, sands, shallows, promontories, harbours, the distance and bearing of one port from another, with every thing that is remarkable, whether out at sea, or on the coast.

**HYDROMANCY**, a method of divination by water, practised by the ancients in this manner. They filled a cup or bowl of water: then fastening a ring to a piece of thread tied to their finger, held it over the water, and repeated a certain form of words, desiring to be satisfied with regard to their inquiry; and if the question was answered in the affirmative, the ring would strike the sides of the bowl of its own accord.

Another kind of hydromancy was to look upon the water in which the figure of several dæmons used to appear. This expedient Numa is said to have made use of, to settle the ceremonies of religion.

This way of divination is said to have been used first by the Persians, and afterwards approved by Pythagoras.

**HYDROMEL**, among physicians, water impregnated with honey, either before or after fermentation.

Vinous hydromel, commonly called mead, is said to be good for the gravel. See the article **MEAD**.

**HYDROMETER**, an instrument to measure the gravity, density, velocity, force, &c. of water and other fluids. See **HYDROSTATICS**.

**HYDROTACE**, in botany. See **LEMNA**.

**HYDROMPHALUS**, in medicine and surgery, a tumour in the navel, arising from a collection of water.

**HYDROPHANÆ**, in natural history, a genus of semipellucid gems, composed of crystal and earth; the latter ingredient being in large proportion, and mixed imperfectly

imperfectly, as in the chalcedony; and giving a general cloudiness or mistiness to the stone, but of so imperfect and irregular an admixture, as not to be capable of so good a polish as the chalcedony; and appearing of a dusky and foul surface, till thrown into water, in which they become lucid, and in some degree transparent, either in part or totally; also changing their colour, which returns to them on being taken out of the water.

To this genus belong the oculus beli of authors, or whitish-grey hydrophines, variegated with yellow, and with a black central nucleus; and the oculus mundi, or lapis mutabilis, which is likewise a whitish-grey kind without veins.

**HYDROPHOBIA**, an aversion or dread of water; a

terrible symptom of the rabies canina. See **MEDICINE**. **HYDROPHYLLUM**, in botany, a genus of the pentandria monogynia class. The corolla is bell-shaped; the stigma is bifid; and the capsule is roundish with two valves. There are two species, none of them natives of Britain.

**HYDROPS**, in medicine. See **MEDICINE**.

**HYDROSCOPE**, an instrument anciently used for the measuring of time

The hydroscope was a kind of water-clock, consisting of a cylindrical tub, conical at bottom: the cylinder was graduated, or marked out with divisions, to which the top of the water becoming successively contiguous, as it trickled out at the vertex of the cone, pointed out the hour.

## H Y D R O S T A T I C S.

**T**HE science of **HYDROSTATICS** treats of the nature of gravity, pressure, and motion of fluids in general; and of weighing solids in them.

A fluid is a body that yields to the least pressure or difference of pressures. Its particles are so exceedingly small, that they cannot be discerned by the best of microscopes; they are hard, since no fluid, except air or steam, can be pressed into a less space than it naturally possesses; and they are round and smooth, since they are so easily moved among one another.

All bodies, both fluid and solid, press downwards by the force of gravity: but fluids have this wonderful property, that their pressure upwards and sidewise is equal to their pressure downwards; and this is always in proportion to their perpendicular height, without any regard to their quantity: for, as each particle is quite free to move, it will move towards that part or side on which the pressure is least. And hence, no particle or quantity of a fluid can be at rest, till it is every way equally pressed.

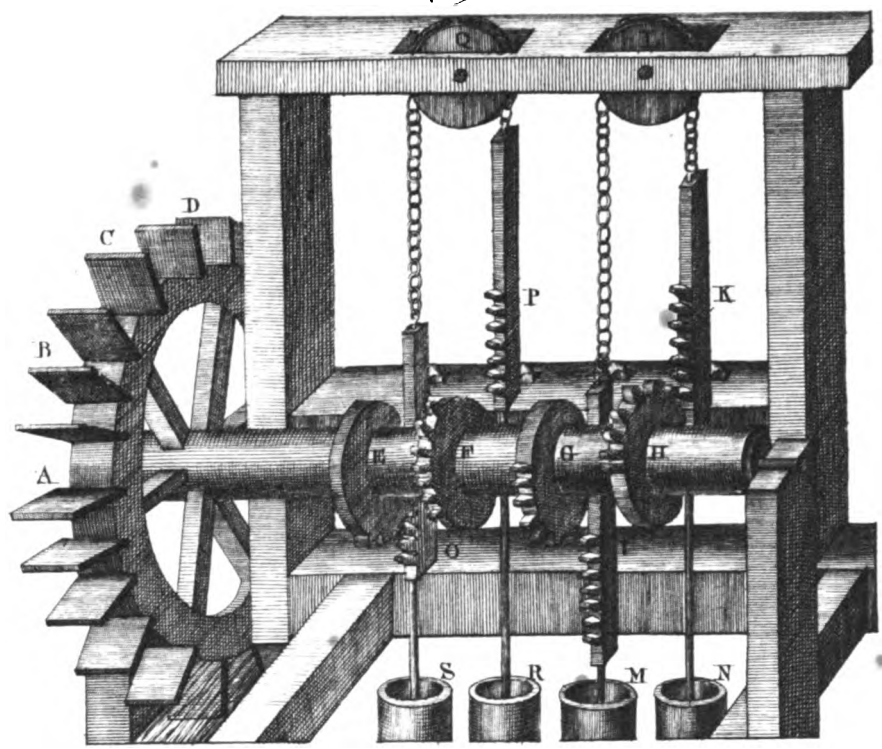
(Plate XCIX. fig. 2.) To shew by experiment that fluids press upward as well as downward, let AB be a long upright tube filled with water near to its top; and CD a small tube open at both ends, and immersed into the water in the large one: if the immersion be quick, you will see the water rise in the small tube to the same height that it stands in the great one, or until the surfaces of the water in both are on the same level: which shews that the water is pressed upward into the small tube by the weight of what is in the great one; otherwise it could never rise therein, contrary to its natural gravity; unless the diameter of the bore were so small, that the attraction of the tube would raise the water; which will never happen, if the tube be as wide as that in a common barometer. And as the water rises no higher in the small tube than till its surface be on a level with the surface of the water in the great one, this shews that the pressure is not in proportion to the quantity of water in the great tube, but in proportion to its perpendicular

height therein: for there is much more water in the great tube all around the small one, than what is raised to the same height in the small one, as it stands in the great.

Take out the small tube, and let the water run out of it; then it will be filled with air. Stop its upper end with the cork C, and it will be full of air all below the cork: this done, plunge it again to the bottom of the water in the great tube, and you will see the water rise up in it to the height E; which shews that the air is a body, otherwise it could not hinder the water from rising up to the same height as it did before, namely, to A; and in so doing it drove the air out at the top; but now the air is confined by the cork C: and it also shews that the air is a compressible body; for if it were not so, a drop of water could not enter into the tube.

The pressure of fluids being equal in all directions, it follows, that the sides of a vessel are as much pressed by a fluid in it, all around in any given ring of points, as the fluid below that ring is pressed by the weight of all that stands above it. Hence the pressure upon every point in the sides, immediately above the bottom, is equal to the pressure upon every point of the bottom. To shew this by experiment, let a hole be made at E (fig. 3.) in the side of the tube AB close by the bottom; and another hole of the same size in the bottom, at C; then pour water into the tube, keeping it full as long as you chuse the holes should run, and have two basons ready to receive the water that runs through the two holes, until you think there is enough in each bason; and you will find, by measuring the quantities, that they are equal; which shews that the water runs with equal speed through both holes; which it could not have done, if it had not been equally pressed through them both: for if a hole of the same size be made in the side of the tube, as about f, and if all three are permitted to run together, you will find that the quantity run through the hole at f is much less than what has run in the same time through either of the holes C or e.

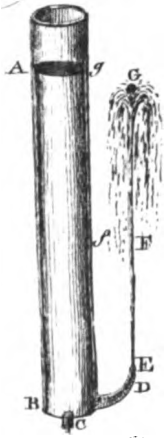
*Fig. 1.*



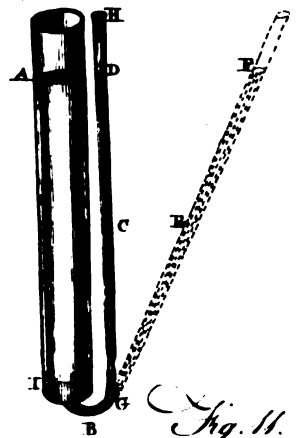
*Fig. 2.*



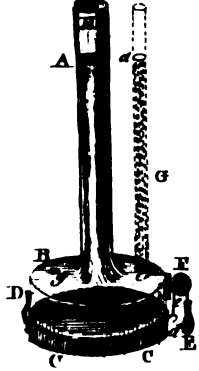
*Fig. 3.*



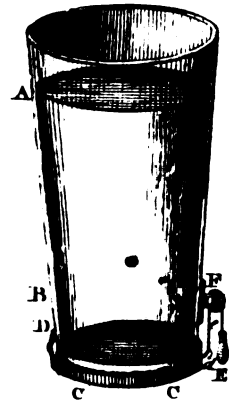
*Fig. 4.*



*Fig. 5.*



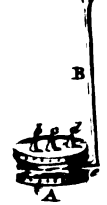
*Fig. 6.*



*Fig. 8.*



*Fig. 7.*



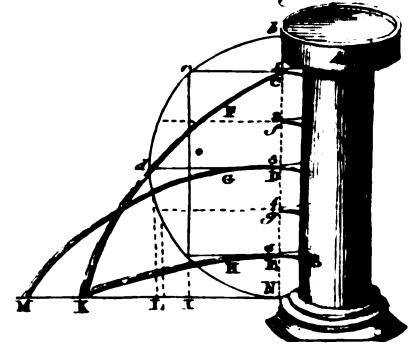
*Fig. 11.*



*Fig. 10.*



*Fig. 9.*



*Abhill & Sulp.*



In the same figure, let the tube be re-curved from the bottom at C into the shape DE, and the hole at C be stopp'd with a cork. Then pour water into the tube to any height, as Ag, and it will spout up in a jet EFG, nearly as high as it is kept in the tube AB, by continuing to pour in as much there as runs through the hole E; which will be the case whilst the surface Ag keeps at the same height. And if a little ball of cork G be laid upon the top of the jet, it will be supported thereby, and dance upon it. The reason why the jet rises not quite so high as the surface of the water Ag, is owing to the resistance it meets with in the open air: for if a tube, either great or small, was screwed upon the pipe at E, the water would rise in it until the surfaces of the water in both tubes were on the same level; as will be shewn by the next experiment.

*The hydrostatic paradox.*

ANY quantity of a fluid, how small soever, may be made to balance and support any quantity, how great soever. This is deservedly termed *the hydrostatical paradox*, which we shall first shew by an experiment, and then account for it upon the principle above-mentioned, namely, that *the pressure of fluids is directly as their perpendicular height, without any regard to their quantity.*

Let a small glass tube DCG, (fig. 4.) open at both ends, and bended at B, be joined to the end of a great one AI at cd, where the great one is also open; so that these tubes in their openings may freely communicate with each other. Then pour water through a small-necked funnel into the small tube at H; this water will run through the joining of the tubes at cd, and rise up into the great tube: and if you continue pouring until the surface of the water comes to any part, as A, in the great tube, and then leave off, you will see that the surface of the water in the small tube will be just as high at D; so that the perpendicular altitude of the water will be the same in both tubes, however small the one be in proportion to the other. This shews, that the small column DCG balances and supports the great column Acd; which it could not do if their pressures were not equal against one another in the recurved bottom at B.—If the small tube be made longer, and inclined in the situation GEF, the surface of the water in it will stand at F, on the same level with the surface A in the great tube; that is, the water will have the same perpendicular height in both tubes, although the column in the small tube is longer than that in the great one; the former being oblique, and the latter perpendicular.

Since then the pressure of fluids is directly as their perpendicular heights, without any regard to their quantities, it appears that whatever the figure or size of vessels be, if they are of equal heights, and if the areas of their bottoms are equal, the pressures of equal heights of water are equal upon the bottoms of these vessels; even though the one should hold a thousand or ten thousand times as much water as would fill the other. To confirm this part of the hydrostatical paradox by an experiment, let two vessels be prepared of equal heights, but very unequal contents, such as AB in fig. 5. and AB in fig. 6.

Let each vessel be open at both ends, and their bottoms Dd Dd be of equal widths. Let a brass bottom CC be exactly fitted to each vessel, not to go into it, but for it to stand upon; and let a piece of wet leather be put between each vessel and its brass bottom, for the sake of closeness. Join each bottom to its vessel by a hinge D, so that it may open like the lid of a box; and let each bottom be kept up to its vessel by equal weights E and E, hung to lines which go over the pulleys F and F (whose blocks are fixed to the sides of the vessels at f) and the lines tied to hooks at d and d, fixed in the brass bottoms opposite to the hinges D and D. Things being thus prepared and fitted, hold the vessel AB (fig. 5.) upright in your hands over a basin on a table, and cause water to be poured into the vessel slowly, till the pressure of the water bears down its bottom at the side d, and raises the weight E; and then part of the water will run out at d. Mark the height at which the surface H of the water stood in the vessel, when the bottom began to give way at d; and then, holding up the other vessel AB (fig. 4.) in the same manner, cause water to be poured into it at H; and you will see that when the water rises to A in this vessel, just as high as it did in the former, its bottom will also give way at d, and it will lose part of the water.

The natural reason of this surprising phenomenon is, that since all parts of a fluid at equal depths below the surface are equally pressed in all manner of directions, the water immediately below the fixed part Bf (fig. 4) will be pressed as much upward against its lower surface within the vessel, by the action of the column Ag, as it would be by a column of the same height, and of any diameter whatever; (as was evident by the experiment with the tube, fig. 3.) and therefore, since action and reaction are equal and contrary to each other, the water immediately below the surface Bf will be pressed as much downward by it, as if it was immediately touched and pressed by a column of the height gA, and of the diameter Bf; and therefore, the water in the cavity BDdf will be pressed as much downward upon its bottom CC, as the bottom of the other vessel (fig. 5.) is pressed by all the water above it.

To illustrate this a little farther, let a hole be made at f (fig. 9.) in the fixed top Bf, and let a tube G be put into it; then, if water be poured into the tube A, it will (after filling the cavity Bd) rise up into the tube G, until it comes to a level with that in the tube A; which is manifestly owing to the pressure of the water in the tube A, upon that in the cavity of the vessel below it. Consequently, that part of the top Bf, in which the hole is now made, would, if corked up, be pressed upward with a force equal to the weight of all the water which is supported in the tube G: and the same thing would hold at g, if a hole were made there. And so if the whole cover or top Bf were full of holes, and had tubes as high as the middle one Ag put into them, the water in each tube would rise to the same height as it is kept into the tube A, by pouring more into it, to make up the deficiency that it sustains by supplying the others, until they were all full: and then the water in the tube A would support equal heights of water in all the rest of the

The tubes, Or, if all the tubes except A, or any other one, were taken away, and a large tube equal in diameter to the whole top Bf were placed upon it, and cemented to it; and then if water were poured into the tube that was left in either of the holes, it would ascend through all the rest of the holes, until it filled the large tube to the same height that it stands in the small one, after a sufficient quantity had been poured into it: which shews, that the top Bf was pressed upward by the water under it, and before any hole was made in it, with a force equal to that wherewith it is now pressed downward by the weight of all the water above it in the great tube. And therefore, the reaction of the fixed top Bf must be as great, in pressing the water downward upon the bottom CC, as the whole pressure of the water in the great tube would have been, if the top had been taken away, and the water in that tube left to press directly upon the water in the cavity BDisf.

*The hydrostatic bellows.*

PERHAPS the best machine in the world for demonstrating the upward pressure of fluids, is the hydrostatic bellows A (fig. 7.) which consists of two thick oval boards, each about 16 inches broad, and 18 inches long, covered with leather, to open and shut like a common bellows, but without valves; only a pipe B, about three feet high, is fixed into the bellows at *e*. Let some water be poured into the pipe at *c*, which will run into the bellows, and separate the boards a little. Then lay three weights *b*, *c*, *d*, each weighing 100 pounds, upon the upper board; and pour more water into the pipe B, which will run into the bellows, and raise up the board with all the weights upon it; and if the pipe be kept full, until the weights are raised as high as the leather which covers the bellows will allow them, the water will remain in the pipe, and support all the weights, even though it should weigh no more than a quarter of a pound, and they 300 pounds: nor will all their force be able to cause them to descend and force the water out at the top of the pipe.

The reason of this will be made evident, by considering what has been already said of the result of the pressure of fluids of equal heights without any regard to their quantity. For, if a hole be made in the upper board, and a tube be put into it, the water will rise in the tube to the same height that it does in the pipe; and would rise as high (by supplying the pipe) in as many tubes as the board could contain holes. Now, suppose only one hole to be made in any part of the board, of an equal diameter with the bore of the pipe B; and that the pipe holds just a quarter of a pound of water; if a person claps his finger upon the hole, and the pipe be filled with water, he will find his finger to be pressed upward with a force equal to a quarter of a pound. And as the same pressure is equal upon all equal parts of the board, each part, whose area is equal to the area of the whole, will be pressed upward with a force equal to that of a quarter of a pound: the sum of all which pressures against the under side of an oval board 16 inches broad, and 18 inches long, will amount to 300 pounds; and therefore so much weight will be raised up and supported by a quarter of a pound of water in the pipe.

Hence, if a man stands upon the upper board, and blows into the bellows through the pipe B, he will raise himself upward upon the board: and the smaller the bore of the pipe is, the easier he will be able to raise himself. And then, by clapping his finger upon the top of the pipe, he can support himself as long as he pleases; provided the bellows be air-tight, so as not to lose what is blown into it.

Upon this principle of the upward pressure of fluids, a piece of lead may be made to swim in water, by immersing it to a proper depth, and keeping the water from getting above it. Let CD (fig. 8.) be a glass tube, open at both ends, and EFG a flat piece of lead, exactly fitted to the lower end of the tube, not to go within it, but for it to stand upon; with a wet leather between the lead and tube to make close work. Let this leaden bottom be half an inch thick, and held close to the tube by pulling the packthread IHL upward at L with one hand, whilst the tube is held in the other by the upper end C. In this situation, let the tube be immersed in water in the glass vessel AB, to the depth of six inches below the surface of the water at K; and then, the leaden bottom EFG will be plunged to the depth of somewhat more than eleven times its own thickness: holding the tube at that depth, you may let go the thread at L; and the lead will not fall from the tube, but will be kept to it by the upward pressure of the water below it, occasioned by the height of the water at K above the level of the lead. For as lead is 11.33 times as heavy as its bulk of water, and is in this experiment immersed to a depth somewhat more than 11.33 times its thickness, and no water getting into the tube between it and the lead, the column of water EabcG below the lead is pressed upward against it by the water KDEGL all around the tube; which water being a little more than 11.33 times as high as the lead is thick, is sufficient to balance and support the lead at the depth KE. If a little water be poured into the tube upon the lead, it will increase the weight upon the column of water under the lead, and cause the lead to fall from the tube to the bottom of the glass vessel, where it will lie in the situation *bd*. Or, if the tube be raised a little in the water, the lead will fall by its own weight, which will then be too great for the pressure of the water around the tube upon the column of water below it.

Let two pieces of wood be plained quite flat, so as no water may get in between them when they are put together: let one of the pieces, as *bd*, be cemented to the bottom of the vessel AB (fig. 8.) and the other piece be laid flat and close upon it, and held down to it by a stick, whilst water is poured into the vessel: then remove the stick, and the upper piece of wood will not rise from the lower one: for, as the upper one is pressed down both by its own weight and the weight of all the water over it, whilst the contrary pressure of the water is kept off by the wood under it, it will lie as still as a stone would do in its place. But if it be raised ever so little at any edge, some water will then get under it; which being acted upon by the water above, will immediately press it upward; and as it is lighter than its bulk of water, it will rise, and float upon the surface of the water.

All fluids weigh just as much in their own element as they

they do in open air. To prove this by experiment, let as much shot be put into a phial, as, when corked, will make it sink in water: and being thus charged, let it be weighed, first in air, and then in water, and the weights in both both cases wrote down. Then, as the phial hangs suspended in water, and counterpoised, pull out the cork, that water may run into it, and it will descend, and pull down that end of the beam. This done, put as much weight into the opposite scale as will restore the equipoise; which weight will be found to answer exactly to the additional weight of the phial when it is again weighed in air, with the water in it.

The velocity with which water spouts out at a hole in the side or bottom of a vessel, is as the square root of the depth or distance of the hole below the surface of the water. For, in order to make double the quantity of a fluid run through one hole as through another of the same size, it will require four times the pressure of the other, and therefore must be four times the depth of the other below the surface of the water: and for the same reason, three times the quantity running in an equal time through the same sort of hole, must run with three times the velocity, which will require nine times the pressure; and consequently must be nine times as deep below the surface of the fluid: and so on.—To prove this by an experiment, let two pipes, as C and g (fig. 9.) of equal sized bores, be fixed into the side of the vessel AB; the pipe g being four times as deep below the surface of the water at b in the vessel as the pipe C is: and whilst these pipes run, let water be constantly poured into the vessel, to keep the surface still at the same height. Then, if a cup that holds a pint be so placed as to receive the water that spouts from the pipe C, and at the same moment a cup that holds a quart be so placed as to receive the water that spouts from the pipe g, both cups will be filled at the same time by their respective pipes.

The horizontal distance, to which a fluid will spout from a horizontal pipe, in any part of the side of an upright vessel below the surface of the fluid, is equal to twice the length of a perpendicular to the side of the vessel, drawn from the mouth of the pipe to a semicircle described upon the altitude of the fluid: and therefore, the fluid will spout to the greatest distance possible from a pipe whose mouth is at the centre of the semicircle; because a perpendicular to its diameter (supposed parallel to the side of the vessel) drawn from that point, is the longest that can possibly be drawn from any part of the diameter to the circumference of the semicircle. Thus, if the vessel AB (fig. 9.) be full of water, the horizontal pipe D be in the middle of its side, and the semicircle  $Nacb$  be described upon D as a centre, with the radius or semidiameter  $D_2N$ , or  $D/h$ , the perpendicular  $Dd$  to the diameter  $NDh$  is the longest that can be drawn from any part of the diameter to the circumference  $Nacb$ . And if the vessel be kept full, the jet G will spout from the pipe D, to the horizontal distance NM, which is double the length of the perpendicular  $Dd$ . If two other pipes as C and E, be fixed into the side of the vessel at equal distances above and below the pipe D, the perpendiculars Cc and Ee, from these pipe to the semicircle, will be equal; and the jets F and H spouting from them will

each go to the horizontal distance NK; which is double the length of the equal perpendiculars Cc or Dd.

Fluids by their pressure may be conveyed over hills and valleys in bended pipes, to any height not greater than the level of the springs from whence they flow. But when they are designed to be raised higher than the springs, forcing engines must be used; which shall be described when we come to treat of pumps.

A *syphon*, generally used for decanting liquors, is a bended pipe, whose legs are of unequal lengths; and the shortest leg must always be put into the liquor intended to be decanted, that the perpendicular altitude of the column of liquor in the other leg may be longer than the column in the immerfed leg, especially above the surface of the water. For, if both columns were equally high in that respect, the atmosphere, which presses as much upward as downward, and therefore acts as much upward against the column in the leg that hangs without the vessel, as it acts downward upon the surface of the liquor in the vessel, would hinder the running of the liquor through the syphon, even though it were brought over the bended part by suction. So that there is nothing left to cause the motion of the liquor, but the superior weight of the column in the longer leg, on account of its having the greater perpendicular height.

Let D (fig. 10.) be a cup filled with water to C, and ABC a syphon, whose shorter leg BCF is immerfed in the water from C to F. If the end of the other leg were no lower than the line AC, which is level with the surface of the water, the syphon would not run, even though the air should be drawn out of it at the mouth A. For although the suction would draw some water at first, yet the water would stop at the moment the suction ceased; because the air would act as much upward against the water at A, as it acted downward for it by pressing on the surface at C. But if the leg AB comes down to G, and the air be drawn out at G by suction, the water will immediately follow, and continue to run, until the surface of the water in the cup comes down to F; because, till then, the perpendicular height of the column BAG will be greater than that of the column CB; and consequently, its weight will be greater, until the surface comes down to F; and then the syphon will stop, though the leg CF should reach to the bottom of the cup. For which reason, the leg that hangs without the cup is always made long enough to reach below the level of its bottom; as from d to E: and then, when the syphon is emptied of air by suction at E, the water immediately follows, and by its continuity brings away the whole from the cup; just as pulling one end of a thread will make the whole cue follow.

If the perpendicular height of a syphon, from the surface of the water to its bended top at B, be more than 33 feet, it will draw no water, even though the other leg were much longer, and the syphon quite emptied of air, because the weight of a column of water 33 feet high is equal to the weight of as thick a column of air, reaching from the surface of the earth to the top of the atmosphere; so that there will then be an equilibrium; and consequently, though there would be weight enough of air upon the surface C to make the water ascend in the

leg



leg CB almost to the height B, if the syphon were emptied of air, yet the weight would not be sufficient to force the water over the bend; and therefore, it could never be brought into the leg BAC.

#### *Tantalus's cup.*

LET a hole be made quite through the bottom of the cup A (fig. 11.) and the longer leg of the bended syphon BCED be cemented into the hole, so that the end D of the shorter leg DE may almost touch the bottom of the cup within. Then, if water be poured into this cup, it will rise in the shorter leg by its upward pressure, extruding the air all the way before it through the longer leg: and when the cup is filled above the bend of the syphon at F, the pressure of the water in the cup will force it over the bend of the syphon: and it will descend in the longer leg CBG, and run through the bottom, until the cup be emptied.

This is generally called *Tantalus's cup*, and the legs of the syphon in it are almost close together; and a little hollow statue, or figure of a man, is sometimes put over the syphon to conceal it; the bend E being with the neck of the figure as high as the chin. So that poor thirsty *Tantalus* stands up to the chin in water, imagining it will rise a little higher, and he may drink; but instead of that, when the water comes up to his chin, it immediately begins to descend; and so, as he cannot stoop to follow it, he is left as much pained with thirst as ever.

#### *The fountain at command.*

THE device called *the fountain at command* acts upon the same principle with the syphon in the cup. Let two vessels A and B (Plate C. fig. 1.) be joined together by the pipe C which opens into them both. Let A be open at top, B close both at top and bottom (save only a small hole at *b* to let the air get out of the vessel B) and A be of such a size as to hold about six times as much water as B. Let a syphon DEF be soldered to the vessel B, so that the part DEe may be within the vessel, and F without it; the end D almost touching the bottom of the vessel, and the end F below the level of D: the vessel B hanging at A by the pipe C (soldered into both) and the whole supported by the pillars G and H upon the stand I. The bore of the pipe must be considerably less than the bore of the syphon.

The whole being thus constructed, let the vessel A be filled with water, which will run through the pipe C, and fill the vessel B. When B is filled above the top of the syphon at E, the water will run through the syphon, and be discharged at F. But since the bore of the syphon is larger than the bore of the pipe, the syphon will run faster than the pipe, and will soon empty the vessel B; upon which the water will cease from running through the syphon at F, until the pipe C re-fills the vessel B, and then it will begin to run as before. And thus the syphon will continue to run and stop alternately, until all the water in the vessel A has run through the pipe C.—So that after a few trials, one may easily guess about what time the syphon will stop, and when it will be-

gin to run: and then to amuse others, he may call out *stop*, or *run*, accordingly.

Upon this principle, we may easily account for *intermitting* or *reciprocating springs*. Let AA (fig. 2) be part of a hill, within which there is a cavity BB; and from this cavity a vein or channel running in the direction BCDE. The rain that falls upon the side of the hill will sink and strain through the small pores and crannies G, G, G, G; and fill the cavity H with water. When the water rises to the level HHC, the vein BCDE will be filled to C, and the water will run through CDF as through a syphon; which running will continue until the cavity be emptied, and then it will stop until the cavity be filled again.

#### *The common pump.*

THE *common sucking pump*, with which we draw water out of wells, is an engine both pneumatic and hydraulic. It consists of a pipe open at both ends, in which is a moveable piston, bucket, or sucker, as big as the bore of the pipe in that part wherein it works; and is leathered round, so as to fit the bore exactly; and may be moved up and down, without suffering any air to come between it and the pipe or pump-barrel.

We shall explain the construction both of this and the forcing pump by pictures of glass models, in which both the action of the pistons and motion of the valves are seen.

Hold the model DCBL (fig. 3.) upright in the vessel of water K, the water being deep enough to rise at least as high as from A to L. The valve *a* on the moveable bucket G, and the valve *b* on the fixed box H, (which box quite fills the bore of the pipe or barrel at H) will each lie close, by its own weight, upon the hole in the bucket and box, until the engine begins to work. The valves are made of brass, and covered underneath with leather for closing the holes the more exactly: and the bucket G is raised and depressed alternately by the handle E and rod D *d*, the bucket being supposed at B before the working begins.

Take hold of the handle E, and thereby draw up the bucket from B to C, which will make room for the air in the pump all the way below the bucket to dilate itself, by which its spring is weakened, and then its force is not equivalent to the weight or pressure of the outward air upon the water in the vessel K: and therefore, at the first stroke, the outward air will press up the water through the notched foot A, into the lower pipe, about as far as *e*: this will condense the rarefied air in the pipe between *e* and C to the same state it was in before; and then, as its spring within the pipe is equal to the force or pressure of the outward air, the water will rise no higher by the first stroke; and the valve *b*, which was raised a little by the dilation of the air in the pipe, will fall, and stop the hole in the box H; and the surface of the water will stand at *e*. Then, depress the piston or bucket from C to B, and as the air in the part B cannot get back again through the valve *b*, it will (as the bucket descends) raise the valve *a*, and so make its way through the upper part of the barrel *d* into the open air. But upon raising the  
larger

bucket G a second time, the air between it and the water in the lower pipe at *e* will be again left at liberty to fill a larger space; and so its spring being again weakened, the pressure of the outward air on the water in the vessel K will force more water up into the lower pipe from *e* to *f*; and when the bucket is at its greatest height C, the lower valve *b* will fall, and stop the hole in the box H as before. At the next stroke of the bucket or piston, the water will rise through the box H towards B, and then the valve *b*, which was raised by it, will fall when the bucket G is at its greatest height. Upon depressing the bucket again, the water cannot be pushed back through the valve *b*, which keeps close upon the hole whilst the piston descends. And upon raising the piston again, the outward pressure of the air will force the water up thro' H, where it will raise the valve, and follow the bucket to C. Upon the next depression of the bucket G, it will go down into the water in the barrel B; and as the water cannot be driven back through the now close valve *b*, it will raise the valve *a* as the bucket descends, and will be lifted up by the bucket when it is next raised. And now, the whole space below the bucket being full, the water above it cannot sink when it is next depressed; but upon its depression, the valve *a* will rise to let the bucket go down; and when it is quite down, the valve *a* will fall by its weight, and stop the hole in the bucket. When the bucket is next raised, all the water above it will be lifted up, and begin to run off by the pipe F. And thus, by raising and depressing the bucket alternately, there is still more water raised by it; which getting above the pipe F, into the wide top I, will supply the pipe, and make it run with a continued stream.

So, at every time the bucket is raised, the valve *b* rises, and the valve *a* falls; and at every time the bucket is depressed, the valve *b* falls, and *a* rises.

As it is the pressure of the air or atmosphere which causes the water to rise and follow the piston or bucket G as it is drawn up; and since a column of water 33 feet high is of equal weight with as thick a column of the atmosphere from the earth to the very top of the air; therefore, the perpendicular height of the piston or bucket from the surface of the water in the well must always be less than 33 feet; otherwise the water will never get above the bucket. But, when the height is less, the pressure of the atmosphere will be greater than the weight of the water in the pump, and will therefore raise it above the bucket; and when the water has once got above the bucket, it may be lifted thereby to any height, if the rod D be made long enough, and a sufficient degree of strength be employed, to raise it with the weight of the water above the bucket; without ever lengthening the stroke.

The force required to work a pump, will be as the height to which the water is raised, and as the square of the diameter of the pump-bore, in that part where the piston works. So that, if two pumps be of equal heights, and one of them be twice as wide in the bore as the other, the widest will raise four times as much water as the narrowest; and will therefore require four times as much strength to work it.

The wideness or narrowness of the pump, in any other part besides that in which the piston works, does not

make the pump either more or less difficult to work; except what difference may arise from the friction of the bore, which is always greater in a narrow bore than in a wide one, because of the greater velocity of the water.

The pump-rod is never raised directly by such a handle as E at the top, but by means of a lever, whose longer arm (at the end of which the power is applied) generally exceeds the length of the shorter arm five or six times; and, by that means, gives five or six times as much advantage to the power. Upon these principles, it will be easy to find the dimensions of a pump that shall work with a given force, and draw water from any given depth. But, as these calculations have been generally neglected by pump-makers (either for want of skill or industry) the following table was calculated by the late ingenious Mr Booth for their benefit. In this calculation, he supposed the handle of the pump to be a lever increasing the power five times; and had often found that a man can work a pump four inches diameter, and 30 feet high above the bucket, and discharge 27½ gallons of water (English wine measure) in a minute. Now, if it be required to find the diameter of a pump, that shall raise water with the same ease from any other height above the bucket; look for that height in the first column, and over against it in the second you have the diameter or width of the pump; and in the third, you find the quantity of water which a man of ordinary strength can discharge in a minute.

Height of the pump above the bucket. Feet.	Diameter of the bore where the bucket works. Inches.		Water discharged in a minute, English wine-measure.	
	100 parts.		Gallons.	Pints.
10	6	.93	81	6
15	5	.65	54	4
20	4	.90	40	8
25	4	.38	32	6
30	4	.00	27	2
35	3	.70	23	3
40	3	.47	20	4
45	3	.26	18	1
50	3	.10	16	3
55	2	.95	14	7
60	2	.83	13	5
65	2	.71	12	4
70	2	.62	11	5
75	2	.53	10	7
80	2	.44	10	2

The forcing-pump.

THE forcing pump raises water through the box H (fig. 4) in the same manner as the sucking-pump does, when the plunger or piston *g* is lifted up by the rod D. But this plunger has no hole through it, to let the water in the barrel

barrel BC get above it when it is depressed to B, and the valve *b* (which rose by the ascent of the water through the box H when the plunger *g* was drawn up) falls down and stops the hole in H, the moment that the plunger is raised to its greatest height. Therefore, as the water between the plunger *g* and box H can neither get through the plunger upon its descent, nor back again into the lower part of the pump *Le*, but has a free passage by the cavity around H into the pipe MM, which opens into the air-vessel KK at P; the water is forced through the pipe MM by the descent of the plunger, and driven into the air-vessel; and in running up through the pipe at P, it opens the valve *a*; which shuts at the moment the plunger begins to be raised, because the action of the water against the under side of the valve then ceases.

The water, being thus forced into the air-vessel KK by repeated strokes of the plunger, gets above the lower end of the pipe GHI, and then begins to condense the air in the vessel KK. For, as the pipe GH is fixed airtight into the vessel below F, and the air has no way to get out of the vessel but through the mouth of the pipe at I, and cannot get out when the mouth I is covered with water, and is more and more condensed as the water rises upon the pipe, the air then begins to act forcibly by its spring against the surface of the water, at H: and this action drives the water up through the pipe IH GF, from whence it spouts in a jet S to a great height; and is supplied by alternately raising and depressing of the plunger *g*, which constantly forces the water that it raises through the valve H, along the pipe MM, into the air-vessel KK.

The higher that the surface of the water H is raised in the air-vessel, the less space will the air be condensed into, which before filled that vessel; and therefore the force of its spring will be so much the stronger upon the water, and will drive it with the greater force through the pipe at F: and as the spring of the air continues whilst the plunger *g* is rising, the stream or jet S will be uniform, as long as the action of the plunger continues: and when the valve *b* opens, to let the water follow the plunger upward, the valve *a* shuts, to hinder the water, which is forced into the air-vessel, from running back by the pipe MM into the barrel of the pump.

If there was no air-vessel to this engine, the pipe GHI would be joined to the pipe MMN at P; and then the jet S would stop every time the plunger is raised, and run only when the plunger is depressed.

Mr Newsham's water-engine, for extinguishing fire, consists of two forcing pumps, which alternately drive water into a close vessel of air; and by forcing the water into that vessel, the air in it is thereby condensed, and compresses the water so strongly, that it rushes out with great impetuosity and force through a pipe that comes down into it; and makes a continued uniform stream by the condensation of the air upon its surface in the vessel.

By means of forcing pumps, water may be raised to any height above the level of a river or spring; and machines may be contrived to work these pumps, either by a running stream, a fall of water, or by horses. An instance in each sort will be sufficient to shew the method.

First, by a running stream, or a fall of water. Let AA (fig. 5.) be a wheel turned by the fall of water BB; and have any number of cranks (suppose six) as C, D, E, F, G, H, on its axis, according to the strength of the fall of water, and the height to which the water is intended to be raised by the engine. As the wheel turns round, these cranks move the levers *c, d, e, f, g, h*, up and down, by the iron rods *i, k, l, m, n, o*; which alternately raise and depress the pistons by the other iron rods *p, q, r, s, t, u, w, x, y*, in twelve pumps; nine whereof, as L, M, N, O, P, Q, R, S, T, appear in the plate; the other three being hid behind the work at V. And as pipes may go from all these pumps, to convey the water (drawn up by them to a small height) into a close cistern, from which the main pipe proceeds, the water will be forced into this cistern by the descent of the pistons. And as each pipe, going from its respective pump into the cistern, has a valve at its end in the cistern, these valves will hinder the return of the water by the pipes; and therefore, when the cistern is once full, each piston upon its descent will force the water (conveyed into the cistern by a former stroke) up the main pipe, to the height the engine was intended to raise it: which height depends upon the quantity raised, and the power that turns the wheel. When the power upon the wheel is lessened by any defect of the quantity of water turning it, a proportionable number of the pumps may be laid aside, by disengaging their rods from the vibrating levers.

This figure is a representation of the engine erected at Blenheim for the Duke of Marlborough, by the late ingenious Mr Aldersca. The water-wheel is  $7\frac{1}{2}$  feet in diameter, according to Mr Switzer's account in his Hydraulics.

When such a machine is placed in a stream that runs upon a small declivity, the motion of the levers and action of the pumps will be but slow; since the wheel must go once round for each stroke of the pumps. But, when there is a large body of slow running water, a cog or spur-wheel may be placed upon each side of the water-wheel AA, upon its axis, to turn a trundle upon each side; the cranks being upon the axis of the trundle. And by proportioning the cog-wheels to the trundles, the motion of the pumps may be made quicker, according to the quantity and strength of the water upon the first wheel; which may be as great as the workman pleases, according to the length and breadth of the float-boards or wings of the wheel. In this manner, the engine for raising water at London-Bridge is constructed; in which the water-wheel is 20 feet diameter, and the floats 14 feet long.

#### *A quadruple pump-mill for raising water.*

THE engine is represented in Plate 99. fig. 1. In which ABCD is a wheel, turned by water according to the order of the letters. On the horizontal axis are four small wheels, toothed almost half round; and the parts of their edges on which there are no teeth are cut down so as to be even with the bottoms of the teeth where they stand.

The teeth of these four wheels take alternately into the

the teeth of four racks, which hang by two chains over the pulleys Q and L; and to the lower ends of these racks there are four iron rods fixed, which go down into the four forcing pumps, S, R, M, and N. And, as the wheels turn, the racks and pump-rods are alternately moved up and down.

Thus, suppose the wheel G has pulled down the rack I, and drawn up the rack K by the chain: as the last tooth of G just leaves the uppermost tooth of I, the first tooth of H is ready to take into the lowermost tooth of the rack K, and pull it down as far as the teeth go; and then the rack I is pulled upward through the whole space of its teeth, and the wheel G is ready to take hold of it, and pull it down again, and so draw up the other — In the same manner, the wheels E and F work the racks O and P.

These four wheels are fixed on the axle of the great wheel in such a manner, with respect to the positions of their teeth, that whilst they continue turning round, there is never one instant of time in which one or other of the pump rods is not going down and forcing the water. So that, in this engine, there is no occasion for having a general air-vessel to all the pumps, to procure a constant stream of water flowing from the upper end of the main pipe.

From each of these pumps, near the lowest end, in the water, there goes off a pipe, with a valve on its farthest end from the pump; and these ends of the pipes all enter one close box, into which they deliver the water: and into this box, the lower end of the main conduct pipe is fixed. So that, as the water is forced or pushed into the box, it is also pushed up the main pipe to the height that it is intended to be raised,

*A pump-engine to go by horses.*

WHERE a stream or fall of water cannot be had, and gentlemen want to have water raised, and brought to their houses from a rivulet or spring; this may be effected by a horse engine, working three forcing-pumps which stand in a reservoir filled by the spring or rivulet: the pistons being moved up and down in the pumps by means of a triple crank ABC, which, as it is turned round by the trundle G (Plate 100. fig. 6.) raises and depresses the rods D, E, F. if the wheel has three times as many cogs as the trundle has staves or rounds, the trundle and cranks will make three revolutions for every one of the wheel: and as each crank will fetch a stroke in the time it goes round, the three cranks will make nine strokes for every turn of the great wheel.

The cranks should be made of cast iron, because that will not bend; and they should each make an angle of 120 with both of the others, as at *a, b, c*; which is (as it were) a view of their radii, in looking endwise at the axis: and then there will be always one or other of them going downward, which will push the water forward with a continued stream into the main pipe. For, when *b* is almost at its lowest situation, and is therefore just beginning to lose its action upon the piston which it moves, *c* is beginning to move downward, which will by its piston continue the propelling force upon the water: and when

*c* is come down to the position of *b*, *a* will be in the position of *c*.

The more perpendicularly the piston rods move up and down in the pumps, the freer and better will their strokes be: but a little deviation from the perpendicular will not be material. Therefore, when the pump-rods D, E, and F go down into a deep well, they may be moved directly by the cranks, as is done in a very good horse-engine of this sort at the late Sir James Creed's at Greenwich, which forces up water about 64 feet from a well under ground, to a reservoir on the top of his house. But when the cranks are only at a small height above the pumps, the pistons must be moved by vibrating levers, as in the above engine at Blenheim: and the longer the levers are, the nearer will the strokes be to a perpendicular.

Let us suppose, that in such an engine as Sir James Creed's, the great wheel is twelve feet diameter, the trundle four feet, and the radius or length of each crank nine inches, working a piston in its pump. Let there be three pumps in all, and the bore of each pump be four inches diameter. Then, if the great wheel has three times as many cogs as the trundle has staves, the trundle and cranks will go three times round for each revolution of the horses and wheel, and the three cranks will make nine strokes of the pumps in that time, each stroke being 18 inches (or double the length of the crank) in a four-inch bore. Let the diameter of the horse-wheel be 18 feet, and the perpendicular height to which the water is raised above the surface of the well be 64 feet.

If the horses go at the rate of two miles an hour (which is very moderate walking) they will turn the great wheel 187 times round in an hour.

In each turn of the wheel the pistons make nine strokes in the pumps, which amount to 1683 in an hour.

Each stroke raises a column of water 18 inches long, and four inches thick, in the pump barrels; which column, upon the descent of the piston, is forced into the main pipe, whose perpendicular altitude above the surface of the well is 64 feet.

Now, since a column of water 18 inches long, and four inches thick, contains 226.18 cubic inches, this number multiplied by 1683 (the strokes in an hour) gives 380661 for the number of cubic inches of water raised in an hour.

A gallon, in wine-measure, contains 231 cubic inches, by which divide 380661, and it quotes 1468 in round numbers, for the number of gallons raised in an hour; which, divided by 63, gives 26½ hogheads — If the horses go faster, the quantity raised will be so much the greater.

In this calculation it is supposed that no water is wasted by the engine. But as no forcing engine can be supposed to lose less than a fifth part of the calculated quantity of water, between the pistons and barrels, and by the opening and shutting of the valves, the horses ought to walk almost 2½ miles *per* hour to fetch up this loss.

A column of water four inches thick, and 64 feet high, weighs 349½ pounds averdupoise, or 424½ pounds troy; and this weight, together with the friction of the engine, is the resistance that must be overcome by the strength of the horses.

The

The horse tackle should be so contriv'd. that the horses may rather push on than drag the levers after them. For if they draw, in going round the walk, the outside leather-straps will rub against their sides and hams; which will hinder them from drawing at right angles to the levers, and so make them pull at a disadvantage. But if they push the levers before their breasts, instead of dragging them, they can always walk at right angles to these levers.

It is no ways material what the diameter of the main or conduct pipe be: for the whole resistance of the water therein, against the horses, will be according to the height to which it is raised, and the diameter of that part of the pump in which the piston works; as we have already observed. So that by the same pump, an equal quantity of water may be raised in (and consequently made to run from) a pipe of a foot diameter, with the same ease as in a pipe of five or six inches; or rather with more ease, because its velocity in a large pipe will be less than in a small one, and therefore its friction against the sides of the pipe will be less also.

And the force required to raise water depends not upon the length of the pipe, but upon the perpendicular height to which it is raised therein above the level of the spring. So that the same force, which would raise water to the height AB (fig. 7.) in the upright pipe *AiklmnopqB*, will raise it to the same height or level *BIH* in the oblique pipe *AEFGH*. For the pressure of the water at the end *A* of the latter, is no more than its pressure against the end *A* of the former.

The weight or pressure of water at the lower end of a pipe, is always as the sine of the angle to which the pipe is elevated above the level parallel to the horizon. For, although the water in the upright pipe *AB* would require a force applied immediately to the lower end *A*, equal to the weight of all the water in it, to support the water, and a little more to drive it up and out of the pipe; yet if that pipe be inclined from its upright position to an angle of 80 degrees (as in *A 80*), the force required to

support or to raise the same cylinder of water will then be as much less as the sine *80 b* is less than the radius *AB*; or as the sine of 80 degrees is less than the sine of 90. And so, decreasing as the sign of the angle of elevation lessens, until it arrives at its level *AC* or place of rest, where the force of the water is nothing at either end of the pipe. For, although the absolute weight of the water is the same in all positions, yet its pressure at the lower end decreases, as the sine of the angle of elevation decreases; as will appear plainly by a farther consideration of the figure.

Let two pipes, *AB* and *BC*, of equal lengths and bores, join each other at *A*; and let the pipe *AB* be divided into 100 equal parts, as the scale *S* is; whose length is equal to the length of the pipe.—Upon this length, as a radius, describe the quadrant *BCD*, and divide it into 90 equal parts or degrees.

Let the pipe *AC* be elevated to 10 degrees upon the quadrant, and then filled with water; then, part of the water that is in it will rise in the pipe *AB*, and if it be kept full of water, it will raise the water in the pipe *AB* from *A* to *i*; that is, to a level *i 10* with the mouth of the pipe at 10: and the upright line *a 10*, equal to *Ai*, will be the sine of 10 degrees elevation; which being measured upon the scale *S*, will be about 17.4 of such parts as the pipe contains 100 in length: and therefore, the force or pressure of the water at *A*, in the pipe *A 10*, will be to the force or pressure at *A* in the pipe *AB* as 17.3 to 100.

Let the same pipe be elevated to 20 degrees in the quadrant, and if it be kept full of water, part of that water will run into the pipe *AB*, and rise therein to the height *At*, which is equal to the length of the upright line *b 20*, or to the sine of 20 degrees elevation; which, being measured upon the scale *S*, will be 34.2 of such parts as the pipe contains 100 in length; and therefore the pressure of the water at *A*, in the full pipe *A 20*, will be to its pressure, if that pipe were raised to the perpendicular situation *AB*, as 34.2 to 100.

Sine of	Parts	Sine of	Parts	Sine of	Parts	Sine of	Parts	Sine of	Parts
D. 1	17	D. 19	325	D. 37	602	D. 55	819	D. 73	956
2	35	20	342	38	616	56	829	74	961
3	52	21	358	39	629	57	839	75	966
4	70	22	375	40	643	58	848	76	970
5	87	23	391	41	656	59	857	77	974
6	104	24	407	42	669	60	866	78	978
7	122	25	423	43	682	61	875	79	982
8	139	26	438	44	695	62	883	80	985
9	156	27	454	45	707	63	891	81	988
10	174	28	469	46	719	64	899	82	990
11	191	29	485	47	731	65	906	83	992
12	208	30	500	48	743	66	913	84	994
13	225	31	515	49	755	67	920	85	996
14	242	32	530	50	766	68	927	86	997
15	259	33	545	51	777	69	934	87	998
16	276	34	559	52	788	70	940	88	999
17	292	35	573	53	799	71	945	89	1000
18	309	36	588	54	809	72	951	90	1000

Elevate

Elevate the pipe to the position A 30 on the quadrant ; and if it be supplied with water, the water will rise from it into the pipe AB; to the height A/, or to the same level with the mouth of the pipe at 30. The sine of this elevation, or of the angle of 30 degrees, is *c* 30; which is just equal to half the length of the pipe, or to 50 of such parts of the scale as the length of the pipe contains 100. Therefore, the pressure of the water at A, in a pipe elevated 30 degrees above the horizontal level, will be equal to one half of what it would be, if the same pipe stood upright in the situation AB.

And thus, by elevating the pipe to 40, 50, 60, 70, and 80 degrees on the quadrant, the sines of these elevations will be *d* 40, *e* 50, *f* 60, *g* 70, and *h* 80; which will be equal to the heights Aw, An, Ao, Ap, and Aq; and these heights measured upon the scale *S* will be 64.2, 76.6, 86.6, 94.0, and 98.5; which express the pressures at A in all these elevations, considering the pressure in the upright pipe AB as 100.

Because it may be of use to have the lengths of all the sines of a quadrant from 0 degrees to 90, we have given the foregoing table, shewing the length of the sine of every degree in such parts as the whole pipe (equal to the radius of the quadrant) contains 1000. Then the sines will be integral or whole parts in length. But if you suppose the length of the pipe to be divided only into 100 equal parts, the last figure of each part or sine must be cut off as a decimal; and then those which remain at the left hand of this separation will be integral or whole parts.

Thus, if the radius of the quadrant (supposed to be equal to the length of the pipe AC) be divided into 1000 equal parts, and the elevation be 45 degrees, the sine of that elevation will be equal to 707 of these parts; but if the radius be divided into 100 equal parts, the same sine will be only 70.7 or  $70\frac{7}{10}$  of these parts. For, as 1000 is to 707, so is 100 to 70.7.

As it is of great importance to all engine-makers, to know what quantity and weight of water will be contained in an upright round pipe of a given diameter and height, so as, by knowing what weight is to be raised, they may proportion their engines to the force which they can afford to work them; we shall subjoin tables shewing the number of cubic inches of water contained in an upright pipe of a round bore, of any diameter from one inch to six and a half; and of any height from one foot to two hundred: together with the weight of the said number of cubic inches, both in troy and avoirdupoise ounces. The number of cubic inches divided by 231, will reduce the water to gallons in wine-measure; and divided by 382, will reduce it to the measure of ale-gallons. Also, the troy ounces divided by 12, will reduce the weight to troy pounds: and the avoirdupoise ounces divided by 16, will reduce the weight to avoirdupoise pounds.

And here we must repeat it again, that the weight or pressure of the water acting against the power that works the engine must always be estimated according to the perpendicular height to which it is to be raised, without any regard to the length of the conduct pipe, when it has an oblique position; and as if the diameter of that

pipe were just equal to the diameter of that part of the pump in which the piston works. Thus by the tables on the two following pages, the pressure of the water against an engine whose pump is of a  $4\frac{1}{2}$  inch bore, and the perpendicular height of the water in the conduct pipe is 80 feet, will be equal to 8057.5 troy ounces, and to 8848.2 avoirdupoise ounces; which makes 671.4 troy pounds, and 553 avoirdupoise.

EXAMPLE. *Required the number of cubic inches, and the weight of the water, in an upright pipe 278 feet high, and  $1\frac{1}{2}$  inch diameter?*

Feet.	Cubic inches.	Troy oz.	Avoir. oz.
200	4241.1	2238.2	2457.8
70	1484.1	783.3	860.2
8	169.6	89.5	98.3
Ans <sup>r</sup> . 278	5895.1	3111.0	3416.3

Here the nearest angle decimal figure is only taken into the account; and the whole, being reduced by division, amounts to  $25\frac{1}{2}$  wine-gallons in measure, to  $259\frac{1}{2}$  pounds troy, and  $213\frac{1}{2}$  pounds avoirdupoise.

These tables were at first calculated to six decimal places for the sake of exactness; but in transcribing them there are no more than two decimal figures taken into the account, and sometimes but one; because there is no necessity for computing to hundredth parts of an inch or of an ounce in practice.

*The fire engine.*

THE fire-engine comes next in order to be explained: but as it would be difficult, even by the best plates, to give a particular description of its several parts, so as to make the whole intelligible, we shall only explain the principles upon which it is constructed.

1. Whatever weight of water is to be raised, the pump-rod must be loaded with weights sufficient for that purpose, if it be done by a forcing pump, as is generally the case: and the power of the engine must be sufficient for the weight of the rod, in order to bring it up.

2. It is known, that the atmosphere presses upon the surface of the earth with a force equal to 15 pounds upon every square inch.

3. When water is heated to a certain degree, the particles thereof repel one another, and constitute an elastic fluid, which is generally called steam or vapour.

4. Hot steam is very elastic; and when it is cooled by any means, particularly by its being mixed with cold water, its elasticity is destroyed immediately, and it is reduced to water again.

5. If a vessel be filled with hot steam, and then closed so as to keep out the external air and all other fluids; when that steam is by any means condensed, cooled, or reduced to water, that water will fall to the bottom of the vessel; and the cavity of the vessel will be almost a perfect vacuum.

6. Whenever a vacuum is made in any vessel, the air by its weight will endeavour to rush into the vessel, or

to drive in any other body that will give way to its pressure; as may be easily seen by a common syringe. For, if you stop the bottom of a syringe, and then draw up the piston, if it be so tight as to drive out all the air before it, and leave a vacuum within the syringe, the piston being let go will be driven down with a great force.

7. The force with which the piston is drove down, when there is a vacuum under it, will be as the square of the diameter of the bore in the syringe. That is to say, it will be driven down with four times as much force in a syringe of a two-inch bore, as in a syringe of one inch: for the areas of circles are always as the squares of their diameters.

8. The pressure of the atmosphere being to 15 pounds upon every square inch, it will be equal to about 12 pounds upon every circular inch. So that if the bore of the syringe be round, and one inch in diameter, the piston will be pressed down into it by a force nearly equal to 12 pounds: but if the bore be two inches diameter, the piston will be pressed down with four times that force.

And hence it is easy to find with what force the atmosphere presses upon any given number either of square or circular inches.

These being the principles upon which this engine is constructed, we shall next describe the chief working parts of it: which are, 1. A boiler. 2. A cylinder and piston. 3. A beam or lever.

The boiler is a large vessel made of iron or copper; and commonly so big as to contain about 2000 gallons.

The cylinder is about 40 inches diameter, bored so smooth, and its leathered piston fitting so close, that little or no water can get between the piston and sides of the cylinder.

Things being thus prepared, the cylinder is placed upright, and the shank of the piston is fixed to one end of the beam, which turns on a centre like a common balance.

The boiler is placed under the cylinder, with a communication between them, which can be opened and shut occasionally.

The boiler is filled about half full of water, and a strong fire is made under it: then, if the communication between the boiler and the cylinder be opened, the cylinder will be filled with hot steam: which would drive the piston quite out at the top of it. But there is a contrivance by which the piston, when it is near the top of the cylinder, shuts the communication at the top of the boiler within.

This is no sooner shut, than another is opened, by which a little cold water is thrown upwards in a jet into the cylinder, which mixing with the hot steam, condenses it immediately; by which means a vacuum is made in the cylinder, and the piston is pressed down by the weight of the atmosphere; and so lifts up the loaded pump-rod at the other end of the beam.

## HYDROSTATIC TABLES.

1 Inch diameter.				1 1/2 Inches diameter.			
Feet high.	Solidity in cubic inches.	Weight in Troy ounces.	In avoirdupoise ounces.	Feet high.	Solidity in cubic inches.	Weight in Troy ounces.	In avoirdupoise ounces.
1	9.42	4.97	5.46	1	21.21	11.19	12.29
2	18.85	9.95	10.92	2	42.44	22.38	24.58
3	28.27	14.92	16.38	3	63.64	33.57	36.87
4	37.70	19.89	21.85	4	84.8	44.76	49.16
5	47.12	24.87	27.31	5	106.03	55.95	61.45
6	56.55	29.84	32.77	6	127.23	67.15	73.73
7	65.97	34.82	38.23	7	147.44	78.34	86.02
8	75.40	39.79	43.69	8	169.65	89.53	98.31
9	84.82	44.76	49.16	9	190.85	100.72	110.60
10	94.25	49.74	54.62	10	212.06	111.91	122.89
20	188.49	99.48	109.24	20	424.12	223.82	245.78
30	282.74	149.21	163.86	30	636.17	335.73	368.68
40	376.99	198.95	218.47	40	848.23	447.64	491.57
50	471.24	248.69	273.09	50	1060.29	559.55	614.46
60	565.49	298.43	327.71	60	1272.35	671.46	737.35
70	659.73	348.17	382.33	70	1484.40	783.37	860.24
80	753.98	397.90	436.95	80	1696.46	895.28	983.14
90	848.23	447.64	491.57	90	1908.52	1007.19	1106.03
100	942.48	497.38	546.19	100	2120.58	1119.09	1228.92
200	1884.96	994.76	1092.38	200	4241.15	2238.18	2457.84
2 Inches diameter.				2 1/2 Inches diameter.			
1	37.70	19.89	21.85	1	58.90	31.08	34.14
2	75.40	39.79	43.69	2	117.81	62.17	68.27
3	113.10	59.68	65.54	3	176.71	93.26	102.41
4	150.80	79.58	87.39	4	235.62	124.34	136.55
5	188.50	99.47	109.24	5	294.52	155.43	170.68
6	226.19	119.37	131.08	6	353.43	186.52	203.82
7	263.89	139.26	152.92	7	412.33	217.60	238.96
8	301.59	159.16	174.78	8	471.24	248.69	273.09
9	339.29	179.06	196.63	9	530.14	279.77	307.23
10	376.99	198.95	218.47	10	589.05	310.86	341.37
20	753.98	397.90	436.95	20	1178.10	621.72	682.73
30	1130.97	596.85	665.42	30	1767.15	932.58	1024.10
40	1507.97	795.80	873.90	40	2356.20	1243.44	1365.47
50	1884.96	994.75	1092.37	50	2945.25	1554.30	1706.83
60	2261.95	1193.70	1310.85	60	3534.29	1865.16	2048.20
70	2638.94	1392.65	1529.32	70	4123.34	2176.02	2389.27
80	3015.93	1591.60	1747.80	80	4712.39	2486.88	2730.94
90	3392.92	1790.56	1966.27	90	5301.44	2797.74	3072.10
100	3769.91	1989.51	2184.75	100	5890.49	3108.60	3413.67
200	7539.82	3979.00	4369.50	200	11780.98	6217.20	6827.34

HYDRO-

## HYDROSTATIC TABLES.

3 Inches diameter.				$3\frac{1}{2}$ Inches diameter.				5 Inches diameter.				$5\frac{1}{2}$ Inches diameter.			
Feet high.	Solidity in cubic inches.	Weight in Troy ounces.	In avoirdupoise ounces.	Feet high.	Solidity in cubic inches.	Weight in Troy ounces.	In avoirdupoise ounces.	Feet high.	Solidity in cubic inches.	Weight in Troy ounces.	In avoirdupoise ounces.	Feet high.	Solidity in cubic inches.	Weight in Troy ounces.	In avoirdupoise ounces.
1	84.8	44.76	49.16	1	115.4	60.9	66.9	1	235.6	124.3	136.5	1	285.1	150.5	164.3
2	169.6	89.53	98.31	2	230.9	121.8	133.8	2	471.2	248.7	273.1	2	570.2	300.9	328.5
3	254.5	134.29	147.47	3	346.4	182.8	200.7	3	706.8	373.0	409.6	3	855.3	451.4	492.8
4	239.3	179.06	199.63	4	461.8	243.7	267.6	4	942.5	497.4	546.2	4	1140.4	601.8	657.1
5	424.1	223.82	245.78	5	577.3	304.6	334.5	5	1178.1	621.8	682.7	5	1425.5	752.2	821.3
6	508.9	268.58	294.94	6	692.7	365.6	401.4	6	1413.7	746.1	819.3	6	1710.6	902.7	985.6
7	591.7	313.35	344.10	7	808.2	426.5	468.4	7	1649.3	870.4	955.8	7	1995.7	1053.2	1149.9
8	698.6	358.11	393.25	8	923.6	487.4	535.3	8	1884.9	994.8	1092.4	8	2280.8	1203.6	1314.2
9	763.4	402.87	442.41	9	1039.1	548.3	602.2	9	2120.6	1119.1	1228.9	9	2565.9	1354.1	1478.4
10	848.2	447.64	491.57	10	1154.5	609.2	669.1	10	2356.2	1243.4	1365.5	10	2851.0	1504.6	1642.7
20	1696.5	895.28	983.14	20	2309.1	1218.6	1338.2	20	4712.4	2486.9	2730.9	20	5702.0	3009.1	3285.4
30	2244.7	1342.92	1474.70	30	3461.6	1827.9	2007.2	30	7068.6	3710.3	4096.4	30	8553.0	4513.7	4928.1
40	3392.9	1790.56	1966.27	40	4618.1	2437.1	2676.3	40	9424.8	4973.8	5461.9	40	11404.0	6018.2	6570.8
50	4241.1	2238.19	2457.84	50	5772.7	3046.4	3345.4	50	11781.0	6217.2	6827.3	50	14255.0	7522.9	8213.5
60	5089.4	2685.83	2949.41	60	6927.2	3655.7	4014.5	60	14137.2	7460.6	8192.8	60	17106.0	9027.4	9856.2
70	5937.6	3133.47	3440.98	70	8081.7	4265.0	4683.6	70	16493.4	8704.1	9558.3	70	19957.0	10531.9	11498.9
80	6785.8	3581.11	3932.55	80	9236.3	4874.3	5352.6	80	18849.6	9947.5	10923.7	80	22808.0	12036.5	13141.6
90	7634.1	4028.75	4424.12	90	10390.8	5483.6	6021.7	90	21205.8	11191.0	12289.2	90	25659.0	13541.1	14784.3
100	8482.3	4476.39	4915.68	100	11545.4	6092.9	6690.8	100	23562.0	12434.4	13654.7	100	28510.0	15045.1	16426.9
200	16964.6	8952.78	9821.36	200	23090.7	12185.7	13381.5	200	47124.0	24868.8	27309.3	200	57020.0	30091.2	32853.9
4 inches diameter.				$4\frac{1}{2}$ Inches diameter.				6 Inches diameter.				$6\frac{1}{2}$ Inches diameter.			
1	150.8	79.6	87.4	1	190.8	100.7	110.6	1	335.3	179.0	196.6	1	398.2	210.1	230.7
2	301.6	159.2	174.8	2	381.7	201.4	221.2	2	678.6	358.1	393.3	2	797.4	420.3	461.4
3	452.4	238.7	262.2	3	572.6	302.2	331.8	3	1017.9	537.2	589.9	3	1195.6	630.4	692.1
4	603.2	318.	349.6	4	763.4	402.9	442.4	4	1357.2	716.2	786.5	4	1593.8	810.6	922.8
5	754.0	497.9	436.9	5	954.3	503.6	553.0	5	1696.5	895.1	983.1	5	1991.9	1050.8	1153.6
6	904.8	477.5	524.3	6	1145.1	604.3	66.6	6	2035.7	1074.3	1179.8	6	2390.1	1260.9	1384.3
7	1055.6	557.1	611.7	7	1337.9	705.0	774.2	7	2375.0	1251.4	1376.4	7	2788.3	1471.1	1615.0
8	1206.4	636.6	699.1	8	1526.8	805.7	884.8	8	2714.3	1432.4	157.7	8	3186.5	1681.2	1845.7
9	1357.2	716.2	786.5	9	1717.7	906.5	995.4	9	3053.6	1611.5	1769.6	9	3584.7	1891.3	2076.4
10	1508.0	795.8	873.9	10	1908.5	1007.2	1106.0	10	3392.9	1790.6	1966.3	10	3982.0	2101.5	2307.1
20	3115.9	1591.6	1747.8	20	3817.0	2014.4	2212.1	20	6785.8	3581.1	3932.5	20	7965.8	4202.9	4614.3
30	4523.9	2387.4	2621.7	30	5725.6	3021.6	3818.1	30	10178.8	5371.7	5898.8	30	11941.8	6304.4	6921.4
40	6031.9	3181.2	3495.6	40	7644.1	4028.7	4424.1	40	13571.7	7162.2	7865.1	40	15931.7	8105.9	9228.6
50	7539.8	3997.0	4369.5	50	9542.6	5035.9	5530.1	50	16964.6	8952.8	9831.4	50	19914.6	10507.4	11535.7
60	9047.8	4774.8	5243.4	60	11451.1	6043.1	66.6	60	20357.5	10743.3	11797.6	60	23897.6	12608.9	13842.9
70	10555.8	5570.6	6117.3	70	13359.6	7050.3	7742.2	70	23750.5	12513.9	13763.9	70	27880.5	14710.4	16150.0
80	12063.7	6364.4	6991.2	80	15268.2	8057.5	8848.2	80	27144.4	14324.4	15710.2	80	31863.4	16811.8	18457.2
90	13571.7	7162.2	7865.1	90	17176.7	9064.7	9951.1	90	30561.1	16115.0	17696.5	90	35846.3	18913.3	20764.3
100	15079.7	7958.0	8739.1	100	19085.2	10071.9	11060.1	100	33929.2	17905.6	19662.7	100	39829.3	21014.8	23071.5
200	30159.3	15916.0	17478.2	200	38170.4	20143.8	22120.6	200	67858.1	35811.2	39325.4	200	79658.6	42029.6	46143.0



If the cylinder be 42 inches in diameter, the piston will be pressed down with a force greater than 20000 pounds, and will consequently lift up that weight at the opposite end of the beam : and as the pump-rod with its plunger is fixed to that end, if the bore where the plunger works were 10 inches diameter, the water would be forced up through a pipe of 180 yards perpendicular height.

But, as the parts of this engine have a good deal of friction, and must work with a considerable velocity, and there is no such thing as making a perfect vacuum in the cylinder, it is found that no more than 8 pounds of pressure must be allowed for, on every circular inch of the piston in the cylinder, that it may make about 16 strokes in a minute, about 6 feet each.

Where the boiler is very large, the piston will make between 20 and 25 strokes in a minute, and each stroke 7 or 8 feet ; which, in a pump of 9 inches bore, will raise upwards of 300 hogheads of water in an hour.

It is found by experience, that a cylinder 40 inches diameter will work a pump 10 inches diameter and

100 yards long : and hence we can find the diameter and length of a pump that can be worked by any other cylinder.

For the convenience of those who would make use of this engine for raising water, we shall subjoin part of a table calculated by Mr. Beighton, shewing how any given quantity of water may be raised in an hour, from 48 to 440 hogheads ; at any given depth, from 15 to 100 yards ; the machine working at the rate of 16 strokes per minute, and each stroke being 6 feet long.

One example of the use of this table, will make the whole plain. Suppose it were required to draw 150 hogheads per hour, at 90 yards depth ; in the second column from the right hand, I find the nearest number, viz. 149 hogheads 40 gallons ; against which, on the right hand, I find the diameter of the bore of the pump must be 7 inches ; and in the same collateral line, under the given depth 90, I find 27 inches, the diameter of the cylinder fit for that purpose.—And so for any other.

A Table shewing the Power of the Engine for raising Water by Fire ; Calculated to the Measure of Ale-gallons, at 282 cubic Inches per Gallon.

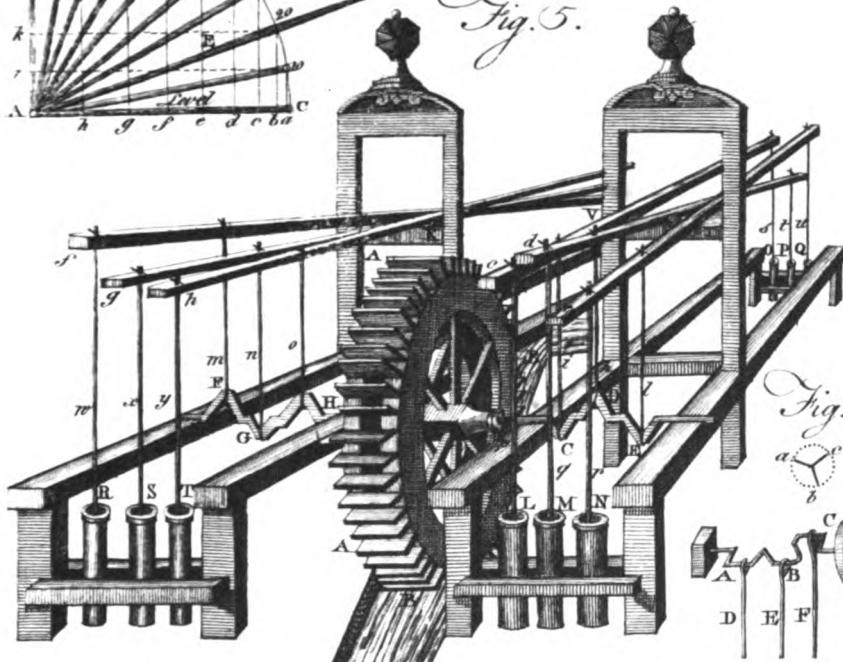
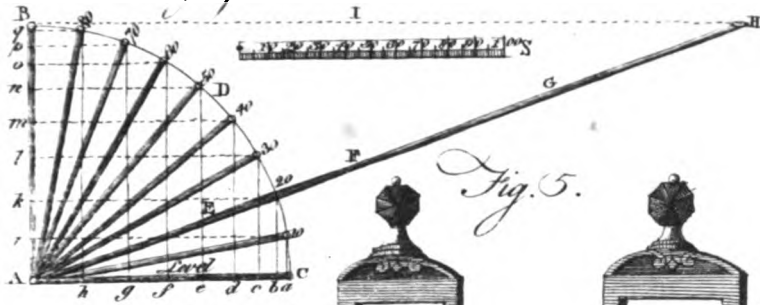
The depth to be drawn in yards.														In one hour.	Diam. of pump.
Diameter of the Cylinder in Inches.	15	20	25	30	35	40	45	50	60	70	80	90	100	Hogsh. Gal.	Inches.
	18½	21½	24	26½	28½	30½	32½	34½	37½	40	—	—	—	—	440
17	19½	22	24½	26½	28	29½	31½	34½	37	39½	—	—	—	369	33
15½	18	20	22	23½	25½	27	28½	31½	33½	36	38½	40	—	304	48
14	16½	18	20	21½	23	24½	25	28	30½	33	35	36½	—	247	7
13½	15½	17½	19	20½	21½	23	24	26½	28½	31	32	35½	—	221	15
12½	14½	16½	18½	19	20½	21½	23	25	27	29	30½	32½	—	195	22
12	14	15½	17½	18½	19½	21	22	24½	26	28	29½	31½	—	182	13
11	13½	15	16½	18	19	20	21½	23½	25	27	28½	30½	—	172	30
10½	13	14	15½	16½	18½	19	20½	22	24	25½	27	28½	—	149	40
10	12	13	14	15½	16½	18	19	20	22	23	24½	26½	—	128	54
9½	11	12	13	14	15½	16	17	19	20½	22	23	24½	—	110	1
	10	11	12	13	14	15	15½	17	19	20	21	22½	—	94	30
		10	11	11	11½	12	12½	14	15½	16½	18½	19½	—	66	61
			10	10	10	11½	12	13½	14	15	16	17	—	60	60
				9	10	11	11½	12	13½	14	15	16	—	48	51
													—	48	4

The Persian wheel.

WATER may be raised by means of a stream AB (Plate 100. fig. 8.) turning a wheel CDE, according to the order of the letters, with buckets a, a, a, &c. hung upon the wheel by strong pins b, b, b, &c. fixed in the side of the rim : but the wheel must be made as high as the water is intended to be raised above the level of that part of the stream in which the wheel is placed. As the wheel turns, the buckets on the right hand go down into

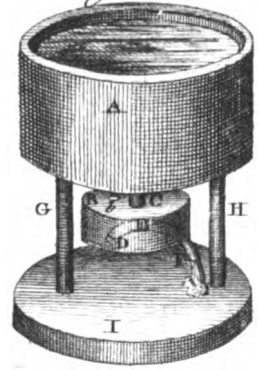
the water, and are thereby filled ; and go up full on the left hand, until they come to the top at K ; where they strike against the end n of the fixed trough M, and are thereby overset, and empty the water into the trough ; from which it may be conveyed in pipes to the place which it is designed for : and as each bucket gets over the trough, it falls into a perpendicular position again, and goes down empty, until it comes to the water at A, where it is filled as before. On each bucket is a spring r, which going over the top or crown of the bar m (fixed to the trough M) raises the bottom of the bucket above the level of

*Fig. 7.*



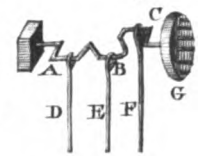
*Fig. 5.*

*Fig. 1.*



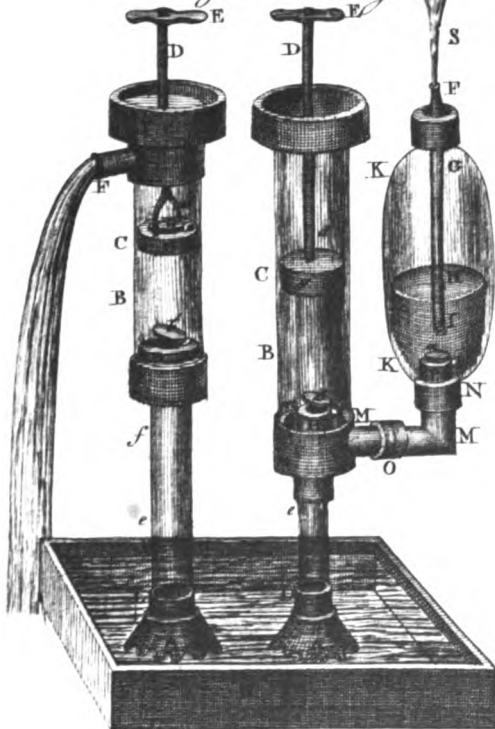
*Fig. 2.*

*Fig. 6.*

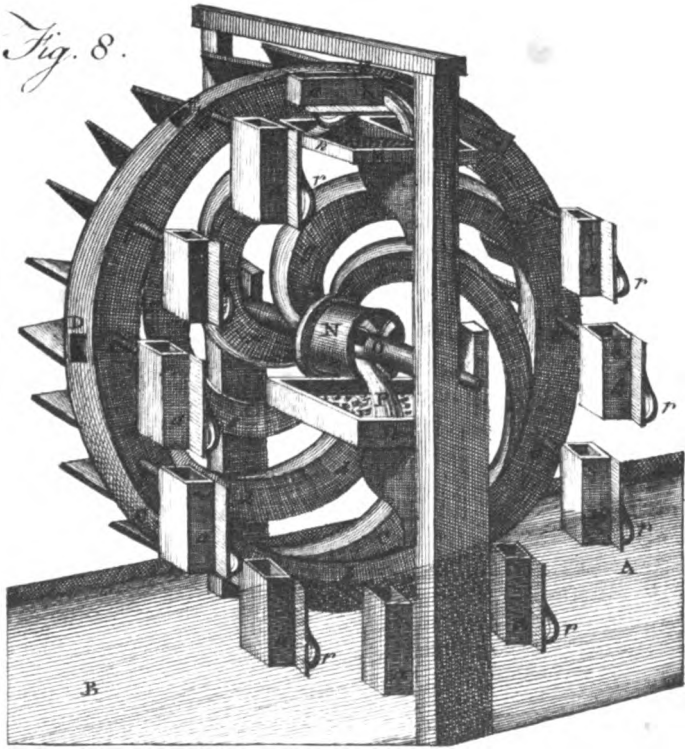


*Fig. 3.*

*Fig. 4.*



*Fig. 8.*





of its mouth, and so causes it to empty all its water into the trough.

Sometimes this wheel is made to raise water no higher than its axis; and then, instead of buckets hung upon it, its spokes C, d, e, f, g, h are made of a bent form, and hollow within; these hollows opening into the holes C, D, E, F, in the outside of the wheel, and also into those at O in the box N upon the axis. So that, as the holes C, D, &c. dip into the water, it runs into them; and as the wheel turns, the water rises in the hollow spokes, e, d, &c. and runs out in a stream P from the holes at O, and falls into the trough Q, from whence it is conveyed by pipes. And this is a very easy way of raising water, because the engine requires neither men nor horses to turn it.

*Of the specific gravities of bodies.*

THE art of weighing different bodies in water, and thereby finding their specific gravities, or weights, bulk for bulk, was invented by Archimedes.

The specific gravities of bodies are as their weights, bulk for bulk: thus a body is said to have two or three times the specific gravity of another, when it contains two or three times as much matter in the same space.

A body immersed in a fluid will sink to the bottom, if it be heavier than its bulk of the fluid. If it be suspended therein, it will lose as much of what it weighed in air, as its bulk of the fluid weighs. Hence, all bodies of equal bulk, which would sink in fluids, lose equal weights when suspended therein. And unequal bodies lose in proportion to their bulks.

*The hydrostatic balance.*

THE hydrostatic balance differs very little from a common balance that is nicely made: only it has a hook at the bottom of each scale, on which small weights may be hung by horse hairs, or by silk threads. So that a body, suspended by the hair or thread, may be immersed in water without wetting the scale from which it hangs.

If the body thus suspended under the scale, at one end of the balance, be first counterpoised in air by weights in the opposite scale, and then immersed in water, the equilibrium will be immediately destroyed. Then, if as much weight be put into the scale from which the body hangs as will restore the equilibrium (without altering the weights in the opposite scale) that weight which restores the equilibrium will be equal to the weight of a quantity of water as big as the immersed body. And if the weight of the body in air be divided by what it loses in water, the quotient will shew how much that body is heavier than its bulk of water. Thus, if a guinea suspended in air be counterbalanced by 129 grains in the opposite scale of the balance; and then upon its being immersed in water, it becomes so much lighter as to require  $7\frac{1}{2}$  grains put into the scale over it, to restore the equilibrium; it shews that a quantity of water of equal bulk with the guinea, weighs  $7\frac{1}{2}$  grains, or 7.25; by which divide 129 (the weight of the guinea in air) and the quotient will be 17.793; which shews that the guinea is

17.793 times as heavy as its bulk of bulk of water. And thus any piece of gold may be tried, by weighing it first in air, and then in water; and if, upon dividing the weight in air by the loss in water, the quotient comes out to be 17.793, the gold is good; if the quotient be 18, or between 18 and 19, the gold is very fine; but if it be less than  $17\frac{1}{2}$ , the gold is too much allayed, by being mixed with some other metal.

If silver be tried in this manner, and found to be 11 times as heavy as water, it is very fine; if it be  $10\frac{1}{2}$  times as heavy, it is standard; but if it be of any less weight compared with water, it is mixed with some lighter metal, such as tin.

By this method the specific gravities of all bodies that will sink in water may be found. But as to those which are lighter than water, as most sorts of wood are, the following method may be taken, to shew how much lighter they are than their respective bulks of water.

Let an upright stud be fixed into a thick flat piece of brass, and in this stud let a small lever, whose arms are equally long, turn upon a fine pin as an axis. Let the thread which hangs from the scale of the balance be tied to one end of the lever, and a thread from the body to be weighed tied to the other end. This done, put the brass and lever into a vessel: then pour water into the vessel, and the body will rise and float upon it, and draw down the end of the balance from which it hangs: then, put as much weight in the opposite scale as will raise that end of the balance, so as to pull the body down into the water by means of the lever; and this weight in the scale will shew how much the body is lighter than its bulk of water.

There are some things which cannot be weighed in this manner, such as quicksilver, fragments of diamonds, &c. because they cannot be suspended in threads; and must therefore be put into a glass bucket, hanging by a thread from the hook of one scale, and counterpoised by weights put into the opposite scale. Thus, suppose you want to know the specific gravity of quicksilver, with respect to that of water; let the empty bucket be first counterpoised in air, and then the quicksilver put into it and weighed. Write down the weight of the bucket, and also of the quicksilver; which done, empty the bucket, and let it be immersed in water as it hangs by the thread, and counterpoised therein by weights in the opposite scale: then, pour the quicksilver into the bucket in the water, which will cause it to preponderate; and put as much weight into the opposite scale as will restore the balance to an equipoise; and this weight will be the weight of a quantity of water equal in bulk to the quicksilver. Lastly, divide the weight of the quicksilver in air, by the weight of its bulk of water, and the quotient will shew how much the quicksilver is heavier than its bulk of water.

If a piece of brass, glass, lead, or silver be immersed and suspended in different sorts of fluids, its different losses of weight therein will shew how much it is heavier than its bulk of the fluid; the fluid being lightest, in which the immersed body loses least of its aerial weight. A solid bubble of glass is generally used for finding the specific gravities of fluids.

Hence we have an easy method of finding the specific gravities both of solids and fluids, with regard to the re-

specific bulks of common pump water, which is generally made a standard for comparing all the others by.

In constructing tables of specific gravities with accuracy, the gravity of water must be represented by unity or 1.000, where three cyphers are added, to give room for expressing the ratios of other gravities in decimal parts, as in the following table.

Take away the decimal point from the numbers in the right hand column, or (which is the same) multiply them by 1000, and they will shew how many ounces avoirdupoise are contained in a cubic foot of each body.

*How to find out the quantity of adulteration in metals.*

THE use of the table of specific gravities will best appear by an example. Suppose a body to be compounded of gold and silver, and it is required to find the quantity of each metal in the compound.

First find the specific gravity of the compound, by weighing it in air and in water, and dividing its aerial weight by what it loses thereof in water, the quotient will shew its specific gravity, or how many times it is heavier than its bulk of water. Then, subtract the specific gravity of silver (found in the table) from that of the compound, and the specific gravity of the compound from that of gold; the first remainder shews the bulk of gold, and the latter the bulk of silver, in the whole compound: and if these remainders be multiplied by the respective specific gravities, the products will shew the proportion of weights of each metal in the body. Example.

Suppose the specific gravity of the compounded body to be 13; that of standard silver (by the table) is 10.5, and that of gold 19.63: therefore 10.5 from 13, remains 2.5, the proportional bulk of the gold; and 13 from 19.63, remains 6.63, the proportional bulk of silver in the compound. Then, the first remainder 2.5, multiplied by 19.63, the specific gravity of gold, produces 49.075 for the proportional weight of gold; and the last remainder 6.63 multiplied by 10.5, the specific gravity of silver, produces 69.615 for the proportional weight of silver in the whole body. So that, for every 49.07 ounces or pounds of gold, there are 69.6 pounds or ounces of silver in the body.

Hence it is easy to know whether any suspected metal be genuine, or alloyed, or counterfeit; by finding how much it is heavier than its bulk of water, and comparing the same with the table: if they agree, the metal is good; if they differ, it is alloyed or counterfeited.

*How to try spirituous liquors.*

A CUBICAL inch of good brandy, rum, or other proof spirits, weighs 235.7 grains; therefore, if a true inch cube of any metal weighs 235.7 grains less in spirits than in air, it shews the spirits are proof. If it loses less of its aerial weight in spirits, they are above proof: if it loses more, they are under. For, the better the spirits are, they are the lighter; and the worse, the heavier.

The hydrometer is one of the most useful instruments of the philosophic kind; for though the hydrostatical balance be the most general instrument for finding the

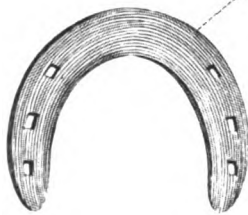
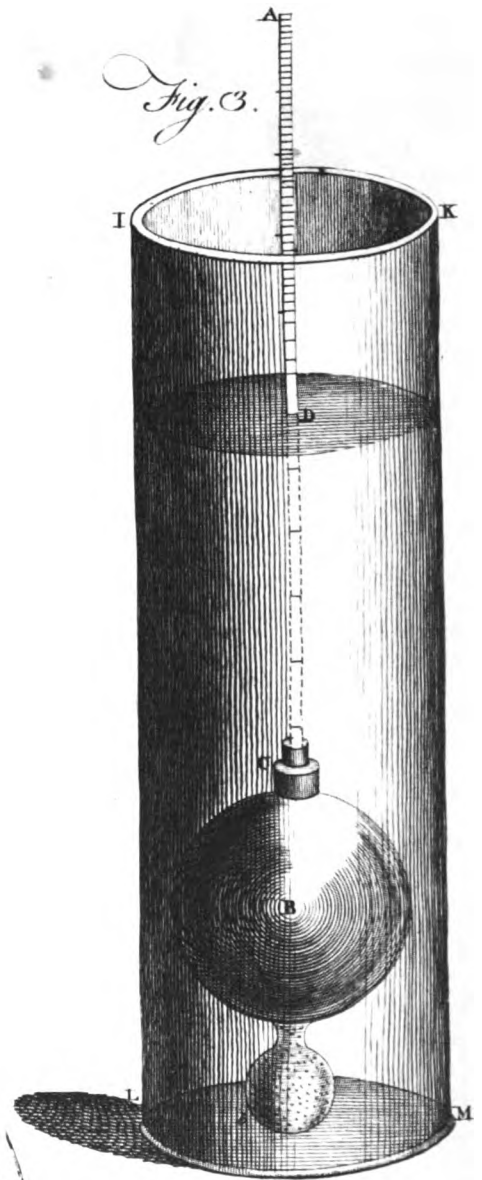
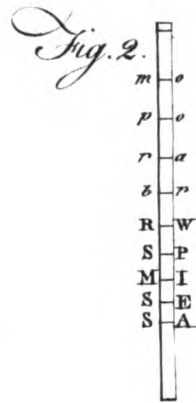
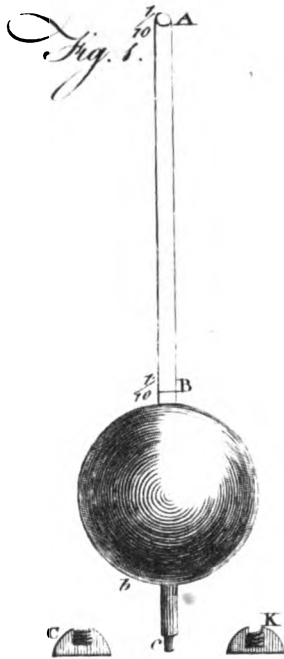
A TABLE of the specific Gravities of the several solid and fluid Bodies.

A cubic inch of	Troy weight			Avoirdup.		Comparative weight.
	oz.	pw.	gr.	oz.	drams.	
Very fine gold	10	7	3.83	1	5 80	19.637
Standard gold	9	19	6.44	10	14 90	18.888
Guinea gold	9	7	17.18	10	4 76	17.793
Moidore gold	9	0	19.84	9	14.71	17.140
Quicksilver	7	7	11.61	8	1.45	14.019
Lead	5	19	17.55	6	9.08	11 325
Fine silver	5	16	23.23	6	6.66	11 087
Standard silver	5	11	3.36	6	1.54	10.535
Copper	4	13	7 04	5	1.89	8.843
Plate brass	4	4	9.60	4	10.09	8 000
Steel	4	2	20.12	4	8.70	7.852
Iron	4	0	15.20	4	6.77	7.645
Block tin	3	17	5 68	4	3.79	7.321
Spelter	3	14	12.86	4	1.42	7 065
Lead ore	3	11	17.76	3	14.96	6.800
Glass of antimony	2	15	16.89	3	0.89	5.280
German antimony	2	2	4.80	2	5.04	4 000
Copper ore	2	1	11.83	2	4.43	3.775
Diamond	1	15	20.88	1	15.48	3.400
Clear glass	1	13	5.58	1	13 16	3.150
Lapis lazuli	1	12	5.27	1	12.27	3.054
Welch asbestos	1	10	17.57	1	10.97	2.913

The



HYDROMETERS



*Fig. 5. HYSTRIX or Porcupine*

The Table concluded.

A cubic inch of	Troy weight.			Avoirdup.		Compa- rative weight.
	oz.	pw.	gr.	oz.	drams.	
White marble	1	8	13.41	1	9.06	2.707
Black ditto	1	8	12.65	1	9.02	2.704
Rock crystal	1	8	1.00	1	8.61	2.658
Green glass	1	7	15.38	1	8.26	2.620
Cornelian stone	1	7	1.21	1	7.73	2.568
Flint	1	6	19.63	1	7.53	2.542
Hard paving stone	1	5	22.87	1	6.77	2.460
Live sulphur	1	1	2.40	1	2.52	2.000
Nitre	1	0	1.08	1	1.59	1.900
Alabaster	0	19	18.74	1	1.35	1.875
Dry ivory	0	19	6.09	1	0.89	1.825
Brimstone	0	18	23.76	1	0.66	1.800
Alum	0	17	21.92	0	15.72	1.714
Ebony	0	11	18.82	0	10.34	1.117
Human blood	0	11	2.89	0	9.76	1.054
Amber	0	10	20.79	0	9.54	1.030
Cow's milk	0	10	20.79	0	9.54	1.030
Sea water	0	10	20.79	0	9.54	1.030
Pump water	0	10	13.30	0	9.26	1.000
Spring water	0	10	12.94	0	9.25	0.999
Distilled water	0	10	11.42	0	9.20	0.993
Red wine	0	10	11.42	0	9.20	0.993
Oil of amber	0	10	7.63	0	9.06	0.978
Proof spirits	0	9	19.73	0	8.62	0.931
Dry oak	0	9	18.00	0	8.56	0.925
Olive oil	0	9	15.17	0	8.45	0.913
Pure spirits	0	9	3.27	0	8.02	0.866
Spirit of Turpentine	0	9	2.76	0	7.99	0.864
Oil of Turpentine	0	8	8.53	0	7.33	0.772
Dry Crabtree	0	8	1.69	0	7.08	0.765
Saffrafas wood	0	5	2.04	0	4.46	0.482
Cork	0	2	12.77	0	2.21	0.240

specific gravities of all sorts of bodies, yet the hydro-  
meter is best suited to find those of fluids in particular,  
both as to ease and expedition.

This instrument should be made of copper, since  
ivory imbibes spirituous liquors, and thereby alters  
its gravity; and glass is apt to break. The most  
simple kind, used for finding the strength of spirits,  
consists of a copper-ball B<sup>b</sup> Plate 101. (fig. 1. n<sup>o</sup> 1.)  
with a brass wire, AB,  $\frac{1}{2}$  of an inch thick, soldered  
into it. The upper part of this wire being filed  
flat on one side, is marked proof at *m*, because it sinks  
exactly to this mark in proof-spirits. There are other  
two marks at A and B, to shew whether the liquor  
be  $\frac{1}{10}$  above or below proof, according as the hydro-  
meter sinks to A or emerges to B, when a brass-weight  
as C or K has been screwed on at the bottom *c*. There  
are also weights to be screwed on, for shewing the spe-  
cific gravities of fluids quite to common water. The  
round part of the wire above the ball, may be marked  
so as to represent river water when it sinks to R W,

(*ibid.* n<sup>o</sup> 2.) the weight which fits the instrument for  
river-water being screwed on at *c*: also when put into  
spring-water, mineral-water, sea-water, and water of  
salt-springs, it will emerge or rise gradually to the  
marks SP, MI, SE, SA; and, on the contrary, when  
put into Bristol-water, rain-water, port-wine, and moun-  
tain-wine, it will successively sink to the marks, *br*, *ra*,  
*po*, *mo*.

Another kind, which serves to distinguish the speci-  
fic differences of fluids to great nicety, consists of a  
large hollow ball B. (*ibid.* n<sup>o</sup> 3) with a smaller ball *b*  
under it, partly filled with quick silver or small shot,  
and screwed on to the lower part of the former, in  
order to render it but little specifically lighter than  
water: it has also a small short neck at C, into which  
is screwed the graduated brass-wire AC, which by its  
weight causes the body of the instrument to descend in  
the fluid, with part of the stem.

When this instrument is swimming in the liquor,  
contained in the jar ILMK, the part of the fluid dis-  
placed



placed by it will be equal in bulk to the part of the instrument under water, and equal in weight to that of the whole instrument. Suppose the weight of the whole were 4000 grains, then it is evident we can by this means compare together the different bulks of 4000 grains of various sorts of fluids. For if the weight *A* be such as shall cause the aræometer to sink in rain-water, till its surface comes to the middle point of the stem 20; and if, after this, it be immersed in common spring water, and the surface is observed to stand  $\frac{1}{4}$  of an inch below the middle point 20; it is evident that the same weight of each water differs in bulk only by the magnitude of  $\frac{1}{4}$  of an inch in the stem.

Now suppose the stem were ten inches long, and weighed 100 grains, then every tenth of an inch would be one grain weight; and since the stem is of brass, and brass is about eight times heavier than water, the same bulk of water will be equal to  $\frac{1}{8}$  of a grain; and consequently to the  $\frac{1}{8}$  of  $\frac{1}{32000}$  part, that is, a 3200th part of the whole bulk, which is a degree of exactness as great as can be desired. Yet the instrument is capable of still greater exactness, by making the stem or neck consist of a flat thin slip of brass, instead of one that is round or cylindrical: by this means we increase the surface, which is the most requisite thing; and diminish the solidity, by which the instrument is rendered more exact.

In order to adapt this instrument to all sorts of uses, there ought to be two different stems to screw on and off in a small hole at *a*. One stem should be such a nice thin slip of brass, or rather of steel, like a watch-spring set straight, as we have just mentioned, on one side of which ought to be the several marks or divisions to which it will sink in various sorts of waters, as rain-water, river-water, spring water, sea-water, salt spring-water, &c. And on the other side you mark the division to which it sinks in various lighter fluids, as hot bath-water, Bristol water, Lincomb water, Cheltenham water, port-wine, mountain, madeira, and various other sorts of wine. But in this case the weight *A* on the top must be a little less than before, when it was used for the heavier waters.

But, in case of trying the strength of spirituous liquors, a common cylindrical stem will do best, because of its strength and steadiness; and this ought to be so contrived, that, when immersed in what is called proof-spirit, the surface of the spirit may be upon the middle point 20; which is easily done by duly adjusting the small weight *A* on the top, and making the stem of such a length, that, when immersed in water, it may just cover the ball, and rise to *a*; but, when immersed in pure spirit, it may arise to the top at *A*; then by dividing the upper and lower parts *a* 20, *A* 20, into ten equal parts each, when the instrument is immersed in any sort of spirituous liquor, it will immediately shew how much it is above or below proof.

This proof-spirit consists of half water and half alcohol or pure spirit; that is, such as when poured upon gunpowder, and set on fire, will burn all away, and permit the powder to take fire, which it will, and

flash as in the open air. But if the spirit be not so highly rectified, there will remain some phlegm or water, which will make the powder wet, and unfit to take fire. This proof-spirit of any kind weighs seven pounds twelve ounces per gallon.

The common method of shaking the spirits in a vial, and, by raising a crown of bubbles, to judge by the manner of their rising or breaking away whether the spirit be proof or near it, is very precarious, and capable of great fallacy. There is no way so easy, quick, certain, and philosophical, as this by the aræometer, which will demonstrate infallibly the difference of bulks, and consequently specific gravities, in equal weights of spirits, to the 30, 40, or 50 thousandth part of the whole, which is a degree of accuracy beyond which nothing can be desired.

All bodies expand with heat, and contract with cold; but some more and some less than others: and therefore the specific gravities of bodies are not precisely the same in summer as in winter. It has been found, that a cubic inch of good brandy is 10 grains heavier in winter than in summer; as much spirit of nitre. 20 grains; vinegar 6 grains, and spring water 3. Hence it is most profitable to buy spirits in winter, and sell them in summer, since they are always bought and sold by measure. It has been found, that 32 gallons of spirits in winter will make 33 in summer.

The expansion of all fluids is proportionable to the degree of heat; that is, with a double or triple heat a fluid will expand two or three times as much.

Upon these principles depends the construction of the thermometer, in which the globe or bulb, and part of the tube, are filled with a fluid, which, when joined to the barometer, is spirits of wine tinged, that it may be the more easily seen in the tube. But when thermometers are made by themselves, quicksilver is generally used.

In the thermometer, a scale is fitted to the tube, to shew the expansion of the quicksilver, and consequently the degree of heat. And, as *Fahrenheit's* scale is most in esteem at present, we shall explain the construction and graduation of thermometers according to that scale.

First, let the globe or bulb, and part of the tube, be filled with a fluid; then immerse the bulb in water just freezing, or snow just thawing; and even with that part in the scale where the fluid then stands in the tube, place the number 32, to denote the freezing point: then put the bulb under your armpit, when your body is of a moderate degree of heat, so that it may acquire the same degree of heat with your skin; and when the fluid has risen as far as it can by that heat, there place the number 97: then divide the space between these numbers into 65 equal parts, and continue those divisions both above 97 and below 32, and number them accordingly.

This may be done in any part of the world; for it is found that the freezing point is always the same in all places, and the heat of the human body differs but very little: so that the thermometers made in this manner will

will agree with one another: and the heat of several bodies will be shewn by them, and expressed by the number upon the scale, thus.

Air, in severe cold weather, in our climate, from 15 to 25. Air in winter, from 26 to 42. Air in spring and autumn, from 43 to 53. Air at midsummer, from 65 to 68. Extreme heat of the summer sun, from 86 to 100. Butter just melting, 95. Alcohol boils with 174 or 175. Brandy with 190. Water 212. Oil of turpentine 550. Tin melts with 408, and lead with 540. Milk freezes about 30, vinegar 28, and blood 27.

A body specifically lighter than a fluid will swim upon its surface, in such a manner, that a quantity of the fluid equal in bulk with the immersed part of the body, will be as heavy as the whole body. Hence, the lighter a fluid is, the deeper a body will sink in it; upon which depends the construction of the hydrometer or water-poise.

From this we can easily find the weight of a ship, or any other body that swims in water. For, if we multiply the number of cubic feet which are under the surface, by 62 5, the number of pounds in one foot of fresh water; or by 63, the number of pounds in a foot of salt water; the product will be the weight of the ship, and all that is in it. For, since it is the weight of the ship that displaces the water, it must continue to sink until it has removed

as much water as is equal to it in weight; and therefore the part immersed must be equal in bulk to such a portion of the water as is equal to the weight of the whole ship.

To prove this by experiment, let a ball of some light wood, such as fir or pear-tree, be put into water contained in a glass vessel; and let the vessel be put into a scale at one end of a balance, and counterpoised by weights in the opposite scale: then, marking the height of the water in the vessel, take out the ball; and fill up the vessel with water to the same height that it stood at when the ball was in it; and the same weight will counterpoise it as before.

From the vessel's being filled up to the same height: at which the water stood when the ball was in it, it is evident that the quantity poured in is equal in magnitude to the immersed part of the ball; and from the same weight counterpoising, it is plain that the water poured in is equal in weight to the whole ball.

In troy weight, 24 grains make a pennyweight, 20 pennyweight make an ounce, and 12 ounces a pound. In avoirdupoise weight, 16 drams make an ounce, and 16 ounces a pound. The troy pound contains 5760 grains, and the avoirdupoise pound 7000: and hence, the avoirdupoise dram weighs 27.34375 grains, and the avoirdupoise ounce 437.5.

H Y P

**HYGROMETER**, a machine, or instrument whereby to measure the degrees of driness, or moisture of the air, or rather of the atmosphere.

There are divers sorts of hygrometers; for whatever body either swells or shrinks, by dryness or moisture, is capable of being formed into an hygrometer. Such are woods of most kinds particularly ash, deal, poplar, &c. Such also is catgut, the beard of a wild oat, &c.

**HYMEN**, in anatomy. See **ANATOMY**, p. 277.

**HYMENÆA**, in botany, a genus of the decandria monogynia class. The calix consists of five segments, and the corolla of five petals; and the pod is filled with a farinaceous pulp. There is but one species, a native of America.

**HYMENÆAL**, something belong to marriage, so called from hymen.

**HYMN**, a religious song. The hymns sung in the christian church, as distinguished from the psalms, are pieces of poetry composed by pious but not inspired authors.

**HYOIDES**, in anatomy. See **ANATOMY**, p. 166.

**HYOSCYAMUS**, **HEN-BANE**, in botany, a genus of the pentandria monogynia class. The corolla is obtuse and funnel shaped; the stamina are inclined; and the capsule is operculated, and consists of two cells. There are six species, only one of which, *viz.* the niger, or common hen-bane, is a native of Britain. The leaves, &c. of this plant are highly narcotic and poisonous, and now disregarded in practice.

**HYOTHYROIDES**, in anatomy. See **ANATOMY**, p. 300.

H Y P

**HYPANTE**, or **HYPERFANTE**, a name given by the Greeks to the feast of the presentation of Jesus in the temple.

This word, which signifies lowly or humble meeting, was given to this feast, from the meeting of old Simon and Anna the prophetess in the temple, when Jesus was brought thither.

**HYPECUM**, *wild cumin*, in botany, a genus of the tetrandria digynia class. The calix consists of two leaves, and the corolla of four petals, the two outermost of which are broader, and divided into three segments. There are four species, none of them natives of Britain.

**HYPERBATON**, in grammar, a figurative construction inverting the natural and proper order of words and sentences.

**HYPERBOLA**. See **CONIC SECTIONS**.

**HYPERBOLE**, in rhetoric, a figure, whereby the truth and reality of things are excessively either enlarged or diminished.

An object uncommon with respect to size, either very great of its kind or very little, strikes us with surprise; and this emotion forces upon the mind a momentary conviction that the object is greater or less than it is in reality: the same effect, precisely, attends figurative grandeur or littleness; and hence the hyperbole, which expresses this momentary conviction. A writer, taking advantage of this natural delusion, enriches his description greatly by the hyperbole: and the reader, even in his coolest moments, relishes this figure, being sensible that it is the operation of nature upon a warm fancy.

It cannot have escaped observation, that a writer is generally more successful in magnifying by a hyperbole than in diminishing. The reason is, that a minute object contracts the mind, and fetters its powers of imagination; but that the mind, dilated and inflamed with a grand object, moulds objects for its gratification with great facility. Longinus, with respect to a diminishing hyperbole, cites the following ludicrous thought from a comic poet: "He was owner of a bit of ground not larger than a Lacedæmonian letter." But, for the reason now given, the hyperbole has by far the greater force in magnifying objects; of which take the following examples:

For all the land which thou see'st, to thee will I give it, and to thy seed for ever. And I will make thy seed as the dust of the earth: so that if a man can number the dust of the earth, then shall thy seed also be numbered. *Genesis* xiii. 15. 16.

*Illa vel intactæ segetis per summa volaret  
Gramina: nec teneras cursu læsisset aristas.*  
*Æneid.* vii. 808.

—————*Atque imo barathri ter gurgite vastos  
Sorbet in abruptum fluctus, rursusque sub auras  
Erigit alternos, et sidera verberat unda.*  
*Æneid.* iii. 421.

—————*Horrificis juxta tonat Ætna ruinis,  
Interdumque atram prorumpit ad æthera nubem,  
Turbine fumantem piceo et candente favilla:  
Attollitque globos flammaram, et sidera lambit.*  
*Æneid.* iii. 571.

#### Speaking of Polyphemus,

—————*Ipsè arduus, altaque pulsat  
Sidera.* *Æneid.* iii. 619.

—————*When he speaks,  
The air, a charter'd libertine, is still.*  
*Henry V.* act 1. sc. 1.

Now shield with shield, with helmet helmet clos'd,  
To armour armour, lance to lance oppos'd,  
Host against host with shadowy squadrons drew,  
The founding darts in iron tempests flew,  
Victors and vanquish'd join promiscuous cries,  
And shrilling shouts and dying groans arise;  
With streaming blood the slipp'ry fields are dy'd,  
And slaughter'd heroes swell the dreadful tide.  
*Iliad* iv. 508.

Quintilian is sensible that this figure is natural: "For," says he, "not contented with truth, we naturally incline to augment or diminish beyond it; and for that reason the hyperbole is familiar even among the vulgar and illiterate:" and he adds, very justly, "That the hyperbole is then proper, when the subject of itself exceeds the common measure." From these premises, one would not expect the following inference, the only reason he can find for justifying this figure of speech, "Conceditur enim amplius dicere, quia dici quantum est, non potest: meliusque ultra quam citra stat oratio." (We are indulged to say more than enough,

because we cannot say enough; and it is better to be above than under.) In the name of wonder, why this slight and childish reasoning, when immediately before he had observed, that the hyperbole is founded on human nature? we could not resist this personal stroke of criticism; intended not against our author, for no human creature is exempt from error, but against the blind veneration that is paid to the ancient classic writers, without distinguishing their blemishes from their beauties.

Having examined the nature of this figure, and the principle on which it is erected; let us proceed to the rules by which it ought to be governed. And, in the first place, it is a capital fault, to introduce an hyperbole in the description of an ordinary object or event; for in such a case, it is altogether unnatural, being destitute of surprise, its only foundation. Take the following instance, where the subject is extremely familiar, viz. swimming to gain the shore after a shipwreck,

I saw him beat the surges under him,  
And ride upon their backs; he trod the water;  
Whose enmity he flung aside, and breast'd  
The surge most swollen that met him: his bold head  
'Bove the contentious waves he kept, and oar'd  
Himself with his good arms, in lusty strokes  
To th' shore, that o'er his wave-borne basis bow'd,  
As stooping to relieve him. *Tempest,* act 2. sc. 1.

In the next place, it may be gathered from what is said, that an hyperbole can never suit the tone of any dispiriting passion: sorrow in particular will never prompt such a figure; and for that reason the following hyperboles must be condemned as unnatural:

*K. Rich.* Aumerle, thou weep'st, my tender-hearted cousin!

We'll make foul weather with despis'd tears;  
Our sighs, and they, shall lodge the summer-corn,  
And make a dearth in this revolting land.  
*Richard II.* act 3. sc. 6.

Draw them to Tyber's bank, and weep your tears  
Into the channel, till the lowest stream  
Do kiss the most exalted shores of all.  
*Julius Caesar,* act 1. sc. 1.

Thirdly, a writer, if he wish to succeed, ought always to have the reader in his eye: he ought in particular never to venture a bold thought or expression, till the reader be warmed and prepared. For this reason, an hyperbole in the beginning of a work can never be in its place. Example:

*Jam pauca aratro jugera regie  
Moles relinquat.* *Horat. Carm. lib. 2. ode 15.*

In the fourth place, the nicest point of all, is to ascertain the natural limits of an hyperbole, beyond which being overstrained it has a bad effect. Longinus, (chap. iii.) with great propriety of thought, enters a caveat against an hyperbole of this kind: he compares it to a bowstring, which relaxes by overstraining, and produceth an effect directly opposite to what is intended. To ascertain any precise boundary, would be difficult,

if

not impracticable. We shall therefore only give a specimen of what may be reckoned overstrained hyperboles. No fault is more common among writers of inferior rank; and instances are found even among those of the finest taste; witness the following hyperbole, too bold even for an Hotspur.

Hotspur, talking of Mortimer :

In single opposition hand to hand,  
He did confound the best part of an hour  
In changing hardiment with great Glendower.  
Three times they breath'd, and three times did they  
drink,

Upon agreement, of swift Severn's flood;  
Who then affrighted with their bloody looks,  
Ran fearfully among the trembling reeds,  
And hid his crisp'd head in the hollow bank,  
Blood-stained with these valiant combatants.

*First Part Henry IV. act 1. sc. 4.*

Speaking of Henry V.

England ne'er had a King until his time :  
Virtue he had, deserving to command :  
His brandish'd sword did blind men with its beams :  
His arms spread wider than a dragon's wings :  
His sparkling eyes, replete with awful fire,  
More dazzled, and drove back his enemies,  
Than mid-day sun fierce bent against their faces.  
What should I say? his deeds exceed all speech :  
He never lifted up his hand, but conquer'd.

*First Part Henry VI. act 1. sc. 1.*

Lastly, An hyperbole, after it is introduced with all advantages, ought to be comprehended within the fewest words possible: as it cannot be relished but in the hurry and swelling of the mind, a leisurely view dissolves the charm, and discovers the description to be extravagant at least, and perhaps also ridiculous. This fault is palpable in a sonnet which passeth for one of the most complete in the French language: Phillis, in a long and florid description, is made as far to outshine the sun as he outshines the stars :

Le silence regnoit sur la terre et sur l'onde,  
L'air devenoit serain et l'Olimp vermeil,  
Et l'amoureux Zephir affranchi du someil.  
Ressuscitoit les fleurs d'une haleine seconde.

L'Aurore deployoit l'or de sa tresse blonde,  
Et semoit de rubis le chemin du soleil ;  
Enfin ce Dieu venoit au plus grand appareil  
Qu'il soit jamais venu pour éclairer le monde :

Quand la jeune Philis au visage riant,  
Sortant de son palais plus clair que l'orient,  
Fit voir une lumiere et plus vive et plus belle.

Sacre flambeau du jour, n'en soiez point jaloux,  
Vous parutes alors aussi peu devant elle,  
Que les feux de la nuit avoient fait devant vous.

*Malleville.*

There is in Chaucer a thought expressed in a single line,

which sets a young beauty in a more advantageous light than the whole of this much laboured poem :

Up rose the sun, and up rose Emelie.

HYPERCATALECTIC, in the Greek and Latin poetry, is applied to a verse, which has one or two syllables too much, or beyond the regular and just measure: as,

*Musa sorores sunt Minerva.*

Also,

*Musa sorores Palladis lugent.*

HYPERICUM, *St John's wort*, a genus of the polyadelphia polyandria class. The calix consists of five segments, and the corolla of five petals: and the filaments are numerous, and bound in five bundles. There are twenty-nine species, eight of them natives of Britain.

HYPERSARCOSIS, in medicine and surgery, an excess of flesh, or rather a fleshy excrescence, such as those generally arising upon the lips of wounds, &c.

HYPHEN, an accent or character, in grammar, implying that two words are to be joined, or connected into one compound word, and marked thus -; as, pre established, five-leaved, &c.

Hypens also serve to connect the syllables of such words as are divided by the end of the line.

HYPNOTIC, in the materia medica, such medicines as any way produce sleep, whether called narcotics, hypnotics, opiates, or soporifics.

HYPNUM, in botany, a genus of the cryptogamia musci class. There are forty-two species, all natives of Britain.

HYPOCAUSTUM, among the Greeks and Romans, a subterraneous place, wherein was a furnace to heat the baths.

Another sort of hypocaustum was a kind of kiln, to heat their winter-parlours.

Among the moderns, it is that place where the fire is kept that warms a stove or hot-house.

HYPOCHAERIS, in botany a genus of the syngenesia polygamia æqualis class. The receptacle is paleaceous; the calix is imbricated; and the pappus is plumose. There are four species, two of them natives of Britain, viz. the radicata, or long-rooted hawkweed; and the maculata, or spotted hawkweed.

HYPOCHONDRIA, in anatomy. See ANATOMY, p. 256.

HYPOCHONDRIAC PASSION. See MEDICINE.

HYPOCYSTIS, in pharmacy, an inspissated juice, obtained from the sessile asarum, much resembling the true Egyptian acacia.

They gather the fruit, while unripe; and express the juice, which they evaporate over a very gentle fire, to the consistence of an extract, and then form into cakes, and expose them to the sun to dry.

Hypocystis is an astringent, and that of considerable power; it is good against diarrhoeas and hæmorrhages of all kinds, and may be used in repellent gargarisms in the manner of the acacia; but it is very rarely met with genuine in our shops, the german acacia being usually sold under its name.

**HYPOGASTRIC**, an appellation given to the internal branch of the iliac artery.

**HYPOGASTRICUM**, in anatomy. See **ANATOMY**. p. 256.

**HYPOPHYLLLOCARPODENDRON**, in botany. See **LEUCODENDRON**.

**HYPOPYON**, in medicine, a collection of purulent matter under the cornea of the eye.

**HYPOSTASIS**, among divines, signifies a person or substance; chiefly used in speaking of the persons of the Trinity.

**HYPOTHEC**, in Scotslaw, a right of security established by law to creditors upon the goods and effects of their debtors, for payment of certain debts. See **LAW**, tit. 20. § 13.

**HYPOTHENAR**, in anatomy. See **ANATOMY**, p. 200.

**HYPOTHENUSE**, in geometry, the longest side of a right-angled triangle, or it is that side which subtends the right angle.

**HYPOTHESIS**, in general, denotes something supposed to be true, or taken for granted, in order to prove or illustrate a point in question.

Hypotheses, however elegant and artful, ought to be first proved by repeated observations and constant experience, before they are received as truths.

**HYSSOPUS**, in botany, a genus of the didynamia gynospemia class. The inferior lip of the corolla has a small crenated segment; and the stamina are erect and distant. There are three species, none of them natives of Britain. The leaves are said to be good in asthma, coughs, and other disorders of the lungs.

**HYSTERIC**, or **HYSTERIC PASSION**. See **MEDICINE**.

**HYSTERON PROTERON**, in grammar and rhetoric, a species of the hyperbaton, wherein the proper order of construction is so inverted, as that the part of any sentence which should naturally come first is placed last; as in this of Terence, *valet & vivit, for vivit & valet*; and in the following of Virgil, *moriamur & in media arma ruamus, for in media arma ruamus & moriamur*.

**HYSTEROPHORUS**. See **PARTHENIUM**.

**HYSTRIX**, in zoology, a genus of quadrupeds belonging to the order of glires, the characters of which are these: They have two fore-teeth, obliquely divided, both in the upper and under jaw, besides eight graders; and the body is covered with quills or prickles. (See Plate CI. fig. 5.) There are four species. *viz.*

1. The *crifata*, or crested porcupine, has four toes on the fore-feet, five toes on the hind-feet, a crested head, a short tail, and the upper lip is divided like that of a hare. The length of the body is about two feet, and the height about two feet and a half. The porcupine is covered with prickles, some of them nine or ten inches long, and about  $\frac{1}{2}$  of an inch thick. Like the hedge-hog, he rolls himself up in a globular form, in which position he is proof against the attacks of the most rapacious animals. The prickles are exceedingly sharp, and each of them has five large black and as many white rings, which succeed one another alter-

nately from the root to the point. These quills the animal can erect or let down at pleasure; when irritated, he beats the ground with his hind-feet, erects his quills, shakes his tail, and makes a considerable rattling noise with his quills.

Most authors have asserted that the porcupine, when irritated, darts his quills to a considerable distance against the enemy, and that he will kill very large animals by this means. But Mr Buffon, and some other late historians, assure that the animal possesses no such power. Mr Buffon frequently irritated the porcupine, but never saw any thing like this darting of his quills. He says indeed, that when the creature was much agitated with passion, some of the quills which adhered but slightly to the skin, would fall off, particularly from the tail; and this circumstance, he imagines, has given rise to the mistake.

The porcupine, though originally a native of Africa and the Indies, can live and multiply in the more temperate climates of Spain and Italy. Pliney, and every other natural historian since the days of Aristotle, tells us that the porcupine, like the bear, conceals itself during the winter, and that they bring forth their young in 80 days. But these circumstances remain to this day uncertain. It is remarkable, that although this animal be very common in Italy, no person has ever given us a tolerable history of it. We only know in general, that the porcupine, in a domestic state, is not a fierce or ill-natured animal; that with his foreteeth, which are strong and sharp, he can cut through a strong board; that he eats bread, fruits, roots, &c. that he does considerable damage when he gets into a garden; that he grows fat, like most animals, about the end of summer; and that his flesh is not bad food.

2. The *prehenilis*, or cuandu, has four toes on the fore-feet, five on the hind-feet, and a long tail. It is considerably less than the former species, being only 17 inches long from the point of the muzzle to the origin of the tail, which is nine inches long; the legs and feet are covered with long brownish hair; the rest of the body is covered with quills interperfed with long hairs; the quills are about five inches long and about  $\frac{1}{2}$  of an inch in diameter. He feeds upon birds and small animal. He sleeps in the day like the hedgehog, and searches for his food in the night. He climbs trees, and supports himself by twisting his tail round the branches. He is generally found in the high grounds of America from Brazil to Louisiana and the southern parts of Canada. His flesh is esteemed very good eating.

3. The *dorsata*, has four toes on the fore-feet, five on the hind-feet, and has quills only on the back, which are short, and almost hid among the long hair. He is about two feet long. He is a native of Hudson's bay. The savages eat his flesh, and make use of his skin as a fur after taking off the prickles.

4. The *macroura*, has five toes both on the hind and fore feet; his tail is very long, and the prickles are elevated. He is a native of Asia the East Indies.

JACCA,

## I.

J A G

J A M

**JACCA**, a city and bishop's see of Arragon, in Spain, sixty miles north of Saragossa: W. lon. 50', and N. lat. 42° 50'.

**JACEA**. See **CENTAURIA**.

**JACK**, in mechanics, a well-known instrument of common use for raising very great weights of any kind.

The common kitchen-jack is a compound engine where the weight is the power applied to overcome the friction of the parts, and the weight with which the spit is charged; and a steady and uniform motion is obtained by means of the fly

**JACK-FLAG**, in a ship, that hoisted up at the sprit sail top-mast head. See **FLAG**.

**JACK-DAW**, in ornithology. See **CORVUS**.

**JACKALL**, in zoology. See **CANIS**.

**JACOBÆA**, in botany. See **SENECIO**.

**JACOBITES**, a term of reproach bestowed on the persons, who, vindicating the doctrines of passive obedience and non-resistance with respect to the arbitrary proceedings of princes, disallow of the late revolution, and assert the supposed rights and adhere to the interests of the late abdicated king James and his family.

**JACOBITES**, in church-history, a sect of Christians in Syria and Mesopotamia; so called either from Jacob, a Syrian, who lived in the reign of the emperor Mauricius; or from one Jacob, a monk, who flourished in the year 550.

The Jacobites are of two sects, some following the rites of the Latin church, and others continuing separated from the church of Rome. There is also at present a division among the latter, who have two rival patriarchs, one of whom resides at Caramit, and the other at Derzapharan. As to their belief, they hold but one nature in Jesus Christ; with respect to purgatory and prayers for the dead, they are of the same opinion as the Greeks and other eastern Christians: they consecrate unleavened bread at the eucharist, and are against confession, believing that it is not of divine institution.

**JACOBUS**, an ancient gold coin worth twenty-five shillings.

**JAFFA**, anciently called **JOPPA**, is a port-town of Palestine in Asiatic Turkey, situated thirty miles north-west of Jerusalem: E. lon. 36°, N. lat. 32° 20'.

**JAFNAPATAN**, a port-town at the north end of the island of Ceylon, in the East Indies; subject to the Dutch: E. lon. 79°, N. lat. 10°.

**JAGENDORF**, a city of Silesia, twelve miles north-west of Tropaw: E. lon. 17° 6' N. lat. 50° 8'.

*St.* **JAGO**, the chief of the Cape Verd islands, in Africa, 300 miles west of Cape Verd; subject to Portugal: W. lon. 24°, N. lat. 15°.

*St.* **JAGO**, the capital of the island of Cuba, 100 miles north-west of Jamaica: W. lon. 76°, 30', N. lat. 20°.

VOL. II. Numb. 61.

2

*St.* **JAGO**, the capital of the province of Chili, in South America, situated six miles west of the mountains of Andes, and eighteen east of the Pacific ocean: W. lon. 77°, S. lat. 34°.

**JAGO DE LA VEGA**, or Spanish town, the capital of Jamaica, situated at the south-east part of the island, about seven miles north-west of Port Passage and the bay of Port Royal: E. lon. 76° 50', N. lat. 18° 20'.

**JALAP**, in botany. See **MIRABILIS**.

**JAMAICA**, an island of America, situated in the Atlantic ocean, between 76° and 79° of west longitude, and between 17° and 18° odd minutes north latitude, near 5000 miles south-west of England, 100 miles south of the island of Cuba, and 350 miles north of Terra Firma. The island lies east and west, and is about 140 miles long, and 60 broad. The wind sets on the shore almost all the day in every part of the island, and off the shore in the night; it sometimes hails, but the people there never see frost or snow. The produce of the island is chiefly sugar; but there are plantations of coffee, of the cocoa or chocolate tree, of indigo, tobacco, pepper, cotton, woods for dyeing, and the mahogany and machineel wood, ginger, medicinal drugs and gums. The common diseases of the country are fevers, fluxes, and the dry gripes.

**JAMANA**, the chief town of a province of Arabia, also of the same name: E. lon. 47° 15', N. lat. 25°.

**JAMBA**, a city of the hither India, and the capital of the province of the same name, situated 220 miles north-east of Delli: E. lon. 82°, N. lat. 31°.

**JAMBOLIFERA**, in botany, a genus of the octandria monogynia class. The calix has four teeth, and the corolla four funnel-shaped petals; and the stigma is simple. There is but one species, a native of India,

**IAMBUS**, in ancient poetry, a simple foot consisting of a short and a long syllable, as *pis*.

**JAMBY**, a town on the east side of the island of Sumatra, in the East Indies, situated in 101° E. lon. and in 1° 30' S. lat.

**JAMES**, or *knights of St James*, a military order in Spain, first instituted about the year 1170, by Ferdinand II. king of Leon and Galicia. The greatest dignity belonging to this order is grand master, which has been united to the crown of Spain. The knights are obliged to make proof of their descent from families that have been noble for four generations, on both sides; they must also make it appear that their said ancestors have neither been Jews, Saracens, nor Heretics; nor have ever been called into question by the inquisition. The novices are obliged to serve six months in the galleys, and to live a month in a monastery; they observe the rules of St Austin, making no vows but of poverty, obedience, and conjugal fidelity.

*St.* **JAMES'S DAY**, a festival of the Christian church, observed

† 8 Y

served

served on the 25th of July, in honour of St James the greater, son of Zebedee.

*Epistle of St James*, a canonical book of the New Testament, being the first of the catholic or general epistles; which are so called, as not being written to one, but to several Christian churches.

**JAMES TOWN**, once the capital of Virginia in America, and of James-country, situated in a peninsula on the north side of James, or Pauhatan river, in W. lon.  $76^{\circ} 30'$ , N. lat.  $37^{\circ} 30'$ .

**JANEIRO**, a province of Brazil, in south America, situated between  $44^{\circ}$  and  $49^{\circ}$  of W. lon. and between the tropic of capricorn and  $22^{\circ}$  of S. lat.

**JANICAW**, or **JANOWITZ**, a town of Bohemia, situated forty-five miles south-east of Prague.

**JANIZARIES**, an order of the Turkish infantry, reputed the grand signior's guards, and the main strength of the Ottoman army.

**JANSENISTS**, in church-history, a sect of the Roman-catholics in France, who followed the opinions of Jansenius, bishop of Ypres, and doctor of divinity of the universities of Louvain and Douay, in relation to grace and predestination.

In the year 1640, the two universities just mentioned, and particularly father Molina and father Leonard Celsus, thought fit to condemn the opinions of the Jesuits on grace and free-will. This having set the controversy on foot, Jansenius opposed to the doctrine of the Jesuits the sentiments of St Augustine, and wrote a treatise on grace, which he entitled *Augustinus*. This treatise was attacked by the Jesuits, who accused Jansenius of maintaining dangerous and heretical opinions; and afterwards in 1642, obtained of pope Urban VIII. a formal condemnation of the treatise wrote by Jansenius: when the partisans of Jansenius gave out that this bull was spurious, and composed by a person entirely devoted to the Jesuits. After the death of Urban VIII. the affair of Jansenism began to be more warmly controverted, and gave birth to an infinite number of polemical writings concerning grace; and what occasioned some mirth, was the titles which each party gave to their writings: one writer published, *The torch of St Augustin*, another found snuffers for St Augustin's torch, and father Veron formed a gag for the Jansenists, &c. In the year 1650, sixty eight bishops of France subscribed a letter to pope innocent X to obtain an enquiry into, and condemnation of the five following propositions, extracted from Jansenius's *Augustinus*: I. Some of God's commandments are impossible to be observed by the righteous, even though they endeavour with all their power to accomplish them. II. In the state of corrupted nature, we are incapable of resisting inward grace. III. Merit and demerit in a state of corrupted nature, does not depend on a liberty which excludes necessity. but on a liberty which excludes constraint. IV. The semipelagians admitted the necessity of an inward preventing grace for the performance of each particular act, even for the beginning of faith: but they were heretics in maintaining that this grace was of such a nature, that the will of man was able either to resist

or obey it. It is semipelagianism to say, that Jesus Christ died, or shed his blood, for all mankind in general.

In the year 1652, the pope appointed a congregation for examining into the dispute in relation to grace. In this congregation Jansenius was condemned, and the bull of condemnation, published in May 1653, filled all the pulpits in Paris with violent outcries and alarms against the heresy of the Jansenists. In the year 1656, pope Alexander VII. issued out another bull, in which he condemned the five propositions of Jansenius. However, the Jansenists affirm, that these propositions are not to be found in this book; but that some of his enemies having caused them to be printed on a sheet, inserted them in the book, and thereby deceived the pope. At last Clement the XI. put an end to the dispute by his constitution of July the 17. 1705; in which, after having recited the constitutions of his predecessors in relation to this affair, he declares, "That in order to pay a proper obedience to the papal constitutions concerning the present question, it is necessary to receive them with a respectful silence." The clergy of Paris, the same year, approved and accepted this bull, and none dared to oppose it.

This is the famous bull *Unigenitus*, so called from its beginning with the words *Unigenitus Dei Filius*, &c. which has occasioned so much confusion in France.

**JANUARY**, in chronology, the first month of the year, so called from Janus, one of the ancient Roman deities painted with two faces; one whereof was supposed to look towards the new year, and the other towards the old.

**JAPAN**, or *islands of JAPAN*, are situated between  $130^{\circ}$  and  $144^{\circ}$  of E. lon. and between  $30^{\circ}$  and  $40^{\circ}$  N. lat.

**JAPANING**, the art of varnishing and drawing figures on wood, &c. in the manner as is done by the natives of Japan.

The method of preparing woods for japaning is as follows. 1. Take plasterer's size, dissolve it over the fire, and mix it with whiting finely powdered till it is of a good body, but not too thick. 2. By means of a strong brush, lay your work over with the former mixture; and letting it dry very well, repeat this till the wood is perfectly plain, or the pores and crevices sufficiently filled up; and when it is thoroughly dry, rub the work over with a wet rag till it is rendered as smooth as possible: this work is called water-plaining. 3. After this, wash over the work with the thickest of seed-lac varnish till it is very smooth, letting it stand to dry between every washing. 4. In a day or two's time, you may varnish it over with black, or whatever other colour you design; and when it is dry, finish it by polishing. See the article **VARNISH**.

After the same manner carved figures are to be primed; also frames, cabinets, stands, tea-tables, &c. saying that these are not to be polished, and therefore do not require so great a body of varnish: but for the tops of tables, boxes, sides of cabinets, &c. when the wood is ordinary and rough grained, as deal oak, &c. you may use common joiners glue dissolved in water

water till it is fine and thin, into which put the finest saw dust, till it is indifferently thick: then with a brush lay your wooden-work over with it, and when it is dry, repeat it so often till all the roughness and grain of the wood is sufficiently hidden; and two or three days after let it be scraped with a scraper, as pear-tree and olive-wood are done to make it as smooth as possible: then varnish it as before directed. This, if well done, might not come behind any other work either for beauty or durability; but, however, those woods that are firm and close grained are chiefly to be chosen.

Method of taking off japan patterns. 1. Having laid your ground, whether black, or of any other colour, and rendered it fit for drawing; and having your draught or design before you on paper, either drawn or printed, do as follows. 2. Rub this draught or print all over the back side with whiting or fine chalk, wiping off all that whiting which lies loose upon the paper; then laying this paper upon the table, or piece of varnished-work, with the whited side next it upon the very place where you would have that figure made, with a needle not sharp-pointed, fixed in a wooden handle, and called a tracing-pencil, go over and trace as much of the drawing as you think proper: thus by means of the whiting, you will have the gross form of the draught, and such other lines as will be a direction to you how to perform what you would have done. 3. Having done this, if you draw in gold-size, use fine chnabar mixed with gum-water; and with a small pencil dipt into it, go over all the lines made by the chalk: this will hold it so as not to come off. 4. If you work your metals or colours in gum-water, then trace over your design with gum-water mixt with gold or brass dust; by either of these ways when it is dry and finished, viz. either in gum-water or gold size, you may compleat and finish your work.

Method of japanning wood. The wood being prepared as before directed, it is japanned with black, as follows. 1. Take of the thickest lac-varnish, six ounces; and lamp black, enough to colour it: with this wash over your piece three times, letting it dry thoroughly between each time: again, with the same varnish, wash it over three other several times, letting it dry as before, and rush it smooth between each washing. 2. Then take the following: Of thickest seed-lac varnish, six ounces; and venice turpentine, one ounce: wash over your work with it six times, letting it stand twelve hours between the three first and the three last varnishes. 3. Your work being thus far done, take the following japan-varnish: Of the finest seed lac varnish, six ounces; of lamp black, a sufficient quantity; mix them, and with that let your work be washed twelve times, standing twelve hours betwixt the first six and the last six washings. 4. Then letting it stand to dry for six or seven days: polish it with tripoli and a rag, as before directed: but in polishing you must work at it only till it is almost smooth; and then let it stand by for two days: afterwards polish it again, almost enough; then let it stand for six days, after which finish the polishing of it; finally, clear it up with oil and lamp-black, by which means you will have a good black japan. Scarce at all inferior to the true japan.

For a white japan. 1. Lay the ground with ising-

glass size mixed with as much whiting scraped into it as will make it of a proper thickness; with this whiten your work once over, and being thoroughly dry, do it over again; and in like manner repeat it the third time; after which let it stand for twelve hours, covering it from dust; rush it with Dutch rushing as near the grain of the wood as is proper. 2. Then taking first ising-glass size, and flake white, so much as will make the size of a fair body, mix them well together, and with this go over your work three several times, letting it dry between each time, and rush it as before. 3. Then take white starch boiled in fair water, till it is somewhat thick, wash over the whole work twice with it, blood-warm; letting it dry as before. 4. Letting it stand for a day or two, it being first washed with rectified spirit of wine, to clear it from the dust, dip a pure clean pencil into the finest white varnish, and do over the work six or seven times; and if this be well done, it will give a finer gloss than if it were polished: if it be not well done, polishing will be necessary, for which reason you must give it five or six varnishes more. In polishing you must make use of the finest tripoli; and instead of lamp-black and oil, must use putty and oil, and conclude with white starch mixed with oil.

Common red japan. 1. Take ising-glass size, fine vermilion, a sufficient quantity, as much as is proper; with the former mixture do your work over four times; first warming it by the fire, letting it dry each time, and rushing it as before. 2. This being done, wash it over eight times with ordinary seed lac varnish, and let it by for twelve hours: then rush it again, but slightly, to make it look smooth. 3. And, lastly, for an exquisite outward covering, wash it ten times with the best lac-seed varnish; let it lie seven days to dry, and then polish it with tripoli, and clear it up with oil and lamp black.

A deeper red japan may be made by mixing fine sanguis draconis, in powder, with the varnish, and a pale red japan may be had by mixing too much white lead with it, as to make it of whatever degree of paleness you please.

Blue japan. 1. Take gum-water what quantity you please, and a sufficient quantity of white lead; grind them well upon a marble; take ising glass size what quantity you please, and the finest and best smalt a sufficient quantity; mix them well together; then add to them of the white lead, ground as before, so much as will give it a sufficient body; mix all together to the consistence of a paint. 2. Do your work over with this mixture three or four times, till you perceive the blue to lie with a good and fair body, letting it dry thoroughly between each time: if your blue is too pale, put more smalt among your size, without any white lead, and so vice versa. 3. Then rush it smooth, and go over it again with a stronger blue; and when it is dry, wash it three times with the clearest ising glass size alone, and let it stand for two days to dry, covering it. 4. Warm your work gently at the fire, and with a pencil varnish it over with the finest white varnish, repeating it seven or eight times, letting it stand to dry two days as before. After which repeat again the washes seven or eight times in like manner. 5. Let it now stand for a week, and then polish it as before, and clear it up with lamp black and oil.

Chestnut-



**Chefaut-coloured japan.** Take indian red, grind it with ising-glass size upon a porphyry-stone, till they are as soft and as fine as butter; then mix a little white lead, which grind strongly; and, lastly, lamp-black, in due proportion.

**A tortoise-shell japan.** First lay a white ground, as before directed; then with proper colours, as vermilion, auripigment, &c. duly mixed with turpentine-varnish, streak and cloud or shadow the white ground with any irregular fancy at pleasure, in imitation of tortoise-shell: then let it stand to dry, and striking it here and there with reddish-yellow varnish, mixed with a little cinnabar, cloud the work up and down, touching it up also with varnish mixed with lamp or ivory black. Having done this, varnish it five or six times over with the finest white varnish, letting it dry between every washing.

**Japanning with gold size.** The size being laid over that part only which you intend to gild, as already directed, let it remain there till it is so dry, that when you put your finger on it, it be glutinous and clammy, but not so moist that the particles should come off with your fingers. It is in this temper that the gold is to be applied: then take a piece of washing leather, or the like, and wrapping it round your fore finger, dip it in the gold dust, and rub it where your gold size is laid; for it will stick no where but on the size; and if any gold-dust lies about your work, brush it away with a fine clean varnishing brush. Then, with your pencil, draw that part with gold size also which is designed for your copper, and letting it dry as in the former case, cover it over with copper dust in the same manner. Having done this, lay your silver-size; and when it is dry, as before, lay on your silver-dust, as in the two former. But it is to be observed, that the metalline colours are to be laid successively one after another, letting each be covered and thoroughly dry before you enter upon a distinct colour. After all these, the other colours which are not metalline are to be laid on with gum-water, reserving the rock, &c. for the last part of the work. Let your size be of a due consistence, neither too thick nor too thin, that it may run smooth and clean. See SIZES.

**Japanning metals with gum-water.** Take gum water, put it into a mussel-shell; with which mix so much of your metal or colour as may give it a proper consistence, so that it may run fine and smooth: having prepared and well mixed your metals and colours, lay on your design; your gum-water being thoroughly dried, you are to run it over with fine seed-lac varnish, and afterwards polish and clear it.

**Laying speckles or strewings on japan-work.** To do this, either on outside or inside boxes, drawers, &c. mix your speckles with ordinary lac-varnish, so much as may make it fit to work, but not so thick as for colour, and mix them well with a proper brush. Warm the work to be done gently by the fire, and with a pencil wash it over with the former mixture; and when it is dry, repeat it again, and so often till your speckles lie as thick and even as you desire. When it is thoroughly dry, go over and beautify the work three or four times with seed-lac varnish mixt with turpentine, and so let it dry, and the work is finished, except you have a mind to polish it.

But if you polish it, you must wash it eight or ten times over with the best seed-lac varnish, letting it stand to dry every time; and afterwards polish it, as before directed. All sorts of coloured speckles may be thus used, except those of silver; the laying on of which requires the best and finest of the lac-varnish, or the best white varnish, which must make it fit for polishing; but if you have not a mind to polish it, fewer washes of the varnish will be sufficient.

Japanned and laquered ware of the East Indies, pay duty for every 100 l. gross value at the sale 38 l. on importation, and the drawback is 35 l. 12s. 6d. on exportation.

**JASMINUM**, in botany, a genus of the diandria monogynia class. The corolla consists of five segments, the berry is tricoccus; and the seed is arillated. There are six species, none of them natives of Britain.

**JASPER**, in natural history, a genus of scrupi, of a complex irregular structure, of great variety of colours, and emulating the appearance of the finer marbles, or semipellucid gems.

The great characteristic of jaspers is, that they all readily strike fire with steel, and make not the least effervescence with aquafortis.

Jaspers, though commonly reckoned among the precious stones, ought undoubtedly to be ranged among the scrupi; being only opaque crystalline masses, variously debased with an earthy admixture: and to this last ingredient it is that they owe all their variety of colours, as white, green, red, brown, and bluish.

The several kinds of nephritic stone, and the lapis divinus or jade, are all genuine jaspers; but the hard, bright, green jasper of the East Indies, seems to be the true kind. It is found in masses of various sizes and shapes; but the more usual standard as to size, is between four and six inches in diameter; but there are masses of it found of a foot or more in diameter, and others no larger than a horse bean. It is generally simple and unmixed; but if it be variegated at all, it is always with white; and this is disposed not in streaks or veins, but in clouds. It is capable of a very fine polish; and when the white clouds are well disposed, is very beautiful; and, in pieces not too thick, is tolerably pellucid, when held up against the light.

**JASPONYX**, in natural history, the purest horn-coloured onyx, with beautiful green zones, which are composed of the genuine matter of the finest jaspers. See JASPER and ONYX.

**JASQUES**, a port-town of Persia, situated on the gulph of Ormus: E. long. 58°, N. lat. 25°.

**JATROPHA**, the CASSADA PLANT, in botany, a genus of the monœcia monadelphia class. The male has no calix; the corolla consists of one funnel-shaped petal; and the stamina are ten. The female has no calix; the corolla consists of five petals; the styli are three, and bifid; the capsule has three cells, and contains but one seed. There are seven species, none of them natives of Britain.

**JAVA**, an island of the East Indies, situated between 102° and 113° of E. longitude, and between 5° and 8°

8° of south latitude; being about 700 miles long from east to west, and one hundred broad.

**JAVELIN**, in antiquity, a sort of spear, five feet and an half long; the shaft of which was of wood, with a steel point.

Every soldier, in the Roman armies, had seven of these; which were very light and slender.

**JAUNDICE**, in medicine. See **MEDICINE**.

**JAW**, in anatomy. See **ANATOMY**, p. 159.

**JAWER**, a city of Silesia, capital of the duchy of Jawer, situated in 16° 12' E. long, and 51° 8' N. lat.

**JAZY**, a city of European Turkey, capital of Moldavia, situated on the river Pruth, in E. long. 28° 40', N. lat. 47° 15.

**IBERIS**, in botany, a genus of the tetradynamia sili-culosa class. The corolla is irregular, the two out-most petals being largest; and the pod is emarginated, and contains many seeds. There are twelve species, only one of which, viz. the medicaulis or rock-creffe, is a native of Britain.

**IBEX**, in zoology. See **CAPRA**.

**IBIS**, in ornithology. See **TANTALUS**.

**ICE**, in physiology, a solid, transparent, and brittle body, formed of some fluid, particularly water, by means of cold. See **FROST** and **FREEZING**.

The younger Lemery observes, that ice is only a re-establishment of the parts of water in their natural state; that the mere absence of fire is sufficient to account for this re-establishment; and that the fluidity of water is a real fusion, like that of metals exposed to the fire; differing only in this, that a greater quantity of fire is necessary to the one than the other. Gallileo was the first that observed ice to be lighter than the water which composed it: and hence it happens, that ice floats upon water, its specific gravity being to that of water as eight to nine. This rarefaction of ice is owing to the air-bubbles produced in the water by freezing; and being considerably large in proportion to the water frozen, render the body so much specifically lighter: and these air-bubbles growing large, acquire a great expansive power, so as to burst the containing vessels, though ever so strong.

**ICE-HOUSE**, a building contrived to preserve ice for the use of a family in the summer-season.

Ice-houses are more generally used in warm countries than with us; particularly in Italy, where the meanest person who rents a house, has his vault or cellar for ice.

As to the situation, it ought to be placed upon a dry spot of ground; because where-ever there is moisture, the ice will melt: therefore in all strong lands which retain the wet, too much pains cannot be taken to make drains all round them. The place should also be elevated, and as much exposed to the sun and air as possible.

As to the figure of the building, that may be according to the fancy of the owner; but a circular form is most proper for the well in which the ice is to be preserved, which should be of a size and depth proportionable to the quantity to be kept; for it is proper to have it large enough to contain ice for two years consumption,

so that if a mild winter should happen, in which little or no ice is to be had, there may be a stock to supply the want. At the bottom of the well, there should be a space of about two feet deep, left to receive any moisture that may drain from the ice; over this space should be placed a strong wooden grate, and from thence a small drain should be laid under ground, to carry off the wet. The sides of the well should be built with brick or stone, at least two bricks thick; for the thicker it is, the less danger there will be of the well being affected by any external cause. When the well is brought up within three feet of the surface, there should be another outer-arch or wall begun, which should be carried up to the height of the top of the intended arch of the well; and if there be a second arch turned over this wall, it will add to the goodness of the house: the roof must be high enough above the inner arch to admit of a door-way to get out the ice. If the building is to be covered with slates or tiles, reeds should be laid considerably thick under them, to keep out the sun and external air; and if these reeds are laid the thickness of six or eight inches, and plastered over with lime and hair, there will be no danger of the heat getting through them. The external wall may be built in what form the proprietor pleases; and as these ice-houses are placed in gardens, they are sometimes so contrived as to have an handsome alcove-seat in front, with a small door behind it, through which a person might enter to take out the ice; and a large door on the other side, fronting the north, with a porch wide enough for a small cart to back, in order to shoo down the ice near the mouth of the well, which need not be more than two feet diameter, and a stone so contrived as to shut it up in the exactest manner: all the vacant space above and between this and the large door should be filled up with barley-straw. The building thus finished, should have time to dry before the ice is put into it.

It is to be observed, that upon the wooden grate, at the bottom of the well, there should be laid some small faggots; and if upon these a layer of reeds is placed smooth for the ice to lie upon, it will be better than straw, which is commonly used. As to the choice of the ice, the thinner it is, the easier it may be broken to powder; for the smaller it is broken, the better it will unite when put into the well. In putting it in, care must be taken to ram it as close as possible; and also to allow a vacancy of two inches, all round, next the side of the well, to give passage to any moisture occasioned by the melting of some of the ice. When the ice is put into the well, if a little salt-petre be mixed with it at every ten inches or a foot in thickness, it will cause it to unite more closely into a solid mass.

**ICHNEUMON**, in zoology. See **VIVERRA**:

**ICHNEUMON** is also the name of a genus of flies, of the hymenoptera order. It has no tongue; the antennæ have above thirty joints; the abdomen, in most of the species, is petiolated; and it has a sting in the tail inclosed in a double-valved cylindrical sheath. There

are seventy-seven species, principally distinguished by their colour.

**ICHOGRAPHY**, in perspective, the view of any thing cut off by a plain parallel to the horizon, just at the base of it.

Among painters, it signifies a description of images, or of ancient statues of marble and copper, of busts and semi-busts, of paintings in fresco, mosaic works, and ancient pieces of miniature.

**ICHOGLANS**, the grand signior's pages serving in the seraglio.

Those are the children of Christian parents, either taken in war, purchased, or presents from the viceroys and governors of distant provinces: they are the most sprightly, beautiful and well-made that can be met with; and are always reviewed and approved of by the grand signior himself, before they are admitted into the seraglios of Pera, Constantinople, or Adrianople, being the three colleges where they are educated, or fitted for employments, according to the opinion the court entertains of them.

**ICHOR**, properly signifies a thin watery humour, like serum: but is sometimes also used for a thicker kind, flowing from ulcers, called also sanies.

**ICHTHYOCOLLA**, ISINGLASS, a preparation from the fish known by the name of huso. See **ACCIPENSER**.

This is a tough and firm substance, of a whitish colour, and in some degree transparent; it is light, moderately hard, very flexible, and of scarce any smell, and very little taste. We usually receive it in twisted pieces of an oblong and rounded figure, and bent in the shape of a horse-shoe: this our druggists usually beat and pull to pieces, and sell it in thin shreds like skins, which easily dissolve: besides this kind of round isinglass, we meet with some in small thin square cakes, white and very transparent; these are the finest of all. But isinglass, of whatever shape, is to be chosen clean, whitish, and pellucid.

The method of preparing the ichthyocolla is this: they cut off all the fins of the huso, close to the flesh, and take out the bladder, stomach, and intestines; they wash these very clean, and then cut them in pieces, and throwing them into a large quantity of water, they let them steep four and twenty hours, and after this they kindle a fire under the vessel, and keep the liquor just boiling till the greater part of the matters are dissolved; they then stir the whole briskly about; then strain it through flannels, and set the liquor by to cool. When there is a large quantity of fat usually formed upon it, which is carefully skimmed off, and the clear liquor is poured off from the grosser parts which subside, it is put over the fire again, and gently evaporated and skimmed afresh all the time, till by trials they find, that on letting a spoonful of it cool it will harden into the consistence of glue. Great care is taken to keep the fire very gentle, to prevent burning towards the end of this evaporation. They then pour it out upon a large, smooth, wooden table; and as it cools, form it into the masses we meet with it in, by cutting and rolling it up.

The greatest quantity of isinglass is made in Russia. We have it principally from Holland, the Dutch contracting for the most of it before it is made.

It is an excellent agglutinant and strengthener; and is often prescribed in jellies and broth, but rarely enters any compositions of the regular medicinal form. It is the most efficacious as well as the most safe and innocent of all the ingredients used for cleaning wines, upon which account the wine-coopers use a much greater quantity of it than the apothecaries.

A very valuable glue is also made of this drug, which is a proper form to keep it for the wine-coopers use.

**ICHTHYOLOGY**, the science of fishes, or that branch of zoology which treats of fishes. See **NATURAL HISTORY**.

**ICHTHYPERIA**, in natural history, a name given by Dr Hill to the bony palates and mouths of fishes, usually met with either fossile, in single pieces, or in fragments. They are of the same substance with the bufonitz; and are of very various figures, some broad and short, others longer and slender; some very gibbose, and others plainly arched. They are likewise of various sizes, from the tenth of an inch to two inches in length, and an inch in breadth.

**ICOSAHEDRON**, in geometry, a regular solid, consisting of twenty triangular pyramids, whose vertexes meet in the centre of a sphere, supposed to circumscribe it; and therefore, have their height and bases equal. wherefore the solidity of one of those pyramids multiplied by 20, the number of bases, gives the solid content of the icosahedron.

**ICOSANDRIA**, in the Linnæan system of botany. See **BOTANY**, p. 635.

**IDA**, a mountain in the island of Candia or Crete; also another in Natolia, or lesser Asia, celebrated by the poets for the judgment of Paris on the beauty of the three goddesses, Minerva, Juno, and Venus, to the last of whom he gave the preference.

**IDEA**, the reflex perception of objects, after the original perception or impression has been felt by the mind. See **METAPHYSICS**.

**IDENTITY**, denotes that by which a thing is itself, and not any thing else; in which sense, identity differs from similitude as well as diversity. See **METAPHYSICS**.

**IDES**, in the ancient Roman calendar, were eight days in each month; the first of which fell on the 15th of March, May, July, and October; and on the 13th day of the other months.

They were reckoned backwards, in the manner already explained under the article **CALENDIS**.

Thus they called the 14th day of March, May, July, and October; and the 12th of the other months, the *pridie idus*, or the day before the ides; the next preceding day, they called the *tertio idus*; and so on, reckoning always backwards, till they come to the nones. See **NONES**. This method of reckoning time is still retained in the chancery of Rome, and in the calendar of the breviary.

**IDIOM**, among grammarians, properly signifies the peculiar

cular genius of each language, but it is often used in a synonymous sense with dialect.

**IDIOPATHY**, in physic, a disorder peculiar to a certain part of the body, and not arising from any preceding disease; in which sense, it is opposed to sympathetic. Thus, an epilepsy is idiopathic, when it happens merely through some fault in the brain; and sympathetic, when it is the consequence of some other disorder.

**IDIOSYNCRASY**; among physicians, denotes a peculiar temperament of body, whereby it is rendered more liable to certain disorders than persons of a different constitution usually are.

**IDIOT**, a person that is born a natural fool.

**IDOLATRY**, or the worship of idols, may be distinguished into two sorts. By the first, men adore the works of God, the sun, the moon, the stars, angels, dæmons, men and animals: by the second, men worship the work of their own hands, as statues, pictures, and the like: and to these may be added a third, that by which men have worshipped the true God under sensible figures and representations. This indeed may have been the case with respect to each of the above kinds of idolatry; and thus the Israelites adored God under the figure of a calf.

The stars were the first objects of idolatrous worship; and on account of their beauty, their influence on the productions of the earth, and the regularity of their motions, particularly the sun and moon, which are considered as the most glorious and resplendent images of the Deity: afterwards, as their sentiments became more corrupted, they began to form images, and to entertain the opinion, that by virtue of consecration, the gods were called down to inhabit or dwell in their statues. Hence Arnobius takes occasion to rally the pagans for guarding so carefully the statues of their gods, who, if they were really present in their images, might save their worshippers the trouble of securing them from thieves and robbers.

As to the adoration which the ancient pagans paid to the statues of their gods, it is certain, that the wiser and more sensible heathens considered them only as simple representations or figures designed to recal to their minds the memory of their gods. This was the opinion of Varro and Seneca: and the same sentiment is clearly laid down in Plato, who maintains, that images are inanimate, and that all the honour paid to them has respect to the gods whom they represent. But as to the vulgar, they were stupid enough to believe the statues themselves to be gods, and to pay divine worship to stocks and stones.

Soon after the flood, idolatry seems to have been the prevailing religion of all the world; for where-ever we cast our eyes at the time of Abraham, we scarcely see any thing but false worship and idolatry. And it appears from scripture, that Abraham's forefathers, and even Abraham himself, were for a time idolaters.

The Hebrews were indeed expressly forbidden to make any representation of God; they were not so much as to look upon an idol: and from the time of the Maccabees to the destruction of Jerusalem, the Jews extended this precept to the making the figure

of any man: by the law of Moses, they were obliged to destroy all the images they found, and were forbidden to apply any of the gold or silver to their own use, that no one might receive the least profit from any thing belonging to an idol. Of this the Jews, after they had smarted for their idolatry, were so sensible, that they thought it unlawful to use any vessel that had been employed in sacrificing to a false god, to warm themselves with the wood of a grove, after it was cut down, or to shelter themselves under its shade.

But the preaching of the Christian religion, wherever it prevailed, entirely rooted out idolatry; as did also that of Mahomet, which is built on the worship of one God. It must not, however, be forgotten, that the protestant Christians charge those of the church of Rome with paying an idolatrous kind of worship to the pictures or images of saints and martyrs: before these, they burn lamps and wax-candles; before these, they burn incense, and kneeling offer up their vows and petitions: they, like the pagans, believe that the saint to whom the image is dedicated, presides in a particular manner about its shrine, and works miracles by the intervention of its image; and that if the image was destroyed or taken away, the saint would no longer perform any miracle in that place.

**IDYLLION**, in ancient poetry, is only a diminutive of the word [*eidos*,] and properly signifies any poem of moderate extent, without considering the subject. But as the collection of Theocritus's poems were called idyllia, and the pastoral pieces being by far the best in that collection, the term idyllion seems to be now appropriated to pastoral pieces.

**JEALOUSY**, in general, denotes the fear of a rival; but is more especially understood of the suspicion which married people entertain of each other's fidelity and affection.

**JEDBURGH**, the capital of Tiviotdale or Roxburgh, in Scotland, thirty-six miles south-east of Edinburgh: W. long 2° 15', N. lat. 55° 25'.

**JEDDO**, the capital city of Japan Proper, situated on the east side of the island: E. long. 141° N. lat. 36°.

The splendor of the royal palace and public buildings of this city, in the opinion of those Europeans who have seen it, is no where to be equalled. The emperor's palace and gardens, which are in the middle of the city, are five miles in circumference. All the houses are built upon one floor, and the rooms are only divided by folding screens.

**JEER**, or **JEER-ROPE**, in a ship, is a large rop reeved through double or treble blocks, lashed at the mast-head and on the yard, in order to hoist or lower the yards.

**JEHOVAH**, one of the scripture names of God, signifying the Being who is self-existent and gives existence to others.

So great a veneration had the Jews for this name, that they left off the custom of pronouncing it, whereby its true pronunciation was forgotten. They call it tetragrammaton, or the name with four letters; and believe, that whoever knows the true pronunciation of it cannot fail to be heard by God.

JEJU-

**JEJUNUM**, in anatomy. See ANATOMY, p. 260.  
**JEMPTERLAND**, a province of Sweden, bounded by Angermania on the north, by Medelpadia on the east, by Helsingia on the south, and by Norway on the west.

**JENA**, a city of Germany, in the circle of Upper Saxony, and the landgraviate of Thuringia: E. lon.  $11^{\circ} 44'$ , N. lat.  $51^{\circ}$ .

**JENKOPING**, a city of Sweden, in the province of Gothland, situated ninety miles south-east of Gottenburg: E. long.  $14^{\circ} 30'$ , N.  $57^{\circ} 30'$ .

**JEREMIAH**, *The prophecy of*, a canonical book of the Old Testament. This divine writer was of the race of the priests, the son of Hilkiath of Anathoth, in the tribe of Benjamin. He was called to the prophetic office when very young, about the thirteenth of Josiah, and continued in the discharge of it about forty years. He was not carried captive to Babylon with the other Jews, but remained in Judea to lament the desolation of his country. He was afterwards a prisoner in Egypt with his disciple Baruch, where it is supposed he died in a very advanced age. Some of the Christian fathers tell us, he was stoned to death by the Jews, for preaching against their idolatry; and some say, he was put to death by Pharaoh Hophra, because of his prophecy against him. Part of the prophecy of Jeremiah relates to the time after the captivity of Israel, and before that of Judah, from the first chapter to the forty-fourth; and part of it was in the time of the latter captivity, from the forty-fourth chapter to the end. The prophet lays open the sins of Judah with great freedom and boldness, and reminds them of the severe judgments, which had befallen the ten tribes for the same offences. He passionately laments their misfortune, and recommends a speedy reformation to them. Afterwards he predicts the grievous calamities that were approaching, particularly the seventy years captivity in Chaldæa. He likewise foretells their deliverance and happy return, and the recompence which Babylon, Moab, and other enemies of the Jews should meet with in due time. There are likewise several intimations in this prophecy concerning the kingdom of the Messiah; also several remarkable visions, and types, and historical passages relating to those times. The fifty-second chapter does not belong to the prophecy of Jeremiah, which probably was added by Ezra, and contains a narrative of the taking of Jerusalem, and of what happened during the captivity of the Jews, to the death of Jechonias. St. Jerom has observed upon this prophet, that his style is more easy than that of Isaiah and Hosea; that he retains something of the rusticity of the village where he was born; but that he is very learned and majestic, and equal to those two prophets in the sense of his prophecy.

**JERSEY**, an island in the English channel, fifteen miles west of the coast of Normandy, and eighty miles south of Portland in Dorsetshire: W. long.  $2^{\circ} 20'$ , N. lat.  $49^{\circ} 20'$ .

*New* **JERSEY**, a province in North America, which may be bounded on the north by a line drawn from

the river Delaware to Hudson's river, which divides it from New-York; by the Atlantic Ocean, on the east; by the same ocean on the south; and by Delaware bay and river, which separates it from Pennsylvania, on the west. It lies between  $74^{\circ}$  and  $76^{\circ}$  of W. long. and between  $39^{\circ}$  and  $41^{\circ}$  of N. lat. and is about 140 miles in length, and 60 in breadth. It is subject to Britain.

**JERUSALEM**, the capital city of Judea, or Palestine, in Asiatic Turkey, situated thirty miles east of the Levant, or Mediterranean sea, and ninety miles south of Damascus: E. long.  $36^{\circ}$ , N. lat.  $32^{\circ}$ .

It stands on a high rock, with steep ascents on every side, except on the north; and is surrounded with a deep valley, which is again encompassed with hills. The city is at present three miles in circumference, and has a little altered its situation: for mount Calvary, which was formerly without the walls, stands now in the middle of the city; and mount Sion, which stood near the centre, is now without the walls.

**JESI**, a city of Italy, in the province of Ancona, and territory of the pope: E. long.  $14^{\circ} 40'$ , N. lat.  $43^{\circ} 45'$ .

**JESSELMERE**, the capital of the province of the same name in the East Indies, subject to the Mogul: E. long.  $73^{\circ} 20'$ , N. lat.  $27^{\circ}$ .

**JESSO**, or **YEDSO**, a country of Asia, which lies north of Japan, and is said to extend north-east to the continent of America: E. long.  $140^{\circ}$ , N. lat.  $40^{\circ}$ .

**JESUAT**, a province of India, bounded by Patan on the north, and by Bengal on the south; subject to the Mogul.

**JESUITES**, or the society of Jesus, a famous religious order in the Romish church, founded by Ignatius Loyola, a native of Guipuscoa in Spain, who in the year 1538 assembled ten of his companions at Rome, principally chosen out of the university of Paris, and made a proposal to them to form a new order; when, after many deliberations, it was agreed to add to the three ordinary vows of chastity, poverty, and obedience, a fourth; which was, to go into all countries whither the pope should please to send them, in order to make converts to the Romish church. Two years after, pope Paul III. gave them a bull, by which he approved this new order, giving them a power to make such statutes as they should judge convenient: on which, Ignatius was created general of the order; which in a short time spread over all the countries of the world, to which Ignatius sent his companions, while he staid at Rome, from whence he governed the whole society.

The entire society is composed of four sorts of members; novices, scholars, spiritual and temporal coadjutors, and professed members. The novices continue so two years; after which they are admitted to make the three simple vows, of chastity, poverty, and obedience, in the presence of their superiors: the scholars add some spiritual exercises to their studies. The spiritual coadjutors assist the professed members, and also make the three simple vows: the temporal coadjutors,

or

or lay-brothers, take care of the temporal affairs of the society; and the professed members, which compose the body of the society, besides the three simple vows, add a special vow of obedience to the head of the church in every thing relating to missions among idolaters and heretics. They have professed houses for their professed members and their coadjutors; colleges, in which the sciences are taught to strangers; and seminaries, in which the young Jesuits go through a course of philosophy and theology. They are governed by a general, who has four assistants, and who appoints rectors, superiors of houses, provincials, visitors, and commissaries. The discipline of these houses, and especially of the colleges, was regulated by Ignatius himself. On account of the gross doctrines and bad practices of the Jesuits, the order, within these few years, has been suppressed in most Roman-catholic countries; the members banished, and their goods confiscated.

**JET**, in natural history, a solid, dry, opaque, inflammable substance, found in large detached masses, of a fine and regular structure, having a grain like that of wood, splitting more easily horizontally than in any other direction, very light, moderately hard, not fusible, but readily inflammable, and burning a long time with a fine greenish flame.

It is of a fine deep black colour, very glossy and shining, except upon its surface, where it has been fouled by accident. When examined by the microscope, it is found to be composed of a number of parallel plates, very thin, and laid closely upon one another. It is not soluble in, nor makes any effervescence with acids. It should be chosen of the deepest black, of a moderate hardness, very light, and such as will split most evenly in an horizontal direction; this being its great characteristic, by which it is distinguished from the cannel coal, which breaks equally easy any way.

Jet is of great use to perfumers, and is sometimes prescribed in medicine. Dioscorides tells us, that it is an excellent emollient and discutient, and recommends a fumigation of it for diseases of the womb; and among the eastern nations, it is still in high repute as a cordial, a strengthener, and prolonger of life.

Every pound of jet pays on importation a duty of  $7\frac{1}{2}$ d. and draws back  $6\frac{1}{2}$ d. on exportation.

**JET D'EAU**, a French term, frequently also used with us, for a fountain that casts up water to a considerable height in the air.

**JEWEL**, any precious stone, or ornament beset with them. See the articles **DIAMOND**, **RUBY**, &c.

**JEWS**, those who profess obedience to the laws and religion of Moses.

When a modern Jew builds an house, he must leave part of it unfurnished, in remembrance that the temple and Jerusalem now lie desolate. They lay great stress upon frequent washings. They abstain from meats prohibited by the Levitical law; for which reason, whatever they eat must be dressed by Jews, and after a manner peculiar to themselves. Every Jew is obli-

ged to marry, and a man who lives to twenty unmarried, is accounted as actually living in sin.

The Jews, it is said, were formerly at the disposal of the chief lord where they lived, and likewise all their goods. A Jew may be a witness by our law, being sworn on the Old Testament, and taking the oaths to the government.

For a farther account of the Jew, see the articles **CARAITES**, **CIRCUMCISION**, **LEVITES**, **PASSOVER**, **PHARISEES**, **RABBINS**, **SADDUCEES**, **SANHEDRIM**, **SYNAGOGUE**, **TALMUD**, &c.

**JEW'S EARS**, in botany, See **TRENELLA**.

**IGLAW**, a town of Germany, in the province of Moravia, situated on the river Iгла, on the frontiers of Bohemia; subject to the house of Austria: E. long.  $45^{\circ} 7'$ , N. lat.  $49^{\circ} 16'$ .

**IGNAVUS**, in zoology. See **BRADYPUS**.

**IGNIS**. See **FIRE**.

**IGNIS-FATUUS**. See **WILL-with-a-wisp**.

**IGNITION**, in chemistry, the heating metals red-hot, without melting them.

**IGNORANCE**, the privation or absence of knowledge.

The causes of ignorance, according to Locke, are chiefly these three. 1. Want of ideas. 2. Want of a discoverable connection between the ideas we have.

3. Want of tracing and examining our ideas. See **METAPHYSICS**.

**IGUANA**, in zoology. See **LACERTA**.

**IHOR**, the capital of the province of Ibor, in Malacca, near the south cape of the further peninsula of India, subject to the Dutch: E. lon.  $103^{\circ}$ , N. lat.  $3^{\circ}$ .

**ILCHESTER**, a borough-town of Somersetshire, fourteen miles south of Wells. It sends two members to parliament.

**ILEX**, the **HOLM-OAK**, or **EVER-GREEN OAK**, in botany, a genus of the tetrandria-tetragynia class. The calix has four teeth; the corolla is rotated; it has no stylus; and the berry contains four seeds. There are five species, none of them natives of Britain. The kermes of the shops adheres and is gathered off the branches of the *ilex aquifolium*. The kermes is a round grain about the bulk of a pea. These grains appear full of small reddish ovula, or animalcules, of which they are the nidus. The kermes is a grateful mild refringent and corroborant.

**ILHEOS**, or **RIO DE ILHEOS**, a province of Brazil in south America, subject to Portugal. It is bounded by the bay of All-saints on the north, and by the Atlantic ocean on the east.

**ILIAC PASSION**, in medicine. See **MEDICINE**.

**ILIACUS MUSCULUS**, in anatomy. See **ANATOMY**, p. 204.

**ILIAD**, the name of an ancient epic poem, the first and finest of those composed by Homer.

The poet's design in the *iliad* was to shew the Greeks, who were divided into several little states, how much it was their interest to preserve a harmony and good understanding among themselves: for which end, he sets before them the calamities that beset their ancestors from the wrath of Achilles, and his misunder-

- standing with Agamemnon; and the advantages that afterwards accrued to them from their union. The Iliad is divided into twenty-four books, or rhapsodies, which are marked with the letters of the alphabet.
- ILIUM**, in anatomy. See *ANAT.* p. 260.
- ILLENOIS**, the inhabitants of a country contiguous to the illenois-lake, in Canada, in north America, which is situated between 88° and 93° of W. lon. and between 41° and 46° of N. lat.
- ILLER**, a river of Germany, which rising in the mountains of Tyrol, runs north through Swabia, and falls into the Danube at Ulm.
- ILMEN**, a lake in the province of Great Novogrod, in Russia, in 34° E. lon. and 58° N. lat.
- ILMINSTER**, a market-town of Somersetsshire, twenty-four miles south-west of Wells.
- IMAGE**, in a religious sense, is an artificial representation or similitude of some person or thing, used either by way of decoration and ornament, or as an object of religious worship and veneration; in which last sense, it is used indifferently with the word idol.
- IMAGINATION**, a power or faculty of the mind, whereby it conceives and forms ideas of things communicated to it by the outward organs of sense. See *METAPHYSICS*.
- IMAN**, a name applied by the Mahometans to him who is head of the congregations in their mosques; and, by way of eminence, to him who has the supreme authority both in respect to spirituals and temporals.
- IMBECILLITY**, a languid, infirm state of body; which, being greatly impaired, is not able to perform its usual exercises and functions.
- IMBIBING**, the action of a dry porous body, that absorbs or takes up a moist or fluid one: thus, sugar imbibes water; a sponge, the moisture of the air, &c.
- IMBRICATED**, among botanists. See *BOTANY*, p. 641.
- IMENSTAT**, a town of Germany, in the circle of Swabia; situated in E. lon. 10° 8'. N. lat. 47° 26'.
- IMITATION**, the acts of doing or striving to copy after, or become like to, another person or thing.
- Du Bos observes, that the principal merit of poems and pictures consists in the imitation of such objects as would have excited real passions; and that the passions which these imitations give rise to, are only superficial, and not so strong as that of the object imitated, and are therefore soon effaced. He also maintains, that the imitation of tragic objects in poems and pictures, afford most pleasure: we listen, therefore, with pleasure to those unhappy men who make a recital of their misfortunes by means of a painter's pencil, or of a poet's verses; but, as Diogenes Laertius observes, it would afflict us extremely, were we to hear them bewailing their sad disasters in person.
- IMMACULATE**, something without stain, chiefly applied to the conception of the holy virgin.
- IMMATERIAL**, something devoid of matter, or that is pure spirit: thus God, angels, and the human soul, are immaterial beings.
- IMMEDIATE**, whatever is capable of producing an effect without the intervention of external means; thus we say, an immediate cause, in opposition to a mediate or remote one.
- IMMENSITY**, an unlimited extension, or which no finite and determinate space, repeated ever so often, can equal.
- IMMERSION**, that act by which any thing is plunged into water or other fluid.
- It is used in chemistry for a species of calcination, when any body is immersed in a fluid to be corroded; or it is a species of lotion, as when a substance is plunged into any fluid in order to deprive it of a bad quality, or communicate to it a good one.
- IMMERSION**, in astronomy, is when a star or planet is so near the sun with regard to our observations, that we cannot see it; being, as it were, enveloped and hid in the rays of that luminary. It also denotes the beginning of an eclipse of the moon, or that moment when the moon begins to be darkened, and to enter into the shadow of the earth.
- IMMORTAL**, that which will last to all eternity, as having in it no principle of alteration or corruption: thus God and the human soul are immortal.
- IMMUNITY**, a privilege or exemption from some office, duty, or imposition, as an exemption from tolls, &c.
- Immunity is more particularly understood of the liberties granted to cities and communities.
- IMPALED**, in heraldry; when the coats of a man and his wife who is not an heiress are borne in the same escutcheon, they must be marshalled in pale; the husband's on the right side, and the wife's on the left: and this the heralds call baron and feme, two coats impaled.
- If a man has had two wives, he may impale his coat in the middle between theirs; and if he has had more than two, they are to be marshalled on each side of his in their proper order.
- IMPALPABLE**, that whose parts are so extremely minute that they cannot be distinguished by the senses, particularly by that of feeling.
- IMPANATION**, a term used by divines, to signify the opinion of the Lutherans with regard to the eucharist, who believe that the species of bread and wine remain together with the body of our Saviour after consecration.
- IMPANNELLING**, in law, signifies the writing down or entering into a parchment, list or schedule, the names of a jury summoned by the sheriff to appear for such public services as juries are employed in.
- IMPARLANCE**, in law, a petition in court for a day to consider or advise what answer the defendant shall make to the plaintiff's action; and is the continuance of the cause till another day, or a longer time given by the court.
- IMPASTATION**, the mixtion of various materials of different colours and consistencies, baked or bound together with some cement, and hardened either by the air or by fire.
- IMPATIENS**, in botany, a genus of the syngenesia monogynia class. The calix consists of two leaves, and the

the corolla of five irregular petals; and the capsule has five valves. There are seven species, only one of which, *viz.* the *noli-me-tangere*, or touch-me-not, is a native of Britain.

**IMPEACHMENT**, an accusation and prosecution for treason and other crimes and misdemeanors.

**IMPENETRABILITY**, in philosophy, that property of body, whereby it cannot be pierced by another: thus, a body, which so fills a space as to exclude all others, is said to be impenetrable.

**IMPERATIVE**, one of the moods of a verb, used when we would command, intreat, or advise: thus, *go, read, take pity, be advised*, are imperatives in our language.

**IMPERATOR**, in Roman antiquity, a title of honour conferred on victorious generals, by their armies, and afterwards confirmed by the senate.

**IMPERATORIA**, **MASTER-WORT**, in botany, a genus of the pentandria digynia class. The fruit is roundish, compressed, and gibbous in the middle. There is but one species, a native of Switzerland. The root of this plant, though an excellent aromatic, has only place in the plague water of the Edinburgh pharmacopœia.

**IMPERFECT**, something that is defective, or that wants some of the properties found in other beings of the same kind.

**IMPERIAL**, something belonging to an emperor or empire, as imperial crown, imperial chamber, imperial cities, imperial diet, &c.

**IMPERSONAL VERB**, in grammar, a verb to which the nominative of any certain person cannot be prefixed; or, as others define it, a verb destitute of the two first and primary persons, as *debet, oportet, &c.*

**IMPERVIOUS**, a thing not to be pervaded nor passed thro', either by reason of the closeness of its pores, or the particular configuration of its parts.

**IMPETUS**, in mechanics, the force with which one body impels or strikes another. See **MECHANICS**.

**IMPLICATION**, in law, is where something is implied, that is not expressed by the parties themselves in their deeds, contracts, and agreements.

**IMPORTATION**, in commerce, the bringing merchandise into a kingdom from foreign countries; in contradistinction to exportation. See **EXPORTATION**.

We shall here give some of the principal laws relating to the importation of goods into this kingdom. Goods imported without entry, or paying customs, are forfeited; and the lord-treasurer, the barons of the exchequer, or chief magistrates of the place where the offence was committed, or next adjoining to it, may grant a warrant to any person, who, with the assistance of a constable, may break open doors, chests, &c. and take thence any prohibited or unaccustomed goods; but this is to be done within one month after the offence was committed. But if false information is given, the person wrongfully accused, may recover costs, and damages.

No ship or vessel arriving from beyond sea is to be above three days in sailing from Gravesend to the place of discharge on the river Thames, unless hindered by contrary winds or other impediment. And no ship bound

for the port of London is to touch or stay at any place adjoining to any shore, between Gravesend and Cheltenham. True entries are to be made of all such ships lading, upon oath of the master or purser for that voyage; also where she took in her lading, where she was built, how manned, who were the owners, and who the master during the voyage. In all out-ports, ships are to come directly to the place of unloading, and make true entries as aforesaid, upon penalty of the forfeiture of 100 l.

After any ship is cleared, and the watchmen and tidemen discharged from their attendance, if there be found on board any concealed goods that have not paid the duty inwards, the master, or other person taking charge of the ship, shall forfeit 100 l.

Porters, carmen, watermen, &c. assisting in landing unaccustomed goods, shall, on conviction, for the first offence, be committed to the next jail till they find security for their good behaviour; and for their second offence, they are to be committed to prison for two months, without bail or mainprize, or till they are discharged by the court of exchequer, or each of them pay 5 l. to the sheriff of the county.

No merchant-denizen shall cover a stranger's goods, but shall, by himself or agent, sign one of his bills of every entry, with the mark, number, and contents of every parcel of goods, without which no entry shall pass. And no children of aliens under the age of twenty one years, shall have entry made in their names, nor be permitted to trade.

Merchants, trading into the port of London, shall have free liberty to lade and unlade their goods at any of the lawful quays between the Tower and London-bridge, from sun-rising to sun-setting, from September 10, to March 10; and between six o'clock in the morning and six in the evening, from March 10, to September 10; giving notice thereof to the respective officers, appointed to attend the lading and unloading of goods. And such officers as shall refuse to be present shall forfeit 5 l. for every default.

To prevent combination between importers, and seizers of goods unlawfully imported or exported, none shall seize them but the officers of the customs, or such as shall be authorized so to do by the lord treasurer, undertreasurer, or a special commission from his majesty, under the great privy seal.

If any seizer of prohibited or unaccustomed goods does not make due prosecution thereof, it is lawful for the custom-house officers, or others deputed thereto, to make seizure of such goods, and they shall be, in law, adjudged the first true informers and seizers, and have the benefit thereof, notwithstanding any law and statute to the contrary.

All foreign goods permitted to be landed by bills at sight, bills at view or suffrance, shall be landed at the most convenient quays and wharfs, as the officers of the customs shall direct; and there, or at the king's storehouse of the respective ports, shall be measured, weighed, numbered, &c. by the officers appointed, who shall perfect the entry, and subscribe their names to it, and the next day make their report to the customer, collector, or



or comptroller; or in default thereof, shall forfeit 100 l.

Any merchant who shall import goods, shall have liberty to break bulk in any lawful port or quay, the master or purser first making oath of the true contents of the ship's lading. No English merchant shall put on shore in Scotland or Ireland, any merchandize of the growth or produce of any of his majesty's plantations, unless the same have been first landed in England, Wales, or Berwick, and paid the duties with which they are chargeable, under the penalty of forfeiting the ship and goods, three fourths to the king, and one fourth to the informer, or he that shall sue for the same: but if a ship be disabled, or driven into any port of Ireland, and unable to proceed on her voyage, her goods may be put on shore, under the hands of the principal officers of the customs there residing, till the goods can be put on board some other vessel, to be transported to some part of England or Wales.

Natives of England or Ireland may import into England, directly from Ireland, any hemp, flax, thread, yarn and linen, of the growth and manufacture of Ireland, custom-free; the chief officer so importing bringing a certificate from the chief office in Ireland, expressing the particulars of the goods, with the names and places of abode of the exporters thence, and of such as have sworn that the said goods are, bona fide, of the growth and manufacture of that kingdom, and who they are consigned to in England; and the chief officer shall make oath, that the said goods are the same that are on board, by virtue of that certificate.

**IMPOST**, in law, signifies in general a tribute or custom, but is more particularly applied to signify that tax which the crown receives for merchandizes imported into any port or haven.

**IMPOSTS**, in architecture, the capitals of pillars, or pilasters, which support arches.

**IMPOSTHUME**, in surgery, &c. See **ABSCESS**.

**IMPOTENCE**, or **IMPOTENCY**, in general, denotes want of strength, power, or means to perform any thing.

Divines and philosophers distinguish two sorts of impotency; natural, and moral. The first is a want of some physical principle, necessary to an action; or where a being is absolutely defective, or not free and at liberty to act: the second only imports a great difficulty, as a strong habit to the contrary, a violent passion, or the like.

Impotency is, more particularly, used for a natural inability to coition. Impotence with respect to men, is the same as sterility in women; that is, an inability of propagating the species. There are many causes of impotence; as, a natural defect in the organs of generation, which seldom admits of a cure: accidents, or diseases; and in such cases the impotence may, or may not be remedied, according as these are curable or otherwise.

**IMPREGNATION**, the getting a female with-child. See **PREGNANCY**.

The term impregnation is also used, in pharmacy; for communicating the virtues of one medicine to ano-

ther, whether by mixture, coction, digestion, &c. **IMPRESSION** is applied to the species of objects, which are supposed to make some mark or impression on the senses, the mind, and the memory.

The peripatetics assert, that bodies emit species resembling them, which are conveyed to the common sensorium, and they are rendered intelligible by the active intellect; and when thus spiritualized, are called expressions, or express species, as being expressed from the others.

**IMPRESSION** also denotes the edition of a book, regarding the mechanical part only; whereas edition, besides this, takes in the care of the editor, who corrected or augmented the copy, adding notes, &c. to render the work more useful.

**IMPROBATION**, in Scots law, the name of that action brought for setting any deed or writing aside upon the head of forgery. See **LAW**, tit. 33.

**IMPROPRIATION**, a parsonage or ecclesiastical living, the profits of which are in the hands of a layman; in which sense, it stands distinguished from appropriation, which is where the profits of a benefice are in the hands of a bishop, college, &c. though these terms are now often used promiscuously.

**IMPULSE**, in mechanics. See **MECHANICS**.

**IMPURITY**, in the law of Moses, is any legal defilement. Of these there were several sorts; some were voluntary, as the touching a dead body, or any animal that died of itself, or any creature that was esteemed unclean; or the touching things holy, by one who was not clean, or was not a priest; the touching one who had a leprosy, one who had a gonorrhœa, or who was polluted by a dead carcase, &c. Sometimes these impurities were involuntary, as when any one inadvertently touched bones, or a sepulchre, or any thing polluted; or fell into such diseases as pollute, as the leprosy, &c.

**IMPUTATION**, in general, the charging something to the account of one, which belonged to another: thus, the assertors of original sin maintain, that Adam's sin is imputed to all his posterity.

In the same sense, the righteousness and merits of Christ are imputed to true believers.

**INACCESSIBLE**, something that cannot be come at, or approached, by reason of intervening obstacles, as a river, rock, &c. It is chiefly used in speaking of heights and distances. See **GEOMETRY**.

**INALIENABLE**, that which cannot be legally alienated or made over to another: thus the dominions of the king, the revenues of the church, the estates of a minor, &c. are inalienable, otherwise than with a reserve of the right of redemption.

**INANIMATE**, a body that has either lost its soul, or that is not of a nature capable of having any.

**INANITION**, among physicians, denotes the state of the stomach when empty, in opposition to repletion.

**INARCHING**, in gardening, is a method of grafting, commonly called grafting by approach, and is used when the stock intended to graft on, and the tree from which the graft is to be taken, stand so near, or can

can be brought so near, that they may be joined together.

**INAUGURATION**, the coronation of an emperor or king, or the consecration of a prelate: so called from the ceremonies used by the Romans, when they were received into the college of augurs.

**INCA**, or **YUCA**, a name given by the natives of Peru to their kings and the princes of the blood. Pedro de Cieça, in his Chronicle of Peru, gives the origin of the incas, and says, that that country was, for a long time, the theatre of all manner of crimes, of war, dissention, and the most dreadful disorders, till at last two brothers appeared, one of whom was called Mangocapa; of this person, the Peruvians relate many wonderful stories. He built the city of Cusco, made laws, established order and harmony by his wise regulations; and he and his descendants took the name of inca, which signifies king or great lord. These incas became so powerful, that they rendered themselves masters of all the country from Pasco to Chili, and from the river Maule on the south, to the river Augsmago on the north; these two rivers forming the bounds of their empire, which extended above thirteen hundred leagues in length. This they enjoyed till the divisions between inca Guascar and Atabalipa; which the Spaniards laying hold of, made themselves masters of the country, and destroyed the empire of the incas.

**INCAMERATION**, a term used in the chancery of Rome, for the uniting of lands, revenues, or other rights, to the pope's domain.

**INCANTATION**, denotes certain ceremonies, accompanied with a formula of words, and supposed to be capable of raising devils, spirits, &c. See **CHARM**, &c.

**INCAPACITY**, in the canon-law, is of two kinds: 1. The want of a dispensation for age in a minor, for legitimation in a bastard, and the like: this renders the provision of a benefice void in its original. 2. Crimes and heinous offences, which annul provisions at first valid.

**INCARNATION**, in theology, the act whereby the second person of the holy Trinity assumed the human nature, viz. a true body and reasonable soul, in order to accomplish the redemption of fallen mankind.

**INCARNATIVES**, in surgery, medicines which assist nature in filling up wounds or ulcers with flesh; or rather remove the obstructions thereto.

**INCENSE**, or **FRANK-INCENSE**, in the materia medica, &c. a dry resinous substance, known among authors by the names thus and olibanum.

Incense is a rich perfume, with which the ancient pagans, and the Roman Catholics still, perfume their temples, altars, &c.

The burning of incense made part of the daily service of the ancient Jewish church. The priests drew lots to know who should offer it; the destined person took a large silver dish, in which was a censer full of incense; and being accompanied by another priest, carrying some live coals from the altar, went into the temple. There, in order to give notice to the people, they struck upon an instrument of brass placed between

the temple and the altar; and being returned to the altar, he who brought the fire left it there, and went away. Then the offerer of incense having said a prayer or two, waited the signal, which was the burning of the holocaust; immediately upon which he set fire to the incense, the whole multitude continuing all the time in prayer. The quantity of incense offered each day, was half a pound in the morning, and as much at night.

One reason of this continual burning of incense might be, that the multitude of victims that were continually offered up, would have made the temple smell like a slaughter-house, and consequently have inspired the comers rather with disgust and aversion, than awe and reverence, had it not been overpowered by the agreeable fragrance of those perfumes.

**INCEST**, the crime of venereal commerce between persons who are related in a degree wherein marriage is prohibited by the law of the country.

**INCH**, a well known measure of length; being the twelfth part of a foot, and equal to three barley-corns in length.

**INCIDENCE**, denotes the direction in which one body strikes on another. See **OPTICS** and **MECHANICS**.

**INCIDENT DILIGENCE**, in Scots law, a warrant granted by a lord ordinary in the court of session, for citing witnesses for proving any point, or for production of any writing necessary for preparing the cause for a final determination, or before it goes to a general proof.

**INCISIVE**, an appellation given to whatever cuts or divides: thus, the fore-teeth are called dentes incisivi, or cutters; and medicines of an attenuating nature, incidents, or incisive medicines.

**INCLE**, a kind of tape made of linen yarn.

**INCLINATION**, is a word frequently used by mathematicians, and signifies the mutual approach, tendency, or leaning of two lines or two planes towards each other, so as to make an angle.

**INCLINED PLANE**, in mechanics, one that makes an oblique angle with the horizon. See **MECHANICS**.

**INCLOSURE**, in husbandry, the fence or hedge made to inclose lands.

**INCOGNITO**, or **INCOG**, is applied to a person that is in any place where he would not be known: but it is more particularly applied to princes, or great men, who enter towns, or walk the streets, without their ordinary train or the usual marks of their distinction and quality.

**INCOMBUSTIBLE**, something that cannot be burnt, or consumed by fire. See **ASBESTUS**.

**INCOMMENSURABLE**, a term in geometry, used where two lines, when compared to each other, have no common measure, how small soever, that will exactly measure them both. And in general, two quantities are said to be incommensurable, when no third quantity can be found that is an aliquot part of both.

**INCOMMENSURABLE NUMBERS** are such as have no common divisor that will divide them both equally.

**INCOMPATIBLE**, that which cannot subsist with another, without destroying it: thus cold and heat are incom-

- incompatible in the same subject, the strongest overcoming and expelling the weakest.
- INCORPORATION**, in pharmacy, is much the same as impastation, being a reduction of dry substances to the consistence of a paste, by the admixture of some fluid; thus pills, boles, troches, and plasters are made by incorporation. Another incorporation is, when things of different consistences, are by digestion reduced to one common consistence.
- INCORPOREAL**, a thing, or substance, which has no body; as God, angels, and the soul of man.
- INCORRUPTIBLE**, that which cannot be corrupted.
- INCORASSATING**, in pharmacy, &c. the rendering fluids thicker by the mixture of other substances less fluid, or by the evaporation of the thinner parts.
- INCUBATION**, the action of a hen, or other fowl brooding on her eggs.
- INCUBUS**, or **NIGHT-MARE**, in medicine. See **MEDICINE**.
- INCUMBENT**, a clerk, or minister who is resident on his benefice: he is called incumbent, because he does, or at least ought, to bend his whole study to discharge the cure of his church.
- INCURVATION** of the rays of light, their bending out of a rectilinear straight course, occasioned by refraction. See **OPTICS**.
- INCUS**, in anatomy. See **ANATOMY**, p. 296.
- INDEFINITE**, that which has no certain bounds, or to which the human mind cannot affix any.
- INDEFINITE**, in grammar, is understood of nouns, pronouns, verbs, participles, articles, &c. which are left in an uncertain indeterminate sense, and not fixed to any particular time, thing, or other circumstance.
- INDELIBLE**, something that cannot be cancelled, or effaced.
- INDEMNITY**, in law, the saving harmless; or, a writing to secure one from all damage and danger that may ensue from any act.
- INDENTED**, in heraldry, is when the out-line of an ordinary is notched like the teeth of a saw. See **PLATE CII. fig. 1.**
- INDEPENDENTS**, a sect of Protestants in Britain and Holland, so called from their independency on other churches, and their maintaining that each church or congregation has sufficient power to act and perform every thing relating to religious government within itself, and is no way subject or accountable to other churches or their deputies.
- They therefore disallow parochial and provincial subordination, and form all their congregations upon a scheme of co-ordinancy. But though they do not think it necessary to assemble synods; yet if any be held, they look on their resolutions as prudential councils, but not as decisions to which they are obliged to conform.
- INDETERMINATE**, in general, an appellation given to whatever is not certain, fixed, and limited; in which sense, it is the same with indefinite.
- INDEX**, in arithmetic and algebra, shews to what power any quantity is involved, and is otherwise called exponent.
- INDIA PROPER**, or **HITHER INDIA**, a large peninsula in Asia, bounded on the north by Ussac Tartary, and Thibet; on the east, by another part of Thibet, the kingdom of Afem, Ava, and Pegu; on the south, by the bay of Bengal, and the Indian ocean; and by the same ocean and Persia on the west: situated between 66° and 92° of east longitude, and between 7° and 40° of north latitude; being about 2000 miles in length from north to south, and 1500 miles in breadth from east to west where broadest; though the southern part of the peninsula is not 300 miles broad. All the country within these limits is either subject or tributary to the great Mogul. It is frequently called Indostan, a name supposed to be derived from the river Indus, on its western frontiers: it is also called the Mogulistan, from the imperial family now upon the throne, who trace their pedigree from Tamerlane a Mogul Tartar.
- The produce of this country, and what the Europeans import from thence, is chiefly chints, callicocs, muslins, some silk, pepper, and diamonds, which are purchased by most nations with silver; but the Dutch frequently barter spices for them, which makes the India trade doubly advantageous to them.
- INDIA**, beyond the Ganges, is a country bounded by Thibet and Boutan on the north; by China, Tonquin, and Cochinchina on the east; by the Indian ocean on the south; and by the hither India, the bay of Bengal, and the straits of Malacca, on the west: it is situated between 92° and 104° of east longitude, and between the equator and 30 degrees of north latitude: being near 2000 miles in length from north to south, but of a very unequal breadth; in which limits are comprehended the kingdoms of Afem, Ava, Pegu, Laos, Siam, Cambodia, and Malacca, governed by as many Indian princes; only the Dutch have usurped the dominion of Malacca. In this country there are a vast number of elephants, and consequently a great deal of ivory; our merchants also meet with gold and precious stones, canes, opium, and such other articles as are usually found within the tropics.
- INDIAN BERRY**. See **COCCULUS**.
- INDICATION**, in physic, whatever serves to direct the physician how to act.
- INDICATIVE**, in grammar, the first mood, or manner, of conjugating a verb, by which we simply affirm, deny, or ask something; as, *amant*, they love; *non amant*, they do not love; *amantne*, do they love?
- INDICTION**, in chronology, a cycle of fifteen years.
- INDICTMENT**, in Scots law, the name of the summons or libel upon which criminals are cited before the court of Justiciary to stand trial.
- INDIES**, East and West. See **INDIA** and **AMERICA**.
- INDIGESTION**, in medicine, a crudity, or want of due coction, either in the food, an humour of the body, or an excrement.
- INDIGETES**, a name which the ancients gave to some of their gods.
- INDIGO**, in botany. See **INDIGOFERA**.
- INDIGOFERA**, in botany, a genus of the diadelphia decandria class. The calix is plain; the superior margins

gins of the alæ are connivent, and of the same shape with the vexillum; and the pod is strait. There are six species, all of them natives of the Indies. The tinctoria, anil, or indigo, grows about two feet high, with roundish leaves.

As to the indigo blue, it is a secular, or settling, made by means of water and oil olive out of the leaves of the anil, or indigo plant; there is a difference between that made by the leaves only, and that which is made of the leaves and small branches. The choicest of the former sort is that which bears the surname of Serquisse, from a village of that name some leagues from Surat in the East-Indies. It is made also about Biana and Coffa near Agra; and also in the kingdom of Golconda. In making the secular of anil, in order to make indigo of it, they cut the herb with a sickle, when the leaves begin to fall upon touching them; and after they have stripped them from the branches, they put them into a sufficient quantity of water in a vessel called the steeping vat; and let them infuse there thirty or thirty-five hours; after which they turn the cock, in order to let the water run off, which is become of a green colour inclining towards blue, into a vessel of the nature of a churn, where it is worked by means of a roller or turner of wood, the ends of which are pointed and faced with iron: this they work till the water abounds with a lather; then they cast into it a little oil of olive, that is, one pound into such a quantity of the liquor as will yield seventy pounds of indigo, such as is saleable; and as soon as the said oil is thrown in, the lather separates into two parts, so that you may observe a quantity curdled as milk is when ready to break; then they cease working, and let it stand to settle; which when it has done some time, they open the pipe or cock of the vessel, in order to let the water clear off, that the secular which is subsided may remain behind at the bottom of the vessel like the lees of wine. Then taking it out, they put it into straining bags of cloth, to separate what water was left; after which they convey it into chests or boxes that are shallow, to dry it; and being dried, it is what we call indigo.

Choose the indigo of Serquisse in flat cakes, of a moderate thickness, neither too soft nor too hard, of a deep violet colour, light, and such as swims on water, and when broken has no white spots in it; and lastly, such as is copperish or reddish on being rubbed with one's nail, and has the least dust and broken pieces in it.

The other sort of indigo is also the secular made from the anil; and differs nothing from the former, but as it is made of the whole plant, stalk and leaf; the best of which kind is that which bears the name Guatimala, that comes from the West Indies. In choosing this indigo, it should be as near the other kind as can be; but the surest proof of its goodness is its burning upon the fire like wax, and leaving only a little ashes behind. The second sort of indigo is that of St Domingo, differing nothing from the Guatimala, only that it is not of so lively a colour; the third is the Jamaica indigo; the fourth is that of the Leeward

islands; all which are better or worse, according as they are more or less neat and pure.

The use of the indigo is for the the dyer and landresses, serving the last to put among their linen. The painters use it to grind with white for painting in blue; for if it is used alone and neat, it turns black; ground with yellow, it makes a green: some confectioners and apothecaries preposterously use this to colour sugars with which to make conferves and syrup of violets, by adding some orice.

**INDIVIDUAL**, in logic, a particular being of any species, or that which cannot be divided into two or more beings equal or alike.

The usual division in logic is made unto genera or genus's, those genera into species, and those species into individuals.

**INDIVISIBLE**, among metaphysicians. A thing is said to be absolutely indivisible, that is a simple being, and consists of no parts into which it may be divided. Thus God is indivisible in all respects, as is also the human mind, not having extension or other properties of body.

**INDIVISIBLES**, in geometry, the elements or principles into which any body or figure may be ultimately resolved; which elements are supposed infinitely small: thus a line may be said to consist of points, a surface of parallel lines, and a solid of parallel and similar surfaces.

**INDORSEMENT**, in law, any thing written on the back of a deed, as a receipt for money received.

There is likewise an indorsement, by way of assignment, on bills of exchange and notes of hand; which is done by writing a person's name on the back thereof. See **BILL**.

**INDUCTION**, in law, is putting a clerk or clergyman in possession of a benefice or living to which he is collated, or presented.

**INDULGENCES**, in the Romish church, are a remission of the punishment due to sins, granted by the church, and supposed to save the sinner from Purgatory. Clement VI. in his decretal, which is generally received by the church of Rome, declares; that our Saviour has left an infinite treasure of merits, arising from his own sufferings, besides those of the blessed virgin and the faints; and that the pastors and guides of the church, and more especially the popes, who are the sovereign disposers of this treasure, have authority to apply it to the living by virtue of the keys, and to the dead by way of suffrage, to discharge them from their respective proportions of punishment, by taking just so much merit out of this general treasure as they conceive the debt requires, and offering it to God.

The power of granting indulgences has been greatly abused in the church of Rome. It was one of the chief things which the council of Constance laid to the charge of John XXIII. in 1415, that he impowered his legates to absolve penitents from all sorts of crimes, upon the payment of sums proportionable to their guilt. Pope Leo X. in order to carry on the magnificent structure of St. Peter's at Rome, published indulgences, and a plenary remission to all such as should contribute money

money towards it. Finding the project take, he gave his sister, the princess of Cibo, the benefit of the indulgences of Saxony and the neighbouring parts, and farmed out those of other countries to the highest bidders, who, to make the best of their bargains, procured the ablest preachers to cry up the value of the ware. "Happy times for sinners! says a modern writer, "their crimes were rated, and the remission of them set up by auction. The apostolic chancery taxed sins at a pretty reasonable rate. It cost but ninety livres and a few ducats, for crimes which people on this side the Alps punished with death."

It was this great abuse of indulgences that contributed not a little to the first reformation of religion in Germany, where Martin Luther began first to declaim against the preachers of indulgences, and afterwards against indulgences themselves: but since that time the popes have been more sparing in the exercise of this power: however, they still carry on a great trade with them to the Indies, where they are purchased at two rials a-piece, and sometimes more.

The pope likewise grants indulgences to persons at the point of death; that is, he grants them, by a brief, power to chuse what confessor they please, who is authorized thereby to absolve them from all their sins in general.

**INDULT**, in the church of Rome, the power of presenting to benefices granted to certain persons by the pope. Of this kind is the indult of kings and sovereign princes in the Romish communion, and that of the parliament of Paris granted by several popes. By the concordat for the abolition of the pragmatic sanction, made between Francis I. and Leo X. in 1516, the French king has the power of nominating to bishoprics, and other consistorial benefices, within his realm. At the same time, by a particular bull, the pope granted him the privilege of nominating to the churches of Britany and Provence. In 1648 pope Alexander VIII. and in 1668 Clement IX. granted the king an indult for the bishoprics of Metz, Toul, and Verdun, which had been yielded to him by the treaty of Munster; and in 1668 the same pope Clement IX. granted him an indult for the benefices in the counties of Roussillon, Artois, and the Netherlands. The cardinals likewise have an indult granted them by agreement between pope Paul IV. and the sacred college in 1555, which is always confirmed by the popes at the time of their election. By this treaty the cardinals have the free disposal of all the benefices depending on them, and are empowered likewise to bestow a benefice in commendam.

**INDULTO**, a duty, tax, or custom, paid to the king of Spain for all such commodities as are imported from the West Indies in the galleons.

**INDUS**, a large river of Asia, which rises in the mountains which separate Tartary from India, and discharges itself into the India ocean.

**INERTIA of matter**, in philosophy, is defined by Sir Isaac Newton to be a passive principle by which bodies persist in their motion or rest, receive motion in pro-

portion to the force impressing it, and resist as much as they are resisted. It is also defined by the same author to be a power implanted in all matter, whereby it resists any change endeavoured to be made in its state. See **MECHANICS**.

**INFALLIBLE**, something that cannot err, or be deceived.

One of the great controversies between the Protestants and Papists, is the infallibility which the latter attribute to the pope; though, in fact, they themselves are not agreed on that head, some placing this pretended infallibility in the pope and a general council.

**INFAMY**, in law, is a term which extends to forgery, perjury, gross cheats, &c. by which a person is rendered incapable of being a witness or juror, even tho' he is pardoned for his crimes.

**INFANT**, denotes a young child. See **MIDWIFERY**, and **MEDICINE**.

**INFANTE**, and **INFANTA**, all the sons and daughters of the kings of Spain and Portugal, except the eldest; the princes being called *infantes*, and the princesses *infantas*.

**INFANTRY**, in military affairs, denotes the whole body of foot-soldiers.

**INFECTION**, among physicians. See **CONTAGION**.

**INFESTMENT**, in Scots law, the solemnity of the delivery of an heretable subject to the purchaser. See **LAW**, tit. 10.

**INFINITE**, that which has neither beginning nor end: in which sense God alone is infinite.

Infinite is also used to signify that which has had a beginning, but will have no end, as angels and human souls. This makes what the schoolmen call *infinitum a parte post*; as, on the contrary, by *infinitum a parte ante*, they mean that which has an end but had no beginning.

**INFINITE QUANTITIES**. The very idea of magnitudes infinitely great, or such as exceed any assignable quantities, does include a negation of limits: yet if we nearly examine this notion, we shall find that such magnitudes are not equal among themselves, but that there are really, besides infinite length and infinite area, three several sort of infinite solidity; all of which are *quantitates sui generis*, and that those of each species are in given proportions.

Infinite length, or a line infinitely long, is to be considered either as beginning at a point, and so infinitely extended one way, or else both ways from the same point; in which case the one, which is a beginning infinity, is the one half of the whole, which is the sum of the beginning and ceasing infinity; or, as may be said, of infinity *a parte ante* and *a parte post*, which is analogous to eternity in time and duration, in which there is always as much to follow as is past, from any point or moment of time; nor doth the addition or subtraction of finite length, or space of time, alter the case either in infinity or eternity, since both the one or the other cannot be any part of the whole.

**INFINITESIMALS**, among mathematicians, are defined to be infinitely small quantities.

In

In the method of infinitesimals, the element, by which any quantity increases or decreases, is supposed to be infinitely small, and is generally expressed by two or more terms, some of which are infinitely less than the rest, which being neglected as of no importance, the remaining terms form what is called the difference of the proposed quantity. The terms that are neglected in this manner, as infinitely less than the other terms of the element, are the very same which arise in consequence of the acceleration, or retardation, of the generating motion, during the infinitely small time in which the element is generated; so that the remaining terms express the elements that would have been produced in that time, if the generating motion had continued uniform: therefore those differences are accurately in the same ratio to each other as the generating motions or fluxions. And hence, though in this method infinitesimal parts of the elements are neglected, the conclusions are accurately true without even an infinitely small error, and agree precisely with those that are deduced by the method by fluxions. See **FLUXIONS**.

**INFIRMARY**, a kind of hospital, where the weak and sickly are properly taken care of.

**INFLAMMABILITY**, that property of bodies which disposes them to kindle, or catch fire. See **FIRE**.

**INFLAMMATION**. See **MEDICINE** and **SURGERY**.  
**INFLECTION**, or *Point of INFLECTION*, in the higher geometry, is a point where a curve begins to bend a contrary way.

**INFLECTION**, in grammar, the variation of nouns and verbs, by declension and conjugation.

**INFLUENCE**, a quality supposed to flow from the heavenly bodies, either with their light or heat; to which astrologers idly ascribe all sublunary events.

**INFORMATION**, in law, is nearly the same in the crown-office, as what in other courts is called a declaration. It is sometimes brought by the king, or his attorney general, or the clerk of the crown-office; and at other times by a private person, who informs or sues, as well for the king as himself, upon the breach of some popular statute, in which a penalty is given to the party that will sue for it.

**INFRACTION**, a term chiefly used to signify the violation of a treaty.

**INFRA-SCAPULARIS**, in anatomy. See **ANATOMY**, p. 196.

**INFRA-SPINATUS**, in anatomy. See **ANATOMY**, p. 195.

**INFULA**, in antiquity, a broad kind of fillet, made of white wool, which the priests used to tie round their heads.

**INFUNDIBULIFORM**, in botany, an appellation given to such monopetalous or one-leaved flowers, as resemble a funnel in shape, or which have a narrow tube at one end, and gradually widen towards the limb or mouth.

**INFUSION**, in pharmacy, a method of obtaining the virtues of plants, roots, &c. by steeping them in a hot or cold liquid.

Hot infusions are made by pouring boiling water, or  
Vol. II. Numb. 62.

any other menstruum, on the drugs whose virtues we would extract: thus, in order to obtain the common infusion of senna, take the leaves of senna, an ounce and a half; of crystals of tartar, three drams; of the lesser cardamom seeds husked, two drams: boil the crystals of tartar in a pint of water, till they are dissolved; then pour the water, while boiling hot, upon the senna and the rest; and when the liquor is cold, strain it off.

**INGELSHEIM**, a town of Germany, in the palatinate of the Rhine, eight miles south-west of Mentz, E. long. 7° 40', N. lat. 50°

**INGLUVIES**, the crop or craw of granivorous birds, serving for the immediate reception of the food, where it is macerated for some time, before it is transmitted to the true stomach.

**INGOLSTAT**, a town of Germany, in the circle of Bavaria, situated on the river Danube, thirty miles west of Ratibon: E. long. 11° 30', and N. lat. 48° 45'.

**INGOT**, a mass of gold or silver, melted down and cast in a mould, but not coined or wrought.

**INGRAFTING**, in gardening. See **GARDENING**.

**INGRESS**, in astronomy, signifies the sun's entering the first scruple of one of the four cardinal signs, especially Aries.

**INGRIA**, a province of Russia, bounded by the lake Ladoga, the river Nieva, and the gulph of Finland on the north, by Novogorod on the east and south, and by Livonia on the west.

**INGROSSER**, one who buys up great quantities of any commodity, before it comes to market, in order to raise the price.

**INGUEN**, in anatomy, the same with what is otherwise called groin, or pubes.

**INHERITANCE**, a perpetual right or interest in lands, invested in a person and his heirs.

**INHIBITION**, in Scots law, a diligence obtained at the suit of a creditor against his debtor, prohibiting him from selling or contracting debts upon his estate to the creditor's prejudice. See **LAW**, tit. 18.

**INHUMATION**, in chemistry, a method of digesting substances by burying the vessel in which they are contained in horse-dung or earth.

**INJECTION**, the forcibly throwing certain liquid medicines into the body, by means of a syringe, tube, clyster-pipe, or the like.

*Anatomical* **INJECTION**, the filling the vessels with some coloured substance, in order to make their figures and ramifications visible.

For this purpose, a fine red injection is prepared thus: pour a pint of oil of turpentine on three ounces of vermilion, stir them well together, and then strain all through a fine linen cloth. If a green injection is wanted, distilled verdigrease may be used instead of the vermilion.

A coarse injection may be made of one pound of tallow, five ounces of white-wax, three ounces of oil of olives, melted together, and adding two ounces of venice-turpentine; and when this is dissolved, three ounces of vermilion or verdigrease are to be thoroughly mixed with the other ingredients, and the whole strained through a linen cloth.

**INJURY**, any wrong done to a man's person, reputation, or goods.

**INK**, a black liquor generally made of an infusion of galls, copperas, and a little gum arabic.

To make a very good ink for writing: take three ounces of good galls, reduced to powder; which infuse in three pints of river or rain-water, setting it in the sun or a gentle heat, for two days; then take common copperas, or green vitriol, three ounces; powder it, put it into the infusion, and set it in the sun for two days more; lastly, shake it well, and add an ounce of good gum arabic.

To make the London powder-ink: take ten ounces of the clearest nut-galls, which reduce to a fine powder; then add two ounces of white copperas, four ounces of Roman vitriol, and of gum arabic or sandarach an ounce; pound and sift them very fine. This powder, though whitish itself, will, when put into water, turn it to a good black ink: an ounce of the powder serves to make a pint of ink.

To make a shining ink: take gum arabic and Roman vitriol, of each an ounce; galls well bruised, a pound; put them into rape-vinegar, or vinegar made of clear small beer; set them in a warm place, stir them often till the liquor becomes black, and then add to a gallon of this preparation an ounce of ivory-black, and a quarter of a pint of seed-lac varnish.

To make a shining Japan or China ink: take an ounce of lamp-black, and clarify it in an earthen pipkin to take out the dross; two drams of indigo; half a dram of peach black; one dram of black endive, burnt; reduce them to a very fine powder, and then take a moiety of fig-leaf-water, another part of milk, and a very little gum arabic; and mixing all the ingredients well together, make them up for use.

**Printing Ink** is made by boiling or burning linseed-oil till it is pretty thick, adding a little rosin to it while hot, and then mixing this varnish with lamp-black.

**INK** is also an appellation given to any coloured liquor, used in the same manner as the atramentum or black ink; as red, green, blue, yellow, &c. inks.

Red ink is made thus: take wine-vinegar a pint; raspings of brazil, one ounce; alum, half an ounce; boil them gently, and add five drams of gum arabic: dissolve the gum, strain the ingredients, and keep the liquid for use.

Green ink is made by boiling verdigrease with argol in fair water, and adding a little gum arabic.

Blue ink is made by grinding indigo with honey and the white of eggs, and making it fluid with water.

Yellow ink is made by an infusion of saffron in water, with a little alum and gum arabic.

**Sympathetic Ink**, a liquor with which a person may write, without the letters appearing, till some means be taken to render them legible.

Of this kind are the glutinous juices of plants, or any other thick and viscid fluids, provided they have no remarkable colours themselves; for being written on white paper, nothing will appear, till some fine powder of any coloured earth is thrown over the paper, whereby the letters become legible: the reason of this is

evident, as the powder sticks only to the letters formed by the invisible but viscid liquor.

Another sort of sympathetic inks are made of infusions, the matter of which easily burns to a charcoal: thus if a scruple of sal armoniac be dissolved in two ounces of fair water, letters written therewith will be invisible till held before the fire; for the sal armoniac being burnt to a charcoal, by a heat not strong enough to scorch the paper, the letters are thereby rendered visible,

Another sort of sympathetic ink is made of a solution of lead in vinegar, and a lixivium of lime and orpiment; for if a letter be written with the former, nothing will appear: but to conceal the affair still more, some different subject may be written above it, with a black ink made of burnt cork and gum-water; then, if a piece of cotton, wetted with the said lixivium, be rubbed over the paper, the sentence that was visible will disappear, and the invisible one before written with the solution of lead will be seen in its place very black and strong.

**INN**, a place appointed for the entertainment and relief of travellers.

**Inns of Court**, are colleges in London, for the study of the laws of England, with all conveniencies for the lodging and entertainment of the professors and students.

The four principal inns of court are the Inner-temple, Middle-temple, Lincoln's inn, and Gray's inn; the other inns are the two serjeant's inns; and the others, which are less considerable, are Clifford's inn, Symond's inn, Clement's inn, Lion's inn, Furnival's inn, Staple's inn, Thavie's inn, Barnard's inn, and New-inn. These are mostly taken up by attorneys, solicitors, &c. but they belong to the inns of court, who send yearly some of their barristers to read to them.

**INN**, in geography, a large river which rises in a mountain of the Alps, in the country of the Grisons, runs north-east through Tyrol and Bavaria, and discharges itself into the Danube.

**INNATE IDEAS**, those supposed to be stamped on the mind from the first moment of its existence, and which it constantly brings into the world with it: a doctrine, which Mr. Locke has abundantly refuted.

**INNERKEITHING**, a port-town of Scotland, in the county of Fife, situated on the north shore of the frith of Forth, ten miles north-west of Edinburgh.

**INNISKILLING**, a strong town of Ireland, in the province of Ulster, and county of Fermanagh: W. long. 7° 50', and N. lat. 54° 20'.

**INNOCENTS DAY**, a festival of the Christian church, observed on December 28, in memory of the massacre of the innocent children by the command of Herod king of Judea; who being alarmed at hearing that an infant was born king of the Jews, and imagining that his own kingdom was in danger, sent orders to have all the children slain that were in Bethlehem and the adjacent country.

The Greek church in their calendar, and the Abyssinians of Ethiopia in their offices, commemorate fourteen thousand infants on this occasion.

INNOMI-

**INNOMINATA OSSA**, in anatomy. See **ANATOMY**, p. 171.

**INOCULATION**, in medicine, the art of transplanting a distemper from one subject to another, by incision, particularly used for engrafting the small pox. See **MEDICINE**.

**INOSCULATION**, in anatomy. See **ANASTOMASIS**.

**INQUEST**, in Scots law, the same with jury.

**INQUISITION**, in the church of Rome, a tribunal in several Roman catholic countries, erected by the popes for the examination and punishment of heretics.

This court was founded in the twelfth century by father Dominic and his followers, who were sent by pope Innocent III. with orders to excite the catholic princes and people to extirpate heretics, to search into their number and quality, and to transmit a faithful account thereof to Rome. Hence they were called inquisitors; and this gave birth to the formidable tribunal of the inquisition, which was received in all Italy, and the dominions of Spain, except the kingdom of Naples and the Low Countries.

This diabolical tribunal takes cognizance of heresy, Judaism, Mahometanism, Sodomy, and polygamy; and the people stand in so much fear of it, that parents deliver up their children, husbands their wives, and masters their servants, to its officers, without daring in the least to murmur. The prisoners are kept for a long time, till they themselves turn their own accusers, and declare the cause of their imprisonment; for they are neither told their crime, nor confronted with witnesses. As soon as they are imprisoned, their friends go into mourning, and speak of them as dead, not daring to solicit their pardon, lest they should be brought in as accomplices. When there is no shadow of proof against the pretended criminal, he is discharged, after suffering the most cruel tortures, a tedious and dreadful imprisonment, and the loss of the greatest part of his effects. The sentence against the prisoners is pronounced publicly, and with extraordinary solemnity. In Portugal they erect a theatre capable of holding three thousand persons, in which they place a rich altar, and raise seats on each side in the form of an amphitheatre. There the prisoners are placed, and over-against them is a high chair, whither they are called, one by one, to hear their doom, from one of the inquisitors.

These unhappy people know what they are to suffer, by the cloaths they wear that day. Those who appear in their own cloaths, are discharged upon payment of a fine: those who have a *santo benito*, or strait yellow coat without sleeves, charged with St. Andrew's cross, have their lives, but forfeit all their effects: those who have the resemblance of flames, made of red serge, sewed upon their *santo benito*, without any cross, are pardoned, but threatened to be burnt if ever they relapse: but those who, besides these flames, have on their *santo benito* their own picture, surrounded with figures of devils, are condemned to expire in the flames. The inquisitors, who are ecclesiastics, do not pronounce the sentence of death; but form and

read an act, in which they say, that the criminal being convicted of such a crime, by his own confession, is with much reluctance delivered to the secular power to be punished according to his demerits: and this writing they give to the seven judges, who attend at the right side of the altar, who immediately pass sentence. For the conclusion of this horrid scene, see **ACT of faith**.

**INSCRIBED**, in geometry. A figure is said to be inscribed in another, when all its angles touch the side or planes of the other figure.

**INSCRIPTION**, a title or writing carved, engraved, or affixed to any thing, to give a more distinct knowledge of it, or to transmit some important truth to posterity.

The inscriptions mentioned by Herodotus and Diodorus Siculus, sufficiently shew that this was the first method of conveying instruction to mankind, and transmitting the knowledge of history and sciences to posterity: thus the ancients engraved upon pillars both the principles of sciences, and the history of the world. Pisistratus carved precepts of husbandry on pillars of stone; and the treaties of confederacy between the Romans and Jews, were engraved on plates of brass. Hence, antiquarians have been very curious in examining the inscriptions on ancient ruins, coins, medals, &c.

**INSECTS**, in zoology, a numerous class of animals. See **NATURAL HISTORY**.

**INSERTION**, in anatomy, the close conjunction of the vessels, tendons, fibres, and membranes of the body with some other parts.

**INSIPID**, an appellation given to things without taste.

**INSOLATION**, in chemistry, the suffering matters to stand and digest in the heat of the sun, instead of that of a furnace.

**INSOLVENT**, a term applied to persons unable to pay their debts.

**INSPIRATION**, among divines, implies the conveying of certain extraordinary and supernatural notices or motions into the soul.

**INSPISSATING**, in pharmacy, an operation whereby a liquor is brought to a thicker consistence, by evaporating the thicker parts.

**INSBRUCK**, a city of Germany, in the circle of Austria, capital of the county of Tyrol, situated on the river Inn, in E. long. 11° 26', N. lat. 47° 12'.

**INSTALLMENT**, the installing or establishing a person in some dignity.

**INSTANT**, such a part of duration wherein we perceive no succession; or it is that which takes up the time only of one idea in our minds.

**INSTAURATION**, the re establishment or restoration of a religion, a church, or the like, to its former state.

**INSTEP**, in the manege, is that part of a horse's hind leg which reaches from the ham to the pastern-joint.

**INSTINCT**, an appellation given to the sagacity and natural inclinations of brutes, which supplies the place of reason in mankind.

INSTI-



**INSTITUTES**, in literary history, a book containing the elements of the Roman law, and constitutes the last part of the civil-law.

The Institutes are divided into four books, and contain an abridgment of the whole body of the civil law; being designed for the use of students.

**INSTITUTE**, in Scots law. When by disposition, or deed of entail, a number of persons are called to the succession of an estate one after another, the person first named is called the institute, and the others substitutes. See *LAW*, tit. 27.

**INSTITUTION**, in general, signifies the establishing or founding something.

In the canon and common law, it signifies the investing a clerk with the spiritualities of a rectory, &c. which is done by the bishop, who uses the formula, "I institute you rector of such a church, with cure of souls, and receive your care and mine."

**INSTRUMENT**, in general, whatever is subservient to a cause in producing any effect.

A common case of mathematical instruments contains several compasses, a sector, scale, drawing-pen, and protractor.

**Notarial INSTRUMENT**, in Scots law, any fact certified in writing, under the hand of a notary-public. See *LAW*, tit 21.

**INSULATED**, in architecture, an appellation given to such columns as stand alone, or free from any contiguous wall, &c. like an island in the sea; whence the name.

**INSURANCE**, in law and commerce, a contract or agreement whereby one or more persons, called insurers, assurers, &c. oblige themselves to answer for the loss of a ship, house, goods, &c. in consideration of a premium paid by the proprietors of the things insured.

Insurances are of various kinds, as on ships or parts of ships, on merchandize singly, and on ships and goods jointly: and these are again branched out to run either for a time stipulated, or to one single port, or out and home, with liberty to touch at the different places mentioned in the policy. Insurances may likewise be made on goods sent by land, or by hoys, &c. on rivers; and this is frequently done, more especially on jewels, and other things of great value.

The principal offices for the insurance of ships and merchandize in London, are the Royal-exchange assurance, and the London assurance, both of which are established by act of parliament. These offices also insure houses and other buildings, goods, wares, and merchandize, from loss or damage by fire; and the former of them also assure lives.

The Royal-exchange insurance, on a brick or stone building, insures any sum not exceeding 200*l.* at 5*s.* *per ann.* and any larger sum not exceeding 1000*l.* after the rate of 2*s.* 6*d.* *per cent. per ann.* Above 1000*l.* and not exceeding 2000*l.* at 3*s.* *per cent.* Above 2000*l.* and not exceeding 3000*l.* at 4*s.* *per cent.* On goods and merchandize, the property of the assured, within any brick or stone building, or on the goods and building together, this office insures any sum not exceeding 300*l.* for 7*s.* 6*d.* *per ann.* and

larger sums after the rates above-mentioned: but timber or plaster-buildings, or goods or merchandize therein, pay 8*s.* *per ann.* for 200*l.* and after the rate of 4*s.* *per cent.* for any greater sum not exceeding 1000*l.* and 5*s.* *per cent.* for all insurances above 1000*l.* and not exceeding 2000*l.* On a timber or plaster-building with goods and merchandize together, any sum, not exceeding 300*l.* may be insured for 12*s.* *per ann.* and larger sums at the above rates. The goods belonging to hazardous trades, as distillers, chemists, apothecaries, colour-men, tallow-chandlers, oilmen, innholders, &c. deposited in brick houses, pay 8*s.* *per ann.* for insuring 200*l.* and after the rate of 4*s.* *per cent.* for any greater sum not exceeding 1000*l.*; and above 1000*l.* and not exceeding 2000*l.* 5*s.* *per cent.* but when the houses and goods are put together, the price of insurance is 4*s.* *per cent. per ann.* without any other charge except the policies.

The Friendly Society insurance, has some very extraordinary regulations; the principal of which is, that every one of the assured becomes a member of the society; and when any loss happens, contributes in proportion to the sum he has insured, to make good the damage; on which account he pays only 1*s.* 4*d.* *per cent. per ann.* premium, and 6*s.* 8*d.* *per cent.* as a caution; but what is unexpended of the 6*s.* 8*d.* is returned to the party insured at the end of seven years.

We have also insurances for lives, in virtue of which, when the person insured dies, a sum of money becomes payable to the person on whose behalf the policy of insurance was granted. The principal insurance-office of this kind, is that of the Amicable Society for a perpetual assurance, kept in Serjeant's inn, Fleet-street, London.

In this office, after paying the charges of the policy, and 10*s.* entrance-money, each person pays 5*l.* *per annum*, by quarterly payments; and from these payments the dividends, which usually amount to 100*l.* and upwards, are to arise. All persons admitted are to be between the ages of twelve and forty five, and in a good state of health. Any person is allowed to have two or three insurances or numbers on the same life, whereby such person will be intitled to a claim on each number so insured; and every claimant is empowered to put in a new life, in the room of one deceased, within twelve calendar months next after the end of the current year. By becoming members of this society, clergymen, physicians, lawyers, tradesmen, and all whose income ceases at the time of their death, may, in all probability, leave to their families a claim of not less than 100*l.* for every 5*l.* annually paid in.

**INTAGLIOS**, precious stones on which are engraved the heads of great men, inscriptions, and the like; such as we frequently see set in rings, seals, &c.

**INTEGER**, in arithmetick, a whole number, in contradistinction to a fraction.

**INTERCALARY**, an appellation given to the odd day inserted in leap year; which was so called from *cal.*, *calare*, to proclaim, it being proclaimed by the priests with a loud voice.

INTER-

**INTERCOLUMNIATION**, in architecture, denotes the space between two columns, which is always to be proportioned to the height and bulk of the columns. See ARCHITECTURE.

**INTERCOSTAL**. in anatomy, an appellation given to such muscles, nerves, arterics and veins as lie between the ribs. See ANATOMY, Part II.

**INTERDICT**, an ecclesiastical censure, by which the church of Rome forbids the performance of divine service in a kingdom, province, town, &c.

**INTERDICTION**, in Scots law, a legal restraint laid upon weak or profuse persons from signing any deed to their own prejudice, without the consent of curators or interdictors. See SCOTS LAW, tit. 7.

**INTEREST**, is the premium or money paid for the loan or use of money; and is distinguished into two kinds, simple and compound.

Simple interest is that which is paid for the principal, or sum lent, at a certain rate or allowance made by law, or agreement of parties, whereby so much as 5l. or 6l. or any other sum, is paid for 100l. lent out for one year; and more or less proportionally for greater or lesser sums, and for more or less time. For example, if it is 5l. to 100l. for one year, it is 2l. 10s. for half a year, and 10l. for two years: also 10l. for one year of 200l. and 5l. for half a year; and so on, for other sums and times. Thus, as the law, or agreement of parties, fixes a certain ratio, or, as we call it, rate of interest, which is so much on the 100l. for one year: from this we can easily find the proportional interest on 1l. for one year, being plainly the  $\frac{1}{20}$  part of the interest of 100l. so if this is 5l. that is .05l. if this is 6l. that is .06l. and if this is 5l. 10s. or 5 5l. that is .055l. Wherefore, if we understand the rate of interest to be the interest of 1l. for one year, the more common questions about simple interest will relate to these four things, viz. any principal sum, its interest, the time in which it gives that interest, and the rate, or interest of 1l. for one year; according to which, that principal, interest, and time, are adjusted to one another.

From which we have four problems; in the rules whereof we suppose the principal and interest expressed in the denomination of pounds, by reducing what is less than 1l. to a decimal of 1l. and the time to be expressed in years, and decimal parts of one year.

**Prob. I.** Having any principal, sum, and time, with the rates of interest given, to find the interest of that sum for that time and rate.

**Rule:** Multiply the principal rate, and time, continually into one another; the product is the interest sought.

Observe, if we express the principal by  $p$ , the interest by  $n$ , the time by  $t$ , and the rate by  $r$ , then this rule is thus represented,  $n = tpr$ .

**Example:** The rate of interest being .05l. what is the interest of 85l. for 4 years and 3 quarters, or 4.75 years?

**Answer.** 20l. 3s. 9d. = 20.1875l. =  $85 \times 4.75 \times .05$ .

Which is thus performed:

$$\begin{array}{r} 85 = p \\ 4.75 = t \\ \hline 425 \\ 595 \\ 340 \\ \hline 403.75 \\ .05 = r \\ \hline \end{array}$$

20.1875 pounds.

Which decimal is reduced by multiplying it by 20, 12, and 4: thus,

$$\begin{array}{r} .1875 \\ 20 \\ \hline 3.7500 \text{ shillings} \\ 12 \\ \hline 15000 \\ 7500 \\ \hline 9.0000 \text{ pence} \end{array}$$

**Prob. II.** Having the rate, principal and interest, to find the time.

**Rule:** Divide the interest by the product of the rate and principal, the quote is the time: thus,  $t = \frac{n}{rp}$ .

**Example:** The rate .05l. principal 85l. interest 20l. 3s. 9d. or 20.1875l. the time is 4.75 years, or 4  $\frac{3}{4}$  years. Thus,  $4.75 = \frac{20.1875}{85 \times .05}$ , or  $\frac{20.1875}{4.25}$ .

**Demonstration:** This rule is deduced from the former; thus, since  $n = tpr$ , then dividing both sides by  $rp$ , it is  $\frac{n}{rp} = t$ .

**Prob. III.** Having the principal, interest, and time, to find the rate.

**Rule:** Divide the interest by the product of principal and time, the quote is the rate: thus,  $r = \frac{n}{tp}$ .

**Example:**  $n = 20.1875l.$   $t = 4.75$  years,  $p = 85l.$  then is  $r = .05l. = \frac{20.1875}{4.75 \times 85}$ , or  $\frac{20.1875}{403.75}$ .

**Demonstration:** Since  $n = tpr$ , divide both by  $tp$ ; it is  $\frac{n}{tp} = r$ .

**Prob. IV.** Having the rate, time and interest, to find the principal.

**Rule:** Divide the interest by the product of rate and time, the quote is the principal; thus,  $p = \frac{n}{tr}$ .

**Example:**  $n = 20.1875l.$   $t = 4.75$  years,  $r = .05l.$  then is  $p = 85l. = \frac{20.1875}{4.75 \times .05}$ , or  $\frac{20.1875}{.2375}$ .

**Demonstration:** Since  $n = tpr$ , divide both sides by  $tr$ , the quote is  $\frac{n}{tr} = p$ .

**Scholium:** If the interest of any sum for any time is added to the principal, this total or sum is called the amount, (viz. of the principal and its interest for that time.) And then from these four things, viz. the amount, which we call  $a$ , the principal, the time, and

and rate, arise four problems; for having any three of these, the fourth may always be found. Thus,

Prob. V. Having the principal, time, and rate, to find the amount.

Rule: Find the interest by prob. I. add it to the principal, the sum is the amount.

Thus, by prob. I. the interest is  $ptr$ : therefore the amount is  $a=ptr+p$ . The reason is evident.

Note: Because  $ptr=rt \times p$ , and  $p=1 \times p$ ; therefore  $rt \times p + p = rt + 1 \times p = a$ . And so the rule may be expressed thus; To the product of the rate and time add unity, and multiply the sum by the principal, the product is the amount.

Example: What is the amount of 246l. principal in 2 years and  $\frac{1}{2}$ , or 2.5 years, the rate of interest being .05l? Answer  $246l. + 30.75l. = 276l. 15s.$  for the interest is  $246 \times .05 \times 2.5 = 30.75l.$  Or thus;  $.05 \times 2.5 = .125l.$  to which add 1, it is  $1 + .125l.$  which multiplied by 276, produces 276.75l.

Prob. VI. Given the principal, amount, and time, to find the rate.

Rule: Take the difference betwixt the principal and amount, and divide it by the product of the time and

principal, the quote is the rate: thus,  $r = \frac{a-p}{tp}$ .

Example: Suppose  $a=276.75l.$   $p=246,$   $t=2.5$  years; then is  $r=.05l. = \frac{276.75-246}{2.5 \times 246} = \frac{30.75}{615}$ .

Demonstration: Since by prob. V.  $a=trp+p$ , take  $p$  from both sides, it is  $a-p=trp$ ; then divide both by  $tp$ , it is  $\frac{a-p}{tp}=r$ .

Prob. VII. Given the amount, principal, and rate, to find the time.

Rule: Take the difference of the amount and principal, and divide it by the product of the principal and rate, the quote is the time: thus  $t = \frac{a-p}{rp}$ .

Example: Suppose  $a=276.75l.$   $p=246l.$   $r=.05$ ; then is  $t=2.5$  years  $= \frac{276.75l. - 246}{246 \times .05} = \frac{30.75}{12.3}$ .

Demonstration: In the last problem,  $a-p$  was equal to  $trp$ ; and dividing both by  $rp$ , it is  $\frac{a-p}{rp}=t$ .

Prob. VIII. Given the amount, rate, and time, to find the principal.

Rule: Add 1 to the product of the rate and time, and by that sum divide the amount, the quote is the

principal: thus,  $p = \frac{a}{rt+1}$ .

Example:  $a=276.75l.$   $r=.05l.$   $t=2.5$  years; then is  $p=246 = \frac{276.75}{2.5 \times .05 + 1} = \frac{276.75}{1.125}$ .

Demonstration: By prob. V. it is  $a=rt+1 \times p$ ; therefore dividing both sides by  $rt+1$ , it is  $\frac{a}{rt+1}=p$ .

Compound INTEREST, is that which is paid for any principal sum, and the simple interest due upon it for any

time, accumulated into one principal sum. Example: if 100l. is lent out for one year at 6l. and if at the end of that year the 6l. due of interest be added to the principal, and the sum 106l. be considered as a new principal bearing interest for the next year (or whatever less time it remains unpaid) this is called compound interest, because there is interest upon interest, which may go on by adding this second year's interest of 106l. to the principal 106l. and making the whole a principal for the next year.

Now, although it be not lawful to let out money at compound interest, yet in purchasing of annuities or pensions, &c. and taking leases in reversion, it is very usual to allow compound interest to the purchaser for his ready money; and therefore, it is very necessary to understand it.

Let therefore, as before,  $p$ =the principal put to interest;  $t$ =the time of its continuance;  $a$ =the amount of the principal and interest;  $R$ =the amount of 1l. and its interest for one year, at any given rate, which may be thus found.

*Viz.* 100 : 106 :: 1 : 1.06 = the amount of 1l. at 6 per cent. Or 100 : 105 :: 1 : 1.05 = the amount of 1l. at 5 per cent. And so on, for any other assigned rate of interest.

Then if  
 $R$  = amount of 1l. for 1 year, at any rate.  
 $R^2$  = amount of 1l. for 2 years.  
 $R^3$  = amount of 1l. for 3 years.  
 $R^4$  = amount of 1l. for 4 years.  
 $R^5$  = amount of 1l. for 5 years.

Here  $t=5$ . For 1 :  $R$  ::  $R$  :  $RR$  ::  $RR$  :  $RRR$  ::  $RRR$  :  $R^4$  :  $R^4$  :  $R^5$  : &c. in a geometrical progression continued; that is, as 1l. : is to the amount of 1l. at 1 year's end : so is that amount : to the amount of 1l. at 2 years end, &c. Whence it is plain, that compound interest is grounded upon a series of terms, increasing in geometrical proportion continued; wherein  $t$  (*viz.* the number of years) does always assign the index of the last and highest term, *viz.* the power of  $R$ , which is  $R^t$ .

Again, as 1 :  $R^t$  ::  $p$  :  $pR^t = a$  the amount of  $p$  for the time, that  $R^t$  = the amount of 1l. That is, as 1l. : is to the amount of 1l. for any given time :: so is any proposed principal, or sum : to its amount for the same time.

From what has been said, we presume, the reason of the followings theorems will be very easily understood.

Theorem I.  $pR^t = a$ , as above.

From hence the two following theorems are easily deduced.

Theorem II.  $\frac{a}{R^t} = p$ .

Theorem III.  $\frac{a}{p} = R^t$ .

By these three theorems, all questions about compound interest may be truly resolved by the pen only, *viz.* without tables: though not so readily as by the help of tables calculated on purpose.

Example

**Example I.** What will 256l. 10s. amount to in 7 years, at 5 per cent. per annum, compound interest?

Here is given  $p=256\ 5$ ,  $t=7$ , and  $R=1.05$ , which being involved until its index  $=t$  (*viz.* 7) will become  $R^7=1.40710$ . Then  $1.40710 \times 256.5 = 360.92115 = a = 360\text{l. } 18\text{s. } 5\text{d.}$  which is the answer required.

**Example II.** What principal or sum of money must be put out to raise a stock of 360l. 18s. 5d. in seven years, at 5 per cent. per annum, compound interest.

Here is given  $a=360.92115$ ,  $R=1.05$  and  $t=7$  to find  $p$  by theorem II. Thus  $R^7=1.40710$  ( $360.92115 = a$ )  $256.5 = p$ . That is,  $p=256\text{l. } 10\text{s.}$  which is the sum or principal required.

**Example III.** In what time will 256l. 10s. raise a stock of (or amount to) 360l. 18s. 5d. allowing 5 per cent. per annum, compound interest?

Here is given  $p=256\ 5$ ,  $a=360.92115$ ,  $R=1.05$ .

To find  $t$  by theorem III.  $R^t = \frac{a}{p} = \frac{360.92115}{256}$

$1.40710$ . which being continually divided by  $R=1.05$  until nothing remain, the number of those divisions will be  $=7=t$ .

Thus  $1.05$   $1.40710$  ( $1.3400$ , and  $1.05$ ) ( $1.3400$ )  $1.2762$ , and  $1.05$  ( $1.2762$ )  $1.2155$ , and so on until it becomes  $1.05$   $1.05$  ( $1$ . which will be at the seventh division.

Therefore it will be  $t=7$ , the number of years required by the question.

**INTERJECTION**, in grammar, an indeclinable part of speech, signifying some passion or emotion of the mind. See GRAMMAR.

**INTERIM**, a name given to a formulary, or kind of confession of the articles of faith, obtruded upon the Protestants after Luther's death by the emperor Charles V. when he had defeated their forces; so called because it was only to take place in the interim (mean time) till a general council should have decided all points in dispute between the Protestants and Romanists. It retained most of the doctrines and ceremonies of the Romanists, excepting that of marriage, which was allowed to priests, and communion to the laity under both kinds. Most of the Protestants rejected it. There were two other interims, one of Leipsic, the other of Franconia.

**INTERLOCUTOR**, in Scots law. The sentence or judgment of a court of law, is commonly called an interlocutor before decree is extracted.

**INTERLOPERS**, are properly those who, without due authority, hinder the trade of a company or corporation lawfully established, by dealing in the same way.

**INTERLUDE**, an entertainment exhibited on the theatre between the acts of a play, to amuse the spectators while the actors take breath and shift their dresses, or to give time of changing the scenes and decorations.

**INTERMITTENT**, or **INTERMITTING FEVERS**, such fevers as go off and soon return again, in opposition to those which are continual. See MEDICINE.

**INTEROSSEUS**, in anatomy. See ANATOMY, p. 202.

**INTERPOLATION**, among critics, denotes a spurious passage inserted into the writings of some ancient author.

**INTERREGNUM**, the time during which the throne is vacant in elective kingdoms; for in such as are hereditary, like ours, there is no such thing as an interregnum.

**INTERREX**, the magistrate who governs during an interregnum.

**INTERMENT**. See BURIAL.

**INTERROGATION**, or *Point of INTERROGATION*, in grammar, a character of this form (?) serving to denote a question.

**INTERVAL**, in music, the difference between two sounds, in respect of acute and grave; or, that imaginary space terminated by two sounds, differing in acuteness or gravity.

**INTESTATE**, in law, a person that dies without making a will.

**INTESTINES**, in anatomy. See ANATOMY, p. 259.

**INTESTINAL**, something belonging to or seated in the intestines.

**INTRIGUE**, or **INTRIGUE**, an assemblage of events or circumstances, occurring in an affair, and perplexing the persons concerned in it.

In this sense, it is used to signify the nodus or plot of a play or romance; or that point wherein the principal characters are most embarrassed, through the artifice and opposition of certain persons, or the unfortunate falling out of certain accidents and circumstances.

**INTRINSIC**, a term applied to the inner, real, and genuine values, properties, &c. of any thing, in opposition to their extrinsic or apparent values, &c.

**INTRUSION**, in Scots law. See EJECTION.

**INTUITION**, among logicians, the act whereby the mind perceives the agreement or disagreement of two ideas, immediately by themselves, without the intervention of any other; in which case, the mind perceives the truth as the eye doth the light, only by being directed towards it.

**INVECTED**, in heraldry, denotes a thing fluted or furrowed.

Invected is just the reverse of ingrailed, in which the points are turned outward to the field; whereas in invected they are turned inward to the ordinary, and the small semicircles outward to the field. See Plate CII fig. 2.

**INVECTIVE**, in rhetoric, differs from reproof, as the latter proceeds from a friend, and is intended for the good of the person reproofed; whereas the invective is the work of an enemy, and entirely designed to vex and give uneasiness to the person against whom it is directed.

**INVENTION**, denotes the act of finding any thing new, or even the thing thus found.

**INVERARY**, a parliament town of Scotland, in the county of Argyll, of which it is the capital, situated in Lochfin, forty five miles north-west of Glasgow: W. long. 5° N. lat. 56° 25'.

**INVERNESS**, a parliament and port-town of Scotland, the capital of the county of Inverness, situated at the mouth of the river Ness: W. long. 4° N. lat. 57° 45'.

INVERUR,

**INVERSE**, is applied to a manner of working the rule of three. See **ARITHMETICK**, p. 383.

**INVERURY**, a parliament-town of Scotland, in the county of Aberdeen, situated on the river Don, ten miles west of Aberdeen.

**INVESTIGATION**, properly denotes the searching or finding any thing out by the tracks or prints of the feet; whence mathematicians, schoolmen, and grammarians, come to use the term in their respective researches.

**INVESTITURE**, in Scots law, the writings which constitute a proper feudal right. See **LAW**, tit. 10.

**INULA**, in botany, a genus of the syngenesia polygamia superflua class. The receptacle is naked; the pappus is simple; and the antheræ terminate at the base in two bristles. There are 22 species, 4 of them natives of Britain, *viz.* the helenium, or elecampane; the dysenterica, or middle flea-bane; the pulicaria, or small flea-bane; and the erithmoides, or golden sampire. The root of the elecampane is said to excite urine, and loosen the belly.

**INVOCATION**, in theology, the act of adoring God, and especially of addressing him in prayer for his assistance and protection.

**INVOICE**, an account in writing of the particulars of merchandize, with their value, custom, charges, &c. transmitted by one merchant to another in a distant country. See **BOOK-KEEPING**, p. 618.

**INVOLUCRUM**, among botanists. See **BOTANY**, p. 637.

**INVOLUTION**, in algebra. See **ALGEBRA**, p. 84.

**JOACHIMITES**, in church-history, the disciples of Joachim a cistercian monk, who was an abbot of Flora in Calabria, and a great pretender to inspiration.

The Joachimites were particularly fond of certain ternaries: the Father, they said, operated from the beginning till the coming of the Son; the Son, from that time to theirs, which was the year 1260; and from that time the Holy Spirit was to operate in his turn. They also divided every thing relating to *mn*, to doctrine, and the manner of living, into three classes, according to the three persons in the Trinity.

**JOANNA**, one of the islands of Comoro, situated between the north-west part of Madagascar and Zanguebar, in Africa: E. long. 45°, S. lat. 12°.

**JOB**, or *Book of Job*, a canonical book of the Old Testament, containing a narrative of a series of misfortunes which happened to a man whose name was Job, as a trial of his virtue and patience; together with the conferences he had with his cruel friends, on the subject of his misfortunes, and the manner in which he was restored to ease and happiness. This book is filled with those noble, bold, and figurative expressions, which constitute the very soul of poetry.

Many of the Jewish rabbins pretend that this relation is altogether a fiction: others think it a simple narrative of a matter of fact, just as it happened: while a third sort of critics acknowledge, that the groundwork of the story is true, but that it is wrote in a poetical strain, and decorated with peculiar circumstances, to render the narration more profitable and entertaining.

The time is not set down in which Job lived. Some

have thought that he was much ancients than Moses, because the law is never cited by Job or his friends, and because it is related that Job himself offered sacrifices. Some imagine that this book was wrote by himself; others say, that Job wrote it originally in Syriac or Arabic, and that Moses translated it into Hebrew: but the rabbins generally pronounce Moses to be the author of it, and many Christian writers are of the same opinion.

**JOBBER**, in law, a person that buys and sells cattle for others. Hence stock jobbers are persons who buy and sell stocks for other persons.

**IOGUIS**, among the East-Indians, a kind of hermits, who generally stand under trees, or near their pagods. Some of them go stark naked, holding their arms across over their heads, and continue in that posture all their lives: others lie on the ground, with one leg higher than the other, and their arms raised above their head; and these wretched penitents insensibly lose the use of their arms and legs: some confine themselves in cages, set on the top of a thick stake, fixed in the ground; and these cages are so small, that they put the penitent to prodigious torture: some holding a sabre in one hand, and a kind of shield in the other, go up a kind of crane, where hooking themselves to an iron, which runs a considerable way into their backs, they spring forward into the air, flourishing their sabres, and launching out into extravagant praises of their idols: and others plunge into the Ganges, in hopes of being devoured by a crocodile, fancying that by this means they shall obtain the happiness of the next life.

These miserable wretches are considered by the Indians as perfect models of piety and holiness: they are followed by persons of both sexes, who make a vow of devoting themselves to their service, and are wholly employed in soothing their voluntary sufferings by offering them alms and refreshments. They call the pious to their devotions by ringing a little bell; and when they hold their spiritual conversations, they sit close in a ring, and set up a banner, made of several pieces of stuff, fastened at the end of a stick.

**JOHN**, or *Gospel of St. JOHN*, a canonical book of the New Testament, containing a recital of the life, actions, doctrine, and death of our Saviour Jesus Christ, written by St. John the apostle and evangelist.

St. John wrote his Gospel at Ephesus, after his return from the isle of Patmos, at the desire of the Christians of Asia. St. Jerom says, he would not undertake it, but on condition they shall appoint a public fast, to implore the assistance of God; and that the fast being ended, St. John, filled with the Holy Ghost, broke out into these words, "In the beginning was the word," &c. The ancients assign two reasons for this undertaking: the first is, because, in the other three gospels, there was wanting the history of the beginning of Jesus Christ's preaching, till the imprisonment of John the Baptist; which, therefore, he applied himself particularly to relate. The second reason was, in order to remove the errors of the Corinthians, Ebionites, and other sects.

St

**St. JOHN'S DAY**, the name of two Christian festivals, one observed on June 24, kept in commemoration of the wonderful circumstances attending the birth of St. John the Baptist; and the other on Dec. 27, in honour of St. John the Evangelist.

**St. JOHN'S WORT.** See **HYPERICUM**.

**St. JOHN'S**, in geography, one of the Philippine islands, situated in 126° E. lon. and 7° N. lat.

**St. JOHN'S**, is also an island in the bay of St. Lawrence, situated north of New Scotland: W. lon. 65°, N. lat. 47°.

**JOINERY**, the art of working in wood, or of fitting various pieces of timber together.

It is called by the French *menuiserie*, *q. d.* small work, to distinguish it from carpentry, which is employed about large and less curious works.

**JOINT**, in general, denotes the juncture of two or more things.

The joints of the human body are called by anatomists articulations. See **ANATOMY**, p. 148.

**JOINTURE**, in law, generally signifies a settlement of lands and tenements, made on a woman in consideration of marriage.

**JOINVILLE**, a town of Champaign, in France, situated on the river Marne: E. lon. 5° 15', and N. lat. 48° 27'.

**JOISTS**, or **JOYSTS**, in architecture, those pieces of timber framed into the girders and summers, on which the boards of the floor are laid.

**JONAH**, or *Prophecy of JONAH*, a canonical book of the Old Testament; in which it is related, that Jonah was ordered to go and prophecy the destruction of the Ninevites; but that disobediently attempting a voyage another way, he was discovered by the rising of a sudden tempest, and cast into the sea; where he was swallowed up by a whale, which, having lodged him three days and three nights in his belly, disgorged him upon the shore; whereupon being sensible of his past danger and surprising deliverance, he betook himself to the journey and embassy to which he was appointed; and arriving at Nineveh, the metropolis of Assyria, he, according to his commission, boldly laid open to the inhabitants their sins and miscarriages, and proclaimed their sudden overthrow; upon which the whole city, by prayer and fasting, and a speedy repentance, happily averted the divine vengeance, and escaped the threatened ruin.

**IONIA**, anciently was a province of the Lesser Asia, or Natolia, bounded by Etolia on the north, Lydia on the east, Caria on the south, and the Archipelago on the west.

**IONIC ORDER.** See **ARCHITECTURE**, p. 352.

**IONIC DIALECT**, in grammar, a manner of speaking peculiar to the people of Ionia.

**IONIC SECT** was the first of the ancient sects of philosophers; the others were the Italic and Eleatic. The founder of this sect was Thales, who, being a native of Miletus in Ionia, occasioned his followers to assume the appellation of Ionic: Thales was succeeded by Anaximander, and he by Anaximenes, both of Miletus; Anaxagoras Clazomenius succeeded them, and

removed his school from Asia to Athens, where Socrates was his scholar. It was the distinguishing tenet of this sect, that water was the principle of all natural things.

**JONK**, or **JONQUE**, in naval affairs, is a kind of small ship, very common in the East Indies: these vessels are about the bigness of our fly-boats; and differ in the form of their building, according to the different methods of naval architecture used by the nations to which they belong. Their sails are frequently made of mats, and their anchors are made of wood.

**JOSHUA**, a canonical book of the Old Testament, containing a history of the wars and transactions of the person whose name it bears. This book may be divided into three parts; the first of which is a history of the conquest of the land of Canaan; the second, which begins at the twelfth chapter, is a description of that country, and the division of it among the tribes; and the third, comprised in the two last chapters, contains the renewal of the covenant he caused the Israelites to make, and the death of their victorious leader and governor. The whole comprehends a term of seventeen, or, according to others, of twenty-seven years.

**JOURNAL**, or **DAY-BOOK.** See **BOOK KEEPING**, p. 583

**JOURNAL**, at sea. See **NAVIGATION**.

**JOURNAL** is also a name common for weekly essays, news-papers, &c. as the Gray's Inn Journal, the Westminster Journal, the Edinburgh Weekly Journal, &c.

**JOURNEYMAN**, properly one who works by the day only; but it is now used for any one who works under a master, either by the day, the year, or the piece.

**IPECACUANHA**, in the materia medica, a West-indian root, of which there are two kinds, distinguished by their colour, and brought from different places, but both possessing the same virtues, though in a different degree. The one is grey, and brought from Peru; the other is brown, and is brought from the Brazils: and these are indifferently sent into Europe under the general name of ipecacuanha.

These two sorts have been by some supposed to be the roots of two different plants: but this is a mistake; the only difference is, that one grows in a different place, and in a richer and moister soil, and is better supplied with juices than the other.

Ipecacuanha is an excellent, mild, and safe emetic; it is also a noble restraining; and, given in doses too small to vomit, is the greatest of all remedies for a dysentery. Small doses of ipecacuanha, are an excellent remedy in diarrhoeas of a more simple kind; and in the fluxus albus we hardly know a better medicine.

**I POMÆA**, in botany, a genus of the pentandria monogynia class. The corolla is funnel shaped; the stylum is globular; and the capsule has three cells. There are eighteen species, none of them natives of Britain.

**IPSWICH**, a borough and port town of Suffolk, situated on the river Orwel, twenty-four miles south east of Bury.

It sends two members to parliament.

**IRELAND**, an island of the Atlantic ocean, subject to Great Britain, situated between  $5^{\circ}$  an  $10^{\circ}$  W. long. and between  $51^{\circ}$  and  $56^{\circ}$  N. lat. being bounded by the Northern ocean on the north, by St. George's channel, which divides it from Great Britain, on the east, and by the Atlantic and Western ocean on the south and west. This country is two hundred and fifty miles long, and one hundred and fifty broad; distant from Holyhead in north Wales fifty miles, and from Galloway in Scotland fifteen miles. It is divided into four large provinces, *viz.* Ulster on the north, Leinster on the east, Munster on the south, and Connaught on the west.

**IRIS**, the RAINBOW. See OPTICS.

**IRIS**, in anatomy. See ANATOMY, p. 289.

**IRIS**, the FLOWER-DE LUCE, in botany, a genus of the triandria monogynia class. The corolla consists of six divisions, alternately reflected: the stigmata have the appearance of petals. There are twenty-two species, only two of which are natives of Britain. *viz.* the pseudacorus, or yellow flower-de-luce; and the foetidissima, or stinking gladdon. The root is cathartic, and recommended in dropsies.

**IRON**. See CHEMISTRY, p. 82.

**IRON-SICK**, in the sea-language, is said of a ship or boat, when her bolts or nails are so eaten with rust, and so worn away, that they occasion hollows in the planks, whereby the vessel is rendered leaky.

**IRON-WORM**, in botany. See SIDERITIS.

**IRONY**, in rhetoric, is when a person speaks contrary to his thoughts, in order to add force to his discourse; whence Quintilian calls it *diversifiloquium*.

**IROQUOIS**, the name of five nations in North America, in alliance with the British colonies. They are bounded by Canada on the north, by the British plantations of New-York and Pennsylvania on the east and south, and by the lake Ontario on the west.

**IRRADIATION**, the act of emitting subtile effluvia, like the rays of the sun, every way.

**IRTIS**, a great river, which runs from north to south through Russia, falls into the river Oby, and makes part of the boundary between Asia and Europe.

**IRWIN**, a port-town of Scotland, in the bailiwick of Cunningham, situated at the mouth of the river Irwin, on the frith of Clyde: W. long.  $4^{\circ} 40'$ , N. lat.  $55^{\circ} 35'$ .

**ISABELLA**, a fortress of the Austrian Netherlands, situated on the west side of the river Schield, opposite to Antwerp: in E. long.  $4^{\circ} 10'$ , N. lat.  $51^{\circ} 15'$ .

**ISAIAH**, or *Prophecy of ISAIAH*, a canonical book of the Old Testament. Isaiah is the first of the four greater prophets, the other three being Jeremiah, Ezekiel, and Daniel. This prophet was of royal blood, his father Amos being brother to Azariah king of Judah. The style of this prophet is noble, sublime and florid. Grotius calls him the Demosthenes of the Hebrews. He had the advantage, above the other prophets, of improving his diction by conversing with men of the greatest parts and elocution; and this added a sublimity, force, and majesty to what he said. He impartially reprov'd the vices of the age in which he

lived, and openly displayed the judgments of God that were hanging over the Jewish nation: at the same time denouncing vengeance on the Assyrians, Egyptians, Ethiopians, Moabites, Edomites, Syrians, and Arabians, who were instrumental in inflicting those judgments. He foretold the deliverance of the Jews from their captivity in Babylon, by the hands of Cyrus king of Persia, an hundred years before it came to pass; but the most remarkable of his predictions are those concerning the Messiah, in which he not only foretold his coming in the flesh, but all the great and memorable circumstances of his life and death.

**ISATIS**, in botany, a genus of the tetradynamia siliquosa class. The pod is lanceolated, has two valves, and contains but one seed. There are four species, only one of which, *viz.* the tinctoria, or woad, is a native of Britain. It is used by the dyers. See BOTANY, p. 634.

**ISCHÆMUM**, SCHOENANTH, in botany, a genus of the polygamia monœcia class. The calix of the hermaphrodite is a glume containing two flowers; the corolla consists of two valves; it has three stamina, two styli, and one seed. The calix, & c. of the male are the same with those of the hermaphrodite. There are two species, both natives of the East Indies.

**ISCHIUM**, in anatomy. See ANAT. p. 172.

**ISCHURY**, in medicine, a disease consisting in an entire suppression of urine. See MEDICINE.

**ISENACH**, a town of Germany in the circle of Upper Saxony, situated in E. long.  $10^{\circ} 12'$ , N. lat.  $51^{\circ}$ .

**ISENARTS**, a town of Germany, in the circle of Austria, and dukedom of Stiria, situated thirty five miles north-west of Gratz.

**ISERNIA**, a town of Naples, in the province of Molise, situated in E. long.  $15^{\circ} 15'$ , N. lat.  $41^{\circ} 36'$ .

**ISH**, in Scots law, signifies *expiry*: thus we say, The ish of a lease. It signifies also *to go out*: thus we say, Free ish and entry from and to any place.

**ISIA**, feasts and sacrifices anciently solemnized in honour of the goddess Isis.

The Isia were full of abominable impurities, and for that reason those who were initiated were obliged to take an oath of secrecy: they held for nine days successively; but were so abominable, that the senate abolished them at Rome, under the consulship of Piso and Gabinius.

**ISINGLASS**. See ICHTHYOCOLLA.

**ISLAND**, a tract of dry land, encompassed with water; in which sense it stands contradistinguished from continent, or terra firma.

**ISLE DE DIEU**, an island in the bay of Biscay, on the coast of France, situated fourteen miles west of the coast of Poitou.

**ISLE of France**, a province of that kingdom, in which the capital city of Paris is situated, being bounded by Picardy on the north, by Champain on the east, by Orleans on the south, and by Normandy on the west.

**ISNARDIA**, in botany, a genus of the tetrandria monogynia class. It has no corolla; the calix consists of four divisions; and the capsul has four cells. There is but one species, a native of France.

ISNY,

**ISNY**, a free imperial city of Germany, in the circle of Swabia, situated in E. long.  $10^{\circ}$ , N. lat.  $47^{\circ} 36'$ .

**ISOCHRONAL**, is applied to such vibrations of a pendulum, as are performed in the same space of time as all the vibrations or swings of the same pendulum are, whether the arches it describes be longer or shorter.

**ISOCHRONAL LINE**, that in which a heavy body is supposed to descend without any acceleration.

**ISOLA**, a port town and bishop's see of the hither Calabria, fifteen miles south of St Severino.

**ISOPERIMETRICAL FIGURES**, in geometry, are such as have equal perimeters or circumferences.

**ISOPYRUM**, in botany, a genus of the polyandria polygynia class. It has no calix; the petals are five or more; the nectarium is bilabiated, and tubular; and the capsule contains many seeds. There are three species, none of them natives of Britain.

**ISOCELES TRIANGLE**, in geometry, one that has two equal sides.

**ISPAHAN**, or **SPAHAWN**, the capital city of Eyrac Agem, and of all Persia: it is of an oval form, and twelve miles in circumference: E. lon.  $50^{\circ}$ , N. lat.  $32^{\circ} 30'$ .

**ISPIDA**, in ornithology. See **ALCEDO**.

**ISSUES**, in surgery, are little ulcers made designedly by the surgeon in various parts of the body, and kept open by the patient, for the preservation or recovery of his health. See **SURGERY**.

**ISTHMA**, or **ISTHMIAN GAMES**, one of the four solemn games which were celebrated every fifth year in Greece; so called from the Corinthian isthmus, where they were kept.

**ISTHMUS**, in geography, a narrow neck of land, that joins two continents, or joins a peninsula to the terra firma, and separates two seas,

**ISTRIA**, a peninsula in the north part of the gulph of Venice, bounded by Carniola on the north; and on the south, east, and west, by the sea.

**ITALIAN**, the language spoken in Italy.

**ITALY**, a country situated between seven and nineteen degrees east long. and between thirty-eight and forty-seven degrees north latitude, bounded by Switzerland, and the Alps, which separate it from Germany, on the north; by the gulph of Venice, on the east; by the Mediterranean sea, on the south; and by the same sea and the Alps, which separate it from France, on the west; and if we include Savoy, which lies indeed on the west side of the Alps, between Italy and France, we must extend it a degree farther west: this is usually described, however, with Italy, as it is contiguous to Piedmont, and has the same sovereign, being a province of the king of Sardinia's dominions. Italy is said to resemble a boot, and is in length from north-west to south-east 600 miles; the breadth is very unequal; in the north, which may be called the top of the boot, it is about 400 miles broad from east to west; in the calf of the leg, or middle, it is about 120 miles broad; and towards the south, about the instep, eighty miles broad; and comprehends the following countries or subdivisions. 1. In the north are

the duchies of Savoy, Piedmont, and Montferrat; the territories of Genoa; the duchies of Milan, Mantua, Parma, Modena, and the territories of Venice. 2. In the middle of Italy, are the duchy of Tuscany, the pope's dominions, and the state of Lucca. 3. And in the south is the kingdom of Naples.

**ITCH**, a cutaneous disease, arising from a corruption of a ferous lymphatic matter, sometimes attended with mild, sometimes with more obstinate and dangerous symptoms. See **MEDICINE**.

**JUBILEE**, a time of public and solemn festivity among the ancient Hebrews.

This was kept every fiftieth year: it began about autumnal equinox, and was proclaimed by the found of trumpet throughout all the country. At this time all slaves were released, all debts annihilated, and all lands, houses, wives, and children, however alienated, were restored to their first owners. During this whole year a'l kind of agriculture was forbidden, and the poor had the benefit of the harvest, vintage, and other productions of the earth, in the same manner as in the sabbatic or seventh year. As this was designed to put the Israelites in mind of their Egyptian servitude, and to prevent their imposing the like upon their brethren, it was not observed by the Gentile profelytes.

The Christians, in imitation of the Jews, have likewise established jubilees, which began in the time of pope Boniface VIII. in the year 1300, and are now practised every twenty-five years; but these relate only to the pretended forgiveness of sins, and the indulgences granted by the church of Rome; together with the privilege of performing a thousand frolics in masquerade.

**JUCATAN**, or **YUCATAN**, a peninsula of Mexico, situated between  $89^{\circ}$  and  $94^{\circ}$  W. long. and between  $16^{\circ}$  and  $21^{\circ}$  N. lat.

**JUDAISM**, the religious doctrines and rites of the Jews. See **Jews**.

**JUDE**, or *the general epistle of JUDE*, a canonical book of the New Testament, written against the heretics, who, by their disorderly lives and impious doctrines, corrupted the faith and good morals of the Christians. St Jude draws them in lively colours, as men given up to their passions, full of vanity, conducting themselves by worldly wisdom, and not by the spirit of God.

**JUDEA**. See **PALESTINE**.

**JUDENBURGH**, a city of Stiria, in Germany: E. long.  $15^{\circ}$ , N. lat.  $47^{\circ} 22'$ .

**JUDGE**, a chief magistrate of the law, appointed to hear causes, to explain the laws, and to pass sentence.

*Book of JUDGES*, a canonical book of the Old Testament, so called from its relating the state of the Israelites under the administration of many illustrious persons who were called judges, from their being both the civil and military governors of the people, and who were raised up by God upon special occasions, after the death of Joshua, till the time of their making a king. In the time of this peculiar polity, there were several remarkable occurrences, which are recorded in this book: It acquaints us with the gross impiety of a new generation which sprung up after the death of Jo-

shua,



- shua, and gives us a short view of the dispensations of heaven towards this people, sometimes relieving and delivering them, and at others severely chastising them by the hands of their enemies.
- JUDGMENT**, among logicians, a faculty or rather act of the human soul, whereby it compares its ideas, and perceives their agreement or disagreement.
- JUDGEMENT**, in law, the sentence of the judges upon a suit, &c.
- JUDOIGEN**, a town of the Austrian Netherlands, in the province of Brabant, situated on the river Gheet, thirteen miles south-east of Louvain, and sixteen north of Namur.
- IVES**, or **St. Ives**, a borough and port-town of Cornwall, situated on the Irish channel: it sends two members to parliament: W. long. 6°, N. lat. 50° 18'.
- JUGERUM**, in Roman antiquity, a square of 120 Roman feet; its proportion to the English acre being as 10000 to 16097.
- JUGULAR**, in anatomy, an appellation given to two veins of the neck, which arise from the subclavians. See **ANATOMY**, part IV.
- IVICA**, or **YVICA**, the capital of an island of the same name, fifty miles east of Valencia in Spain: E. long. 1°, N. lat. 39°.
- JUICE**, denotes the sap of vegetables, or the liquors of animals.
- JUJUBES**, in the materia medica, the name of a fruit of the pulpy kind, produced on a tree which Linnæus makes a species of rhamnus. See **RHAMNUS**.  
The jujubes have been made a general ingredient in pectoral decoctions; but they are now seldom used on these occasions, and are scarce at all heard of in prescription, or to be met with in our shops.
- JULEP**, in pharmacy, a medicine composed of some proper liquor, and a syrup or sugar of extemporaneous preparation, without decoction, designed for the concoction or alteration of the humours, or restoring the strength.
- JULIAN**, or **St. JULIAN**, a harbour on the coast of Patagonia, in South America, where ships bound to the south seas usually touch: W. long. 74°, N. lat. 48° 15'.
- JULIAN PERIOD**, in chronology. See **ASTRONOMY**, p. 489.
- JULIERS**, the capital of the duchy of the same name, situated on the river Roer, twenty miles west of Cologne, and as many east of Maastricht: E. long. 6°, N. lat. 50° 55'.
- JULPHA**, or *Old JULPHA*, once the capital of Armenia, but now in ruins, the inhabitants being transplanted to a town within a mile of Ispahan, called New Julpha, and there they carry on a foreign trade with all countries in Asia. The situation of Old Julpha was in E. long. 46°, N. lat. 39°.
- JULY**, in chronology, the seventh month of the year, so called in honour of Julius Cæsar; before whose time it was known by the name of quintilis, as being the fifth month of the old Roman year.
- JUNCUS**, the **RUSH**, in botany, a genus of the hexan-
- dria monogynia class. The calix has six leaves; it has no corolla; and the berry is dry, and contains but one seed. There are 19 species, twelve of them natives of Britain.
- JUNGERMANNIA**, a genus of the cryptogamia algæ class. Of which there are 29 species, all natives of Britain.
- JUNIPERUS**, in botany, a genus of the diœcia monadelphica class. The male has no corolla, but has three stamina; the calix of the female consists of three parts; it has three petals, and three styli; and the berry contains three seeds. There are nine species, only one of which, *viz.* the communis or common juniper, is a native of Britain. The berries are used as carminatives and stomachics.
- JUNK**, in the sea-language, old cables cut into short pieces, and given to boatswains for making swabs, plats, and nippers; as also to the ship carpenters, and to poor people, to be picked into oakum, for caulking ships, &c.
- JUNTO**, in matters of government, denotes a select council for taking cognizance of affairs of great consequence, which require secrecy.  
In Spain and Portugal, it signifies much the same with convention, assembly, or board among us: thus we meet with the junto of the three estates, of commerce, of tobacco, &c. See **BOARD**, &c.
- IVORY**, in natural history, &c. a hard, solid and firm substance, of a white colour, and capable of a very good polish. It is the tusk of the elephant, (See **ELEPHAS**,) and is hollow from the base to a certain height, the cavity being filled up with a compact medullary substance, seeming to have a great number of glands in it. It is observed, that the Ceylon ivory, and that of the island of Achem, do not become yellow in the wearing, as all other ivory does; for this reason the teeth of these places bear a larger price than those of the coast of Guinea.
- JUPITER**, in astronomy. See **ASTRONOMY**, p. 441.
- JUREA**, or **JURA**, a strong city in Italy, in the province of Piedmont, situated on the river Doria, subject to the king of Sardinia: E. long. 7°, 36'; N. lat. 45°, 22'.
- JURISPRUDENCE**, the science of what is just or unjust; or the knowledge of laws, rights, customs, statutes, &c. necessary for the administration of justice.
- JURY-MAST**, whatever is set up in room of a mast that has been lost in a storm or in an engagement, and to which a lesser yard, ropes, and sails, are fixed.
- JUS DELIBERANDI**, in Scots law, that right which an heir has, by law, of deliberating for a certain time whether he will represent his predecessor. See **LAW**, tit. 27.
- JUS DEVOLUTUM**, in Scots law, the right of the church, of presenting a minister to a vacant parish, in case the patron shall neglect to use that right within the time limited by law. See **LAW**, tit. 5.
- JUS MARITI**, in Scots law, the right the husband acquires to his wife's moveable estate, in virtue of the marriage. See **LAW**, tit. 6.
- JUS RELICTÆ**, in Scots law, the right the wife has in the

the goods in communion, in case of the previous decease of the husband. See LAW, tit. 28.

**JUS PREVENTIONIS**, in Scots law, the preferable right of jurisdiction acquired by a court, in any cause to which other courts are equally competent, by having exercised the first act of jurisdiction. See LAW, tit. 2.

**JUST**, a sportive combat on horseback, man against man, armed with lances.

The difference between jousts and tournaments, according to Du Cange, consists in this, that the latter is a genus of which the former is only a species. Tournaments included all kinds of military sports and engagements, which were made out of gallantry and diversion. Jousts were those particular combats, where the parties were near each other, and engaged with lance and sword.

**JUSTICE**, in a moral sense, is one of the four cardinal virtues; which gives every person his due.

**JUSTICE**, in a legal sense, a person deputed by the king to administer justice to his subjects, whose authority arises from his deputation, and not by right of magistracy.

**JUSTICE-SEAT**, is the highest forest-court, always held before the lord chief justice in eyre of the forest; in which court fines are set for offences, and judgments given.

**JUSTICIA**, in botany, a genus of the diandria monogynia class. The corolla is ringent; and the capsule has two cells. There are 19 species, none of them natives of Britain.

**JUSTICIAR**, in the old English laws, an officer instituted by William the Conqueror, as the chief officer of state, who principally determined in all cases civil and criminal. He was called in Latin *Capitalis Justiciarius totius Angliæ*.—For **JUSTICIAR** in Scotland, see LAW, tit. 3. § 13.

**JUSTICIARY**, or *Court of JUSTICIARY*, in Scotland. See LAW, tit. 3. § 10.

**JUTES**, the ancient inhabitants of Jutland, in Denmark.

**JUTLAND**, a peninsula of Denmark, anciently called the Cimbrian Chersonese, situated between 8° and 11° of E. long. and between 55° and 58° of N. lat. bounded by the Categate sea, which separates it from Norway, on the north; by the same sea, which divides it from the Danish islands and Sweden, on the east; by Holstein, on the south; and by the German ocean, on the west. It is divided into north and south Jutland; the south being usually called Sleswic. The whole is about 180 miles in length, and 90 in breadth.

**IVY**, in botany. See **HEDERA**.

**IXIA**, in botany, a genus of the triandria monogynia class. The corolla consists of six open equal petals; and it has three erect stigmata. There are ten species, none of them natives of Britain.

**IXORA**, in botany, a genus of the tetrandria monogynia class. The corolla consists of one long funnel-shaped petal; and the berry contains four seeds. There are three species, none of them natives of Britain.



K.

K E D

**KÆMPFERIA**, in botany, a genus of the monandria monogynia class. The corolla consists of six segments, three of them being large and open. There are two species, both natives of India. The root of this plant is the galangal, which was formerly used in bitter infusions, but is now neglected in practice.

**KAKENHAUSEN**, a city of Livonia, subject to Russia: E. long. 26°, N. lat. 57°.

**KALI**, in botany. See **SALSOLA**.

**KALLO**, a town of upper Hungary, situated in a lake twenty miles south east of Tockay.

**KAOLIN**, one of the substances whereof china-ware is made; being no other than a kind of talc reduced to powder, and made into a paste with water.

**KAUSBEUREN**, an imperial city of Germany, thirty-two miles south of Augsburg: E. long. 10° 45', N. lat. 47° 50'.

**KEBLA**, an appellation given by the Mahometans to that part of the world where the temple of Mecca is situated, towards which they are obliged to turn themselves when they pray.

**KEDGING**, in the sea-language, is when a ship is

K E E

brought up or down in a narrow river by means of the tide, the wind being contrary. To do this, they use to set their fore-course, or fore-top sail and mizzen, that so they may flat her about; and if she happens to come too near the shore, they let fall a kedje-anchor, with a hawser fastened to it from the ship, in order to turn her head about; which work is called kedging.

**KEEL**, the lowest piece of timber in a ship, running her whole length from the lower part of her stem to the lower part of her stern-post. Into it are all the lower futtocks fastened; and under part of it, a false keel is often used.

**KEELSON**, a principal timber in a ship, fayed within-side cros all the floor timbers; and being adjusted to the keel with suitable scarfs, it serves to strengthen the bottom of the ship.

**KEEPER of the great seal**, is a lord by his office, is styled lord keeper of the great seal of Great-Britain, and is always one of the privy council. All grants, charters and commissions of the king under the great seal, pass through the hands of the lord-keeper; for without that seal, many of those grants, &c. would be

be of no force; the king being, in the interpretation of the law, a corporation, and therefore passes nothing but by the great seal, which is also said to be the public faith of the kingdom, being in the highest esteem and reputation.

Whenever there is a lord-keeper, he is invested with the same place, authority, preeminence, jurisdiction, or execution of laws, as the lord chancellor of Great-Britain is vested with.

The lord-keeper is constituted by the delivery of the great seal, &c.

**KEEPER** of the *privy seal*, is also a lord by his office, through whose hands all grants, pardons, &c. pass before they come to the great seal, and even some things pass this officer's hands which do not pass the great seal at all. This officer is also one of the privy council, yet was anciently called clerk of the privy seal. His duty is to put the seal to no grant, &c. without a proper warrant; nor with warrant where it is against law, or inconvenient, but shall first acquaint the king therewith.

**KEISER WAERT**, a strong town of Germany in the circle of Westphalia and duchy of Berg, situated on the Rhine, twenty-five miles north of Cologne, E. lon.  $6^{\circ} 8'$ , N. lat.  $51^{\circ} 20'$ .

**KELLINGTON**, a borough-town of Cornwall, thirteen miles south of Launceston, which sends two members to parliament.

**KELP**, a fixed salt, or particular species of pot-ash, procured by burning a species of *salicofa*. See *SALICOSA*.

**KELSO**, a town of Scotland, in the shire of Mers, or Roxburgh, situated on the north side the Tweed, twenty miles south-west of Berwick.

**KEMPTEN**, a city of Germany, in the circle of Swabia, situated on the river Iser: E. lon.  $10^{\circ} 7'$ , N. lat.  $47^{\circ} 38'$ .

**KENDAL**, a market-town of Westmoreland, twenty-two miles south-west of Appleby.

**KENKS**, in the sea language, doublings in a rope or cable, when banded in and out, so that it does not run easy; or when any rope makes turns or twists, and does not run free in the block, then it is said to make kenks.

**KENNING** *to a Terce*, in Scots law, the dividing or setting off that part of the husband's estate to his relief which she is entitled to life after his death. See *TERCE*.

**KENSINGTON**, a pleasant village in the county of Middlesex, two miles west of London; where is a royal palace, with large and fine gardens.

**KENT**, a county bounded by the river Thames on the north, by the ocean on the east, by Sussex and the Straits of Dover on the south, and by Surrey on the west.

**KERMAN**, the capital of the province of Kerman, or Carimania, in Persia: E. lon.  $56^{\circ} 30'$ , N. lat.  $30^{\circ}$ .

**KERMES** in botany. See *Ilex*.

**KERMES MINERAL**. See *CHEMISTRY*, p. 140.

**KERRY**, a county of Ireland, in the province of Munster, bounded by the river Shannon, which divides it from Clare, on the north; by Limeric and Cork, on

the east; by another part of Cork, on the south; and by the Atlantic Ocean, on the west.

**KESSEL**, a town of Upper Guelderland, in the quarter of Roermonde, situated on the river Meuse: E. lon.  $6^{\circ}$ , N. lat.  $51^{\circ} 25'$ .

**KESTRIL**, in ornithology. See *FALCO*.

**KETMIA**, in botany. See *HIBISCUS*.

**KETTERING**, a market-town of Northamptonshire, ten miles north-east of Northampton.

**KETCH**, in naval architecture, a vessel with two masts. See *SHIP*.

**KEVEL**, in ship-building, a piece of plank layed against the quickwork on the quarter-deck, in the shape of a semicircle; about which the running rigging is belaid.

**KEXHOLME**, the capital of the province of the same name in Finland, situated on the lake Ladoga, eighty miles north of Petersburg: E. lon.  $30^{\circ}$ , N. lat.  $61^{\circ} 30'$ .

**KEY**, a well known instrument for opening and shutting the locks of doors, chests, buroes, and the like.

**KEY**, in music, a certain fundamental note, or tone, to which the whole piece, be it in concerto, sonata, cantata, &c. is accommodated, and with which it usually begins, but always ends.

**KEY-STONE** of an arch, or vault, that placed at the top or vertex of an arch, to bind the two ~~swags~~ together.

**KIAM**, a great river of China, which, taking its rise near the west frontier, crosses the whole kingdom eastward, and falls into the bay or gulph of Nanking, a little below that city.

**KIAMSI**, a province of China, bounded by that of Nanking on the north, and by that of Canton on the south.

**KIDDERMINSTER**, a market-town twelve miles north of Worcester.

**KIDNEYS**, in anatomy. See *ANATOMY*, p. 268.

**KIGGELARIA**, in botany, a genus of the diocia decandria class. The calix of both male and female consists of five segments, and the corolla of five petals; the antheræ of the male are perforated at the apex: The female has five styli; the capsule has five valves, one cell, and many seeds. There is but one species, a native of Ethiopia.

**KIDDARE**, the capital of a county of the same name, in Ireland, twenty-seven miles south-west of Dublin.

**KILDERKIN**, a liquid measure, containing two firkins.

**KILKENNY**, a county of Ireland, in the province of Leinster, bounded by Queen's County, on the north; by the county of Wexford, on the east; by Waterford, on the south; and by the county of Tipperary, on the west. It is also the name of the capital of that county; and is situated in W. lon.  $7^{\circ} 15'$ , N. lat.  $52^{\circ} 20'$ .

**KIMBOLTON**, a market-town of Huntingdonshire, nine miles south-west of Huntingdon.

**KING**, in the general acceptation of the word, is a person who has a supreme authority, with the power of levying taxes, making laws, and enforcing an obedience to them: but in Britain, which is a limited monarchy.

monarchy, the power of the king is greatly restrained ; which is so far from diminishing his honour, that it adds a glory to his crown ; for while other kings are absolute monarchs over innumerable multitudes of slaves, the king of England has the distinguished glory of governing a free people, the least of whom is protected by the laws : he has great prerogatives, and a boundless power in doing good ; and is at the same time only restrained from acting inconsistently with his own happiness, and that of his people. He has all the ensigns of royalty, and all the marks of sovereignty ; but while he has the power of making treaties, of sending and receiving ambassadors, of conferring titles of honour, creating privy counsellors, officers of state, and judges, and may raise men and arms both for sea and land, he cannot force his subjects to maintain them, or raise one tax by his sole authority : he has the privilege of coining money, but he cannot force the meanest subject to part with his property : he can pardon a criminal ; but he cannot put a subject to death, till he is condemned by his peers : he may at his pleasure call, continue, prorogue, and dissolve parliaments, and without his royal assent no bill in parliament can pass into a law ; yet he can neither act contrary to law, nor make new laws by his sole authority ; on the contrary, he may even be sued and cast in his own courts.

At his coronation, he takes an oath to govern his people according to the statutes agreed on in parliament, to cause law and justice in mercy to be executed in all his judgments ; to maintain, as much as in him lies, the laws of God, the true profession of the gospel, and the protestant reformed religion by law established. But tho' he may mitigate the rigour of the law, and forgive offenders, he cannot pardon murder, where an appeal is brought by the subject ; nor any other crime, when the offender is impeached by the house of commons. He may lay an embargo on shipping, but then it ought to be for the public good, and not for the private advantage of any particular traders. Writs, processes, commissions, &c. are in his name ; and he has a power not only to make courts, but to create universities, colleges, and boroughs ; to incorporate a city or town, and to grant franchises to such corporations ; but they must not, under colour thereof, set up a monopoly. He is esteemed the head of the church in that part of his dominions called England. But notwithstanding these and other prerogatives, the king can take what he has a right to only by due course of law. In short, he has a principal share in the legislative power, and the whole executive power is lodged in him ; he is supposed present in all his courts, he can do no wrong, and, according to the laws of England, he never dies.

**KING'S BENCH**, a court in which the king was formerly accustomed to sit in person, and on that account was moved with the king's household. This was originally the only court in Westminster-hall, and from this it is thought that the courts of common pleas and exchequer were derived. As the king in person is still presumed in law to sit in this court, though only represented by his judges, it is said to have supreme

authority ; and the proceedings in it are supposed to be coram nobis, that is, before the king. This court consists of a lord chief justice and three other justices or judges, who are invested with a sovereign jurisdiction over all matters, whether of a criminal or public nature. All crimes against the public good, though they do not injure any particular person, are under the cognizance of this court ; and no private subject can suffer any unlawful violence or injury against his person, liberty, or possessions, but a proper remedy is afforded him here ; not only for satisfaction of damages sustained, but for the punishment of the offender : and wherever this court meets with an offence contrary to the first principles of justice, it may punish it. It frequently proceeds on indictments found before other courts, and removed by certiorari into this. Persons illegally committed to prison, though by the king and counsel, or either of the houses of parliament, may be bailed in it ; and in some cases, even upon legal commitments. Writs of mandamus are issued by this court, for the restoring of officers in corporations, &c. unjustly turned out, and freemen wrongfully disfranchised.

The court of king's bench is now divided into a crown-side and plea-side, the one determining criminal, and the other civil causes : in the first it determines criminal matters of all kinds, where the king is plaintiff ; such as treasons, felonies, murders, rapes, robberies, riots, breaches of the peace, and all other causes that are prosecuted by indictment, information, &c. On the plea-side, it determines all personal actions commenced by bill or writ ; as actions of debt, upon the case, detinue, trover, ejectment, trespass, waste, &c. against any person in the custody of the marshal of the court, as every person sued here is supposed to be by law.

The officers of this court on the crown-side are the clerk and secondary of the crown ; and on the side of the pleas there are two chief clerks or prothonotaries, and their secondary and deputy, the custos brevium, two clerks of the papers, the clerk of the declarations, the signer and sealer of bills, the clerk of the rules, clerk of the errors, and clerk of the bills ; to which may be added the filazers, the marshal of the court, and the crier.

**Books of Kings**, two canonical books of the Old Testament, so called because they contain the history of the kings of Israel and Judah, from the beginning of the reign of Solomon, down to the Babylonish captivity, for the space of near six hundred years.

It is probable that these books were composed by Ezra, who extracted them out of the public records, which were kept of what passed in that nation.

**KING'S COUNTY**, a county of Ireland, in the province of Leinster, bounded by West meath on the north, by the county of Kildare on the east, by Queen's county and Tipperary on the south, and by the river Shannon, which separates it from Galway, on the west.

**KING'S-EVIL**. See MEDICINE.

**KING'S FISHER**. in ornithology. See ALCEDO.

**KINGHORN**, a town of Scotland, on the coast of Fife, nine miles north of Edinlurgh.

**KINGSTON**,

- KINGSTON**, a market-town of Surry, situated on the river Thames, twelve miles west of London.
- KINGSTON**, a port-town of Jamaica, situated on the north side of the bay of Port royal: W. long. 77°, N. lat. 17° 32'.
- KINROSS**, a town of Scotland, in the shire of Fife, situated on the lake of Loch-Leven, twenty miles north of Edinburgh.
- KINSALE**, a port-town of Ireland, in the county of Cork and province of Munster, situated on the river Bandon, fourteen miles south of the city of Cork: W. long. 8° 20', and N. lat. 51° 32'.
- KIOF**, or **KIOW**, the capital of the Russian Ukraine, on the frontiers of Poland: E. long. 30° 30', and N. lat. 51°.
- KIRK**, a Saxon term, signifying the same with church.
- KIRK-OSWALD**, a market town of Cumberland, twelve miles south of Carlisle.
- KIRK-SESSIONS**, an inferior church judicatory in Scotland, consisting of the ministers, elders, and deacons of a parish.
- It regulates matters relating to public worship, catechising, visitations, &c. and judges in cases of fornication and lesser scandals.
- KIRKALDY**, a town of Fifeshire, in Scotland, ten miles north of Edinburgh.
- KIRKHAM**, a market-town of Lancashire, sixteen miles south of Lancaster.
- KIRKUDBRIGHT**, a parliament-town of Scotland, which ranks with Dumfries, Annan, &c. situated on a bay of the Irish sea, sixty miles west of Carlisle: W. long. 4° 5', and N. lat. 54° 38'.
- KIRKWALL**, the capital of the Orkney-islands, and situated in that of Pomona, is a parliament-town, which classes with Dingwall, Tain, &c. W. long. 25°, and N. lat. 59° 45'.
- KITCHEN-GARDEN**, a piece of ground laid out for the cultivation of fruit, herbs, pulse, and other vegetables used in the kitchen. See **GARDENING**.
- KITE**. See **FALCO**.
- KNARESBOROUGH**, a borough-town in the north riding of Yorkshire, fifteen miles north of York. It sends two members to parliament.
- KNAVE**, in old law-books, an appellation given to a manservant, or even to a male child.
- KNAVESHIP**, in Scots law, one of the names of the small-duties payable in thirlage to the miller's servants, called sequels. See **SCOTS LAW**, tit. 16.
- KNAUTIA**, in botany, a genus of the tetrandria monogynia class. The common calix is oblong, simple, and contains five flowers; the proper calix is simple, and above the fruit; the corollulæ are irregular; and the receptacle is naked. There are two species, none of them natives of Britain.
- KNEE**, in anatomy, the articulation of the thigh and leg-bones. See **ANATOMY**, part I. &c.
- KNEE**, in a ship, a crooked piece of timber, bent like a knee, used to bind the beams and futtocks together, by being bolted fast into them both. These are used about all the decks.
- Carling-KNEES**, in a ship, those timbers which extend from the sides to the hatch-way, and bear up the deck on both sides.
- KNIFE**, a well-known instrument, made for cutting.
- All sorts of knives are prohibited to be imported.
- KNIGHT**, among the Romans, a person of the second degree of nobility, following immediately that of the senators.
- Part of the ceremony whereby this honour was conferred, was the giving of an horse; for each had an horse at the public charge, and received the stipend of a horseman, to serve in the wars.
- When the knights were taken in among the senators, they resigned the privilege of having an horse kept for them at the charge of the public: then it became necessary, in order to be a knight, that they should have a certain revenue, that their poverty might not disgrace the order; and when they failed of the prescribed revenue, they were expunged out of the list of knights, and thrust down among the Plebeians. Ten thousand crowns is computed to have been the revenue required.
- The knights at length grew so very powerful, that they became a balance between the power of the senate and people: they neglected the exercises of war, and betook themselves principally to civil employments in Rome.
- KNIGHT**, in a modern sense, properly signifies a person, who, for his virtue and martial prowess, is by the king raised above the rank of gentlemen, into an higher class of dignity and honour.
- Knighthood was formerly the first degree of honour in the army, and usually conferred with a great deal of ceremony on those who had distinguished themselves by some notable exploit in arms: the ceremonies at their creation have been various; the principal was a box on the ear, and a stroke with a sword on the shoulder; they put on him a shoulder-belt, and a gilt sword, spurs, and other military accoutrements; after which being armed as a knight, he was led to the church in great pomp. Camden describes the manner of making a knight-bachelor among us, which is the lowest, though the most ancient order of knighthood, to be thus: the person kneeling, was gently struck on the shoulder by the prince, and accented in these words, "Rise, or be a knight, in the name of God."
- KNIGHT** is also understood of a person admitted into any order, either purely military, or military and religious, instituted by some king or prince, with certain marks and tokens of honour and distinction, as the knights of the garter, knights of the thistle, knights of Malta, the knights of the Holy Ghost, &c.
- KNIGHTS-ERRANT**, a pretended order of chivalry, much talked of in old romances, being a kind of heroes that travelled the world in search of adventures, redressing wrongs, rescuing damsels, and taking all occasions of signaling their prowess. This romantic bravery of the old knights was heretofore the chimera of the Spaniards.
- KNIGHTS of the shire**, or **KNIGHTS of parliament**, in the

the British polity, are knights or gentlemen of estate, who are elected, on the king's writ, by the freeholders of every county, to represent them in parliament.

The qualifications of a knight of the shire in England, is to be possessed of 600*l. per. ann.* in a freehold estate; and in Scotland 400*l.* Scots valued rent, or 40. shillings of old extent. Their expences during their sitting, were, by a statute of Hen. VIII. to be defrayed by the county; but this is now scarce ever required.

**KNIGHT-MARSHAL**, an officer in the king's household, who has jurisdiction and cognizance of any transgression within the king's household and verge; as also of contracts made there, whereof one of the house is party.

**KNIGHTS**, in a ship, two thick short pieces of wood, commonly carved like a man's head, having four shivers in each, three for the halyards, and one for the top-ropes to run in: one of them stands fast bolted on the beams abaft the foremast, and is therefore called the fore-knight; and the other, standing abaft the main mast, is called the main knight.

**KNOWLEDGE**, is defined, by Mr Locke, to be the

perception of the connection and agreement, or disagreement and repugnancy, of our ideas.

**KONIGSBURG**, a city of Poland, the capital of ducal Prussia, and of the king of Prussia's Polish dominions, situated on the river Pregel, near a bay of the Baltic sea, seventy miles north-east of Dantzick: E. long. 21°, and N. lat. 54° 40'.

**KORAN**, or **ALCORAN**. See **MAHOMETANISM**.

**KOS**, in Jewish antiquity, a measure of capacity, containing about four cubic inches: this was the cup of blessing, out of which they drank when they gave thanks after solemn meals, like that of the passover.

**KUR**, the ancient Cyrus, a river of Persia, which rises in the mountains of Georgia, and running south-east by Teflis, unites it streams with the river Arras (the ancient Arraxes) and falls into the Caspian sea, south of Baku.

**KUTUCHTA**, among the Calmuc Tartars, the name of their high-priest, or sovereign pontiff; formerly only the deputy of the delai-lama, or high-priest of the Tartars, but at present independent on him.



L.

L A B

L A B

**L** A, in music, the syllable by which Guido denotes the last sound of each hexachord: if it begins in C, it answers to our A; if in G, to E; and if in F, to D.

**LABARUM**, in Roman antiquity, the standard borne before the Roman emperors; being a rich purple streamer, supported by a spear.

**LABDANUM**, or **LADANUM**, a resin of the softer kind, though of too firm a consistence to be ranked among the fluid ones.

There are two kinds of it kept in the shops; one usually imported in bladders, to preserve it in its genuine soft consistence, and to prevent the evaporation of its finer parts; another in rolls, much inferior to the former in purity and virtue.

Labdanum should be chosen soft and moist, of a strong smell, pure, very inflammable, and diffusing a fragrant smell while burning. It is a resinous juice which exudes from a tree of the cistus-kind.

In medicine it is used externally, to attenuate and discuss tumours; internally, it is more rarely used, but it is greatly extolled by some against catarrhs, and in dysenteries.

**LABEL**, in heraldry, a fillet usually placed in the middle along the chief of the coat, without touching its extremities. Its breadth ought to be a ninth part of the chief. It is adorned with pendants; and when there are above three of these, the number must be specified in blazoning.

This is a kind of addition to the arms of a second  
 Vol. II. Numb. 62. 2

brother, to distinguish him from the first, and is esteemed the most honourable of all differences. See Plate CII.

**LABIAL LETTERS**, those pronounced chiefly by means of the lips.

**LABIATED FLOWERS**, monopetalous flowers, consisting of a narrow tube, with a wide mouth, divided into two or more.

**LABIAU**, a port-town of Prussia, situated on a bay of the Baltic sea, twenty miles north-east of Konigsburg: E. long. 22° 15', N. lat. 55°.

**LABORATORY** or **ELABORATORY**, the chemists work-house, or the place where they perform their operations; where the furnaces are built, their vessels kept, &c. and in general, the term laboratory, is applied to any place where physical experiments in pharmacy, chemistry, pyrotechny, &c. are performed. See **CHEMISTRY**, p. 108, &c.

**LABOUR**, in general, denotes a close application to work or business. Among seamen a ship is said to be in labour, when she rolls and tumbles very much, either a hull, under sail, or at anchor.—It is also spoke of a woman in travail or child birth. See **MIDWIFERY**.

**LABOURER**, generally signifies one that does the most slavish and less artful part of a laborious work, as that of husbandry, masonry, &c.

**LABRADOR**, also called New-Britain, and Eskimaux, is a country in North America, bounded by Hudson's Straits and the Atlantic Ocean, on the north; by the same ocean, on the east; by the river of St. Lawrence

and Canada, on the south; and by Hudson's bay, on the west: situated between  $59^{\circ}$  and  $79^{\circ}$  of W. long. and between  $50^{\circ}$  and  $64^{\circ}$  of N. lat.

**LABRUS**, in ichthyology, a genus of fishes belonging to the order of thoracici, the characters of which are these. The teeth are sharp, and the lips are simple and very thick; there are six bony rays in the membrane of the gills, and the opercula are scaly. The rays of the back fin are furnished with a thread-like ramentum behind; the breast fins are sharp-pointed; and the lateral line is straight. There are forty-one species of labrus, distinguished by the shape of the tail, fins, colour, &c.

**LABURNUM**, in botany. See **CYTISUS**.

**LABYRINTH**, in anatomy. See **ANATOMY**, p. 297.

**LAC, MILK**, among physicians, &c. See **MILK**.

**LACCA**, or **LAC**, in natural history, improperly called gum-lac, a sort of wax of a red colour, collected in the East-Indies by certain insects, and deposited on sticks flattened for that purpose in the earth. It is brought over, either adhering to the sticks, or in small transparent grains, or in semi-transparent flat cakes: the first is called stick lac, the second seed lac, and the third shell lac. On breaking a piece of stick lac, it appears composed of regular cells like the honey-comb, with small corpuscles of a deep red colour lodged in them: these are the young insects, and to these the lac owes its tincture, for when freed from them its colour is very dilute. The shell and seed lacs, which do not exhibit any insects or cellular appearance upon breaking, are supposed to be artificial preparations of the other: the seed sort is said to be the stick lac bruised and robbed of its more soluble parts; and the shell to be the seed lac, melted and formed into cakes. The stick lac therefore is the genuine sort, and ought alone to be employed for medicinal purposes. This concrete is of great esteem in Germany and other countries, for laxity and sponginess of the gums, proceeding from cold; or a scorbutic habit: for this use the lac is boiled in water, with the addition of a little alum, which promotes its solution: or a tincture is made from it with rectified spirit. This tincture is recommended also internally in the fluor albus, and in rheumatic and scorbutic disorders: it has a grateful smell, and a not unpleasent, bitterish, astringent taste: in the Edinburgh pharmacopœia, a tincture is directed to be made with spirit of scurvy grass. The principal use of lac among us is in certain mechanic arts as a colouring drug, and for making sealing wax.

**LACE**, in commerce, a work composed of many threads of gold, silver or silk, interwoven the one with the other, and worked upon a pillow with spindles, according to the pattern designed. The open work being formed with pins, which are placed and displaced as the spindles are moved.

The importation of gold and silver lace is prohibited.

*Bone* **LACE**, a lace made of fine linen thread or silk, much in the same manner as that of gold and silver. The pattern of the lace is fixed upon a large round pillow, and pins being stuck into the holes or openings in the pattern, the threads are interwoven by means of a

number of bobbins made of bone or ivory, each of which contains a small quantity of fine thread, in such a manner as to make the lace exactly resemble the pattern. There are several towns in England, and particularly in Buckinghamshire, that carry on this manufacture; but vast quantities of the finest laces have been imported from Flanders.

**LACEDEMON**, the ancient name of Mithra. See **MISITHRA**.

**LACERTA**, the lizard, in zoology, a genus of amphibious animals belonging to the order of reptilia, the characters of which are these: The body is naked, with four feet, and a tail. There are 49 species, viz.

1. The crocodylus, or crocodile, has a compressed jagged tail, five toes on the fore-feet, and four on the hind-feet. This is the largest animal of the lizard kind. One that was dissected at Siam, an account of which was sent to the Royal Academy at Paris, was eighteen feet and a half long, of which the tail was no less than five feet and a half, and the head and neck above two and a half. He was four feet and nine inches in circumference where thickest.

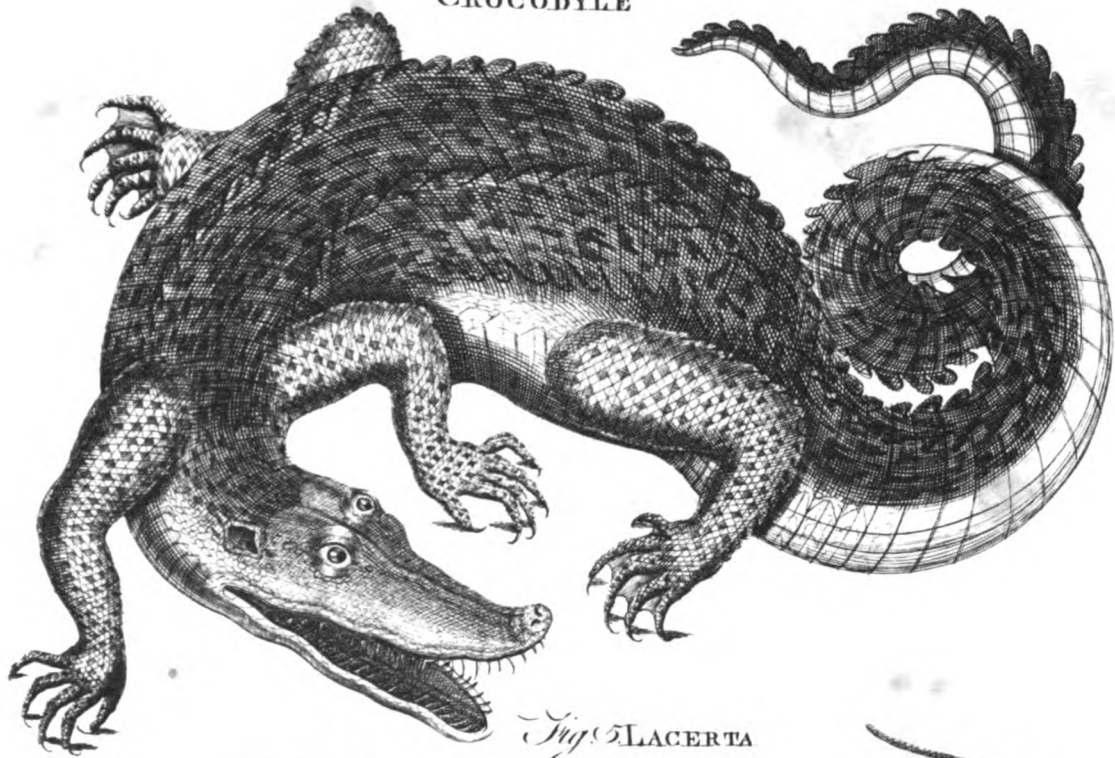
The hinder legs, including the thigh and the paw, were two feet and two inches long; the paws, from the joint to the extremity of the longest claws, were above nine inches. They were divided into four toes; of which three were armed with large claws, the longest of which was an inch and a half, and seven lines and a half broad at the root. The fourth toe was without a nail, and of a conical figure; but was covered with a thick skin like shagreen leather. These toes were united with membranes like those of ducks, but much thicker.

The fore-legs had the same parts and conformation as the arms of a man, both within and without; but they were somewhat shorter than those behind. The hands had five fingers, the two last of which had no nails, and were of a conical figure, like the fourth toe on the hind paws. The head was long, and had a little rising at the top; but the rest was flat, and especially towards the extremity of the jaws. It was covered with a skin, which adhered firmly to the skull and to the jaws. The skull was rough and unequal in several places; and about the middle of the forehead there were two bony crests, about two inches high. They were not quite parallel, but separated from each other in proportion as they mounted upwards.

The eye was very small in proportion to the rest of the body, and was so placed within its orbit, that the outward part, when shut, was only a little above an inch in length, and run parallel to the opening of the jaws.

The nose was placed in the middle of the upper jaw, near an inch from its extremity, and was perfectly round and flat, being two inches in diameter, of a black, soft, spongy substance, not unlike the nose of a dog. The nostrils were in the form of a Greek capital  $\Sigma$ , and there were two caruncles which filled and closed them very exactly, and which opened as often as he breathed through the nose. The jaws seemed to shut one within another by means of several apophyses, which

*Fig. 4.* LACERTA CROCODYLUS or  
CROCODYLE



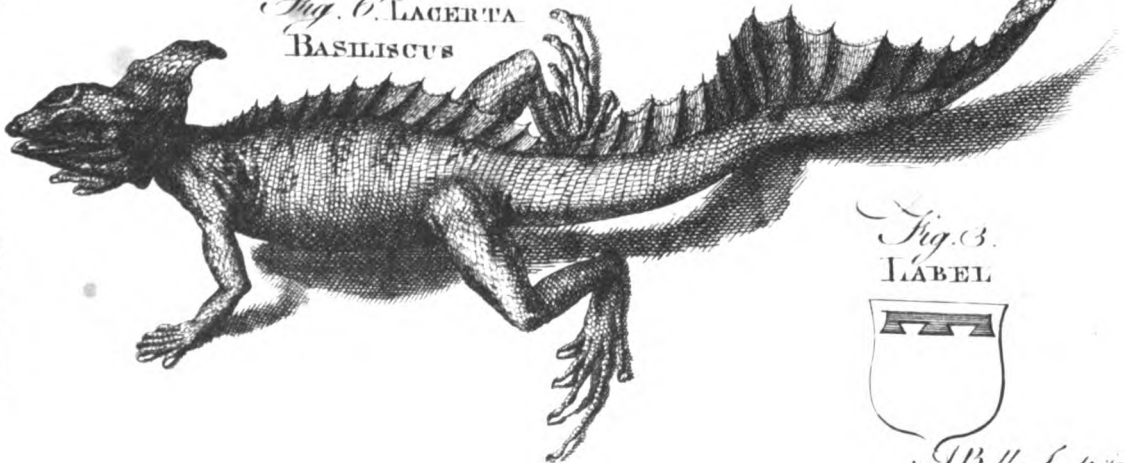
*Fig. 5.* LACERTA  
CHAMÆLEON



*Fig. 1.*  
INDENTED



*Fig. 6.* LACERTA  
BASILISCUS



*Fig. 2.*  
ENVECTED



*Fig. 3.*  
LABEL



*A. Bell's Sculp.*





which proceeded from above downwards, and from below upwards, there being cavities in the opposite jaw to receive them. They had twenty-seven dog-teeth in the upper jaw, and fifteen in the lower, with several void spaces between them. They were thick at the bottom, and sharp at the point; being all of different sizes, except ten large hooked ones, six of which were in the lower jaw, and four in the upper. The mouth was fifteen inches in length, and eight and a half in breadth where broadest; and the distance of the two jaws, when opened as wide as they could be, was fifteen inches and a half. The skull, between the two crests, was proof against a musket ball, for it only rendered the part a little white that it struck against.

The colour of the body was of a dark brown on the upper part, and of a whitish citron below, with large spots of both colours on the sides. From the shoulders to the extremity of the tail he was covered with large scales of a square form, disposed like parallel girdles, and were fifty-two in number; but those near the tail were not so thick as the rest. In the middle of each girdle there were four protuberances, which became higher as they approached the end of the tail, and composed four rows, of which the two in the middle were lower than the remaining two, forming three channels, which grew deeper the nearer they came to the tail, and were confounded with each other about two feet from its extremity.

The skin was defended with a sort of armour, which, however, was not proof against a musket ball, contrary to what has been commonly said. However, it must be acknowledged, that the attitude in which it was placed might contribute not a little thereto; for probably, if the ball had struck obliquely against the shell, it would have flown off. Those parts of the girdles underneath the belly were of a whitish colour, and were made up of scales of divers shapes. They were about one sixth of an inch in thickness, and were not so hard as those on the back.

This creature lays eggs of the size of those of a goose, to the number of sixty; which she covers over with sand, and leaves to be hatched by the heat of the sun. They are to be met with in the rivers Nile, Niger, and Ganges, besides most other large rivers in the southern parts of Asia, Africa, and America.

The crocodile is very destructive to the lower people of Upper Egypt, often devouring women who come to the river to fetch water, and children playing on the shore or swimming in the river.

2. The *caudiverbera*, has a depressed pinnatifid tail, and palmated feet. It is larger than the common green lizard. It is found in Peru, and has got its name from its beating the ground with its tail. 3. The *dracæra*, has a long tail dentated above, a smooth body, and equal toes. It is a native of America. 4. The *superciliosa*, has a carinated tail, and the scales on the back and eye-brows are ciliated. It is a native of the Indies. 5. The *scutata*, has a subcompressed tail, and a dentated future on the back. It is a native of Asia. 6. The *monitor*, has a carinated tail, and white eye-like spots on the body. It is a native of the

Indies. 7. The *principalis*, has a carinated tail, a crest on the throat, and a smooth back. It is found in south America. 8. The *bicarinata*, has a compressed tail with a double carina, and a quadruple carina on the back. It is a native of the Indies. 9. The *cordylus* has a short verticillated tail, and dentated scales. It is found in Africa and Asia. 10. The *stellio*, has a verticillated tail, and dentated scales. It is a native of Africa. 11. The *mauritanica*, has a short verticillated tail smooth at the apex. It is found in Mauritania. 12. The *azurea*, has a short verticillated tail, and sharp pointed scales. It is a native of Africa. 13. The *turcica*, has a verticillated tail, and a rough grey body. It is a native of the East Indies. 14. The *ameiva*, has a long verticillated tail, 30 scutæ on the belly, and a plaited collar. It is a native of America. 15. The *agilis*, has a pretty long verticillated tail, with sharp scales, and a collar formed by scales. This is the common green lizard, and is a native both of Europe and India. 16. The *algira*, has a pretty long verticillated tail, and a yellow line on each side of the body. It is found in Mauritania. 17. The *seps* has a long verticillated tail, with a reflected lateral future, and square scales. It is a native of warm climates. 18. The *sex-lineata*, has a long verticillated tail, and six white lines on the back. It is a native of Carolina. 19. The *angulata*, has a long hexagonal tail, and sharp carinated scales. It is a native of America.

20. The *chamæleon*, has a crooked cylindrical tail.

The head of a large *chamæleon* is almost two inches long, and from thence to the beginning of the tail it is four inches and a half. The tail is five inches long, and the feet two and a half. The thickness of the body is different at different seasons; for sometimes from the back to the belly it is two inches, and sometimes but one; for he can blow himself up and contract himself at pleasure. This swelling and contraction is not only of the back and belly, but of the legs and tail.

These different motions are not like those of other animals, which proceed from a dilatation of the breast in breathing, and which rises and falls successively; but they are very irregular, as in tortoises, and frogs. The *chamæleon* has continued as it were blown up for two hours together, and then he would grow less and less insensibly; for the dilatation was always more quick and visible than the contraction. In this last state he appeared extremely lean, and the spine of the back was sharp, and all his ribs might be told; likewise the tendons of the arms and legs might be seen very distinctly.

The skin is very cold to the touch; and, notwithstanding he seems so lean, there is no feeling the beating of the heart. The surface of the skin is unequal, and has a grain not unlike flageon, but very soft, because each eminence is as smooth as if it was polished. Some of these are as large as a middling pin's head on the arms, legs, belly, and tail, but on the shoulders and head they are of an oval figure, and a little larger. Those under the throat are ranged in the form of a chap-

let,

let, from the lower lip to the breast. Some on the head and back are amassed together in clusters, with spaces between them, on which are almost imperceptible spots of a pale red and yellow colour; as well as the ground of the skin itself; which plainly appears between these clusters. This ground changes colour when the animal is dead, becoming of a greyish brown, and the small spots are whitish.

The colour of all these eminences, when the chamæleon is at rest in a shady place, is of a bluish grey, except on the claws, where it is white with a little yellow; and the spaces between the clusters is of a pale red and yellow, as was before observed. But when he is in the sun, all parts of the body which are affected with the light, become of a greyish brown, or rather of a tawny. That part of the skin which the sun does not shine on, changes into several brighter colours, which form spots of the size of half one's finger. Some of these descend from the spine half way on the back; and others appear on the sides, arms, and tail. They are all of an isabella colour, from a mixture of a pale yellow and of a bright red, which is the colour of the ground of the skin.

The head of a chameleon is not unlike that of a fish, it being joined to the breast by a very short neck, covered on each side with cartilaginous membranes resembling the gills of fishes. There is a crest directly on the top of the head, and two others on each side above the eyes, and between these there are two cavities near the top of the head. The muzzle is blunt, and not much unlike that of a frog; at the end there is a hole on each side for the nostrils, but there are no ears, nor any sign of any.

The jaws are furnished with teeth, or rather with a bone in the form of teeth, which he makes little or no use of, because he lives upon swallowing flies and other insects, without chewing them. The form, structure, and motion of the eyes, have something very particular; for they are very large, being almost half an inch in diameter. They are of a globous figure; which may be easily seen, because they stand out of the head. They have a single eye-lid like a cap, with a hole in the middle, through which the sight of the eye appears, which is of a shining brown, and round it there is a little circle of a gold colour. This eye-lid has a grain like shagreen, as well as the other parts of the skin; and when the rest of the body changes colour, and assumes spots of different shapes, those on the lid always keep the same form, though they are tinged with the same colour as the skin. But the most extraordinary thing relating to the eyes is, that this animal often moves one when the other is entirely at rest; nay, sometimes one eye will seem to look directly forward, and the other backward; and one will look up to the sky when the other regards the earth.

That part of the body which is called the trunk, and comprehends the thorax and the belly, in a chamæleon is almost all thorax with little or no belly. The four feet are all of a length; and the only difference between them is, that those before are turned

backwards, and those behind forwards. There are five toes on each paw, which have a greater resemblance to hands than feet. They are all divided into two, which gives the appearance of two hands to each arm, and two feet to each leg; and though one of these parts have three toes, and the other but two, yet they seem to be all of the same size. These toes lie together under the same skin as in a mitten; however, their shape might be seen through the skin. With these paws the chamæleon can lay hold of the small branches of trees in the same manner as a parrot. When he is about to perch, he parts his toes different from birds, because he puts two behind and two before. The claws are little, crooked, very sharp, and of a pale yellow, proceeding but half way out of the skin, while the other half is hid beneath it. His walk is slower than that of a tortoise, and he seems to move along with an affectation of gravity. He seems to seek for a proper place to set his feet upon; and when he climbs up trees, he does not trust to his feet like squirrels, but endeavours to find out clefts in the bark, that he may get a surer hold.

His tail is like that of a viper when it is puffed up and round, for otherwise the bones may be seen in the same manner as on the back. He always wraps his tail round the branches of trees, and it serves him as it were instead of a fifth hand.

He is a native of Africa and Asia.

21. The gecko, has a cylindrical tail, concave ears, and a warty body. It is the Indian salamander of Bontius. "This animal is very frequent in Cairo, (says Hasselquist) both in the houses and without them. The poison of this animal is very singular, as it exhales from the lobuli of the toes. The animal seeks all places and things impregnated with sea salt, and passing over them several times leaves this very noxious poison behind it. In July 1750, I saw two women and a girl, in Cairo, at the point of death, from eating cheese new salted, bought in the market, and on which this animal had dropt its poison. Once at Cairo, I had an opportunity of observing how acrid the exhalations of the toes of this animal are, as it ran over the hand of a man who endeavoured to catch it; there immediately rose little pustules over all those parts the animal had touched; these were red, inflamed, and smarted a little, greatly resembling those occasioned by the stinging of nettles. It emits an odd sound, especially in the night, from its throat, not unlike that of a frog." 22. The scincus, has a cylindrical tail, compressed at the point, and blunt margined toes. This animal is found in Arabia Petrea near the Red Sea, and in Upper Egypt near the Nile. It is much used by the inhabitants of the East as an aphrodisiacum, but not at this time by the Europeans. The flesh of the animal is given in powder, with some stimulating vehicle; broth made of the recent flesh, is likewise used by the Arabs. It is brought from Upper Egypt and Arabia to Alexandria, whence it is carried to Venice and Marfeilles, and from thence to all the apothecaries shops of Europe. It has been an error, common to almost all authors, to imagine the scincus to be a fish. 23. The orbicularis, has a cylindrical

tail, and a roundish belly. It is a native of Mexico. 24. The *quinque-lineata*, has a cylindrical tail, and five white lines on the back. It is found in Carolina. 25. The *balisicus*, has a long cylindrical tail, a radiated fin on the back, and a crest on the hind part of the head. It is a native of South America. 26. The *ignava*, has a long cylindrical tail, a toothed ridge on the back, and a crest on the throat. It is a native of the Indies. 27. The *calotes*, has a long cylindrical tail, with the fore-part of the back and hind part of the head toothed. It is a native of Ceylon. 28. The *agama*, has a long cylindrical tail, with prickles on the neck and hind part of the head. It is a native of America. 29. The *umbra*, has a long cylindrical tail, a callous crest on the nape of the neck, and a streaked back. It is a native of southern climates. 30. The *plica*, has a long cylindrical tail, a callous crest on the hind head, and a warty neck. It is a native of the Indies. 31. The *marmorata*, has a long cylindrical tail, a smooth back, and a small toothed crest on the throat. It is a native of Spain. 32. The *bullaris*, has a long cylindrical tail, and a bladder on the throat, which it blows up when enraged. It is a native of Jamaica. 33. The *strumosa* has a long cylindrical tail, and a gibbous breast. It is found in South America. 34. The *tequisein*, has a long cylindrical tail, and a plaited future on the side. It is a native of the Indies. 35. The *aurata*, has a cylindrical tail, and round shining scales like gold. It is found in the islands of Cyprus and Jersey. 36. The *nilotica*, has a long tail with a triangular edge, and four lines of scales on the back. It is a native of Egypt. 37. The *punctata*, has a long cylindrical tail, two yellow lines on the back, and is interspersed with black points. It is found in Asia. 38. The *lemniscata*, has a long cylindrical tail, and 8 white lines on the back. It is found in Guinea. 39. The *fasciata*, has a blue cylindrical tail, and five yellow lines on the back. It is a native of Carolina. 40. The *chalcides*, has a long cylindrical tail, and very short legs, with five toes on the feet. It is a native of Europe and Africa. 41. The *vaigaris*, has a cylindrical tail, four toes on the fore feet, and two dusky coloured lines on the back. It is a native of Europe. 42. The *aquatica*, has a tail somewhat cylindrical, and four toes on the fore-feet. It lives in the fresh waters, pools, &c. of Europe. 43. The *palustris*, has a lanceolated tail, and four toes on the fore-feet. It inhabits the stagnant waters of Europe. 44. The *punctata*, has a cylindrical tail, four toes on the fore-feet, and longitudinal rows of white spots on the back. It is a native of Carolina. 45. The *quatuor-lineata*, has a long cylindrical tail, four toes on the fore feet, and four yellow lines on the back. It is a native of North America. 46. The *salamandra*, has a short cylindrical tail, four toes on the fore feet, and a naked porous body. This animal is vulgarly said to live in fire; but it is found to be a mistake. It is found in the southern countries of Europe. 47. The *angina*, has a very long verticillated tail, extremely rigid at the point. It is found at the Cape of Good hope.

**LACHINÆA**, in botany, a genus of the *ostandria monogynia* class. It has no calix; the corolla is divided into four segments; the limb is unequal; and the fruit, which is a kind of berry, contains but one seed. There are two species, both natives of warm climates.

**LACHRYMAL**, in anatomy, an appellation given to several parts of the eye. See **ANATOMY**, p. 289.

**LACHRYMATORY**, in antiquity, a vessel wherein were collected the tears of a deceased person's friends, and preserved along with the ashes and urn.

**LACTEAL VESSELS**, in anatomy. See **ANAT.** p. 263.

**LACTIFEROUS**, an appellation given to plants abounding with a milky juice, as the sow-thistle, and the like.

**LACTUCA**, **LETTUCE**, in botany. See **LETTUCE**.

**LACUNÆ**, in anatomy. See **ANATOMY**, p. 275, 276.

**LACUNAR**, in architecture, an arched roof or ceiling, more especially the planking or flooring above porticos and piazzas.

**LADENBURG**, a town of Germany, situated on the river Neckar, eighty miles north-west of Heidelberg.

**LADRONE ISLANDS**, are situated in the Pacific Ocean, between 12° and 28° of N. lat. and about 140° E. long.

**LADY'S BEDSTRAW**. See **GALLIUM**.

**LADY'S MANTLE**. See **ALCHIMILLA**.

**LADY'S SMOCK**. See **CARDAMINE**.

**LADY'S SLIPPER**. See **CYPRIPEDIUM**.

**LADY'S TRACES**. See **OPHYRS**.

**LADY DAY**, in law, the 25th of March, being the annunciation of the holy virgin. See **ANNUNCIATION**.

**LAGOECIA**, **ROUND-HEADED CUMMIN**, in botany, a genus of the *pentandria monogynia* class. It has both an universal and partial involucre; the petals are bisid; and the seed is solitary. There is but one species, a native of Crete.

**LAGOPUS**, in ornithology. See **TETRAO**.

**LAGOS**, a port-town of Portugal, in the province of Algarva: W. long. 9° 27', N. lat. 36° 45'.

**LAGURUS**, in botany, a genus of the *triandria digynia* class. The calix has a double valve, with a villous aun, and the exterior petal has two auns at the end. There are two species, none of them natives of Britain.

**LAHOLM**, a port-town of Gothland, in Sweden, sixty miles north of Copenhagen.

**LAHOR**, the capital of a province of the same name in the hither India: E. long 75° and N. lat. 33°.

**LAKE**, a collection of waters contained in some cavity in an inland place, of a large extent, surrounded with lands, and having no communication with the ocean.

**LAMA**, the sovereign pontiff, or rather god of the Asiatic Tartars, inhabiting the country of Barantola. The lama is not only adored by the inhabitants of the country, but also by the kings of Tartary, who send him rich presents, and go in pilgrimage to pay him adoration, calling him *lama conguu*, i. e. god the everlasting father of heaven. He is never to be seen but in a secret place of his palace, amidst a great number of lamps, sitting cross-legged upon a cushion, and adorned

- all over with gold and precious stones; where, at a distance, they prostrate themselves before him, it not being lawful for any to kiss even his feet. He is called the great lama, or lama of lamas, that is, priest of priests. And to persuade the people that he is immortal, the inferior priests, when he dies, substitute another in his stead, and so continue the cheat from generation to generation. These priests persuade the people, that the lama was raised from death many hundred years ago, that he has lived ever since, and will continue to live for ever.
- LAMB**, in zoology, the young of the sheep kind. See **Ovis**.
- LAMBOIDES**, in anatomy. See **ANATOMY**, p. 152.
- LAMELLÆ**, in natural history, denotes very thin plates, such as the scales of fishes are composed of.
- LAMENTATIONS**, a canonical book of the Old Testament, written by the prophet Jeremiah. The two first chapters of this book are employed in describing the calamities of the siege of Jerusalem. In the third, the author deploras the persecutions he himself had suffered. The fourth turns upon the desolation of the city and temple, and the misfortune of Zedekiah. The fifth chapter is a prayer for the Jews in their dispersion and captivity; and at the end of all, he speaks of the cruelty of the Edomites, who had insulted Jerusalem in her misery. The first four chapters of the lamentations are an abcdary, every verse or couplet beginning with one of the letters of the Hebrew alphabet, in the alphabetical order.
- LAMINÆ**, in physiology, the thin plates whereof many substances consist.
- LAMIUM**, **DEAD-NETTLE**, in botany, a genus of the didynamia gymnospermia class. The superior labium is entire and vaulted; the inferior one consists of two lobes; in the margin of the faux on each side there is a remarkable tooth. There are eight species, three of them natives of Britain, viz. the album, or white dead-nettle; the rubrum, or red dead nettle; and the amplexicaule, or great henbit.
- LAMMAS-DAY**, a festival celebrated on the first of August by the Romish church, in memory of St. Peter's imprisonment.
- LAMP**, a vessel containing oil, with a lighted wick. Dr. St. Clair, in Phil. Trans. n<sup>o</sup> 245, gives the description of an improvement upon the common lamp. He proposes that it should be made two or three inches deep, with a pipe coming from the bottom almost as high as the top of the vessel: let it be filled to high with water as to cover the hole of the pipe at the bottom, that the oil may not get in at the pipe, and so be lost. Then let the oil be poured in, so as to fill the vessel almost brim full, which must have a cover pierced with as many holes as there are wicks designed. When the vessel is thus filled, and the wicks are lighted, if water falls in by drops at the pipe, it will always keep the oil at the same height, or very near; the weight of the water being to that of the oil as 20 to 19, which in two or three inches makes no great difference. If the water runs faster than the oil wicks, it will only run over at the top of the pipe, and what does not run over will come under the oil, and keep it at the same height.
- LAMPAS**, in fardery. See **FARRIERY**, p. 557.
- LAMPREY**. See **PETROMYZON**.
- LAMP SACUS**, a port-town of the lesser Asia, at the entrance of the Propontis, opposite to Gallipoli, situated eighty miles south-west of Constantinople: E. long. 28°, N. lat. 40° 12'.
- LANCASTER**, the county-town of Lancashire: W. long. 2° 44', N. lat. 54°. It sends two members to parliament.
- LANCEOLATED LEAF**. See **BOTANY**, p. 629.
- LANCET**, a surgical instrument, sharp pointed, and two-edged, chiefly used for opening veins in the operation of phlebotomy, or bleeding; also for laying open abscesses, tumors, &c.
- LANCHANG**, the capital of the kingdom of Laos, in the further India: E. long. 101°, N. lat. 20°.
- LAND**, in a limited sense, denotes arable ground. See **AGRICULTURE**.
- LAND**, in the sea language, makes part of several compound terms; thus *land laid*, or to lay the land, is just to lose sight of it. *Land-locked*, is when land lies all round the ship, so that no point of the compass is open to the sea; if she is at anchor in such a place, she is said to ride land-locked, and is therefore concluded to ride safe from the violence of winds and tides. *Land mark*, any mountain, rock, steeple, tree, &c. that may serve to make the land known at sea. *Land is shut in*, a term used to signify that another point of land hinders the sight of that the ship came from. *Land to*, or the ship *lies land to*; that is, she is so far from shore that it can only be just discerned. *Land turn*, is a wind that in almost all hot countries blows at certain times from the shore in the night. *To set the land*, that is, to see by the compass how it bears.
- LANDAFF**, a city and bishop's see of Glamorganshire, in south Wales, twenty-six miles north west of Bristol: W. long. 3° 20', N. lat. 51° 33'.
- LANDAU**, a city of Germany, in the circle of the Upper Rhine, and landgraviate of Alsace, situated fifteen miles south-west of Spire: E. long. 8°, N. lat. 49° 12'.
- LANDEN**, a small town of the Austrian Netherlands, in the province of Brabant, eighteen miles south-east of Louvain, and twenty miles north of Namur.
- LANDGRAVE**, the German name for a count or earl, that has the government of a province, country, or large tract of land.
- LANDGRAVIATE**, or **LANDGRAVATE**, the office, authority, jurisdiction, or territory of a landgrave.
- LANDRECY**, a town of the French Netherlands, in the province of Hainault: E. long. 3° 25', N. lat. 50° 5'.
- LANDSCROON**, a port-town of Sweden, in the province of Gothland, and territory of Schonen, situated on the Baltic sea, within the Sound: E. long. 14° 20', N. lat. 55° 42'.
- LANDSHUT**, a city of Germany, and the capital of Lower Pavia, situated fifty miles north-east of Munich: E. long. 12° 6', N. lat. 48° 30'.
- LANDSLIP**,

**LANDSHIP**, or **LANDSCAPE**, in painting, the view or prospect of a country, extended as far as the eye will reach.

Landships are esteemed one of the lowest branches of painting, representing some rural scene, as hills, valleys, rivers, country houses, &c. where human figures are only introduced as accidents.

**LANDSPERG**, the name of two towns in Germany; one situated on the river Warta, thirty two miles north-east of Frankfort upon the Oder; and the other in Bavaria, twenty three miles south of Augsburg.

**LANERK**, a parliament town of Scotland, situated on the river Clyde, twenty miles south east of Glasgow.

**LANGREL SHOT**, at sea, that consisting of two bars of iron, joined by a chain or shackle, and having half a ball of iron fixed on each end; by means of which apparatus, it does great execution among the enemy's rigging.

**LANGRES**, a great city of Champagne, the bishop of which is one of the twelve peers of France: E. long.  $5^{\circ} 22'$ , and N. lat.  $48^{\circ}$ .

**LANGUAGE**, in the most general meaning of the word, signifies any sound uttered by an animal, by which it expresses any of its passions, sensations, or affections; but it is more particularly understood to denote those various modifications of the human voice, by which the several sensations and ideas of one man are communicated to another.

Nature has endowed every animal with powers sufficient to communicate to others of the same species some of its sensations and desires. The organs of most animals are so formed, as readily to perceive and understand (as far as is necessary for their particular species of existence) the voice of those of their own kind; by means of which they assemble together, for the defence or preservation of the species. But as they rise higher in the order of intellectual powers, the powers of expression likewise increase. However, the voice alone, even when endowed with a great extent of modulation, is incapable of conveying all that variety of emotions and sensations, which on many occasions are necessary to be communicated. In all these cases, motion and gesture are called in to supply the defects of the voice. The amorous pigeon does not trust solely to his plaintive cooing in order to soften the rigour of his reluctant mate, but adds to it the most submissive and expressive gestures; and the faithful dog, finding his voice alone insufficient to express his joy at meeting with his master, is obliged to have recourse to a variety of endearing actions. But man—the most distinguished of all the animal creation,—although endowed with a power of voice and expression of countenance and gesture eminently superior to all the creatures of God—finds that all these united are not sufficient to express the infinite variety of ideas with which his mind is stored: for although these may powerfully express the passions and stronger feelings of the mind; yet as they are incapable of expressing the several progressive steps of perception by which his *reason* ascends

from one degree of knowledge to another, he has been obliged to discover, by means of his reasoning faculty, a method of expressing with certainty, and communicating with the utmost facility, every perception of his mind.—With this view, having observed, that besides the power of uttering simple sounds, and the several variations of these into acute or grave, open or shrill, &c. by which his stronger feelings were naturally expressed, he was likewise endowed with a power of stopping or interrupting these sounds, by certain closings of the lips with one another, and of the tongue with the palate, &c. he has taken advantage of these circumstances, and formed unto himself a language capable of expressing every perception of the mind; for by affixing at all times the same idea to any one sound or combination of sounds thus modified and joined together, he is enabled at any time to excite in the mind of any other person an idea similar to that in his own mind, provided the other person has been previously so far instructed as to know the particular modification of sound which has been agreed upon as the *symbol* of that idea.—Thus man is endowed with two different species of language: one consisting of tones and gestures; which as it is natural to man considered as a distinct species of animals, and necessary for the preservation and well-being of the whole, is universally understood by all mankind: thus laughter and mirth universally express cheerfulness of mind; while tears, in every part of the globe, discover a heart overflowing with tender sensations; and the humble tone of supplication, or the acute accent of pain, are equally understood by the Hurons of America, and by the more refined inhabitants of Europe. The other species of language, as it is entirely artificial, and derives its power from particular compact, (for before any thing can be recognized as the symbol of an idea, several persons must first agree that such an idea must always be denoted by this symbol,) must be different in different parts of the globe; and every distinct form which it may assume, from the different genius of every society who originally formed a particular language for themselves, will be altogether unintelligible to every other body of men, but those belonging to the same society where that language was originally invented, or those who have been at pains to acquire a knowledge of it by means of study.

It is unnecessary for us here to draw any parallel between the nature of these two different species of language; it being sufficiently evident, that the artificial language does not debar the use of the tones and gestures of the natural, but tends to ascertain the meaning of these with greater precision, and consequently to give them greater power. Man must therefore reap many advantages from the use of artificial language, which he could not have enjoyed without it. It is equally plain, that the one, being natural and inspired, must remain nearly the same, without making any progress to perfection; whereas the other, being entirely the invention of man, must have been exceedingly rude and imperfect at first, and must have arrived by slow degrees at greater and greater perfection, as the reasoning faculties acquired vigour and acuteness. It must likewise be subject to perpetual changes, from that variety of incidents which affect all sensible things:

and

and these changes must always correspond with the change of circumstances in the people who make use of that particular language : for when any particular set of ideas become prevalent among any society of men, words must be adopted to express them ; and from these the language must assume its character. Hence the reason why the language of all barbarous and uncivilized people is rude and uncultivated ; while those nations which have improved their reasoning faculties, and made some progress in the polite arts, have been no less distinguished by the superiority of their language than by their pre-eminence in other respects.—The language of a brave and martial people is bold and nervous, although perhaps rude and uncultivated ; while the language of those nations in which luxury and effeminacy prevail, is flowing and harmonious, but devoid of force and energy of expression.

It may be considered as a general rule, that the language of any nation is an exact index of the state of their minds. But as man is naturally an imitative animal, and in matters of this kind never has recourse to invention but through necessity ; if by some accident any part of a nation should be separated from that community to which they belonged, after a language had been invented, they would retain the same general sounds and *idiom* of language with those from whom they were separated ; although in process of time these two people, by living in countries of a dissimilar nature, or being engaged in different occupations, and leading a different manner of life, might in time lose all knowledge of one another, assume a different national character and opposite dispositions of mind, and form each of them a distinct language to themselves, totally different in genius and style, though agreeing with one another in the fundamental sounds and general *idiom* : so that if this particular *idiom*, formed before their separation, should happen to be more peculiarly adapted to the genius of one of these people than the other, that particular people whose natural genius and style of language was not in concord with the *idiom* which they had adopted, would labour under an inconvenience on this account which they never would be able entirely to overcome ; and this inconvenience would prevent their language from attaining such a degree of perfection, as the genius of the people would otherwise naturally have led them to. Thus languages have been originally formed ; and thus that happy concord of circumstances which have concurred to raise some languages to that height of perfection which they have attained may be easily accounted for, while many ineffectual efforts have been made to raise other languages to the same degree of excellence.

We shall not here enter upon any fruitless inquiries, with a view to discover if only one language was originally formed, or if any language that we are acquainted with has a greater claim to that much envied pre-eminence than others. We have seen, that the discovery of language is entirely within our reach, and evidently the invention of man ; and therefore that the invention of different languages by different societies, is extremely probable. But these different societies, in process of time, behoved to intermix by war or commerce, and their different languages would likewise become mixed.

Hence during the succession of many ages, while the principles of language were not understood, many different languages must have been formed, while others may have sunk into oblivion, especially in those early ages before the invention of letters, which alone could preserve their memory. In vain, therefore, would we endeavour to discover the state of those nations or languages of which we have but obscure traces in history. Indeed we have no reason to lament our loss in this particular ; for supposing such a discovery could be made, we could derive little advantage from it. The antiquity of a language does not imply any degree of excellence : some nations have made more progress in improving their mental faculties, and refining their language, in a few years, than others have done in many ages. We shall therefore leave this subject, and proceed to make some remarks on the advantages or defects of some of those *idioms* of language with which we are most intimately acquainted, as this may perhaps lead us to some discoveries of real utility to ourselves.

As the words *IDIOM* and *GENIUS* of a language are often confounded, it will be necessary to inform the reader, that by *IDIOM* we would here be understood to mean *that general mode of arranging words into sentences which prevails in any particular language* ; and by the *GENIUS* of a language we mean to express *the particular set of ideas which the words of any language, either from their formation or multiplicity, are most naturally apt to excite in the mind of any one who hears it properly uttered*. Thus although the *English*, *French*, *Italian*, and *Spanish* languages, nearly agree in the same general *IDIOM* ; yet the particular *GENIUS* of each is remarkably different : The *English* is naturally bold nervous, and strongly articulated ; the *French* is weaker, and more flowing ; the *Italian* more soothing and harmonious ; and the *Spanish* more grave, sonorous, and stately. Now, when we examine the several languages which have been most esteemed in Europe, we find that there are only two distinct *IDIOMS* among them which are essentially distinguished from one another ; and all these languages are divided between these two *idioms*, following sometimes the one, and sometimes the other, either wholly or in part. The languages which may be said to adhere to the first *IDIOM*, are those which in their construction follow the order of nature ; that is, express their ideas in the natural order in which they occur to the mind ; the subject which occasions the action appearing first ; then the action, accompanied with its several modifications ; and, last of all, the object to which it has reference.—These may be properly called *ANALOGOUS* languages ; and of this kind are the *English*, *French*, and most of the modern languages in Europe.—The languages which may be referred to the other *IDIOM*, are those which follow no other order in their construction than what the taste or fancy of the composer may suggest ; sometimes making the object, sometimes the action, and sometimes the modification of the action, to precede or follow the other parts. The confusion which this might occasion is avoided by the particular manner of *arranging* their words, by which they are made to refer to the others with which they ought to be connected, in what-

ever part of the sentence they occur, the mind being left at liberty to connect the several parts with one another after the whole sentence is concluded. And as the words may be here transposed at pleasure, those languages may be called *TRANSPOSITIVE* languages. To this class we must, in an especial manner, refer the *Latin* and *Greek* languages.—As each of these *IDIOMS* has several advantages and defects peculiar to itself, we shall endeavour to point out the most considerable of them, in order to ascertain with greater precision the particular character and excellence of some of those languages now principally spoken or studied in Europe.

The partiality which our forefathers, at the revival of letters in Europe, naturally entertained for the Greek and Roman languages, made them look upon every distinguishing peculiarity belonging to them, as *one* of the *many* causes of the amazing superiority which these languages evidently enjoyed above every other at that time spoken in Europe.—This blind deference still continues to be paid to them, as our minds are early prepossessed with these ideas, and as we are taught in our earliest infancy to believe, that to entertain the least idea of our own language being equal to the Greek or Latin in any particular whatever, would be a certain mark of ignorance or want of taste.—Their rights, therefore, like those of the church in former ages, remain still to be examined; and we, without exerting our reason to discover truth from falsehood, tamely sit down satisfied with the idea of their undoubted pre-eminence in every respect.—But if we look around us for a moment, and observe the many excellent productions which are to be met with in almost every language of Europe, we must be satisfied, that *even these* are now possessed of *some* powers which might afford at least a presumption, that, if they were cultivated with a proper degree of attention, they might, in *some respects*, be made to rival, if not to excel, those beautiful and justly admired remains of antiquity.—Without endeavouring to derogate from their merit, let us, with the cool eye of philosophic reasoning, endeavour to bring before the sacred tribunal of Truth some of those opinions which have been most generally received upon this subject, and rest the determination of the cause on her impartial decision.

The learned reader well knows, that the several changes which take place in the arrangement of the words in every *TRANSPOSITIVE* language could not be admitted without occasioning great confusion, unless certain classes of words were endowed with particular variations, by means of which they might be made to refer to the other words with which they ought naturally to be connected.—From this cause proceeds the necessity of several variations of *verbs*, *nouns*, and *adjectives*; which are not in the least essential or necessary in the *ANALOGOUS* languages, as we have pretty fully explained under the article *GRAMMAR*, to which we refer for satisfaction on this head. We shall in this place consider, whether these variations are an advantage or a disadvantage to language.

As it is generally supposed, that every language whose verbs admit of *inflection*, is on that account much more perfect than one where they are varied by *auxiliaries*; we shall, in the first place, examine this with some degree

of attention; and that what is said on this head may be the more intelligible, we shall give examples from the Latin and English languages. We make choice of these languages, because the Latin is more purely *transpositive* than the Greek, and the English admits of less *inflection* than any other language that we are acquainted with.

If any preference be due to a language from the one or the other method of *conjugating* verbs, it must in a great measure be owing to one or more of these three causes:—Either it must admit of a greater variety of sounds, and consequently more room for harmonious diversity of tones in the language;—or a greater freedom of expression is allowed in uttering any simple idea, by the one admitting of a greater variety in the arrangement of the words which are necessary to express that idea than the other does;—or, lastly, a greater precision and accuracy in fixing the meaning of the person who uses the language, arise from the use of one of these forms above the other!—for, 'as every other circumstance which may serve to give a diversity to language, such as the general and most prevalent sounds, the frequent repetition of any one particular letter, and a variety of other circumstances of that nature, which may serve to debase a particular language, are not influenced in the least by the different methods of varying the verbs, they cannot be here considered. We shall therefore proceed to make a comparison of the advantages or disadvantages which may accrue to a language by inflecting their verbs, with regard to each of these particulars.

The *first* particular that we have to examine, is, Whether the one method of expressing the variations of a verb admits of a greater variety of sounds.—In this respect the *Latin* seems, at first view, to have a great advantage over the *English*: for the word *amo*, *amabam*, *amaveram*, *amavero*, *amem*, &c. seem to be more different from one another than the English translations of these, *I love*, *I did love*, *I had loved*, *I shall have loved*, *I may love*, &c. for, although the syllable *AM* is repeated in every one of the first, yet as the last syllable usually strikes the ear with greater force, and leaves a greater impression than the first, it is very probable that many will think the frequent repetition of the word *LOVE* will, in the last instance, appear more striking to the ear than the other: we will therefore allow this its full weight, and grant that there is as great, or even a greater difference between the sounds of the different *tenses* of a Latin verb, than there is between the words that are equivalent to them in English.—But as we here consider the variety of sounds of the language in general, before any just conclusion can be drawn, we must not only compare the different parts of the same verb, but also compare the different verbs with one another in each of these languages.—And here, at first view, we perceive a most striking distinction in favours of the *analogous* language over the *inflected*: for as it would be impossible to form a particular set of inflections different from one another for each particular verb, all those languages which have adopted this method have been obliged to reduce their verbs into a small number of classes; all the words of each of which classes, commonly called *conjugations*, have the several variations of the *modes*, *tenses*, and *persons*, expressed



expressed exactly in the same manner, which must of necessity introduce a similarity of sounds into the language in general, much greater than where every particular verb always retains its own distinguishing sound.—To be convinced of this, we need only repeat any number of verbs in Latin and English, and observe one which side the preference with respect to variety of sounds must fall.

Pono,	<i>I put.</i>	Moveo,	<i>I move.</i>
Dono,	<i>I give.</i>	Doleo,	<i>I ail.</i>
Canō,	<i>I sing.</i>	Lugeo,	<i>I mourn.</i>
Sono,	<i>I sound.</i>	Obeo,	<i>I die.</i>
Orno,	<i>I adorn.</i>	Gaudeo,	<i>I rejoice.</i>
Pugno,	<i>I fight.</i>	Incipio,	<i>I begin.</i>
Lego,	<i>I read.</i>	Facio,	<i>I make.</i>
Scribo,	<i>I write.</i>	Fodio,	<i>I dig.</i>
Puto,	<i>I think.</i>	Odio,	<i>I hate.</i>
Vivo,	<i>I live.</i>	Rideo,	<i>I laugh.</i>
Ambulo,	<i>I walk.</i>	Impleo,	<i>I fill.</i>
Loqueo,	<i>I speak.</i>	Abstineo,	<i>I forbear.</i>

The similarity of sounds is here so obvious in the Latin as to be perceived at the first glance: nor can we be surprised to find it so, when we consider, that all their regular verbs, amounting to four thousand or upwards, must all be reduced to four conjugations, and even these differing but little from one another, which must of necessity produce the sameness of sounds which we here perceive; whereas every language that follows the natural order, like the English, instead of these small number of uniform terminations, have almost as many distinct sounds as original verbs in their language.

But if, instead of the present of the indicative mood, we should take almost any other tense of the Latin verb, the similarity of sounds would be still more perceptible, as many of these tenses have the same termination in all the four conjugations, particularly in the imperfect of the indicative, as below.

Pona bam;	<i>I did put,</i>	<i>I put.</i>
Dona bam;	<i>I did give,</i>	<i>I gave.</i>
Cano bam;	<i>I did sing,</i>	<i>I sung.</i>
Sona bam;	<i>I did sound,</i>	<i>I sounded.</i>
Orna bam;	<i>I did adorn,</i>	<i>I adorned.</i>
Pugna bam;	<i>I did fight,</i>	<i>I fought.</i>
Lege bam;	<i>I did read,</i>	<i>I read.</i>
Scribe bam;	<i>I did write,</i>	<i>I wrote.</i>
Putā bam;	<i>I did think,</i>	<i>I thought.</i>
Vive bam;	<i>I did live,</i>	<i>I lived.</i>
Ambula bam;	<i>I did walk,</i>	<i>I walked.</i>
Loque bam;	<i>I did speak,</i>	<i>I spoke.</i>
Move bam;	<i>I did move,</i>	<i>I moved.</i>
Dole bam;	<i>I did ail,</i>	<i>I ailed.</i>
Luge bam;	<i>I did mourn,</i>	<i>I mourned.</i>

\* We are sufficiently aware, that the last variation cannot in strictness be considered as good language; although many examples of this manner of using it in serious compositions, both in poetry and prose, might be easily produced from the best authors in the English language.—But however unjustifiable it may be to use it in serious composition; yet, when judiciously employed in works of humour, this and other forced expressions of the like nature produce a fine effect, by giving a burlesque air to the language, and beautifully contrasting it to the purer diction of solid reasoning. The sagacious Shakespeare has, on many occasions, shewed how successfully these may be employed in composition, particularly in drawing the character of *ancient Pistol*, in *Henry V.* Without this liberty, Butler would have found greater difficulty in drawing the inimitable character of *Hudibras*.—Let this apology suffice for our having inserted this and other variations of the same kind; which, although they may be often improper for serious composition, have still their use in language.

Obie bam;	<i>I did die,</i>	<i>I died.</i>
Gaudie bam;	<i>I did rejoice,</i>	<i>I rejoiced.</i>
Incipie bam;	<i>I did begin,</i>	<i>I began.</i>
Facie bam;	<i>I did make,</i>	<i>I made.</i>
Fodie bam;	<i>I did dig,</i>	<i>I dug.</i>
Odie bam;	<i>I did hate,</i>	<i>I hated.</i>
Ride bam;	<i>I did laugh,</i>	<i>I laughed.</i>
Imple bam;	<i>I did fill,</i>	<i>I filled.</i>
Abstinie bam;	<i>I did forbear,</i>	<i>I forbore.</i>

It is unnecessary to make any remarks on the Latin words in this example: but in the English translation we have carefully marked, in the first column, the words without any inflection; and, in the second, have put down the same meaning by an inflection of our verb; which we have been enabled to do, from a peculiar excellency in our own language unknown to any other, either ancient or modern.—Were it necessary to pursue this subject farther, we might observe, that the *perfect* tense in all the conjugations ends universally in *I*, the *pluperfect* in *ERAM*, the *future* in *AM* or *BO*; in the subjunctive mood, the *imperfect* universally in *REM*, the *perfect* in *ERIM*, and the *pluperfect* in *ISSEM* and *ERO*: and as a still greater sameness is observable in the different variations for the persons in these tenses, seeing the first person plural in all tenses ends in *MUS*, and the second person in *TIS*, with little variation in the other persons; it is evident, that, in respect of diversity of sounds, this method of conjugating verbs by *inflection*, is greatly inferior to the more natural method of expressing the various connections and relations of the verbal attributive by different words, usually called *auxiliaries*.

The second particular by which the different methods of marking the relation of the verbal attributive can affect language, arises from the variety of expressions, which either of these may admit of in uttering the same sentiment.—In this respect likewise the method of conjugating by inflection seems to be deficient. Thus the present of the indicative mood in Latin can at most be expressed only in two ways, *viz.* *SCRIBO*, and *EGO SCRIBO*; which ought perhaps in strictness to be admitted only as one: whereas, in English, we can vary it in four different ways, *viz.* *1<sup>st</sup>*, *I WRITE*; *2<sup>dly</sup>*, *I DO WRITE*; *3<sup>dly</sup>*, *WRITE I DO*; *4<sup>thly</sup>*, *WRITE DO I*\*. And if we consider the further variation which these receive in power as well as in sound, by having the accent placed on the different words; instead of four, we will find eleven different variations: thus, *1<sup>st</sup>*, *I write*, with the emphasis upon the *I*;—*2<sup>dly</sup>*, *I WRITE*, with the emphasis upon the word *WRITE*. Let any one pronounce these with the different accent necessary, and he will be immediately satisfied that they are not only distinct from each other with respect to meaning, but also with

regard

regard to sound; and the same must be understood of all the other parts of this example.

- |                       |                        |
|-----------------------|------------------------|
| 3. <i>I do write,</i> | 8. <i>Writs I do,</i>  |
| 4. <i>I DO write,</i> | 9. <i>WRITE do I,</i>  |
| 5. <i>I do WRITE,</i> | 10. <i>Write DO I,</i> |
| 6. <i>WRITE I do,</i> | 11. <i>Write do I.</i> |
| 7. <i>Write I do.</i> |                        |

None of the Latin tenses admit of more variations than the two above mentioned: nor do almost any of the English admit of fewer than in the above example; and several of these phrases, which must be considered as exact translations of some of the tenses of the Latin verb, admit of many more. Thus the imperfect of the subjunctive mood, which in Latin admits of the above two variations, admits in English of the following:

- |                               |                               |
|-------------------------------|-------------------------------|
| 1. <i>I might have wrote.</i> | 4. <i>Wrote might have I.</i> |
| 2. <i>Wrote I might have.</i> | 5. <i>I wrote might have.</i> |
| 3. <i>Have wrote I might.</i> | 6. <i>Have wrote might I.</i> |

And if we likewise consider the variations which may be produced by a variation of the emphasis, they will be as under.

- |                                |                                |
|--------------------------------|--------------------------------|
| 1. <i>I might have wrote.</i>  | 13. <i>WROTE might have I.</i> |
| 2. <i>I MIGHT have wrote.</i>  | 14. <i>Wrote MIGHT have I.</i> |
| 3. <i>I might HAVE wrote.</i>  | 15. <i>Wrote might HAVE I.</i> |
| 4. <i>I might have WROTE.</i>  | 16. <i>Wrote might have I.</i> |
| 5. <i>WROTE I might have.</i>  | 17. <i>I wrote might have.</i> |
| 6. <i>Wrote I might have.</i>  | 18. <i>I WROTE might have.</i> |
| 7. <i>Wrote I MIGHT have.</i>  | 19. <i>I wrote MIGHT have.</i> |
| 8. <i>Wrote I might HAVE.</i>  | 20. <i>I wrote might HAVE.</i> |
| 9. <i>HAVE wrote I might.</i>  | 21. <i>HAVE wrote might I.</i> |
| 10. <i>Have WROTE I might.</i> | 22. <i>Have WROTE might I.</i> |
| 11. <i>Have wrote I might.</i> | 23. <i>Have wrote MIGHT I.</i> |
| 12. <i>Have wrote I MIGHT.</i> | 24. <i>Have wrote might I.</i> |

In all twenty four variations, instead of two.—If we likewise consider, that the Latins were obliged to employ the same word, not only to express “*I might have wrote*” but also “*I could, I would, or I should have wrote,*” each of which would admit of the same variations as the word *might*, we have in all *ninety six* different expressions in English for the same phrase which in Latin admits only of two, unless they have recourse to other forced turns of expression, which the defects of their verbs in this particular has compelled them to invent.

But, if it should be objected, that the last circumstance we have taken notice of as a defect, can only be considered as a defect of the Latin language, and is not to be attributed to the *inflection* of their verbs, seeing they might have had a particular tense for each of these different words *might, could, would, and should*; we answer, that, even admitting this excuse as valid, the superiority of the analogous language, as such, still remains in this respect as twelve to one.—Yet even this concession is greater than ought to have been made: For as the difficulty of forming a sufficient variety of words for all the different modifications which a verb may be made to undergo is too great for any rude people to be able to overcome; we find, that every nation which has adopted this mode of inflection, not excepting the Greeks themselves, has been obliged to remain satisfied with fewer

words than would have been necessary even to effect this purpose, and make the same word serve a double, treble, or even quadruple office, as in the Latin tense which gave rise to these observations: So that however in physical necessity this may not be chargeable upon this particular mode of construction, yet in moral certainty this must always be the case; and therefore we may safely conclude, that the mode of varying verbs by *inflection* affords less variety in the arrangement of the words of the particular phrases, than the method of varying them by the help of auxiliaries.

But if there should still remain any shadow of doubt in the mind of the reader, whether the method of varying the verbs by *inflection*, is inferior to that by *auxiliaries*, with regard to diversity of sounds, or variety of expression; there cannot be the least doubt, but that, with respect to precision, distinctness, and accuracy in expressing any idea, the latter enjoys a superiority beyond all comparison.—Thus the Latin verb *Amo*, may be Englished either by the words *I love*, or *I do love*, and the emphasis placed upon any of the words that the circumstances may require; by means of which, the meaning is pointed out with a force and energy which it is altogether impossible to produce by the use of any single word. The following line from Shakespear's Othello may serve as an example;

—Excellent wretch!

Perdition catch my soul, but *I do love* thee:

In which the strong emphasis upon the word *do*, gives it a force and energy which conveys, in an irresistible manner, a most perfect knowledge of the situation of the mind of the speaker at the time.—That the whole energy of the expression depends upon this seemingly insignificant word, we may be at once satisfied of, by keeping it away in this manner;

—Excellent wretch!

Perdition catch my soul, but *I love* thee.

How poor—how tame—how insignificant is this, when compared with the other! Here nothing remains but a tame assertion, ushered in with a pompous exclamation which could not here be introduced with any degree of propriety. Whereas, in the way that Shakespear has left it to us, it has a forcible power which nothing can surpass; for, overpowered with the irresistible force of Desdemona's charms, this strong exclamation is forced from the soul of Othello in spite of himself. Surprised at this tender emotion which brings to his mind all those amiable qualities for which he had so much esteemed her, and at the same time fully impressed with the firm persuasion of her guilt, he bursts out into that seemingly inconsistent exclamation—*Excellent wretch!* And then he adds in the warmth of his surprise,—thinking it a thing most astonishing that any warmth of affection should still remain in his breast, he even confirms it with an oath.—“*Perdition catch my soul, but I do love thee.*”—“In spite of all the falsehoods with which I know thou hast deceived me—in spite of all the crimes of which I know thee guilty—in spite of all these reasons for which I ought to hate thee—in spite of myself,—still I find that I love,—yes, I do love thee.”—We look upon it as a thing altogether impossible to trans-

ful

use the energy of this expression into any language whose verbs are regularly inflected.

In the same manner we might go through all the other tenses, and shew that the same superiority is to be found in each—Thus in the *perfect tense* of the Latins, instead of the simple *AMAVI*, we say, *I HAVE LOVED*; and by the liberty we have of putting the emphasis upon any of the words which compose this phrase, we can in the most accurate manner fix the precise idea which we mean to excite: for if we say *I have loved*, with the emphasis upon the word *I*, it at once points out the person as the principal object in that phrase, and makes us naturally look for a contrast in some other person, and the other parts of the phrase become subordinate to it;—“*HE has loved thee much, but I have loved thee infinitely more*”—The Latins too, as they were not prohibited from joining the pronoun with their verb, were also acquainted with this excellence, which Virgil has beautifully used in this verse:

—————*Nos patriam fugimus ;*  
*Tu, Tyters, lentis in umbra, &c.*

But we are not only enabled thus to distinguish the person in as powerful a manner as the Latins, but can also with the same facility point out any of the other circumstances as principals; for if we say, with the emphasis upon the word *Have*, “*I HAVE loved*,” it as naturally points out the time as the principal object, and makes us look for a contrast in that peculiarity, *I HAVE*: “*I have loved indeed;—my imagination has been led astray—my reason has been perverted:—but, now that time has opened my eyes, I can smile at those imaginary distresses which once perplexed me.*”—In the same manner we can put the emphasis upon the other word of the phrase *loved*,—“*I have LOVED.*”—Here the passion is exhibited as the principal circumstance; and as this can never be excited without some object, we naturally wish to know the object of that passion—“*Who! what have you loved?*” are the natural questions we would put in his case. “*I have LOVED —Eliza.*”—In this manner we are, on all occasions, enabled to express, with the utmost precision, that particular idea which we would wish to excite, so as to give an energy and perspicuity to the language, which can never be attained by those languages whose verbs are conjugated by inflection; and if to this we add the inconvenience which all inflected languages are subjected to, by having too small a number of tenses, so as to be compelled to make one word on many occasions supply the place of two, three, or even four, the balance is turned still more in our favours.—Thus, in Latin, the same word *AMABO* stands for *shall* or *will* love, so that the reader is left to guess from the context which of the two meanings it was most likely the writer had in view.—In the same manner, *may* or *can* love are expressed by the same word *AMEM*; as is also *might*, *could*, *would*, or *should* love, by the single word *AMAREM*, as we have already observed; so that the reader is left to guess which of these four meanings the writer intended to express; which occasions a perplexity very different from that clear precision which our language allows of, by not only pointing out the different words, but also by allowing us to put the emphasis upon

any of them we please, which superadds energy and force to the precision it would have had without that of assistance.

Upon the whole, therefore, after the most candid examination, we must conclude, that the method of conjugating verbs by *inflection* is inferior to that which is performed by the help of *auxiliaries*;—because it does not afford such a diversity of sounds,—nor allow such variety in the arrangement of expression for the same thought,—nor give so much distinction and precision in the meaning.—It is, however, attended with one considerable advantage above the other method: for as the words of which it is formed are necessarily of greater length, and more sonorous, than in the analogous languages, it admits of a more flowing harmony of expression; for the number of monosyllables in this last greatly checks that pompous dignity which naturally results from longer words. Whether this single advantage is sufficient to counterbalance all the other defects with which it is attended; is left to the judgment of the reader to determine:—but we may remark, before we quit the subject, that even this excellence is attended with some peculiar inconveniences, which shall be more particularly pointed out in the sequel.

But perhaps it might still be objected, that the comparison we have made above, although it may be fair, and the conclusion just with regard to the Latin and English languages; yet it does not appear clear, that on that account the method of conjugating verbs by *inflection* is inferior to that by *auxiliaries*: for although it be allowed, that the Latin language is defective in point of tenses; yet if a language were formed which had a sufficient number of inflected tenses to answer every purpose; if it had, for instance, a word properly formed for every variation of each tense; one for *I love*, another for *I do love*; one for *I shall*, another for *I will love*; one for *I might*, another for *I could*, and *would*, and *should* love; and so on through all the other tenses; that this language would not be liable to the objections we have brought against the inflection of verbs; and that of course, the objections we have brought are only valid against those languages which have followed that mode and executed it imperfectly.—We answer, that although this would in some measure remedy the evil, yet it would not remove it entirely. For in the first place, unless every verb, or a very small number of verbs, was conjugated in one way, having the sound of the words in each tense, and divisions of tenses, as we may say, different from all the other conjugations,—it would always occasion a sameness of sounds which would in some measure prevent that variety of sounds so proper for a language. And even if this could be effected, it would not give such a latitude to the expression as auxiliaries allow: for although there should be two words, one for *I might*, and another for *I could* love; yet as these are single words, they cannot be varied; whereas, by auxiliaries, either of these can be varied twenty-four different ways, as has been shewn above.—In the last place, no single word can ever express all that variety of meaning which we can do by the help of our auxiliaries and the emphasis. *I have loved*, if expressed by any one word, could only denote at all times one distinct meaning; so that, to give it

it the power of ours, there behoved to be three distinct words at least. However, if all this was done;—that is, if there was a distinct conjugation formed for every forty or fifty verbs;—if each of the tenses was properly formed, and all of them different from every other tense as well as every other verb; and these all carried through each of the different persons, so as to be all different from one another;—and if likewise there was a distinct word to mark each of the separate meanings which the same tense could be made to assume by means of the emphasis;—and if all this infinite variety of words could be formed in a distinct manner, different from each other and harmonious;—this language would have powers greater than any that could be formed by auxiliaries, if it were possible for the human powers to acquire such a degree of knowledge as to be able to employ it with facility. But how could this be attained, since upwards of ten thousand words would be necessary to form the variations of any one verb, and a hundred times that number would not include the knowledge of the verbs alone of such a language\*?—How much, therefore, ought we to admire the simple perspicuity of our language, which enables us, by the proper application of ten or twelve seemingly trifling words, the meaning and use of which can be attained with the utmost ease, to express all that could be expressed by this unwieldy apparatus? What can equal the simplicity or the power of the one method, but the well known powers of the twenty-four letters, the knowledge of which can be obtained with so much ease—and their power knows no limits?—or what can be compared to the fancied perfection of the other, but the transcript of it which the Chinese seem to have formed in their unintelligible language?

Having thus considered pretty fully the advantages and defects of each of these two methods of varying verbs, we cannot help feeling a secret wish arise in our mind, that there had been a people sagacious enough to have united the powers of the one method with those of the other;—nor can we help being surprised, that, among the changes which took place in the several languages of Europe after the downfall of the Roman monarchy, some of them did not accidentally stumble on the method of doing it.—From many concurring circumstances, it seems probable, that the greatest part, if not all the Gothic nations that over-ran Italy at that time, had their verbs varied by the help of auxiliaries; and many of the modern European languages which have sprung from them, have so far borrowed from the Latin, as to have some of the tenses of their verbs inflected: yet the English alone have in any instance combined the joint powers of the two: which could only be done by forming inflections for the different tenses in the same manner as the Latins, and at the same time retaining the original method of varying them by auxiliaries; by which means either the one or the other method could have been employed as occasion required.—We have luckily two tenses formed in that way; the

VOL. II. No. 63.

2

†

9 K

acquainted

*present* of the indicative, and the *pass.* In almost all our verbs these can be declined either with or without auxiliaries. Thus the present, without an auxiliary, is, *I love, I write, I speak*; with an auxiliary, *I do write, I do love, I do speak*. In the same manner, the past tense, by inflection, is, *I loved, I wrote, I spoke*; by auxiliaries, *I did love, I did speak, I did write*. Every author, who knows any thing of the power of the English language, knows the use which may be made of this distinction. What a pity is it that we should have stopt short so soon? how blind was it in so many other nations to imitate the defects, without making a proper use of that beautiful language which is now numbered among the dead?

After the verbs, the next most considerable variation we find between the *Analogous* and *transpositive* languages, is in the nouns; the latter varying the different cases of these by *inflection*; whereas the former express all the different variations of them by the help of other words prefixed, called *prepositions*. Now, if we consider the advantages or disadvantages of either of these methods under the same heads as we have done the verbs, we will find, that with regard to the first particular, *viz.* variety of sounds, almost the same remarks may be made as upon the verbs;—for if we compare any particular noun by itself, the variety of sound appears much greater between the different cases in the *Transpositive*, than between the translation of these in the *Analogous* language. Thus, *REX, REGIS, REGI, REGEM, &c.* are more distinct from one another in point of sound, than the translation of these, *a king, of a king, to a king, a king, &c.* But if we proceed one step further, and consider the variety which is produced in the language *in general*, by the one or the other of these methods, the case is entirely reversed. For as it would have been impossible to form distinct variations, different from one another, for each case of every noun, they have been obliged to reduce all their nouns into a few general classes, called *declensions*, and endowed all of those included under each class with the same termination in every case; which produces a like similarity of sound with what we already observed was occasioned to the verbs from the same cause; whereas in the analogous languages, as there is no necessity for any constraint, there is almost as great a variety of sounds as there are of nouns. The Latins have only five different declensions, so that all the great number of words of this general order must be reduced to the very small diversity of sounds which these few classes admit of; and even the sounds of these few classes are not so much diversified as they ought to have been, as many of the different *cases* in the different *declensions* have exactly the same sounds, as we shall have occasion to remark more fully hereafter.—We might here produce examples to shew the great *similarity* of sounds between different nouns in the Latin language, and *variety* in the English, in the same way as we did of the verbs: but as every reader, in the least

\* This assertion may perhaps appear to many very much exaggerated: but if any should think so, we only beg the favour that he will set himself to mark all the variation of tenses, mode, person, and number, which an English verb can be made to assume, varying each of these in every way that it will admit, both as to the diversity of expressions, and the emphasis; he will soon be convinced that we have here said nothing more than enough.

acquainted with these two languages, can satisfy himself in this particular, without any further trouble than by marking down any number of Latin nouns, with their translations in English; we thought it unnecessary to dwell longer on this particular.

But if the inflection of nouns is a disadvantage to a language in point of diversity of sounds, it is very much the reverse with regard to the variety it allows in the arranging the words of the phrase. Here, indeed, the Transpositive language shines forth in all its glory, and the Analogous must yield the palm without the smallest dispute. For as the *nominative case* (or that noun which is the cause of that energy expressed by the verb) is different from the *accusative* (or that noun upon which the energy expressed by the verb is exerted) these may be placed in any situation that the writer shall think proper, without occasioning the smallest confusion: whereas in the analogous languages, as these two different states of the noun are expressed by the same word, they cannot be distinguished but by their position alone; so that the noun which is the efficient cause must always precede the verb, and that which is the active subject must follow; which greatly cramps the harmonious flow of composition.—Thus the Latins, without the smallest perplexity in the meaning, could say either *Brutum amavit Cassius*, or *Cassius amavit Brutum*, or *Brutum Cassius amavit*, or *Cassius Brutum amavit*. As the termination of the word *Cassius* always points out that it is in the *nominative case*, and therefore that he is the person from whom the energy proceeds; and in the same manner, as the termination of the word *Brutum* points out that it is in the *accusative case*, and consequently that he is the object upon which the energy is exerted; the meaning continues still distinct and clear, notwithstanding of all these several variations: whereas in the English language, we could only say *Cassius loved Brutus*, or, by a more forced phraseology, *Cassius Brutus loved*: Were we to reverse the case, as in the Latin, the meaning also would be reversed; for if we say *Brutus loved Cassius*, it is evident, that, instead of being the person beloved, as before, *Brutus* now becomes the person from whom the energy proceeds, and *Cassius* becomes the object beloved.—In this respect, therefore, the analogous languages are greatly inferior to the transpositive; and indeed it is from this single circumstance alone that they derive their chief excellence.

But although it thus appears evident, that any language, which has a particular variation of its nouns to distinguish the *accusative* from the *nominative case*, has an advantage over those languages which have none; yet it does not appear that any other of their *cases* adds to the variety, but rather the reverse: for, in Latin, we can only say *Amor Dei*; in English the same phrase may be rendered, either,—*the love of God*,—*of God the love*,—or, by a more forced arrangement, *God the love of*. And as these oblique cases, as the Latins called them, except the accusative, are clearly distinguished from one another, and from the nominative, by the preposition which accompanies them, we are not confined to any particular arrangement with regard to these as with the accusative, but may place them in what

order we please, as in Milton's elegant invocation at the beginning of *Paradise Lost*:—

Oh man's first disobedience, and the fruit  
Of that forbidden tree, whose mortal taste  
Brought death into the world, and all our wo,  
With loss of Eden, till one greater Man  
Restore us, and regain the blissful seat,  
Sing, heavenly muse.

In this sentence the transposition is almost as great as the Latin language would admit of, and the meaning as distinct as if Milton had begun with the plain language of prose, thus,—“Heavenly muse, sing of man's first disobedience,” &c.

Before we leave this head, we may remark, that the little attention which seems to have been paid to this peculiar advantage derived from the use of an accusative case different from the nominative, is somewhat surprising.—The Latins, who had more occasion to attend to this with care than any other nation, have in many cases overlooked it, as is evident from the many instances we meet with in their language where this is not distinguished. For the nominative and accusative are the same in the singular number of all those of the first declension ending in *æ*; as is likewise the case with those in *um* of the second, in *æ* of the third, and in *u* of the fourth. In the plural number, there is no distinction between these two cases in those of the second declension ending in *um*, nor in all those of the third, fourth, and fifth, of every termination, the number of which is very considerable. So that their language reaps no advantage in this respect from almost one half of their nouns. Nor have any of the modern languages in Europe, however much they may have borrowed from the ancient languages in other respects, attempted to copy from them in this particular; from which perhaps more advantage would have been gained, than from copying all the other supposed excellencies of their language.—But to return to our subject.

It remains that we consider, whether the inflection of nouns gives any advantage over the method of defining them by prepositions, in point of distinctness and precision of meaning.—But in this respect too the analogous language must come off victorious.—Indeed this is the particular in which their greatest excellence consists; nor was it, we believe, ever disputed, but that, in point of accuracy and precision, this method must excel all others, however it may be defective in other respects.—We observed under this head, when speaking of verbs, that it might perhaps be possible to form a language by inflection which should be capable of as great accuracy as in the more simple order of auxiliaries: but this would have been such an infinite labour, that it was not to be expected that ever human powers would have been able to accomplish it. More easy would it have been to have formed the several inflections of the nouns so different from one another, as to have rendered it impossible ever to mistake the meaning. Yet even this has not been attempted. And as we find that those languages which have adopted the method of inflecting their verbs are more imperfect in point of precision than the other, so the same may be said of inflecting the nouns: for, not to mention the energy which

which the analogous languages acquire by putting the accent upon the noun, or its preposition (when in an oblique case), according as the subject may require, to express which variation of meaning no particular variety of words have been invented in any inflected language, they are not even complete in other respects.—The Latin, in particular, is in many cases defective, the same termination being employed in many instances for different cases of the same noun.—Thus the genitive and dative singular, and nominative and vocative plural, of the first declension, are all exactly alike, and can only be distinguished from one another by the formation of the sentences;—as are also the nominative, vocative and ablative singular, and the dative and ablative plural. In the second, the genitive singular, and nominative and vocative plural, are the same; as are also the dative and ablative singular, and dative and ablative plural; except those in *um*, whose nominative, accusative, and vocative singular, and nominative, accusative and vocative plural, are alike. The other three declensions agree in as many of their cases as these do; which evidently tends to perplex the meaning, unless the hearer is particularly attentive to, and well acquainted with, the particular construction of the other parts of the sentence; all of which is totally removed, and the clearest certainty exhibited, at once, by the help of prepositions in the analogous languages.

It will hardly be necessary to enter into such a minute examination of the advantages or disadvantages attending the variation of *adjectives*: as it will appear evident, from what has been already said, that the endowing them with terminations similar to, and corresponding with the nouns, must tend still more and more to increase the similarity of sounds in any language, than any of those particulars we have already taken notice of; and were it not for the liberty which they have, in transpositive languages, of separating the adjective from the noun, this must have occasioned such a jingle of similar sounds as behoved to have been most disgusting to the ear: but as it would have been impossible in many cases, in those languages where the verbs and nouns are inflected, to have pronounced the words which ought to have followed each other, unless their adjectives could have been separated from the nouns; therefore, to remedy this inconvenience, they were forced to devise this unnatural method of inflecting them also; by which means it is easy to recognize to what noun any adjective has a reference, in whatever part of the sentence it may be placed.—In these languages, therefore, this inflection, both as to gender, number, and case, becomes absolutely necessary; and, by the diversity which it admitted in the arranging the words of the several phrases, might counterbalance the jingle of similar sounds which it introduced into the language.—But what shall we say of those European nations, who, although possessed of a language in every respect different from the transpositive idiom, have nevertheless adopted the variations of their adjectives in the fullest sense? for here they have nothing to counterbalance this disagreeable jingle of similar sounds, so destructive of all real harmony.—In the days of monkish ignorance, when this custom was probably introduced, the clashing of words with one another might be esteemed an ornament; but now that mankind

have attained a higher sense of harmony and propriety, we in Britain may felicitate ourselves to find, that our language has escaped this mark of barbarity, which so many others are now subjected to.

Having thus examined the most striking particulars in which the transpositive and analogous languages differ, and endeavoured to show the general tendency of every one of the particulars separately, it would not be fair to dismiss the subject without considering each of these as a whole, and pointing out their general tendency in that light: for we all know, that it often happens in human inventions, that every part which composes a whole, taken separately, may appear extremely fine; and yet, when all these parts are put together, they may not agree, but produce a jarring and confusion very different from what we might have expected. We therefore imagine a few remarks upon the genius of each of these two distinct idioms of language considered as a whole will not be deemed useless.

Although all languages agree in this respect, that they are the means of conveying the ideas of one man to another; yet as there are an infinite variety of ways in which we might wish to convey these ideas, sometimes by the easy and familiar mode of conversation, and at other times by more solemn addresses to the understanding, by pompous declamation, &c. it may so happen, that the genius of one language may be more properly adapted to the one of these than the other, while another language may excel in the opposite particular. This is exactly the case in the two general idioms of which we now treat.—Every particular in a *transpositive* language, is peculiarly calculated for that solemn dignity which is necessary for pompous orations. Long sounding words, formed by the inflection of the different parts of speech,—flowing periods, in which the attention is kept awake by the harmony of the sounds, and an expectation of that word which is to unravel the whole,—if composed by a skilful artist, are admirably suited to that solemn dignity and awful grace which constitute the essence of a public harangue. On the contrary, in private conversation, where the mind wishes to unbend itself with ease, these become so many clogs which encumber and perplex. At these moments we wish to transfuse our thoughts with ease and facility—we are tired with every unnecessary syllable—and wish to be freed of the trouble of attention as much as may be. Like our state-ropes, we would wish to lay aside our pompous language, and enjoy ourselves at home with freedom and ease. Here the solemnity and windings of the *transpositive* language are burdensome; while the facility with which a sentiment can be expressed in the *analogous* language is the thing that we wish to acquire.—In this humble, though most engaging sphere, the analogous language moves unrivalled;—in this it wishes to indulge, and never tires. But it in vain attempts to rival the *transpositive* in dignity and pomp: The number of monosyllables interrupt the flow of harmony; and altho' they may give a greater variety of sounds, yet they do not naturally possess that dignified gravity which suits the other language. This, then, must be considered as the striking particular in the genius of these two different idioms, which marks their characters.

If

If we consider the effects which these two different characters of language must naturally produce upon the people who employ them, we will soon perceive, that the genius of the *analogous* language is much more favourable for the most engaging purposes of life, the civilizing the human mind by mutual intercourse of thought, *than the transpositive*. For as it is chiefly by the use of speech that man is raised above the brute creation;—as it is by this means he improves every faculty of his mind, and, to the observations which he may himself have made, has the additional advantage of the experience of those with whom he may converse, as well as the knowledge which the human race have acquired by accumulated experience of all preceding ages;—as it is by the enlivening glow of conversation that kindred souls catch fire from one another, that thought produces thought, and each improves upon the other, till they soar beyond the bounds which human reason, if left alone, could ever have aspired to;—we must surely consider that language as the most beneficial to society, which most effectually removes these bars that obstruct its progress. Now, the genius of the *analogous* languages is so easy, so simple and plain, as to be within the reach of every one who is born in the kingdom where it is used, to speak it with facility; even the rudest among the vulgar can hardly fall into any grammatical errors: whereas, in the *transpositive* languages, so many rules are necessary to be attended to, and so much variation is produced in the meaning by the slightest variations in the sound, that it requires a study far above the reach of the illiterate mechanic ever to attain. So that, how perfect soever the language may be when spoken with purity, the bulk of the nation must ever labour under the inconvenience of rudeness and inaccuracy of speech, and all the evils which this naturally produces.—Accordingly we find, that in Rome, a man, even in the highest rank, received as much honour, and was as much distinguished among his equals, for being able to converse with ease, as a modern author would be for writing in an easy and elegant style; and Cæsar among his contemporaries was as much esteemed for his superiority in speaking the language in ordinary conversation with ease and elegance, as for his powers of oratory, his skill in arms, or his excellence in literary composition. It is needless to point out the many inconveniences that this behoved to produce in a state. It is sufficient to observe, that it naturally tends to introduce a vast distinction between the different orders of men; to set an impenetrable barrier between those born in a high and those born in a low station; to keep the latter in ignorance and barbarity, while it elevates the former to such a height as must subject the other to be easily led by every popular demagogue.—How far the history of the nations who have followed this IDIOM of language confirms this observation, every one is left to judge for himself.

Having thus considered LANGUAGE in general, and pointed out the genius and tendency of the two most distinguished IDIOMS which have prevailed; we shall close these remarks with a few observations upon the particular nature and genius of those languages which are now chiefly studied or spoken in Europe.

Of all the nations whose memory history has trans-

mitted to us, none have been so eminently distinguished for their literary accomplishments, as well as acquaintance with the polite arts, as the Greeks; nor are we as yet acquainted with a language possessed of so many advantages, with so few defects, as that which they used, and which continues still to be known by their name.—The necessary connection between the progress of knowledge and the improvement of language has been already explained; so that it will not be surprising to find their progress in the one keep pace with that of the other: but it will be of utility to point out some advantages which that distinguished people possessed, which other nations, perhaps not less distinguished for talents or taste, have not enjoyed, which has contributed to render their language the most universally admired in ancient as well as in modern times.

As it is probable, that many different societies of men, in the early ages of antiquity, may have found them selves in such circumstances as to be obliged to invent a language to themselves; each would naturally adopt those sounds into their language which chance might suggest, or were most agreeable to their perception of harmony, or most consonant to the disposition of mind of the original inventors; in the same manner as we see that each composer of music has a particular species of sounds of which he is fonder than any other, which will predominate through all his compositions, and give them a certain characteristic tone by which they may be distinguished from that of other composers:—So the language of each particular set of people would have originally a certain characteristic tone of harmony, which would distinguish it from all others; and behoved to be more or less perfect, according to the greater or less degree of that delicate sense of harmony, distinguished by the name of *taste*, which these original inventors were possessed of. These sounds, then, being once established by custom, would become familiar to the ear of the descendants of these particular tribes: new words would be invented as knowledge increased; but these behoved to be modulated so as to be agreeable to the general tenor of their language, from the necessity of making it consonant as well to the organs of hearing as the organs of speech.—Hence it happens, that the characteristic tones of a language are preserved much longer without variation than any other particular relating to it; and if it change at all, the change must be slow and imperceptible. Knowledge after this may increase;—taste may be improved;—it may be perceived that the language is not copious enough to express the ideas, or harmonious enough to please the ear of the composer;—he may readily invent words to supply the deficiency in that respect; but the sounds in a great measure remain without the reach of his power, and he must rest satisfied with these, such as they are, without attempting innovations.—Happy therefore, in this respect, must we deem those nations, whose earliest ancestors have been so fortunate as to adopt no unharmonious sounds into their language, whereby they are freed from one bar to the cultivating those refined pleasures which proceed from the use of a delicate taste, which others may perhaps never be able to surmount:—and in this respect no nation was ever so eminently distinguished as the

the Greeks; which no doubt contributed its share to promote that general elegance and harmony of proportion which prevailed in all their arts. The original sounds and fundamental tones of that language are the most harmonious, and the most agreeable to the ear, of any that have hitherto been invented; inasmuch, that from this principle alone the sound of their language is agreeable to every nation who have heard it, even when the meaning of the words are not understood; whereas almost all other languages, till they are understood, appear, to an ear which has not been accustomed to them, jarring and discordant. This is the fundamental excellence of that justly admired language; nor have the people failed to improve this to the utmost of their power, by many aids of their own invention.—The Greek language is of the *transpositive* kind: but a people so lively, so acute, and so loquacious, could ill bear the ceremonious restraint which that mode of language naturally subjected them to; and have therefore, by various methods, freed it in a great measure from the stiffness which that produced. In inflecting their nouns and verbs, they sometimes prefix a syllable, and sometimes add one; which, besides the variety that it gives to the sounds of the language, adds greatly to the distinctness, and admits of a more natural arrangement of the words than in the Latin, and of consequence renders it much fitter for the easiness of private conversation: and indeed, the genius of the people so far prevailed over the *idiom* of the language, as to render it, in the age of its greatest perfection, capable of almost as much ease, and requiring almost as little transposition of words, as those languages which have been called analogous. But as those nations who spoke this language were all governed by popular assemblies, and as no authority could be obtained among them but by a skill in rhetoric and the powers of persuasion; it became necessary for every one, who wished to acquire power or consideration in the state, to improve himself in the knowledge of that language, in the use of which alone he could expect honours or reputation. Hence it happened, that while the vivacity of the people rendered it easy, the great men studiously improved every excellence that it could reap from its powers as a *transpositive* language; so that, when brought to its utmost perfection by the amazing genius of the great Demosthenes, it attained a power altogether unknown to any other language.—Thus happily circumstanced, the Greek language arrived at that envied pre-eminence which it still justly retains. From the progress of arts and sciences; from the gaiety and inventive genius of the people; from the number of free states into which Greece was divided, each of which invented words of its own, all of which contributed to the general stock; and from the natural commutation which took place between these states, which excited in the strongest degree the talents of the people; it acquired a copiousness unknown to any ancient language, and excelled by few of the moderns.—In point of harmony of numbers, it is altogether unrivalled; and on account of the ease as well as dignity which it admitted of from the causes assigned above, it admits of perfection in a greater number of particular kinds of composition than any other language ever known.—The irresistible force and overwhelming impetuosity of

*Demosthenes* seems not more natural to the genius of the language; than the more flowery charms of Plato's calm and harmonious cadences, or the unadorned simplicity of Xenophon; nor does the majestic pomp of Homer seem to be more naturally adapted to the genius of the language, than the more humble strains of Theocritus, or the laughing festivity of Anacreon: Equally adapted to all purposes, when we peruse any of these authors, we would imagine the language was most happily adapted for his particular style alone. The same powers it likewise in a great measure possessed for conversation; and the dialogue seems not more natural for the dignity of Sophocles or Euripides, than for the more easy tenderness of Menander, or buffoonery of Aristophanes.—With all these advantages, however, it must be acknowledged, that it did not possess that unexceptionable clearness of meaning, which some analogous languages enjoy, or that characteristic force which the accent has power to give it, were not these defects counterbalanced by other causes which we shall afterwards point out.

The Romans, a people of fierce and warlike dispositions, for many ages during the infancy of their republic, more intent on pursuing conquests and military glory, than in making improvements in literature or the fine arts, bestowed little attention to their language. Of a disposition less social and more phlegmatic than the Greeks, they gave themselves no trouble about rendering their language fit for conversation; and it remained strong and nervous, but, like their ideas, was limited and confined. More disposed to command respect by the power of their arms than by the force of persuasion, they despised the more effeminate powers of speech: so that, before the Punic wars, their language was perhaps more reserved and uncourtly than any other at that time known.—But after their rival Carthage was destroyed, and they had no longer that powerful curb upon their ambition; when riches flowed in upon them by the multiplicity of that conquests;—luxury began to prevail, the stern austerity of their manners to relax, and selfish ambition to take place of that disinterested love for their country so eminently conspicuous among all orders of men before that period.—Popularity began then to be courted: ambitious men, finding themselves not possessed of that merit which insured them success with the virtuous senate, amused the mob with artful and seditious harangues; and by making them believe that they were possessed of all power, and had their sacred rights encroached upon by the senate, led them about at their pleasure, and got themselves exalted to honours and riches by these insidious arts. It was then the Romans first began to perceive the use to which a command of language could be put.—Ambitious men then studied it with care, to be able to accomplish their ends; while the more virtuous were obliged to acquire a skill in this, that they might be able to repel the attacks of their adversaries.—Thus it happened, that in a short time that people, from having entirely neglected, began to study their language with the greatest assiduity; and as Greece happened to be subjected to the Roman yoke about that time, and a friendly intercourse was established between these two countries, this greatly conpired to nourish in the



minds of the Romans a taste for that art of which they had lately become so much enamoured. Greece had, long before this period, been corrupted by luxury; their taste for the fine arts had degenerated into unnecessary refinement; and all their patriotism consisted in popular harangues and unmeaning declamation. Oratory was then studied as a refined art; and all the subtleties of it were taught by rule, with as great care as the gladiators were afterwards trained up in Rome. But while they were thus idly trying who should be the lord of their own people, the nerves of government were relaxed, and they became an easy prey to every invading power. In this situation they became the *subjects*, under the title of the *allies*, of Rome, and introduced among them the same taste for haranging which prevailed among themselves. Well acquainted as they were with the powers of their own language, they set themselves with unwearied assiduity to polish and improve that of their new masters: but with all their assiduity and pains they never were able to make it arrive at that perfection which their own language had acquired; and in the Augustan age, when it had arrived at the summit of its glory, Cicero bitterly complains of its want of copiousness in many particulars.

But as it was the desire of all who studied this language with care, to make it capable of that stately dignity and pomp necessary for public harangues; they followed the genius of the language in this particular, and in a great measure neglected those lesser delicacies which form the pleasure of domestic enjoyment; so that, while it acquired more copiousness, more harmony, and precision, it remained stiff and inflexible for conversation; nor could the minute distinction of nice grammatical rules be ever brought down to the apprehension of the vulgar; so that the language spoken among the lower class of people remained rude and unpolished even till the end of the monarchy. The Huns who over run Italy, incapable of acquiring any knowledge of such a difficult and abstruse language, never adopted it; and the native inhabitants being made acquainted with a language more natural and easily acquired, quickly adopted that idiom of speech introduced by their conquerors, although they still retained many of those words which the confined nature of the barbarian language made necessary to allow them, to express their ideas.—And thus it was that the language of Rome, that proud mistress of the world, from an original defect in its formation, although it had been carried to a perfection in other respects far superior to any northern language at that time, easily gave way to them, and in a few ages the knowledge of it was lost among mankind: while, on the contrary, the more easy nature of the Greek language has still been able to keep some slight footing in the world, although the nations in which it has been spoken have been subjected to the yoke of foreign dominion for upwards of two thousand years, and their country has been twice ravaged by barbarous nations, and more cruelly depressed than ever the Romans were.

From the view which we have already given of the Latin language, it appears evident, that its idiom was more strictly transpositive than any other language yet known, and was attended with all the defects to which that idiom

is naturally subjected: nor could it boast of such favourable alleviating circumstances as the Greek, the prevailing sounds of the Latin being far less harmonious to the ear: and although the formation of the words are such as to admit of full and distinct sounds, and so modulated as to lay no restraint upon the voice of the speaker; yet, to a person unacquainted with the language, they do not convey that enchanting harmony so remarkable in the Greek language. The Latin is stately and solemn, it does not excite disgust; but at the same time it does not charm the ear, so as to make it listen with pleased attention. To one acquainted with the language indeed, the nervous boldness of the thoughts, the harmonious rounding of the periods, the full solemn swelling of the sounds, so distinguishable in the most eminent writers in that language which have been preferred to us, all conspire to make it pleasing and agreeable.—In these admired works we meet with all its beauties, without perceiving any of its defects; and we naturally admire, as perfect, a language which is capable of producing such excellent works.—Yet with all these seeming excellencies, this language is less copious, and more limited in its style of composition, than many modern languages far less capable of precision and accuracy than almost any of these, and infinitely behind them all in point of easiness in conversation. But these points have been so fully proved already, as to require no further illustration.—Of the compositions in that language which have been preferred to us, the *orations* of Cicero are best adapted to the genius of the language, and we there see it in its utmost perfection. In the *philosophical works* of that great author we perceive some of its defects; and it requires all the powers of that great man, to render his *epistles* agreeable, as these have the genius of the language to struggle with.—Next to oratory, history agrees with the genius of this language; and Cæsar, in his *Commentaries*, has exhibited the language in its purest elegance, without the aid of pomp or foreign ornament.—Among the Poets, Virgil has best adapted his works to his language. The flowing harmony and pomp of it is well adapted for the epic strain, and the correct delicacy of his taste rendered him perfectly equal to the task. But Horace is the only poet whose force of genius was able to overcome the bars which the language threw in his way, and succeed in lyric poetry. Were it not for the brilliancy of the thoughts, and acuteness of remarks, which so eminently distinguish this author's compositions, his odes would long ere now have sunk into utter oblivion.—But so conscious have all the Roman poets been of the unfitness of their language for easy dialogue; that almost none of them, after Plautus and Terence, have attempted any dramatic compositions in that language.—Nor have we any reason to regret that they neglected this branch of poetry, as it is probable, if they had ever become fond of these, they would have been obliged to have adopted so many unnatural contrivances to render them agreeable, as would have prevented us (who of course would have considered ourselves as bound to follow them) from making that progress in the drama which so particularly distinguishes the productions of modern times.

The modern *Italian* language, from an inattention quite common in literary subjects, has been usually called a

child

child of the Latin language, and is commonly believed to be the ancient Latin a little debased by the mixture of the barbarous language of those people who conquered Italy. The truth is, it is directly the reverse: for this language, in its general idiom, and fundamental principles, is evidently of the analogous kind, first introduced by these fierce invaders, although it has borrowed many of its words, and some of its modes of phraseology, from the Latin, with which they were so intimately blended that this could scarcely be avoided; and it has been from remarking this slight connection so obvious at first sight, that superficial observers have been led to draw this general conclusion, so contrary to fact.

When Italy was over-run with the Lombards, and the empire destroyed by these northern invaders, they, as conquerors, continued to speak their own native language. Fierce and illiterate, they would not stoop to the servility of studying a language so clogged with rules, and difficult of attainment, as the Latin behoved to be to a people altogether unacquainted with nice grammatical distinctions: while the Romans of necessity were obliged to study the language of their conquerors, as well to obtain some relief of their grievances by prayers and supplications, as to destroy that odious distinction which subsisted between the conquerors and conquered while they continued as distinct people. As the language of their new masters, although rude and confined, was natural in its order, and easy to be acquired, the Latins would soon attain a competent skill in it: and as they bore such a proportion to the whole number of people, the whole language behoved to partake somewhat of the general sound of the former: for, in spite of all their efforts to the contrary, the organs of speech could not at once be made to acquire a perfect power of uttering any unaccustomed sounds; and as the language of the barbarians behoved to be much less copious than the Latin, whenever they found themselves at a loss for a word, they would naturally adopt those which most readily presented themselves from their new subjects. Thus a language in time was formed, somewhat resembling the Latin, both in the general tenor of the sounds, and in the meaning of many words: and as the barbarians gave themselves little trouble about language, and in some cases perhaps hardly knew the general analogy of their own language, it is not surprising if their new subjects should find themselves sometimes at a loss on that account, or if, in these situations, they followed, on some occasions, the analogy suggested to them by their own: which accounts for the strange degree of mixture of heterogeneous grammatical analogy we meet with in the Italian as well as Spanish and French languages.—The Idiom of all the Gothic languages is purely analogous; and in all probability, before their mixture with the Latins and other people in their provinces, the several grammatical parts of speech followed the plain simple idea which that supposes; the verbs and nouns were all probably varied by auxiliaries, and their adjectives retained their simple unalterable state:—but by their mixture with the Latins, this simple form has been in many cases altered; their verbs became in some cases inflected; but their nouns in all these languages still retained their original form; although they have varied

their adjectives, and foolishly clogged their nouns with gender, according to the Latin idioms. From this heterogeneous, and fortuitous (as we may say, because injudicious) mixture of parts, results a language possessing almost all the defects of each of the languages of which it is composed; with few of the excellencies of either: for it has neither the ease and precision of the *analogous*, nor the pomp and boldness of the *transpositive* languages; at the same time that it is clogged with almost as many rules, and liable to as great abuses.

These observations are equally applicable to the French and Spanish, as to the Italian language.—With regard to this last in particular, we may observe, that as the natural inhabitants of Italy, before the last invasion of the barbarians, were sunk and enervated by luxury and that depression of mind and genius which anarchy always produces; they had become fond of feasting and entertainments, and the enjoyment of sensual pleasures constituted their highest delight; and their language partook of the same debility as their body.—The barbarians too—unaccustomed to the seductions of pleasure—soon fell from their original boldness and intrepidity,—and, like Hannibal's troops of old, were enervated by the sensual gratifications into which a nation of conquerors unaccustomed to the restraint of government freely indulged.—The softness of the air—the fertility of the climate—the unaccustomed flow of riches which they at once acquired,—together with the voluptuous manner of their conquered subjects,—all conspired to enervate their minds, and render them soft and effeminate.—No wonder then, if a language new-moulded should at this juncture partake of the genius of the people who formed it; and instead of participating of the martial boldness and ferocity of either of their ancestors, should be softened and enfeebled by every device which an effeminate people could invent.—The strong consonants which terminated the words, and gave them life and boldness, being thought too harsh for the delicate ears of these sons of sloth, were banished their language;—while sonorous vowels, which could be protracted to any length in music, were substituted in their stead.—Thus the Italian language is formed flowing and harmonious, but destitute of those nerves which constitute the strength and vigour of a language: at the same time, the sounds are neither enough diversified, nor in themselves of such an agreeable tone, as to afford great pleasure without the aid of musical notes;—and the small pleasure which this affords is still lessened by the little variety of measure which the great similarity of the termination of words occasions.—Hence it happens, that this language is fitted for excelling in fewer branches of literature than almost any other:—and although we have excellent historians, and more than ordinary poets, in this language; yet they labour under great inconveniences from the language in which they write,—as it wants nerves and stateliness for the former,—and sufficient variety of modulation for the latter.—It is, more particularly on this account, altogether unfit for an epic poem:—and although attempts have been made in this way by two men, whose genius, if not fettered by the language, might have been crowned with success; yet these, notwithstanding the fame that

with

with some they may have acquired, must, in point of poetic harmony, be deemed defective by every impartial person. Nor is it possible that a language which hardly admits of poetry without rhyme, can ever be capable of producing a perfect poem of great length; and the stanza to which their poets have ever confined themselves, must always produce the most disagreeable effect in a poem where unrestrained pomp or pathos are necessary qualifications. The only species of poetry in which the Italian language can claim a superior excellence, is the tender tone of elegy: and here it remains unrivalled and alone:—the plaintive melody of the sounds, and smooth flow of the language, seem perfectly adapted to express that soothing melancholy which this species of poetry requires.—On this account, the plaintive stanzas of the *Pastor Fido* of Guarini have justly gained to that poem an universal applause; although, unless on this account alone, it is perhaps inferior to almost every other poem of the kind which ever appeared.—We must observe with surprise, that the Italians, who have fettered every other species of poetry with the severest shackles of rhyme, have in this species shewed an example of the most unrestrained freedom; the happy effects of which ought to have taught all Europe the powerful charms attending it: yet with amazement we perceive, that scarce an attempt to imitate them has been made by any poet in Europe except by Milton in his *Lycidas*; no dramatic poet, even in Britain, having ever adopted the unrestrained harmony of numbers to be met with in this and many other of their best dramatic compositions.

Of all the languages which sprung up from the mixture of the Latins with the northern people on the destruction of the Roman empire, none of them approach so near to the genius of the Latin as the Spanish does. For as the Spaniards have been always remarkable for their military prowess and dignity of mind, their language is naturally adapted to express ideas of that kind. Sonorous and solemn, it admits nearly of as much dignity as the Latin. For conversation, it is the most elegant and courteous language in Europe.—The humane and generous order of chivalry was first invented and kept its footing longest in this nation; and although it run at last into such a ridiculous excess as deservedly made it fall into universal disrepute, yet it left such a strong tincture of romantic heroism upon the minds of all ranks of people, as made them jealous of their glory, and strongly emulous of cultivating that heroic politeness, which they considered as the highest perfection they could attain. Every man disdained to flatter, or to yield up any point of honour which he possessed: at the same time, he rigorously exacted from others all that was his due. These circumstances have given rise to a great many terms of respect, and courteous condescension, without meanness or flattery, which give their dialogue a respectful politeness and elegance unknown to any other European language. This is the reason why the characters so finely drawn by Cervantes in *Don Quixote* are still unknown to all but those who understand the language in which he wrote.—Nothing can be more unlike the gentle meekness and humane heroism of the knight, or the native simplicity, warmth of affection, and respectful loquacity of the squire,—than

the inconsistent follies of the one, or the impertinent forwardness and disrespectful petulance of the other, as they are exhibited in every English translation.—Nor is it possible to represent so much familiarity, united with such becoming condescension in the one, and unfeigned deference in the other, in any other European language, as is necessary to paint these two admirable characters.

Although this language, from the solemn dignity and majestic elegance of its structure, is perhaps better qualified than any other modern one for the sublime strains of epic poetry; yet as the poets of this nation have all along imitated the Italians by a most servile subjection to rhyme, they never have produced one poem of this sort, which in point of poetry of style deserves to be transmitted to posterity. And in any other species of poetry but this, or the higher tragedy, is it not naturally fitted to excel. But although the drama and other polite branches of literature were early cultivated in this country, and made considerable progress in it, before the thirst of gain debased their souls, or the desire of universal dominion made them forfeit that liberty which they once so much prized; since they became enervated by an overbearing pride, and their minds enslaved by superstition; all the polite arts have been neglected: so that, while other European nations have been advancing in knowledge, and improving their language, they have remained in a state of torpid inactivity; and their language has not arrived at that perfection which its nature would admit, or the acute genius of the people would have made us naturally expect.

It will perhaps, by some, be thought an unpardonable insult, if we do not allow the French the preference of all modern languages in many respects. But so far must we pay a deference to truth, as to be obliged to rank it among the poorest languages in Europe.—Every other language has some sounds which can be uttered clearly by the voice: even the Italian, although it wants energy, still possesses distinctness of articulation. But the French is almost incapable of either of these beauties; for in that language the vowels are so much curtailed in the pronunciation, and the words run into one another in such a manner, as of necessity to produce an indistinctness which renders it incapable of measure or harmony. From this cause, it is in a great measure incapable of poetic modulation, and rhyme has been obliged to be substituted in its stead; so that this poorest of all contrivances which has ever yet been invented to distinguish poetry from prose, admitted into all the modern languages when ignorance prevailed over Europe; has still kept some footing in the greatest part of these, rather through a deference for established customs, than from any necessity.—Yet as the French language admits of so little poetic modulation, rhyme is in some measure necessary to it; and therefore they have adopted, and dignified this poor deviation from prose with the name of Poetry; and, by their blind attachment to this art, have neglected to improve so much as they might have done the small powers for harmony that their language is possessed of; and, by being long accustomed to this false taste, have become fond of it to such a ridiculous excess, as to have all their tragedies,—nay even their comedies, in rhyme. While the poet is obliged to enervate his language, and check the flow of composition, for the

the sake of linking his lines together, the judicious actor finds more difficulty in destroying the appearance of that measure, and preventing the clinking of the rhimes, than in all the rest of his task.—After this we will not be surpris'd to find Voltaire attempt an epic poem in this species of poetry; although the more judicious Fénélon in his *Telemaque* had shewn to his countrymen the only species of poetry which their language could admit of for any poem which aspired to the dignity of the epic strain.—Madam Despouliers, in her *Idyllie*, has shewn the utmost extent of harmony to which their language can attain in smaller poems:—indeed in the tenderness of an elegy, or the gaiety of a song, it may succeed; but it is so destitute of force and energy, that it can never be able to reach the Pindaric, or even perhaps the Lyric strain,—as the ineffectual efforts even of the harmonious Rousseau, in his translation of the Psalms of David of this stamp, may fully convince us.

With regard to its power in other species of composition, the sententious rapidity of Voltaire, and the more nervous dignity of Rousseau, afford us no small presumption, that, in a skilful hand, it might acquire so much force, as to transmit to futurity historical facts in a style not altogether unworthy of the subject.—In attempts at pathetic declamation, the superior abilities of the composer may perhaps on some occasions excite a great idea, but this is ever cramped by the genius of the language: and altho' no nation in Europe can boast of so many orations where this grandeur is attempted; yet perhaps there are few who cannot produce more perfect, although not more laboured, compositions of this kind.

But notwithstanding the French language labours under all these inconveniences;—although it can neither equal the dignity or genuine politeness of the Spanish, the nervous boldness of the English, nor the melting softness of the Italian;—although it is destitute of poetic harmony, and so much cramped in sound as to be absolutely unfit for almost every species of musical composition\*;—yet the sprightly genius of that volatile people has been able to surmount all these difficulties, and render it the language most generally esteemed, and most universally spoken, of any in Europe: for this people, naturally gay and loquacious, and fond to excess of those superficial accomplishments which engage the attention of the fair sex, have invented such an infinity of words capable of expressing vague and unmeaning compliment, now dignified by the name of *politeness*, that, in this strain, one who uses the French can never be at a loss;

VOL. II. Numb. 63.

2

and as it is easy to converse *more*, and really say *less*, in this than any other language, a man of very moderate talents may distinguish himself much more by using this than any other that has ever yet been invented.—On this account, it is peculiarly well adapted for that species of conversation which must ever take place in those general and promiscuous companies, where many persons of both sexes are met together for the purposes of relaxation or amusement; and must of course be naturally admitted into the courts of princes, and assemblies of great personages; who, having fewer equals with whom they can associate, are more under a necessity of conversing with strangers, in whose company the tender stimulus of friendship does not so naturally expand the heart to mutual trust or unrestrained confidence. In these circumstances, as the heart remaineth disengaged, conversation must necessarily flag; and mankind in this situation will gladly adopt that language in which they can converse most easily without being deeply interested.—One these accounts the French now is, and probably will continue to be reckoned the most polite language in Europe, and therefore the most generally studied and known: nor should we envy them this distinction, if our countrymen would not weaken and enervate their own manly language, by adopting too many of their unmeaning phrases.

The English is perhaps possessed of a greater degree of excellence, blended with a greater number of defects, than any of the languages that we have hitherto mentioned.—As the people of great Britain are a bold, daring, and impetuous race of men; subject to strong passions, and, from the absolute freedom and independence which reigns among all ranks of people throughout this happy isle, little solicitous about controuling these passions;—our language takes its strongest characteristic distinction from the genius of the people; and, being bold, daring, and abrupt, is admirably well adapted to express those great emotions which spring up in an intrepid mind at the prospect of interesting events. Peculiarly happy too in the full and open sound of the vowels, which forms the characteristic *tone* of the language, and in the strong use of the aspirate H in almost all those words which are used as exclamations, or marks of strong emotions upon interesting occasions, that particular class of words called *interjections* have, in our language, more of that fulness and unrestrained freedom of tones, in which their chief power consists, and are pushed forth from the inmost recesses of the soul in a more forcible and unrestrained manner, than any other language whatever. Hence it is

† 9 M.

more

\* An author of great discernment, and well acquainted with the French language, has lately made the same remark; and as the loftiness of his genius often prevents him from bringing down his illustrations to the level of ordinary comprehension, he has on this, and many other occasions, been unjustly accused of being fond of paradoxes.—But as music never produces its full effect but when the tones it assumes are in unison with the idea that the words naturally excite, it of necessity follows, that if the words of any language do not admit of that fulness of sound, or of that species of tones, which the passion or affection that may be described by the words would naturally require to excite the same idea in the mind of one who was unacquainted with the language, it will be impossible for the music to produce its full effect, as it will be cramped and confined by the sound of the words;—and as the French language does not admit of those full and open sounds which are necessary for pathetic expression in music, it must of course be unfit for musical composition.—It is true indeed, that in modern times, in which so little attention is bestowed on the simple and sublime charms of pathetic expression, and a fantastical tingling of unmeaning sounds is called music—where the sense of the words are lost in figures, quavers, and unnecessary repetition of particular syllables,—all languages are nearly equally fitted for it; and among these the French; nor is it to be doubted, that, in the easy gaiety of a song, this language can properly enough admit of all the musical expression which that species of composition may require.

more peculiarly adapted for the great and interesting scenes of the *Drama* than any language that has yet appeared in the globe.—Nor has any other nation ever arrived at that perfection which the English may justly claim in that respect; for however faulty our dramatic compositions may be in some of the critical niceties which relate to this art,—in nervous force of diction, and in the natural expression of those great emotions which constitute its soul and energy, we claim, without dispute, an unrivalled superiority.—Our language too, from the great intercourse that we have had with almost all the nations of the globe by means of our extensive commerce, and from the eminent degree of perfection which we have attained in all the arts and sciences, has acquired a copiousness beyond what any other modern nation can lay claim to; and even the most partial favourers of the Greek language are forced to acknowledge, that in this respect it must give place to the English. Nor is it less happy in that facility of construction which renders it more peculiarly adapted to the genius of a free people, than any other form of language.—Of an *idiom* purely analogous, it has deviated less from the genius of that *idiom*, and possesses more of the characteristic advantages attending it, than any other language that now exists: for, while *others*, perhaps by their more intimate connection with the Romans, have adopted some of their transpositions, and clogged their language with unnecessary letters, *we* have preserved ourselves free from the contagion, and still retain the primitive simplicity of our language. Our *verbs* are all varied by auxiliaries (except in the instance we have already given, which is so much in our favours); our *nouns* remain free from the perplexing embarrassment of *genders*, and our pronouns mark this distinction where necessary with the most perfect accuracy; our *articles* also are of course freed from this unnatural encumbrance, and our *adjectives* preserve their natural freedom and independence. From these causes, our language follows an order of construction so natural and easy, and the rules of *syntax* are so few and obvious, as to be within the reach of the most ordinary capacity. So that from this, and the great clearness and distinctness of meaning which this mode of construction necessarily is accompanied with, it is much better adapted for the familiar intercourse of private society, and liable to fewer errors in using it, than any other language yet known; and on this account we may boast, that in no nation of Europe do the lower class of people speak their language with so much accuracy, or have their minds so much enlightened by knowledge, as those of great Britain.—What then shall we say of the discernment of those grammarians, who are every day echoing back to one another complaints of the poverty of our language on account of the few and simple rules which it requires in *syntax*? As justly might we complain of an invention in mechanics, which, by means of one or two simple movements, obvious to an ordinary capacity, little liable to accidents, and easily put in order by the rudest hand, should possess the whole powers of a complex machine, which had required an infinite apparatus of wheels and contrary movements, the knowledge of which could only be acquired, or the various accidents to which it was exposed by using it be

repaired, by the powers of an ingenious artist, as complain of this characteristic excellence of our language as a defect.

But if we thus enjoy in an eminent degree the advantages attending an *analogous* language; we likewise feel in a considerable measure the defects to which it is exposed; as the number of monosyllables with which it always must be embarrassed, notwithstanding the great improvements which have been made in our language since the revival of letters in Europe, prevents in some degree that swelling fulness of sound which so powerfully contributes to harmonious dignity and graceful cadences in literary compositions.—And as the genius of the people of Britain has always been more disposed to the rougher arts of command, than the softer insinuations of persuasion, no pains have been taken to correct these natural defects of our language; but on the contrary, by an inattention of which we have hardly a parallel in the history of any civilized nation, we meet with many instances, even within this last century, of the harmony of sound being sacrificed to that brevity so desirable in conversation, as many elegant words have been curtailed, and harmonious syllables suppressed, to substitute in their stead others, shorter indeed, but more barbarous and uncouth.—Nay, so little attention have our forefathers bestowed upon the harmony of sounds in our language, that one would be tempted to think, on looking back to its primitive state, that they had on some occasions studiously debased it.—Our language, at its first formation, seems to have laboured under a capital defect in point of sound, as such a number of S's enter into the formation of our words, and such a number of letters and combinations of other letters assume a similar sound, as to give a general hiss through the whole tenor of our language, which must be exceedingly disagreeable to every unprejudiced ear. We would therefore have naturally expected, that at the revival of letters, when our forefathers became acquainted with the harmonious languages of Greece and Rome, they would have acquired a more correct taste, and endeavoured, if possible, to have diminished the prevalence of this disgusting sound. But so far have they been from thinking of this, that they have multiplied this letter exceedingly. The plurals of almost all our nouns were originally formed by adding the harmonious syllable *en* to the singular, which has given place to the letter *s*; and instead of *housen* formerly, we now say *houses*. In like manner, many of the variations of our verbs were formed by the syllable *eth*, which we have likewise changed into the same disagreeable letter; so that, instead of *loveth*, *moveth*, *writeth*, *walketh*, &c. we have changed them into the more modern form of *loves*, *moves*, *writes*, *walks*, &c.—Our very auxiliary verbs have suffered the same change; and instead of *hath* and *doth*, we now make use of *has* and *does*. From these causes, notwithstanding the great improvements which have been made in language, within these few centuries, in other respects; yet, with regard to the pleasantness of sound alone, it was perhaps much more perfect in the days of Chaucer than at present: and although custom may have rendered these sounds so familiar to our ear, as not to affect us much; yet to an unprejudiced person, unacquainted with our language, we

have

have not the smallest doubt, but the language of *Bacon* or *Sydney* would appear more harmonious than that of *Robertson* or *Hume*.—This is indeed the fundamental defect of our language, and loudly calls for reformation.

But notwithstanding this great and radical defect in our language with regard to pleasingness of sounds, which must be so strongly perceived by every one who is unacquainted with the meaning of our words; yet to those who understand the language, the exceeding copiousness which it allows in the choice of words proper for the occasion, and the nervous force which it derives from the accent, with the perspicuity and graceful elegance the emphasis bestows upon it, makes this defect be totally overlooked; and we could produce such numerous works of prose which excel in almost every different style of composition as would be tiresome to enumerate; and every reader of taste and discernment will be able to recollect a sufficient number of writings which excel in point of style, between the graceful and becoming gravity so conspicuous in all the works of the author of the *Whole Duty of Man*, and the animated and nervous diction of *Robertson* in his history of *Charles the fifth*,—the more flowery style of *Shaftsbury*, or the Attic simplicity and elegance of *Addison*. But although we can equal, if not surpass, every modern language in works of prose, it is in its poetical powers that our language shines forth with the greatest lustre.—The brevity to which we must here necessarily confine ourselves, prevents us from entering into a minute examination of the poetical powers of our own, compared with other languages; otherwise it would be easy to shew, that every other modern language labours under great restraints in this respect which ours is freed from;—that our language admits of a greater variety of poetic movements, and diversity of cadence, than any of the admired languages of antiquity;—that it distinguishes with the greatest accuracy between accent and quantity, and is possessed of every other poetic excellence which their languages were capable of: so that we are possessed of all the sources of harmony which they could boast; and, besides all these, have one superadded, which is the cause of greater variety and more forcible expression in numbers than all the rest; that is, the unlimited power given to the emphasis over quantity and cadence; by means whereof, a necessary union between sound and sense, numbers and meaning, in versification, unknown to the ancients, has been brought about, which gives our language in this respect a superiority over all those justly admired languages.—But as we cannot here further pursue this subject, we shall only observe, that these great and distinguishing excellencies far more than counterbalance the inconveniencies that we have already mentioned; and although, in mere pleasingness of sounds, or harmonious flow of syllables, our language may be inferior to the Greek, the Latin, Italian, and Spanish; yet in point of manly dignity, graceful variety, intuitive distinctness, nervous energy of expression, unconstrained freedom and harmony of poetic numbers, it will yield the palm to none.—Our immortal *Milton*, slowly rising, in graceful majesty stands up as equal, if not superior in these respects to any poet, in any other language, that ever yet existed;—while *Thomson*, with more humble

aim, in melody more smooth and flowing, softens the soul to harmony and peace:—the plaintive moan of *Hammond* calls forth the tender tear and sympathetic sigh; while *Gray's* more soothing melancholy fixes the sober mind to silent contemplation:—more tender still than these, the amiable *Shenston* comes; and from his Doric reed, still free from courtly affectation, flows a strain so pure, so simple, and of such tender harmony, as even Arcadian shepherds would be proud to own. But far before the rest, the daring *Shakespeare* steps forth conspicuous, clothed in native dignity; and, pressing forward with unremitting ardour, boldly lays claim to both dramatic crowns, held out to him by *Thalia* and *Melpomene*:—his rivals, far behind, look up, and envy him for these unfading glories; and the astonished nations round, with distant awe, behold and tremble at his daring flight.—Thus the language, equally obedient to all, bends with ease under their hands, whatever form they would have it assume; and, like the yielding wax, readily receives, and faithfully transmits to posterity, those impressions which they have stamped upon it.

Such are the principal outlines of the language of Great Britain, such are its beauties, and such its most capital defects; a language more peculiarly circumstanced than any that has ever yet appeared.—It is the language of a great and powerful nation, whose fleets surround the globe, and whose merchants are in every port; a people admired, or revered by all the world;—and yet it is less known in every foreign country, than any other language in Europe.—In it are written more perfect treatises on every art and science, than are to be found in any other language;—yet it is less sought after or esteemed by the literati in any part of the globe, than almost any of these. Its superior powers for every purpose of language are sufficiently obvious from the models of perfection, in almost every particular, which can be produced in it;—yet it is neglected, despised, and vilified by the people who use it; and many of those authors who owe almost the whole of their fame to the excellence of the language in which they wrote, look upon that very language with the highest contempt.—Neglected and despised, it has been trodden under foot as a thing altogether unworthy of cultivation or attention. Yet in spite of all these inconveniencies, in spite of the many wounds it has thus received, it still holds up its head, and preserves evident marks of that comeliness and vigour which are its characteristic distinction. Like a healthy oak planted in a rich and fertile soil, it has sprung up with vigour: and although neglected, and suffered to be over-run with weeds; although exposed to every blast, and unprotected from every violence; it still beareth up under all these inconveniencies, and shoots up with a robust healthiness and wild luxuriance of growth. Should this plant, so sound and vigorous, be now cleared from those weeds with which it has been so much encumbered;—should every obstacle which now buries it under thick shades, and hides it from the view of every passenger, be cleared away;—should the soil be cultivated with care, and a strong fence be placed around it, to prevent the idle or the wicked from breaking or distorting its branches;—who can tell with what additional vigour it would flourish, or what amazing magnitude and perfec-

tion it might at last attain!—How would the astonished world behold, with reverential awe, the majestic gracefulness of that object which they so lately despised!

[N. B. Some unavoidable circumstances which attended the printing of the preceding article, have occasioned several mistakes in it, of which the following describe the immediate matter.]

Page 864, column 1, line 29, the words *in time* should be deleted.

P. 865, col. 2, l. 34, for *word*, read *words*.

P. 865, col. 2, l. 6, for *one*, read *on*.

Ibid. col. 1, and 2, delete *Isaguro*, *Olia*, *Loquus-bam*, *Olie-bam*, with the English words accompanying them;—and for *Ficco*, *Pon-i-bam*, *Obie-bam*, *Gaudii-bam*, and *Affine-bam*, read *Ficio*, *Pone-bam*, *Obi-bam*, *Gau-de-bam*, and *Affine-bam*.

Ibid. col. 2, l. 22, for “and the *fluterfeld* in ISSEM and ERO,” read, “the *fluterfeld* in ISSEM, and the *future* in ERO.”

P. 864, for, TU, *Tytete*, *lentis* in *umbra*, &c. read, TU, *Tityre*, *lentus* in *umbra*, &c.

Ibid. col. 1, l. 28, for *contract*, read *contract*;—l. 37, for *fiction*, read *fiction*;—and delete the syllable *con* at the beginning of l. 45.

P. 870, col. 2, lines 22, 23, 24, 25, and 26, read thus:—For all their nouns in UM of the second declension, in E of the third, and in U of the fourth, have each their nominative and accusative singular alike. Nor in the plural number is there any distinction between these cases, &c.

Ibid. col. 2, l. 19, from the bottom, for *language*, read *linguages*.

P. 873, col. 2, l. 38, for *that*, read *their*.

P. 876, col. 2, l. 16, for *is it*, read *it is*.

**LANGUED**, in heraldry, expresses such animals whose tongue appearing out of the mouth, is borne of a different colour from that of the body.

**LANGUEDOC**, a province of France, bounded by Lionois, on the north; by the river Rhone, which divides it from Dauphine and Provence, on the east; by the Mediterranean and the the Pyrenees, on the south; and by Guienne and Gascony, on the west.

**LANGUOR**, among physicians, signifies great weakness and loss of strength, attended with a dejection of mind; so that the patients can scarce walk, or even stand upright, but are apt to faint away.

**LANIGEROUS**, an appellation given to whatever bears wool.

**LANIUS**, the BUTCHER-BIRD, in ornithology, a genus belonging to the order of accipitres; the characters of which are these: The beak is somewhat strait, with a tooth on each side towards the apex, and naked at the base; and the tongue is lacerated. There are twenty six species, distinguished by the shape of the tail, and colour.

**LANNIERS**, or **LANNIARDS**, in a ship, are small ropes reeved into the dead-man's eyes of all shrouds, either to slacken them or set them taught: the stays of all masts are also set taught by lanniers.

**LANTANA**, in botany, a genus of the didynamia angiospermia class. The calix consists of four obsolete teeth; and the drupa has two cells. There are seven species, none of them natives of Britain.

**LANUGO**, the soft down of plants, like that growing on the fruit of the peach-tree.

**LANZO**, a town of Italy, in the territory of Piedmont, situated fifteen miles north of Turin.

**LAODICEA**, an ancient city of the lesser Asia, situated east of Ephesus, now in ruins.

**LAON**, a city of France, in the province of the Isle of France, situated in E. long. 3° 45', lat. 49° 37'.

**LAOS**, a country of the farther India in Asia, bounded by China on the north; by Tonquin, on the east; by Siam and Cambodia, on the south; and Ava and Pegu, on the west.

**LAPATHUM**, in botany. See **RUMEX**.

**LAPIDARY**, an artificer, who cuts precious stones.

The art of cutting precious stones is of great antiquity. The French, though they fell into it but lately, have notwithstanding carried this art to a very great perfection, but not in any degree superior to the English.

There are various machines employed in the cutting of precious stones, according to their quality: the diamond, which is extremely hard, is cut on a wheel of soft steel, turned by a mill, with diamond-dust, tempered with olive-oil, which also serves to polish it.

The description of the diamond-cutter's wheel or mill, as represented in Plate CIII. fig. 7. is as follows: *a* is the pincers; *b*, the screw of the pincers; *c*, the shell that carries the mastic and the diamond; *d*, the mastic that softens the diamond at the end of the shell; *e*, the diamond presented to the wheel, to be cut facetwise; *f*, the iron-wheel turning on its pivot; *g*, iron-pegs, to fix and keep the pincers steady; *h*, small pigs of lead of different weights, wherewith the pincers are loaded at pleasure to keep them steady; *i*, a wooden wheel; *k*, the axis of the wheel. It is bended and makes an elbow under the wheel, to receive the impulsion of a bar that does the office of a turning handle; *l*, the sole, or square piece of steel, wherein the pivot of the tree or axis moves; *m*, the turning handle, that sets the wheel a-going by means of the elbow of its axis; the elbow of the piercer wherewith a hog-head is broached, will give an idea of this kind of motion; *n*, the cat-gut string, that goes round both the iron and the wooden wheels. If the wooden wheel is twenty times larger than the iron-one, the latter shall make twenty turns upon the diamond, whilst the large wheel makes but one round its axis; and whilst the boy gives, without any resistance, a hundred impulsions to the turning handle, the diamond experiences a thousand times the friction of the whole grinding wheel.

The diamond-cutter follows the work with his eyes, without taking any other share in it than that of changing the place of the diamond to bite on a new surface; and of timely thrown upon it, with a few drops of oil, the minute particles of the diamonds first ground one against the other, to begin the cutting of them.

The oriental ruby, sapphire, and topaz, are cut on a copper-wheel with diamond dust, tempered with olive-oil, and are polished on another copper-wheel with tripoli and water. The hyacinth, emerald, amethyst, garnets, agats, and other stones, not of an equal degree of hardness with the other, are cut on a leaden wheel with smalt and water, and polished on a tin-wheel with tripoli. The turquois of the old and new rock, girasol and opal, are cut and polished on a wooden wheel with tripoli also.

The lapidaries of Paris have been a corporation since the year 1290. It is governed by four jurats, who superintend their rights and privileges, visit the master-workmen, take care of the master-piece of workmanship, bind apprentices, and administer the freedom.

**LAPIS**, in general, is used to denote a stone of any kind.

**LAPLAND**, the most northerly part of Europe, divi-  
de d

Fig. 1. LACERTA SALAMANDRA or Salamander



Fig. 4. Log



Fig. 2. LEPUS TIMIDUS or Hare

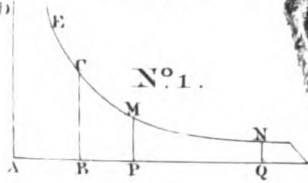
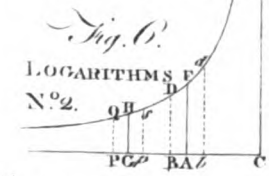
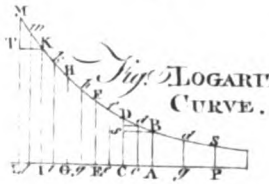
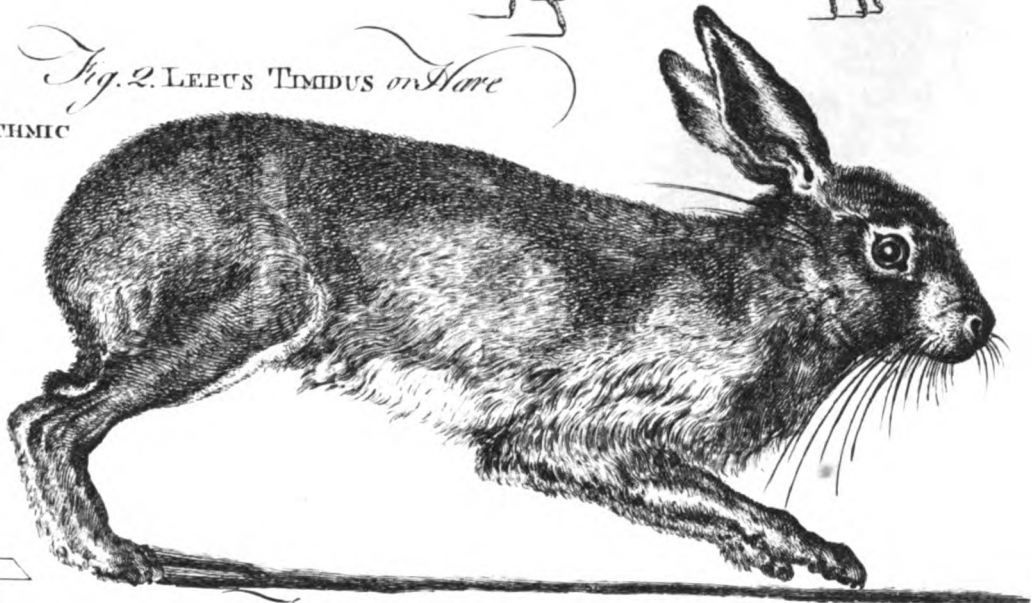


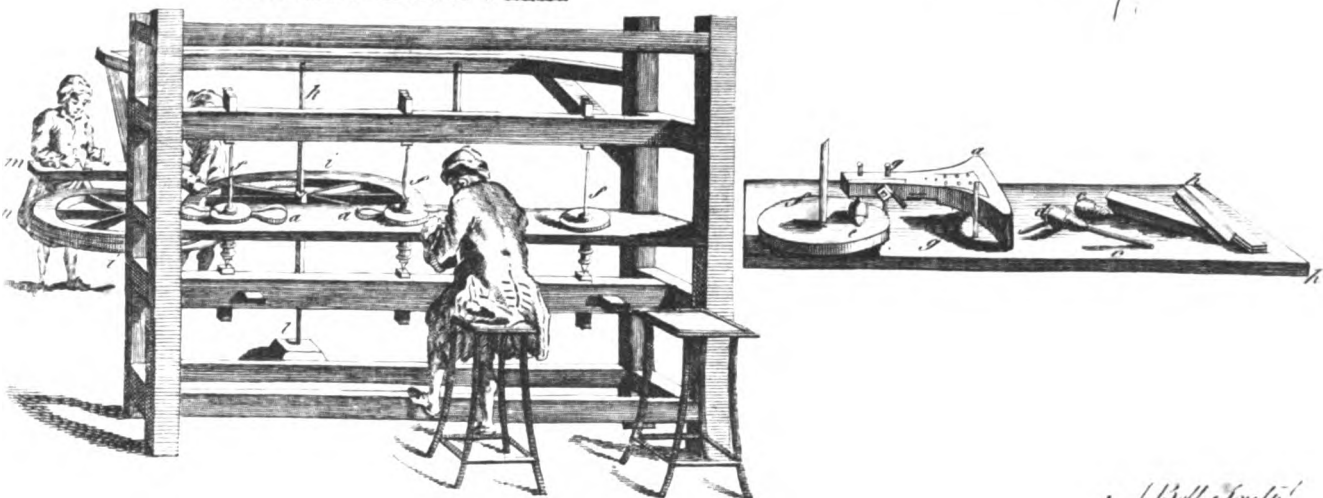
Fig. 3. LEPUS CUNICULUS or Rabbit



Fig. 8. LOZENGE



Fig. 7. LAPIDARY'S MILL or WHEEL







- ded into Norwegian Lapland, Swedish Lapland, and Russian Lapland: it lies between  $10^{\circ}$  and  $35^{\circ}$  of E. long. and between  $65$  and  $72^{\circ}$  of N. lat.
- LAPWING**, in ornithology. See **FRINGA**.
- LACQUEUS**, in surgery, a kind of ligature, so contrived, that when stretched by any weight, or the like, it draws up close. Its use is to extend broken or dis-jointed bones, to keep them in their places when they are set, and to bind the parts close together.
- LAR-BOARD**, among seamen, the left-hand side of the ship, when you stand with your face towards the head.
- LARCENY**, in law, a felonius carrying away another person's goods; and this, according to the value of the thing stolen, is either grand, or petit larceny; the first being stealing effects above the value of 1 s. and the last such as are either of that value, or under it.
- LAREDO**, a port-town of Spain, in the province of Biscay, situated on the coast of Biscay: W. lon.  $3^{\circ} 40'$ , N. lat.  $43^{\circ} 30'$ .
- LARES**, certain inferior deities among the ancient Romans, who were the guardians of houses; they were also sometimes taken for the guardians of streets and ways, and Tibullus makes them the guardians of the fields. According to Ovid, they were the sons of Mercury and Lara, whose tongue was cut out by Jupiter, because she revealed his adulteries to Juno; and not contented with this, he delivered her to Mercury, with orders to conduct her to hell; but he falling in love with her by the way, had twins by her, who from their mother were called lares.
- These domestic deities were sometimes represented under the figure of a dog, the symbol of fidelity; because dogs have the same function as the lares, which is to guard the house. At other times their images were covered with the skin of a dog, and had the figure of that domestic animal standing by them. The principal sacrifices to the lares, were incense, fruit, and a hog.
- LARIX**. See **PINUS**.
- LARK**, in ornithology. See **ALAUDA**.
- LARUS**, the **GULL**, in ornithology, a genus belonging to the order of anseres, the characters of which are these: The bill is strait, cultrated, a little crooked at the point, and without teeth; the inferior mandible is gibbous below the apex, the nostrils are linear, a little broader before, and situate in the middle of the back. There are 11 species, principally distinguished by their colour.
- LARYNX**, in anatomy. See **ANAT.** p. 300.
- LASERPITIUM**, **LASER-WORT**, a genus of the pentandria digynia class. The fruit is oblong, with eight membranaceous angles. There are nine species, none of them natives of Britain.
- LASSITUDE**, or **WEARINESS**, in medicine, a morbid sensation, that comes on spontaneously, without any previous motion, exercise, or labour. This is a frequent symptom in acute distempers: it arises either from an increase of bulk, a diminution of proper evacuation, or too great a consumption of the fluids necessary to maintain the spring of the solids, or from a vitiated secretion of that juice.
- LAST**, in general, signifies the burden or load of a ship. It signifies also a certain measure of fish, corn, wool, leather, &c. A last of codfish, white herrings, meal, and ashes for soap, is twelve barrels; of corn or rapeseed, ten quarters; of gun powder, twenty-four barrels; of red-herrings, twenty cades; of hides, twelve dozen; of leather, twenty dickers; of pitch and tar, fourteen barrels; of wool, twelve sacks; of stock-fish, one thousand; of flax or feathers, 1700 lb.
- LASTAGE**, or **LESTAGE**, a duty exacted in some fairs and markets, for carrying things bought whither one will. It signifies also the ballast or lading of a ship; and sometimes is used for garbage, rubbish, or such like filth.
- LATERAN COUNCILS**, those councils held in the basilica of the Latin church at Rome. See **COUNCIL**. There have been five councils held in this place. viz. in the years 1123, 1139, 1179, 1215, and 1513.
- LATH**, in building, a long, thin and narrow slip of wood, nailed to the rafters of a roof or ceiling, in order to sustain the covering.
- LATHE**, in turning, a well-known engine used in turning wood, ivory, and other materials.
- LATHRÆA**, in botany, a genus of the didynamia angiospermia class. The calix consists of four segments; and the capsule has but one cell. There are four species, only one of which, viz. the squamaria, or toothwort, is a native of Britain.
- LATHYRUS**, in botany, a genus of the diadelphia decandria class. The stylus is plain, villous above, and broader below; and the two superior lacinie of the calix are shorter than the others. There are 21 species, seven of them natives of Britain; viz. the pissolia or crimson grass-vetch; the yellow vetchling; the hirsutus, or rough-codded chickling-vetch; the latifolius, or broad-leaved pease-everlasting; the sylvestris, or narrow-leaved pease-everlasting; the palustris, or marsh chickling-vetch; and the pratensis, or common yellow vetchling.
- LATIN**, a dead language, first spoken in Latium, and afterwards at Rome; and still used in the Romish church, and among many of the learned. See **LANGUAGE**.
- LATISSIMUS**, in anatomy. See **ANAT.** p. 195.
- LATITUDE**. See **GEOGRAPHY**, and **ASTRONOMY**.
- LATITUDINARIAN**, a person of moderation with regard to religious opinions, who believes there is a latitude in the road to heaven, which may admit people of different persuasions.
- LATTEN**, denotes iron-plates tinned over, of which tea-canisters are made.
- LAVANDULA**, **LAVENDER**, in botany, a genus of the didynamia-gymnospermia class. The calix is oval, subdentated, and supported by a bractea; and the stamina are within the tube. There are four species, none of them natives of Britain.
- LAVATERA**, in botany, a genus of the monadelphia polyandria class. The calix is double, the exterior one being divided into three segments; and there are many capsules, containing each a number of seeds. There are nine species, only one of which, viz. the arborea,

arborca, or sea-tree mallow, is a native of Britain.

**LAUBACH**, a city of Germany, in the circle of Austria, and the capital of the duchy of Carinthia: E. lon.  $14^{\circ} 40'$ , and N. lat.  $46^{\circ} 28'$ .

**LAUDANUM**. See **OPIMUM**.

**LAUDER**, a borough town of Scotland, in the shire of Mers, situated twenty-two miles south-east of Edinburgh.

**LAVENDER**. See **LAVENDULA**.

**LAUGHTER**, an affection peculiar to mankind, occasioned by something that tickles the fancy.

In laughter the eye-brows are raised about the middle, and drawn down next the nose; the eyes are almost shut; the mouth opens, and shews the teeth, the corners of the mouth being drawn back and raised up; the cheeks seem puffed up, and almost hide the eyes; the face is usually red, and nostrils open, and the eyes wet.

**LAUNCESTON**, the county-town of Cornwall, thirty-six miles west of Exeter; W. lon.  $4^{\circ} 40'$ , N. lat.  $50^{\circ} 45'$ .

It sends two members to parliament.

**LAUNCH**, in the sea language, signifies to put out: as, *launch the ship*, that is, put her out of the dock: *launch ast*, or *forward*, speaking of things that are stowed in the hold, is, put them more forward: *launch, ho!* is a term used when a yard is hoisted high enough, and signifies, *hoist no more*.

**LAURA**, in church-history, a name given to a collection of little cells, at some distance from each other, in which the hermits, in ancient times, lived together in a wilderness.

These hermits did not live in community, but each monk provided for himself in his distinct cell. The most celebrated lauras mentioned in ecclesiastical history, were in Palestine; as the Laura of St Euthymus, at four or five leagues distance from Jerusalem; the Laura of St Saba, near the brook Cedron; and the Laura of the Towers, near the river Jordan, &c.

**LAURENTALIA**, in Roman antiquity, a festival celebrated in honour of Acca Laurentia, Romulus's nurse.

**LAURUS**, in botany, a genus of the enneandria monogynia class. It has no calix; the corolla consists of six petals; the nectarium consists of three glands, with two bristles surrounding the germen; and the drupa contains but one seed. There are eleven species, among which are the cinnamonum, or cinnamon-tree; the camphora, or camphor-tree, (see **CAMPHOR**;) and the sassafras, or sassafras-tree.

The bark of the cinnamon-tree is light, thin, and of a reddish colour, rolled up in long quills or canes; of a fragrant delightful smell, and an aromatic sweet

pungent taste, with some degree of astringency. It is generally mixed with the casia bark: this last is easily distinguishable by its breaking over smooth, whilst cinnamon splinters; and by its slimy mucilaginous taste; without any thing of the roughness of the true cinnamon. Cinnamon is a very elegant and useful aromatic, more grateful both to the palate and stomach than most other substances of this class: by its astringent quality it likewise corroborates the viscera, and proves of great service in several kinds of alvine fluxes and immoderate discharges from the uterus. An essential oil, a simple and spirituous distilled water, and a tincture of it, are kept in the shops: it is likewise employed as a spicy ingredient in a great number of compositions.

The root of the sassafras-tree is brought to us in long straight pieces, very light, and of a spongy texture, covered with a rough fungous bark; outwardly of an ash colour, inwardly of the colour of rusty iron. It has a fragrant smell, and a sweetish aromatic subacid taste: the bark tastes much stronger than any other part; and the small twigs stronger than the large pieces. As to the virtues of this root, it is a warm aperient and corroborant; and frequently employed, with good success, for purifying and sweetening the blood and juices. For these purposes, infusions made from the rasped root or bark may be drank as tea. In some constitutions, these liquors, by their fragrance, are apt, on first taking them, to affect the head: in such cases, they may be advantageously freed from their flavour by boiling; a decoction of sassafras, boiled down to the consistence of an extract, proves simply bitterish and subastringent. Hoffman assures us, that he has frequently given this extract to the quantity of a scruple at a time, with remarkable success, for strengthening the tone of the viscera in cachexies; as' also in the decline of intermitent fevers, and in hypochondriacal spasms. Sassafras yields in distillation an extremely fragrant oil, of a penetrating pungent taste, so ponderous (notwithstanding the lightness of the drug itself) as to sink in water. Rectified spirit extracts the whole taste and smell of sassafras: and elevates nothing in evaporation: hence the spirituous extract proves the most elegant and efficacious preparations, as containing the virtue of the root entire.

The only official preparation of sassafras is the essential oil. The sassafras itself is an ingredient in the decoction of the woods and the compound lime waters, and the oil in the elixir guaiacinum.

**LAUSANNE**, a city of Switzerland, in the canton of Bern, situated on the north side of the lake of Geneva: E. lon.  $6^{\circ} 31'$ , and N. lat.  $46^{\circ} 33'$ .

## L

## A

## W.

**LAW** may be defined, "The command of the sovereign power, containing a common rule of life for the subjects." It is divided into the law of nature, the law of nations, and civil or municipal law.

1. The law of nature is that which God has prescribed to all men, by the internal dictate of reason alone. It is discovered by a just consideration of the agreeableness or disagreeableness of human actions to the nature of man;

and

and comprehends all the duties we owe either to the Supreme Being, to ourselves, or to our neighbour; as reverence to God, self defence, temperance, honour to our parents, benevolence to all, a strict adherence to our engagements, gratitude, &c. The law of nature, where it either commands or forbids, is immutable, and cannot be controlled by any human authority; but where that law does no more than confer a right, without obliging us to use it, the supreme power may divest us thereof, in whole or in part.

2. The law of nations is also the result of reason, and has God for its author; but it supposes mankind formed into several bodies politic, or states; and comprises all the duties which one state owes to another. These must of necessity be similar to the duties arising between individuals, since both are dictated by reason; so that what is the law of nature when applied to men considered simply as such, is indeed the law of nations when applied to kingdoms or states. From this source proceed the rights of war, the security of ambassadors, the obligations arising from treaties, &c. The particular usages of nations in their mutual correspondence

which are not necessarily founded in reason, are no part of the law of nations in its proper sense: for they are arbitrary, and derive their sole authority from compact, either express or presumed; and may therefore, without violating the law of nature, be altered. For this reason, they ought to be thrown into the class of positive laws, whose obligation lasts no longer than the agreement upon which it is founded. Of this sort, are the ceremonial used in receiving and entertaining ambassadors, the privileges indulged to some of their servants, the rules observed in cartels for exchanging prisoners of war, &c.

3. Civil or municipal law, is that which every sovereign kingdom or state has appropriated to itself. The appellation of municipal was originally confined to the laws of *municipia*, or dependent states; but it came by degrees to signify all civil laws without distinction. No sovereign state can subsist without a supreme power, or a right of commanding in the last resort; the supreme power of one age cannot therefore be fettered by any enactment of a former age, otherwise it would cease to be supreme. Hence the law last in date derogates from prior laws.

## PRINCIPLES OF THE LAW OF SCOTLAND.

### Title I. *General Observations.*

1. THE municipal law of Scotland, as of most other countries, consists partly of statutory or written law, which has the express authority of the legislative power; partly of customary or unwritten law, which derives force from its presumed or tacit consent.

2. Under our statutory or written law is comprehended, (1.) Our acts of parliament: not only those which were made in the reign of James I. of Scotland, and from thence down to our union with England in 1707, but such of the British statutes enacted since the union as concern this part of the united kingdom.

3. The remains of our ancient written law were published by Sir John Skene clerk-register, in the beginning of the last century, by licence of parliament. The books of *Regiam Majestatem*, to which the whole collection owes its title, seem to be a system of Scots law, written by a private lawyer at the command of David I.; and though no express confirmation of that treatise by the legislature appears, yet it is admitted to have been the ancient law of our kingdom by express statutes. The borough-laws, which were also enacted by the same king David, and the statutes of William, Alexander II. David II. and the three Roberts, are universally allowed to be genuine. Our parliaments have once and again appointed commissions to revise and amend the *Regiam Majestatem*, and the other ancient books of our law, and to make their report: but, as no report appears to have been made, nor consequently any ratification by parliament, none of these remains are received, as of proper authority, in our courts; yet they are of excellent use in proving and illustrating our most ancient customs.

4. Our written law comprehends, (2.) The acts of seditant, which are ordinances for regulating the forms of

proceeding before the court of session in the administration of justice, made by the judges, who have a delegated power from the legislature for that purpose. Some of these acts dip upon matter of right, which declare what the judges apprehend to be the law of Scotland, and what they are to observe afterwards as a rule of judgment.

5. The civil or Roman and canon laws, though they are not perhaps to be deemed proper parts of our written law, have undoubtedly had the greatest influence in Scotland. The powers exercised by our sovereigns and judges have been justified upon no other ground, than that they were conformable to the civil or canon laws; and a special statute was judged necessary, upon the reformation, to rescind such of their constitutions as were repugnant to the Protestant doctrine. From that period, the canon law has been little respected, except in questions of tithes, patronages, and some few more articles of ecclesiastical right: But the Roman continues to have great authority in all cases where it is not derogated from by statute or custom, and where the genius of our law suffers us to apply it.

6. Our unwritten or customary law, is that which, without being expressly enacted by statute, derives its force from the tacit consent of king and people; which consent is presumed from the ancient custom of the community. Custom, as it is equally founded in the will of the lawgiver with written law, has therefore the same effects: Hence, as one statute may be explained by another, so a statute may be explained or repealed by the uniform practice of the community, and even go into disuse by a posterior contrary custom. But this power of custom to derogate from prior statutes, is generally confined by lawyers to statutes concerning private right, and does not extend to those which regard public policy.

7. An

7. An uniform tract of the judgments or decisions of the court of session, is commonly considered as part of our customary law; and without doubt, where a particular custom is thereby fixed or proved, such custom of itself constitutes law: But decisions, though they bind the part as litigating, have not, in their own nature, the authority of law in similar cases; yet, where they continue uniform, great weight is justly laid on them. Neither can the judgments of the house of peers of Great Britain reach farther than to the parties in the appeal, since in these the peers act as judges, not as lawgivers.

8. Though the laws of nature are sufficiently published by the internal suggestion of natural light, civil laws cannot be considered as a rule for the conduct of life, till they are notified to those whose conduct they are to regulate. The *Scots* acts of parliament were, by our most ancient custom, proclaimed in all the different shires, boroughs, and baron-courts of the kingdom. But after our statutes came to be printed, that custom was gradually neglected; and at last, the publication of our laws, at the market-cross of Edinburgh, was declared sufficient; and they became obligatory forty days thereafter. *British* statutes are deemed sufficiently notified, without formal promulgation; either because the printing is truly a publication, or because every subject is, by a maxim of the English law, party to them, as being present in parliament, either by himself or his representative. After a law is published, no pretence of ignorance can excuse the breach of it.

9. As laws are given for the rule of our conduct, they can regulate future cases only; for past actions, being out of our power, can admit of no rule. Declaratory laws form no exception to this; for a statute, where it is declaratory of a former law, does no more than interpret its meaning; and it is included in the notion of interpretation, that it must draw back to the date of the law interpreted.

10. By the rules of interpreting statute-law received in Scotland, an argument may be used from the title to the act itself, *a rubro ad nigrum*; at least, where the rubric has been either originally framed, or afterwards adopted by the legislature. The preamble or narrative, which recites the inconveniences that had arisen from the former law, and the causes inducing the enactment, may also lead a judge to the general meaning of the statute. But the chief weight is to be laid on the statutory words.

11. Laws, being directed to the unlearned as well as the learned, ought to be construed in their most obvious meaning, and not explained away by subtle distinctions; and no law is to suffer a figurative interpretation, where the proper sense of the words is as commodious, and equally fitted to the subject of the statute. Laws ought to be explained so as to exclude absurdities, and in the sense which appears most agreeable to former laws, to the intention of the lawgiver, and to the general frame and structure of the constitution. In prohibitory laws, where the right of acting is taken from a person, solely for the private advantage of another, the consent of him, in whose behalf the law was made, shall support the act done in breach of it; but the consent of parties immediately interested has no effect in matters which regard

the public utility of a state. Where the words of a statute are capable but of one meaning, the statute must be observed, however hard it may bear on particular persons. Nevertheless, as no human system of laws can comprehend all possible cases, more may be sometimes meant by the lawgiver than is expressed; and hence certain statutes, where extension is not plainly excluded, may be extended beyond the letter, to similar and omitted cases: others are to be confined to the statutory words.

12. A strict interpretation is to be applied, 1. To correctory statutes, which repeal or restrict former laws, and to statutes which enact heavy penalties, or restrain the natural liberties of mankind. 2. Laws, made on occasion of present exigencies in a state, ought not to be drawn to similar cases, after the pressure is over. 3. Where statutes establish certain solemnities as requisite to deeds, such solemnities are not suppliable by equivalents; for solemnities lose their nature, when they are not performed specifically. 4. A statute, which enumerates special cases, is, with difficulty, to be extended to cases not expressed; but, where a law does not descend to particulars, there is greater reason to extend it to similar cases. 5. Statutes, which carry a dispensation or privilege to particular persons or societies, suffer a strict interpretation; because they derogate from the general law, and imply a burden upon the rest of the community. But at no rate can a privilege be explained to the prejudice of those in whose behalf it was granted. As the only foundation of customary law is usage, which consists in fact, such law can go no farther than the particular usage has gone.

13. All statutes, concerning matters specially favoured by law, receive an ample interpretation; as laws for the encouragement of commerce, or of any useful public undertaking, for making effectual the wills of dying persons, for restraining fraud, for the security of creditors, &c. A statute, though its subject-matter should not be a favourite of the law, may be extended to similar cases, which did not exist when the statute was made; and for which, therefore, it was not in the lawgiver's power to provide.

14. Every statute, however unfavourable, must receive the interpretation necessary to give it effect: And, on the other hand, in the extension of favourable laws, scope must not be given to the imagination, in discovering remote resemblances; the extension must be limited to the cases immediately similar. Where there is ground to conclude that the legislature has omitted a case out of the statute purposely, the statute cannot be extended to that case, let it be ever so similar to the cases expressed.

## Tit. 2. Of Jurisdiction and Judges in general.

1. THE object of law are persons, things, and actions: among persons, judges, who are invested with jurisdiction, deserve the first consideration. Jurisdiction is a power conferred upon a judge or magistrate, to take cognizance of, and decide causes according to law, and to carry his sentences into execution. That tract of ground, or district, within which a judge has the right of jurisdiction,

is called his territory: and every act of jurisdiction, exercised by a judge without his territory, either by pronouncing sentence, or carrying it into execution, is null.

2. The supreme power, which has the right of enacting laws, falls naturally to have the right of erecting courts, and appointing judges, who may apply these laws to particular cases: But, in Scotland, this right has been always intrusted with the Crown, as having the executive power of the state.

3. Jurisdiction is either supreme, inferior, or mixed. That jurisdiction is supreme, from which there lies no appeal to a higher court. Inferior courts are those whose sentences are subject to the review of the supreme courts, and whose jurisdiction is confined to a particular territory. Mixed jurisdiction participates of the nature both of the supreme and inferior: thus, the judge of the high court of Admiralty, and the commissaries of Edinburgh, have an universal jurisdiction over Scotland, and they can review the decrees of inferior admirals and commissaries; but since their own decrees are subject to the review of the courts of Session or Justiciary, they are, in that respect, inferior courts.

4. Jurisdiction is either civil or criminal: by the first, questions of private right are decided; by the other, crimes are punished. But, in all jurisdiction, though merely civil, there is a power inherent in the judge to punish, either corporally, or by a pecuniary fine, those who offend during the proceedings of the court, or who shall afterwards obstruct the execution of the sentence.

5. Jurisdiction is either privative or cumulative. Privative jurisdiction, is that which belongs only to one court, to the exclusion of all others. Cumulative, otherwise called concurrent, is that which may be exercised by any one of two or more courts, in the same cause. In civil cumulative jurisdiction, the private pursuer has the right of election before which of the courts he shall sue; but as, in criminal questions which are prosecuted by a public officer of court, a collision of jurisdiction might happen, through each of the judges claiming the exercise of their right, that judge, by whose warrant the delinquent is first cited or apprehended, (which is the first step of jurisdiction), acquires thereby (*jure præventionis*) the exclusive right of judging in the cause.

6. All rights of jurisdiction, being originally granted in consideration of the fitness of the grantee, were therefore personal, and died with himself. But, upon the introduction of the feudal system, certain jurisdictions were annexed to lands, and descended to heirs, as well as the lands to which they were annexed; but now all heritable jurisdictions, except those of admiralty and a small pittance reserved to barons, are either abolished, or resumed and annexed to the crown.

7. Jurisdiction is either proper or delegated. Proper jurisdiction, is that which belongs to a judge or magistrate himself, in virtue of his office. Delegated, is that which is communicated by the judge to another who acts in his name, called a depute or deputy. Where a deputy appoints one under him, he is called a substitute. No grant of jurisdiction, which is an office requiring personal qualifications, can be delegated by the grantee to another, without an express power in the grant.

8. Civil jurisdiction is founded, 1. *Ratione domicilii*, if the defender has his domicile within the judge's territory. A domicile is the dwelling place where a person lives with an intention to remain; and custom has fixed it as a rule, that residence for forty days founds jurisdiction. If one has no fixed dwelling place, *e. g.* a soldier, or a travelling-merchant, a personal citation against him within the territory is sufficient to found the judge's jurisdiction over him, even in civil questions. As the defender is not obliged to appear before a court to which he is not subject, the pursuer must follow the defender's domicile.

9. It is founded, 2. *Ratione rei sitæ*, if the subject in question lie within the territory. If that subject be immoveable, the judge, whose jurisdiction is founded in this way, is the sole judge competent, excluding the judge of the domicile.

10. Where one, who has not his domicile within the territory, is to be sued before an inferior court *ratione rei sitæ*, the court of session must be applied to, whose jurisdiction is universal, and who, of course, grants letters of supplement to cite the defender to appear before the inferior judge. Where the party to be sued resides in another kingdom, and has an estate in this, the court of session is the only proper court, as the *commune forum* to all persons residing abroad; and the defender, if his estate be heritable, is considered as lawfully summoned to that court, by a citation at the market-cross of Edinburgh, and pier and shore of Leith: but where a stranger, not a native of Scotland, has only a moveable estate in this kingdom, he is deemed to be so little subject to the jurisdiction of our courts, that action cannot be brought against him till his effects be first attached by an arrestment *jurisdictionis fundandæ causa*, *Harc. 487*, which is laid on by a warrant issuing from the supreme courts of session, or admiralty, or from that within whose territory the subject is situated, at the suit of the creditor.

11. A judge may, in special cases, arrest or secure the persons of such as have neither domicile nor estate within his territory, even for civil debts. Thus, on the border between Scotland and England, warrants are granted of course by the judge-ordinary of either side, against those who have their domicile upon the opposite side, for arresting their persons, till they give caution *judicio fisci*: and even the persons of citizens or natives may be so secured, where there is just reason to suspect that they are *in meditatione fugæ*, *i. e.* that they intend suddenly to withdraw from the kingdom; upon which suspicion, the creditor who applies for the warrant must make oath. An inhabitant of a borough-royal, who has furnished one who lives without the borough in meat, cloaths, or other merchandize, and who has no security for it but his own compt-book, may arrest his debtor, till he give security *judicio fisci*.

12. A judge may be declined, *i. e.* his jurisdiction disowned judicially, 1. *Ratione causæ*, from his incompetency to the special cause brought before him. 2. *Ratione suspecti judicis*; where either the judge himself, or his near kinsman, has an interest in the suit. No judge can vote in the cause of his father, brother, or son, either by consanguinity or affinity; nor in the cause of his uncle or nephew by consanguinity. 3. *Ratione pri-*

*vilegii*; where the party is by privilege exempted from their jurisdiction.

13. Prorogated jurisdiction (*jurisdictio in consentientes*) is that which is, by the consent of parties, conferred upon a judge, who, without such consent, would be incompetent. Where a judge is incompetent, every step he takes must be null, till his jurisdiction be made competent by the parties actual submission to it. It is otherwise where the judge is competent, but may be declined by the party upon privilege.

14. In order to prorogation, the judge must have jurisdiction, such as may be prorogated. Hence, prorogation cannot be admitted where the judge's jurisdiction is excluded by statute. Yet where the cause is of the same nature with those to which the judge is competent, though law may have confined his jurisdiction within a certain sum, parties may prorogate it above that sum unless where prorogation is prohibited. Prorogation is not admitted in the king's causes; for the interest of the Crown cannot be hurt by the negligence of its officers.

15. All judges must at their admission swear, 1. The oath of allegiance, and subscribe the assurance; 2. The oath of abjuration; 3. The oath of supremacy; lastly, The oath *de fideli administratione*.

16. A party who has either properly declined the jurisdiction of the judge before whom he had been cited, or who thinks himself aggrieved by any proceedings in the cause, may, before decree, apply to the court of session to issue letters of advocacy for calling the action from before the inferior court to themselves. The grounds therefore, upon which a party may pray for letters of advocacy, are incompetency and iniquity. Under incompetency, is comprehended not only defect of jurisdiction, but all the grounds of declining a jurisdiction, in itself competent, arising either from suspicion of the judge, or privilege in the parties. A judge is said to commit iniquity, when he either delays justice, or pronounces sentence, in the exercise of his jurisdiction, contrary to law.

17. That the court of session may not waste their time in trifles, no cause for a sum below twelve pound Sterling can be advocated to the court of session from the inferior judge competent: but if an inferior judge shall proceed upon a cause to which he is incompetent, the cause may be carried from him by advocacy, let the subject be ever so inconsiderable.

### Tit. 3. *Of the supreme Judges and Courts of Scotland.*

1. THE King, who is the fountain of jurisdiction, might by our constitution have judged in all causes, either in his own person, or by those whom he was pleased to vest with jurisdiction.

2. The parliament of Scotland, as our court of the last resort, had the right of reviewing the sentences of all our supreme courts.

3. By the treaty of union, 1707, the parliaments of Scotland and England are united into one parliament of Great Britain. From this period, the British house of Peers, as coming in place of the Scots parliament, is become our court of the last resort, to which appeals lie

from all the supreme courts of Scotland: But that court has no original jurisdiction in civil matters, in which they judge only upon appeal. By art. 22. of that treaty, the Scots share of the representation in the house of Peers is fixed to sixteen Scots peers elective; and in the house of Commons, to forty-five commoners, of which thirty are elected by the freeholders of counties, and fifteen by the royal boroughs. The Scots privy council was also thereupon abolished, and sunk into that of Great Britain, which for the future is declared to have no other powers than the English privy council had at the time of the union.

### COURT OF SESSION.

4. A court was erected in 1425, consisting of certain persons to be named by the king, out of the three estates of parliament, which was vested with the jurisdiction formerly lodged in the privy council, and got the name of the Session, because it was ordained to hold annually a certain number of sessions at the places to be specially appointed by the king. This court had a jurisdiction, cumulative with the judge ordinary, in spuilzies, and other possessory actions, and in debts; but they had no cognizance in questions of property of heritable subjects. No appeal lay from its judgments to the parliament. The judges of this court served by rotation, and were changed from time to time, after having sat forty days; and became so negligent in the administration of justice, that it was at last thought necessary to transfer the jurisdiction of this court to a council to be named by the king, called the daily council.

5. The present model of the court of session, or college of justice, was formed in the reign of James V. The judges thereof, who are vested with an universal civil jurisdiction, consisted originally of seven churchmen, seven laymen, and a president, whom it behoved to be a prelate; but spiritual judges were in 1584 partly, and in 1640 totally prohibited. The judges of session have been always received by warrants from the crown. Anciently his Majesty seems to have transferred to the court itself the right of chusing their own president; and in a sederunt recorded June 26. 1593, the king condescended to present to the lords, upon every vacancy in the bench, a list of three persons, out of which they were to chuse one. But his Majesty soon resumed the exercise of both rights, which continued with the Crown till the usurpation; when it was ordained, that the king should name the judges of the session, by the advice of parliament. After the restoration, the nomination was again declared to be solely in the Sovereign.

6. Though judges may, in the general case, be named at the age of twenty-one years, the lords of session must be at least twenty-five. No person can be named lord of session, who has not served as an advocate or principal clerk of session for five years, or as a writer to the signet for ten: and in the case of a writer to the signet, he must undergo the ordinary trials upon the Roman law, and be found qualified two years before he can be named. Upon a vacancy in the bench, the king presents the successor by a letter addressed to the lords, wherein he requires them to try and admit the person presented. The powers given them to reject the person presented upon trial are

taken away, and a bare liberty to remonstrate substituted in its place.

7. Besides the fifteen ordinary judges, the king was allowed to name three or four lords of his great council, who might sit and vote with them. These extraordinary lords were suppressed in the reign of Geo. I.

8. Though the jurisdiction of the session be properly limited to civil causes, the judges have always sustained themselves as competent to the crime of falsehood. Where the falsehood deserves death or demerbration, they, after finding the crime proved, remit the criminal to the court of justiciary. Special statute has given to the court of session jurisdiction in contraventions of law-burrows, de-forcements, and breach of arrestment; and they have been in use to judge in battery *pendente lite*, and in usury.

9. In certain civil causes, the jurisdiction of the session is exclusive of all inferior jurisdictions; as in declarators of property, and other competitions of heritable rights, provings of the tenor, *cessiones honorum*, restitution of minors, reductions of decrees or of writings, sales of the estates of minors or bankrupts, &c. In a second class of causes, their jurisdiction can be only exercised in the way of review, after the cause is brought from the inferior court; as in maritime and consistorial causes, which must be pursued in the first instance before the admiral or commissary; and in actions below twelve pounds Sterling, which must be commenced before the judge-ordinary. In all civil actions, which fall under neither of these classes, the jurisdiction of the session is concurrent, even in the first instance, with that of the judge-ordinary. The session may proceed as a court of equity by the rules of conscience, in abating the rigour of law, and giving aid in proper cases to such as in a court of law can have no remedy: and this power is inherent in the supreme court of every country, where separate courts are not established for law and for equity.

#### COURT OF JUSTICIARY.

10. The supreme criminal judge was styled the Justiciar; and he had anciently an universal civil jurisdiction, even in matters of heritage. He was obliged to hold two justice courts or ayres yearly at Edinburgh or Peebles, where all the free-holders of the kingdom were obliged to attend. Besides this universal court, special justice-ayres were held in the different shires of the kingdom twice in the year. These last having gone into disuse, eight deputies were appointed, two for every quarter of the kingdom, who should make their circuits over the whole in April and October.

11. The office of deputies was suppressed in 1672; and five lords of session were added, as commissioners of Justiciary, to the justice-general and justice clerk. The justice-general, if present, is constant president of the court, and in his absence the justice-clerk. The kingdom is divided into three districts, and two of the judges are appointed to hold circuits in certain boroughs of each district twice in the year; one judge may proceed to business in the absence of his colleague.

12. By an old statute, the crimes of robbery, rape, murder, and wilful fire raising, (the four pleas of the

Crown), are said to be referred to the King's court of Justiciary; but the only crime in which, *de praxi*, the jurisdiction of Justiciary became at last exclusive of all inferior criminal jurisdiction, was that of high treason. The court of Justiciary, when sitting at Edinburgh, has a power of advocating causes from all inferior criminal judges, and of suspending their sentences.

13. The circuit-court can also judge in all criminal causes which do not infer death or demerbration, upon appeal from any inferior court within their district; and has a supreme civil jurisdiction, by way of appeal, in all causes not exceeding twelve pounds Sterling, in which their decrees are not subject to review; but no appeal is to lie to the circuit, till the cause be finally determined in the inferior court.

#### COURT OF EXCHEQUER.

14. The court of Exchequer, as the King's chamberlain-court, judged in all questions of the revenue. In pursuance of the treaty of Union, that court was abolished, and a new court erected, consisting of the Lord High Treasurer of Great Britain, and a chief Baron, with four other Barons of Exchequer; which Barons are to be made of serjeants at law, English barristers, or Scots advocates of five years standing. This court has a privative jurisdiction conferred upon it, as to the duties of customs, excise, or other revenues appertaining to the King or Prince of Scotland, and as to all honours and estates that may accrue to the crown; in which matters, they are to judge by the forms of proceeding used in the English court of Exchequer, under the following limitations; that no debt due to the Crown shall affect the debtor's real estate in any other manner than such estate may be affected by the laws of Scotland, and that the validity of the Crown's titles to any honours or lands shall continue to be tried by the court of Session. The Barons have the powers of the Scots court transferred to them, of passing the accounts of sheriffs, or other officers who have the execution of writs issuing from, or returnable to the court of Exchequer, and of receiving resignations, and passing signatures of charters, gifts of casualties, &c. But though all these must pass in Exchequer, it is the court of Session only who can judge of their preference after they are completed.

#### ADMIRAL COURT.

15. The jurisdiction of the Admiral in maritime causes was of old concurrent with that of the Session. The High-admiral is declared the King's Justice-General upon the seas, on fresh water within flood mark, and in all harbours and creeks. His civil jurisdiction extends to all maritime causes, and so comprehends questions of charter parties, freights, salvages, bottomries, &c. He exercises this supreme jurisdiction by a delegate, the judge of the high-court of admiralty; and he may also name inferior deputies, whose jurisdiction is limited to particular districts, and whose sentences are subject to the review of the high court. In causes which are declared to fall under the Admiral's cognizance, his jurisdiction is now sole; in so much that the Session itself, though they may review his decrees by suspension or reduction, can-



not carry a maritime question from him by advocacy. The Admiral has acquired, by usage, a jurisdiction in mercantile causes, even where they are not strictly maritime, cumulative with that of the judge-ordinary.

16. All our supreme courts have seals or signets, proper to their several jurisdictions. The courts of Session and Justiciary used formerly the same signet, which was called the King's, because the writs issuing from thence run in the King's name; and though the Justiciary got at last a separate signet for itself, yet that of the Session still retains the appellation of the *King's Signet*. In this office are sealed summonses for citation, letters of executorial diligence, or for staying or prohibiting of diligence, and generally whatever passes by the warrant of the Session, and is to be executed by the officers of the court. All these must, before sealing, be signed by the writers or clerks of the signet: But letters of diligence, where they are granted in a depending process, merely for probation, though they pass by the signet, must be subscribed by a clerk of Session. The clerks of the signet also prepare and subscribe all signatures of charters, or other royal grants, which pass in Exchequer.

#### Tit. 4. *Of the inferior Judges and Courts of Scotland.*

##### SHERIFF.

SHERIFF, from *reeve*, governor, and *sheer*, to cut or divide, is the judge ordinary constituted by the Crown over a particular division or county. The Sheriff's jurisdiction, both civil and criminal, was, in ancient times, nearly as ample within his own territory as that of the supreme courts of Session and Justiciary was over the whole kingdom.

2. His civil jurisdiction now extends to all actions upon contracts, or other personal obligations, forthcomings, poundings of the ground, mails and duties, and to all possessory actions, as removing, ejectons, spuilzies, &c. to all brieves issuing from the chancery, as of inquest, terce, division, tutory, &c. and even to adjudications of land-estates, when proceeding on the renunciation of the apparent heir. His present criminal jurisdiction extends to certain capital crimes, as theft, and even murder, though it be one of the pleas of the Crown; and he is competent to most questions of public police, and has a cumulative jurisdiction with justices of the peace in all riots and breaches of the peace.

3. Sheriffs have ministerial power, in virtue of which, they return juries, in order to the trial of causes that require juries. The writs for electing members of parliament have been, since the union, directed to the Sheriffs, who, after they are executed, return them to the crown-office from whence they issued. They also execute writs issuing from the court of Exchequer; and in general, take care of all estates, duties, or casualties that fall to the Crown within their territory, for which they must account to the Exchequer.

##### LORD OF REGALTY.

4. A Lord of Regality was a magistrate, who had a

grant of lands from the Sovereign, with royal jurisdiction annexed thereto. His civil jurisdiction was equal to that of a Sheriff; his criminal extended to the four pleas of the crown. He had a right to repledge or reclaim all criminals, subject to his jurisdiction, from any other competent court, though it were the Justiciary itself, to his own. He had also right, according to the most common opinion, to the single escheat of all denounced persons residing within his jurisdiction, even though such privilege had not been expressed in the grant of regality.

##### STEWART.

5. The Stewart was the magistrate appointed by the King over such regality lands as happened to fall to the Crown by forfeiture, &c. and therefore the Stewart's jurisdiction was equal to that of a regality. The two Stewartries of Kircudbright, and of Orkney and Zetland, make shires or counties by themselves, and send each a representative to parliament.

##### BAILIE.

6. Where lands, not erected into a regality, fell into the King's hands, he appointed a Bailie over them, whose jurisdiction was equal to that of a Sheriff.

7. By the late jurisdiction act 20. *Geo. II.* all heritable regalities and baileries, and all such heritable sheriffships and stewartries as were only parts of a shire, are dissolved; and the powers formerly vested in them are made to devolve upon such of the King's courts as these powers would have belonged to if the jurisdictions dissolved had never been granted. All sheriffships and stewartries that were no part of a shire, where they had been granted, either heritably or for life, are resumed and annexed to the crown. No High Sheriff or Stewart can hereafter judge personally in any cause. One Sheriff or Stewart-depute is to be appointed by the King in every shire, who must be an advocate of three years standing; and after a certain term not yet expired, all commissions to these deputies are to be granted for life.

##### PRINCE OF SCOTLAND.

8. The appanage, or patrimony, of the Prince of Scotland, has been long erected into a regality-jurisdiction, called the Principality. It is personal to the King's eldest son, upon whose death or succession it returns to the Crown. The prince has, or may have, his own chancery, from which his writs issue, and may name his own chamberlain and other officers for receiving and managing his revenue. The vassals of the Prince are intitled to elect, or to be elected members of Parliament for counties, equally with those who hold of the Crown.

##### JUSTICES OF THE PEACE.

9. Justices of the Peace are magistrates named by the Sovereign over the several counties of the kingdom, for the special purpose of preserving the public peace. Anciently their power reached little farther than to bind over disorderly persons for their appearance before the Privy Council or Justiciary; afterwards they were authorized to judge in breaches of the peace, and in most of the laws concerning public policy. They may compel workmen or labourers to serve for a reasonable fee, and they

they can condemn masters in the wages due to their servants. They have power to judge in questions of highways, and to call out the tenants with their cotiers and servants to perform six days work yearly for upholding them.

10. Since the Union our justices of the peace, over and above the powers committed to them by the laws of Scotland, are authorised to exercise whatever belonged to the office of an English justice of the peace, in relation to the public peace. From that time, the Scots and the English commissions have run in the same style, which contain powers to inquire into, and judge in all capital crimes, witchcrafts, felonies, and several others specially enumerated, with this limitation subjoined, *of which justices of the peace may lawfully inquire*. Two justices can constitute a court. Special statute has given the cognisance of several matters of excise to the justices, in which their sentences are final.

#### BOROUGHES.

11. A borough is a body-corporate, made up of the inhabitants of a certain tract of ground erected by the Sovereign, with jurisdiction annexed to it. Boroughs are erected, either to be holden of the Sovereign himself, which is the general case of royal boroughs; or of the superior of the lands erected, as boroughs of regality and barony. Boroughs-royal have power, by their charters, to chuse annually certain office-bearers or magistrates; and in boroughs of regality and barony, the nomination of magistrates is, by their charter, lodged sometimes in the inhabitants, sometimes in the superior. Bailies of boroughs have jurisdiction in matters of debt, services, and questions of possession betwixt the inhabitants. Their criminal jurisdiction extends to petty riots, and reckless fire-raising. The Dean of Guild is that magistrate of a royal borough who is head of the merchant-company: he has the cognisance of mercantile causes within borough, and the inspection of buildings, that they incroach neither on private property, nor on the public streets; and he may direct insufficient houses to be pulled down. His jurisdiction has no dependance on the court of the borough, or bailie-court.

#### BARONS.

12. A Baron, in the large sense of that word, is one who holds his lands immediately of the Crown; and, as such, had, by our ancient constitution, right to a seat in parliament, however small his freehold might have been. The lesser Barons were exempted from the burden of attending the service of parliament. This exemption grew insensibly into an utter disability in all the lesser Barons from sitting in parliament, without election by the county; though no statute is to be found expressly excluding them.

13. To constitute a Baron in the strict law-sense, his lands must have been erected, or at least confirmed by the King, *in liberam baroniam*: and such Baron had a certain jurisdiction, both civil and criminal, which he might have exercised, either in his own person, or by his bailie.

14. By the late jurisdiction-act, the civil jurisdiction

of a Baron is reduced to the power of recovering, from his vassals and tenants, the rents of his lands, and of condemning them in mill-services; and of judging in causes where the debt and damages do not exceed 40 s. Sterling. His criminal jurisdiction is, by the same statute, limited to assaults, batteries, and other smaller offences, which may be punished by a fine not exceeding 20 s. Sterling, or by setting the offender in the stocks in the day-time not above three hours; the fine to be levied by pouding, or one month's imprisonment. The jurisdiction formerly competent to proprietors of mines, and coal or salt works, over their workmen, is reserved; and also that which was competent to proprietors who had the right of fairs or markets, for correcting the disorders that might happen during their continuance; provided they shall exercise no jurisdiction inferring the loss of life or demembration.

#### CONSTABULARIES.

15. The High Constable of Scotland had no fixed territorial jurisdiction, but followed the court; and had, jointly with the Marischal, the cognisance of all crimes committed within two leagues of it. All other constabularies were dependant on him: These had castles, and sometimes boroughs subject to their jurisdiction, as Dundee, Montrose, &c. and amongst other powers, now little known, they had the right of exercising criminal jurisdiction within their respective territories during the continuance of fairs. By the late jurisdiction-act, all jurisdictions of constabulary are dissolved, except that of High Constable.

#### LYON KING OF ARMS.

16. The office of the Lyon King of Arms was chiefly ministerial, to denounce war, proclaim peace, carry public messages, &c. But he has also a right of jurisdiction, whereby he can punish all who usurp arms contrary to the law of arms, and deprive or suspend messengers, heralds, or pursuivants, (who are officers named by himself;) but he has no cognisance of the damage arising to the private party through the messenger's fault. Messengers are subservient to the supreme courts of session and judiciary; and their proper business is to execute all the King's letters either in civil or criminal causes.

17. Our judges had, for a long time, no other salaries or appointments than what arose from the sentences they pronounced. Our criminal judges applied to their own use the fines or issues of their several courts; and regalities had a right to the single escheat of all persons denounced, who resided within their jurisdiction; and our civil judges got a certain proportion of the same contained in the decree pronounced. But these were all prohibited upon regular salaries being settled upon our judges.

#### Tit. 5. Of Ecclesiastical Persons.

THE Pope, or bishop of Rome, was long acknowledged, over the western part of Christendom, for the head of the Christian church. The papal jurisdiction was abolished in Scotland *anno* 1560. The King was, by act 1669, declared to have supreme authority over all

persons, and in all causes ecclesiastical; but this act was repealed by 1690, as inconsistent with Presbyterian church-government, which was then upon the point of being established.

2. Before the reformation from Popery, the clergy was divided into secular and regular. The secular had a particular tract of ground given them in charge, within which they exercised the pastoral office of bishop, presbyter, or other church officer. The regular clergy had no cure of souls, but were tied down to residence in their abbeys, priories, or other monasteries: And they got the name of regular, from the rules of mortification to which they were bound, according to the institution of their several orders. Upon the vacancy of any benefice, whether secular or regular, Commendators were frequently appointed to levy the fruits, as factors or stewards during the vacancy. The Pope alone could give the higher benefices *in commendam*; and at last, from the plenitude of his power, he came to name commendators for life, and without any obligation to account. After the reformation, several abbeys and priories were given by James VI. *in perpetuam commendam*, to laics.

3. Upon abolishing the Pope's authority, the regular clergy was totally suppressed; and, in place of all the different degrees which distinguished the secular clergy, we had at first only parochial Presbyters or Ministers, and superintendants, who had the oversight of the church within a certain district: Soon thereafter the church-government became episcopal, by Archbishops, Bishops, &c. and after some intermediate turns, is now Presbyterian by kirk-sessions, presbyteries, synods, and general assemblies.

4. Prelate, in our statutes, signifies a Bishop, Abbot, or other dignified clergyman, who in virtue of his office had a seat in parliament. Every Bishop had his Chapter, which consisted of a certain number of the ministers of the diocese, by whose assistance he managed the affairs of the church within that district. The nomination of Bishops to vacant sees has been in the crown since 1540, though under the appearance of continuing the ancient right of election, which was in the Chapter. The confirmation by the Crown under the great seal, of the Chapter's election, confirmed a right to the spirituality of the benefice; and a second grant, upon the consecration of the Bishop-elect, gave a title to the temporality; but this second grant fell soon into disuse.

5. He who founded or endowed a church was intitled to the right of patronage thereof, or *advocatio ecclesie*; whereby, among other privileges, he might present a churchman to the cure, in case of a vacancy. The presentee, after he was received into the church, had a right to the benefice *proprio jure*; and if the church was parochial, he was called a parson. The Pope claimed the right of patronage of every kirk, to which no third party could shew a special title; and since the reformation, the Crown, as coming in place of the Pope, is considered as universal patron. where no right of patronage appears in a subject. Where two churches are united, which had different patrons, each patron presents by turns.

6. Gentlemen of estates frequently founded colleges or

collegiate churches, the head of which got the name of Provost, under whom were certain Prebendaries or Canons, who had their several stalls in the church, where they sung masses. Others of lesser fortunes founded chaplainries, within the precincts of a parochial church; or altarges, which were donations granted for the singing of masses for deceased friends at particular altars in a church. Though all these were suppressed upon the reformation, their founders continued patrons of the endowments; out of which they were allowed to provide bursars, to be educated in any of the universities.

7. Where a fund is gifted for the establishment of a second minister in a parish where the cure is thought too heavy for one, the patronage of such benefice does not belong to the donor, but to him who was patron of the church, unless either where the donor has reserved to himself the right of patronage in the donation, or where he and his successors have been in the constant use of presenting the second minister, without challenge from the patron. The right of presenting incumbents was by 1690, c. 23. taken from patrons, and vested in the heritors and elders of the parish, upon payment to be made by the heritors to the patron of 600 merks; but it was again restored to patrons, 10. An. c. 12. with the exception of the presentations sold in pursuance of the former act.

8. Patrons were not simply administrators of the church; for they held the fruits of the vacant benefice as their own, for some time after the reformation. But that right is now no more than a trust in the patron, who must apply them to pious uses within the parish, at the sight of the heritors, yearly as they fall due. If he fail, he loses his right of administering the vacant stipend for that and the next vacancy. The king, who is exempted from this rule, may apply the vacant stipend of his churches to any pious use, though not within the parish. If one should be ordained to a church, in opposition to the presentee, the patron, whose civil right cannot be affected by any sentence of a church-court, may retain the stipend as vacant. Patrons are to this day intitled to a seat and burial-place in the churches of which they are patrons; and to the right of all the tithes of the parish not heritably disposed.

9. That kirks may not continue too long vacant, the patron must present to the presbytery, (formerly to the Bishop), a fit person for supplying the cure, within six months from his knowledge of the vacancy, otherwise the right of presentation accrues to the presbytery *jure devoluto*. Upon presentation by the patron, the Bishop collated or conferred the benefice upon the presentee by a writing, in which he appointed certain ministers of the diocese to induce or institute him into the church; which induction completed his right, and was performed by their placing him in the pulpit, and delivering him the bible and the keys of the church. The bishop collated to the churches of which himself was patron, *pleno jure*, or without presentation; which he also did in menial churches, whose patronages were sunk, by the churches being appropriated to him, as part of his patrimony. Since the revolution, a judicial act of admission by the presbytery, proceeding either upon a presentation, or up-

on a call from the heritors and elders, or upon their own *ius devolutum*, compleats the minister's right to the benefice.

10. Soon after the reformation, the Popish churchmen were prevailed upon to resign in the sovereign's hands, a third of their benefices, which was appropriated, in the first place, for the subsistence of the reformed clergy. To make this fund effectual, particular localities were assigned in every benefice, to the extent of a third, called the assumption of thirds; and for the farther support of ministers. Queen Mary made a grant in their favour of all the small benefices not exceeding 300 merks. Bishops, by the act which restored them to the whole of their benefices, were obliged to maintain the ministers within their dioceses, out of the thirds; and in like manner, the laic titulars, who got grants of the teinds, became bound, by their acceptance thereof, to provide the kirks within their erections in competent stipends.

11. But all these expedients for the maintenance of the clergy having proved ineffectual, a commission of parliament was appointed in the reign of James VI. for planting kirks, and modifying stipends to ministers out of the teinds; and afterwards several other commissions were appointed, with the more ample powers of dividing large parishes, erecting new ones, &c. all of which were, in 1707, transferred to the court of Session, with this limitation, that no parish should be disjoined, nor new church erected, nor old one removed to a new place, without the consent of three fourths of the heritors, computing the votes, not by their numbers, but by the valuation of their rents within the parish. The Judges of Session, when sitting in that court, are considered as a commission of Parliament, and have their proper clerks, macers, and other officers of court, as such.

12. The lowest stipend that could be modified to a minister by the first commission was 500 merks, or five chalders of victual, unless where the whole teinds of the parish did not extend so far: And the highest was 1000 merks, or ten chalders. The parliament 1633 raised the *minimum* to eight chalders of victual, and proportionably in silver; but as neither the commission appointed by that act, nor any of the subsequent ones, was limited as to the *maximum*, the commissioners have been in use to augment stipends considerably above the old *maximum*, where there is sufficiency of free teinds, and the cure is burdensome, or living expensive.

13. Where a certain quantity of stipend is modified to a minister out of the teinds of a parish, without proportioning that stipend among the several heritors, the decree is called a *decree of modification*: But where the commissioners also fix the particular proportions payable by each heritor, it is a decree of *modification and locality*. Where a stipend is only modified, it is secured on the whole teinds of the parish, so that the minister can insist against any one heritor to the full extent of his teinds, such heritor being always entitled to relief against the rest, for what he shall have paid above his just share: But where the stipend is also localised, each heritor is liable in no more than his own proportion.

14. Few of the reformed ministers were, at first, provided with dwelling houses: most of the Popish clergy

having, upon the first appearance of the reformation, let their manse in feu, or in long tacks: Ministers therefore got a right, by 1563. to as much of these manse as would serve them, notwithstanding such feus or tacks. Where there was no parson's nor vicar's manse, one was to be built by the heritors, at the sight of the bishop, (now the Presbytery,) the charge not exceeding L. 1000 Scots, nor below 500 merks. Under a manse are comprehended stable, barn, and byre, with a garden; for all which, it is usual to allow half an acre of ground.

15. Every incumbent is intitled at his entry to have his manse put into good condition; for which purpose, the presbytery may appoint a visitation by tradesmen, and order estimates to be laid before them of the sums necessary for the repairing, which they may proportion among the heritors according to their valuations. The presbytery, after the manse is made sufficient, ought, upon application of the heritors, to declare it a free manse, which lays the incumbent under an obligation to uphold it in good condition during his incumbency; otherwise, he or his executors shall be liable in damages: But they are not bound to make up the loss arising from the necessary decay of the building by the waste of time.

16. All ministers, where there is any landward or country-parish, are, over and above their stipend, intitled to a glebe, which comprehends four acres of arable land, or sixteen fowms of pasture-ground where there is no arable land, (a fowm is what will graze ten sheep or one cow), and is to be designed or marked by the bishop or presbytery out of such kirk-lands within the parish as lie nearest to the kirk, and, in default of kirk-lands, out of temporal lands.

17. A right of relief is competent to the heritors, whose lands are set off for the manse or glebe, against the other heritors of the parish. Manses and glebes, being once regularly designed, cannot be feued or sold by the incumbent in prejudice of his successors, which in practice extended even to the case where such alienation evidently appears profitable to the benefice.

18. Ministers, besides their glebe, are intitled to grass for a horse and two cows. And, if the lands out of which the grass may be designed, either lie at a distance, or are not fit for pasture, the heritors are to pay to the minister L. 20 Scots yearly as an equivalent. Ministers have also freedom of baggage, pasture, fowel, seal, divot, loaning, and free fish and entry, according to use and wont: What these privileges are, must be determined by the local custom of the several parishes.

19. The legal terms at which stipends become due to ministers are Whitunday and Michaelmas. If the incumbent be admitted to his church before Whitunday, till which term the corns are not presumed to be fully sown, he has right to that whole year's stipend; and, if he is received after Whitunday, and before Michaelmas, he is intitled to the half of that year; because, tho' the corns were sown before his entry, he was admitted before the term at which they are presumed to be reaped. By the same reason, if he dies or is transported before Whitunday, he has right to no part of that year; if before Michaelmas, to the half; and if not till after Michaelmas, to the whole.

20. After

20. After the minister's death, his executors have right to the annat; which, in the sense of the canon law, was a right reserved to the Pope, of the first year's fruits of every benefice. Upon a threatened invasion from England *anno* 1547, the annat was given by our Parliament, notwithstanding this right in the Pope, to the executors of such churchmen as should fall in battle in defence of their country: But the word *annat* or *ann*, as it is now understood, is the right which law gives to the executors of ministers, of half a year's benefice, over and above what was due to the minister himself for his incumbency.

21. The executors of a minister need make up no title to the ann by confirmation: Neither is the right assignable by the minister, or affectable with his debts; for it never belonged to him, but is a mere gratuity given by law to those whom it is presumed the deceased could not sufficiently provide; and law has given it expressly to *executors*: And if it were to be governed by the rules of succession in executory, the widow, in case of no children, would get one half, the other would go to the next of kin; and where there are children, she would be intitled to a third, and the other two thirds would fall equally among the children. But the court of Session, probably led by the general practice, have in this last case divided the ann into two equal parts, of which one goes to the widow, and the other among the children *in capita*.

22. From the great confidence that was, in the first ages of Christianity, reposed in churchmen, dying persons frequently committed to them the care of their estates, and of their orphan children: but these were simply rights of trust, not of jurisdiction. The clergy soon had the address to establish to themselves a proper jurisdiction, not confined to points of ecclesiastical right, but extending to questions that had no concern with the church. They judged, not only in tithes, patronages, testaments, breach of vow, scandal, &c.; but in questions of marriage and divorce, because marriage was a sacrament; in tochers, because these were given in consideration of marriage; in all questions where an oath intervened, on pretence that oaths were a part of religious worship, &c. As churchmen came, by the means of this extensive jurisdiction, to be diverted from their proper functions, they committed the exercise of it to their officials or commissaries: Hence the Commissary-court was called the Bishops court, and *Curia Christianitatis*; it is also styled the Consistorial Court, from *Consistory*, a name first given to the court of appeals of the Roman Emperors and afterwards to the courts of judicature held by churchmen.

23. At the reformation, all episcopal jurisdiction, exercised under the authority of the Bishop of Rome, was abolished. As the course of justice in consistorial causes was thereby stopped, Q. Mary besides naming a Commissary for every diocese, did, by a special grant, establish a new Commissary-court at Edinburgh, consisting of four judges or commissaries. This court is vested with a double jurisdiction; one diocesan, which is exercised in the special territory contained in the grant, *viz* the counties of Edinburgh, Haddington, Linlithgow, Peebles, and a part part of Stirling-shire; and another universal, by which the judges confirm the testaments of all

who die in foreign parts, and may reduce the decrees of all inferior Commissaries, provided the reduction be pursued within a year after the decree: Bishops, upon their re-establishment in the reign of James VI. were restored to the right of naming their several Commissaries.

24. As the clergy in times of Popery assumed a jurisdiction independent of the civil power or any secular court, their sentences could be reviewed only by the Pope, or judges delegated by him; so that, with regard to the courts of Scotland, their jurisdiction was supreme. But by an act 1560, the appeals from our Bishops courts, that were then depending before the Roman consistory, were ordained to be decided by the court of Session: And by a posterior act 1609, the Session is declared the King's great Consistory, with power to review all sentences pronounced by the Commissaries. Nevertheless, since that court had no inherent jurisdiction in consistorial causes, prior to this statute; and since the statute gives them a power of judging only by way of advocacion, they have not, to this day, any proper consistorial jurisdiction in the first instance: neither do they pronounce sentence, in any consistorial cause brought from the Commissaries, but remit it back to them with instructions. By the practice immediately subsequent to the act before quoted, they did not admit advocacions from the inferior Commissaries, till the cause was brought before the Commissaries of Edinburgh; but that practice is now in disuse.

25. The Commissaries retain to this day an exclusive power of judging in declarators of marriage, and of the nullity of marriage; in actions of divorce and of non-adherence, of adultery, bastardy, and confirmation of testaments: because all these matters are still considered to be properly consistorial. Inferior Commissaries are not competent to questions of divorce, under which are comprehended questions of bastardy and adherence, when they have a connection with the lawfulness of marriage, or with adultery.

26. Commissaries have now no power to pronounce decrees in absence for any sum above L. 40 Scots, except in causes properly consistorial: but they may authenticate tutorial and curatorial inventories; and all bonds, contracts, &c. which contain a clause for registration in the books of any judge competent, and protests on bills, may be registred in their books.

#### Tit. 6. Of Marriage.

PERSONS, when considered in a private capacity, are chiefly distinguished by their mutual relations; as husband and wife, tutor and minor, father and child, master and servant. The relation of husband and wife is constituted by marriage; which is the conjunction of man and wife, vowing to live inseparably till death.

2. Marriage is truly a contract, and so requires the consent of parties. Idiots, therefore, and furious persons cannot marry. As no person is presumed capable of consent within the years of pupillarity, which, by our law, lasts till the age of fourteen in males, and twelve in females; marriage cannot be contracted by pupils; but if the married pair should cohabit after puberty, such acquiescence

acquiescence gives force to the marriage. Marriage is fully perfected by consent; which, without consummation, founds all the conjugal rights and duties. The consent requisite to marriage must be *de presenti*. A promise of marriage, (*stipulatio sponsalitia*;) may be rescinded from, as long as matters are entire; but if any thing be done by one of the parties, whereby a prejudice arises from the non-performance, the party rescinding is liable in damages to the other. The canonists, and after them our courts of justice, explain a *copula* subsequent to a promise of marriage into actual marriage.

3. It is not necessary, that marriage should be celebrated by a clergyman. The consent of parties may be declared before any magistrate, or simply before witnesses: And though no formal consent should appear, marriage is presumed from the cohabitation, or living together at bed and board, of a man and woman who are generally reputed husband and wife. One's acknowledgment of his marriage to the midwife whom he called to his wife, and to the minister who baptized his child, was found sufficient presumptive evidence of marriage, without the aid, either of cohabitation, or of *habite and repute*. The father's consent was, by the Roman law, essential to the marriage of children *in familia*: But, by our law, children may enter into marriage, without the knowledge; and even against the remonstrances of a father.

4. Marriage is forbidden within certain degrees of blood. By the law of Moses, *Levit. c. 18.* which is made ours, seconds in blood, and all remoter degrees, may lawfully marry. By seconds in blood, are meant first cousins. Marriage in the direct line is forbidden *in infinitum*; as it is also in the collateral line, in the special case where one of the parties is *loco parentis* to the other, as grand-uncle, great grand-uncle, &c. with respect to his grand-niece, &c. The same degrees that are prohibited in consanguinity, are prohibited in affinity; which is the tie arising from marriage, betwixt one of the married pair and the blood-relations of the other. Marriage also, where either of the parties is naturally unfit for generation, or stands already married to a third person, is *ipso jure* null.

5. To prevent bigamy and incestuous marriages, the church has introduced proclamation of banns; which is the ceremony of publishing the names and designations of those who intend to intermarry, in the churches where the bride and bridegroom reside, after the congregation is assembled for divine service; that all persons who know any objection to the marriage, may offer it. When the order of the church is observed, the marriage is called regular; when otherwise, clandestine.

6. By marriage, a society is created between the married pair, which draws after it a mutual communication of their civil interests, in as far as is necessary for maintaining it. As the society lasts only for the joint lives of the *socii*; therefore rights that have the nature of a perpetuity, which our law styles heritable, are not brought under the partnership or communion of goods; as a land-estate, or bonds bearing a yearly interest: It is only moveable subjects, or the fruits produced by heritable sub-

jects during the marriage, that become common to man and wife.

7. The husband, as the head of the wife, has the sole right of managing the goods in communion, which is called *jus mariti*. This right is so absolute, that it bears but little resemblance to a right of administering a common subject; for the husband can, in virtue thereof, sell, or even gift at pleasure, the whole goods falling under communion; and his creditors may affect them for the payment of his proper debts: So that the *jus mariti* carries all the characters of an assignation by the wife to the husband, of her moveable estate. It arises *ipso jure* from the marriage; and therefore needs no other constitution. But a stranger may convey an estate to a wife, so as it shall not be subject to the husband's administration; or the husband himself may, in the marriage-contract, renounce his *jus mariti* in all or any part of his wife's moveable estate.

8. From this right are excepted paraphernal goods, which, as the word is understood in our law, comprehends the wife's wearing apparel, and the ornaments proper to her person, as necklaces, ear-rings, breast or arm jewels, buckles, &c. These are neither alienable by the husband, nor affectable by his creditors. Things of promiscuous use to husband and wife, as plate, medals, &c. may become paraphernal, by the husband's giving them to the wife, at or before marriage; but they are paraphernal only in regard to that husband who gave them as such, and are esteemed common moveables, if the wife, whose *paraphernalia* they were, be afterwards married to a second husband; unless he shall in the same manner appropriate them to her.

9. The right of the husband to the wife's moveable estate, is burdened with the moveable debts contracted by her before marriage: And as his right is universal, so is his burden; for it reaches to her whole moveable debts, though they should far exceed her moveable estate. Yet the husband is not considered as the true debtor in his wife's debts. In all actions for payment, she is the proper defender: the husband is only cited for his interest, that is, as curator to her, and administrator of the society-goods. As soon therefore as the marriage is dissolved, and the society-goods thereby suffer a division, the husband is no farther concerned in the share belonging to his deceased wife; and consequently is no longer liable to pay her debts, which must be recovered from her representatives, or her separate estate.

10. This obligation upon the husband is perpetuated against him 1. Where his proper estate, real or personal, has been affected, during the marriage, by complete legal diligence; in which case, the husband must, by the common rules of law, relieve his property from the burden with which it stands charged: But the utmost diligence against his person, is not sufficient to perpetuate the obligation; nor even incomplete diligence against his estate. 2. The husband continues liable, even after the wife's death, in so far as he is *lucratus* or profited by her estate. As he was at no time the proper debtor in his wife's moveable debts; therefore, though he should be *lucratus*, he is, after the dissolution, only liable for them

them *subsidiari*, i. e. if her own separate estate is not sufficient to pay them off.

11. Where the wife is debtor in that sort of debt, which, if it had been due to her, would have excluded the *jus mariti*, e. g. in bonds bearing interest, the husband is liable only for the bygone interests, and those that may grow upon the debt during the marriage; because his obligations for her debts must be commensurated to the interest he has in her estate. It is the husband alone who is liable in personal diligence for his wife's debts, while the marriage subsists: The wife, who is the proper debtor, is free from all personal execution upon them while she is *vestita viro*.

12. The husband by marriage becomes the perpetual curator of the wife. From this right it arises, 1. That no suit can proceed against the wife, till the husband be cited for his interest. 2. All deeds, done by a wife without the husband's consent, are null; neither can she sue in any action without the husband's concurrence. Where the husband refuses, or by reason of forfeiture, &c. cannot concur; or where the action is to be brought against the husband himself, for performing his part of the marriage-articles; the judge will authorise her to sue in her own name. The effects arising from this curatorial power discover themselves even before marriage, upon the publication of banns; after which the bride, being no longer *sui juris*, can contract no debt, nor do any deed, either to the prejudice of her future husband, nor even to her own.

13. If the husband should either withdraw from his wife, or turn her out of doors; or if, continuing in family with her, he should by severe treatment endanger her life; the Commissaries will authorise a separation *a mensa et toro*, and give a separate alimony to the wife, suitable to her husband's estate, from the time of such separation, until either a reconciliation or a sentence of divorce.

14. Certain obligations of the wife are valid, notwithstanding her being *sub cura mariti*; *ex. gr.* obligations arising from delict; for wives have no privilege to commit crimes. But if the punishment resolves into a pecuniary mulct, the execution of it must, from her incapacity to fulfil, be suspended till the dissolution of the marriage, unless the wife has a separate estate exempted from the *jus mariti*.

15. Obligations arising from contract, affect either the person or the estate. The law has been so careful to protect wives, while *sub cura mariti*, that all personal obligations granted by a wife, though with the husband's consent, as bonds, bills, &c. are null; with the following exceptions: 1. Where the wife gets a separate *peculium* or stock, either from her father or a stranger, for her own or her children's alimony, she may grant personal obligations in relation to such stock; and by stronger reason, personal obligations granted by a wife are good, when her person is actually withdrawn from her husband's power, by a judicial separation. 2. A wife's personal obligation, granted in the form of a deed *inter vivos*, is valid, if it is not to take effect till her death. 3. Where the wife is by the husband *præposita negotiis*, entrusted with the management, either of a particular branch of business, or of his whole affairs, all the contracts she en-

ters into in the exercise of her *præpositura*, are effectual, even though they be not reduced to writing, but should arise merely *ex re*, from furnishings made to her: But such obligations have no force against the wife; it is the husband only, by whose commission she acts, who is thereby obliged.

16. A wife, while she remains in family with her husband, is considered as *præposita negotiis domesticis*; and consequently may provide things proper for the family, for the price whereof the husband is liable, though they should be misapplied, or though the husband should have given her money to provide them elsewhere. A husband, who suspects that his wife may hurt his fortune by high living, may use the remedy of inhibition against her; by which all persons are interpellated from contracting with her, or giving her credit. After the completing of this diligence, whereby the *præpositura* falls, the wife cannot bind the husband, unless for such reasonable furnishings as he cannot instruct that he provided her with *alimunde*. As every man, and consequently every husband, has a right to remove his managers at pleasure, inhibition may pass at the suit of the husband against the wife, though he should not offer to justify that measure by an actual proof of the extravagance or profuseness of her temper.

17. As to rights granted by the wife affecting her estate; she has no moveable estate, except her *paraphernalia*; and these she may alien or impignorate, with consent of the husband. She can, without the husband, bequeath by testament her share of the goods in communion; but she cannot dispose of them *inter vivos*. A wife can lawfully oblige herself, in relation to her heritable estate, with consent of her husband; for though her person is in some sense sunk by the marriage, she continues capable of holding a real estate; and in such obligations, her estate is considered, and not her person. A husband, though he be curator to his wife, can, by his acceptance or intervention, authorise rights granted by her in his own favour; for a husband's curatory is not intended only for the wife's advantage, but is considered as a mutual benefit to both.

18. All donations, whether by the wife to the husband, or by the husband to the wife, are revocable by the donor; but if the donor dies without revocation, the right becomes absolute. Where the donation is not pure, it is not subject to revocation: Thus, a grant made by the husband, in consequence of the natural obligation that lies upon him to provide for his wife, is not revocable, unless in so far as it exceeds the measure of a rational settlement; neither are remuneratory grants revocable, where mutual grants are made in consideration of each other, except where an onerous cause is simulated, or where what is given *hinc inde* bears no proportion to each other. All voluntary contracts of separation, by which the wife is provided in an yearly alimony, are effectual as to the time past, but revocable either by the husband or wife.

19. As wives are in the strongest degree subject to the influence of their husbands, third parties, in whose favours they had made grants, were frequently vexed with actions of reduction, as if the grant had been extorted from the wife, through the force or fear of the husband.

husband. To secure the grantees against this danger, ratifications were introduced, whereby the wife, appearing before a judge, declares upon oath, her husband not present, that she was not induced to grant the deed *ex vi put metu*. A wife's ratification is not absolutely necessary for securing the grantee: Law indeed allows the wife to bring reduction of any deed she has not ratified, upon the head of force or fear; of which, if she brings sufficient evidence, the deed will be set aside; but if she fails in the proof, it will remain effectual to the receiver.

20. Marriage, like other contracts, might, by the Roman law, be dissolved by the contrary consent of parties; but, by the law of Scotland, it cannot be dissolved till death, except by divorce, proceeding either upon the head of adultery, or of wilful desertion.

21. Marriage is dissolved by death, either within year and day from its being contracted, or after year and day. If it is dissolved within year and day, all rights granted in consideration of the marriage (unless guarded against in the contract) become void, and things return to the same condition in which they stood before the marriage; with this restriction, that the husband is considered as a *bona fide* possessor, in relation to what he has consumed upon the faith of his right; but he is liable to repay the tocher, without any deduction in consideration of his family expence during the marriage. If things cannot be restored on both sides, equity hinders the restoring of one party, and not the other.

22. Upon the dissolution of a marriage, after year and day, the surviving husband becomes the irrevocable proprietor of the tocher and the wife, where she survives, is intitled to her jointure, or to her legal provisions. She has also right to mournings, suitable to the husband's quality; and to alimony from the day of his death till the term at which her liferent provision, either legal or conventional, commences. If a living child be procreated of the marriage, the marriage has the same effect as if it had subsisted beyond the year. A day is adjoined to the year, *in majorem evidentiam*, that it may clearly appear that the year itself is elapsed; and therefore, the running of any part of the day, after the year, has the same effect as if the whole were elapsed. The legal right of courtesy competent to the surviving husband is explained below, Tit. xvi 28.

23. Divorce is such a separation of married persons, during their lives, as looses them from the nuptial tie, and leaves them at freedom to intermarry with others. But neither adultery, nor wilful desertion, are grounds which must necessarily dissolve marriage: they are only handles, which the injured party may take hold of, to be free. Cohabitation, therefore, by the injured party, after being in the knowledge of the acts of adultery, implies a passing from the injury; and no divorce can proceed, which is carried on by collusion betwixt the parties, lest, contrary to the first institution of marriage, they might disengage themselves by their own consent: and though after divorce, the guilty person, as well as the innocent, may contract second marriages; yet in the case of divorce upon adultery, marriage is by special statute prohibited betwixt the two adulterers.

24. Where either party has deserted from the other

for four years together, that other may sue for adherence. If this has no effect, the church is to proceed, first by admonition, then by excommunication; all which previous steps are declared to be a sufficient ground for pursuing a divorce. *De praxi*, the Commissaries pronounce sentence in the adherence, after one year's desertion; but four years must intervene between the first desertion and the decree of divorce.

25. The legal effects of divorce on the head of desertion are, that the offending husband shall restore the tocher, and forfeit to the wife all her provisions, legal and conventional; and on the other hand, the offending wife shall forfeit to the husband her tocher, and all the rights that would have belonged to her, in the case of her survivance. This was also esteemed the rule in divorces upon adultery. But by a decision of the court of Session 1762, founded on a tract of ancient decisions recovered from the records, the offending husband was allowed to retain the tocher.

#### Tit. 7. Of Minors, and their Tutors and Curators.

1. THE stages of life principally distinguished in law are, *pupillarity*, *puberty* or *minority*, and *majority*. A child is under pupillarity, from the birth till fourteen years of age, if a male, and till twelve, if a female. Minority begins where pupillarity ends, and continues till majority, which, by the law of Scotland, is the age of twenty-one years complete, both in males and females: But minority, in a large sense, includes all under age, whether pupils, or *puberes*. Because pupils cannot in any degree act for themselves, and minors seldom with discretion, pupils are put by law under the power of tutors, and minors may put themselves under the direction of curators. Tutory is a power and faculty to govern the person, and administer the estate of a pupil. Tutors are either nominate, of law, or elative.

2. A tutor nominate is he who is named by a father, in his testament or other writing, to a lawful child. Such tutor is not obliged to give caution for the faithful discharge of his office; because his fidelity is presumed to have been sufficiently known to the father.

3. If there be no nomination by the father, or if the tutors nominate do not accept, or if the nomination falls by death or otherwise, there is place for a tutor of law. This sort of tutory devolves upon the next agnate; by which we understand he who is nearest related by the father, though females intervene.

4. Where there are two or more agnates equally near to the pupil, he who is intitled to the pupil's legal succession fails to be preferred to the others. But as the law suspects, that he may not be over careful to preserve a life which stands in the way of his own interest, this sort of tutor is excluded from the custody of the pupil's person, which is commonly committed to the mother, while a widow, until the pupil be seven years old; and, in default of the mother, to the next cognate, *i. e.* the nearest relation by the mother. The tutor of law must be at least twenty-five years of age. He is served or declared by a jury of sworn men, who are called upon a brief issuing



ing from the Chancery, which is directed to any judge having jurisdiction. He must give security before he enters upon the management.

5. If no tutor of law demands the office, any person, even a stranger, may apply for a tutory-dative. But because a tutor in law ought to be allowed a competent time to deliberate whether he will serve or not, no tutory-dative can be given till the elapsing of a year from the time at which the tutor of law had first a right to serve. It is the king alone, as the father of his country, who gives tutory-dative, by his court of exchequer; and no gift of tutory can pass in exchequer, without the citation or consent of the next of kin to the pupil, both by the father and mother, nor till the tutor give security, recorded in the books of exchequer. There is no room for a tutor of law, or tutor-dative, while a tutor nominate can be hoped for: and tutors of law, or dative, even after they have begun to act, may be excluded by the tutor nominate, as soon as he offers to accept, unless he has expressly renounced the office. If a pupil be without tutors of any kind, the court of Session will, at the suit of any kinsman, name a factor (steward) for the management of the pupil's estate.

6. After the years of pupillarity are over, the minor is considered as capable of acting by himself, if he has confidence enough of his own capacity and prudence. The only two cases in which curators are imposed upon minors are, first, where they are named by the father, in a state of health. 2. Where the father is himself alive; for a father is *ipso jure*, without any service, administrator, that is, both tutor and curator of law to his children, in relation to whatever estate may fall to them during their minority. This right in the father does not extend to grand-children, nor to such even of his immediate children as are forisfamiliated. Neither has it place in subjects which are left by a stranger to the minor, exclusive of the father's administration. If the minor chuses to be under the direction of curators, he must raise and execute a summons, citing at least two of his next of kin, to appear before his own judge-ordinary, upon nine days warning. At the day and place of appearance, he offers to the judge a list of those whom he intends for his curators: such of them as resolve to undertake the office, must sign their acceptance, and give caution; upon which an act of curatory is extracted.

7. These curators are styled *ad negotia*, to distinguish them from another sort called curators *ad lites*, who are authorized by the judge to concur with a pupil or minor in actions of law, either where he is without tutors and curators, or where his tutors or curators are parties to the suit. This sort is not obliged to give caution, because they have no intermeddling with the minor's estate: they are appointed for a special purpose; and when that is over, their office is at an end. Women are capable of being tutors and curators, under the following restrictions; 1. The office of a female tutor or curator falls by her marriage, even though the nomination should provide otherwise; 2. No woman can be tutor of law. Pupils are declared incapable of tutory or curatory. Where the minor has more tutors and curators than one, who are called in the nomination to the joint management,

they must all concur in every act of administration: where a certain number is named for a quorum, that number must concur: where any one is named *sine quo non*, no act is valid without that one's special concurrence. But if they are named without any of these limitations, the concurrence of the majority of the nominees then alive is sufficient.

8. In this, tutory differs from curatory, that as pupils are incapable of consent, they have no person capable of acting; which defect the tutor supplies: but a minor *pupus* can act for himself. Hence, the tutor subscribes alone all deeds of administration: but in curatory, it is the minor who subscribes as the proper party; the curator does no more than consent. Hence also, the persons of pupils are under the power, either of their tutors or of their nearest cognates; but the minor, after pupillarity, has the disposal of his own person, and may reside where he pleases. In most other particulars, the nature, the powers, and the duties of the two offices coincide. Both tutors and curators must, previous to their administration, make a judicial inventory, subscribed by them and the next of kin, before the minor's judge-ordinary, of his whole estate, personal and real; of which, one subscribed duplicate is to be kept by the tutors or curators themselves; another, by the next of kin on the father's side; and a third, by the next of kin on the mother's. If any estate belonging to the minor shall afterwards come to their knowledge, they must add it to the inventory within two months after their attaining possession thereof. Should they neglect this, the minor's debtors are not obliged to make payment to them; they may be removed from their offices as suspected, and they are intitled to no allowance for the sums disbursed by them in the minor's affairs, except the expence laid out upon the minor's entertainment, upon his lands and houses, and upon completing his titles.

9. Tutors and curators cannot grant leases of the minor's lands, to endure longer than their own office; nor under the former rental, without either a warrant from the court of Session, or some apparent necessity.

10. They have power to sell the minor's moveables; but cannot sell their pupil's land estate, without the authority of a judge. But the alienation of heritage by a minor, with consent of his curators, is valid.

11. Tutors and curators cannot, contrary to the nature of their trust, authorise the minor to do any deed for their own benefit; nor can they acquire any debt affecting the minor's estate: and, where a tutor or curator makes such acquisition, in his own name, for a less sum than the right is intitled to draw, the benefit thereof accrues to the minor.

12. By the Roman law, tutory and curatory, being *munera publica*, might be forced upon every one who had not a relevant ground of excuse; but, with us, the persons named to these offices may either accept or decline: and where a father, in *lege joustie*, names certain persons both as tutors and curators to his children, though they have acted as tutors, they may decline the office of curatory. Tutors and curators having once accepted, are liable *in diligence*, that is, are accountable for the consequences of their neglect in any part of their duty.

duty from the time of their acceptance. They are accountable *singuli in solidum*, i. e. every one of them is answerable, not only for his own diligence, but for that of his co-tutors; and any one may be sued without citing the rest: But he who is condemned in the whole, has action of relief against his co-tutors.

13. From this obligation to diligence, we may except, 1. Fathers or administrators in law, who, from the presumption that they act to the best of their power for their children, are liable only for actual intrusions. 2. Tutors and curators named by the father, with the special provisos, that they shall be liable barely for intrusions, not for omissions; and that each of them shall be liable only for himself, and not *in solidum* for the co-tutors: But this power of exemption from diligence, is limited to the estate descending from the father himself. Tutors or curators are not intitled to any salary or allowance for pains, unless a salary has been expressly contained in the testator's nomination; for their office is presumed gratuitous.

14. Though no person is obliged to accept the office of tutor or curator, yet having once accepted, he cannot throw it up or renounce it, without sufficient cause; but, if he should be guilty of misapplying the minor's money, or fail in any other part of his duty, he may be removed at the suit of the minor's next in kin, or by a co-tutor, or co-curatur: Where the misconduct proceeds merely from indolence, or inattention, the court, in place of removing the tutor, either join a curator with him, or, if he be a tutor-nominate, they oblige him to give caution for his past and future management.

15. The offices of tutory and curatory expire by the pupil's attaining the age of puberty, or the minor's attaining the age of twenty-one years complete; and by the death either of the minor, or of his tutor or curator.

16. Deeds either by pupils, or by minors having curators without their consent, are null; but they oblige the granters, in as far as relates to sums profitably applied to their use. A minor under curators can indeed make a testament by himself; but whatever is executed in the form of a deed *inter vivos*, requires the curator's consent. Deeds by a minor who has no curators, are as effectual as if he had curators, and signed them with their consent; he may even alien his heritage, without the interposition of a judge.

17. Minors may be restored against all deeds granted in their minority, that are hurtful to them. Deeds, in themselves void, need not the remedy of restitution; but where hurtful deeds are granted by a tutor in his pupil's affairs, or by a minor who has no curators, as these deeds subsist in law, restitution is necessary: And even where a minor, having curators, executes a deed hurtful to himself with their consent, he has not only action against the curators, but he has the benefit of restitution against the deed itself. The minor cannot be restored, if he does not raise and execute a summons for reducing the deed, *ex capite minorænitatis et læsionis*, before he be twenty-five years old. These four years, between the age of twenty-one and twenty five, called *quadriennium utile*, are indulged to the minor, that he may have a

reasonable time, from that period, when he is first presumed to have the perfect use of his reason, to consider with himself what deeds done in his minority have been truly prejudicial to him.

18. Questions of restitution are proper to the court of Session. Two things must be proved by the minor, in order to the reduction of the deed; 1. That he was minor when it was signed; 2. That he is hurt or lesed by the deed. This lesion must not proceed merely from accident; for the privilege of restitution was not intended to exempt minors from the common misfortunes of life; it must be owing to the imprudence or negligence of the minor, or his curator.

19. A minor cannot be restored against his own delict or fraud. 2. Restitution is excluded, if the minor, at any time after majority, has approved of the deed, either by a formal ratification, or tacitly by payment of interest, or by other acts inferring approbation. 3. A minor, who has taken himself to business, as a merchant shop-keeper, &c cannot be restored against any deed granted by him, in the course of that business, especially if he was *proximus majorænitatis* at signing the deed. 4. According to the more common opinion, a minor cannot be restored in a question against a minor, unless some gross unfairness shall be qualified in the bargain.

20. The privilege of restitution does not always die with the minor himself. 1. If a minor succeeds to a minor, the time allowed for restitution is governed by the minority of the heir, not of the ancestor. 2. If a minor succeeds to a major, who was not full twenty-five, the privilege continues with the heir during his minority; but he cannot avail himself of the *anni utiles*, except in so far as they were unexpired at the ancestor's death. 3. If a major succeeds to a minor, he has only the *quadriennium utile* after the minor's death; and if he succeeds to a major dying within the *quadriennium*, no more of it can be profitable to him than what remained when the ancestor died.

21. No minor can be compelled to state himself as a defender, in any action, whereby his heritable estate flowing from ascendants may be evicted from him, by one pretending a preferable right.

22. This privilege is intended merely to save minors from the necessity of disputing upon questions of preference; it does not therefore take place, 1. Where the action is pursued on the father's falsehood or delict. 2. Upon his obligation to convey heritage. 3. On his liquid bond for a sum of money, though such action should have the effect to carry off the minor's estate by adjudication. 4. Nor in actions pursued by the minor's superior, upon feudal casual ties. 5. This privilege cannot be pleaded in bar of an action which had been first brought against the father, and is only continued against the minor; nor where the father was not in the peaceable possession of the heritable subject at his death. Before the minor can plead it, he must be served heir to his father. The persons of pupils are protected from imprisonment on civil debts.

23. Curators are given, not only to minors, but in general to every one who, either through defect of judgment, or unsuitness of disposition, is incapable of

rightly managing his own affairs. Of the first sort, are idiots and furious persons. Idiots, or *fatui*, are entirely deprived of the faculty of reason. The distemper of the furious person does not consist in the defect of reason, but in an overheated imagination, which obstructs the application of reason to the purposes of life. Curators may be also granted to lunatics, and even to persons dumb and deaf, though they are of sound judgment, where it appears that they cannot exert it in the management of business. Every person, who is come of age, and is capable of acting rationally, has a natural right to conduct his own affairs. The only regular way, therefore, of appointing this sort of curators, is by a jury summoned upon a brief from the chancery; which is not, like the brief of common tutory, directed to any judge-ordinary, but to the judge of the special territory where the person alleged to be fatuous or furious resides; that if he is truly of sound judgment, he may have an opportunity to oppose it: And, for this reason, he ought to be made a party to the brief. The curatory of idiots and furious persons belongs to the nearest agnate; but a father is preferred to the curatory of his fatuous son, and the husband to that of his fatuous wife, before the agnate.

24. A clause is inserted in the brief, for inquiring how long the fatuous or furious person has been in that condition; and the verdict to be pronounced by the inquest, is declared a sufficient ground, without farther evidence, for reducing all deeds granted after the period at which it appeared by the proof that the fatuity or furiosity began. But, as fatuous and furious persons are, by their very state, incapable of being obliged, all deeds done by them may be declared void, upon proper evidence of their fatuity at the time of signing, though they should never have been cognosed idiots by an inquest.

25. We have some few instances of the Sovereign's giving curators to idiots, where the next agnate did not claim; but such gifts are truly deviations from our law, since they pass without an inquiry into the state of the person upon whom the curatory is imposed. Hence the curator of law to an idiot, serving *quandocunque*, is preferred as soon as he offers himself, before the curator-dative. This sort of curatory does not determine by the lucid intervals of the person *sub cura*; but it expires by his death, or perfect return to a sound judgment; which last ought regularly to be declared by the sentence of a judge.

26. Persons, let them be ever so profuse, or liable to be imposed upon, if they have the exercise of reason, can effectually oblige themselves, till they are fettered by law. Interdiction is a legal restraint laid upon such persons from signing any deed to their own prejudice, without the consent of their curators or interdictors.

27. There could be no interdiction, by our ancient practice, without a previous inquiry into the person's condition. But as there were few who could bear the shame that attends judicial interdiction, however necessary the restraint might have been, voluntary interdiction has received the countenance of law; which is generally executed in the form of a bond, whereby the granter obliges himself to do no deed that may affect his estate, without the consent of certain friends therein mentioned. Though

the reasons inductive of the bond should be but gently touched in the recital, the interdiction stands good. Voluntary interdiction, though it be imposed by the sole act of the person interdicted, cannot be recalled at his pleasure: But it may be taken off, 1. By a sentence of the court of Session, declaring, either that there was, from the beginning, no sufficient ground for the restraint; or that the party is, since the date of the bond, become *rei suæ providus*. 2. It falls, even without the authority of the Lords, by the joint act of the person interdicted, and his interdictors, concurring to take it off. 3. Where the bond of interdiction requires a certain number as a quorum, the restraint ceases, if the interdictors shall be by death reduced to a lesser number.

28. Judicial interdiction is imposed by a sentence of the court of Session. It commonly proceeds on an action brought by a near kinsmen to the party; and sometimes from the *nobile officium* of the court, when they perceive, during the pendency of a suit, that any of the litigants is, from the facility of his temper, subject to imposition. This sort must be taken off by the authority of the same court that imposed it.

29. An interdiction need not be served against the person interdicted; but it must be executed, or published by a messenger, at the market-cross of the jurisdiction where he resides, by publicly reading the interdiction there, after three o'yclock made for convocating the lieges. A copy of this execution must be affixed to the cross; and thereafter, the interdiction, with its execution, must be registered in the books, both of the jurisdiction where the person interdicted resides, and where his lands lie, or in the general register of the session, within forty days from the publication. An interdiction, before it is registered, has no effect against third parties, though they should be in the private knowledge of it; but it operates against the interdictors themselves, as soon as it is delivered to them.

30. An interdiction, duly registered, has this effect, that all deeds, done thereafter, by the person interdicted, without the consent of his interdictors, affecting his heritable estate, are subject to reduction. Registration, in the general register, secures all his lands from alienation, where-ever they lie; but where the interdiction is recorded in the register of a particular shire, it covers no lands, except those situated in that shire. But persons interdicted have full power to dispose of their moveables, not only by testament, but by present deeds of alienation: And creditors, in personal bonds granted after interdiction, may use all execution against their debtor's person and moveable estate; such bonds being only subject to reduction, in so far as diligence against the heritable estate may proceed upon them.

31. All onerous or rational deeds granted by the person interdicted, are as effectual, even without the consent of the interdictor, as if the granter had been laid under no restraint; but he cannot alter the succession of his heritable estate, by any settlement, let it be ever so rational. No deed, granted with consent of the interdictors, is reducible, though the strongest lesion or prejudice to the granter should appear: The only remedy competent, in such case, is an action by the granter against his interdic-

tors.

tors, for making up to him what he has lost through their undue consent. It is no part of the duty of interdictors, to receive sums, or manage any estate; they are given merely *ad auctoritatem præstandam*, to interpose their authority to reasonable deeds; and so are accountable for nothing but their fraud or fault, in consenting to deeds hurtful to the person under their care.

32. The law concerning the state of children falls next to be explained. Children are either born in wedlock, or out of it. All children, born in lawful marriage or wedlock, are presumed to be begotten by the person to whom the mother is married; and consequently to be lawful children. This presumption is so strongly founded, that it cannot be defeated but by direct evidence that the mother's husband could not be the father of the child. *e. g.* where he is impotent, or was absent from the wife till within six lunar months of the birth. The canonists indeed maintain, that the concurring testimony of the husband and wife that the child was not procreated by the husband, is sufficient to elide this legal presumption for legitimacy: but it is an agreed point, that no regard is to be paid to such testimony, if it be made after they have owned the child to be theirs. A father has the absolute right of disposing of his children's person, of directing their education, and of moderate chastisement; and even after they become *puberes*, he may compel them to live in family with him, and to contribute their labour and industry, while they continue there, towards his service. A child who gets a separate stock from the father for carrying on any trade or employment, even though he should continue in the father's house, may be said to be emancipated or forisfamiliated, in so far as concerns that stock; for the profits arising from it are his own. Forisfamiliation, when taken in this sense, is also inferred by the child's marriage, or by his living in a separate house, with his father's permission or goodwill. Children, after their full age of twenty-one years, become, according to the general opinion, their own masters; and from that period are bound to the father only by the natural ties of duty, affection, and gratitude. The mutual obligations between parents and children to maintain each other, are explained afterwards, Tit. 20.

33. Children, born out of wedlock, are styled natural children, or bastards. Bastards may be legitimated or made lawful, either, 1. By the subsequent intermarriage of the mother of the child with the father. And this sort of legitimation, intitles the child to all the rights of lawful children. The subsequent marriage, which produces legitimation, is considered by the law to have been entered into when the child legitimated was begotten; and hence, if he be a male he excludes, by his right of primogeniture, the sons procreated after the marriage, from the succession of the father's heritage, though these sons were lawful children from the birth. Hence also, those children only can be thus legitimated, who are begotten of a woman whom the father might at that period have lawfully married. 2. Bastards are legitimated by letters of legitimation from the sovereign. See Tit. 29.

34. As to the power of masters over their servants: All servants now enjoy the same rights and privileges with other subjects, unless in so far as they are tied down by

their engagements of service. Servants are either necessary or voluntary. Necessary are those whom law obliges to work without wages, of whom immediately. Voluntary servants engage without compulsion, either for mere subsistence, or also for wages. Those who earn their bread in this way, if they should stand off from engaging, may be compelled to it by the Justices of the peace, who have power to fix the rate of their wages.

35. Colliers, coal-bearers, and salters, and other persons necessary to collieries and saltworks, as they are particularly described by act 1661, are tied down to perpetual service at the works to which they have once entered. Upon a sale of the works, the right of their service is transferred to the new proprietor. All persons are prohibited to receive them into their service, without a testimonial from their last master; and if they desert to another work, and are redemanded within a year thereafter, he who has received them is obliged to return them within twenty-four hours, under a penalty. But though the proprietor should neglect to require the deserter within the year, he does not, by that short prescription, lose his property in him. Colliers, &c. where the colliery to which they are allotted, is either given up, or not sufficient for their maintenance, may lawfully engage with others; but if that work shall be again set a going, the proprietor may reclaim them back to it.

36. The poor make the lowest class or order of persons. Indigent children may be compelled to serve any of the king's subjects without wages, till their age of thirty years. Vagrants and sturdy beggars may be also compelled to serve any manufacturer. And because few persons were willing to receive them into their service, public work-houses are ordained to be built for setting them to work. The poor who cannot work, must be maintained by the parishes in which they were born; and where the place of their nativity is not known, that burden falls upon the parishes where they have had their most common resort, for the three years immediately preceding their being apprehended, or their applying for the public charity. Where the contributions collected at the churches to which they belong, are not sufficient for their maintenance, they are to receive badges from the minister and kirk session, in virtue of which they may ask alms at the dwelling houses of the inhabitants of the parish.

#### Tit. 8. *Of the Division of Rights, and the several ways by which a Right may be acquired.*

THE things or subjects to which persons have right, are the second object of law. The right of enjoying and disposing of a subject at one's pleasure, is called property. Proprietors are restrained by law from using their property enviously to their neighbour's prejudice. Every state or sovereign has a power over private property, called, by some lawyers, *dominium eminent*, in virtue of which, the proprietor may be compelled to sell his property for an adequate price, where an evident utility on the part of the public demands it.

2. Certain things are by nature itself incapable of appropriation, as the air, the light, the ocean, &c.; none of

of which can be brought under the power of any one person, though their use be common to all: Others are by law exempted from private commerce, in respect of the uses to which they are destined. Of this last kind are, 1. *Res publicæ*, as navigable rivers, highways, bridges, &c.: the right of these is vested in the King, chiefly for the benefit of his people, and they are called *regalia*. 2. *Res universitatis*, things which belong in property to a particular corporation or society, and whose use is common to every individual in it; but both property and use are subject to the regulations of the society; as town-houses, corporation-halls, market-places, church yards, &c. The lands or other revenue belonging to a corporation do not fall under this class, but are *juris privati*.

3. Property may be acquired, either by occupation or accession; and transferred by tradition or prescription: But prescription, being also a way of losing property, falls to be explained under a separate title. OCCUPATION, or occupancy, is the appropriating of things which have no owner, by apprehending them, or seizing their possession. This was the original method of acquiring property, and continued, under certain restrictions, the doctrine of the Roman law, *Quod nullius est, sit occupantis*; but it can have no room in the feudal plan, by which the King is looked on as the original proprietor of all the lands within his dominions.

4. Even in that sort of moveable goods which are presumed to have once had an owner, this rule obtains by the law of Scotland, *Quod nullius est, sit domini regis*. Thus, the right of treasures hid under ground, is not acquired by occupation, but accrues to the King. Thus also, where one finds strayed cattle or other moveables, which have been lost by the former owner, the finder acquires no right in them, but must give public notice thereof; and if within year and day after such notice, the proprietor does not claim his goods, they fall to the King, Sheriff, or other person, to whom the King has made a grant of such escheats.

5. In that sort of moveables which never had an owner, as wild beasts, fowls, fishes, or pearls found on the shore, the original law takes place, that he who first apprehends, becomes proprietor; in so much, that though the right of hunting, fowling, and fishing, be restrained by statute, under certain penalties, yet all game, even what is caught in contravention of the law, becomes the property of the catcher, unless where the confiscation thereof is made part of the penalty: But whales thrown in or killed on our coasts, belong neither to those who kill them, nor to the proprietor of the grounds on which they are cast, but to the King, providing they are so large as that they cannot be drawn by a wane with six oxen.

6. ACCESSION is that way of acquiring property, by which, in two things which have a connection with, or dependence on one another, the property of the principal thing draws after it the property of its accessory. Thus the owner of a cow becomes the owner of the calf; a house belongs to the owner of the ground on which it stands, though built with materials belonging to, and at the charge of another. The Romans excepted from this rule the case of paintings drawn on another man's board

or canvas, in consideration of the excellency of the art; which exception our practice has for a like reason extended to similar cases.

7. Under accession is comprehended SPECIFICATION; by which is meant, a person's making a new species or subject, from materials belonging to another. Where the new species can be again reduced to the matter of which it was made, law considers the former mass as still existing; and therefore, the new species, as an accessory to the former subject, belongs to the proprietor of that subject: But where the thing made cannot be so reduced, as in the case of wine, which cannot be again turned into grapes, there is no place for the *fructus juris*; and therefore the workmanship draws after it the property of the materials.

8. Though the new species should be produced from the COMMIXTION or confusion of different substances belonging to different proprietors, the same rule holds; but where the mixture is made by the common consent of the owners, such consent makes the whole a common property, according to the shares that each proprietor had formerly in the several subjects. Where things of the same sort are mixed without the consent of the proprietors, which cannot again be separated. *e. g.* two hogsheds of wine, the whole likewise becomes a common property; but in the after-division, regard ought to be had to the different quality of the wines: If the things so mixed admit of a separation, *e. g.* two flocks of sheep, the property continues distinct.

9. Property is carried from one to another by TRADITION; which is the delivery of possession by the proprietor, with an intention to transfer the property to the receiver. Two things are therefore requisite, in order to the transmitting of property in this way: 1. The intention or consent of the former owner to transfer it on some proper title of alienation, as sale, exchange, gift, &c. 2. The actual delivery in pursuance of that intention. The first is called the *causa*, the other the *modus transferendi domini*: Which last is so necessary to the acquiring of property, that he who gets the last right, with the first tradition, is preferred, according to the rule, *Traditionibus, non nudis pactis, transferuntur rerum dominia*.

10. Tradition is either real, where the *ipsa corpora* of moveables are put into the hands of the receiver; or symbolical, which is used where the thing is incapable of real delivery, or even when actual delivery is only inconvenient. Where the possession or custody of the subject has been before with him to whom the property is to be transferred, there is no room for tradition.

11. Possession, which is essential both to the acquisition and enjoyment of property, is defined, the detention of a thing, with a design or *animus* in the detainer of holding it as his own. It cannot be acquired by the sole act of the mind, without real detention; but, being once acquired, it may be continued *solo animo*. Possession is either natural, or civil. Natural possession is, when one possesses by himself: Thus, we possess lands by cultivating them and reaping their fruits, houses by inhabiting them, moveables by detaining them in our hands. Civil possession is our holding the thing, either by the sole act

of the mind, or by the hands of another who holds it in our name: Thus, the owner of a thing lent possesses it by the borrower; the proprietor of lands, by his tacksmen, trustee, or steward, &c. The same subject cannot be possessed entirely, or *in solidum*, by two different persons at one and the same time; and therefore possession by an act of the mind ceases, as soon as the natural possession is so taken up by another, that the former possessor is not suffered to re-enter. Yet two persons may, in the judgment of law, possess the same subject, at the same time, on different rights: thus, in the case of a pledge, the creditor possesses it in his own name, in virtue of the right of impignoration; while the proprietor is considered as possessing, in and through the creditor, in so far as it is necessary for supporting his right of property. The same doctrine holds in liferenters, tacksmen, and, generally, in every case where there are rights affecting a subject, distinct from the property.

12. A *bona fide* possessor is he, who, though he is not really proprietor of the subject, yet believes himself proprietor on probable grounds. A *mala fide* possessor knows, or is presumed to know, that what he possesses is the property of another. A possessor *bona fide* acquired right, by the Roman law, to the fruits of the subject possessed, that had been reaped and consumed by himself, while he believed the subject his own. By our customs, perception alone, without consumption, secures the possessor: Nay, if he has sown the ground, while his *bona fides* continued, he is intitled to reap the crop, *propter curam et culturam*. But this doctrine does not reach to civil fruits, e. g. the interest of money, which the *bona fide* receiver must restore, together with the principal, to the owner.

13. *Bona fides* necessarily ceaseth by the *conscientia rei aliena* in the possessor, whether such consciousness should proceed from legal interpellation, or private knowledge. *Mala fides* is sometimes induced, by the true owner's bringing his action against the possessor, sometimes not till liticontestation, and, in cases uncommonly favourable, not till sentence be pronounced against the possessor.

14. The property of moveable subjects is presumed by the bare effect of possession, until the contrary be proved; but possession of an immoveable subject, though for a century of years together, if there is no seisin, does not create even a presumptive right to it: *Nulla sansa, nulla terra*. Such subject is considered as caducuary, and so accrues to the sovereign. Where the property of a subject is contested, the lawful possessor is intitled to continue his possession, till the point of right be discussed; and, if he has lost it by force or stealth, the judge will, upon summary application, immediately restore it to him.

15. Where a possessor has several rights in his person, affecting the subject possessed, the general rule is, that he may ascribe his possession to which of them he pleases; but one cannot ascribe his possession to a title other than that on which it commenced, in prejudice of him from whom his title flowed.

#### Tit. 9. Of heritable and moveable Rights.

FOR the better understanding the doctrine of this title,  
VOL. II. No. 64. 2 †

it must be known, that by the law of Scotland, and indeed of most nations of Europe, since the introduction of feus, where ever there are two or more in the same degree of consanguinity to one who dies intestate, and who are not all females, such rights belonging to the deceased as are either properly feudal, or have any resemblance to feudal rights, descend wholly to one of them, who is considered as his proper heir; the others, who have the name of next of kin or executors, must be contented with that portion of the estate which is of a more perishable nature. Hence has arisen the division of rights to be explained under this title: the subjects descending to the heir, are styled heritable; and those that fall to the next of kin, moveable.

2. All rights of, or affecting lands, under which are comprehended houses, mills, fishings, teinds; and all rights of subjects that are *fundo anexa*, whether completed by seisin or not, are heritable *ex sua natura*. On the other hand, every thing that moves itself, or can be moved, and in general whatever is not united to land, is moveable: as household-furniture, corns, cattle, cash, arrears of rent and of interest, even though they should be due on a right of annualrent: For though the arrears last mentioned are secured on land, yet being presently payable, they are considered as cash.

3. Debts, (*nomina debitorum*), when due by bill, promissory note, or account, are moveable. When constituted by bond, they do not all fall under any one head; but are divided into heritable and moveable, by the following rules. All debts constituted by bond bearing an obligation to interest the creditor in any heritable subject in security of the principal sum and annualrent, or annualrent only, are heritable; for they not only carry a yearly profit, but are secured upon land.

4. Bonds merely personal, though bearing a clause of interest, are moveable as to succession; i. e. they go not to the heir, but to the next of kin or executors: but they are heritable with respect to the fisk, and to the rights of husband and wife; that is, though, by the general rule, moveable rights fall under the communion of goods consequent upon marriage, and the moveables of denounced persons fall to the crown or fisk, by single escheat, yet such bonds do neither, but are heritable in both respects.

5. Bonds taken payable to heirs and assignees, secluding executors, are heritable in all respects, from the destination of the creditor. But a bond, which is made payable to heirs, without mention of executors, descends, not to the proper heir in heritage, though heirs are mentioned in the bond, but to the executor; for the word *heir*, which is a generic term, points out him who is to succeed by law in the right; and the executor, being the heir *in mobilibus*, is considered as the person to whom such bond is taken payable. But where a bond is taken to heirs-male, or to a series of heirs, one after another, such bond is heritable, because its destination necessarily excludes executors.

6. Subjects originally moveable become heritable:  
1. By the proprietor's destination. Thus, a jewel, or any other moveable subject, may be provided to the heir, from the right competent to every proprietor to settle his property on whom he pleases. 2. Moveable rights

rights may become heritable, by the supervening of an heritable security: Thus, a sum due by a personal bond becomes heritable, by the creditor's accepting an heritable right for securing it, or by adjudging upon it,

7. Heritable rights do not become moveable by accessory moveable securities, the heritable right being in such case the *jus nobilius*, which draws the other after it.

8. Certain subjects partake, in different respects, of the nature both of heritable and moveable. Personal bonds are moveable in respect of succession, but heritable as to the fisk, and husband and wife. All bonds, whether merely personal, or even heritable, on which no seisin has followed, may be affected at the suit of creditors, either by adjudication, which is a diligence proper to heritage; or by arrestment, which is peculiar to moveables. Bonds including executors, though they descend to the creditor's heir, are payable by the debtor's executors, without relief against the heir; since the debtor's succession cannot be affected by the destination of the creditor.

9. All questions, whether a right be heritable or moveable, must be determined according to the condition of the subject at the time of the ancestor's death. If it was heritable at that period, it must belong to the heir; if moveable, it must fall to the executor, without regard to any alterations that may have affected the subject in the intermediate period between the ancestor's death and the competition.

#### Tit. 10. *Of the Constitution of heritable Rights by Charter and Seisin.*

HERITABLE rights are governed by the feudal law, which owed its origin, or at least its first improvements, to the Longobards; whose kings, upon having penetrated into Italy, the better to preserve their conquests, made grants to their principal commanders of great part of the conquered provinces, to be again subdivided by them among the lower officers, under the conditions of fidelity and military service.

2. The feudal constitutions and usages were first reduced into writing, about the year 1150, by two lawyers of Milan, under the title of *Consuetudines Feudorum*. None of the German Emperors appear to have expressly confirmed this collection by their authority; but it is generally agreed, that it had their tacit approbation, and was considered as the customary feudal law of all the countries subject to the empire. No other country has ever acknowledged these books for their law; but each state has formed to itself such a system of feudal rules, as best agreed with the genius of its own constitution. In feudal questions, therefore, we are governed, in the first place, by our own statutes and customs; where these fail us, we have regard to the practice of neighbouring countries, if the genius of their law appears to be the same with ours; and should the question still remain doubtful, we may have recourse to those written books of the feus, as to the original plan on which all feudal systems have proceeded.

3. This military grant got the name, first of *beneficium*, and afterwards of *feudum*; and was defined a gratuitous right to the property of lands, made under the conditions

of fealty and military service, to be performed to the granter by the receiver; the radical right of the lands still remaining in the granter. Under lands, in this definition, are comprehended all rights or subjects so connected with land, that they are deemed a part thereof; as houses, mills, fishings, jurisdictions, patronages, &c. Though feus in their original nature were gratuitous, they soon became the subject of commerce; services of a civil or religious kind were frequently substituted in place of military; and now, of a long time, services of every kind have been entirely dispensed with, in certain feudal tenures. He who makes the grant is called the superior, and he who receives it the vassal. The subject of the grant is commonly called the feu; though that word is at other times, in our law, used to signify one particular tenure. See Tit. 11. The interest retained by the superior in the feu is styled *dominium directum*, or the superiority; and the interest acquired by the vassal, *dominium utile*, or the property. The word *fee* is promiscuously applied to both.

4. Allodial goods are opposed to feus; by which are understood, goods enjoyed by the owner, independent of a superior. All moveable goods are allodial; lands only are so, when they are given without the condition of fealty or homage. By the feudal system, the sovereign, who is the fountain of feudal rights, reserves to himself the superiority of all the lands of which he makes the grant; so that, with us, no lands are allodial, except those of the King's own property, the superiorities which the King reserves in the property-lands of his subjects, and manes and glebes, the right of which is completed by the presbytery's designation, without any feudal grant.

5. Every person who is in the right of an immoveable subject, provided he has the free administration of his estate, and is not debarred by statute, or by the nature of his right, may dispose of it to another. Nay, a vassal, though he has only the *dominium utile*, can subfeu his property to a subvassal by a subaltern right, and thereby raise a new *dominium directum* in himself, subordinate to that which is in his superior; and so *in infinitum*. The vassal who thus subfeus, is called the subvassal's immediate superior, and the vassal's superior is the subvassal's mediate superior.

6. All persons who are not disabled by law, may acquire and enjoy feudal rights. Papists cannot purchase a land estate by any voluntary deed. Aliens, who owe allegiance to a foreign prince, cannot hold a feudal right without naturalization; and therefore, where such privilege was intended to be given to favoured nations or persons, statutes of naturalization were necessary, either general, or special; or at least, letters of naturalization by the sovereign.

7. Every heritable subject, capable of commerce, may be granted in feu. From this general rule is excepted, 1. The annexed property of the Crown, which is not alienable without a previous dissolution in parliament. 2. Tailzied lands, which are devised under condition that they shall not be aliened. 3. An estate *in hereditate jacente* cannot be effectually aliened by the heir-apparent (*i. e.* not entered); but such alienation becomes

becomes effectual upon his entry, the supervening right accruing in that case to the purchaser; which is a rule applicable to the alienation of all subjects not belonging to the venter at the time of the sale.

8. The feudal right, or, as it is called, investiture, is constituted by charter and feisin. By the charter, we understand that writing which contains the grant of the feudal subject to the vassal, whether it be executed in the proper form of a charter, or of a disposition. Charters by subject-superiors are granted, either, 1. *A me de superiore meo*: when they are to be holden, not of the grantor himself, but of his superior. This sort is called a public holding, because vassals were in ancient times publicly received in the superior's court before the *pares curie* or co-vassals. Or, 2. *De me*, where the lands are to be holden of the grantor. These were called sometimes base rights, from *bas*, lower: and sometimes private, because, before the establishment of our records, they were easily concealed from third parties; the nature of all which will be more fully explained, Tit. 14. An original charter is that by which the fee is first granted: A charter by progress is a renewed disposition of that fee to the heir or assignee of the vassal. All doubtful clauses in charters by progress ought to be construed agreeably to the original grant; and all clauses in the original charter are understood to be implied in the charters by progress, if there be no express alteration.

9. The first clause in an original charter, which follows immediately after the name and designation of the grantor, is the narrative or recital, which expresses the causes inductive of the grant. If the grant be made for a valuable consideration, it is said to be onerous; if for love and favour, gratuitous. In the dispositive clause of a charter, the subjects made over are described either by special boundaries or march-stones, (which is called a bounding charter), or by such other characters as may sufficiently distinguish them. A charter regularly carries right to no subjects but what are contained in this clause, though they should be mentioned in some other clause of the charter.

10. The clause of *tenendas* (from its first words, *tenendas prædictas terras*) expresses the particular tenure by which the lands are to be holden. The clause of *reddendo* (from the words, *reddendo in die annustim*) specifies the particular duty or service which the vassal is to pay or perform to the superior.

11. The clause of warrandice is that by which the grantor obliges himself that the right conveyed shall be effectual to the receiver. Warrandice is either personal or real. Personal warrandice, where the grantor is only bound personally, is either, 1. Simple, that he shall grant no deed in prejudice of the right; and this sort, which is confined to future deeds, is implied even in donations. 2. Warrandice from fact and deed, by which the grantor warrants that the right neither has been, nor shall be hurt by any fact of his. Or, 3. Absolute warrandice *contra omnes mortales*, whereby the right is warranted against all legal defects in it, which may carry it off from the receiver, either wholly or in part. Where a sale of lands proceeds upon an onerous cause, the grantor is liable in absolute warrandice, though no warran-

dice be expressed; but in assignments to debts or decrees, no higher warrandice than from fact and deed is implied.

12. Gratuitous grants by the Crown imply no warrandice; and though warrandice should be expressed, the clause is ineffectual, from a presumption, that it has crept in by the negligence of the Crown's officers. But where the Crown makes a grant, not *jure coronæ*, but for an adequate price, the sovereign is in the same case with his subjects.

13. Absolute warrandice, in case of eviction, affords an action to the grantee, against the grantor, for making up to him all that he shall have suffered through the defect of the right; and not simply for his indemnification, by the grantor's repayment of the price to him. But as warrandice is penal, and consequently *stricti juris*, it is not easily presumed, nor is it incurred from every light servitude that may affect the subject, far less does it extend to burdens which may affect the subject posterior to the grant, nor to those imposed by public statute, whether before or after, unless specially warranted against.

14. Real warrandice is either, 1. Express, whereby, in security of the lands principally conveyed, other lands, called warrandice-lands, are also made over, to which the receiver may have recourse in case the principal lands be evicted. Or, 2. Tacit, which is constituted by the exchange or excambion of one piece of ground with another; for, if the lands exchanged are carried off from either of the parties, the law itself, without any paction, gives that party immediate recourse upon his own first lands, given in exchange for the lands evicted.

15. The chapter concludes with a precept of feisin, which is the command of the superior grantor of the right to his bailie, for giving feisin or possession to the vassal, or his attorney, by delivering to him the proper symbols. Any person, whose name may be inserted in the blank, left in the precept for that purpose, can execute the precept as bailie; and whoever has the precept of feisin in his hands, is presumed to have a power of attorney from the vassal for receiving possession in his name.

16. A feisin is the instrument or attestation of a notary, that possession was actually given by the superior or his bailie, to the vassal or his attorney; which is considered as necessary solemnity, as not to be suppliable, either by a proof of natural possession, or even of the special fact that the vassal was duly entered to the possession by the superior's bailie.

17. The symbols, by which the delivery of possession is expressed, are, for lands, earth and stone; for rights of annualrent payable forth of land, it is also earth and stone, with the addition of a penny money; for parsonage teinds, a sheaf of corn; for jurisdictions, the book of the court; for patronages, a psalm book, and the keys of the church; for fishings, net and coble; for mills, clap and happer, &c. The feisin must be taken upon the ground of the lands, except where there is a special dispensation in the charter from the Crown.

18. All feisins must be registered within sixty days after their date, either in the general register of feisins at Edinburgh, or in the register of the particular shire appointed by the act 1617; which, it must be observed, is not, in every case, the shire within which the lands lie. Bur-

gidge:



gage feifins are ordained to be registered in the books of the borough.

19. Unregistered feifins are ineffectual againft third parties, but they are valid againft the granters and their heirs. Seifins regularly recorded, are preferable, not according to their own dates, but the dates of their registration.

20. Seifin neceffarily fupposes a fuperior by whom it is given; the right therefore which the fovereign, who acknowledges no fuperior, has over the whole lands of Scotland, is conftituted, *jure coronæ*, without feifin. In feveral parcels of land, that lie contiguous to one another, one feifin ferves for all, unlefs the right of the feveral parcels be either holden of different fuperiors, or derived from different authors, or enjoyed by different tenures under the fame fuperior. In difcontiguous lands, a feparate feifin muft be taken on every parcel, unlefs the fovereign has united them into one tenandry, by a charter of union; in which cafe, if there is no fpecial place expreffed, a feifin taken on any part of the united lands will ferve for the whole, even though they be fituated in different fhires. The only effect of union is, to give the difcontiguous lands the fame quality as if they had been contiguous, or naturally united; union, therefore, does not take off the neceffity of feparate feifins, in lands holden by different tenures, or the rights of which flow from different fuperiors, thefe being incapable of natural union.

21. The privilege of barony carries a higher right than union does, and confequently includes union in it as the leffer degree. This right of barony can neither be given, nor transmitted, unlefs by the Crown; but the quality of fimple union, being once conferred on lands by the fovereign, may be communicated by the vaffal to a fubvaffal. Though part of the lands united or erected into a barony, be fold by the vaffal to be holden *a me*, the whole union is not thereby diffolved: what remains unfold retains the quality.

22. A charter, not perfected by feifin, is a right merely perfonal, which does not transfer the property. (fee Tit. xx. 1.) and a feifin of itfelf bears no faith, without its warrant: It is the charter and feifin joined together that conftitutes the feudal right, and fecures the receiver againft the effect of all pofterior feifins, even though the charters on which they proceed fhould be prior to his.

23. No quality which is designed as a lien or real burden on a feudal right, can be effectual againft fingular fucceffors, if it be not inferted in the inveftiture. If the creditors in the burden are not particularly mentioned, the burden is not real; for no perpetual unknown incumbrance can be created upon lands. Where the right itfelf is granted with the burden of the fum therein mentioned, or where it is declared void, if the fum be not paid againft a day certain, the burden is real; but where the receiver is fimplly obliged by his acceptance to make payment, the clause is effectual only againft him and his heirs.

#### Tit. II. Of the feveral kinds of Holding.

FEUDAL fubjects are chiefly diftinguifhed by their dif-

ferent manners of holding, which were either ward, blanch, feu, or burgage. Ward-holding, which is now abolifhed by 20. Geo. II. c. 50. was that which was granted for military fervice. Its proper *reddendo* was, *services*, or *services ufed and wout*; by which laft was meant the performance of fervice whenever the fuperior's occafions required it. As all feudal rights were originally held by this tenure, ward-holding was *in dubio*. Hence, though the *reddendo* had contained fome fpecial fervice, or yearly duty, the holding was prefumed ward, if another holding was not particularly expreffed.

2. Feu holding is that whereby the vaffal is obliged to pay to the fuperior a yearly rent in money or grain, and fometimes alfo in *services* proper to a farm as ploughing, reaping, carriages for the fuperior's ufe, &c. *nomine feudi firma*. This kind of tenure was introduced for the encouragement of agriculture the improvement of which was confiderably obftruded by the vaffal's obligation to military fervice. It appears to have been a tenure known in Scotland as far back as *leges burgorum*.

3. Blanch-holding is that whereby the vaffal is to pay to the fuperior an elufory yearly duty, as a penny money, a rofe, a pair of gilt furs, &c. merely in acknowledgment of the fuperiority, *nomine albæ firmæ*. This duty, where it is a thing of yearly growth, if it be not demanded within the year, cannot be exacted thereafter; and where the words, *fi petatur tantum*, are fubjoined to the *reddendo*, they imply a releafe to the vaffal, whatever the quality of the duty may be, if it is not afked within the year.

4. Burgage holding is that, by which boroughs-royal hold of the fovereign the lands which are contained in their charters of erection. This, in the opinion of *Craig*, does not conftitute a feparate tenure, but is a fpecies of ward-holding; with this fpeciality, that the vaffal is not a private perfon, but a community: And indeed, watching and warding, which is the ufual fervice contained in the *reddendo* of fuch charters, might be properly enough faid, fome centuries ago, to have been of the military kind. As the royal borough is the King's vaffal, all burgage-holders hold immediately of the Crown: The magiftrates therefore, when they receive the refignations of the particular burgeffes, and give feifin to them, act, not as fuperiors, but as the King's bailies fpecially authorized thereto.

5. Feudal fubjects, granted to churches, monafteries, or other focieties for religious or charitable ufes, are faid to be mortified, or granted *ad manum mortuam*; either becaufe all casualties muft neceffarily be loft to the fuperior, where the vaffal is a corporation, which never dies: or becaufe the property of thefe fubjects is granted to a dead hand, which cannot transfer it to another. In lands mortified in times of Poperly to the church, whether granted to prelates for the behoof of the church, or *in puram elemofynam*; the only *services* preftable by the vaffal were prayers, and finging of mafles for the fouls of the deceased, which approaches nearer to blanch-holding than ward. The purpofes of fuch grants having been, upon the reformation, declared fuperftitious, the lands mortified were annexed to the Crown: But mortifications

to universities, hospitals, &c. were not affected by that annexation; and lands may, at this day, be mortgaged to any lawful purpose, either by blanch or by feu holding.

**Tit. 12. Of the Casualties due to the Superior.**

THE right of the superior continues unimpaired, notwithstanding the feudal grant, unless in so far as the *dominium utile*, or property, is conveyed to his vassal. The superiority carries a right to the services and annual duties contained in the *reddendo* of the vassal's charter. The duty payable by the vassal is a *debitum fundi*; *i. e.* it is recoverable, not only by a personal action against himself, but by a real action against the lands.

2. Besides the constant fixed rights of superiority, there are others, which, because they depend upon uncertain events, are called casualties.

3. The casualties proper to a ward holding, while that tenure subsisted, were ward, recognition, and marriage, which it is now unnecessary to explain, as by the late statutes 20 and 25 *Geo. II.* for abolishing ward-holdings, the tenure of the lands holden ward of the Crown or Prince is turned into *blanch*, for payment of one penny Scots yearly, *si petatur tantum*; and the tenure of those holden of subjects, into *feu*, for payment of such yearly feu-duty in money, victual, or cattle, in place of all services, as shall be fixed by the court of Session. And accordingly that court, by act of sederunt Feb. 8. 1749, laid down rules for ascertaining the extent of these feu-duties.

4. The only casualty, or rather forfeiture, proper to feu-holdings, is the loss or tinsel of the feu-right, by the neglect of payment of the feu-duty for two full years. Yet where there is no conventional irritancy in the feu-right, the vassal is allowed to purge the legal irritancy at the bar; that is, he may prevent the forfeiture, by making payment before sentence: but where the legal irritancy is fortified by a conventional, he is not allowed to purge, unless where he can give a good reason for the delay of payment.

5. The casualties common to all holdings are, non-entry, relief, *diserent-efcheat*, disclamation, and purpresture. *NON-ENTRY* is that casualty which arises to the superior out of the rents of the feudal subject, through the heir's neglecting to renew the investiture after his ancestor's death. The superior is intitled to this casualty, not only where the heir has not obtained himself *infeft*, but where his retour is set aside upon nullities. The heir, from the death of the ancestor, till he be cited by the superior in a process of general declarator of non-entry, loses only the retoured duties of his lands, (see next parag.); and he forfeits these, though his delay should not argue any contempt of the superior, because the casualty is considered to fall, as a condition implied in the feudal right, and not as a penalty of transgression: But, where the delay proceeds not from the heir, but from the superior, nothing is forfeited.

6. For understanding the nature of retoured duties, it must be known, that there was anciently a general valuation of all the lands in Scotland, designed both for re-

gulating the proportion of public subsidies, and for ascertaining the quantity of non-entry and relief-duties payable to the superior; which appears, by a contract betwixt K. R. Bruce and his subjects *anno 1327*, preserved in the library of the faculty of advocates, to have been settled at least as far back as the reign of Alexander III. This valuation became in the course of time, by the improvement of agriculture, and perhaps also by the heightning of the nominal value of our money, from the reign of Robert I. downwards to that of James III. much too low a standard for the superior's casualties: Wherefore, in all services of heirs, the inquest came at last to take proof likewise of the present value of the lands contained in the brief (*quantum nunc valent*) in order to fix these casualties. The first was called the old, and the other the new extent. Though both extents were ordained to be specified in all retours made to the Chancery upon briefs of inquest; yet by the appellation of retoured duties in a question concerning casualties, the new extent is always understood. The old extent continued the rule for levying public subsidies, till a tax was imposed by new proportions, by several acts, made during the usurpation. By two acts of Cromwell's parliament, held at Westminster 1656, imposing taxations on Scotland, the rates laid upon the several counties are precisely fixed. The subsidy granted by the act of convention 1667, was levied on the several counties, nearly in the same proportions that were fixed by the usurper in 1656; and the sums to which each county was subjected were subdivided among the individual land-holders in that county, according to the valuations already settled, or that should be settled by the commission appointed to carry that act into execution. The rent fixed by these valuations is commonly called the valued rent; according to which the land tax, and most of the other public burdens, have been levied since that time.

7. In feu-holdings, the feu-duty is retoured as the rent, because the feu-duty is presumed to be, and truly was at first, the rent. The superior therefore of a feu-holding gets no non-entry, before citation in the general declarator; for he would have been intitled to the yearly feu-duty, though the fee had been full, *i. e.* though there had been a vassal *infeft* in the lands. The superior of teinds gets the fifth part of the retoured duty as non-entry, because the law considers teinds to be worth a fifth part of the rent. In rights of annualrent which are holden of the granter, the annualrent becomes his debtor's vassal; and the annualrent contained in the right is retoured to the blanch or other duty contained in the right before declarator.

8. It is because the retoured duty is the presumed rent, that the non-entry is governed by it. If therefore no retour of the lands in non-entry can be produced, nor any evidence brought of the retoured duty, the superior is intitled to the real, or at least to the valued rent, even before citation. In lands formerly holden ward of the King, the heir, in place of the retoured duties, is subjected only to the annual payment of one *per cent.* of the valued rent.

9. The heir, after he is cited by the superior in the action of general declarator, is subjected to the full rents

till his entry, because his neglect is less excusable after citation. The decree of declarator, proceeding on this action, intitles the superior to the possession, and gives him right to the rents, downward from the citation. As this sort of non-entry is properly penal, our law has always restricted it to the retoured duties, if the heir had a probable excuse for not entering.

10. Non entry does not obtain in burgage-holdings, because the incorporation of inhabitants holds the whole incorporated subjects of the King; and there can be no non-entry due in lands granted to communities, because there the vassal never dies: This covers the right of particulars from non-entry; for if non-entry be excluded with regard to the whole, it cannot obtain with regard to any part. It is also excluded, as to a third of the lands, by the terce, during the widow's life; and as to the whole of them, by the courtesy, during the life of the husband. But it is not excluded by a precept of feisin granted to the heir, till feisin be taken thereon.

11. RELIEF is that casualty which intitles the superior to an acknowledgment or consideration from the heir, for receiving him as vassal. It is called relief, because, by the entry of the heir, his fee is relieved out of the hands of the superior. It is not due in feu-holdings flowing from subjects, unless where it is expressed in the charter by a special clause for doubling the feu-duty at the entry of an heir; but in feu rights, holden of the crown, it is due, though there should be no such clause in the charter. The superior can recover this casualty, either by a pointing of the ground, as a *debitum fundi*, or by a personal action against the heir. In blanch and feu-holdings, where this casualty is expressly stipulated, a year's blanch or feu-duty is due in name of relief, beside the current year's duty payable in name of blanch or feu farm.

12. ESCHEAT (from *echeoir, to happen or fall*) is that forfeiture which falls through a person's being denounced rebel. It is either single or liferent. Single escheat, though it does not accrue to the superior, must be explained in this place, because of its coincidence with life-tenant.

13. After a debt is constituted, either by a formal decree, or by registration of the ground of debt, which to the special effect of execution, is in law accounted a decree; the creditor may obtain letters of horning, issuing from the signet, commanding messengers to charge the debtor to pay or perform his obligation, within a day certain. Where horning proceeds on a formal decree of the Session, the time indulged by law to the debtor is fifteen days; if upon a decree of the commission of teinds or admiral, it is ten; and upon the decrees of all inferior judges, fifteen days. Where it proceeds on a registered obligation, which specifies the number of days, that number must be the rule; and, if no precise number be mentioned, the charge must be given on fifteen days, which is the term of law, unless where special statute interposes; as in bills, upon which the debtor may be charged on six days.

14. The messenger must execute these letters (and indeed all summonses) against the debtor, either personally, or at his dwelling house; and, if he get not access to

the house, he must strike six knocks at the gate, and thereafter affix to it a copy of his execution. If payment be not made within the days mentioned in the horning, the messenger, after proclaiming three o'yeffs at the market-cross of the head borough, of the debtor's domicile, and reading the letters there, blows three blasts with a horn, by which the debtor is understood to be proclaimed rebel to the King for contempt of his authority; after which, he must affix a copy of the execution to the market-cross: This is called the publication of the diligence, or a denunciation at the horn. Where the debtor is not in Scotland, he must be charged on sixty days, and denounced at the market cross of Edinburgh, and pier and shore of Leith.

15. Denunciation, if registered within fifteen days, either in the Sheriff's books, or in the general register, drew after it the rebel's single escheat, *i. e.* the forfeiture of his moveables to the Crown. Persons denounced rebels have not a *persona standi in judicio*; they can neither sue nor defend in any action. But this incapacity, being unfavourable, is personal to the rebel, and cannot be pleaded against his assignee.

16. Persons cited to the court of Justiciary may be also denounced rebels, either for appearing there with too great a number of attendants; or, if they fail to appear, they are declared fugitives from the law. Single escheat falls without denunciation, upon sentence of death pronounced in any criminal trial; and by special statute, upon one's being convicted of certain crimes, though not capital; as perjury, bigamy, deforcement, breach of arraignment, and usury. By the late act abolishing wardholdings, the casualties both of single and liferent escheat are discharged, when proceeding upon denunciation for civil debts; but they still continue, when they arise from criminal causes. All moveables belonging to the rebel at the time of his rebellion, (whether proceeding upon denunciation, or sentence in a criminal trial), and all that shall be afterwards acquired by him until relaxation, fall under single escheat. Bonds bearing interest, because they continue heritable *quoad fiscum*, fall not under it, nor such fruits of heritable subjects as become due after the term next ensuing the rebellion, these being reserved for the liferent escheat.

17. The King never retains the right of escheat to himself, but makes it over to a donatory, whose gift is not perfected, till, upon an action of general declarator, it be declared that the rebel's escheat has fallen to the crown by his denunciation, and that the right of it is now transferred to the pursuer by the gift in his favour: Every creditor therefore of the rebel, whose debt was contracted before rebellion, and who has used diligence before declarator, is preferable to the donatory. But the escheat cannot be affected by any debt contracted, nor by any voluntary deed of the rebel after rebellion.

18. The rebel, if he either pays the debt charged for, or suspends the diligence, may procure letters of relaxation from the horn, which, if published in the same place, and registered fifteen days thereafter in the same register with the denunciation, have the effect to restore him to his former state; but they have no retrospect, as to the

moveables

moveables already fallen under escheat, without a special clause for that purpose.

19. The rebel, if he continues unrelaxed for year and day after rebellion, is construed to be civilly dead: And therefore, where he holds any feudal right, his superiors, as being without a vassal, are entitled, each of them, to the rents of such of the lands belonging to the rebel as holds of himself, during all the days of the rebel's natural life, by the casualty of **LIFERENT-ESCHEAT**; except where the denunciation proceeds upon treason or proper rebellion, in which case the liferent falls to the King.

20. It is that estate only, to which the rebel has a proper right of liferent in his own person, that falls under his liferent escheat.

21. Though neither the superior nor his donatory can enter into possession in consequence of this casualty, till decree of declarator; yet that decree, being truly declaratory, has a retrospect, and does not so properly confer a new right, as declare the right formerly constituted to the superior, by the civil death of his vassal. Hence, all charters or heritable bonds, though granted prior to the rebellion, and all adjudications, though led upon debts contracted before that period, are ineffectual against the liferent-escheat, unless seisin be taken thereon within year and day after the granter's rebellion.

22. Here, as in single escheat, no debt contracted after rebellion can hurt the donatory, nor any voluntary right granted after that period, though in security or satisfaction of prior debts.

23. **DISCLAMATION** is that casualty whereby a vassal forfeits his whole feu to his superior, if he disowns or disclaims him without ground, as to any part of it; **PURPRESTURE** draws likewise a forfeiture of the whole feu after it, and is incurred by the vassal's incroaching upon any part of his superior's property, or attempting, by building, inclosing, or otherwise, to make it his own. In both these feudal delinquencies, the least colour of excuse saves the vassal.

24. All grants from the crown, whether charters, gifts of casualties, or others, proceed on signatures which pass the signet. When the King resided in Scotland, all signatures were superscribed by him; but, on the accession of James VI. to the crown of England, a cachet or seal was made, having the King's name engraved on it, in pursuance of an act of the Privy Council, April 4. 1603, with which all signatures were to be afterwards sealed, that the Lords of exchequer were impowered to pass; and these powers are transferred to the court of Exchequer, which was established in Scotland after the union of the two kingdoms in 1707. Grants of higher consequence, as remissions of crimes, gifts proceeding upon forfeiture, and charters of *msodamus*, must have the King's sign-manual for their warrant.

25. If lands holding of the Crown were to be conveyed, the charter passed, before the union of the kingdoms in 1707, by the great seal of Scotland; and now by a seal substituted in place thereof. Grants of church-dignities, during episcopacy, passed also by the great seal; and the commissions to all the principal officers of the Crown, as Justice Clerk, King's Advocate, Solicitor, &c.

do so at this day. All rights which subjects may transmit by simple assignation, the King transmits by the privy seal; as gifts of moveables, or of casualties that require no seisin. The quarter seal, otherwise called the testimonial of the great seal, is appended to gifts of tutory, commissions of brieves issuing from the chancery, and letters of presentation to lands holding of a subject, proceeding upon forfeiture, bastardy, or *ultimus heres*.

26. Seals are to royal grants, what subscription is to rights derived from subjects, and give them authority: They serve also as a check to gifts procured (*subreptione vel obreptione*) by concealing the truth, or expressing a falsehood; for, where this appears, the gift may be stopped before passing the seals, though the signature should have been signed by the King. All rights passing under the great or privy seal must be registered in the registers of the great or privy seal *respectivé*, before appending the seal.

### Tit. 13. Of the Right which the Vassal acquires by getting the Feu.

**UNDER** the *dominium utile* which the vassal acquires by the feudal right, is comprehended the property of whatever is considered as part of the lands, whether of houses, woods, inclosures, &c. above ground; or of coal, limestone, minerals, &c. under ground. Mills have, by the generality of our lawyers, been deemed a separate tenement, and so not carried by a charter or disposition, without either a special clause conveying mills, or the erection of the lands into a barony. Yet it is certain, that, if a proprietor builds a mill on his own lands, it will be carried by his entail, or by a retour, without mentioning it, although the lands are not erected into a barony. If the lands disposed be astricted, or thirled to another mill, the purchaser is not allowed to build a new corn-mill on his property, even though he should offer security that it shall not hurt the thirle; which is introduced for preventing daily temptations to fraud.

2. Proprietors are prohibited to build dove-cotes, unless their yearly rent, lying within two miles thereof, extend to ten chalders of victual. A purchaser of lands, with a dove-cote, is not obliged to pull it down, though he should not be qualified to build one; but, if it becomes ruinous, he cannot rebuild it. The right of brewing, though not expressed in the grant, is implied in the nature of property; as are also the rights of fishing, fowling, and hunting, in so far as they are not restrained by statute.

3. There are certain rights naturally consequent on property, which are deemed to be reserved by the crown as *regalia*: unless they be specially conveyed: Gold and silver mines are of this sort: The first universally; and the other, where three half-pennies of silver can be extracted from the pound of lead, by act 1424. (three half-pennies at that time was equal to about two shillings five pennies of our present Scots money.) These were by our ancient law annexed to the Crown; but they are now dissolved from it; and every proprietor is intitled to a grant of the mines within his own lands, with the burden of delivering to the crown a tenth of what shall be brought up.

4. Salmon-

4. Salmon-fishing is likewise a right understood to be reserved by the Crown, if it be not expressly granted; but forty years possession thereof, where the lands are either erected into a barony, or granted with the general clause of fishings, establish as the full right of the salmon fishing in the vassal. A charter of lands, within which any of the king's forests lie, does not carry the property of such forest to the vassal.

5. All the subjects, which were by the Roman law accounted *res publicæ*, as rivers, high ways, ports, &c. are, since the introduction of feus, held to be *inter regalia*, or *in patrimonio principis*; and hence incroachment upon a highway is said to infer purpresture. No person has the right of a free port without a special grant, which implies a power in the grantee to levy anchorage and shore-dues, and an obligation upon him to uphold the port in good condition. In this class of things, our forefathers reckoned fortalices, or small places of strength, originally built for the defence of the country, either against foreign invasions, or civil commotions; but these now pass with the lands in every charter,

6. The vassal acquires right by his grant, not only to the lands specially contained in the charter, but to those that have been possessed forty years as pertinent thereof. But, 1. If the lands in the grant are marked out by special limits, the vassal is circumscribed by the tenor of his own right, which excludes every subject without these limits from being pertinent of the lands. 2. A right possessed under an express investment is preferable, *ceteris paribus*, to one possessed only as pertinent, 3. Where neither party is invest *per expressum*, the mutual promiscuous possession by both, of a subject as pertinent, resolves into a commonalty of the subject possessed: But if one of the parties has exercised all the acts of property of which the subject was capable, while the possession of the other was confined to pasturage only, or to casting seal and divot, the first is to be deemed sole proprietor, and the other to have merely a right of servitude.

7. As barony is a *nomen universitatis*, and unites the several parts contained in it into one individual right, the general conveyance of a barony carries with it all the different tenements of which it consists, though they should not be specially enumerated, (and this holds, even without erection into a barony, in lands that have been united under a special name.) Hence likewise, the possession by the vassal of the smallest part of the barony lands preserves to him the right of the whole.

8. The vassal is intitled, in consequence of his property, to levy the rents of his own lands, and to recover them from his tenants by an action for rent before his own court; and from all other possessors and intruders, by an action of mails and duties before the Sheriff. He can also remove from his lands, tenants who have no leases, and he can grant tacks or leases to others. A tack is a contract of location, whereby the use of land or any other immoveable subject, is set to the lessee or tacksmen for a certain yearly rent, either in money, the fruits of the ground, or services. It ought to be reduced into writing, as it is a right concerning lands; tacks therefore, that are given verbally, to endure for term of years, are good against neither party, for more

than one year. An obligation to grant a tack is as effectual against the grantor, as a formal tack. A liferenter, having a temporary property in the fruits, may grant tacks to endure for the term of his own liferent.

9. The tacksmen's right is limited to the fruits which spring up annually from the subject set, either naturally, or by the industry of the tacksmen; he is not therefore intitled to any of the growing timber above ground, and far less to the minerals, coal, clay, &c. under ground, the use of which consumes the substance. Tacks are, like other contracts, personal rights in their own nature, and consequently ineffectual against singular successors in the lands; but, for the encouragement of agriculture, they were, by act 1449, declared effectual to the tacksmen for the full time of their endurance, into whose hands soever the lands might come.

10. To give a written tack the benefit of this statute, it must mention the special tack-duty payable to the proprietor, which though small, if it be not elusory, secures the tacksmen; and it must be followed by possession, which supplies the want of a seisin. If a tack does not express the term of entry, the entry will commence at the next term after its date, agreeable to the rule, *Quod parè debetur, præsentis die debetur*. If it does not mention the ish, *i. e.* the term at which it is to determine, it is good for one year only; but, if the intencion of parties to continue it for more than one year, should appear from any clause in the tack, it is sustained for two years as the *minimum*. Tacks granted to perpetuity, or with an indefinite ish, have not the benefit of the statute. Tacks of houses within borough do not fall within this act.

11. Tacks necessarily imply a *delectus persona*, a choice by the setter of a proper person for his tenant. Hence the conveyance of a tack, which is not granted to assignees, is ineffectual without the landlord's consent. A right of tack, though it be heritable, falls under the *jur mariti*, because it cannot be separated from the labouring cattle and implements of tillage, which are moveable subjects. A tack therefore granted to a single woman without the liberty of assignig, falls by her marriage, because the marriage, which is a legal conveyance thereof to the husband, cannot be annulled. This implied exclusion of assignees, is however limited to voluntary, and does not extend to necessary assignments, as an adjudication of a tack by the tacksmen's creditor; but a tack, expressly excluding assignees, cannot be carried even by adjudication. But tacksmen may sublet, unless subtenants are expressly excluded; and liferent tacks, because they import a higher degree of right in the tacksmen, than tacks for a definite term, may be assigned, unless assignees be specially excluded.

12. If neither the setter nor tacksmen shall properly discover their intencion to have the tack dissolved at the term fixed for its expiration, they are understood, or presumed, to have entered into a new tack upon the same terms with the former, which is called *tacit relocation*; and continues till the landlord warns the tenant to remove, or the tenant renounces his tack to the landlord: This obtains also in the case of moveable tenants, who possess from year to year without written tacks.

13. In tacks of land the setter is commonly bound to put

put all the houses and office houses, necessary for the farm, in good condition at the tenant's entry; and the tenant must keep them and leave them so at his removal. But in tacks of houses, the fetter must not only deliver to the tenant the subject set, in tenantable repair at his entry, but uphold it in that repair during the whole years of the tack.

14. If the inclemency of the weather, inundation, or calamity of war, should have brought upon the crop an extraordinary damage (*plus quam tolerabile*), the landlord had, by the Roman law, no claim for any part of the tack-duty: If the damage was more moderate, he might exact the full rent. It is no where defined, what degree of sterility or devastation makes a loss not to be borne; but the general rule of the Roman law seems to be made ours. Tenants are obliged to pay no public burdens, to which they are not expressly bound by their tacks, except mill-services.

15. Tacks may be evacuated during their currency, 1. In the same manner as feu-rights, by the tacksmen's running in arrear of his tack-duty for two years together. This irritancy may be prevented by the tenant's making payment at the bar before sentence. 2. Where the tenant either runs in arrear of one year's rent, or leaves his farm uncultivated at the usual season; in which case he may be ordained to give security for the arrears, and for the rent of the five following crops, if the tack shall subsist so long; otherwise, to remove, as if the tack were at an end. 3. Tacks may be evacuated at any time, by the mutual consent of parties.

16. The landlord, when he intends to remove a tenant whose tack is expiring, or who possesses without a tack, must, upon a precept signed by himself, warn the tenant forty days preceding the term of Whitsunday, at or immediately preceding the ish, personally, or at his dwelling house, to remove at that term, with his family and effects. This precept must be also executed on the ground of the lands, and thereafter read in the parish church where the lands lie, after the morning service, and affixed to the most patent door thereof. Whitsunday, though it be a moveable feast, is, in questions of removing, fixed to the 15th of May. In warnings from tenements within borough, it is sufficient that the tenant be warned forty days before the ish of the tack, whether it be Whitsunday or Martinmas; and in these the ceremony of chalking the door is sustained as warning, when proceeding upon a verbal order from the proprietor.

17. This process of warning was precisely necessary for founding an action of removing against tenants, till the act of federunt of the court of Session, Dec. 14. 1756, which leaves it in the option of the proprietor, either to use the former method, or to bring his action of removing before the judge ordinary; which, if it be called forty days before the said term of Whitsunday, shall be held as equal to a warning. Where the tenant is bound, by an express clause of his tack, to remove at the ish without warning, such obligation is, by the said act, declared to be a sufficient warrant for letters of horning, upon which, if the landlord charge his tenant forty days before the said Whitsunday, the judge is authorized to eject him within six days after the term of removing expressed in the tack.

18. Actions of removing might, even before this act of federunt, have been pursued without any previous warning, 1. Against vicious possessors, *i. e.* persons who had seized the possession by force, or who, without any legal title, had intruded into it, after the last possessor had given it up. 2. Against possessors who had a naked tolerance. 3. Against tenants who had run in arrear of rent, during the currency of their tacks. 4. Again such as had sold their lands, and yet continued to possess after the term of the purchaser's entry. Upon the same ground, warning was not required, in removings against possessors of liferented lands, after the death of the liferenter who died in the natural possession: But if he possessed by tenants, these tenants could not be disturbed in their possessions till the next Whitsunday, that they might have time to look out for other farms; but they might be compelled to remove at that term, by an action of removing, without warning.

19. A landlord's title in a removing, let it be ever so lame, cannot be brought under question by a tenant whose tack flows immediately from him; but, if he is to insist against tenants not his own, his right must be perfected by infestment, unless it be such as requires no infestment, as *terce*, &c.

20. The defender, in a removing, must, before offering any defence which is not instantly verified, give security to pay to the fetter the violent profits, if they should be awarded against him. These are so called, because the law considers the tenant's possession after the warning as violent. They are estimated, in tenements within borough, to double the rent; and in lands, to the highest profits the pursuer could have made of them, by possessing them either by a tenant, or by himself.

21. If the action of removing shall be passed from, or if the landlord shall, after using warning, accept of rent from the tenant, for any term subsequent to that of the removal, he is presumed to have changed his mind, and tacit relocation takes place. All actions of removing against the principal or original tacksmen, and decrees thereupon, if the order be used, which is set forth *supra*, § 17. are, by the act of federunt 1755, declared to be effectual again the assignees to the tack, or subtenants.

22. The landlord has, in security of his tack-duty, over and above the tenant's personal obligation, a tacit pledge or hypothec, not only in the fruits, but in the cattle pasturing on the ground. The corn, and other fruits, are hypothecated for the rent of that year whereof they are the crop; for which they remain affected, though the landlord should not use his right for years together.

23. The whole cattle on the ground, considered as a quantity, are hypothecated for a year's rent, one after another successively. The landlord may apply this hypothec payment of the past year's rent, at any time within three months from the last conventional term of payment, after which it ceases for that year. As the tenant may increase the subject of this hypothec, by purchasing oxen, sheep, &c. so he can impair it, by selling part of his stock; but if the landlord suspects the tenant's management, he may, by sequestration or poiding, make his right, which was before general upon the whole stock, special upon every individual. A superior has also a hypo-

pothec for his feu-duty, of the same kind with that just explained.

24. In tacks of houses, breweries, shops, and other tenements, which have no natural fruits, the furniture and other goods brought into the subject set are hypothecated to the landlord for one year's rent. But the tenant may by sale impair this hypothec, as he might that of cattle in rural tenements; and indeed, in the particular case of a shop, the tenant rents it for no other purpose, than as a place of sale.

**Tit. 14. Of the Transmission of Rights, by Confirmation and Resignation.**

A VASSAL may transmit his feu either to universal successors, as heirs; or to singular successors, *i. e.* those who acquire by gift, purchase, or other singular title. This last sort of transmission is either voluntary, by disposition; or necessary, by adjudication.

2. By the first feudal rules, no superior could be compelled to receive any vassal in the lands, other than the heir expressed in the investiture; for the superior alone had the power of ascertaining to what order of heirs the fee granted by himself was to descend. But this right of refusal in the superior did not take place, 1. In the case of creditors appraisers or adjudgers, whom superiors were obliged to receive upon payment of a year's rent. 2. In the case of purchasers of bankrupt estates, who were put on the same footing with adjudgers. The Crown refuses no voluntary disponee, on his paying a composition to the exchequer of a sixth part of the valued rent. Now superiors are directed to enter all singular successors (except incorporations) who shall have got from the vassal a disposition, containing procuratory of resignation; they always receiving the fees or casualties that law entitles them to on a vassal's entry, *i. e.* a year's rent.

3. Base rights, *i. e.* dispositions to be holden of the disponer, are transmissions only of the property, the superiority remaining as formerly. As this kind of right might, before establishing the registers, have been kept quite concealed from all but the granter and receiver, a public right was preferable to it, unless clothed with possession: But as this distinction was no longer necessary after the establishment of the records, all infeftments are declared preferable, according to the dates of their several registrations; without respect to the former distinction of base and public, or of being clothed and not clothed with possession.

4. Public rights, *i. e.* dispositions to be holden of the granter's superior, may be perfected either by confirmation or resignation; and therefore, they generally contain both precept of feisin and procuratory of resignation. When the receiver is to complete his right in the first way, he takes feisin upon the precept; but such feisin is ineffectual without the superior's confirmation; for the disponee cannot be deemed a vassal, till the superior receive him as such, or confirm the holding. By the usual style in the transmission of lands, the disposition contains an obligation and precept of infeftment, both *a me* and *de me*, in the option of the disponee; upon which, if feisin is taken indefinitely, it is construed in favour of

the disponee to be a base infeftment, because a public right is null without confirmation: But, if the receiver shall afterwards obtain the superior's confirmation, it is considered as if it had been from the beginning a public right.

5. Where two several public rights of the same subject are confirmed by the superior, their preference is governed by the dates of the confirmations, not of the infeftments confirmed; because it is the confirmation which compleats a public right.

6. Though a public right becomes, by the superior's confirmation, valid from its date; yet if any mid impediment intervene betwixt that period and the confirmation, to hinder the two from being conjoined, *e. g.* if the granter of a public right should afterwards grant a base right to another, upon which feisin is taken before the superior's confirmation of the first, the confirmation will have effect only from its own date; and consequently the base right first compleated, will carry the *property* of the lands preferable to the public one.

7. Resignation is that form of law, by which a vassal surrenders his feu to his superior; and it is either *ad perpetuam remanentiam*, or *in favorem*. In resignations *ad remanentiam*, where the feu is resigned, to the effect that it may remain with the superior, the superior, who before had the superiority, acquires, by the resignation, the property also of the lands resigned: and as his infeftment in the lands still subsisted, notwithstanding the right by which he had given his vassal the property; therefore, upon the vassal's resignation, the superior's right of property revives, and is consolidated with the superiority, without the necessity of a new infeftment; but the instrument of resignation must be recorded.

8. Resignations *in favorem* are made, not with an intention that the property resigned should remain with the superior, but that it should be again given by him, in favour either of the resigner himself, or of a third party; consequently the fee remains in the resigner, till the person in whose favour resignation is made gets his right from the superior perfected by feisin. And because resignations *in favorem*, are but incompleat personal deeds, our law has made no provision for recording them. Hence, the first feisin on a second resignation is preferable to the last feisin upon the first resignation; but the superior, accepting a second resignation, whereupon a prior feisin may be taken in prejudice of the first resignatory, is liable in damages.

9. By our former decisions, one who was vested with a personal right of lands, *i. e.* a right not compleated by feisin, effectually divested himself by disposing it to another; after which, no right remained in the disponer, which could be carried by a second disposition, because a personal right is no more than a *jus obligationis*, which may be transferred by any deed sufficiently expressing the will of the granter. But this doctrine, at the same time that it rendered the security of the records extremely uncertain, was not truly applicable to such rights as required feisin to complete them; and therefore it now obtains, that the granter even of a personal right of lands, is not so divested by conveying the right to one person, but that he may effectually make it over afterwards to another;

mother; and the preference between the two does not depend on the dates of the dispositions, but on the priority of the seisin following upon them.

### Tit. 15. Of redeemable Rights.

An heritable right is said to be redeemable, when it contains a right of reversion, or return, in favour of the person from whom the right flows. Reversions are either legal, which arise from the law itself, as in adjudications, which law declares to be redeemable within a certain term after their date; or conventional, which are constituted by the agreement of parties, as in wadsets, rights of annualrent, and rights in security. A wadset (from wad or pledge) is a right, by which lands, or other heritable subjects, are impignorated by the proprietor to his creditor, in security of his debt; and, like other heritable rights, is perfected by seisin. The debtor, who grants the wadset, and has the right of reversion, is called the reverser; and the creditor, receiver of the wadset, is called the wadsetter.

Wadsets, by the present practice, are commonly made out in the form of mutual contracts, in which one party sells the land, and the other grants the right of reversion. When the right of reversion is thus incorporated in the body of the wadset, it is effectual without registration; because the singular successor in the wadset is, in that case, sufficiently certified of the reversion, though it be not registered, by looking into his own right, which bears it *in gremio*. But where the right of reversion is granted in a separate writing, it is ineffectual against the singular successor of the wadsetter, unless it be registered in the register of seisin within 60 days after the date of the seisin upon the wadset.

3. Rights of reversion are generally esteemed *stricti juris*; yet they go to heirs; though heirs should not be mentioned, unless there be some clause in the right, discovering the intention of parties, that the reversion should be personal to the reverser himself. In like manner, though the right should not express a power to redeem from the wadsetter's heir, as well as from himself, redemption will be competent against the heir. All our lawyers have affirmed, that reversions cannot be assigned, unless they are taken to assignees; but from the favour of legal diligence, they may be adjudged.

4. Reversions commonly leave the reverser at liberty to redeem the lands *quandocunque*, without restriction in point of time; but a clause is adjected to some reversions, that if the debt be not paid against a determinate day, the right of reversion shall be irritated, and the lands shall become the irredeemable property of the wadsetter. Nevertheless, the irritancy being penal, as in wadsets, the sum lent falls always short of the value of the lands, and the right of redemption is by indulgence continued to the reverser, even after the term has expired, while the irritancy is not declared. But the reverser, if he does not take the benefit of this indulgence, within forty years after the lapse of the term, is cut out of it by prescription.

5. If the reverser would redeem his lands, he must use an order of redemption against the wadsetter: the first

step of which is premonition (or notice given under form of instrument) to the wadsetter, to appear at the time and place appointed by the reverser, then and there to receive payment of his debt, and thereupon to renounce his right of wadset. In the voluntary redemption of a right of wadset holden base, a renunciation duly registered re-establishes the reverser in the full right of the lands. Where the wadset was granted to be holden of the grantor's superior, the superior must receive the reverser, on payment of a year's rent, if he produce a disposition from the wadsetter, containing procuratory of resignation. If, at executing the wadset, the superior has granted letters of regrefs, *i. e.* an obligation again to enter the reverser upon redemption of the lands, he will be obliged to receive him, without payment of the year's rent. But letters of regrefs will not have this effect against singular successors in the superiority, if they are not registered in the register of reversions. All wadsets that remain personal rights, are extinguished by simple discharges, though they should not be recorded.

6. If the wadsetter either does not appear at the time and place appointed, or refuses the redemption-money, the reverser must consign it under form of instrument, in the hands of the person thereto appointed in the right of reversion; or, if no person be named, in the hands of the clerk to the bills, a clerk of session, or any responsible person. An instrument of consignment, with the consignatory's receipt of the money consigned, compleats the order of redemption; stops the farther currency of interest against the reverser, and founds him in an action for declaring the order to be formal, and the lands to be redeemed in consequence of it.

7. After decree of declarator is obtained, by which the lands are declared to return to the debtor, the consigned money, which comes in place of the lands, becomes the wadsetter's, who therefore can charge the consignatory upon letters of horning to deliver it up to him; but, because the reverser may, at any time before decree, pass from his order, as one may do from any other step of diligence, the consigned sums continue to belong to the reverser, and the wadsetter's interest in the wadset continues heritable till that period.

8. If the wadsetter chuses to have his money rather than the lands, he must require from the reverser, under form of instrument, the sums due by the wadset, in terms of the right. The wadset sums continue heritable, notwithstanding requisition, which may be passed from by the wadsetter even after the reverser has consigned the redemption money in consequence thereof.

9. Wadsets are either proper or improper. A proper wadset is that whereby it is agreed, that the use of the land shall go for the use of the money; so that the wadsetter takes his hazard of the rents, and enjoys them without accounting, in satisfaction, or *in solutum* of his interest.

10. In an improper wadset, the reverser, if the rent should fall short of the interest, is taken bound to make up the deficiency; if it amounts to more, the wadsetter is obliged to impute the excrement towards extinction of the capital: And, as soon as the whole sums, principal and interest, are extinguished by the wadsetter's possession,



session, he may be compelled to renounce, or divest himself in favour of the reverser.

11. If the wadsetter be intitled by his right to enjoy the rents without accounting, and if at the same time the reverser be subjected to the hazard of their deficiency, such contract is justly declared usurious; and also in all proper wadsets wherein any unreasonable advantage has been taken of the debtor, the wadsetter must, during the not requisition of the sum lent, either quit his possession to the debtor, upon his giving security to pay the interest, or subject himself to account for the surplus-rents, as in improper wadsets.

12. Infeftments of annualrent, the nature of which has been explained, are also redeemable rights. A right of annualrent does not carry the property of the lands, but it creates a real *nexus* or burden upon the property, for payment of the interest or annualrent contained in the right; and consequently, the bygone interelts due upon it are *debita fundi*. The annualrenter may therefore either insist in a real action for obtaining letters of poinding the ground, or sue the tenant in a personal action towards the payment of his past interest: And in a competition for those rents, the annualrenter's preference will not depend on his having used a poinding of the ground, for his right was complicated by the feisin; and the power of poinding the ground, arising from that antecedent right, is *meræ facultatis*, and need not be exercised, if payment can be otherwise got. As it is only the interest of the sum lent which is a burden upon the lands, the annualrenter, if he wants his principal sum, cannot recover it either by poinding or by a personal action against the debtor's tenants, but must demand it from the debtor himself, on his personal obligation in the bond, either by requisition, or by a charge upon letters of horning, according as the right is drawn.

13. Rights of annualrent, being servitudes upon the property, and consequently consistent with the right of property in the debtor, may be extinguished without resignation.

14. Infeftments in security are another kind of redeemable rights (now frequently used in place of rights of annualrent) by which the receivers are infeft in the lands themselves, and not simply in an annualrent forth of them, for security of the principal sums, interest, and penalty, contained in the rights. If an infeftment in security be granted to a creditor, he may thereupon enter into the immediate possession of the lands or annualrent for his payment. They are extinguished as rights of annualrent.

15. All rights of annualrent, rights in security, and generally whatever constitutes a real burden on the fee, may be the ground of an adjudication, which is preferable to all adjudications, or other diligences, intervening between the date of the right and of the adjudication deduced on it; not only for the principal sum contained in the right, but also for the whole past interest contained in the adjudication. This preference arises from the nature of real debts, or *debita fundi*; but in order to obtain it for the interest of the interest accumulated in the adjudication, such adjudication must proceed on a process of poinding the ground.

### Tit. 16. Of Servitudes.

SERVITUDE is a burden affecting lands, or other heritable subjects, whereby the proprietor is either restrained from the full use of what is his own, or is obliged to suffer another to do something upon it. Servitudes are either natural, legal, or conventional. Nature itself may be said to constitute a servitude upon inferior tenements, whereby they must receive the water that falls from those that stand on higher ground. Legal servitudes are established by statute or custom, from considerations of public policy; among which may be numbered the restraints laid upon the proprietors of tenements within the city of Edinburgh. There is as great a variety of conventional servitudes, as there are ways by which the exercise of property may be restrained by passion in favour of another.

2. Conventional servitudes are constituted, either by grant, where the will of the party burdened is expressed in writing, or by prescription, where his consent is presumed from his acquiescence in the burden for 40 years. A servitude constituted by writing, or grant, is not effectual against the grantor's singular successors, unless the grantee has been in the use or exercise of his right: But they are valid against the grantor and his heirs, even without use. In servitudes that may be acquired by prescription, forty years exercise of the right is sufficient, without any title in writing, other than a charter and feisin of the lands, to which the servitude is claimed to be due.

3. Servitudes constituted by grant are not effectual, in a question with the superior of the tenement burdened with the servitude, unless his consent be adhibited; for a superior cannot be hurt by his vassal's deed: But, where the servitude is acquired by prescription, the consent of the superior, whose right afforded him a good title to interrupt, is implied. A servitude by grant, though followed only by a partial possession, must be governed, as to its extent, by the tenor of the grant; but a servitude by prescription is limited by the measure or degree of the use had by him who prescribes: agreeably to the maxim, *tantum præscriptum quantum possessum*.

4. Servitudes are either predial or personal. Predial servitudes are burdens imposed upon one tenement, in favour of another tenement. That to which the servitude is due is called the dominant, and that which owes it is called the servient tenement. No person can have right to a predial servitude, if he is not proprietor of some dominant tenement that may have benefit by it; for that right is annexed to a tenement, and so cannot pass from one person to another, unless some tenement goes along with it.

5. Predial servitudes are divided into rural servitudes, or of lands; and urban servitudes, or of houses. The rural servitudes of the Romans were *iter*, *clivus*, *via*, *aquæductus*, *aquæhousus*, and *jus pascendi pecoris*. Similar servitudes may be constituted with us, of a foot-road, horse road, cart-road, dams, and aqueducts, watering of cattle, and pasturage. The right of a highway is not a servitude constituted in favour of a particular tenement, but is a right common to all travellers. The care

of

of high-ways, bridges, and ferries, is committed to the sheriffs, justices of peace, and commissioners of supply in each shire.

6. Common pasturage, or the right of feeding one's cattle upon the property of another, is sometimes constituted by a general clause of pasturage in a charter or disposition, without mentioning the lands burdened; in which case, the right comprehends whatever had been formerly appropriated to the lands disposed out of the grantor's own property, and likewise all pasturage due to them out of other lands. When a right of pasturage is given to several neighbouring proprietors, on a moor or common belonging to the grantor, indefinite as to the number of cattle to be pastured, the extent of their several rights is to be proportioned according to the number that each of them can fodder in winter upon his own dominant tenement.

7. The chief servitudes of houses among the Romans were those of support, *viz. tigni immittendi*, and *oneris ferendi*. The first was the right of fixing in our neighbour's wall a joist or beam from our house: The second was that of resting the weight of one's house upon his neighbour's wall.

8. With us, where different floors or stories of the same house belong to different persons, as is frequent in the city of Edinburgh, the property of the house cannot be said to be entirely divided; the roof remains a common roof to the whole, and the area on which the house stands supports the whole; so that there is a communication of property, in consequence of which the proprietor of the ground floor must, without the constitution of any servitude, uphold it for the support of the upper, and the owner of the highest story must uphold that as a cover to the lower. Where the highest floor is divided into garrets among the several proprietors, each proprietor is obliged, according to this rule, to uphold that part of the roof which covers his own garret.

9. No proprietor can build, so as to throw the rain-water falling from his own house, immediately upon his neighbour's ground, without a special servitude, which is called of *stillicide*: but, if it falls within his own property, though at the smallest distance from the march, the owner of the inferior tenement must receive it.

10. The servitudes *altius non tollendi*, *et non officendi luminibus vel prospectui*, restrain proprietors from raising their houses beyond a certain height, or from making any building whatsoever that may hurt the light or prospect of the dominant tenement. These servitudes cannot be constituted by prescription alone; for, though a proprietor should have built his house ever so low, or should not have built at all upon his grounds for forty years together, he is presumed to have done so for his own conveniency or profit; and therefore cannot be barred from afterwards building a house on his property, or raising it to what height he pleases, unless he be tied down by his own consent.

11. We have two predial servitudes to which the Romans were strangers, *viz.* that of *sewel* or *seal* and *divot*, and of *thirlage*. The first is a right, by which the owner of the dominant tenement may turn up peats, turfs, seals, or divots, from the ground of the servient, and carry

them off either for *sewel*, or *thatch*, or the other uses of his own tenement.

12. *THIRLAGE* is that servitude, by which lands are *alstricted*, or *thirled*, to a particular mill, and the possessors bound to grind their grain there, for payment of certain *multures* and *sequels*, as the agreed price of grinding. In this servitude, the mill is the dominant tenement, and the lands *alstricted* (which are called also the *thirle* or *sucken*) the *servient*. *Multure* is the quantity of grain or meal payable to the proprietor of the mill, or to the *multurer* his *tacksmen*. The *sequels* are the small quantities given to the servants, under the name of *knave-ship*, *bannock*, and *lock* or *gowpen*. The quantities paid to the mill by the lands not *alstricted*, are generally proportioned to the value of the labour, and are called *out-town* or *in-sucken multures*; but those paid by the *thirle* are ordinarily higher, and are called *in-town* or *in-sucken multures*.

13. *Thirlage* may be constituted by a land-holder, when, in the disposition of certain lands, he *alstricts* them to his own mill; or when, in the disposition of a mill, he *alstricts* his own lands to the mill disposed, or when, in letting his lands, he makes it a condition in the *tacks*. The grant of a mill with the general clause of *multures*, without specifying the lands *alstricted*, conveys the *thirlage* of all the lands formerly *alstricted* to that mill, whether they were the property of the grantor, or of a third party.

14. A less formal constitution serves to *alstrict* barony-lands to the mill of the barony, than is necessary in any other *thirlage*; which perhaps proceeds from the effects of the union between the two. Hence, if a baron makes over the mill of a barony, *cum multuris*, or *cum alstrictis multuris*, it infers an *alstriction* of the barony-lands to the mill conveyed, even of such as had been before sold to another for a certain duty *pro omni alio onere*. But if, prior to the baron's conveyance of his mill *cum multuris*, he had sold any part of the barony-lands to another *cum multuris*, the first purchaser's lands are not *alstricted* by the posterior grant; for a right of lands with the *multures*, implies a freedom of these lands from *thirlage*.

15. *Thirlage* is either, 1. Of *grindable* corns; or, 2. Of *all* growing corns; or, 3. Of the *investa et illata*, *i. e.* of all the grain brought within the *thirle*, though of another growth. Where the *thirlage* is of *grindable* grain, it is in practice restricted to the corns which the tenants have occasion to grind, either for the support of their families, or for other uses; the surplus may be carried out of the *thirle* unmanufactured, without being liable in *multure*. Where it is of the *grana crescentia*, the whole grain growing upon the *thirle* is *alstricted*, with the exceptions, 1. Of seed and horse-corn, which are destined to uses inconsistent with grinding; and, 2. Of the farm-duties due to the landlord, if they are deliverable in grain not grinded. But, if the rent be payable in meal, flour, or malt, the grain of which these are made must be manufactured in the dominant mill.

16. The *thirlage* of *investa et illata* is seldom constituted but against the inhabitants of a borough or village, that they shall grind all the unmanufactured grain they import thither at the dominant mill. *Multure*, therefore, cannot be exacted in a *thirlage* of *investa et illata*, for

flour or oat-meal brought into the servient tenement, unless the importer had brought it in grain, and grinded it at another mill. The same grain that owes multure, as *granum crescens*, to the mill in whose thirle it grew, if it shall be afterwards brought within a borough where the *inveſta et illata* are thirled, muſt pay a ſecond multure to the proprietor of that dominant tenement; but, where the right of theſe two thirlages is in the ſame proprietor, he cannot exact both. Where lands are thirled of general terms, without expreſſing the particular nature in the ſervitude, the lighteſt thirlage is preſumed, from the favour of liberty; but in the aſtriction of a borough or village, where there is no growing grain which can be the ſubject of thirlage, the aſtriction of *inveſta et illata* muſt be neceſſarily underſtood.

17. Thirlage, in the general caſe, cannot be eſtabliſhed by preſcription alone, *ſoi iis quæ ſunt mera facultatis non præſcribitur*; but where one has paid for forty years together the heavy inſucken multures, the ſlighteſt title in writing will ſubject his lands. Thirlage may be, contrary to the common rule, conſtituted by preſcription alone, 1. Where one pays to a mill a certain ſum, or quantity of grain yearly, in name of multure, whether he grinds at it or not (called dry multure.) 2. In mills of the King's property; which is conſtituted *jure coronæ*, without titles in writing; and; where he derives right from another, his titles are more liable to be loſt. This is extended in practice to mills belonging to church-lands, where thirty years poſſeſſion is deemed equivalent to a title in writing, from a preſumption that their rights were deſtroyed at the reformation. Though thirlage itſelf cannot be conſtituted by mere poſſeſſion, the proportion of multure payable to the dominant tenement may be ſo fixed.

18. The poſſeſſors of the lands aſtricted, are bound to uphold the mill, repair the dam-dykes and aqueducts, and bring home the millſtones. Theſe ſervices, though not expreſſed in the conſtitution, are implied.

19. Servitudes, being reſtraints upon property, are *ſtricti juris*: They are not therefore preſumed, if the acts upon which they are claimed can be explained conſiſtently with freedom; and, when ſervitudes are conſtituted, they ought to be uſed in the way leaſt burdensome to the ſervient tenement. Hence, one who has a ſervitude of peats upon his neighbour's moſs, is not at liberty to extend it for the uſe of any manufacture which may require an extraordinary expence of ſewel; but muſt confine it to the natural uſes of the dominant tenement.

20. Servitudes are extinguished, 1. *Confuſione*, when the ſame perſon comes to be proprietor of the dominant and ſervient tenements; for *res ſua nemini ſervit*, and the uſe the proprietor thereafter makes of the ſervient tenement is not *jure ſervitutis*, but is an act of property. 2. By the perishing, either of the dominant or ſervient tenement. 3. Servitudes are loſt *non utendo*, by the dominant tenement neglecting to uſe the right for forty years; which is conſidered as a dereliction of it, though he, who has the ſervient tenement, ſhould have made no interruption, by doing acts contrary to the ſervitude.

21. Personal ſervitudes are thoſe by which the proper-

ty of a ſubject is burdened, in favour, not of a tenement, but of a perſon. The only perſonal ſervitude known in our law, is uſufruct or life-rent; which is a right to uſe and enjoy a thing during life, the ſubſtance of it being preſerved. A life-rent cannot therefore be conſtituted upon things which perish in the uſe; and though it may upon ſubjects which gradually wear out by time, as houſehold-furniture, &c. yet, with us, it is generally applied to heritable ſubjects. He, whoſe property is burdened, is uſually called the ſiar.

22. Life-rents are divided into conventional and legal. Conventional life-rents are either ſimple, or by reſervation. A ſimple life-rent, or by a ſeparate conſtitution, is that which is granted by the proprietor in favour of another: And this ſort, contrary to the nature of predial ſervitudes, requires ſeiſin in order to affect ſingular ſucceſſors; for a life-rent of lands is, in ſtrict ſpeech, not a ſervitude, but a right reſembling property, which conſtitutes the life-renter vaſſal for life; and ſingular ſucceſſors have no way of diſcovering a life-rent-right, which perhaps is not yet commenced, but by the records; whereas, in predial ſervitudes, the conſtant uſe of the dominant tenement makes them public. The proper right of life-rent is intransmiſſible, *offibus uſufructuarii inheret*: When the profits of the life-rented ſubject are tranſmitted to another, the right becomes merely perſonal, for it intitles the aſſignee to the rent, not during his own life, but his cedent's, and is therefore carried by ſimple aſſignation, without ſeiſin.

23. A life-rent by reſervation, is that which a proprietor reſerves to himſelf in the ſame writing by which he conveys the fee to another. It requires no ſeiſin; for the granter's former ſeiſin, which virtually included the life-rent, ſtill ſubſiſts as to the life-rent which is expreſſly reſerved. In conjunct inſeſtments taken to huſband and wife, the wife's right of conjunct fee reſolves, in the general caſe, into a life-rent.

24. Life-rents by law, are the terce and the courteſy. The terce (*tertia*) is a life-rent competent by law to widows, who have not accepted of ſpecial provisions, in the third of the heritable ſubjects, in which their huſbands died inſeſt; and takes place only where the marriage has ſubſiſted for year and day, or where a child has been born alive of it.

25. The terce is not limited to lands, but extends to teinds, and to ſervitudes and other burdens affecting lands; thus, the widow is intitled, in the right of her terce, to a life-rent of the third of the ſums ſecured, either by rights of annualrent, or by rights in ſecurity. In improper wadſets, the terce is a third of the ſum lent: In thoſe that are proper, it is a third of the wadſet-lands; or in caſe of redemption, a third of the redemption money. Neither rights of reverſion, ſuperiority, nor patronage, fall under the terce; for none of theſe have fixed profits, and ſo are not proper ſubjects for the widow's ſubſiſtence; nor tacks, becauſe they are not feudal rights. Burgage-tenements are alſo excluded from it, the reaſon of which is not ſo obvious. Since the huſband's ſeiſin is both the meaſure and ſecurity of the terce, ſuch debts or diligences alone, as exclude the huſband's ſeiſin, can prevail over it.

26. Where a terce is due out of lands burdened with

a prior terce still subsisting, the second tercer has only right to a third of the two thirds that remain unaffected by the first terce. But upon the death of the first widow, whereby the lands are disburdened of her terce, the lesser terce becomes enlarged, as if the first had never existed. A widow, who has accepted of a special provision from her husband, is thereby excluded from the terce, unless such provision shall contain a clause that she shall have right to both.

27. The widow has no title of possession, and so cannot receive the rents in virtue of her terce, till she be served to it; and in order to this, she must obtain a brief out of the chancery, directed to the Sheriff, who calls an inquest, to take proof that she was wife to the deceased; and that the deceased died intestate in the subjects contained in the brief. The service or sentence of the jury, finding these points proved, does, without the necessity of a retour to the chancery, intitle the wife to enter into the possession; but she can only possess with the heir *pro indiviso*, and so cannot remove tenants, till the sheriff kens her to her terce, or divides the lands between her and the heir. In this division, after determining by lot or kaval, whether to begin by the sun or the shade, *i. e.* by the east or the west, the sheriff sets off the two first acres for the heir, and the third for the widow. Sometimes the division is executed, by giving one entire farm to the widow, and two of equal value to the heir. The widow's right is not properly constituted by this service; it was constituted before, by the husband's seisin, and fixed by his death; the service only declares it, and so intitles her to the third part of the rents *retro* to her husband's death, preferable to any rights that may have affected the lands in the intermediate period between that and her own service. The relict, if she was reputed to be lawful wife to the deceased, must be served, notwithstanding any objections by the heir against the marriage, which may be afterwards tried by the commissary.

28. Courtesy is a liferent given by law, to the surviving husband, of all his wife's heritage in which she died intestate, if there was a child of the marriage born alive. A marriage, though of the longest continuance, gives no right to the courtesy, if there was no issue of it. The child born of the marriage must be the mother's heir: If she had a child of a former marriage, who is to succeed to her estate, the husband has no right to the courtesy while such child is alive: so that the courtesy is due to the husband, rather as father to an heir, than as husband to an heiress. Heritage is here opposed to conquest, and so is to be understood only of the heritable rights to which the wife succeeded as heir to her ancestors, excluding what she herself had acquired by singular titles.

29. Because the husband enjoys the liferent of his wife's whole heritage, on a lucrative title, he is considered as her temporary representative, and so is liable in payment of all the yearly burdens chargeable on the subject, and of the current interest of all her debts, real and personal, to the value of the yearly rent he enjoys by the courtesy. The courtesy needs no solemnity to its constitution: That right, which the husband had to the rents of his wife's estate, during the marriage, *jure mariti*, is continued with him after her death, under the name of

courtesy, by an act of the law itself. As in the terce, the husband's seisin is the ground and measure of the wife's right; so in the courtesy, the wife's seisin is the foundation of the husband's; and the two rights are, in all other respects, of the same nature; if it is not that the courtesy extends to burgage-holdings, and to superiorities.

30. All liferenters must use their right *salva rei substantia*: Whatever therefore is part of the fee itself, cannot be encroached on by the liferenter, *e. g.* woods or growing timber, even for the necessary uses of the liferented tenement. But, where a coppice or *silva cadua* has been divided into hags, one of which was in use to be cut annually by the proprietor, the liferenter may continue the former yearly cuttings; because these are considered as the annual fruits the subject was intended to yield, and so the proper subject of a liferent.

31. Liferenters are bound to keep the subject liferented in proper repair. They are also burdened with the alimony of the heir, where he has not enough for maintaining himself. The bare right of apparency founds the action against the liferenter. It is a burden personal to the liferenter himself, and cannot be thrown upon his adjudging creditors, as coming in his place by their diligences. Liferenters are also subjected to the payment of the yearly cesses, stipends, &c. falling due during their right, and to all other burdens that attend the subject liferented.

32. Liferent is extinguished by the liferenter's death. That part of the rents which the liferenter had a proper right to, before his death, falls to his executors; the rest, as never having been *in bonis* of the deceased, goes to the fiar. Martinmas and Whitfunday are, by our custom, the legal terms of the payment of rent: Consequently, if a liferenter of lands survives the term of Whitfunday, his executors are intitled to the half of that year's rent, because it was due the term before his death; and if he survives the Martinmas, they have right to the whole. If the liferenter, being in the natural possession, and having first sowed the ground, should die, even before the Whitfunday, his executors are intitled to the whole crop, in respect that both seed and industry were his. In a liferent of money constituted by a moveable bond, the executors have a right to the interest, down to the very day of the liferenter's death, where no terms are mentioned for the payment thereof; but in the case of an heritable bond, or of a money liferent secured on land, the interests of liferenter and fiar (or of heir and executor, for the same rules serve to fix the interests of both) are both governed by the legal terms of land-rent, without regard to the conventional.

#### Tit. 17. Of Teinds.

T. TEINDS, or tithes, are that liquid proportion of our rents or goods, which is due to churchmen, for performing divine service, or exercising the other spiritual functions proper to their several offices. Most of the canonists affirm, that the precise proportion of a tenth, not only of the fruits of the ground, but of what is acquired by personal industry, is due to the Christian clergy, of divine right, which they therefore call the proper patrimony.

trimony of the church; though it is certain that tithes, in their infancy, were given, not to the clergy alone, but to lay-monks who were called *pauperes*, and to other indigent persons. Charles the Great was the first secular Prince who acknowledged this right in the church. It appears to have been received with us, as far back as David I.

2. The person employed by a cathedral church or monastery to serve the cure in any church annexed, was called a vicar, because he held the church, not in his own right, but in the right or *vice* of his employers; and so was removeable at pleasure, and had no share of the benefice, other than what they thought fit to allow him: But, in the course of time, the appellation of vicar was limited to those who were made perpetual, and who got a stated share of the benefice for their incumbency; from whence arose the distinction of benefices into parsonages and vicarages.

3. Parsonage-teinds are the teinds of corn; and they are so called because they are due to the parson or other titular of the benefice. Vicarage-teinds are the small teinds of calves, lint, hemp, eggs, &c. which were commonly given by the titular to the vicar who served the cure in his place. The first sort was universally due, unless in the case of their infeudation to laics, or of a pontifical exemption; but, by the customs of almost all Christendom, the lesser teinds were not demanded where they had not been in use to be paid. By the practice of Scotland, the teinds of animals, or of things produced from animals, as lambs, wool, calves, are due though not accustomed to be paid; but roots, herbs, &c. are not tithable, unless use of payment be proved: neither are personal teinds, *i. e.* the tenth of what one acquires by his own industry, acknowledged by our law; yet they have been found due, when supported by 40 years possession.

4. The parson who was entitled to the teind of corns, made his right effectual either by accepting of a certain number of teind-bolls yearly from the proprietor, in satisfaction of it; or more frequently, by drawing or separating upon the field his own tenth part of the corns, after they were reaped, from the stock or the remaining nine tenths of the crop, and carrying it off to his own granaries; which is called drawn teind.

5. After the reformation, James VI. considered himself as proprietor of all the church-lands; partly because the purposes for which they had been granted were declared superstitious; and partly, in consequence of the resignations which he, and *Q. Mary* his mother, had procured from the beneficiaries: and even as to the teinds, though our reformed clergy also claimed them as the patrimony of the church, our sovereign did not submit to that doctrine farther than extended to a competent provision for ministers. He therefore erected or secularised several abbeys and priories into temporal lordships; the grantees of which were called sometimes lords of erection, and sometimes titulars, as having by their grants the same title to the erected benefices, that the monasteries had formerly.

6. As the Crown's revenue suffered greatly by these erections, the temporality of all church-benefices (*i. e.*

church lands) was, by 1587, *c.* 29. annexed to the crown. That statute excepts from the annexation such benefices as were established before the reformation in laymen, whose rights the legislature had no intention to weaken. Notwithstanding this statute, his Majesty continued to make farther erections, which were declared null by 1592, *c.* 119. with an exception of such as had been made in favour of lords of parliament, since the general act of annexation in 1587.

7. *K. Charles I.* soon after his succession, raised a reduction of all these erections, whether granted before or after the act of annexation, upon the grounds mentioned at length by Mr Forbes in his treatise of tithes, p. 159. At last the whole matter was referred to the King himself by four several submissions or compromises, in which the parties on one side were the titulars and their tacksmen, the bishops with the inferior clergy, and the royal boroughs, for the interest they had in the teinds that were gifted for the provision of ministers, schools, or hospitals within their boroughs; and, on the other part, the proprietors who wanted to have the leading of their own teinds. The submission by the titulars contained a surrender into his Majesty's hands of the superiorities of their several erections.

8. Upon each of these submissions his Majesty pronounced separate decrees-arbitral, dated Sept. 2. 1629, which are subjoined to the acts of parliament of his reign. He made it lawful for proprietors to sue the titulars for a valuation, and if they thought fit for a sale also, of their teinds, before the commissioners named or to be named for that purpose. The rate of teind, when it was possessed by the proprietor jointly with the stock, for payment of a certain duty to the titular; and so did not admit a separate valuation, was fixed at a fifth part of the constant yearly rent, which was accounted a reasonable *surrogatum*, in place of a tenth of the increase. Where it was drawn by the titular, and consequently might be valued separately from the stock, it was to be valued as its extent should be ascertained upon a proof before the commissioners; but in this last valuation, the King directed the fifth part to be deducted from the proved teind, in favour of the proprietor, which was therefore called the King's case: The proprietor suing for a valuation gets the leading of his own teinds as soon as his suit commences; providing he does not allow protestation to be extracted against him for not insisting.

9. Where the proprietor insisted also for a sale of his teinds, the titular was obliged to sell them at nine years purchase of the valued teind-duty. If the pursuer had a tack of his own teinds, not yet expired; or if the defender was only tacksmen of the teinds, and so could not give the pursuer an heritable right; an abatement of the price was to be granted accordingly by the commissioners.

10. There is no provision in the decrees-arbitral, for selling the teinds granted for the sustentation of ministers, universities, schools or hospitals; because these were to continue, as a perpetual fund, for the maintenance of the persons or societies to whom they were appropriated; and they are expressly declared not subject to sale, by 1690, *c.* 30.—1693, *c.* 23. By the last of these acts, it is also provided

vided, that the teinds belonging to bishops, which had then fallen to the crown, upon the abolishing of episcopacy, should not be subject to sale as long as they remained with the Crown not disposed of; nor those which the proprietor, who had right both to stock and teind, reserved to himself, in a sale or feu of the lands. But, though none of these teinds can be sold, they may be valued.

11. The King by the decrees arbitral, declared his own right to the superiorities of erection which had been resigned to him by the submission, reserving to the titulars the feu-duties thereof, until payment by himself to them of one thousand merks Scots for every chaldier of feu-victual, and for each hundred merks of feu-duty, which right of redeeming the feu-duties was afterwards renounced by the Crown. If the church-vassal should consent to hold his lands of the titular, he cannot thereafter recur to the Crown as his immediate superior.

12. In explaining what the constant rent is, by which the teind must be valued, the following rules are observed. The rent drawn by the proprietor, from the sale of subjects, that are more properly parts of the land than of the fruits, *e. g.* quarries, minerals, mosses, &c. is to be deducted from the rental of the lands; and also the rent of supernumerary houses, over and above what is necessary for agriculture; and the additional rent that may be paid by the tenant, in consideration of the proprietor's undertaking any burden that law imposes on the tenant, *e. g.* upholding the tenant's houses, because none of these articles are paid properly on account of the fruits. Orchards must also be deducted, and mill-rent, because the profits of a mill arise from industry; and the corns manufactured there suffer a valuation, as rent payable by the tenant; and therefore ought not to be valued a second time against the titular as mill-rent. The yearly expence of culture ought not to be deducted; for no rent can be produced without it: But, if an improvement of rent is made at an uncommon expence, *e. g.* by draining a lake, the proprietor is allowed a reasonable abatement on that account.

13. Notwithstanding the several ways of misapplying parochial teinds in the times of popery, some few benefices remained entire in the hands of the parsons. The ministers planted in these, after the reformation, continued to have the full right to them, as proper beneficiaries; but a power was afterwards granted to the patron, to redeem the whole teind from such beneficiaries, upon their getting a competent stipend modified to them; which teind so redeemed, the patron is obliged to sell to the proprietor, at six years purchase.

14. Some teinds are more directly subject to an allocation for the minister's stipend, than others. The teinds, in the hands of the lay titular, fall first to be allocated, who, since he is not capable to serve the cure in his own person, ought to provide one who can; and if the titular, in place of drawing the teind, has set it in tack, the tack-duty is allocated: This sort is called free teind. Where the tack-duty, which is the titular's interest in the teinds, falls short, the tack itself is burdened, or, in other words, the surplus teind over and above the tack-duty: But, in this case, the commissioners are empowered to recompense

the tacksmen, by prorogating his tack for such a number of years as they shall judge equitable. Where this likewise proves deficient, the allocation falls on the teinds, heritably conveyed by the titular, unless he has warranted his grant against future augmentations; in which case, the teinds of the lands belonging in property to the titular himself must be allocated in the first place.

15. Where there is sufficiency of free teinds in a parish, the titular may allocate any of them he shall think fit for the minister's stipend, since they are all his own; unless there has been a previous decree of locality: And this holds, though the stipend should have been paid immemorably out of the teinds of certain particular lands. This right was frequently abused by titulars, who, as soon as a proprietor had brought an action of sale of his teinds, allocated the pursuer's full teind for the stipend, whereby such action became ineffectual: It was therefore provided, that after citation in a sale of teinds it shall not be in the titular's power to allocate the pursuer's teinds solely, but only in proportion with the other teinds in the parish.

16. Ministers glebes are declared free from the payment of teind. Lands *cum decimis inclusis* are also exempted from teind. But in order to exempt lands from payment of teind, it is necessary that the proprietor prove his right thereto, *cum decimis inclusis*, as far back as the above act of annexation 1587.

17. Teinds are *debita fructuum*, not *fundi*. The action therefore for bygone teinds is only personal, against those who have intermeddled, unless where the titular is infest in the lands, in security of the valued teind-duty. Where a tenant is, by his tack, bound to pay a joint duty to his landlord for stock and teind, without distinguishing the rent of each, his defence of a *bona fide* payment of the whole to the landlord has been sustained in a suit at the instance of a laic titular, but repelled where a churchman was pursuer. In both cases the proprietor who receives such rent is liable as intermeddler.

18. In tacks of teinds, as of lands, there is place for tacit relocation; to stop the effect of which, the titular must obtain and execute an inhibition of teinds against the tacksmen, which differs much from inhibition of lands (explained under the next title), and is intended merely to interpel or inhibit the tacksmen from farther intermeddling. This diligence of inhibition may also be used at the suit of the titular, against any other possessor of the teinds; and if the tacksmen or possessor shall intermeddle after the inhibition is executed, he is liable in a *spuilzie*.

19. Lands and teinds pass by different titles: A disposition of lands therefore, though granted by one who has also right to the teind, will not carry the teind, unless it shall appear from special circumstances that a sale of both was designed by the parties. In lands *cum decimis inclusis*, where the teinds are consolidated with the stock, the right of both must necessarily go together in all cases.

#### Tit. 18. Of Inhibitions.

THE constitution and transmission of feudal rights being explained,

explained, and the Surdens with which they are chargeable, it remains to be considered, how these rights may be affected at the suit of creditors, by legal diligence. Diligences are certain forms of law, whereby a creditor endeavours to make good his payment, either by affecting the person of his debtor, or by securing the subjects belonging to him from alienation, or by carrying the property of these subjects to himself. They are either real or personal. Real diligence is that which is proper to heritable or real rights; personal, is that by which the person of the debtor may be secured, or his personal estate affected. Of the first sort we have two, *viz.* Inhibition and Adjudication.

2. Inhibition is a personal prohibition, which passes by letters under the signet, prohibiting the party inhibited to contract any debt, or do any deed, by which any part of his lands may be aliened or carried off, in prejudice of the creditor inhibiting. It must be executed against the debtor, personally, or at his dwelling house, as summonses, and thereafter published and registred in the same manner with interdictions, (see Tit. vii. 30.)

3. Inhibition may proceed, either upon a liquid obligation, or even on an action commenced by a creditor for making good a claim not yet sustained by the judge; which last is called inhibition upon a depending action. The summons, which constitutes the dependance, must be executed against the debtor before the letters of inhibition pass the signet; for no suit can be said to depend against one, till he be cited in it as a defender: But the effect of such inhibition is suspended, till decree be obtained in the action against the debtor; and in the same manner, inhibitions on conditional debts have no effect, till the condition be purified. Inhibitions are not granted, without a trial of the cause, when they proceed on conditional debts. And though, in other cases, inhibitions now pass of course, the Lords are in use to stay, or recal them, either on the debtor's shewing cause why the diligence should not proceed, or even *ex officio* where the ground of the diligence is doubtful.

4. Though inhibitions, by their uniform style, disable the debtor from selling his moveable as well as his heritable estate, their effect has been long limited to heritage, from the interruption that such an embargo upon moveables must have given to commerce; so that debts contracted after inhibition may be the foundation of diligence, against the debtor's person and moveable estate. An inhibition secures the inhibitor against the alienation, not only of the lands that belonged to his debtor when he was inhibited, but of those that he shall afterwards acquire; but no inhibition can extend to such after-purchases as lie in a jurisdiction where the inhibition was not registred; for it could not have extended to these, tho' they had been made prior to the inhibition.

5. This diligence only strikes against the voluntary debts or deeds of the inhibited person: It does not restrain him from granting necessary deeds, *i. e.* such as he was obliged to grant anterior to the inhibition, since he might have been compelled to grant these before the inhibitor had acquired any right by his diligence. By this rule, a wadsetter or annualrenter might, after being inhibited, have effectually renounced his right to the reverser on

payment, because law could have compelled him to it; but to secure inhibitors against the effect of such alienations, it is declared by act of sederunt of the court of Session, Feb. 19. 1680, that, after intimation of the inhibition to the reverser, no renunciation or grant of redemption shall be sustained, except upon declarator of redemption brought by him, to which the inhibitor must be made a party.

6. An inhibition is a diligence simply prohibitory, so that the debt, on which it proceeds, continues personal after the diligence; and consequently, the inhibitor, in a question with anterior creditors whose debts are not struck at by the inhibition, is only preferable from the period at which his debt is made real by adjudication: And where debts are contracted on heritable security, though posterior to the inhibition, the inhibitor's debt, being personal, cannot be ranked with them; he only draws back from the creditors ranked the sums contained in his diligence. The heir of the person inhibited is not restrained from alienation, by the diligence used against his ancestor; for the prohibition is personal, affecting only the debtor against whom the diligence is used.

7. Inhibitions do not, of themselves, make void the posterior debts or deeds of the person inhibited; they only afford a title to the user of the diligence to set them aside, if he finds them hurtful to him: And even where a debt is actually reduced *ex capite inhibitionis*, such reduction, being founded solely in the inhibitor's interest, is profitable to him alone, and cannot alter the natural preference of the other creditors.

8. Inhibitions may be reduced, upon legal nullities, arising either from the ground of debt, or the form of diligence. When payment is made by the debtor to the inhibitor, the inhibition is said to be purged. Any creditor, whose debt is struck at by the inhibition, may, upon making payment to the inhibitor, compel him to assign the debt and diligence in his favour, that he may make good his payment the more effectually against the common debtor.

#### Tit. 19. Of Comprisings, Adjudications, and Judicial Sales.

HERITABLE rights may be carried from the debtor to the creditor, either by the diligence of apprising (now adjudication), or by a judicial sale carried on before the court of Session. Apprising, or comprising, was the sentence of a sheriff, or of a messenger who was specially constituted sheriff for that purpose, by which the heritable rights belonging to the debtor were sold for payment of the debt due to the appriser; so that apprisings were, by their original constitution, proper sales of the debtor's lands, to any purchaser who offered. If no purchaser could be found, the sheriff was to apprise or tax the value of the lands by an inquest, (whence came the name of apprising), and to make over to the creditor lands to the value of the debt.

2. That creditors may have access to affect the estate of their deceased debtor, though the heir should stand off from entering, it is made lawful (by 1540, c. 106.) for any creditor to charge the heir of his debtor to enter to his ancestor,

year

year and day being past after the ancestor's death, within forty days after the charge; and, if the heir fails, the creditor may proceed to apprise his debtor's lands, as if the heir had been entered. Custom has so explained this statute, that the creditor may charge the heir, immediately after the death of his ancestor, provided letters of apprising be not raised till after the expiry both of the year and of the forty days next ensuing the year, within which the heir is charged to enter. But this statute relates only to such charges on which apprising is to be led against the ancestor's lands; for, in those which are to be barely the foundation of a common summons or process against the heir, action will be sustained if the year be elapsed from the ancestor's death before the execution of the summons, though the forty days should not be also expired. Though the statute authorises such charges against majors only, practice has also extended it against minors, and the rule is extended to the case where the heir is the debtor. One must, in this matter, distinguish between a general and a special charge. A general charge serves only to fix the representation of the heir who is charged, so as to make the debt his, which was formerly his ancestor's: But a special charge makes up for the want of a service, explained Tit. xxvii. 25. and states the heir, *fictione juris*, in the right of the subjects to which he is charged to enter. Where therefore the heir is the debtor, a general charge for fixing the representation against him is unnecessary. since the only concern of the creditor is, that his debtor make up titles to the ancestor's estate, which is done by a special charge: But where the deceased was the debtor, the creditor must first charge his heir to enter in general, that it may be known whether he is to represent the debtor; if he does not enter within forty days, the debt may be fixed against him by a decree of constitution, on which he must be charged to enter heir in special, upon forty days more; and these must be elapsed before the creditor can proceed to apprise.

3. Apprisings in course of time underwent several changes in their form and effect, till at length, by act 1672, c. 19. adjudications were substituted in their place, which directed to proceed against debtors by way of action before the court of Session. By that statute, such part of the debtor's lands is to be adjudged as is equivalent to the principal sum and interest of the debt, with the composition due to the superior and expences of infestment; and a fifth part more in respect the creditor is obliged to take land for his money. The debtor must deliver to the creditor a valid right of the lands to be adjudged, or transumps thereof, renounce the possession in his favour, and ratify the decree of adjudication: And law considers the rent of the lands as precisely commensurated to the interest of the debt; so that the adjudger lies under no obligation to account for the surplus rents. In this, which is called a special adjudication, the legal or time within which the debtor may redeem, is declared to be five years; and the creditor attaining possession upon it can use no farther execution against the debtor, unless the lands be evicted from him.

4. Where the debtor does not produce a sufficient right to the lands, or is not willing to renounce the pos-

session, and ratify the decree, (which is the case that has most frequently happened), the statute makes it lawful for the creditor to adjudge all right belonging to the debtor in the same manner, and under the same reversion of ten years, as he could, by the former laws, have apprised it. In this last kind, which is called a general adjudication, the creditor must limit his claim to the principal sum, interest, and penalty, without demanding a fifth part more. But no general adjudication can be insisted on, without libelling in the summons the other alternative of a special adjudication; for special adjudications are introduced by the statute in the place of apprisings; and it is only where the debtor refuses to comply with the terms thereof that the creditor can lead a general adjudication.

5. Abbreviates are ordained to be made of all adjudications, which must be recorded within sixty days after the date of the decree. In every other respect, general adjudications have the same effects that apprisings had; adjudgers in possession are accountable for the surplus rents; a citation in adjudications renders the subject litigious; superiors are obliged to enter adjudgers; the legal of adjudications does not expire during the debtor's minority, &c. Only it may be observed, that though apprisings could not proceed before the term of payment, yet where the debtor is *vergens ad inopiam*, the court *ex nobili officio* admit adjudication for the debt before it be payable. But this sort being founded solely in equity, subsists merely as a security, and cannot carry the property to the creditor by any length of time.

6. There are two kinds of adjudication, which took place at the same time with apprisings, and still obtain; viz. adjudications on a decree *cognitionis causa*, otherwise called *contra hereditatem jacentem*, and adjudications in implement. Where the debtor's apparent heir, who is charged to enter, formally renounces the succession, the creditor may obtain a decree *cognitionis causa*; in which, though the heir renouncing is cited for the sake of form, no sentence condemnatory can be pronounced against him, in respect of his renunciation; the only effect of it is to subject the *hereditas jacens* to the creditor's diligence.

7. Adjudications *contra hereditatem jacentem*, carry not only the lands themselves that belonged to the deceased, but the rents thereof fallen due since his death; for these, as an accessory to the estate belonging to the deceased, would have descended to the heir if he had entered, which rule is applied to all adjudications led on a special charge. This sort of adjudication is declared redeemable within seven years, by any co-adjudging creditor, either of the deceased debtor, or of the heir renouncing: The heir himself, who renounces, cannot be restored against his renunciation, nor consequently redeem, if he be not a minor. But even a major may redeem indirectly, by granting a simulate bond to a confident person; the adjudication upon which, when conveyed to himself, is a good title to redeem all other adjudications against the lands belonging to his ancestor.

8. Adjudications in implement are deduced against those who have granted deeds without procuratory of resignation or precept of seisin, and refuse to divest themselves;



to the end that the subject conveyed may be effectually vested in the grantee. These adjudications may be also directed against the heir of the grantor, upon a charge to enter. Here there is no place for a legal reversion; for, as the adjudication is led for completing the right of a special subject, it must carry that subject as irredeemably as if the right had been voluntarily completed.

9. All adjudications led within year and day of that one which has been made first effectual by seisin (where seisin is necessary) or exact diligence for obtaining seisin, are preferable *pari passu*. The year and day runs from the date of the adjudication, and not of the seisin or diligence for obtaining it. After the days of that period, they are preferable according to their dates. All the co-adjudgers within the year are preferable *pari passu* as if one adjudication had been led for all their debts. This makes the seisin or diligence on the first adjudication a common right to the rest, who must therefore be refund to the owner of that diligence his whole expence laid out in carrying on and completing it. And though that first adjudication should be redeemed, the diligence upon it still subsists as to the rest. This *pari passu* preference, however, does not destroy the legal preference of adjudications led on *debita fundi*. See Tit. xv. 15. Nor does it take place in adjudications in implement.

10. Before treating of judicial sales of bankrupts estates, the nature of sequestration may be shortly explained, which is a diligence that generally ushers in actions of sale. Sequestration of lands is a judicial act of the court of Session, whereby the management of an estate is put into the hands of a factor or steward named by the court, who gives security, and is to be accountable for the rents to all having interest. This diligence is competent, either where the right of the lands is doubtful, if it be applied for before either of the competitors has attained possession; or where the estate is heavily charged with the debts: But, as it is an unfavourable diligence, it is not admitted, unless that measure shall appear necessary for the security of creditors. Subjects, not brought before the court by the diligence of creditors, cannot fall under sequestration; for it is the competition of creditors which alone founds the jurisdiction of the court to take the disputed subject into their possession.

11. The court of Session who decrees the sequestration has the nomination of the factor, in which they are directed by the recommendation of the creditors. A factor appointed by the Session, though the proprietor had not been in seisin in the lands, has a power to remove tenants. Judicial factors must, within six months after extracting their factory, make up a rental of the estate, and a list of the arrears due by tenants, to be put into the hands of the clerk of the process, as a charge against themselves, and a note of such alterations in the rental as may afterwards happen; and must also deliver to the clerk annually a scheme of their accounts, charge and discharge, under heavy penalties. They are, by the nature of their office, bound to the same degree of diligence that a prudent man adhibits in his own affairs; they are accountable for the interest of the rents, which they either have, or by diligence might have recovered, from a year after their falling due. As it is much in the power of those factors to

take advantage of the necessities of creditors, by purchasing their debts at an undervalue, all such purchases made either by the factor himself, or to his behoof, are declared equivalent to an acquittance or extinction of the debt. No factor can warrantably pay to any creditor, without an order of the court of Session; for he is, by the tenor of his commission, directed to pay the rents to those who shall be found to have best right to them. Judicial factors are intitled to a salary, which is generally stated at five *per cent.* of their intromissions; but it is seldom ascertained till their office expires, or till their accounting; that the court may modify a greater or smaller salary, or none, in proportion to the factor's integrity and diligence. Many cases occur, where the court of Session, without sequestration, name a factor to preserve the rents from perishing; *e. g.* where an heir is deliberating whether to enter, where a minor is without tutors, where a succession opens to a person residing abroad; in all which cases, the factor is subjected to the rules laid down in act of sederunt, Feb. 13. 1730. \*

12. The word *bankrupt* is sometimes applied to persons whose funds are not sufficient for their debts; and sometimes, not to the debtor, but to his estate. The court of Session are empowered, at the suit of any real creditor, to try the value of a bankrupt's estate, and sell it for the payment of his debts.

13. No process of sale, at the suit of a creditor, can proceed without a proof of the debtor's bankruptcy, or at least that his lands are so charged with debts, that no prudent persons will buy from him; and therefore the summons of sale must comprehend the debtor's whole estate. The debtor, or his apparent heir, and all the real creditors in possession, must be made parties to the suit; but it is sufficient if the other creditors be called by an edictal citation. The summons of sale contains a conclusion of ranking or preference of the bankrupt's creditors. In this ranking, first and second terms are assigned to the whole creditors for exhibiting in court (or producing) their rights and diligences; and the decree of certification proceeding thereupon, against the writings not produced, has the same effect in favour of the creditors who have produced their rights, as if that decree had proceeded upon an action of reduction-improbation. See Tit. xxx. 5. The ranking of these creditors must be concluded by an extracted decree, before the actual sale. The irredeemable property of the lands is adjudged by the court to the highest offerer at the sale. The creditors receiving payment must grant to the purchaser absolute warrandice, to the extent of the sum received by them; and the lands purchased are declared disburdened of all debts or deeds of the bankrupt, or his ancestors, either on payment of the price by the purchaser to the creditors according to their preference, or on consignation of it, in case of their refusal, in the hands of the magistrates of Edinburgh: The only remedy provided to such creditors as judge themselves hurt by the sale of division of the price, even though they should be minors, is an action for recovering their share of the price against the creditors who have received it.

14. The expence of these processes is disbursed by the factor out of the rents in his hands; by which the  
 whose

whole burden of such expence falls upon the posterior creditors.

15. Apparent heirs are intitled to bring actions of sale of the estates belonging to their ancestors, whether bankrupt or not; the expence of which ought to fall upon the pursuer, if there is any excess of the price, after payment of the creditors.

16. As processes of ranking and sale are designed for the common interest of all the creditors, no diligence carried on or completed during their pendency ought to give any preference in the competition; *pendente lite, nihil innovandum*.

17. It is a rule in all real diligences, that where a creditor is preferable on several different subjects, he cannot use his preference arbitrarily, by favouring one creditor more than another; but must allocate his universal or catholic debt proportionally against all the subjects or parties whom it affects. If it is material to such creditor to draw his whole payment out of any one fund, he may apply his debt so as may best secure himself; but that inequality will be rectified, as to the posterior creditors, who had likewise, by their rights and diligences, affected the subjects out of which he drew his payment, by obliging him to assign in their favour his right upon the separate subjects which he did not use in the ranking; by which they may recur against these separate subjects for the shares which the debt preferred might have drawn out of them. As the obligation to assign is founded merely in equity, the catholic creditor cannot be compelled to it; if his assigning shall weaken the preference of any separate debt vested in himself, affecting the special subject sought to be assigned. But if a creditor upon a special subject shall acquire from another a catholic right, or a catholic creditor shall purchase a debt affecting a special subject, with a view of creating to the special debt a higher degree of preference than was naturally due to it, by an arbitrary application of the catholic debt, equity cannot protect him from assigning in favour of the creditor excluded by such application, especially if, prior to the purchase, the subject had become litigious by the process of ranking; for transmissions ought not to hurt creditors who are no parties to them, nor to give the purchaser any new right, which was not formerly in himself or his cedent.

#### Tit. 20. Of Obligations and Contracts in general.

THE law of heritable rights being explained, moveable rights fall next to be considered, the doctrine of which depends chiefly on the nature of Obligations. An obligation is a legal tie, by which one is bound to pay or perform something to another. Every obligation on the person obliged, implies an opposite right in the creditor, so that what is a burden in regard to the one is right with respect to the other; and all rights founded on obligation are called personal. There is this essential difference between a real and a personal right, that a *jus in re*, whether of property, or of an inferior kind as servitude, entitles the person vested with it to possess the subject as his own; or if he is not in possession, to demand it from the possessors; whereas the creditor in a personal right

has only *jus ad rem*, or a right to compel the debtor to fulfil his obligation; without any right in the subject itself, which the debtor is bound to transfer to him. One cannot oblige himself, but by a present act of the will. A bare resolution therefore, or purpose to be obliged; is alterable at pleasure.

2. Obligations are either, first, merely natural, where one person is bound to another by the law of nature, but cannot be compelled by any civil action to the performance. Thus, though deeds granted by a minor having curators, without their consent, are null, yet the minor is naturally obliged to perform such deeds; and parents are naturally obliged to provide their children in reasonable patrimonies. Natural obligations intitle the creditor to retain what he has got in virtue thereof, without being subjected to restore it. 2. Obligations are merely civil, which may be sued upon by an action; but are elided by an exception in equity; this is the case of obligations granted through force or fear, &c. 3. Proper or full obligations, are those which are supported both by equity and the civil sanction.

3. Obligations may be also divided into, 1. Pure, to which neither day nor condition is adjoined. These may be exacted immediately. 2. Obligations (*ex die*), which have a day adjoined to their performance. In these, *dies statem cedit, sed non venit*; a proper debt arises from the date of the obligation, because it is certain that the day will exist; but the execution is suspended, till the lapse of that day. 3. Conditional obligations; in which there is no proper debt (*dies non cedit*) till the condition be purified, because it is possible the condition may exist; and which therefore are said to create only the hope of a debt; but the granter, even of these, has no right to refuse. An obligation, to which a day is adjoined that possibly may never exist, implies a condition; *dies incertus pro conditione habetur*. Thus, in the case of a provision to a child, payable when he attains to the age of fourteen, if the child dies before that age, the provision falls.

4. Obligations, when considered with regard to their cause, were divided by the Romans, into those arising from contract, quasi contract, delict, and quasi-delict: But there are certain obligations, even full and proper ones, which cannot be derived from any of these sources, and to which Lord Stair gives the name of obdiential. Such as the obligation on parents to aliment or maintain their children; which arises singly from the relation of parent and child, and may be enforced by the civil magistrate. Under parents are comprehended the mother, grandfather, and grandmother, in their proper order. This obligation on parents extends to the providing of their issue in all the necessaries of life, and giving them suitable education. It ceases, when the children can earn a livelihood by their own industry; but the obligation on parents to maintain their indigent children, and reciprocally on children to maintain their indigent parents, is perpetual. This obligation is, on the father's death, transferred to the eldest son, the heir of the family; who, as representing the father, must aliment his younger brothers and sisters: The brothers are only intitled to alimony, till their age of twenty-one, after which they are presumed able to do for themselves; but the obligation to

to maintain the sisters continues till their marriage. In persons of lower rank, the obligation to aliment the sisters ceases after they are capable of subsisting by any service or employment.

5. All obligations, arising from the natural duty of restitution, fall under this class: Thus, things given upon the view of a certain event, must be restored, if that event does not afterwards exist: Thus also, things given *ob turpem causam*, where the turpitude is in the receiver and not in the giver, must be restored. And on the same principle, one upon whose ground a house is built or repaired by another, is obliged, without any covenant, to restore the expence laid out upon it, in so far as it has been profitable to him.

6. A contract is the voluntary agreement of two or more persons, whereby something is to be given or performed upon one part, for a valuable consideration, either present or future, on the other part. Consent, which is implied in agreement, is excluded, 1. By error in the essentials of the contract, for in such case, the party does not properly contract, but errs or is deceived; Add this may be also applied to contracts which take their rise from fraud or imposition. 2. Consent is excluded by such a degree of restraint upon any of the contracting parties, as extorts the agreement; for where violence or threatening are used against a person, his will has really no part in the contract.

7. Loan or *mutuum* is that contract which obliges a person, who has borrowed any fungible subject from another, to restore to him as much of the same kind, and of equal goodness. Whatever receives its estimation in number, weight, or measure, is a fungible, as corn, wine, current coin, &c. The only proper subjects of this contract are things which cannot be used, without either their extinction or alienation; hence, the property of the thing lent is necessarily transferred by delivery to the borrower, who consequently must run all the hazards, either of its deterioration or its perishing, according to the rule, *res perit suo domino*. Where the borrower neglects to restore, at the time and place agreed on, the estimation of the thing lent must be made according to its price at that time and in that place; because it would have been worth so much to the lender, if the obligation had been duly performed. If there is no place nor time stipulated for, the value is to be stated according to the price that the commodity gave when and where it was demanded. In the loan of money, the value put on it by public authority, and not its intrinsic worth, is to be considered. This contract is obligatory only on one part; for the lender is subjected to no obligation: The only action therefore that it produces, is pointed against the borrower, that he may restore as much in quantity and quality as he borrowed, together with the damage the lender may have suffered through default of due performance.

8. Commodate is a species of loan, gratuitous on the part of the lender, where the thing lent may be used, without either its perishing or its alienation. Hence, in this sort of loan, the property continues with the lender: the only right the borrower acquires in the subject is its use, after which he must restore the individual thing that

he borrowed: Consequently, if the subject perishes, it perishes to the lender, unless it has perished by the borrower's fault. What degree of fault or negligence makes either of the contracting parties liable to the other in damages, is comprehended under the following rules. Where the contract gives a mutual benefit to both parties, each contracter is bound to admit a middle sort of diligence, such as a man of ordinary prudence uses in his affairs. Where only one of the parties has benefit by the contract, that party must use exact diligence; and the other who has no advantage by it is accountable only for dole, or for gross omissions which the law construes to be dole. Where one employs less care on the subject of any contract which implies an exuberant trust, than he is known to employ in his own affairs, it is considered as dole.

9. By these rules, the borrower in the contract of commodate must be exactly careful of the thing lent, and restore it at the time fixed by the contract, or after that use is made of it for which it was lent: If he puts it to any other use, or neglects to restore it at the time covenanted, and if the thing perishes thereafter, even by mere accident, he is bound to pay the value. On the other part, the lender is obliged to restore to the borrower such of the expences disbursed by him on that subject, as arose from any uncommon accident, but not those that naturally attend the use of it. Where a thing is lent gratuitously, without specifying any time of redelivery, it constitutes the contract of *precarium*, which is revokable at the lender's pleasure, and, being entered into from a personal regard to the borrower, ceases by his death.

10. Deposition is a contract, by which one who has the custody of a thing committed to him (the depositary), is obliged to restore it to the depositor. If a reward is bargained for by the depositary for his care, it resolves into the contract of location. As this contract is gratuitous, the depositary is only answerable for the consequences of gross neglect; but after the deposit is redemanded, he is accountable even for casual misfortune. He is intitled to a full indemnification for the losses he has sustained by the contract, and to the recovery of all sums expended by him on the subject.

11. An obligation arises without formal passion, barely by a traveller's entering into an inn, ship, or stable, and there depositing his goods, or putting up his horses; whereby the innkeeper, shipmaster, or stabler, is accountable, not only for his own facts and those of his servants, (which is an obligation implied in the very exercise of these employments), but of the other guests or passengers; and, indeed, in every case, unless where the goods have been lost *damno fatali*, or carried off by pirates or house-breakers. Not only the masters of ships but their employers, are liable each of them for the share that he has in the ship; but by the present custom of trading nations, the goods brought into a ship must have been delivered to the master or mate, or entered into the ship-books. Carriers fall within the intendment of this law; and practice has extended it to vintners within borough. The extent of the damage sustained by the party may be proved by his own oath *in litem*.

12. Sequestration, whether voluntarily consented to by the parties, or authorized by the judge, is a kind of deposit;

deposit; but as the office of sequestree, to whose care the subject in dispute is committed, is not considered as gratuitous, he cannot throw it up at pleasure, as a common depositary may do; and he is liable in the middle degree of diligence. Confignation of money is also a deposit. It may be made, either where the debt is called in question by the debtor, as in suspensions; or where the creditor refuses to receive his money, as in wadsets, &c. The risk of the configned money lies on the configner, where he ought to have made payment, and not confignation, or has configned only a part; or has chosen for confignatory, a person neither named by the parties nor of good credit. The charger, or other creditor, runs the risk, if he has charged for sums not due, or has without good reason refused payment, by which refusal the confignation became necessary. It is the office of a confignatory, to keep the money in safe custody, till it be called for: If therefore he puts it out at interest, he must run the hazard of the debtor's insolvency; but, for the same reason, though he should draw interest for it, he is liable in none to the configner.

13. Pledge, when opposed to wadset, is a contract, by which a debtor puts into the hands of his creditor a special moveable subject in security of the debt, to be redelivered on payment. Where a security is established by law to the creditor, upon a subject which continues in the debtor's possession, it has the special name of an hypothec. Tradesmen and ship-carpenters have an hypothec on the house or ship repaired, for the materials and other charges of reparation; but not for the expence of building a new ship. Owners of ships have an hypothec on the cargo for the freight, heritors on the fruits of the ground, and landlords on the *investa et illata*, for their rents. Writers also, and agents, have a right of hypothec, or more properly of retention, in their constituent's writings, for their claim of pains and disbursements. A creditor cannot, for his own payment, sell the subject impignorated, without applying to the judge-ordinary for a warrant to put it up to public sale or roup; and to this application the debtor ought to be made a party.

#### Tit. 21. Of Obligations by Word or Writ.

THE appellation of *verbal* may be applied to all obligations to the constitution of which writing is not essential, which includes both real and consensual contracts; but as these are explained under separate titles, obligations by word, in the sense of this rubric, must be restricted, either to promises, or to such verbal agreements as have no special name to distinguish them. Agreement implies the intervention of two different parties, who come under mutual obligations to one another. Where nothing is to be given or performed but on one part, it is properly called a promise, which, as it is gratuitous, does not require the acceptance of him to whom the promise is made. An offer, which must be distinguished from a promise, implies something to be done by the other party; and consequently is not binding on the offeror, till it be accepted, with its limitations or conditions, by him to whom the offer is made; after which, it becomes a proper agreement.

2. Writing must necessarily intervene in all obligations and bargains concerning heritable subjects, though they should be only temporary; as tacks, which, when they are verbal, last but for one year. In these no verbal agreement is binding, though it should be referred to the oath of the party; for, till writing is adhibited, law gives both parties a right to refile, as from an unfinished bargain; which is called *locus penitentiae*. If, upon a verbal bargain of lands, part of the price shall be paid by him who was to purchase, the *interventus rei*, the actual payment of money, creates a valid obligation, and gives a beginning to the contract of sale: And in general, where ever matters are no longer entire, the right to refile seems to be excluded. An agreement, whereby a real right is passed from, or restricted, called *pactum liberatorium*, may be perfected verbally; for freedom is favourable, and the purpose of such agreement is rather to dissolve than to create an obligation. Writing is also essential to bargains made under condition that they shall be reduced into writing; for in such cases, it is *pari contractus*, that, till writing be adhibited, both parties shall have liberty to withdraw. In the same manner, verbal or nuncupative testaments are rejected by our law; but verbal legacies are sustained, where they do not exceed *L. 100 Scots*.

3. Anciently, when writing was little used, deeds were executed by the party appending his seal to them; in presence of witnesses. For preventing frauds that might happen by appending seals to false deeds, the subscription also of the granter was afterwards required, and, if he could not write, that of a notary. As it might be of dangerous consequence, to give full force to the subscription of the parties by initials, which is more easily counterfeited; our practice, in order to sustain such subscription, seems to require a proof, not only that the granter used to subscribe in that way, but that *de facto* he had subscribed the deed in question; at least, such proof is required, if the instrumentary witnesses be still alive.

4. As a further check, it was afterwards provided that all writings carrying any heritable right, and other deeds of importance, be subscribed by the principal parties, if they can subscribe; otherwise, by two notaries, before four witnesses specially designed. The subsequent practice extended this requisite of the designation of the witnesses to the case where the parties themselves subscribed. Custom has construed obligations for sums exceeding *L. 100 Scots*, to be obligations of importance: In a divisible obligation, *ex. gr.* for a sum of money, though exceeding *L. 100*, the subscription of one notary is sufficient, if the creditor restricts his claim to *L. 100*: But, in an obligation indivisible, *e. g.* for the performance of a fact, if it be not subscribed in terms of the statute, it is void. When notaries thus attest a deed, the attestation or docket must specially express that the granter gave them a mandate to sign; nor is it sufficient that this be mentioned in the body of the writing.

5. In every deed, the name of him who writes it, with his dwelling place or other mark of distinction, must be inserted. The witnesses must both subscribe as witnesses, and their names and designations be inserted in the body of the deed: And all subscribing witnesses must know the granter, and either see him subscribe, or hear him

him acknowledge his subscription; otherwise they are declared punishable as accessory to forgery. Deeds, decrees, and other securities, consisting of more than one sheet, may be written by way of book, in place of the former custom of pasting together the several sheets, and signing the joinings on the margin; provided each page be signed by the grantor, and marked by its number; and the testing clause express the number of pages.

6. Instruments of seisin are valid, if subscribed by one notary, before a reasonable number of witnesses; which is extended by practice to instruments of resignation. Two witnesses are deemed a reasonable number to every deed that can be executed by one notary. It is not necessary, that the witnesses to a notarial instrument, or execution, see the notary or messenger sign; for they are called as witnesses to the transaction which is attested, and not to the subscription of the person attesting.

7. A new requisite has been added to certain deeds since the union, for the benefit of the revenue: They must be executed on stamped paper, or parchment, paying a certain duty to the crown. Charters, instruments of resignation, seisins, and retours of lands holden of a subject, are charged with 2 s. 3 d. of duty: Bonds, racks, contracts, and other personal obligations, paid at first 6 d. to which a farther duty of 1 s. has been since added. Bail bonds, bills, testaments, discharges, or acquittances of rent or of interest and judicial deeds, as notarial instruments, bonds of cautionry in suspensions, &c. are excepted.

8. The grantor's name and designation are essential, not properly as solemnities, but because no writing can have effect without them. Bonds were, by our ancient practice, frequently executed without filling up the creditor's name; and they passed from hand to hand, like notes payable to the bearer: But as there was no method for the creditor of a person possessed of these to secure them for his payment, all writings taken blank in the creditor's name are declared null, as covers to fraud; with the exception of indorsations of bills of exchange.

9. Certain privileged writings do not require the ordinary solemnities. 1. Holograph deeds (written by the grantor himself) are effectual without witnesses. The date of no holograph writing, except a bill of exchange, (see next paragr.) can be proved by the grantor's own assertion, in prejudice either of his heir or his creditors, but must be supported by other adminicles. 2. Testaments, if executed where men of skill in business cannot be had, are valid though they should not be quite formal: and let the subject of a testament be ever so valuable, one notary signing for the testator, before two witnesses, is in practice sufficient. Clergymen were frequently notaries before the reformation; and, though they were afterwards prohibited to act as notaries, the case of testaments is excepted; so that these are supported by the attestation of one minister, with two witnesses. 3. Discharges to tenants are sustained without witnesses, from their presumed rusticity, or ignorance in business. 4. Missive letters *in re mercatoria*, commissions, and fitted accounts in the course of trade, and bills of exchange, though they are not holograph, are, from the favour of commerce, sustained without the ordinary solemnities.

10. A bill of exchange is an obligation in the form of a mandate, whereby the drawer or mandant desires him to whom it is directed, to pay a certain sum, at the day and place therein mentioned, to a third party. Bills of exchange are drawn by a person in one country to his correspondent in another; and they have that name, because it is the exchange, or the value of money in one place compared with its value in another, that generally determines the precise extent of the sum contained in the draught. The creditor in the bill is sometimes called the possessor, or *porteur*. As parties to bills are of different countries, questions concerning them ought to be determined by the received custom of trading nations, unless where special statute interposes. For this reason, bills of exchange, though their form admits not of witnesses, yet prove their own dates, in questions either with the heir, or creditors of the debtor; but this doctrine is not extended to inland bills payable to the drawer himself.

11. A bill is valid, without the designation, either of the drawer, or of the person to whom it is made payable: It is enough, that the drawer's subscription appears to be truly his; and one's being possessor of a bill marks him out to be the creditor, if he bears the name given in the bill to the creditor: Nay, though the person drawn on should not be designed, his acceptance presumes that it was he whom the drawer had in his eye. Bills drawn blank, in the creditor's name, fall under the statutory nullity; for though indorsations of bills are excepted from it, bills themselves are not. Not only the person drawn upon must sign his acceptance, but the drawer must sign his draught, before any obligation can be formed against the acceptor: Yet it is sufficient in practice, that the drawer signs, before the bill be produced in judgment; though it should be after the death both of the creditor and acceptor. A creditor in a bill may transmit it to another by indorsation, though the bill should not bear *to his order*; by the same rule that other rights are transmissible by assignation, though they do not bear *to assignees*.

12. The drawer, by signing his draught, becomes liable for the value to the creditor in the bill, in case the person drawn upon either does not accept, or after acceptance does not pay; for he is presumed to have received value from the creditor at giving him the draught, though it should not bear *for value received*: But, if the drawer was debtor to the creditor in the bill before the draught, the bill is presumed to be given towards payment of the debt, unless it expressly bears *for value*. The person drawn upon, if he refuse to accept, while he has the drawer's money in his hands, is liable to him in damages. As a bill presumes value from the creditor, indorsation presumes value from the indorsee; who therefore, if he cannot obtain payment from the acceptor, has recourse against the indorser, unless the bill be indorsed in these words, *without recourse*.

13. Payment of a bill, by the acceptor, acquits both the drawer and him at the hands of the creditor; but it intitles the acceptor, if he was not the drawer's debtor, to an action of recourse against him; and, if he was, to

a ground of compensation. Where the bill does not bear value in the hands of the person drawn upon, it is presumed that he is not the drawer's debtor, and consequently he has recourse against the drawer, *ex mandato*.

14. Bills, when indorsed, are considered as so many bags of money delivered to the onerous indorsee; which therefore carry right to the contents, free of all burdens that do not appear on the bills themselves. Hence, a receipt or discharge, by the original creditor, if granted on a separate paper, does not exempt the acceptor from second payment to the indorsee; hence also, no ground of compensation competent to the acceptor against the original creditor can be pleaded against the indorsee: But, if the debtor shall prove, by the oath of the indorsee, that he paid not the full value for the indorsation, the indorsee is justly considered as but a name; and therefore all exceptions, receivable against the original creditor, will be sustained against him.

15. Bills must be negotiated by the possessor, against the person drawn upon, within a precise time, in order to preserve recourse against the drawer. In bills payable so many days after sight, the creditor has a discretionary power of fixing the payment somewhat sooner or later, as his occasions shall require. Bills payable on a day certain, need not be presented for acceptance till the day of payment, because that day can neither be prolonged nor shortened by the time of acceptance. For the same reason, the acceptance of bills, payable on a precise day, need not be dated: But, where a bill is drawn payable so many days after sight, it must; because there the term of payment depends on the date of the acceptance.

16. Though bills are, in strict law, due the very day on which they are made payable, and may therefore be protested on the day thereafter; yet there are three days immediately following the day of payment, called days of grace, within any of which the creditor may protest the bill: But if he delay protesting till the day after the last day of grace, he loses his recourse. Where a bill is protested, either for not acceptance, or not payment, the dishonour must be notified to the drawer or indorser, within three posts at farthest. This strictness of negotiation is confined to such bills as may be protested by the possessor upon the third day of grace: Where therefore bills are indorsed after the days of grace are expired, the indorsee is left more at liberty, and does not lose his recourse, though he should not take a formal protest for not payment, if, within a reasonable time, he shall give the indorser notice of the acceptor's refusing to pay. Not only does the possessor, who neglects strict negotiation, lose his recourse against the drawer, where the person drawn upon becomes afterwards bankrupt, but though he should continue solvent; for he may, in that case, recover payment from the debtor, and so is not to be indulged in an unnecessary process against the drawer, which he has tacitly renounced by his negligence. Recourse is preserved against the drawer, though the bill should not be duly negotiated, if the person drawn upon was not his debtor; for there the drawer can qualify no prejudice by the neglect of diligence, and he ought not to have drawn on one who owed him nothing.

17. The privileges superadded to bills by statute are, that tho', by their form, they can have no clause of registration, yet, if duly protested, they are registrable within six months after their date in case of not acceptance, or in six months after the term of payment in the case of not payment; which registration is made the foundation of summary diligence, either against the drawer or indorser in the case of not acceptance, or against the acceptor in case of not payment. This is extended to inland bills, *i. e.* bills both drawn and made payable in Scotland. After acceptance, summary diligence lies against no other than the acceptor; the drawer and indorser must be pursued by an ordinary action. It is only the principal sum in the bill, and interest, that can be charged for summarily: The exchange, when it is not included in the draught, the re-exchange incurred by suffering the bill to be protested and returned; and the expence of diligence, must all be recovered by an ordinary action; because these are not liquid debts, and so must be previously constituted.

18. Bills, when drawn payable at any considerable distance of time after date, are denied the privileges of bills; for bills are intended for currency, and not to lie as a security in the creditor's hands. Bills are not valid which appear *ex facie* to be donations. No extrinsic stipulation ought to be contained in a bill which deviates from the proper nature of bills; hence, a bill to which a penalty is adjoined, or with a clause of interest from the date, is null. Inland precepts drawn, not for money the medium of trade, but for fungibles, are null, as wanting writer's name and witnesses. It is not an agreed point whether promissory notes, without writer and witnesses, unless holograph, are probative. This however is certain, that they are intitled to the privileges of bills.

19. As for the solemnities essential to deeds signed in a foreign country, when they come to receive execution in Scotland, it is a general rule, that no laws can be of authority beyond the dominions of the lawgiver. Hence, in strictness, no deed, though perfected according to the law of the place where it is signed, can have effect in another country where different solemnities are required to a deed of that sort. But this rigour is softened *ex comitate*, by the common consent of nations, that all personal obligations granted according to the law of that country where they are signed, are effectual every where, which obtains even in obligations to convey heritage, Conveyances themselves, of heritable subjects, must be perfected according to the law of the country where the heritage lies, and from which it cannot be removed.

20. A writing, while the granter keeps it under his own power or his doer's, has no force; it becomes obligatory, only after it is delivered to the grantee himself, or found in the hands of a third person. As to which last, the following rules are observed. A deed found in the hands of one, who is doer both for the granter and grantee, is presumed to have been put in his hands as doer for the grantee. The presumption is also for delivery, if the deed appears in the hands of one who is a stranger to both. Where a deed is deposited in the hands of a third person, the terms of depositation may be proved by the oath of the depositary, unless where they are reduced

reduced into writing. A deed appearing in the custody of the grantee himself, is considered as his absolute right; in so much that the grantor is not allowed to prove that it was granted in trust, otherwise than by a written declaration signed by the trustee, or by his oath.

21. The following deeds are effectual without delivery, 1. Writings containing a clause dispensing with the delivery: These are of the nature of revocable deeds, where the death of the grantor is equivalent to delivery, because after death there can be no revocation. 2. Deeds in favour of children, even natural ones; for parents are the proper custodians or keepers of their children's writings. From a similar reason, postnuptial settlements by the husband to the wife need no delivery. 3. Rights which are not to take effect till the grantor's death, or even where he reserves an interest to himself during his life; for it is presumed he holds the custody of these, merely to secure to himself such reserved interest. 4. Deeds that the grantor lay under an antecedent natural obligation to execute, e. g. rights granted to a cautioner for his relief. 5. Mutual obligations, e. g. contracts; for every such deed, the moment it is executed, is a common evidence to all the parties contracters. Lastly, the publication of a writing by registration, is equivalent to delivery.

*Tit. 22. Of Obligations and Contracts arising from Consent, and of accessory Obligations.*

CONTRACTS consensual, i. e. which might, by the Roman law, be perfected by sole consent, without the intervention either of things or of writing, are sale, permutation, location, society, and mandate. Where the subject of any of these contracts is heritable, writing is necessary.

2. Sale is a contract, by which one becomes obliged to give something to another, in consideration of a certain price in current money to be paid for it. Things consisting merely in hope, may be the subject of this contract, as the draught of a net. Commodities, where their importation or use is absolutely prohibited, cannot be the subject of sale; and even in run goods, no action lies against the vender for not delivery, if the buyer knew the goods were run.

3. Though this contract may be perfected before delivery of the subject, the property remains till then with the vender. See Tit. viii. 9. Yet till delivery, the hazard of its deterioration falls on the purchaser, because he has all the profits arising from it, after the sale. On the other hand, the subject itself perishes to the vender; 1. If it should perish through his fault, or after his undue delay to deliver it. 2. If a subject is sold as a fungible, and not as an individual, or *corpus*, e. g. a quantity of farm-wheat, sold without distinguishing the parcel to be delivered from the rest of the farm. 3. The *periculum* lies on the vender till delivery, if he be obliged by a special article in the contract to deliver the subject at a certain place.

4. Location is that contract, where an hire is stipulated for the use of things, or for the service of persons. He who lets his work or the use of his property to hire, is

the locator or lessor; and the other, the conductor or lessee. In the location of things, the lessor is obliged to deliver the subject, fitted to the use it was let for; and the lessee must preserve it carefully, put it to no other use, and, after that is over, restore it. Where a workman or artificer lets his labour, and if the work is either not performed according to contract, or if it be insufficient, even from mere unskilfulness, he is liable to his employer in damages, for he ought not, as an artificer, to have undertaken a work to which he was not equal. A servant hired for a certain term, is intitled to his full wages, though from sickness or other accident he should be disabled for a part of his time; but, if he die before the term, his wages are only due for the time he actually served. If a master dies, or without good reason turns off, before the term, a servant who eats in his house, the servant is intitled to his full wages, and to his maintenance till that term: And, on the other part, a servant who without ground deserts his service, forfeits his wages and maintenance, and is liable to his master in damages.

5. Society or copartnership is a contract, whereby the several partners agree, concerning the communication of loss and gain arising from the subject of the contract. It is formed by the reciprocal choice that the partners make of one another; and so is not constituted in the case of co-heirs, or of several legatees in the same subject. A copartnership may be so constituted, that one of the partners shall, either from his sole right of property in the subject, or from his superior skill, be intitled to a certain share of the profits, without being subjected to any part of the loss; but a society, where one partner is to bear a certain proportion of loss, without being intitled to any share of the profits, is justly reprobated. All the partners are intitled to shares of profit and loss proportioned to their several stocks, where it is not otherwise covenanted.

6. As partners are united, from a *delectus personae*, in a kind of brotherhood, no partner can, without a special power contained in the contract, transfer any part of his share to another. All the partners are bound *in solidum* by the obligation of any one of them, if he subscribe by the *firm* or social name of the company; unless it be a deed that falls not under the common course of administration. The company-effects are the company property of the society subjected to its debts; so that no partner can claim a division thereof, even after the society is dissolved, till these are paid: And, consequently, no creditor of a partner can, by diligence, carry to himself the property of any part of the common stock, in prejudice of a company-creditor: but he may, by arrestment, secure his debtor's share in the company's hands, to be made forthcoming to him at the close of the copartnership, in so far as it is not exhausted by the company debts.

7. Society being founded in the mutual confidence among the *socii*, is dissolved, not only by the renunciation, but by the death of any one of them, if it be not otherwise specially covenanted. A partner, who renounces upon unfair views, or at a critical time, when his withdrawing may be fatal to the society, loses his partners from all their engagements to him, while he is bound to them for all the profits he shall make by his withdrawing,

ing, and for the loss arising thereby to the company. Not only natural, but civil death, *e. g.* arising from a sentence inflicting capital punishment, makes one incapable to perform the duties of a partner, and consequently dissolves the society. In both cases, of death and renunciation, the remaining partners may continue the copartnership, either expressly, by entering into a new contract; or tacitly, by carrying on their trade as formerly. Public trading companies are now every day constituted, with rules very different from those which either obtained in the Roman law, or at this day obtain in private societies. The proprietors or partners in these, though they may transfer their shares, cannot renounce; nor does their death dissolve the company, but the share of the deceased descends to his representative.

8. A joint trade is not a copartnership, but a momentary contract, where two or more persons agree to contribute a sum, to be employed in a particular course of trade, the produce whereof is to be divided among the adventurers, according to their several shares, after the voyage is finished. If, in a joint trade, that partner who is intrusted with the money for purchasing the goods, should, in place of paying them in cash, buy them upon credit, the furnisher who followed his faith alone in the sale, has no recourse against the other adventurers; he can only recover from them what of the buyer's share is yet in their hands. Where any one of the adventurers, in a joint trade, becomes bankrupt, the others are preferable to his creditors, upon the common stock, as long as it continues undivided, for their relief of all the engagements entered into by them on account of the adventure.

9. Mandate is a contract, by which one employs another to manage any business for him; and by the Roman law, it must have been gratuitous. It may be constituted tacitly, by one's suffering another to act in a certain branch of his affairs, for a tract of time together, without challenge. The mandatory is at liberty not to accept of the mandate; and, as his powers are solely founded in the mandant's commission, he must, if he undertakes it, strictly adhere to the directions given him: Nor is it a good defence, that the method he followed was more rational; for in that his employer was the proper judge. Where no special rules are prescribed, the mandatory, if he acts prudently, is secure, whatever the success may be; and he can sue for the recovery of all the expences reasonably disbursed by him in the execution of his office.

10. Mandates may be general, containing a power of administering the mandant's whole affairs; but no mandate implies a power of disposing gratuitously of the constituent's property; nor even of selling his heritage for an adequate price: But a general mandatory may sell such of the moveables as must otherwise perish. No mandatory can, without special powers, transact doubtful claims belonging to his constituent, or refer them to arbiters.

11. Mandates expire, 1. By the revocation of the employer, though only tacit, as if he should name another mandatory for the same business. 2. By the renunciation of the mandatory; even after he has execu-

ted part of his commission, if his office be gratuitous. 2. By the death, either of the mandant or mandatory: But if matters are not entire, the mandate continues in force, notwithstanding such revocation, renunciation, or death. Procuratories of resignation, and precepts of seisin, are made out in the form of mandates; but, because they are granted for the sole benefit of the mandatory, all of them, excepting precepts of *clare constat*, are declared to continue after the death either of the grantor or grantee. Deeds which contain a clause or mandate for registration, are for the same reason made registrable after the death of either.

12. The favour of commerce has introduced a tacit mandate, by which masters of ships are empowered to contract in name of their executors or employers, for repairs, ship-provisions, and whatever else may be necessary for the ship or crew; so as to oblige, not themselves only, but their employers. Whoever has the actual charge of the ship is deemed the master, though he should have no commission from the executors, or should be substituted by the master in the direction of the ship without their knowledge. Executors are liable, whether the master has paid his own money to a merchant for necessities, or has borrowed money to purchase them. The furnisher or lender must prove that the ship needed repairs, provisions, &c. to such an extent; but he is under no necessity to prove the application of the money or materials to the ship's use. If there are several executors, they are liable *singuli in solidum*. In the same manner the undertaker of any branch of trade, manufacture, or other land-negotiation, is bound by the contracts of the infiters whom he sets over it, in so far as relates to the subject of the *propositura*.

13. Contracts and obligations, in themselves imperfect, receive strength, by the contractor or his heirs doing any act thereafter which imports an approbation of them, and consequently supplies the want of an original legal consent. This is called homologation; and it takes place even in deeds intrinsically null, whether the nullity arises from the want of statutory solemnities, or from the incapacity of the grantor. It cannot be inferred, 1. By the act of a person who was not in the knowledge of the original deed; for one cannot approve what he is ignorant of. 2. Homologation has no place where the act or deed which is pleaded as such can be ascribed to any other cause; for an intention to come under an obligation is not presumed.

14. Quasi-contracts are formed without explicit consent, by one of the parties doing something that by its nature either obliges him to the other party, or the other party to him. Under this class may be reckoned tutory, &c. the entry of an heir, *negotiorum gestio, indebiti solutio*, communion of goods between two or more common proprietors, and *mercium jactus levande navis causa*. *Negotiorum gestio* forms those obligations which arise from the management of a person's affairs in his absence, by another, without a mandate. As such manager acts without authority from the proprietor, he ought to be liable in exact diligence, unless he has from friendship interposed in affairs which admitted no delay; and he is accountable for his intromissions with interest. On the

other



other part, he is intitled to the recovery of his necessary disbursements on the subject, and to be relieved of the obligations in which he may have bound himself in consequence of the management.

15. *Indebiti solutio*, or the payment to one of what is not due to him, if made through any mistake, either of fact, or even of law, founds him who made the payment in an action against the receiver for repayment (*condictio indebiti*.) This action does not lie, 1. If the sum paid was due *ex equitate*, or by a natural obligation; for the obligation to restore is founded solely in equity. 2. If he who made the payment knew that nothing was due; for *qui consulto dat quod non debebat, presumitur donare*.

16. Where two or more persons become common proprietors of the same subject, either by legacy, gift or purchase, without the view of co-partnership, an obligation is thereby created among the proprietors to communicate the profit and loss arising from the subject, while it remains common: And the subject may be divided at the suit of any having interest. This division, where the question is among the common proprietors, is according to the valuation of their respective properties: But, where the question is between the proprietors and those having servitudes upon the property, the superficies is only divided, without prejudice to the property. Commonities belonging to the King, or to royal boroughs, are not divisible. Lands lying runrig, and belonging to different proprietors, may be divided, with the exception of borough and incorporated acres; the execution of which is committed to the judge-ordinary, or justices of the peace.

17. The throwing of goods overboard, for lightening a ship in a storm, creates an obligation, whereby the owners of the ship and goods saved are obliged to contribute for the relief of those whose goods were thrown overboard, that so all may bear a proportional loss of the goods ejected for the common safety. In this contribution, the ship's provisions suffer no estimation. A master who has cut his mast, or parted with his anchor, to save the ship, is intitled to this relief; but if he has lost them by the storm, the loss falls only on the ship and freight. If the ejection does not save the ship, the goods preserved from shipwreck are not liable in contribution. Ejection may be lawfully made, if the master and a third part of the mariners judge that measure necessary, though the owner of the goods should oppose it: And the goods ejected are to be valued at the price that the goods of the same sort which are saved shall be afterwards sold for.

18. There are certain obligations, which cannot subsist by themselves, but are accessions to, or make a part of other obligations. Of this sort are fidejussion, and the obligation to pay interest. Cautionry, or fidejussion, is that obligation by which one becomes engaged as security for another, that he shall either pay a sum, or perform a deed.

19. A cautioner for a sum of money may be bound, either simply as cautioner for the principal debtor, or conjunctly and severally for and with the principal debtor. The first has, by our customs, the *beneficium ordinis*, or of discussion; by which the creditor is obliged to discuss the proper debtor, before he can insist for payment against

the cautioner. Where one is bound as full debtor with and for the principal, or conjunctly and severally with him, the two obligants are bound equally in the same obligation, each *in solidum*; and consequently, the cautioner, though he is but an accessory, may be sued for the whole, without either discussing, or even citing the principal debtor. Cautioners for performance of facts by another, or for the faithful discharge of an office, *e. g.* for factors, tutors, &c. cannot by the nature of their engagement be bound conjunctly and severally with the principal obligant, because the fact to which the principal is bound cannot possibly be performed by any other. In such engagements, therefore, the failure must be previously constituted against the proper debtor, before action can be brought against the cautioner, for making up the loss of the party suffering.

20. The cautioner, who binds himself at the desire of the principal debtor, has an *actio mandati*, or of relief against him, for recovering the principal and interest paid by himself to the creditor, and for necessary damages; which action lies *de jure*, though the creditor should not assign to him on payment. As relief against the debtor is implied in fidejussory obligations, the cautioner, where such relief is cut off, is no longer bound: Hence, the defence of prescription frees the cautioner, as well as the principal debtor.

21. But, 1. Where the cautionry is interposed to an obligation merely natural, the relief is restricted to the sums that have really turned to the debtor's profit. 2. A cautioner who pays without citing the debtor, loses his relief, in so far as the debtor had a relevant defence against the debt, in whole or in part. Relief is not competent to the cautioner, till he either pays the debt, or is distressed for it; except, 1. Where the debtor is expressly bound to deliver to the cautioner his obligation cancelled, against a day certain, and has failed; or, 2. Where the debtor is *vergens ad inopiam*; in which case the cautioner may, by proper diligence, secure the debtor's funds for his own relief, even before payment or distress.

22. A right of relief is competent *de jure* to the cautioner who pays against his co-cautioners, unless where the cautioner appears to have renounced it. In consequence of this implied relief, a creditor, if he shall grant a discharge to any one of the cautioners, must, in demanding the debt from the others, deduct that part, as to which he has cut off their relief by that discharge. Where a cautioner in a bond signs a bond of corroboration, as a principal obligant with the proper debtor, and with them a new cautioner, the cautioner in the new bond is intitled to a total relief against the first cautioner, at whose desire he is presumed to be bound.

23. Cautionry is also judicial, as in a suspension. It is sufficient to loose the cautioner, that when he became bound, the suspender had good reason to suspend, *e. g.* if the charger had at that period no title, or had not then performed his part, though these grounds of suspension should be afterwards taken off. In all maritime causes, where the parties are frequently foreigners, the defender must give caution *judicis fisci et judicatum solvi*: Such cautioner gets free by the death of the defender before sentence;

sentence; but he continues bound, though the cause should be carried from the admiral to the court of session. This sort of caution is only to be exacted in causes strictly maritime.

24. It happens frequently, that a creditor takes two or more obligants bound to him, all as principal debtors, without fidejussion. Where they are so bound, for the performance of facts that are in themselves indivisible, they are liable each for the whole, or *singuli in solidum*. But, if the obligation be for a sum of money, they are only liable *pro rata*; unless, 1. Where they are in express words bound conjunctly and severally; or, 2. In the case of bills or promissory notes. One of several obligants of this sort, who pays the whole debt, or fulfils the obligation, is intitled to a proportional relief against the rest; in such manner, that the loss must, in every case, fall equally upon all the solvent obligants.

25. Obligations for sums of money are frequently accompanied with an obligation for the annual rent or interest thereof. Interest (*usura*) is the profit due, by the debtor of a sum of money, to the creditor, for the use of it. The canon law considered the taking of interest as unlawful: The law of Moses allowed it to be exacted from strangers; and all the reformed nations of Europe have found it necessary, after the example of the Romans, to authorise it at certain rates fixed by statute. Soon after the reformation, our legal interest was fixed at the rate of ten *per cent. per annum*; from which time, it has been gradually reduced, till at last, by 12. *Ann. stat.* 2. c. 16. it was brought to five *per cent.* and has continued at that rate ever since.

26. Interest is due, either by law, or by paction. It is due by law, either from the force of statute, under which may be included acts of federunt, or from the nature of the transaction. Bills of exchange, and inland bills, though they should not be protested, carry interest from their date in case of non acceptance; or from the day of their falling due, in case of acceptance and not payment. Where a bill is accepted, which bears no term of payment, or which is payable on demand, no interest is due till demand be made of the sum, the legal voucher of which is a notorial protest. Interest is due by a debtor after denunciation, for all the sums contained in the diligence, even for that part which is made up of interest. Sums paid by cautioners on distress, carry interest, not only as to the principal sum in the obligation, but as to the interest paid by the cautioner. Factors named by the court of Session are liable for interest by a special act of federunt; see Tit. xix. 10.

27. It arises *ex lege*, or from the nature of the transaction, that a purchaser in a sale is liable in interest for the price of the lands bought from the term of his entry, though the price should be arrested in his hands, or tho' the seller should not be able to deliver to him a sufficient progress or title to the lands; for no purchaser can in equity enjoy the fruits of the lands, while at the same time he retains the interest of the price: But lawful consignment of the price made by a purchaser, upon the refusal of the persons having right to receive it, stops the currency of interest. Where one intermeddles with money belonging to another which carries interest, he ought to re-

store it *cum omni obventionem et causa*, and is therefore liable in the interest of it, as being truly an accessory of the subject itself. It is also from the nature of the transaction, that interest is in certain cases allowed to merchants or others in name of damages.

28. Interest is due by express paction, where there is a clause in a bond or obligation, by which money is made to carry interest. An obligation is not lawful, where it is agreed on, that the yearly interest of the sum lent, if it should not be paid punctually as it falls due, shall be accumulated into a principal sum bearing interest; but an obligation may be lawfully granted, not only for the sum truly lent, but for the interest to the day at which the obligation is made payable, whereby the intermediate interest is accumulated into a principal sum, from the term of payment. Interest may be also due by implied paction: Thus, where interest upon a debt is by a letter promised for time past. such promise implies a paction for interest as long as the debt remains unpaid; thus also, the use of payment of interest presumes a paction, and when interest is expressed for one term, it is presumed to be bargained for till payment.

29. The subject matter of all obligations consists either of things, or of facts. Things exempted from commerce cannot be the subject of obligation. See Tit. viii. 2. et seq. One cannot be obliged to the performance of a fact naturally impossible; nor of a fact in itself immoral, for that is also in the judgment of law impossible. Since impossible obligations are null, no penalty or damage can be incurred for non-performance; but it is otherwise, if the fact be in itself possible, though not in the debtor's power; in which case the rule obtains, *locum facti impræstabilis subit damnum et interesse*.

30. An obligation, to which a condition is adjoined, either naturally or morally impossible, is in the general case null; for the parties are presumed not to have been serious. But such obligation is valid, and the condition thereof held *pro non scripta*, 1. In testaments; 2. In obligations, to the performance of which the grantor lies under a natural tie, as in bonds of provision to a child. Where an obligation is granted under a condition, lawful but unfavourable, e. g. that the creditor shall not marry without the consent of certain friends, no more weight is given to the condition than the judge thinks reasonable, A condition, which is in some degree in the power of the creditor himself, is held as fulfilled, if he has done all he could to fulfil it. Implement or performance cannot be demanded in a mutual contract, by that party who himself declines, or cannot fulfil the counterpart.

31. Donation, so long as the subject is not delivered to the donee, may be justly ranked among obligations; and it is that obligation which arises from the mere good will and liberality of the grantor. Donations imply no warrandice, but from the future facts of the donor. They are hardly revokable by our law for ingratitude, though it should be of the grossest kind: Those betwixt man and wife are revokable by the donor, even after the death of the donee; but remuneratory grants, not being truly donations, cannot be so revoked. That special sort of donation, which is constituted verbally, is called a promise. The Roman law intitled all donors to the *beneficium*

*nefscium competentis*, in virtue of which they might retain such part of the donation as was necessary for their own subsistence. Our law allows this benefit to fathers, with respect to the provisions granted to their children, and to grandfathers, which is a natural consequence of children's obligation to aliment their indigent parents; but to no collateral relation, not even to brothers.

32. Donations, made in contemplation of death, or *mortis causa*, are of the nature of legacies, and like them revokable: Consequently, not being effectual in the grantor's life, they cannot compete with any of his creditors; not even with those whose debts were contracted after the donation. They are understood to be given from a personal regard to the donee, and therefore fall by his predecease. No deed, after delivery, is to be presumed a *donatio mortis causa*; for revocation is excluded by delivery.

33. Deeds are not presumed, *in dubio*, to be donations. Hence, a deed by a debtor to his creditor, if donation be not expressed, is presumed to be granted in security or satisfaction of the debt; but bonds of provision to children are, from the presumption of paternal affection, construed to be intended as an additional patrimony: Yet a tocher, given to a daughter in her marriage-contract, is presumed to be in satisfaction of all former bonds and debts; because marriage contracts usually contain the whole provisions in favour of the bride. One who alimments a person that is come of age, without an express paction for board, is presumed to have entertained him as a friend, unless in the case of those who earn their living by the entertainment or board of strangers. But alimony given to minors, who cannot bargain for themselves, is not accounted a donation; except either where it is presumed, from the near relation of the person alimmenting, that it was given *ex pietate*; or where the minor had a father or curators, with whom a bargain might have been made.

#### Tit. 23. Of the Dissolution or Extinction of Obligations.

OBLIGATIONS may be dissolved by performance or implement, consent, compensation, novation, and confusion. 1. By specific performance: Thus, an obligation for a sum of money is extinguished by payment. The creditor is not obliged to accept of payment by parts, unless where the sum is payable by different divisions. If a debtor in two or more separate bonds to the same creditor, made an indefinite payment, without ascribing it, at the time, to any one of the obligations, the payment is applied, 1. To interest, or to sums not bearing interest. 2. To the sums that are least secured, if the debtor thereby incurs no rigorous penalty. But, 3. If this application be penal on the debtor, *e. g.* by suffering the legal of an adjudication to expire, the payment will be so applied to as to save the debtor from that forfeiture. Where one of the debts is secured by a cautioner, the other not, the application is to be so made, *ceteris paribus*, that both creditor and cautioner may have equal justice done to them.

2. Payment made by the debtor upon a mistake in fact,

to one whom he believed, upon probable grounds, to have the right of receiving payment, extinguishes the obligation. But payment made to one, to whom the law denies the power of receiving it, has not this effect; as if a debtor, seized by letters of caption, should make payment to the messenger; for *ignorantia juris neminem excusat*. In all debts, the debtor, if he be not interpellated, may safely pay before the term, except in tack-duties or feu-duties; the payment whereof, before the terms at which they are made payable, is construed to be collusive, in a question with a creditor of the landlord or superior. Payment is *in dubio* presumed, by the voucher of the debt being in the hands of the debtor; *chirographum, apud debitorem repertum, presumitur solutum*.

3. Obligations are extinguishable by the consent of the creditor, who, without full implement, or even any implement, may renounce the right constituted in his own favour. Though a discharge or acquittance, granted by one whom the debtor *bona fide* took for the creditor, but who was not, extinguishes the obligation, if the satisfaction made by the debtor was real; yet where it is imaginary, the discharge will not screen him from paying to the true creditor the debt that he had made no prior satisfaction for. In all debts which are constituted by writing, the extinction, whether it be by specific performance, or bare consent, must be proved, either by the oath of the creditor, or by a discharge in writing; and the same solemnities which law requires in the obligation, are necessary in the discharge: But, where payment is made, not by the debtor himself, but by the creditor's intromission with the rents of the debtor's estate, or by delivery to him of goods in name of the debtor, such delivery or intromission, being *facti*, may be proved by witnesses, though the debt should have been not only constituted by writing, but made real on the debtor's lands by adjudication.

4. A discharge, though it should be general, of all that the granter can demand, extends not to debts of an uncommon kind, which are not presumed to have been under the granter's eye. This doctrine applies also to general assignations. In annual payments, as of rents, feu-duties, interest, &c. three consecutive discharges by the creditor, of the yearly or termly duties, presume the payment of all preceedings. Two discharges by the ancestor, and the third by the heir, do not infer this presumption, if the heir was ignorant of the ancestor's discharges. And discharges by an administrator, as a factor, tutor, &c. presume only the payment of all preceeding duties incurred during his administration. This presumption arises from repeating the discharges thrice successively; and so does not hold in the case of two discharges, though they should include the duties of three or more terms.

5. Where the same person is both creditor and debtor to another, the mutual obligations, if they are for equal sums, are extinguished by compensation; if for unequal, still the lesser obligation is extinguished, and the greater diminished, as far as the concurrence of debt and credit goes. To found compensation, 1. Each of the parties must be debtor and creditor at the same time. 2. Each

of them must be debtor and creditor in his own right. 3. The mutual debts must be of the same quality: Hence, a sum of money cannot be compensated with a quantity of corns; because, till the prices are fixed, at which the corns are to be converted into money, the two debts are incommensurable. Lastly, compensation cannot be admitted, where the mutual debts are not clearly ascertained, either by a written obligation, the sentence of a judge, or the oath of the party. Where this requires but a short discussion, sentence for the pursuer is delayed for some time, *ex equitate*, that the defender may make good his ground of compensation. Where a debt for fungibles is ascertained in money, by the sentence of a judge, the compensation can have no effect farther back than the liquidation, because, before sentence, the debts were incommensurable: But, where a debt for a sum of money is, in the course of a suit, constituted by the oath of the debtor, the compensation, after it is admitted by the judge, operates, *retro*, in so far as concerns the currency of interest, to the time that, by the parties acknowledgment, the debt became due; for, in this case, the debtor's oath is not what creates the debt, or makes it liquid; it only declares that such a liquid sum was truly due before. Compensation cannot be offered after decree, either by way of suspension or reduction; unless it has been formerly pleaded, and unjustly repelled. Decrees in absence are excepted.

6. The right of retention, which bears a near resemblance to compensation, is chiefly competent, where the mutual debts, not being liquid, cannot be the ground of compensation; and it is sometimes admitted *ex equitate*, in liquid debts, where compensation is excluded by statute: Thus, though compensation cannot be pleaded after decree, either against a creditor or his assignee; yet, if the original creditor should become bankrupt, the debtor, even after decree, may retain against the assignee, till he gives security for satisfying the debtor's claim against the cedent. This right is frequently founded in the expence disbursed or work employed on the subject retained, and so arises from the mutual obligations incumbent on the parties. But retention may be sustained, though the debt due to him who claims it does not arise from the nature of the obligation by which he is debtor: Thus, a factor on a land estate may retain the sums levied by him in consequence of his factory, not only till he be paid of the disbursements made on occasion of such estate, but also till he be discharged from the separate engagements he may have entered into on his constituent's account.

7. Obligations are dissolved by novation, whereby one obligation is changed into another, without changing either the debtor or creditor. The first obligation being thereby extinguished, the cautioners in it are loosed, and all its consequences discharged; so that the debtor remains bound only by the last. As a creditor to whom a right is once constituted, ought not to lose it by implication, novation is not easily presumed, and the new obligation is construed to be merely corroborative of the old; but, where the second obligation expressly bears to be *in satisfaction* of the first, these words must necessarily be explained into novation. Where the creditor accepts of

a new debtor, in place of the former who is discharged, this method of extinction is called delegation.

8. Obligations are extinguished *confusione*, where the debt and credit meet in the same person, either by succession or singular title, *e. g.* when the debtor succeeds to the creditor, or the creditor to the debtor, or a stranger to both, for one cannot be debtor to himself. If the succession, from which the *confusio* arises, happens afterwards to be divided, so as the debtor and creditor come again to be different persons; the *confusio* does not produce an extinction, but only a temporary suspension of the debt.

#### Tit. 24. Of Assignations.

HERITABLE rights, when they are clothed with investment, are transmitted by disposition, which is a writing containing procuratory of resignation and precept of seisin; but those which either require no seisin, or on which seisin has actually followed, are transmissible by simple assignation. He who grants the assignation, is called the cedent; and he who receives it, the assignee or assignee: If the assignee conveys his right to a third person, it is called a translation; and if he assigns it back to the cedent, a retrocession. Certain rights are, from the uses to which they are destined, incapable of transmission, as alimentary rights: Others cannot be assigned by the person invested in them, without special powers given to him, as tacks, reversions: The transmission of a third sort, is not presumed to be intended, without an express conveyance; as of paraphernal goods, which are so proper to the wife, that a general assignation by her to her husband, of all that did or should belong to her at her decease, does not comprehend them. A life interest is, by its nature, incapable of a proper transmission; but its profits may be assigned, while it subsists.

2. Assignations must not only be delivered to the assignee, but intimated by him to the debtor. Intimations are considered as so necessary for completing the conveyance, that in a competition between two assignations, the last, if first intimated; is preferred.

3. Though, regularly, intimation to the debtor is made by an instrument, taken in the hands of a notary, by the assignee or his procurator; yet the law admits equipollencies, where the notice of the assignment given to the debtor is equally strong. Thus, a charge upon letters of horning at the assignee's instance, or a suit brought by him against the debtor, supplies the want of intimation; these being judicial acts, which expose the conveyance to the eyes both of the judge and of the debtor; or the debtor's promise of payment by writing to the assignee, because that is in effect a corroborating of the original debt. The assignee's possession of the right, by entering into payments of the rents or interest, is also equal to an intimation; for it imports, not only notice to the debtor, but his actual compliance: But the debtor's private knowledge of the assignment is not sustained as intimation.

4. Certain conveyances need no intimation. 1. Indorsements of bills of exchange; for these are not to be fettered with forms, introduced by the laws of particular states. 2. Bank-notes are fully conveyed by the bare delivery

delivery of them; for as they are payable to the bearer, their property must pass with their possession. 3. Adjudication, which is a judicial conveyance, and marriage, which is a legal one, carry the full right of the subjects thereby conveyed, without intimation: nevertheless, as there is nothing in these conveyances which can of themselves put the debtor *in mala fide*, he is therefore *in tuto* to pay to the wife, or to the original creditor in the debt adjudged, till the marriage or adjudication be notified to him. Assignments of moveable subjects, though they be intimated, if they are made *retenta possessione*, (the cedent retaining the possession), cannot hurt the cedent's creditors; for such rights are presumed, in all questions with creditors, to be collusive, and granted in trust for the cedent himself.

5. An assignation carries to the assignee the whole right of the subject conveyed, as it was in the cedent; and consequently, he may use diligence, either in his cedent's name while he is alive, or in his own.

6. After an assignation is intimated, the debtor cannot prove payment, or compensation, by the oath of the cedent, who has no longer any interest in the debt; unless the matter has been made litigious by an action commenced prior to the intimation: But the debtor may refer to the oath of the assignee, who is in the right of the debt, that the assignment was gratuitous, or in trust for the cedent; either of which being proved, the oath of the cedent will affect the assignee. If the assignation be in part onerous, and in part gratuitous, the cedent's oath is good against the assignee, only in so far as his right is gratuitous. All defences competent against the original creditor in a moveable debt, which can be proved otherwise than by his oath, continue relevant against even an onerous assignee; whose right can be no better than that of his author, and must therefore remain affected with all the burdens which attended it in the author's person.

#### Tit. 25. Of Arrestments and Poidings.

THE diligences, whereby a creditor may affect his debtor's moveable subjects, are arrestment and poiding. By arrestment is sometimes meant the securing of a criminal's person till trial; but as it is understood in the rubric of this title, it is the order of a judge, by which he who is debtor in a moveable obligation to the arrester's debtor, is prohibited to make payment or delivery till the debt due to the arrester be paid or secured. The arrester's debtor is usually called the common debtor; because, where there are two or more competing creditors, he is debtor to all of them. The person in whose hands the diligence is used, is styled the arrestee.

2. Arrestment may be laid on by the authority either of the supreme court, or of an inferior judge. In the first case, it proceeds either upon special letters of arrestment, or on a warrant contained in letters of horning; and it must be executed by a messenger. The warrants granted by inferior judges are called precepts of arrestment, and they are executed by the officer proper to the court. Where the debtor to the common debtor is a pupil, arrestment is properly used in the hands of the tutor, as the pupil's administrator: This doctrine may perhaps extend

to other general administrators, as commissioner, &c. But arrestment, used in the hands of a factor or steward, cannot found an action of forthcoming without calling the constituent. Where the debtor to the common debtor is a corporation, arrestment must be used in the hands of the directors or treasurer, who represent the whole body. Arrestment, when it is used in the hands of the debtor himself, is inept; for that diligence is intended only as a restraint upon third parties.

3. All debts, in which one is personally bound, though they should be heritably secured, are grounds upon which the creditor may arrest the moveable estate belonging to his debtor. Arrestment may proceed on a debt, the term of payment whereof is not yet come, in case the debtor be *vergens ad inopiam*. If a debt be not yet constituted by decree or registration, the creditor may raise and execute a summons against his debtor for payment, on which pending action arrestment may be used, in the same manner as inhibition, which is called arrestment upon a dependence. If one's ground of credit be for the performance of a fact, or if his depending process be merely declaratory, without a conclusion of payment or delivery, such claims are not admitted to be sufficient grounds for arrestment.

4. Moveable debts are the proper subject of arrestment; under which are comprehended conditional debts, and even depending claims. For lessening the expence of diligence to creditors, all bonds which have not been made properly heritable by feisin are declared arrestable. But this does not extend to adjudications, wadsets, or other personal rights of lands, which are not properly debts. Certain moveable debts are not arrestable. 1. Debts due by bill, which pass from hand to hand as bags of money. 2. Future debts; for though inhibition extends to *adquirenda* as well as *adquisita*, yet arrestment is limited, by its warrant, to the debt due at the time of serving it against the arrestee. Hence, an arrestment of rents or interest carries only those that have already either fallen due, or at least become current. Claims, depending on the issue of a suit, are not considered as future debts; for the sentence, when pronounced, has a retrospect to the period at which the claim was first founded. The like doctrine holds in conditional debts. 3. Alimentary debts are not arrestable; for these are granted on personal considerations, and so are not communicable to creditors; but the past interest due upon such debt may be arrested by the person who has furnished the alimony. One cannot secure his own effects to himself for his maintenance, so as they shall not be affectable by his creditors. Salaries annexed to offices granted by the king, and particularly those granted to the judges of the Session, and the fees of servants, are considered as alimentary funds; but the surplus fee, over and above what is necessary for the servant's personal uses, may be arrested.

5. If, in contempt of the arrestment, the arrestee shall make payment of the sum, or deliver the goods arrested, to the common debtor, he is not only liable criminally for breach of arrestment, but he must pay the debt again to the arrester. Arrestment is not merely prohibitory, as inhibitions are; but is a step of diligence which founds the user in a subsequent action, whereby the property of the

the subject arrested may be adjudged to him: It therefore does not, by our later practice, fall by the death of the arrestee, but continues to subsist, as a foundation for an action of forthcoming against his heir, while the subject arrested remains *in medio*. Far less is arrestment lost, either by the death of the arrester, or of the common debtor.

6. Where arrestment proceeds on a depending action, it may be loosed by the common debtor's giving security to the arrester for his debt, in the event it shall be found due. Arrestment founded on decrees, or on registred obligations, which in the judgment of law are decrees, cannot be loosed, but upon payment or consignation; except, 1. Where the term of payment of the debt is not yet come, or the condition has not yet existed. 2. Where the arrestment has proceeded on a registred contract, in which the debts or mutual obligations are not liquid. 3. Where the decree is suspended, or turned into a libel; for, till the suspension be discussed, or the pending action concluded, it cannot be known whether any debt be truly due. A loosing takes off the *nexus*, which had been laid on the subject arrested; so that the arrestee may thereafter pay safely to his creditor, and the cautioner is substituted in place of the arrestment, for the arrester's security: Yet the arrester may, while the subject continues with the arrestee, pursue him in a forthcoming, notwithstanding the loosing.

7. Arrestment is only an inchoated or begun diligence; to perfect it, there must be an action brought by the arrester against the arrestee, to make the debt or subject arrested forthcoming. In this action, the common debtor must be called for his interest, that he may have an opportunity of excepting to the lawfulness or extent of the debt, on which the diligence proceeded. Before a forthcoming can be pursued, the debt due by the common debtor to the arrester, must be liquidated; for the arrester can be no further intitled to the subject arrested than to the extent of the debt due to him by the common debtor. Where the subject arrested is a sum of money, it is, by the decree of forthcoming, directed to be paid to the pursuer towards satisfying his debt; where goods are arrested, the judge ordains them to be exposed sale, and the price to be delivered to the pursuer. So that in either case, decrees of forthcoming are judicial assignations to the arrester of the subject arrested.

8. In all competitions, regard is had to the dates, not of the grounds of debt, but of the diligences proceeding upon them. In the competition of arrestments, the preference is governed by their dates, according to the priority even of hours, where it appears with any certainty which is the first. But, as arrestment is but a begun diligence, therefore if a prior arrester shall neglect to insist in an action of forthcoming for such a time as may be reasonably construed into a desertion of his begun diligence, he loses his preference. But, as dereliction of diligence is not easily presumed, the distance of above two years, between the first arrestment and the decree of forthcoming, was found not to make such a *mora* as to intitle the posterior arrester to a preference. This rule of preference, according to the dates of the several arrestments, holds, by our present practice, whether they have pro-

ceeded on a decree, or on a dependence; on debts not yet payable, or on debts already payable; provided the pendency shall have been closed, or the debt have become payable, before the issue of the competition.

9. In the competition of arrestments with assignations, an assignation by the common debtor, intimated before arrestment, is preferable to the arrestment. If the assignation is granted before arrestment, but not intimated till after it, the arrester is preferred.

10. Poining is that diligence affecting moveable subjects, by which their property is carried directly to the creditor. No poining can proceed, till a charge be given to the debtor to pay or perform, and the days thereof be expired, except poinings against vassals for their feu-duties, and poinings against tenants for rent, proceeding upon the landlord's own decree; in which the ancient custom of poining without a previous charge continues. A debtor's goods may be poined by one creditor, though they have been arrested before by another; for arrestment being but an imperfect diligence, leaves the right of the subject still in the debtor, and so cannot hinder any creditor from using a more perfect diligence, which has the effect of carrying the property directly to himself.

11. No cattle pertaining to the plough, nor instruments of tillage, can be poined in the time of labouring or tilling the ground, unless where the debtor has no other goods. By labouring time is understood, that time, in which that tenant, whose goods are to be poined, is ploughing, though he should have been earlier or later than his neighbours; but summer-fallowing does not fall under this rule.

12. In the execution of poining, the debtor's goods must be apprifed, first on the ground of the lands where they are laid hold on, and a second time at the market-cross of the jurisdiction, by the stated apprifers thereof; or, if there are none, by persons named by the messenger or other officer employed in the diligence. Next, the messenger must, after public intimation by three oyeses, declare the value of the goods according to the second apprifement, and require the debtor to make payment of the debt, including interest and expences. If payment shall be offered to the creditor, or in his absence to his lawful attorney; or if, in case of refusal by them, consignation of the debt shall be made in the hands of the judge-ordinary or his clerk, the goods must be left with the debtor; if not, the messenger ought to adjudge and deliver them over, at the apprifed value, to the user of the diligence towards his payment: And the debtor is intitled to a copy of the warrant and executions, as a voucher that the debt is discharged in whole or in part by the goods poined.

13. Ministers may point for their stipends, upon one apprifement on the ground of the lands; and landlords were always in use to point so, for their rents. Apprifement of the goods at the market-cross of the next royal borough, or even of the next head-borough of stewardry or regality, though these jurisdictions be abolished, is declared as sufficient as if they were carried to the head-borough of the shire. Poining, whether it be considered as a sentence, or as the execution of a sentence, must be

proceeded in between sun-rising and sun-setting; or at least it must be finished before the going off of daylight. The powers of the officer employed in the execution of poindings, are not clearly defined by custom, in the case of a third party claiming the property of the goods to be poinded. This is certain, that he may take the oath of the claimant, upon the verity of his claim; and if from thence it shall appear that the claimant's title is collusive, he ought to proceed in the diligence; but, if there remains the least doubt, his safest course is to deliver the goods to the claimant, and to express in his execution the reasons why poinding did not proceed.

14. Any person who stops a poinding *via facti*, on groundless pretences, is liable, both criminally, in the pains of deforcement, (see Tit. xxxiii. 15.) and civilly, in the value of the goods which might have been poinded by the creditor.

#### Tit. 26. Of Prescriptions.

PRESCRIPTION, which is a method, both of establishing and of extinguishing property, is either positive or negative. Positive prescription is generally defined, as the Roman *usucapio*, the acquisition of property (it should rather be, when applied to our law, the securing it against all further challenge) by the possessor's continuing his possession for the time which law has declared sufficient for that purpose: Negative, is the loss or amission of a right, by neglecting to follow it forth, or use it, during the whole time limited by law. The doctrine of prescription, which is, by some writers, condemned as contrary to justice, has been introduced, that the claims of negligent creditors might not subsist for ever, that property might be at last fixed, and forgeries discouraged, which the difficulty of detecting must have made exceeding frequent, if no length of time had limited the legal effect of writings.

2. Positive prescription was first introduced into our law by 1617, c. 12. which enacts, that whoever shall have possessed his lands, annualrents, or other heritages, peaceably, in virtue of infeftments, for forty years continually after their dates, shall not thereafter be disquieted in his right by any person pretending a better title. Under *heritages* are comprehended every right that is *fundo annexum*, and capable of continual possession. Continued possession, if proved as far back as the memory of man, presumes possession upwards to the date of the infeftment. The whole course of possession must by the act be founded on seifins, and consequently no part thereof on the bare right of apparenacy; but forty years possession, without seifin, is sufficient in the prescription of such heritable rights as do not require seifin. The possession must also be without any *lawful* interruption, *i. e.* it must neither be interrupted *via facti*, nor *via juris*. The prescription of subjects not expressed in the infeftment as part and pertinent of another subject specially expressed, has been explained, Tit. xiii. 6.

3. The act requires, that the possessor produce, as his title of prescription, a charter of the lands, preceeding the forty years possession, with the seifin following on it: and where there is no charter extant, seifins, one or more

standing together for forty years, and proceeding either on retours, or precepts of *clare constat*. This has given rise to a reasonable distinction observed in practice, between the prescription of a singular successor, and of an heir. Singular successors must produce for their title of prescription, not only a seifin, but its warrant, as a charter, disposition, &c. either in their own person, or in that of their author: But the production by an heir of seifins, one or more, standing together for forty years, and proceeding on retours or precepts of *clare constat*, is sufficient. The heir is not obliged to produce the retours or precepts on which his seifins proceed, nor is the singular successor obliged to produce the ground of his charter; so that if the title of prescription produced be a fair deed, and a sufficient title of property, the possessor is secure by the act, which admits no ground of challenge, but falsehood. A special statute, for establishing the positive prescription in moveable rights, was not necessary; for, since a title in writing is not requisite for the acquiring of these, the negative prescription, by which all right of action for recovering their property is cut off, effectually secures the possessor.

4. The negative prescription of obligations, by the lapse of forty years, was introduced into our law long before the positive, by 1469, c. 29.—1474, c. 55. This prescription is now amplified by the foresaid act 1617, which has extended it to all actions competent upon heritable bonds, reversions, and others whatsoever; unless where the reversions are either incorporated in the body of the wadset right, or registred in the register of reversions: And reversions so incorporated, or registred, are not only exempted from the negative prescription, but they are an effectual bar against any person from pleading the positive.

5. A shorter negative prescription is introduced by statute, in certain rights and debts. Actions of spuilzie, ejection, and others of that nature, must be pursued within three years after the commission of the fact on which the action is founded. As in spuilzes and ejections, the pursuer was intitled, *in odium* of violence, to a proof by his own oath *in litem*, and to the violent profits against the defender, the statute meant only to limit these special privileges by a three years prescription, without cutting off the right of action, where the claim is restricted to simple restitution. Under the general words, *and others of that nature*, are comprehended all actions where the pursuer is admitted to prove his libel by his own oath *in litem*.

6. Servants fees, house-rents, mens ordinaries, (*i. e.* money due for board,) and merchants accounts, fall under the triennial prescription, by 1579, c. 83. There is also a general clause subjoined to this statute, of *other the like debts*, which includes alimentary debts, wages due to workmen, and accounts due to writers, agents, or procurators. These debts may by this act, be proved after the three years, either by the writing or oath of the debtor; so that they prescribe only as to the mean of proof by witnesses; but after the three years, it behoves the creditor to refer to the debtor's oath, not only the constitution, but the subsistence of the debt. In the prescription of house-rents, servants fees, and alimony, each term's

term's rent, fee, or alimony, runs a separate course of prescription; so that in an action for these, the claim will be restricted to the arrears incurred within the three years immediately before the citation: But, in accounts, prescription does not begin till the last article; for a single article cannot be called an account. Actions of removing must also be pursued within three years after the warning. Reductions of erroneous retours, prescribe, if not pursued within twenty years.

7. Ministers stipends and cultures prescribe in five years after they are due; and arrears of rent, five years after the tenant's removing from the lands. As the prescription of mails and duties was introduced in favour of poor tenants, that they might not suffer by neglecting to preserve their discharges, a proprietor of lands subject to a liferent, who had obtained a lease of all the liferented lands from the liferenter, is not intitled to plead it, nor a tacksmen of one's whole estate, who had by the lease a power of removing tenants. Bargains concerning moveables, or sums of money which are proveable by witnesses, prescribe in five years after the bargain. Under these are included sales, locations, and all other consensual contracts, to the constitution of which writing is not necessary. But all the above mentioned debts, may, after the five years, be proved, either by the oath or the writing of the debtor; of which above, § 6. A quinquennial prescription is established in arrestments, whether on decrees or depending actions: The first prescribe in five years after using the arrestment, and the last in five years after sentence is pronounced on the depending action.

8. No person binding for or with another, either as cautioner or co-principal, in a bond or contract for a sum of money, continues bound after seven years from the date of the bond, provided he has either a clause of relief in the bond, or a separate bond of relief, intimated to the creditor, at his receiving the bond. But all diligence used within the seven years against the cautioner, shall stand good. As this is a public law, intended to prevent the bad consequences of rash engagements, its benefit cannot, before the lapse of the seven years, be renounced by the cautioner. As it is correctory, it is strictly interpreted: Thus, bonds bearing a mutual clause of relief *pro rata*, fall not under it; nor bonds of corroboration, nor obligations, where the condition is not purified, or the term of payment not come within the seven years; because no diligence can be used on these. The statute excludes all cautioneries for the faithful discharge of offices; these not being obligations in a bond or contract for sums of money. And practice has denied the benefit of it to all judicial cautioners, as cautioners in a suspension. Actions of count and reckoning, competent either to minors against their tutors or curators, or *vice versa*, prescribe in ten years after the majority or death of the minor.

9. Holograph bonds, missive letters, and books of account, not attested by witnesses, prescribe in twenty years, unless the creditor shall thereafter prove the verity of the subscription by the debtor's oath. It is therefore sufficient to save from the effect of this prescription, that the constitution of the debt be proved by the party's oath,

after the twenty years; whereas in stipends, merchants accounts, &c. not only the constitution, but the subsistence of the debt, must be proved by writing or the debtor's oath, after the term of prescription. Some lawyers extend this prescription of holograph writings to all obligations for sums not exceeding L 100 Scots, which are not attested by witnesses; because though these are in practice sustained, yet they ought not to have the same duration with deeds attested by witnesses. Though in the short prescriptions of debts, the right of action is forever lost, if not exercised within the time limited; yet where action was brought on any of those debts, before the prescription was run, it subsisted, like any other right, for forty years. As this defeated the purpose of the acts establishing these prescriptions, all processes upon warnings, spuilzies, ejections, or arrestments, or for payment of the debts contained in act 1669, c. 9. are by the said act, joined with 1685, c. 14. declared to prescribe in five years, if not wakened within that time; see Tit. 30.

10. Certain obligations are lost by the lapse of less than forty years, without the aid of statute, where the nature of the obligation, and the circumstances of parties, justify it: Thus, bills which are not intended for lasting securities, produce no action, where the creditor has been long silent, unless the subsistence of the debt be proved by the debtor's oath; but the precise time is not fixed by practice. Thus also, a receipt for bills granted by a writer to his employer, not insisted upon for twenty-three years, was found not productive of an action. The prescriptions of the restitution of minors, of the benefit of inventory, &c. are explained in their proper places.

11. In the positive prescription, as established by the act 1617, the continued possession for forty years, proceeding upon a title of property not chargeable with falsehood, secures the possessor against all other grounds of challenge, and so presumes *bona fides*, *presumptione juris et de jure*. In the long negative prescription, *bona fides* in the debtor is not required: The creditor's neglecting to insist for so long a time, is construed as an abandoning of his debt, and so is equivalent to a discharge. Hence, though the subsistence of the debt should be referred to the debtor's own oath, after the forty years, he is not liable.

12. Prescription runs *de momento in momentum*: The whole time defined by law must be completed, before a right can be either acquired or lost by it; so that interruption, made on the last day of the fortieth year, breaks its course. The positive prescription runs against the Sovereign himself, even as to his annexed property, but it is generally thought he cannot suffer by the negative: He is secured against the negligence of his officers, in the management of processes, by express statute, 1600, c. 14. The negative, as well as the positive prescription, runs against the church, though churchmen have but a temporary interest in their benefices. But because the rights of beneficiaries to their stipends are liable to accidents, through the frequent change of incumbents, thirteen years possession does, by a rule of the Roman chancery which we have adopted, found a presumptive title in the beneficiary: But this is not properly prescription; for if by titles recovered, perhaps out of the incumbent's own hands,



hands, it shall appear that he has possessed tithes, or other subjects, to a greater extent than he ought, his possession will be restricted accordingly. This right must not be confounded with that established in favour of churchmen, which is confined to church lands and rents, and constitutes a proper prescription, upon a possession of thirty years.

13. The clause in the act 1617, saving minors from prescription, is extended to the positive, as well as to the negative prescription; but the exception of minority is not admitted in the case of hospitals for children, where there is a continual succession of minors, that being a *casus insolitus*. Minors are expressly excepted in several of the short prescriptions, as 1579, c. 81.—1669, c. 9; but where law leaves them in the common case, they must be subject to the common rules.

14. Prescription does not run *contra non valentem agere*, against one who is barred, by some legal incapacity, from pursuing; for in such case, neither negligence nor dereliction can be imputed to him. This rule is, by a favourable interpretation, extended to wives who *ex reverentia maritali* forbear to pursue actions competent to them against their husbands. On the same ground, prescription runs only from the time that the debt or right could be sued upon. Thus, inhibition prescribes only from the publishing of the deed granted to the inhibitor's prejudice; and in the prescription of removings, the years are computed only from the term at which the defender is warned to remove. Neither can prescription run against persons who are already in possession, and so can gain nothing by a pursuit. Thus, where a person, who has two adjudications affecting the same lands, is in possession upon one of them, prescription cannot run against the other during such possession.

15. Certain rights are incapable of prescription: 1. Things that law has exempted from commerce. 2. *Res mera facultatis*, e. g. a faculty to charge a subject with debts, to revoke, &c. cannot be lost by prescription, for faculties may, by their nature, be exercised at any time: Hence, a proprietor's right of using any act of property on his own grounds, cannot be lost by the greatest length of time. 3. Exceptions competent to a person for eluding an action, cannot prescribe, unless the exception is founded on a right productive of an action, e. g. compensation; such right must be insisted on, within the years of prescription. 4. Obligations of yearly pensions or payments, though no demand has been made on them for forty years, do not suffer a total prescription, but still subsist as to the arrears fallen due within that period; because prescription cannot run against an obligation, till it be payable, and each year's pension or payment is considered as a separate debt.

16. No right can be lost *non utendo* by one, unless the effect of that prescription be to establish it in another. Hence the rule arises, *juri sanguinis nunquam prescribitur*. Hence also, a proprietor of land cannot lose his property by the negative prescription, unless he who objects it can himself plead the positive. On the same ground, a superior's right of feu-duties cannot be lost *non utendo*; because being inherent in the superiority, it is truly a right of lands that cannot suffer the negative

prescription, except in favour of one who can plead the positive; which the vassal cannot do, being destitute of a title. This rule applies also to parsonage tithes, which are an inherent burden upon all lands not specially exempted; and from which therefore the person liable cannot prescribe an immunity, by bare non-payment: But such vicarage tithes as are only due where they are established by usage, may be lost by prescription. In all these cases, though the radical right cannot suffer the negative prescription, the bygone duties, not demanded within the forty years, are lost to the proprietor, superior, or titular.

17. Prescription may be interrupted by any deed, whereby the proprietor or creditor uses his right or ground of debt. In all interruptions, notice must be given to the possessor of the subject, or the debtor, that the proprietor or creditor intends to sue upon his right. All writings whereby the debtor himself acknowledges the debt, and all processes for payment brought or diligences used against him upon his obligation, by horning, inhibition, arrestment, &c. must be effectual to interrupt prescription.

18. Interruptions, by citation upon libelled summonses, where they are not used by a minor, prescribe, if not renewed every seven years: But where the appearance of parties, or any judicial act has followed thereupon, it is no longer a bare citation, but an action which subsists for forty years. Citations for interrupting the prescription of real rights must be given by messengers; and the summonses, on which such citations proceed, must pass the signet upon a bill, and be registered within sixty days after the execution, in a particular register appointed for that purpose: And where interruption of real rights is made *via facti*, an instrument must be taken upon it, and recorded in the said register; otherwise it can have no effect against singular successors.

19. Interruption has the effect to cut off the course of prescription, so that the person prescribing can avail himself of no part of the former time, but must begin a new course, commencing from the date of the interruption. Minority therefore is no proper interruption; for it neither breaks the course of prescription, nor is it a document or evidence taken by the minor on his right: It is a personal privilege competent to him, by which the operation of the prescription is indeed suspended during the years of minority, which are therefore discounted from it; but it continues to run after majority, and the years before and after the minority may be conjoined to complete it. The same doctrine applies to the privilege arising from one's incapacity to act.

20. Diligence used upon a debt, against any one of two or more co-obligants, preserves the debt itself, and so interrupts prescription against all of them; except in the special case of cautioners, who are not affected by any diligence used against the principal debtor. In the same manner, a right of annualrent, constituted upon two separate tenements, is preserved as to both from the negative prescription, by diligence used against either of them. But whether such diligence has also the effect to hinder the possessor of the other tenement by singular titles from the benefit of the positive prescription, may be doubted.

TIT.

Tit. 27. *Of Succession in Heritable Rights.*

SINGULAR successors are those who succeed to a person yet alive, in a special subject by singular titles; but succession, in its proper sense, is a method of transmitting rights from the dead to the living. Heritable rights descend by succession to the heir properly so called; moveable rights, to the executors, who are sometimes said to be heirs in moveables. Succession is either by special destination, which descends to those named by the proprietor himself; or legal, which devolves upon the persons whom the law marks out for successors, from a presumption, that the proprietor would have named them, had he made a destination. The first is in all cases preferred to the other, as presumption must yield to truth.

2. In the succession of heritage, the heirs at law are otherwise called heirs general, heirs whatsoever, or heirs of line; and they succeed by the right of blood, in the following order. First, descendents sons are preferred to daughters, and the eldest son to all the younger. Where there are daughters only, they succeed equally, and are called heirs-portioners. Failing immediate descendents, grand-children succeed; and in default of them, great-grand-children; and so on *in infinitum*; preferring, as in the former case, males to females, and the eldest male to the younger.

3. Next after descendents, collaterals succeed; among whom the brothers *german* of the deceased have the first place. But as, in no case, the legal succession of heritage is, by the law of Scotland, divided into parts, unless where it descends to females; the immediate younger brother of the deceased excludes the rest, according to the rule, *heritage descends*. Where the deceased is himself the youngest, the succession goes to the immediate elder brother, as being the least deviation from this rule. If there are no brothers *german*, the sisters *german* succeed equally; then brothers *consanguinean*, in the same order as brothers *german*; and failing them, sisters *consanguinean* equally. Next, the father succeeds. After him, his brothers and sisters, according to the rules already explained; then the grand-father; failing him, his brothers and sisters; and so upwards, as far back as propinquity can be proved. Though children succeed to their mother, a mother cannot to her child; nor is there any succession by our law through the mother of the deceased; in so much that one brother *uterine*, *i. e.* by the mother only, cannot succeed to another, even in that estate which flowed originally from their common mother.

4. In heritage there is a right of representation, by which one succeeds, not from any title in himself, but in the place of, and as representing some of his deceased ascendants. Thus, where one leaves a younger son, and a grandchild by his eldest, the grandchild, though farther removed in degree from the deceased than his uncle, excludes him, as coming in place of his father the eldest son. Hence arises the distinction between succession *in capita*, where the division is made into as many equal parts as there are *capita* or heirs, which is the case of heirs portioners; and succession *in stirpes*, where the re-

motors heirs draw no more among them than the share belonging to their ascendent or *stirps*, whom they represent: an example of which may be figured in the case of one who leaves behind him a daughter alive, and two granddaughters by a daughter deceased. In which case the two granddaughters would succeed equally to that half which would have belonged to their mother had she been alive.

5. In the succession of heirs portioners, indivisible rights, *e. g.* titles of dignity, fall to the eldest sister. A single right of superiority goes also to the eldest; for it hardly admits a division, and the condition of the vassal ought not to be made worse by multiplying superiors upon him. Where there are more such rights, the eldest may perhaps have her election of the best, but the younger sisters are entitled to a recompence, in so far as the divisions are unequal; at least, where the superiorities yield a constant yearly rent. The principal seat of the family falls to the eldest, with the garden and orchard belonging to it, without recompence to the younger sisters; but all other houses are divided amongst them, together with the lands on which they are built, as parts and pertinents of these lands.

6. Those heritable rights, to which the deceased did himself succeed as heir to his father or other ancestor, get sometimes the name of heritage in a strict sense, in opposition to the *scuda nova*, or feus of conquest, which he had acquired by singular titles, and which descend, not to his heir of line, but of conquest. This distinction obtains only, where two or more brothers or uncles, or their issue, are next in succession; in which case the immediate younger brother, as heir of line, succeeds to the proper heritage, because that descends; whereas the conquest ascends to the immediate elder brother. It has no place in female succession, which the law divides equally among the heirs-portioners. Where the deceased was the younger brother, the immediate elder brother is heir both of line and of conquest. An estate, disposed by a father to his eldest son, is not conquest in the son's person, but heritage; because the son would have succeeded to it, though there had been no disposition. The heir of conquest succeeds to all rights affecting land, which require seisin to perfect them. But teinds go to the heir of line; because they are merely a burden on the fruits, not on the land. Tacks do not fall under conquest, because they are complete rights without seisin; nor personal bonds taken to heirs excluding executors.

7. The heir of line is entitled to the succession, not only of subjects properly heritable, but to that sort of moveables called *heirship*, which is the best of certain kinds. This doctrine has been probably introduced, that the heir might not have an house and estate to succeed to, quite dismantled by the executor. In that sort which goes by pairs or dozens, the best pair or dozen is the heirship. There is no heirship in fungibles, or things estimated by quantity, as grain, hay, current money &c. To intitle an heir to this privilege, the deceased must have been either, 1. A Prelate: 2. A Baron, *i. e.* one who stood inest at his death in lands, though not erected into a barony; or even in a right of annualrent: Or, 3. A burghs; not an honorary one, but a trading burghs of a royal borough, or at least one intitled to enter bur-

gers, in the right of his ancestor. Neither the heir of conquest, nor of tailzie, has right to heirship-moveables.

8. As to succession by destination, no proprietor can settle any heritable estate, in the proper form of a testament; not even bonds including executors, though these are not heritable *ex jure naturæ*: But, where a testament is in part drawn up in the style of a deed *inter vivos*, such part of it may contain a settlement of heritage, though executors should be named in the testamentary part. The common method of settling the succession of heritage is by disposition, contract of marriage, or simple procuratory of resignation: And, though a disposition settling heritage should have neither precept nor procuratory, it founds an action against the heir of line to complete his titles to the estate; and thereafter divest himself in favour of the disponent. The appellation of tailzie, or entail, is chiefly used in the case of a land estate, which is settled on a long series of heirs, substituted one after another. The person first called in the tailzie, is the institute; the rest, the heirs of tailzie, or the substitutes.

9. Tailzies, when considered in relation to their several degrees of force, are either, 1. Simple destinations: 2. Tailzies with prohibitory clauses. 3. Tailzies with prohibitory, resolutive, and irritant clauses. That is a simple destination, where the persons called to the succession are substituted one after another, without any restraint laid on the exercise of their property. The heirs, therefore, succeeding to such estate, are absolute heirs, and consequently may alter the destination at pleasure.

10. In tailzies with clauses prohibitory, *e. g.* declaring that it shall not be lawful to the heirs to contract debts or alien the lands in prejudice of the succession, none of the heirs can alien gratuitously. But the members of entail may contract debts which will be effectual to the creditors, or may dispose of the estate for onerous causes. In both these sorts, the maker himself may alter the tailzie; except, 1. Where it has been granted for an onerous cause, as in mutual tailzies; or, 2. Where the maker is expressly disabled, as well as the institute or the heirs.

11. Where a tailzie is guarded with irritant and resolutive clauses, the estate entailed cannot be carried off by the debt, or deed, of any of the heirs succeeding thereto, in prejudice of the substitutes. It was long doubted, whether such tailzies ought to be effectual, even where the superior's consent was adhibited; because they sunk the property of estates, and created a perpetuity of liferents. They were first explicitly authorized by 1685, *c.* 22. By this statute, the entail must be registered in a special register established for that purpose; and the irritant and resolutive clauses must be inserted, not only in the procuratories, precepts, and seifins, by which the tailzies are first constituted, but in all the after-conveyances thereof; otherwise they can have no force against singular successors. But a tailzie, even without these requisites, is effectual against the heir of the granter, or against the institute who accepts of it.

12. An heir of entail has full power over the entailed estate, except in so far as he is expressly fettered; and as entails are an unfavourable restraint upon property, and a frequent snare to trading people, they are *strictissimi*

*juris*; so that no prohibition or irritancies are to be inserted by implication.

13. An heir, who counteracts the directions of the tailzie, by aliening any part of the estate, charging it with debt, &c. is said to contravene. It is not the simple contracting of debt that infers contravention; the lands entailed must be actually adjudged upon the debt contracted. An heir may, where he is not expressly barred, settle rational provisions on his wife and children, without incurring contravention.

14. When the heirs of the last person specially called in a tailzie come to succeed, the irritancies have no longer any person in favour of whom they can operate; and consequently, the fee, which was before tailzied, becomes simple and unlimited in the person of such heirs. The King may purchase lands within Scotland, notwithstanding the strictest entail; and where the lands are in the hands of minors or fatuous persons, his Majesty may purchase them from the curators or guardians. And heirs of entail may sell to their vassals the superiorities belonging to the entailed estate; but in all these cases, the price is to be settled in the same manner that the lands or superiorities sold were settled before the sale.

15. Rights, not only of land estates, but of bonds, are sometimes granted to two or more persons in conjunct fee. Where a right is so granted to two strangers, without any special clause adjoined to it, each of them has an equal interest in the fee, and the part of the deceased descends to his own heir. If the right be taken to the two jointly, and *the longest liver* and their heirs, the several shares of the conjunct heirs are affectable by their creditors during their lives; but, on the death of any one of them, the survivor has the fee of the whole, in so far as the share of the predeceased remains free, after payment of his debts. Where the right is taken to the two in conjunct fee, and to the heirs of one of them, he to whose heirs the right is taken, is the only heir; the right of the other resolves into a simple liferent: Yet where a father takes a right to himself and his son jointly, and to the son's heirs, such right being gratuitous is not understood to strip the father of the fee, unless a contrary intention shall plainly appear from the tenor of the right.

16. Where a right is taken to a husband and wife, in conjunct fee and liferent, the husband, as the *persona dignior*, is the only heir: The wife's right resolves into a liferent, unless it be presumable, from special circumstances, that the fee was intended to be in the wife. Where a right of moveables is taken to husband and wife, the heirs of both succeed equally, according to the natural meaning of the words.

17. Heirs of provision are those who succeed to any subject, in virtue of a provision in the institute, or other deed of settlement. This appellation is given most commonly to heirs of a marriage. These are more favourably regarded than heirs by simple destination, who have only the hope of succession; for heirs of a marriage, because their provisions are constituted by an onerous contract, cannot be disappointed of them by any gratuitous deed of the father. Nevertheless, as their right is only a right of succession, which is not designed to restrain the father,

father from granting onerous or rational deeds, he continues to have the full power of selling the subject, or charging it with debts, unless a proper right of credit be given to the heir by the marriage-contract, e. g. if the father should oblige himself to infect the heir in the lands, or make payment of the sum provided against a day certain, or when the child attains a certain age, &c. for such rights, when perfected by infection, or secured by diligence, are effectual against all the posterior deeds of the father, even onerous.

18. Though all provisions to children, by a marriage-contract conceived in the ordinary form, being merely rights of succession, are postponed to every onerous debt of the grantor, even to those contracted posterior to the provisions; yet where a father executes a bond of provision to a child actually existing, whether such child be the heir of a marriage or not, a proper debt is thereby created, which, though it be without doubt gratuitous, is not only effectual against the father himself and his heirs, but is not reducible at the instance even of his prior onerous creditors, if he was solvent at the time of granting it. A father may, notwithstanding a first marriage-contract, settle a jointure on a second wife, or provide the children of a second marriage; for such settlements are deemed onerous; but where they are exorbitant, they will be restricted to what is rational: And in all such settlements, where the provisions of the first marriage-contract are incoached upon, the heirs of that marriage have recourse against the father, in case he should afterwards acquire a separate estate, which may enable him to fulfil both obligations.

19. Where heritable rights are provided to the heirs of a marriage, they fall to the eldest son, for he is the heir at law in heritage. Where a sum of money is so provided, the word *heir* is applied to the subject of the provision, and so marks out the executor, who is the heir in moveables. When an heritable right is provided to the *bairns* (or issue) of a marriage, it is divided equally among the children, if no division be made by the father; for such destination cuts off the exclusive right of the legal heir. No provision granted to bairns, gives a special right of credit to any one child, as long as the father lives: The right is granted *familie*; so that the whole must indeed go to one or other of them; but the father has a power inherent in him, to divide it among them, in such proportions as he thinks best; yet so as none of them may be entirely excluded, except in extraordinary cases.

20. A clause of return is that, by which a sum in a bond or other right, is, in a certain event, limited to return to the grantor himself, or his heirs. When a right is granted for onerous causes, the creditor may defeat the clause of return, even gratuitously. But, where the sum in the right flows from the grantor, or where there is any other reasonable cause for the provision of return in his favour, the receiver cannot disappoint it gratuitously. Yet since he is heir, the sum may be either assigned by him for an onerous cause, or affected by his creditors.

21. An heir is, in the judgment of law, *calens persona cum defuncto*, and so represents the deceased universally, not only in his rights, but in his debts: In the

first view, he is said to be heir *active*: in the second *passive*. From this general rule are excepted, heirs substituted in a special bond, and even substituted in a disposition *crucium honorum*, to take effect at the grantor's death; for such substitutes are considered as singular successors, and their right as an universal legacy, which does not subject the legatee *ultra valorum*.

22. Before an heir can have an active title to his ancestor's rights, he must be entered by service and retour. He who is intitled to enter heir, is, before his actual entry, called apparent heir. The bare right of apparentry carries certain privileges with it. An apparent heir may defend his ancestor's titles against any third party who brings them under challenge. Tenants may safely pay him their rents; and after they have once acknowledged him by payment, he may compel them to continue it; and the rents not uplifted by the apparent heir belong to his executors, upon his death.

23. As an heir is, by his entry, subjected universally to his ancestor's debts, apparent heirs have therefore a year (*annus deliberandi*) allowed to them from the ancestor's decease, to deliberate whether they will enter or not; till the expiring of which, though they may be charged by creditors to enter, they cannot be sued in any process founded upon such charge. Though declaratory actions, and others which contain no personal conclusion, may be pursued against the apparent heir, without a previous charge; action does not lie even upon these, within the year, if the heir cannot make the proper defences without incurring a passive title. But judicial sales, commenced against an ancestor, may be continued upon a citation of the heir, without waiting the year of deliberating. This *annus deliberandi* is computed, in the case of a posthumous heir, from the birth of such heir. An apparent heir, who by immixing with the estate of his ancestor, is as much subjected to his debts as if he had entered, can have no longer a right to deliberate whether he will enter or not.

24. All services proceed on brieves from the chancery, which are called brieves of inquest, and have been long known in Scotland. The judge, to whom the brief is directed, is required to try the matter by an inquest of fifteen sworn men. The inquest, if they find the claim verified, must declare the claimant heir to the deceased, by a verdict or service, which the judge must attest, and return the brief, with the service proceeding on it, to the chancery.

25. The service of heirs is either general or special. A general service vests the heir in the right of all heritable subjects, which either do not require seisin, or which have not been perfected by seisin in the person of the ancestor. A special service, followed by seisin, vests the heir in the right of the special subjects in which the ancestor died infected.

26. If an heir, doubtful whether the estate of his ancestor be sufficient for clearing his debts, shall at any time within the *annus deliberandi*, exhibit upon oath a full inventory of all his ancestor's heritable subjects, to the clerk of the shire where the lands lie; or, if there is no heritage requiring seisin, to the clerk of the shire where he died; and if, after the same is subscribed by the the-

riff or sheriff depute, the clerk, and himself, and registered in the sheriff's books, the extract thereof shall be registered within forty days after expiry of the *annus deliberandi* in the general register appointed for that purpose, his subsequent entry will subject him no farther than to the value of such inventory. If the inventory be given up and registered within the time prescribed, the heir may serve on it, even after the year.

27. Creditors are not obliged to acquiesce in the value of the estate given up by the heir; but, if they be real creditors, may bring the estate to a public sale, in order to discover its true value; since an estate is always worth what can be got for it. An heir by inventory, as he is, in effect, a trustee for the creditors, must account for that value to which the estate may have been improved since the death of the ancestor, and he must communicate to all the creditors the sales he has got in transacting with any one of them.

28. Practice has introduced an anomalous sort of entry, without the interposition of an inquest, by the sole consent of the superior, who, if he be satisfied that the person applying to him is the next heir, grants him a precept (called of *clare constat*, from the first words of its recital), commanding his bailie to infect him in the subjects that belonged to his ancestor. These precepts are, no doubt, effectual against the superior who grants them, and his heirs; and they may, when followed by seisin, afford a title of prescription: But as no person can be declared an heir by private authority, they cannot bar the true heir from entering after twenty years, as a legal entry would have done. Of the same nature is the entry by hasp and staple, commonly used in burgage tenements of houses; by which the bailie, without calling an inquest, cognosces or declares a person heir, upon evidence brought before himself; and, at the same time, infects him in the subject, by the symbol of the hasp and staple of the door. Charges given by creditors to apparent heirs to enter, stand in the place of an actual entry, so as to support the creditor's diligence. §

29. A general service cannot include a special one; since it has no relation to any special subject, and carries only that class of rights on which seisin has not proceeded; but a special service implies a general one of the same kind or character, and consequently carries even such rights as have not been perfected by seisin. Service is not required to establish the heir's right in titles of honour, or offices of the highest dignity; for these descend *jure sanguinis*.

30. An heir, by immixing with his ancestor's estate without entry, subjects himself to his debts, as if he had entered; or, in our law-phrases, incurs a passive title. The only passive title by which an apparent heir becomes liable universally for all his ancestor's debts, is *gestio pro herede*, or his behaving as none but an heir has right to do. Behaviour as heir is inferred, from the apparent heir's int omission, after the death of the ancestor, with any part of the lands or other heritable subjects belonging to the deceased, to which he himself might have completed an active title by entry.

31. This passive title is excluded, if the heir's intromission be by order of law; or if it be founded on singu-

lar titles, and not as heir to the deceased. But an apparent heir's purchasing any right to his ancestor's estate, otherwise than at public roup (auktion), or his possessing it in virtue of rights settled in the person of any near relation of the ancestor, to whom he himself may succeed as heir, otherwise than upon purchase by public sale, is deemed behaviour as heir.

32. Behaviour as heir is also excluded, where the intromission is small, unless an intention to defraud the ancestor's creditors be presumable from the circumstances attending it. Neither is behaviour inferred against the apparent heir, from the payment of his ancestor's debt, which is a voluntary act, and profitable to the creditors: nor by his taking out of briefes to serve: for one may alter his purpose, while it is not completed: nor by his assuming the titles of honour belonging to his ancestor, or exercising an honorary office hereditary in the family; for these are rights annexed to the blood, which may be used without proper representation. But the exercising an heritable office of profit, which may pass by voluntary conveyance, and consequently is adjudgeable, may reasonably be thought to infer a passive title. Lastly, as passive titles have been introduced, merely for the security of creditors; therefore, where questions concerning behaviour arise among the different orders of heirs, they are liable to one another no farther than *in valorem* of their several intromissions.

33. Another passive title in heritage, may be incurred by the apparent heir's accepting a gratuitous right from the ancestor, to any part of that estate to which he himself might have succeeded as heir; and it is called *præceptio hereditatis*, because it is a taking of the succession by the heir before it opens to him by the death of his ancestor. If the right be onerous, there is no passive title; If the consideration paid for it does not amount to its full value, the creditors of the deceased may reduce it, in so far as it is gratuitous, but still it infers no passive title.

34. The heir incurring this passive title is no farther liable, than if he had, at the time of his acceptance, entered heir to the granter, and so subjected himself to the debts that were then chargeable against him; but with the posterior debts he has nothing to do, not even with those contracted between the date of the right, and the infestment taken upon it, and he is therefore called *successor titulo lucrativo post contractum debitum*.

35. Neither of these passive titles takes place, unless the subject intermeddled with or disposed, be such as the intromitter or receiver would succeed to as heir. In this also, these two passive titles agree, that the intromission in both must be after the death of the ancestor; for there can be no *termini habiles* of a passive title, while the ancestor is alive. But in the following respect they differ: *Gestio pro herede*, being a vicious passive title founded upon a quasi delict, cannot be objected against the delinquent's heir, if process has not been litiscontested while the delinquent himself was alive; whereas the *successor titulo lucrativo* is, by the acceptance of the disposition, understood to have entered into a tacit contract with the granter's creditors, by which he undertakes the burden of their debts; and all actions founded on contract are transmissible against heirs.

36. An apparent heir, who is cited by the ancestor's creditor in a process for payment, if he offers any peremptory defence against the debt, incurs a passive title; for he can have no interest to object against it, but in the character of heir. In the same manner, the heir's not renouncing upon a charge to enter heir, infers it: But the effect of both these is limited to the special debt pursued for, or charged upon. This passive title, which is inferred from the heir's not renouncing, has no effect till decree pass against him; and even a renunciation offered after decree, if the decree be in absence, will intitle the heir to a suspension of all diligence against his person and estate, competent upon his ancestor's debts.

37. By the principles of the feudal law, an heir, when he is to complete his titles by special service, must necessarily pass over his immediate ancestor, *e. g.* his father, if he was not infest; and serve heir to that ancestor who was last vest and seised in the right, and in whose *hereditas jacens* the right must remain, till a title be connected thereto from him. As this bore hard upon creditors, who might think themselves secure in contracting with a person whom they saw for some time in the possession of an estate, and from thence conclude that it was legally vested in him; it is therefore provided, that every person, passing over his immediate ancestor who had been three years in possession, and serving heir to one more remote, shall be liable for the debts and deeds of the person interjected, to the value of the estate to which he is served. This being correctory of the feudal maxims, has been strictly interpreted, so as not to extend to the gratuitous deeds of the person interjected, nor to the case where the interjected person was a naked heir, and possessed only civilly through the liferenter.

38. Our law, from its jealousy of the weakness of mankind while under sickness, and of the importunity of friends on that occasion, has declared that all deeds affecting heritage, if they be granted by a person on death-bed, (*i. e.* after contracting that sickness which ends in death), to the damage of the heir, are ineffectual, except where the debts of the grantor have laid him under a necessity to alien his lands. As this law of deathbed is founded solely in the privilege of the heir, deathbed-deeds, when consented to by the heir, are not reducible. The term properly opposed to death bed is *liege poustie*, by which is understood a state of health; and it gets that name, because persons in health have the *legitima potestas*, or lawful power of disposing of their property at pleasure.

39. The two extremes being proved, of the grantor's sickness immediately before signing, and of his death following it, though at the greatest distance of time, did, by our former law, found a presumption that the deed was granted on death bed, which could not have been elided, but by a positive proof of the grantor's convalescence; but now the allegation of death bed is also excluded, by his having lived sixty days after signing the deed. The legal evidence of convalescence is the grantor's having been, after the date of the deed, at kirk OR market unsupported; for a proof of either will secure the deed from challenge. The going to kirk or market must

be performed, when people are met together in the church or churchyard for any public meeting, civil or ecclesiastical, or in the market place at the time of public market. No other proof of convalescence is receiveable, because at kirk and market there are always present unsuspected witnesses, which we can hardly be sure of in any other case.

40. The privilege of setting aside deeds *ex capite lecti*, is competent to all heirs, not to heirs of line only, but of conquest, tailzie, or provision; not only to the immediate, but to remoter heirs, as soon as the succession opens to them. But, where it is consented to or ratified by the immediate heir, it is secured against all challenge even from the remoter. Yet the immediate heir cannot, by any antecedent writing, renounce his right of reduction, and thereby give strength to deeds that may be afterwards granted *in lecto* to his hurt; for no private renunciation can authorise a person to act contrary to a public law; and such renunciation is presumed to be extorted through the fear of exheredation. If the heir should not use this privilege of reduction, his creditor may, by adjudication, transfer it to himself, or he may without adjudication, reduce the deed, libelling upon his interest as creditor to the heir: But the grantor's creditors have no right to this privilege, in regard that the law of death-bed was introduced, not in behalf of the grantor himself, but of his heir.

41. The law of death-bed strikes against dispositions of every subject to which the heir would have succeeded, or from which he would have had any benefit, had it not been so disposed. Deathbed-deeds granted in consequence of a full or proper obligation in *liege poustie*, are not subject to reduction; but, where the antecedent obligation is merely natural, they are reducible. By stronger reason, the deceased cannot, by a deed merely voluntary, alter the nature of his estate on death bed to the prejudice of his heir, so as from heritable to make it moveable; but if he should, in *liege poustie*, exclude his apparent heir, by an irrevocable deed containing reserved faculties, the heir cannot be heard to quarrel the exercise of these faculties on death-bed.

42. In a competition between the creditors of the deceased and of the heir, our law has justly preferred the creditors of the deceased, as every man's estate ought to be liable, in the first place, for his own debt. But this preference is, by the statute, limited to the case where the creditors of the deceased have used diligence against their debtor's estate, within three years from his death; and therefore the heir's creditors may, after that period, affect it for their own payment. All dispositions by an heir, of the ancestor's estate, within a year after his death, are null, in so far as they are hurtful to the creditors of the ancestor. This takes place, though these creditors should have used no diligence, and even where the dispositions are granted after the year: It is thought they are ineffectual against the creditors of the deceased who have used diligence within the three years.

#### Tit. 28. Of Succession in Moveables.

In the succession of moveable rights, it is an universal rule,

10 E

2

rule,

rule, that the next in degree to the deceased (or next of kin) succeeds to the whole; and if there are two or more equally near, all of them succeed by equal parts, without that prerogative, which takes place in heritage, of the eldest son over the younger, or of males over females. Neither does the right of representation, explained Tit. xxvii. 4. obtain in the succession of moveables, except in the single case of a competition between the full blood and the half blood; for a niece by the full blood will be preferred before a brother by the half blood, though she is by one degree more remote from the deceased than her uncle. Where the estate of a person deceased consists partly of heritage, and partly of moveables, the heir in the heritage has no share of the moveables, if there are others as near in degree to the deceased as himself: But when the heir, in such case, finds it his interest to renounce his exclusive claim to the heritage, and betake himself to his right as one of the next of kin, he may collate or communicate the heritage with the others, who in their turn must collate the moveables with him; so that the whole is thrown into one mass, and divided equally among all of them. This doctrine holds, not only in the line of descendants, but of collaterals; for it was introduced, that the heir might in no case be worse than the other next of kin.

2. One may settle his moveable estate upon whom he pleases, excluding the legal successor, by a testament; which is a written declaration of what a person wills to be done with his moveable estate after his death. No testamentary deed is effectual, till the death of the testator; who may therefore revoke it at pleasure, or make a new one, by which the first loses its force; and hence testaments are called, last or latter wills. Testaments, in their strict acceptation, must contain a nomination of executors, *i. e.* of persons appointed to administer the succession according to the will of the deceased: Yet nothing hinders one from making a settlement of moveables, in favour of an universal legatee, though he should not have appointed executors; and on the other part, a testament where executors are appointed, is valid, though the person who is to have the right of succession should not be named. In this last case, if the executor nominated be a stranger, *i. e.* one who has no legal interest in the moveable estate, he is merely a trustee, accountable to the next of kin; but he may retain a third of the dead's part (explained § 6.) for his trouble in executing the testament: in payment of which, legacies, if any be left to him, must be imputed. The heir, if he be named executor, has right to the third as a stranger; but if one be named who has an interest in the legal succession, he has no allowance, unless such interest be less than a third. Nuncupative or verbal testaments are not, by the law of Scotland, effectual for supporting the nomination of an executor, let the subject of the succession be ever so small: But verbal legacies, not exceeding *L* 100 *Scots*, are sustained; and even where they are granted for more, they are ineffectual only as to the excess.

3. A legacy is a donation by the deceased, to be paid by the executor to the legatee. It may be granted, either in the testament, or in a separate writing. Legacies are not due till the grantor's death; and consequently they

can transmit no right to the executors of the legatee, in the event that the grantor survives him.

4. Legacies, where they are general, *i. e.* of a certain sum of money indefinitely, give the legatee no right in any one debt or subject; he can only insist in a personal action against the executor, for payment out of the testator's effects. A special legacy, *i. e.* of a particular debt due to the deceased, or of a particular subject belonging to him, is of the nature of an assignation, by which the property of the special debt or subject vests, upon the testator's death, in the legatee, who can therefore directly sue the debtor or possessor: Yet as no legacy can be claimed till the debts are paid, the executor must be cited in such process, that it may be known, whether there are free effects sufficient for answering the legacy. Where there is not enough for payment of all the legacies, each of the general legatees must suffer a proportional abatement: But a special legatee gets his legacy entire, though there should be nothing over for payment of the rest; and on the contrary, he has no claim, if the debt or subject bequeathed should perish, whatever the extent of the free executry may be.

5. Minors, after puberty, can test without their curators, wives without their husbands, and persons interdicted without their interdictors: but bastards cannot test, except in the cases afterwards set forth, Tit. xxix. 3. As a certain share of the goods, falling under the communion that is consequent on marriage, belongs, upon the husband's decease, to his widow, *jure relictae*, and a certain share to the children, called the legitime, portion-natural, or bairns part of gear; one who has a wife or children, though he be the absolute administrator of all these goods during his life, and consequently may alien them by a deed *inter vivos* in *liege poustie*, even gratuitously, if no fraudulent intention to disappoint the wife or children shall appear, yet cannot impair their shares gratuitously on deathbed; nor can he dispose of his moveables to their prejudice by testament, though it should be made in *liege poustie*; since testaments do not operate till the death of the testator, at which period the division of the goods in communion have their full effect in favour of the widow and children.

6. If a person deceased leaves a widow, but no child, his testament, or, in other words, the goods in communion, divide in two; one half goes to the widow, the other is the dead's part, *i. e.* the absolute property of the deceased, on which he can test, and which falls to his next of kin, if he dies intestate. Where he leaves children, one or more, but no widow, the children get one half as their legitime; the other half is the dead's part, which falls also to the children, if the father has not tested upon it. If he leaves both widow and children, the division is tripartite; the wife takes one third by herself; another falls, as legitime, to the children equally among them, or even to an only child, though he should succeed to the heritage; the remaining third is the dead's part. Where the wife predeceases without children, one half is retained by the husband, the other falls to her next of kin: Where she leaves children, the division ought also to be bipartite, by the common rules of society, since no legitime is truly due on a mother's death;

yet

yet it is in practice tripartite; two thirds remain with the surviving father, as if one third were due to him *proprio nomine*, and another as administrator of the legitime for his children; the remaining third, being the wife's share, goes to her children, whether of that or any former marriage, for they are all equally her next of kin.

7. Before a testament can be divided, the debts owing by the deceased are to be deducted; for all executry must be free. As the husband has the full power of burdening the goods in communion, his debts affect the whole, and so lessen the legitime and the share of the relict, as well as the dead's part. His funeral charges, and the mournings and alimony due to the widow, are considered as his proper debts: but the legacies, or other gratuitous rights, granted by him on deathbed, affect only the dead's part. Bonds bearing interest, due by the deceased, cannot diminish the relict's share, because such bonds, when due to the deceased, do not increase it. The funeral charges of the wife predeceasing, fall wholly on her executors who have right to her share. Where the deceased leaves no family, neither husband, wife, nor child, the testament suffers no division, but all is the dead's part.

8. The whole issue of the husband, not only by that marriage which was dissolved by his death, but by any former marriage, has an equal interest in the legitime; otherwise the children of the first marriage would be cut out, as they could not claim the legitime during their father's life. But no legitime is due, 1. Upon the death of a mother. 2. Neither is it due to grandchildren, upon the death of a grandfather. Nor, 3. To children forisfamiliaried, *i. e.* to such as, by having renounced the legitime, are no longer considered as *in familia*, and so are excluded from any farther share of the moveable estate than they have already received.

9. As the right of legitime is strongly founded in nature, the renunciation of it is not to be inferred by implication. Renunciation by a child of his claim of legitime has the same effect as his death, in favour of the other children intitled thereto; and consequently the share of the renouncer divides among the rest; but he does not thereby lose his right to the dead's part, if he does not also renounce his share in the father's executry. Nay, his renunciation of the legitime, where he is the only younger child, has the effect to convert the whole subject thereof into dead's part, which will therefore fall to the renouncer himself as next of kin, if the heir be not willing to collate the heritage with him.

10. For preserving an equality among all the children, who continue intitled to the legitime, we have adopted the Roman doctrine of *collatio bonorum*; whereby the child, who has got a provision from his father, is obliged to collate it with the others, and impute it towards his own share of the legitime; but if, from the deed of provision, the father shall appear to have intended it as a *præcipuum* to the child, collation is excluded. A child is not bound to collate an heritable subject provided to him, because the legitime is not impaired by such provision. As this collation takes place only in questions among children who are intitled to the legitime, the relict is not bound to collate donations given her by her husband, in order to increase the legitime; and on the other

part, the children are not obliged to collate their provisions, in order to increase her share.

11. As an heir in heritage must complete his titles by entry, so an executor is not vested in the right of the moveable estate of the deceased without confirmation. Confirmation is a sentence of the Commissary or Bishop's court, empowering an executor, one or more, upon making inventory of the moveables pertaining to the deceased, to recover, possess, and administer them, either in behalf of themselves, or of others interested therein. Testaments must be confirmed in the commissariat where the deceased had his principal dwelling house at his death. If he had no fixed residence, or died in a foreign country, the confirmation must be at *Edinburgb*, as the *commune forum*; but if he went abroad with an intention to return, the commissariat within which he resided, before he left Scotland, is the only proper court.

12. Confirmation proceeds upon an edict, which is affixed on the door of the parish-church where the deceased dwelt, and serves to intimate to all concerned the day of confirmation, which must be nine days at least after publishing the edict. In a competition for the office of executor, the Commissary prefers, *primo loco*, the person named to it by the deceased himself, whose nomination he ratifies or confirms, without any previous decerniture; this is called the confirmation of a testament-testamentary. In default of an executor named by the deceased, universal dispoonees are by the present practice preferred; after them, the next of kin; then the relict; then creditors; and lastly, special legatees. All these must be decerned executors, by a sentence called a decree-dative; and if afterwards they incline to confirm, the Commissary authorises them to administer, upon their making inventory, and giving security to make the subject thereof forthcoming to all having interest; which is called the confirmation of a testament dative.

13. A creditor, whose debtor's testament is already confirmed, may sue the executor, who holds the office for all concerned, to make payment of his debt. Where there is no confirmation, he himself may apply for the office, and confirm as executor creditor; which intitles him to sue for, and receive the subject confirmed, for his own payment: And where one applies for a confirmation, as executor creditor, every co-creditor may apply to be conjoined with him in the office. As this kind of confirmation is simply a form of diligence, creditors are exempted from the necessity of confirming more than the amount of their debts.

14. A creditor, whose debt has not been constituted, or his claim not closed by decree, during the life of his debtor, has no title to demand directly the office of executor *qua* creditor; but he may charge the next of kin who stands off, to confirm, who must either renounce within twenty days after the charge, or be liable for the debt; and if the next of kin renounces, the pursuer may constitute his debt, and obtain a decree *cognitionis causa*, against the *hereditas jacens* of the moveables, upon which he may confirm as executor creditor to the deceased. Where one is creditor, not to the deceased, but to his next of kin who stands off from confirming, he may affect the moveables of the deceased, by obtaining himself decerned



decearned executor-ative to the deceased, as if he were creditor to him, and not to his next of kin.

15. Where an executor has either omitted to give up any of the effects belonging to the deceased in inventory, or has estimated them below their just value, there is place for a new confirmation, *ad omiffa, vel male appretiatas*, at the suit of any having interest; and if it appears that he has not omitted or undervalued any subject *doloſe*, the Commissary will ordain the subjects omitted, or the difference between the estimations in the principal testament and the true values, to be added thereto; but if *doloſe* shall be presumed, the whole subject of the testament *ad omiffa vel male appretiatas*, will be carried to him who confirms it, to the exclusion of the executor in the principal testament.

16. The legitime and relict's share, because they are rights arising *ex lege*, operate *ipſo jure*, upon the father's death, in favour of the relict and children; and consequently pass from them, though they should die before confirmation, to their next of kin: Whereas the dead's part, which falls to the children or other next of kin in the way of succession, remains, if they should die before confirming, *in bonis* of the first deceased; and so does not descend to their next of kin, but may be confirmed by the person who, at the time of confirmation, is the next of kin to the first deceased. Special assignments, though neither intimated, nor made public, during the life of the granter, carry to the assignee the full right of the subjects assigned, without confirmation. Special legacies are really assignments, and so fall under this rule. The next of kin, by the bare possession of the *ipſa corpora* of moveables, acquires the property thereof without confirmation, and transmits it to his executors.

17. The confirmation of any one subject by the next of kin, as it proves his right of blood, has been adjudged to carry the whole executry out of the testament of the deceased, even what was omitted, and to transmit all to his own executors. The confirmation of a stranger, who is executor nominated, as it is merely a trust for the next of kin, has the effect to establish the right of the next of kin to the subjects confirmed, in the same manner as if himself had confirmed them.

18. Executry, though it carries a certain degree of representation of the deceased, is properly an office: Executors therefore are not subjected to the debts due by the deceased, beyond the value of the inventory; but, at the same time, they are liable in diligence for making the inventory effectual to all having interest. An executor-creditor who confirms more than his debt amounts to, is liable in diligence for what he confirms. Executors are not liable in interest, even upon such bonds recovered by them as carried interest to the deceased, because their office obliges them to retain the sums they have made effectual, in order to a distribution thereof among all having interest. This holds though they should again lend out the money upon interest, as they do it at their own risk.

19. There are certain debts of the deceased called privileged debts, which were always preferable to every other. Under that name are comprehended, medicines furnished to the deceased on death-bed, physicians fees during that period, funeral charges, and the rent of his house, and

his servant's wages for the year or term current at his death. These the executors are in safety to pay on demand. All the other creditors, who either obtain themselves confirmed, or who cite the executor already confirmed, within six months after their debtor's death, are preferred, *pari passu*, with those who have done more timely diligence; and therefore no executor can either retain for his own debt, or pay a testamentary debt, so as to exclude any creditor, who shall use diligence within the six months, from the benefit of the *pari passu* preference; neither can a decree for payment of debt be obtained, in that period, against an executor, because, till that term be elapsed, it cannot be known how many creditors may be intitled to the fund in his hands. If no diligence be used within the six months, the executor may retain for his own debt, and pay the residue *primo venienti*. Such creditors of the deceased as have used diligence within a year after their debtor's death, are preferable on the subject of his testament to the creditors of his next of kin.

20. The only passive title in moveables is vitious intromission, which may be defined an unwarrantable intermeddling with the moveable estate of a person deceased, without the order of law. This is not confined, as the passive titles in heritage are, to the persons interested in the succession, but strikes against all intromitters whatever. Where an executor confirmed, intromits with more than he has confirmed, he incurs a passive title, fraud being in the common case presumed from his not giving up in inventory the full subject intermeddled with. Vitious intromission is also presumed, where the repositories of a dying person are not sealed up, as soon as he becomes incapable of sense, by his nearest relations; or, if he dies in a house not his own, they must be sealed by the master of such house and the keys delivered to the Judge-ordinary, to be kept by him, for the benefit of all having interest.

21. The passive title of vitious intromission does not take place where there is any probable title or circumstance that takes off the presumption of fraud. In consequence of this rule, necessary intromission, or *custodia causa*, by the wife or children, who only continue the possession of the deceased, in order to preserve his goods for the benefit of all concerned, incurs no passive title. And upon the same principle, an intromitter, by confirming himself executor, and thereby subjecting himself to account, before action be brought against him on the passive titles, purges the vitiosity of his prior intromission: And where the intromitter is one who is interested in the succession, *e. g.* next of kin, his confirmation, at any time within a year from the death of the deceased, will exclude the passive title, notwithstanding a prior citation. As this passive title was intended only for the security of creditors, it cannot be sued upon by legatees; and since it arises *ex delicto*, it cannot be pleaded against the heir of the intromitter. As in delicts, any one of many delinquents may be subjected to the whole punishment, so any one of many intromitters may be sued *in solidum* for the pursuer's debt, without calling the rest; but the intromitter who pays, has an action of relief against the others for their share of it. If the intromitters are sued jointly,

jointly, they are liable, not *pro rata* of their several intromissions, but *pro virili*.

28. The whole of a debtor's estate is subjected to the payment of his debts; and therefore, both his heirs and executors are liable for them, in a question with creditors; but as succession is by law divided into the heritable and the moveable estate, each of these ought, in a question between the several successors, to bear the burdens which naturally affect it. Action of relief is accordingly competent to the heir who has paid a moveable debt, against the executor; and *vice versa*. This relief is not cut off by the deceased's having disposed either his land-estate or his moveables, with the burden of his *whole* debts; for such burden is not to be construed as an alteration of the legal succession, but merely as a farther security to creditors, unless the contrary shall be presumed from the special style of the disposition.

#### Tit. 29. Of last Heirs and Bastards.

By our ancient practice, feudal grants taken to the vassal, and to a special order of heirs, without settling the last termination upon *heirs whatsoever*, returned to the superior, upon failure of the special heirs therein contained, but now that feus are become patrimonial rights, the superior is, by the general opinion, held to be fully divested by such grant, and the right descends to the vassal's heirs at law. And even where a vassal dies, without leaving any heir who can prove the remotest propinquity to him, it is not the superior, as the old law stood, but the King, who succeeds as last heir, both in the heritable and moveable estate of the deceased, in consequence of the rule, *Quod nullius est, cedit domino Regi*.

2. If the lands, to which the King succeeds, be holden immediately of himself, the property is consolidated with the superiority, as if resignation had been made in the Sovereign's hands. If they are holden of a subject, the King, who cannot be vassal to his own subject, names a donatory; who, to complete his title, must obtain decree of declarator; and thereafter he is presented to the superior, by letters of presentation from the King under the quarter-seal, in which the superior is charged to enter the donatory. The whole estate of the deceased is, in this case, subjected to his debts, and to the widow's legal provisions. Neither the King nor his donatory is liable beyond the value of the succession. A person who has no heir to succeed to him, cannot alien his heritage *in lesso*, to the prejudice of the King, who is intitled to set aside such deed, in the character of *ultimus heres*.

3. A bastard can have no legal heirs, except those of his own body; since there is no succession but by the father, and a bastard has no certain father. The King therefore succeeds to him, failing his lawful issue, as last heir. Though the bastard, as absolute proprietor of his own estate, can dispose of his heritage in *liege pousie*, and of his moveables by any deed *inter vivos*; yet he is disabled, *ex defectu natalium*, from bequeathing by testament, without letters of legitimation from the Sovereign. If the bastard has lawful children, he may test, without such letters, and name tutors and curators to his issue.

Letters of legitimation, let their clauses be ever so strong, cannot enable the bastard to succeed to his natural father, to the exclusion of lawful heirs.

4. The legal rights of succession, being founded in marriage, can be claimed only by those who are born in lawful marriage; the issue therefore of an unlawful marriage are incapable of succession. A bastard is excluded, 1. From his father's succession; because law knows no father, who is not marked out by marriage. 2. From all heritable succession, whether by the father or mother; because he cannot be pronounced lawful heir by the inquest, in terms of the brief; and, 3. From the moveable succession of his mother; for, though the mother be known, the bastard is not her lawful child, and legitimacy is implied in all succession conferred by law. A bastard, though he cannot succeed *jure sanguinis*, may succeed by destination, where he is specially called to the succession by an entail or testament.

5. Certain persons, though born in lawful marriage, are incapable of succession. Aliens are, from their allegiance to a foreign prince, incapable of succeeding in *feudal rights*, without naturalization. Children born in a foreign state, whose fathers were natural born subjects, and not attainted, are held to be natural born subjects. Persons educated in, or professing the Popish religion, if they shall neglect, upon their attaining the age of fifteen, to renounce its doctrines by a signed declaration, cannot succeed in *heritage*; but must give place to the next Protestant heir, who will hold the estate irredeemably, if the Popish heir does not, within ten years after incurring the irritancy, sign the *formula* prescribed by the statute 1700, c. 3.

#### Tit. 30. Of Actions.

HITHERTO of *persons* and *rights*, the two first objects of law; *actions* are its third object, whereby persons make their rights effectual. An action may be defined, a demand regularly made and insisted in, before the judge competent, for the attaining or recovering of a right; and it suffers several divisions, according to the different natures of the rights pursued upon.

2. Actions are either real or personal. A real action, is that which arises from a right in the thing itself, and which therefore may be directed against all possessors of that thing: Thus, an action for the recovery, even of a moveable subject, when founded on a *jus in re*, is in the proper acceptance real; but real actions are, in vulgar speech, confined to such as are directed against heritable subjects. A personal action is founded only on an obligation undertaken for the performance of some fact, or the delivery of some subject; and therefore can be carried on against no other than the person obliged, or his heirs.

3. Actions are either ordinary or rescissory. All actions are, in the sense of this division, ordinary, which are not rescissory. Rescissory actions are divided, 1. Into actions of proper improbation. 2. Actions of reduction improbation. 3. Actions of simple reduction. Proper improbations, which are brought for declaring writings false or forged, are treated of below, Tit. 33.

Reduction improbation is an action, whereby a person who may be hurt or affected by a writing, insists for producing or exhibiting it in court, in order to have it set aside, or its effect ascertained, under the certification that the writing, if not produced, shall be declared false and forged. This certification is a fiction of law, introduced that the production of writings may be the more effectually forced, and therefore it operates only in favour of the pursuer. Because the summons in this action proceeds on alledged grounds of falsehood, his Majesty's Advocate, who is the public prosecutor of crimes, must concur in it.

4. As the certification in this process draws after it so heavy consequences, two terms are assigned to the defenders for production. After the second term is elapsed, intimation must be made judicially to the defender, to satisfy the production within ten days; and till these are expired, no certification can be pronounced. Certification cannot pass against deeds recorded in the books of Session, if the defender shall, before the second term, offer a condescence of the dates of their registration, unless falsehood be objected; in which case, the original must be brought from the record to the court. But an extract from the inferior court is no bar to certification; the principal writing must be laid before the court of Session on a proper warrant.

5. In an action of simple reduction the certification is only temporary, declaring the writings called for, null, until they be produced; so that they recover their full force after production, even against the pursuer himself; for which reason, that process is now seldom used. Because its certification is not so severe as in reduction-improbation, there is but on term assigned to the defender for producing the deeds called for.

6. The most usual grounds of reductions of writings are, the want of the requisite solemnities; that the granter was minor, or interdicted, or inhibited; or that he signed the deed on death bed, or was compelled or frightened into it, or was circumvented; or that he granted it in prejudice of his lawful creditors.

7. In reductions on the head of force, or fear, or fraud and circumvention, the pursuer must libel the particular circumstances from which his allegation is to be proved. Reduction is not competent upon every degree of force or fear; it must be such as would shake a man of constancy and resolution. Neither is it competent, on that fear which arises from the just authority of husbands or parents over their wives or children, nor upon the fear arising from the regular execution of lawful diligence by caption, provided the deeds granted under that fear relate to the ground of debt contained in the diligence; but if they have no relation to that debt, they are reducible *ex metu*.

8. Alienations granted by debtors after contracting of lawful debts, in favour of conjunct or confident persons, without just and necessary causes, and without a just price really paid, are null. One is deemed a prior creditor, whose ground of debt existed before the right granted by the debtor; though the written voucher of the debt should bear a date posterior to it. Persons are accounted conjuncts, whose relation to the granter is so

near, as to bar them from judging in his cause. Confident persons are those who appear to be in the granter's confidence, by being employed in his affairs, or about his person: as a doer, steward, or domestic servant.

9. Rights, though gratuitous, are not reducible, if the granter had, at the date thereof, a sufficient fund for the payment of his creditors. Provisions to children are, in the judgment of law, gratuitous; so that their effect, in a question with creditors, depends on the solvency of the granter: But settlements to wives, either in marriage contracts, or even after marriage, are onerous, in so far as they are rational; and consequently are not reducible, even though the granter was insolvent. This rule holds also in rational tochers contracted to husbands: But it must, in all cases, be qualified with this limitation, *if the insolvency of the granter was not publicly known*; for if it was, fraud is presumed in the receiver of the right, by contracting with the bankrupt.

10. The receiver of the deed, if he be a conjunct or confident person, must abstract or support the onerous cause of his right, not merely by his own oath, but by some circumstances or adminicles. But where a right is granted to a stranger, the narrative of it expressing an onerous cause, is sufficient *per se* to secure it against reduction.

11. All voluntary payments or rights made by a bankrupt to one creditor, to disappoint the more timeous diligence of another, are reducible at the instance of that creditor who has used the prior diligence. A creditor, though his diligence be but begun by citation, may insist in a reduction of all posterior voluntary rights granted to his prejudice; but the creditor who neglects to complete his begun diligence within a reasonable time, is not intitled to reduce any right granted by the debtor, after the time that the diligence is considered as abandoned.

12. A prohibited alienation, when conveyed by the receiver to another who is not privy to the fraud, subsists in the person of the *bona fide* purchaser. In the case of moveable rights, this nullity is receivable by exception; but it must be declared by reduction, where the right is heritable.

13. By act 1696, c. 5. all alienations by a bankrupt, within sixty days before his bankruptcy, to one creditor in preference to another, are reducible, at the instance even of such co-creditors as had not used the least step of diligence. A bankrupt is there described by the following characters; diligence used against him by horning and caption; and insolvency, joined either with imprisonment, retiring to the sanctuary, absconding, or forcibly defending himself from diligence. It is sufficient that a caption is raised against the debtor, though it be not executed, provided he has retired to shun it. It is provided, that all heritable bonds or rights on which *seisin* may follow, shall be reckoned, in a question with the granter's other creditors upon this act, to be of the date of the *seisin* following thereon. But this act was found to relate only to securities for former debts, and not to *nova debita*.

14. Actions are divided into *rei persequutio*, and *personalis*. By the first, the pursuer insists barely to recover the subject that is his, or the debt due to him; and this

includes the damage sustained; for one is as truly a sufferer in his patrimonial interest by that damage, as by the loss of the subject itself. In penal actions, which always arise *ex delicto*, something is also demanded by way of penalty.

15. Actions of spuilzie, ejection, and intrusion, are penal. An action of spuilzie is competent to one dispossessed of a moveable subject violently, or without order of law, against the person dispossessing; not only for being restored to the possession of the subject, if extant, or for the value, if it be destroyed, but also for the violent profits, in case the action be brought within three years from the spoliation. Ejection and intrusion are, in heritable subjects, what spuilzie is in moveables. The difference between the two first is, that in ejection, violence is used; whereas the intruder enters into the void possession, without either a title from the proprietor, or the warrant of a judge. The actions arising from all the three are of the same general nature.

16. The action of contravention of law-borrows is also penal. It proceeds on letters of law-borrows, (from *borgh* a cautioner), which contain a warrant to charge the party complained upon, that he may give security, not to hurt the complainer in his person, family, or estate. These letters do not require the previous citation of the party complained upon, because the caution which the law requires is only for doing what is every man's duty; but, before the letters are executed against him, the complainer must make oath that he dreads bodily harm from him. The penalty of contravention is ascertained to a special sum, according to the offender's quality; the half to be applied to the silk, and the half to the complainer. Contravention is not incurred by the uttering of reproachful words, where they are not accompanied, either with acts of violence, or at least a real injury; and as the action is penal, it is elided by any probable ground of excuse.

17. Penalties are the consequences of delict, or transgression; and as no heir ought to be accountable for the delict of his ancestor, farther than the injured person has really suffered by it, penal actions die with the delinquent, and are not transmissible against heirs. Yet the action, if it has been commenced, and litiscontested in the delinquent's lifetime, may be continued against the heir, though the delinquent should die during the dependence. Some actions are *rei persecutoria* on the part of the pursuer, when he insists for simple restitution; which yet may be penal in respect of the defender; e. g. the action on the passive title of vitious intromission, by which the pursuer frequently recovers the debt due to him by the deceased, though it should exceed the value of the goods intermeddled with by the defenders.

18. The most celebrated division of actions in our law, is into *petitory*, *possessory*, and *declaratory*. *Petitory* actions are those, where something is demanded from the defender, in consequence of a right of property, or of credit in the pursuer: Thus, actions for restitution of moveables, actions of poinding, or forthcoming, and indeed all personal actions upon contracts or quasi contracts, are petitory. *Possessory* actions are those which are founded, either upon possession alone, as spuilzies; or

upon possession joined with another title, as removings; and they are competent either for getting into possession, for holding it, or for recovering it; analogous to the interdicts of the Roman law, *quorum bonorum*, *uti possidetis*, and *unde vi*.

16. An action of molestation is a possessory action, competent to the proprietor of a land-estate, against those who disturb his possession. It is chiefly used in questions of commonry, or of controverted marches. Where a declarator of property is conjoined with a process of molestation, the session alone is competent to the action. Actions on brieves of perambulation, have the same tendency with molestations, *viz.* the settling of marches between conterminous lands.

20. The action of mails and duties is sometimes petitory, and sometimes possessory. In either case, it is directed against the tenants and natural possessors of land-estates, for payment to the pursuer of the rents remaining due by them for past crops, and of the full rent for the future. It is competent, not only to a proprietor whose right is perfected by seisin, but to a simple disponee, for a disposition of lands includes a right to the mails and duties; and consequently to an adjudger, for an adjudication is a judicial disposition. In the petitory action, the pursuer, since he founds upon right, not possession, must make the proprietor, from whom the tenants derive their right, party to the suit; and he must support his claim by titles of property or diligences, preferable to those in the person of his competitor. In the possessory, the pursuer, who libels that he, his ancestors or authors, have been seven years in possession, and that therefore he has the benefit of a possessory judgment, need produce no other title than a seisin, which is a title sufficient to make the possession of heritage lawful; and it is enough, if he calls the natural possessors, though he should neglect the proprietor. A possessory judgment founded on seven years possession, in consequence either of a seisin or a tack, has this effect, that though one should claim under a title preferable to that of the possessor, he cannot compete with him in the possession, till in a formal process of reduction he shall obtain the possessor's title declared void.

21. A *declaratory* action is that, in which some right is craved to be declared in favour of the pursuer, but nothing sought to be paid or performed by the defender, such as declarators of marriage, of irritancy, of expiry of the legal reversion, &c. Under this class may be also comprehended rescissory actions, which, without any personal conclusion against the defender, tend simply to set aside the rights or writings libelled, in consequence of which a contrary right or immunity arises to the pursuer. Decrees upon action that are properly declaratory confer no new right; they only declare what was the pursuer's right before, and so have a retrospect to the period at which that right first commenced. Declarators, because they have no personal conclusion against the defender, may be pursued against an apparent heir without a previous charge given him to enter to his ancestor; unless where special circumstances require a charge.

22. An action for proving the tenor, whereby a writing, which is destroyed or amissing, is endeavored to be revived, is in effect declaratory. In obligations that are extinguishable

extinguishable barely by the debtor's retiring or cancelling them, the pursuer, before a proof of the tenor is admitted, must condescend on such a *casus amissionis*, or accident by which the writing was destroyed, as shews it was lost when in the creditor's possession; otherwise bonds that have been cancelled by the debtor on payment, might be reared up as still subsisting against him: But in writings which require contrary deeds to extinguish their effect, as assignments, dispositions, charters, &c. it is sufficient to libel that they were lost, even *casu fortuito*.

23. Regularly, no deed can be revived by this action, without some adminicle in writing, referring to that which is libelled; for no written obligation ought to be raised up barely on the testimony of witnesses. If these adminicles afford sufficient conviction, that the deed libelled did once exist, the tenor is admitted to be proved by witnesses, who must depose, either that they were present at signing the deed, or that they afterwards saw it duly subscribed. Where the relative writings contain all the substantial clauses of that which is lost, the tenor is sometimes sustained without witnesses. In a writing which is libelled to have contained uncommon clauses, all these must appear by the adminicles. Actions of proving the tenor are, on account of their importance, appropriated to the court of Session; and, by the old form, the testimony of the witnesses could not be received, but in presence of all the judges.

24. The action of double or multiple pointing may be also reckoned declaratory. It is competent to a debtor, who is distressed, or threatened with distress, by two or more persons claiming right to the debt, and who therefore brings the several claimants into the field, in order to debate and settle their several preferences, that so he may pay securely to him whose right shall be found preferable. This action is daily pursued by an arrestee, in the case of several arrestments used in his hands for the same debt; or by tenants in the case of several adjudgers, all of whom claim right to the same rents. In these competitions, any of the competitors may bring an action of multiple pointing in name of the tenants, or other debtors, without their consent, or even though they should disclaim the process; since the law has introduced it as the proper remedy for getting such competitions determined: And while the subject in controversy continues *in medio*, any third person who conceives he has a right to it, may, though he should not be cited as a defender, produce his titles, as if he were an original party to the suit, and will be admitted for his interest in the competition.

25. Certain actions may be called accessory, because they are merely preparatory or subservient to other actions. Thus, exhibitions *ad deliberandum*, at the instance of an heir against the creditors or custodiers of his ancestor's writings, are intended only to pave the way for future processes. An action of transference is also of this sort, whereby an action, during the pendency of which the defender happens to die, is craved to be transferred against his representative, in the same condition in which it stood formerly. Upon the pursuer's death, his heir may insist in the cause against the defender, upon producing, either a retour or a confirmed testament, ac-

cording as the subject is heritable or moveable. Transferences being but incidental to other actions, can be pronounced by that inferior judge alone before whom the principal cause depended; but, where the representatives of the deceased live in another territory, it is the supreme court which must transfer. Obligations may be now regiltred summarily after the creditor's death; which before was not admitted, without a separate process of registration, to which the granter was necessarily to be made a party.

26. A process of wakening is likewise accessory. An action is said to sleep, when it lies over, not insisted in for a year, in which case its effect is suspended; but even then it may, at any time within the years of prescription, be revived or wakened by a summons, in which the pursuer recites the last step of the process, and concludes that it may be again carried on as if it had not been discontinued. An action that stands upon any of the inner-house rolls cannot sleep; nor an action in which decree is pronounced, because it has got its full completion: Consequently the decree may be extracted after the year, without the necessity of a wakening.

27. An action of transumpt falls under the same class. It is competent to those, who have a partial interest in writings that are not in their own custody, against the possessors thereof, for exhibiting them, that they may be transumed for their behoof. Though the ordinary title in this process be an obligation by the defender to grant transumps to the pursuer, it is sufficient if the pursuer can show that he has an interest in the writings; but, in this case, he must transume them on his own charges. Actions of transumpt may be pursued before any judge-ordinary. After the writings to be transumed are exhibited, full duplicates are made out, collated, and signed, by one of the clerks of court, which are called transumps, and are as effectual as an extract from the register.

28. Actions proceeded anciently upon brieves issuing from the chancery, directed to the justiciary or judge-ordinary, who tried the matter by a jury, upon whose verdict judgment was pronounced: And to this day, we retain certain brieves, as of *inquest*, *terce*, *ideoty*, *tutory*, *perambulation*, and perhaps two or three others: But summonses were, immediately upon the institution of the College of Justice, introduced in the place of brieves. A summons, when applied to actions pursued before the session, is a writ in the King's name, issuing from his signet upon the pursuer's complaint, authorising messengers to cite the defender to appear before the court, and make his defences; with certification if he fail to appear, that decree will be pronounced against him in terms of the certification of the summons.

29. The days indulged by law to a defender, between his citation and appearance, to prepare for his defence, are called *inducie legales*. If he is within the kingdom, twenty one and six days, for the first and second diets of appearance, must be allowed him for that purpose; and if out of it, sixty and fifteen. Defenders residing in Orkney or Zetland must be cited on forty days. In certain summonses which are privileged, the *inducie* are shortened: Spuilzies and ejections proceed on fifteen days; wakings

wakenings and transferences, being but incidental, on six; see the list of privileged summonses, in act of sederunt June 29. 1672. A summons must be executed, *i. e.* served against the defender, so as the last diet of appearance may be within a year after the date of the summons; and it must be called within a year after that diet, otherwise it falls for ever. Offence against the authority of the court, acts of malversation in office by any member of the college of justice, and acts of violence and oppression committed during the dependence of a suit by any of the parties, may be tried without a summons, by a summary complaint.

30. Where an action is in part penal, *e. g.* a removing, spuilzie, &c. a pursuer who restricts his demand to, and obtains decree merely for restitution, cannot thereafter bring a new process for the violent profits. Yet the same fact may be the foundation both of a criminal and civil action, because these two are intended for different purposes; the one for satisfying the public justice, the other for indemnifying the private party: And though the defender should be absolved in the criminal trial, for want of evidence, the party injured may bring an action *ad civilem effectum*, in which he is intitled to refer the libel to the defender's oath.

31. One libel or summons may contain different conclusions on the same ground of right, rescissory, declaratory, petitory, &c. if they be not repugnant to each other: Nay, though different sums be due to one, upon distinct grounds of debt, or even by different debtors, the creditor may insist against them all in the same summons.

32. Defences are pleas offered by a defender for eliding an action. They are either dilatory, which do not enter into the cause itself, and so can only procure an absolviture from the *lis pendens*: Or peremptory, which entirely cut off the pursuer's right of action. The first, because they relate to the forms of proceeding, must be offered *in limine judicii*, and all of them at once. But peremptory defences may be proponed at any time before sentence.

33. A cause, after the parties had litigated it before the judge, was said by the Romans to be litiscontested. By litiscontestation a judicial contract is understood to be entered into by the litigants, by which the action is perpetuated against heirs, even when it arises *ex delicto*. By our law, litiscontestation is not formed till an act is extracted, admitting the libel or defences to proof.

### Tit. 31. Of Probation.

ALL allegations by parties to a suit, must be supported by proper proof. Probation is either by writing, by the party's own oath, or by witnesses. In the case of allegations, which may be proved by either of the three ways, a proof is said to be admitted *prout de jure*; because in such case, all the legal methods of probation are competent to the party: If the proof he brings by writing be lame, he may have recourse either to witnesses or to his adversary's oath: but, if he should first take himself to the proof by oath, he cannot thereafter use any other probation, for the reason assigned § 3. and, on

VOL. II. Numb. 66.

2

the contrary, a pursuer, who has brought a proof by witness, on an extracted act, is not allowed to recur to the oath of the defender. Single combat, as a sort of appeal to Providence, was, by our ancient law, admitted as evidence, in matters both civil and criminal. It was afterwards restricted to the case of such capital crimes where no other proof could be had; some traces of this blind method of trial remained even in the reign of J. VI. who, by 1600. c. 12. might authorise duels on weighty occasions.

2. As obligations or deeds signed by the party himself, or his ancestors or authors, must be, of all evidence, the least liable to exception; therefore every debt or allegation may be proved by proper evidence in writing. The solemnities essential to probative deeds have been already explained, Tit. xxi. 3. *et seq.* Books of account kept by merchants, tradesmen, and other dealers in business, though not subscribed, are probative against him who keeps them; and, in case of furnishings by a shop-keeper, such books, if they are regularly kept by him, supported by the testimony of a single witness, afford a *semiplena probatio* in his favour, which becomes full evidence by his own oath in supplement. Notorial instruments and executions by messengers bear full evidence, that the solemnities therein set forth were used, not to be invalidated otherwise than by a proof of falsehood; but they do not prove any other extrinsic facts therein averred, against third parties.

3. Regularly, no person's right can be proved by his own oath, nor taken away by that of his adversary; because these are the bare averments of parties in their own favour. But, where the matter in issue is referred by one of the parties to the oath of the other, such oath, though made in favour of the deponent himself, is decisive of the point; because the reference is a virtual contract between the litigants, by which they are understood to put the issue of the cause upon what shall be deposed: And this contract is so strictly regarded, that the party who refers to the oath of the other cannot afterwards, in a civil action, plead upon any deed against the party deposing, inconsistent with his oath. To obviate the snares that may be laid for perjury, he, to whose oath of verity a point is referred, may refuse to depose, till his adversary swear that he can bring no other evidence in proof of his allegation.

4. A defender, though he cannot be compelled to swear to facts in a libel properly criminal; yet may, in trespasses where the conclusion is limited to a fine, or to damages. In general, an oath of party cannot either hurt or benefit third parties; being, as to them, *res inter alios acta*.

5. An oath upon reference, is sometimes qualified by special limitations restricting it. The qualities which are admitted by the judge as part of the oath, are called intrinsic; those which the judge rejects or separates from the oath, extrinsic. Where the quality makes a part of the allegation which is relevantly referred to oath, it is intrinsic. Thus, because a merchant, suing for furnishings after the three years, must, in order to make a relevancy, offer to prove by the defender's oath, not only the delivery of the goods, but that the price is still due; there-

† 10 G

fore

fore, though the defender should acknowledge upon oath his having received the goods, yet, if he adds, that he paid the price, this last part, being a denial that the debt subsists, is intrinsic, since it is truly the point referred to oath. Where the quality does not import an extinction of the debt, but barely a counter-claim, or *mutua petitio*, against the pursuer, it is held as extrinsic, and must be proved *aliunde*. Neither can a defender who in his oath admits the constitution of a debt, get off by objecting the quality of payment, where the payment ought by its nature to be vouched by written evidence.

6 Oaths of verity are sometimes deferred by the judge to either party, *ex officio*; which because they are not founded on any implied contract between the litigants, are not finally decisive, but may be traversed on proper evidence afterwards produced. These oaths are commonly put by the judge for supplying a law: or imperfect proof, and are therefore called oaths in supplement. See § 2.

7. To prevent groundless allegations, oaths of calumny have been introduced, by which either party may demand his adversary's oath, that he believes the fact contained in his libel or defences to be just and true. As this is an oath, not of verity, but only of opinion, the party who puts it to his adversary, does not renounce other probation; and therefore no party is bound to give an oath of calumny, on recent facts of his own, for such oath is really an oath of verity. These oaths have not been so frequent since the act of federunt, Feb. 1. 1715, whereby any party, against whom a fact shall be alleged, is obliged, without making oath, to confess or deny it; and in case of calumnious denial, is subjected to the expence that the other party has thereby incurred.

8. In all oaths, whether of verity or calumny, the citation carries, or at least implies, a certification, that if the party does not appear at the day assigned for deposing, he shall be held *pro confesso*; from a presumption of his consciousness, that the fact upon which he declines to swear makes against him; but no party can be held *pro confesso*, if he be in the kingdom, without a previous personal citation used against him. Though an oath which resolves into a *non meministi*, cannot be said to prove any point; yet where one so deposes upon a recent fact, to which he himself was privy, his oath is considered as a dissembling of the truth, and he is held *pro confesso*, as if he had refused to swear.

9. An oath *in litem*, is that which the judge defers to a pursuer, for ascertaining either the quantity or the value of goods which have been taken from him by the defender without order of law, or the extent of his damages. An oath *in litem*, as it is the affirmation of a party in his own behalf, is only allowed where there is proof that the other party has been engaged in some illegal act, or where the public policy has made it necessary, see Tit. xx. 11. This oath, as to the quantities, is not admitted, where there is a concurring testimony of witnesses brought in proof of it. When it is put as to the value of goods, it is only an oath of credulity; and therefore it has always been subject to the modification of the court.

10. The law of Scotland rejects the testimony of witnesses, 1. In payment of any sum above *L. 100 Scots*, all

which must be proved either *scripto vel juramento*. 2. In all gratuitous promises, though for the smallest sums. 3. In all contracts, where writing is either essential to their constitution, (see Tit. xxi. 2) or where it is usually admitted, as in the borrowing of money. And it is a general rule, subject to the restrictions mentioned in the next §, that no debt or right, once constituted by writing, can be taken away by witnesses.

11. On the other part, probation by witnesses is admitted to the extent of *L. 100 Scots*, in payments, nuncupative legacies, and verbal agreements which contain mutual obligations. And it is received to the highest extent, 1. In all bargains which have known engagements naturally arising from them, concerning moveable goods. 2. In facts performed in satisfaction, even of a written obligation, where such obligation binds the party precisely to the performance of them. 3. In facts which with difficulty admit of a proof by writing, even though the effect of such proof should be the extinction of a written obligation, especially if the facts import fraud or violence; thus, a bond is reducible *ex dolo*, on a proof by witnesses. Lastly, all intromission by a creditor with the rents of his debtor's estate payable in grain, may be proved by witnesses; and even intromission with the silver-rent, where the creditor has entered into the total possession of the debtor's lands.

12. No person, whose near relation to another bars him from being a judge in his cause, can be admitted as a witness for him; but he may, against him, except a wife or child, who cannot be compelled to give testimony against the husband or parent, *ob reverentiam personæ, et metum perjurii*. Though the witness, whose propinquity to one of the parties is objected to, be as nearly related to the other, the objection stands good.

13. The testimony of infamous persons is rejected; *i. e.* persons who have been guilty of crimes that law declares to infer infamy, or who have been declared infamous by the sentence of a judge; but *infamia facti* does not disqualify a witness. Pupils are inhabile witnesses; being, in the judgment of law, incapable of the impressions of an oath. The testimony of women is seldom admitted, where other witnesses can be had. And in general witnesses otherwise exceptionable may, where there is a penury of witnesses arising from the nature or circumstances of the fact, be received *cum nota*; that is, their testimony, though not quite free from suspicion, is to be conjoined with the other evidence; and to have such weight given it as the judge shall think it deserves.

14. All witnesses, before they are examined in the cause, are purged of partial counsel; that is, they must declare, that they have no interest in the suit, nor have given advice how to conduct it; that they have got neither bribe nor promise, nor have been instructed how to depose; and that they bear no enmity to either of the parties. These, because they are the points put to a witness before his making oath, are called *initialia testimonii*. Where a party can bring present proof of a witness's partial counsel, in any of the above particulars, he ought to offer it before the witness be sworn; but, because such objection, if it cannot be instantly verified, will be no bar to the examination, law allows the party in that case to

proced

protest for *reprobator*, before the witness is examined; *i. e.* that he may be afterwards allowed to bring evidence of his enmity, or other inhability. *Reprobator* is competent even after sentence, where protestation is duly entered; but in that case, the party inflicting must consign *L. 100 Scots*, which he forfeits if he succumb. This action must have the concurrence of the King's Advocate, because the conclusion of it imports perjury; and for this reason, the witness must be made a party to it.

15. The interlocutory sentence or warrant, by which parties are authorized to bring their proof, is either by way of act, or of incident diligence. In an act, the Lord Ordinary who pronounces it, is no longer judge in the process; but in an incident diligence, which is commonly granted upon special points, that do not exhaust the cause, the Lord ordinary continues judge. If a witness does not appear at the day fixed by the warrant of citation, a second warrant is granted of the nature of a caption, containing a command to messengers to apprehend and bring him before the court. Where the party to whom a proof is granted, brings none within the term allowed by the warrant, an interlocutor is pronounced, circumducing the term, and precluding him from bringing evidence thereafter. Where evidence is brought, if it be upon an act, the Lord Ordinary on the acts, after the term for proving is elapsed, declares the proof concluded, and thereupon a state of the case is prepared by the Ordinary on concluded causes, which must be judged by the whole Lords; but if the proof be taken upon an incident diligence, the import of it may be determined by the Lord Ordinary in the cause.

16. Where facts do not admit a direct proof, presumptions are received as evidence which, in many cases, make as convincing a proof as the direct. Presumptions are consequences deduced from facts known or proved, which infer the certainty, or at least a strong probability, of another fact to be proved. This kind of probation is therefore called artificial, because it requires a reasoning to infer the truth of the point in question, from the facts that already appear in proof. Presumptions are either, 1. *juris et de jure*; 2. *juris*; or 3. *hominis* or *judicis*. The first sort obtains, where statute or custom establish the truth of any point upon a presumption; and it is so strong, that it rejects all proof that may be brought to elide it in special cases. Thus, the testimony of a witness, who forwardly offers himself without being cited, is, from a presumption of his partiality, rejected, let his character be ever so fair; and thus also, a minor, because he is by law presumed incapable of conducting his own affairs, is, upon that presumption, disabled from acting without the consent of his curators, though he should be known to behave with the greatest prudence. Many such presumptions are fixed by statute.

17. *Præsumptiones juris* are those, which our law-books or decisions have established, without founding any particular consequence upon them, or statuting *super præsumpto*. Most of this kind are not proper presumptions inferred from positive facts, but are founded merely on the want of a contrary proof; thus, the legal presumptions for freedom, for life, for innocence, &c. are in effect so many negative propositions, that servitude, death, and

guilt, are not to be presumed, without evidence brought by him who makes the allegation. All of them, whether they be of this sort, or proper presumptions, as they are only conjectures formed from what commonly happens, may be elided, not only by direct evidence, but by other conjectures, affording a stronger degree of probability to the contrary. *Præsumptiones hominis* or *judicis*, are those which arise daily from the circumstances of particular cases; the strength of which is to be weighed by the judge.

18. A *fiction juris* differs from a presumption. Things are presumed, which are likely to be true; but a fiction or law assumes for truth what is either certainly false, or, at least, is as probably false as true. Thus, an heir is feigned or considered in law as the same person with his ancestor. Fictions of law must, in their effects, be always limited to the special purposes of equity, for which they were introduced; see an example, Tit. xxx. 3.

### Tit. 32. Of Sentences and their Execution.

PROPERTY would be most uncertain, if debateable points might, after receiving a definitive judgment, be brought again in question, at the pleasure of either of the parties: Every state has therefore affixed the character of final to certain sentences or decrees, which in the Roman law are called *res judicata*, and which exclude all review or rehearing.

2. Decrees of the court of Session, are either *in foro contradictorio*, where both parties have litigated the cause, or in absence of the defender. Decrees of the Session *in foro* cannot, in the general case, be again brought under the review of the court, either on points which the parties neglected to plead before sentence (which we call competent and omitted), or upon points pleaded and found insufficient (proposed and repelled.) But decrees, though *in foro*, are reversible by the court, where either they labour under essential nullities; *e. g.* where they are *ultra petita*, or not conformable to their grounds and warrants, or founded on an error in calcul, &c.; or where the party against whom the decree is obtained has thereafter recovered evidence sufficient to overturn it, of which he knew not before.

3. As parties might formerly reclaim against the sentences of the session, at any time before extracting the decree, no judgment was final till extract; but now, a sentence of the inner-house, either not reclaimed against within six sederunt-days after its date, or adhered to upon a reclaiming bill, though it cannot receive execution till extract, makes the judgment final as to the court of Session. And, by an order of the house of Lords, March 24. 1725, no appeal is to be received by them from sentences of the Session after five years from extracting the sentence; unless the person entitled to such appeal be minor, clothed with a husband, *non compos mentis*, imprisoned, or out of the kingdom. Sentences pronounced by the Lord Ordinary have the same effect, if not reclaimed against, as if they were pronounced in presence; and all petitions against the interlocutor of an Ordinary must be preferred within eight sederunt days after signing such interlocutor.



4. Decrees, in absence of the defender, have not the force of *res judicate* as to him; for where the defender does not appear, he cannot be said to have subjected himself by the judicial contract which is implied in liti-contestation: A party therefore may be restored against these, upon paying to the other his costs in recovering them. The sentences of inferior courts may be reviewed by the court of Session, before decree, by advocacy, and after decree, by suspension or reduction; which two last are also the methods of calling in question such decrees of the Session itself as can again be brought under the review of the court.

5. Reduction is the proper remedy, either where the decree has already received full execution by payment, or where it decrees nothing to be paid or performed, but simply declares a right in favour of the pursuer. Suspension is that form of law by which the effect of a sentence condemnatory, that has not yet received execution, is stayed or postponed, till the cause be again considered. The first step towards suspension is a bill preferred to the Lord Ordinary on the bills. This bill, when the desire of it is granted, is a warrant for issuing letters of suspension which pass the signet; but, if the presenter of the bill shall not, within fourteen days after passing it, expedite the letters, execution may proceed on the sentence. Suspensions of decrees *in foro* cannot pass, but by the whole Lords in time of session, and by three in vacation time; but other decrees may be suspended by any one of the judges.

6. As suspension has the effect of staying the execution of the creditor's legal diligence, it cannot, in the general case, pass without caution given by the suspender to pay the debt, in the event it shall be found due. Where the suspender cannot, from his low or suspected circumstances, procure unquestionable security, the Lords admit juratory caution, *i. e.* such as the suspender swears is the best he can offer; but the reasons of suspension are, in that case, to be considered with particular accuracy at passing the bill. Decrees in favour of the clergy, of universities, hospitals, or parish school masters, for their stipends, rents, or salaries, cannot be suspended, but upon production of discharges, or on consignation of the sums charged for. A charger, who thinks himself secure without a cautioner, and wants dispatch, may, where a suspension of his diligence is sought, apply to the court to get the reasons of suspension summarily discussed on the bill.

7. Though he, in whose favour the decree suspended is pronounced, be always called the charger, yet a decree may be suspended before a charge be given on it. Nay, suspension is competent even where there is no decree, for putting a stop to any illegal act whatsoever: Thus, a building, or the exercise of a power which one assumes unwarrantably, is a proper subject of suspension. Letters of suspension are considered merely as a prohibitory diligence; so that the suspender, if he would turn provoker, must bring an action of reduction. If upon discussing the letters of suspension, the reasons shall be sustained, a decree is pronounced, suspending the letters of diligence on which the charge was given *simpli-ter*; which is called a decree of suspension, and takes off the effect of the decree sus-

pending. If the reasons of suspension be repelled, the court find the letters of diligence orderly proceeded, *i. e.* regularly carried on; and they ordain them to be put to farther execution.

8. Decrees are carried into execution, by diligence, either against the person, or against the estate of the debtor. The first step of personal execution is by letters of horning, which pass, by warrant of the court of Session, on the decrees of magistrates of boroughs, sheriffs, admirals, and commissaries. If the debtor does not obey the will of the letters of horning within the days of the charge, the charger, after denouncing him rebel, and registering the horning, may apply for letters of caption, which contain a command, not only to messengers, but to magistrates, to apprehend and imprison the debtor. All messengers and magistrates, who refuse their assistance in executing the caption, are liable *subsidiarie* for the debt; and such subsidiary action is supported by the execution of the messenger employed by the creditor, expressing that they were charged to concur, and would not. Letters of caption contain an express warrant to the messenger, in case he cannot get access, to break open all doors, and other lock fast places.

9. Law secures peers, married women, and pupils, against personal execution by caption upon civil debts. No caption can be executed against a debtor within the precincts of the King's palace of Holyroodhouse: But this privilege of sanctuary afforded no security to criminals, as that did which was, by the canon law, conferred on churches and religious houses. Where the personal presence of a debtor, under caption, is necessary in any of our supreme courts, the judges are empowered to grant him a protection, for such time as may be sufficient for his coming and going, not exceeding a month.

10. After a debtor is imprisoned, he ought not to be indulged the benefit of the air, not even under a guard; for creditors have an interest, that their debtors be kept under close confinement, that, by the *squalor carceris*, they may be brought to pay their debt: And any magistrate or jailor, who shall suffer the prisoner to go abroad, without a proper attestation, upon oath, of the dangerous state of his health, is liable *subsidiarie* for the debt. Magistrates are in like manner liable, if they shall suffer a prisoner to escape, through the insufficiency of their prison: But, if he shall escape under night, by the use of instruments, or by open force, or by any other accident which cannot be imputed to the magistrates or jailor, they are not chargeable with the debt; provided they shall have, immediately after his escape, made all possible search for him. Regularly, no prisoner for debt upon letters of caption, though he should have made payment, could be released without letters of suspension, containing a charge to the jailor to fet him at liberty; because the creditor's discharge could not take off the penalty incurred by the debtor for contempt of the King's authority: But to save unnecessary expence to debtors in small debts, jailors are empowered to let go prisoners where the debt does not exceed 200 marks *Scots*, upon production of a discharge, in which the creditor consents to his release.

11. Our law, from a consideration of compassion, allows insolvent debtors to apply for a release from prison, upon a *cessio bonorum*, i. e. upon their making over to the creditors all their estate, real and personal. This must be insisted for, by way of action, to which all the creditors of the prisoner ought to be made parties. The prisoner must, in this action, which is cognisable only by the court of Session, exhibit a particular inventory of his estate, and make oath that he has no other estate than is therein contained, and that he has made no conveyance of any part of it, since his imprisonment, to the hurt of his creditors. He must also make oath, whether he has granted any disposition of his effects before his imprisonment, and condescend on the persons to whom, and on the cause of granting it; that the court may judge, whether, by any collusive practice, he has forfeited his claim to liberty.

12. A fraudulent bankrupt is not allowed this privilege; nor a criminal who is liable in an assythment or indemnification to the party injured or his executors, though the crime itself should be extinguished by a pardon. A disposition granted on a *cessio bonorum* is merely in farther security to the creditors, not in satisfaction or *in solutum* of the debts. If therefore, the debtor shall acquire any estate after his release such estate may be attached by his creditors, as if there had been no *cessio*, except in so far as is necessary for his subsistence. Debtors, who are set free on a *cessio bonorum*, are obliged to wear a habit proper to dyvours or bankrupts. The Lords are prohibited to dispense with this mark of ignominy, unless, in the summons and process of *cessio*, it be libelled, sustained, and proved, that the bankruptcy proceeds from misfortune. And bankrupts are condemned to submit to the habit, even where no suspicion of fraud lies against them, if they have been dealers in an illicit trade.

13. Where a prisoner for debt declares upon oath, before the magistrate of the jurisdiction, that he has not wherewith to maintain himself, the magistrate may set him at liberty, if the creditor, in consequence of whose diligence he was imprisoned, does not aliment him within ten days after intimation made for that purpose. But the magistrate may, in such case, detain him in prison, if he chuses to bear the burden of the aliment; rather than release him. The statute authorising this release, which is usually called the act of grace, is limited to the case of prisoners for civil debts.

14. Decrees are executed against the moveable estate of the debtor by arrestment or pouding; and against his heritable estate, by inhibition, or adjudication. If one be condemned, in a removing or other process, to quit the possession of lands, and refuses, notwithstanding a charge, letters of ejection are granted of course, ordaining the sheriff to eject him; and to enter the obtainer of the decree into possession. Where one opposes by violence the execution of a decree, or of any lawful diligence, which the civil magistrate is not able to do himself and his officers to make good, the execution is enforced *manu militari*.

15. A decree-arbitral, which is a sentence proceeding on a submission to arbiters, has some affinity with a ju-

dicial sentence, though in most respects the two differ. A submission is a contract entered into, by two or more parties who have disputable rights or claims, whereby they refer their differences to the final determination of an arbiter or arbiters, and oblige themselves to acquiesce in what shall be decided. Where the day within which the arbiters are to decide, is left blank in the submission, practice has limited the arbiters power of deciding to a year. As this has proceeded from the ordinary words of style, empowering the arbiters to determine betwixt and the day of next to come; therefore, where a submission is indefinite, without specifying any time, like all other contracts or obligations, it subsists for forty years. Submissions, like mandates, expire by the death of any of the parties-submitters before sentence. As arbiters are not vested with jurisdiction, they cannot compel witnesses to make oath before them, or have writings to exhibit them; but this defect is supplied by the court of Session, who, at the suit of the arbiters, or of either of the parties, will grant warrant for citing witnesses, or for the exhibition of writings. For the same reason, the power of arbiters is barely to decide; the execution of the decree belongs to the judge. Where the submitters consent to the registration of the decree-arbitral, performance may be enforced by summary diligence.

16. The power of arbiters is wholly derived from the consent of parties. Hence, where their powers are limited to a certain day, they cannot pronounce sentence after that day. Nor can they subject parties to a penalty higher than that which they have agreed to in the submission. And where a submission is limited to special claims; sentence pronounced on subjects not specified in the submission is null, as being *ultra vires compromissi*.

17. But, on the other part, as submissions are designed for a most favourable purpose, the amicable composition of differences, the powers thereby conferred on arbiters receive an ample interpretation. Decrees-arbitral are not reducible upon any ground, except corruption, bribery, or falsehood.

#### Tit. 26. Of Crimes.

THE word *crime*, in its most general sense, includes every breach, either of the law of God, or of our country; in a more restricted meaning, it signifies such transgressions of law as are punishable by courts of justice. Crimes were, by the Roman law, divided into public and private. Public crimes were those that were expressly declared such by some law or constitution, and which, on account of their more atrocious nature and hurtful consequences, might be prosecuted by any member of the community. Private crimes could be pursued only by the party injured, and were generally punished by a pecuniary fine to be applied to his use. By the law of Scotland, no private party, except the person injured, or his next of kin, can accuse criminally: but the King's Advocate, who in this question represents the community, has a right to prosecute all crimes in *vindictam publicam*, though the party injured should refuse to concur. Smaller offences, as petty riots, injuries, &c. which do not demand

mand the public vengeance, pass generally by the appellation of delicts, and are punished either by fine or imprisonment.

2. The essence of a crime is, that there be an intention in the actor to commit it; for an action in which the will of the agent has no part, is not a proper object either of rewards or punishments: Hence arises the rule, *crimen dolo contrahitur*. Simple negligence does not therefore constitute a proper crime. Yet where it is extremely gross, it may be punished arbitrarily. Far less can we reckon in the number of crimes, those committed by an idiot or furious person: But lesser degrees of fatuity, which only darken reason, will not afford a total defence, though they may save from the *pœna ordinaria*. Actions committed in drunkenness are not to be considered as involuntary, seeing the drunkenness itself, which was the first cause of the action, is both voluntary and criminal.

3. On the same principle, such as are in a state of infancy, or in the confines of it, are incapable of a criminal action, dole not being incident to that age; but the precise age at which a person becomes capable of dole, being fixed neither by nature nor by statute, is by our practice to be gathered by the judge, as he best can, from the understanding and manners of the person accused. Where the guilt of a crime arises chiefly from statute, the actor, if he is under puberty, can hardly be found guilty; but, where nature itself points out its deformity, he may, if he is *proximus pubertati*, be more easily presumed capable of committing it: Yet, even in that case, he will not be punished *pœna ordinaria*.

4. One may be guilty of a crime, not only by perpetrating it himself, but by being accessory to a crime committed by another; which last is by civilians styled *ope et consilio*, and, in our law-phrase, art and part. A person may be guilty, art and part, either by giving advice or counsel to commit the crime; or, 2. By giving warrant or mandate to commit it; or, 3. By actually assisting the criminal in the execution. It is generally agreed by doctors, that, in the more atrocious crimes, the adviser is equally punishable with the criminal; and that, in the slighter, the circumstances arising from the adviser's lesser age, the jocular or careless manner of giving advice, &c. may be received as pleas for softening the punishment. One who gives mandate to commit a crime, as he is the first spring of action, seems more guilty than the person employed as the instrument in executing it; yet the actor cannot excuse himself under the pretence of orders which he ought not to have obeyed.

5. Assistance may be given to the committer of a crime, not only in the actual execution, but previous to it, by furnishing him, intentionally, with poison, arms, or the other means of perpetrating it. That sort of assistance which is not given till after the criminal act, and which is commonly called abetting, though it be of itself criminal, does not infer art and part of the principal crime; as if one should favour the escape of a criminal knowing him to be such. or conceal him from justice.

6. Those crimes that are, in their consequences, most hurtful to society, are punished capitally. or by death; others escape with a lesser punishment, sometimes fixed by statute, and sometimes arbitrary, *i. e.* left to the dis-

cretion of the judge, who may exercise his jurisdiction, either by fine, imprisonment, or a corporal punishment. Where the punishment is left, by law, to the discretion of the judge, he can in no case extend it to death. The single escheat of the criminal falls on conviction, in all capital trials, though the sentence should not express it.

7. Certain crimes are committed more immediately against God himself; others, against the state; and a third kind, against particular persons. The chief crime in the first class, cognisable by temporal courts, is *blasphemy*, under which may be included atheism. This crime consists in the denying or vilifying the Deity, by speech or writing. All who curse God or any of the persons of the blessed Trinity, are to suffer death, even for a single act; and those who deny him, if they persist in their denial. The denial of a providence, or of the authority of the holy Scriptures, is punishable capitally for the third offence.

8. No prosecution can now be carried on for witchcraft or conjuration. But all who undertake, from their skill in any occult science, to tell fortunes, or discover stolen goods, are to suffer imprisonment for a year, stand in the pillory four times in that year, and find surety for their future good behaviour.

9. Some crimes against the state are levelled directly against the supreme power, and strike at the constitution itself: others discover such a contempt of law, as tends to baffle authority, or slacken the reins of government. *Treason, crimen majestatis*, is that crime which is aimed against the majesty of the state; and can be committed only by those who are subjects of that state either by birth or residence. Soon after the union of the two kingdoms in 1707. the laws of treason, then in force in England, were made ours by 7. *An. c.* 21. both with regard to the facts constituting that crime, to the forms of trial, the corruption of blood, and all the penalties and forfeitures consequent on it.

10. It is high treason, by the law of England, to imagine the death of the King, Queen-consort, or of the heir apparent of the crown; to levy war against the King, or adhere to his enemies; to counterfeit the King's coin, or his great or privy seal; to kill the chancellor, treasurer, or any of the twelve judges of England, while they are doing their offices; which last article is by the forenamed act 7. *An.* applied to Scotland, in the case of slaying any judge of the Session or of Jusiciary sitting in judgment. Those who wash, clip, or lighten the proper money of the realm, who advisedly affirm by writing or printing, that the Pretender has any right to the crown, that the King and Parliament cannot limit the succession to it, or who hold correspondence with the Pretender or any person employed by him, are also guilty of treason.

11. The forms of proceeding in the trial of treason, whether against Peers or Commoners, are set forth in a small treatise, published by order of the house of Lords in 1709, subjoined to a collection of statutes concerning treason. By the conviction upon this trial, the whole estate of the traitor forfeits to the crown. His blood is also corrupted, so that, on the death of an ancestor, he cannot inherit;

herit; and the estate which he cannot take, falls to the immediate superior as escheat, *ob defectum hereditis*, without distinguishing whether the lands hold of the crown, or of a subject. No attainder for treason shall, after the death of the Pretender and all his sons, hurt the right of any person, other than that of the offender, during his natural life; The rights of creditors and other third parties in the case of forfeiture on treason, must be determined by the law of England.

12. *Misprison of treason*, from *Meprendre*, is the overlooking or concealing of treason. It is inferred by one's bare knowledge of the crime, and not discovering it to a magistrate or other person intrusted by his office to take examinations; though he should not in the least degree assent to it. The fore-said act 7. *An.* makes the English law of misprison ours. Its punishment is, by the law of England, perpetual imprisonment, together with the forfeiture of the offender's moveables, and of the profits of his heritable estate, during his life; that is, in the style of our law, his single and liferent-escheat.

13. The crime of *sedition* consists in the raising commotions or disturbances in the state. It is either verbal or real. Verbal sedition, or leasing making, is inferred from the uttering of words tending to create discord between the King and his people. It is punished either by imprisonment, fine, or banishment, at the discretion of the judge. Real sedition is generally committed, by convoking together any considerable number of people, without lawful authority, under the pretence of redressing some public grievance, to the disturbing of the public peace. Those who are convicted of this crime are punished by the confiscation of their goods; and their lives are at the King's will. If any persons, to the number of twelve, shall assemble, and being required by a magistrate or constable to disperse, shall nevertheless continue together for an hour after such command, the persons disobeying shall suffer death and the confiscation of moveables.

14. Judges, who, wilfully or through corruption, use their authority as a cover to injustice or oppression, are punished with the loss of honour, fame, and dignity. Under this head, may be classed *theftbote* (from *bote*, compensation), which is the taking a consideration in money or goods from a thief to exempt him from punishment, or connive at his escape from justice. A sheriff or other judge, guilty of this crime, forfeits his life and goods. And even a private person, who takes *theftbote*, suffers as the principal thief. The buying of disputed claims, concerning which there is a pending process, by any judge or member either of the Session, or of an inferior court, is punished by the loss of the delinquent's office, and all the privileges thereto belonging.

15. Deference is the opposition given, or resistance made, to messengers or other officers, while they are employed in executing the law. The court of Session is competent to this crime. It is punishable with the confiscation of moveables, the one half to the King, and the other to the creditor at whose suit the diligence was used. Armed persons, to the number of three or more, assisting in the illegal running, landing, or exporting of prohibited or uncustomed goods, or any who shall resist, wound,

or maim any officer of the revenue in the execution of office, are punishable with death and the confiscation of moveables.

16. *Breach of arrestment*, (see Tit. xxv. 5.) is a crime of the same nature with deforcement, as it imports a contempt of the law and of our judges. It subjects to an arbitrary corporal punishment, and the escheat of moveables; with a preference to the creditor for his debt, and for such farther sum as shall be modified to him by the judge. Under this head of crimes against good government and police, may be reckoned the *forestalling of markets*; that is, the buying of goods intended for a public market, before they are carried there; which for the third criminal act, infers the escheat of moveables; as also slaying salmon in forbidden time, destroying plough-graith in time of tillage, slaying or houghing horses or cows in time of harvest, and destroying or spoiling growing timber; as to the punishment of which, see statutes 1503, c. 72,—1587, c. 82, and 1698, c. 16—1. *Geo. I. St. 2. c. 48.*

17. Crimes against particular persons may be directed, either against life, limb, liberty, chastity, goods, or reputation. *Murder* is the wilful taking away of a person's life, without a necessary cause. Our law makes no distinction between premeditated and sudden homicide; both are punished capitally. Casual homicide, where the actor is in some degree blameable, and homicide in self-defence, where the just bounds of defence have been exceeded, are punished arbitrarily; but the slaughter of night-thieves, house-breakers, assistants in masterful depredations, or rebels denounced for capital crimes, may be committed with impunity. The crime of *dismemberation*, or the cutting off of a member, is joined with that of murder; but in practice, its punishment has been restricted to the escheat of moveables, and an assythment or indemnification to the party. *Mutilation*, or the disabling of a member, is punished at the discretion of the judge.

18. *Self-murder* is as highly criminal as the killing our neighbour; and for this reason, our law has, contrary to the rule, *crimina morte extinguuntur*, allowed a proof of the crime, after the offender's death, that his single escheat might fall to the King or his donatory. To this end, an action must be brought, not before the Justiciary, but the Session, because it is only intended *ad civilem effectum*, for proving and declaring the self-murder; and the next of kin to the deceased must be made a party to it.

19. The punishment of parricide, or of the murder of a parent, is not confined, by our law, to the criminal himself. All his posterity in the right line are declared incapable of inheriting; and the succession devolves on the next collateral heir. Even the cursing or beating of a parent infers death, if the person guilty be above sixteen years; and an arbitrary punishment, if he be under it. A presumptive or statutory murder is constituted by 1690, c. 21. by which any woman who shall conceal her pregnancy, during its whole course, and shall not call for, or make use of help in the birth, is to be reputed the murderer, if the child be dead, or amissing. This act was intended to discourage the unnatural practice of wo-

men making away with their children begotten in fornication to avoid church-censures.

20. *Duelling*, is the crime of fighting in single combat, on previous challenges given and received. Fighting in a duel, without licence from the King, is punishable by death; and whatever person, principal or second, shall give a challenge to fight a duel, or shall accept a challenge, or otherwise engage therein, is punished by banishment and escheat of moveables, though no actual fighting should ensue.

21. *Himsucken*, (from *haim*, home, and *socken*, to seek or pursue,) is the assaulting or beating of a person in his own house. The punishment of this crime is no where defined, except in the books of the Majesty, which make it the same as that of a rape; and it is, like rape, capital by our practice. The assault must be made in the proper house of the person assaulted, where he lies and rises daily and nightly, so that neither a public house, nor even a private, where one is only transiently, falls within the law.

22. Any party to a law-suit, who shall slay, wound, or otherways invade his adversary, at any period of time between executing the summons and the compleat execution of the decree, or shall be accessory to such invasion, shall lose his cause. The sentence pronounced on this trial, against him who has committed the battery, is not subject to reduction, either on the head of minority, or any other ground whatever: And if the person prosecuted for this crime shall be denounced for not appearing, his liferent, as well as single escheat, falls upon the denunciation.

23. The crime of *wrongous imprisonment* is inferred, by granting warrants of commitment in order to trial, proceeding on informations not subscribed, or without expressing the cause of commitment; by receiving or detaining prisoners on such warrants; by refusing to a prisoner a copy of the warrant of commitment; by detaining him in close confinement, above eight days after his commitment; by not releasing him on bail, where the crime is bailable; and by transporting persons out of the kingdom, without either their own consent, or a lawful sentence. The persons guilty of a wrongous imprisonment, are punished by a pecuniary mulct, from L. 6000 down to L. 400 *Scots*, according to the rank of the person detained; and the judge or other person guilty, is over and above subjected to pay to the person detained a certain sum *per diem*, proportioned to his rank, and is declared incapable of public trust. All these penalties may be insisted for by a summary action before the session, and are subject to no modification.

24. *Adultery*, is the crime by which the marriage-bed is polluted. This crime could, neither by the Roman nor Jewish law, be committed, but where the guilty woman was the wife of another: By ours, it is adultery, if either the man or woman be married. We distinguish between simple adultery, and that which is notorious or manifest. Open and manifest adulterers, who continue incorrigible, notwithstanding the censures of the church, are punished capitally. This crime is distinguished by one or other of the following characters; where there is issue procreated between the adulterers; or where they

keep bed and company together notoriously; or where they give scandal to the church, and are, upon their obstinate refusing to listen to their admonitions, excommunicated. The punishment of simple adultery, not being defined by statute, is left to the discretion of the judge; but custom has made the falling of the single escheat one of its penalties.

25. *Bigamy*, is a person's entering into the engagements of a second marriage, in violation of a former marriage vow still subsisting. Bigamy, on the part of the man, has been tolerated in many states, before the establishment of Christianity, even by the Jews themselves; but it is prohibited by the precepts of the gospel, and it is punished by our law, whether on the part of the man, or of the woman, with the pains of perjury.

26. *Incest*, is committed by persons who stand within the degrees of kindred forbidden in *Lev. xviii.* and is punished capitally. The same degrees are prohibited in affinity, as in consanguinity, *Lev. xviii. 13. et seq.* As this crime is repugnant to nature, all children, whether lawful or natural, stand on an equal footing: *Civilis ratio civilia jura corrumpere potest, non vero naturalia.* It is difficult indeed to bring a legal proof of a relation merely natural, on the side of the father; but the mother may be certainly known without marriage.

26. There is no explicate statute making rape, or the ravishing of women, capital; but it is plainly supposed in act 16 12, c. 4. by which the ravisher is exempted from the pains of death, only in the case of the woman's subsequent consent, or her declaration that she went off with him of her own free-will; and even then, he is to suffer an arbitrary punishment, either by imprisonment, confiscation of goods, or a pecuniary fine.

28. *Theft* is defined, a fraudulent intermeddling with the property of another, with a view of making gain. Our ancient law proportioned the punishment of the theft to the value of the goods stolen; heightening it gradually, from a slight corporal punishment to a capital, if the value amounted to thirty-two pennies Scots, which in the reign of David I. was the price of two sheep. In several later acts, it is taken for granted, that this crime is capital. But where the thing stolen is of small value, we consider it, not as theft, but as pickery, which is punished either corporally or by banishment. The breaking of orchards, and the stealing of green wood, is punished by a fine, which rises as the crime is repeated.

29. Theft may be aggravated into a capital crime, though the value of the thing stolen be trifling; as theft twice repeated, or committed in the night, or by landed men; or of things set apart for sacred uses. The receivers and concealers of stolen goods, knowing them to be such, suffer as thieves. Those who barely harbour the person of the criminal within forty-eight hours either before or after committing the crime, are punished as partakers of the theft. Such as sell goods belonging to thieves or lawless persons who dare not themselves come to market, are punished with banishment and the escheat of moveables.

30. Theft attended with violence, is called *robbery*; and in our old statutes, *rief* or *stouthrief*, under which class may be included *forning*, or the taking of meat and drink by force, without paying for it, *Stouthrief* came

at

at last to be committed so audaciously, by bands of men associated together, that it was thought necessary to vest all our freeholders with a power of holding courts upon forners and rievvers, and condemning them to death. Nay, all were capitally punished, who, to secure their lands from depredation, paid to the rievvers a yearly contribution, which got the name of *black mail*. An act also passed, commanding to banishment a band of forners, who were originally from *Egypt*, called *Gypsies*, and adjudging to death all that should be reputed *Egyptians*, if found thereafter within the kingdom. Robbery committed on the seas, is called *piracy*, and is punished capitally by the high admiral. Several of the facts which constitute this crime are set forth in a British statute, 8. *Geo. I. c. 24.*

31. *Falseness*, in a large sense, is the fraudulent imitation or suppression of truth, to the damage of another. The latest statute against this crime, punishes it by confiscation of moveables. That particular species of falseness, which consists in the falsifying of writings, passes by the name of *forgery*. Our practice has now of a long time, agreeably to the Roman law, made this crime capital; unless the forgery be of executions, or other writings of smaller moment; in which case, it is punished arbitrarily.

32. The writing must not only be fabricated, but put to use or founded on, in order to infer this crime. And though it be strictly criminal, yet the trial of it is proper to the court of Session; but where improbation is moved against a deed by way of exception, the inferior judge, before whom the action lies, is competent to it *ad civilem effectum*. When it is pleaded as an exception, our practice, to discourage affected delays, obliges the defender, who moves it, to consign L. 40 Scots; which he forfeits, if his plea shall appear calumnious.

33. Where a person, found guilty of forgery by the court of Session, is by them remitted to the Justiciary, an indictment is there exhibited against him, and a jury sworn, before whom the decree of Session is produced, in place of all other evidence of the crime, in respect of which the jury find the pannel guilty; so that that decree, being pronounced by a competent court, is held as full proof, or, in the style of the bar, as *probatio probata*.

34. *Perjury*, which is the judicial affirmation of a falsehood on oath, really constitutes the *crimen falsi*; for he who is guilty of it does, in the most solemn manner, substitute falsehood in the place of truth. To constitute this crime, the violation of truth must be deliberately intended by the swearer; and therefore reasonable allowances ought to be given to forgetfulness or misapprehension, according to his age, health, and other circumstances. The breach of a promissory oath does not infer this crime; for he who promises on oath, may sincerely intend performance when he swears, and so cannot be said to call on God to attest a falsehood. Though an oath, however false, if made upon reference in a civil question, concludes the cause, the person perjured is liable to a criminal trial; for the effect of the reference can go no farther than the private right of the parties.

35. Notwithstanding the mischievous consequences of perjury to society, it is not punished capitally, but by confiscation of moveables, imprisonment for a year, and

infamy. The court of Session is competent to perjury *incidenter*, when in any examination upon oath, taken in a cause depending before them, a person appears to have sworn falsely; but in the common case, that trial is proper to the Justiciary. *Subornation of perjury* consists in tampering with persons who are to swear in judgment, by directing them how they are to depose; and it is punished with the pains of perjury.

36. The crime of *Stellionate*, from *stellis*, includes every fraud which is not distinguished by a special name; but is chiefly applied to conveyances of the same numerical right, granted by the proprietor to different disponees. The punishment of stellionate must necessarily be arbitrary, to adapt it to the various natures and different aggravations of the fraudulent acts. The persons guilty of that kind of it, which consists in granting double conveyances, are by our law declared infamous, and their lives and goods at the King's mercy. The cognizance of *fraudulent bankruptcy* is appropriated to the court of Session, who may inflict any punishment on the offender, that appears proportioned to his guilt, death excepted.

37. The crime of *usury*, before the reformation, consisted in the taking of any interest for the use of money; and now in taking an higher rate of interest than is authorized by law. It is divided into *usura manifesta*, or direct; and *velata*, or covered. One may be guilty of the first kind, either where he covenants with the debtor for more than the lawful interest on the loan-money; or where one receives the interest of a sum before it is due, since thereby he takes a consideration for the use of money before the debtor has really got the use of it. Where a debt is clogged with an uncertain condition, by which the creditor runs the hazard of losing his sum, he may covenant for an higher interest than the legal, without the crime of usury; for there, the interest is not given merely in consideration of the use of the money, but of the danger undertaken by the creditor.

38. Covered usury, is that which is committed under the mask, not of a loan, but of some other contract; *e. g.* a sale, or an improper wadset. And in general, all obligations entered into with an intention of getting more than the legal interest for the use of money, however they may be disguised, are usurious. As a farther guard against this crime, the taking more than the legal interest for the forbearance of payment of money, merchandise, or other commodities, by way of loan, exchange, or other contrivance whatever; or the taking a bribe for the loan of money, or for delaying its payment when lent, is declared usury. Where usury is proved, the usurious obligation is not only declared void, but the creditor, if he has received any unlawful profits, forfeits the treble value of the sums or goods lent. Usury, when it is to be pursued criminally, must be tried by the Justiciary; but where the libel concludes only for voiding the debt or restitution, the session is the proper court.

39. *Injury*, in its proper acceptation, is the reproaching or affronting our neighbour. Injuries are either verbal or real. A verbal injury, when directed against a private person, consists in the uttering contumelious words, which tend to expose our neighbour's character by making him little or ridiculous. It does not seem that the twitting

ting one with natural defects, without any sarcastical reflections, though it be inhuman, falls under this description, as these imply no real reproach in the just opinion of mankind. Where the injurious expressions have a tendency to blacken one's moral character, or fix some particular guilt upon him, and are deliberately repeated in different companies, or handed about in whispers to confidants, it then grows up to the crime of slander: and where a person's moral character is thus attacked, the *animus injuriandi* is commonly inferred from the injurious words themselves, unless special circumstances be offered to take off the presumption; *ex. gr.* that the words were uttered in judgment in one's own defence, or by way of information to a magistrate, and had some foundation in fact. Though the cognizance of slander is proper to the commissaries, who, as the *judices Christianitatis*, are the only judges of scandal; yet for some time past, bare verbal injuries have been tried by other criminal judges, and even by the Session. It is punished either by a fine, proportioned to the condition of the persons injuring and injured, and the circumstances of time and place; or if the injury import scandal, by publicly acknowledging the offence; and frequently the two are conjoined. The calling one a bankrupt is not, in strict speech, a verbal injury, as it does not affect the person's moral character; yet as it may hurt his credit in the way of business, it founds him in an action of damages, which must be brought before the judge-ordinary. A real injury is inflicted by any fact by which a person's honour or dignity is affected; as striking one with a cane, or even aiming a blow without striking; spitting in one's face; assuming a coat of arms, or any other mark of distinction proper to another, &c. The composing and publishing defamatory libels may be reckoned of this kind. Real injuries are tried by the judge-ordinary, and punished, either by fine or imprisonment, according to the demerit of the offenders.

40. After having shortly explained the several crimes punishable by our law, this treatise may be concluded, with a few observations on criminal jurisdiction, the forms of trial, and the methods by which crimes may be extinguished. Criminal jurisdiction is founded, 1. *Ratione domicilii*, if the defender dwells within the territory of the judge. Vagabonds, who have no certain domicile, may be tried where-ever they are apprehended. 2. *Ratione delicti*, if the crime was committed within the territory. Treason is triable, by the English law, in any county that the King should appoint; and by a temporary act now expired, treason committed in certain Scots counties, was made triable by the court of Justiciary, where-ever it should fit.

41. No criminal trial can proceed, unless the person accused is capable of making his defence. Absents therefore cannot be tried; nor fatuous nor furious persons, *durante furore*, even for crimes committed, while they were in their senses. For a like reason, minors who had no curators could not, by the Roman law, be tried criminally; but our practice considers every person who is capable of dole, to be also sufficiently qualified for making his defence in a criminal trial.

42. No person can be imprisoned in order to stand trial

for any crime, without a warrant in writing expressing the cause, and proceeding upon a subscribed information, unless in the case of indignities done to judges, riots, and the other offences specially mentioned in 1701, c. 6. Every prisoner committed in order to trial, if the crime of which he is accused be not capital, is entitled to be released upon bail, the extent of which is to be modified by the judge, not exceeding 12000 merks Scots for a Nobleman, 6000 for a landed gentleman, 2000 for any other gentleman or burghers, and 600 for any other inferior person. That persons who, either from the nature of the crime with which they are charged, or from their low circumstances, cannot procure bail, may not lie for ever in prison untried, it is lawful to every such prisoner, to apply to the criminal judge, that his trial may be brought on. The judge must, within twenty-four hours after such application, issue letters directed to messengers, for intimating to the prosecutor to fix a diet for the prisoner's trial, within sixty days after the intimation, under the pain of wrongous imprisonment: And if the prosecutor does not insist within that time, or if the trial is not finished in forty days more, when carried on before the Justiciary, or in thirty, when before any other judge; the prisoner is, upon a second application, setting forth that the legal time is elapsed, entitled to his freedom, under the same penalty.

43. Upon one's committing any of the grosser crimes, it is usual for a justice of the peace, sheriff, or other judge, to take a precognition of the facts, *i. e.* to examine those who were present at the criminal act, upon the special circumstances attending it, in order to know whether there is ground for a trial, and to serve as a direction to the prosecutor, how to set forth the facts in the libel; but the persons examined may insist to have their declarations cancelled, before they give testimony at the trial. Justices of the peace, sheriffs, and magistrates of boroughs, are also authorized to receive informations, concerning crimes to be tried in the circuit-courts; which informations are to be transmitted to the justice clerk forty days before the sitting of the respective courts. To discourage groundless criminal trials, all prosecutors, where the defender was absolved, were condemned by statute, in costs, as they should be modified by the judge, and besides were subjected to a small fine to be divided between the sisk and the defender: And where the King's advocate was the only pursuer, his informer was made liable. This sufficiently warrants the present practice of condemning vexatious prosecutors in a pecuniary mulct, though far exceeding the statutory sum.

44. The forms of law upon criminal accusations, differ much from those observed in civil actions, if we except the case of such crimes as the court of Session is competent to, and of lesser offences tried before inferior courts. The trial of crimes proceeds, either upon indictment, which is sometimes used, when the person to be tried is in prison; or by criminal letters issuing from the signet of the Justiciary. In either case the defender must be served with a full copy of the indictment or letters, and with a list of the witnesses to be brought against him, and of the persons who are to pass on the inquest, and fifteen free days must intervene, between his being

so served, and the day of appearance. When the trial proceeds upon criminal letters, the private prosecutor must give security, at raising the letters, that he will report them duly executed to the Justiciary, in terms of 1535, c. 35; and the defender, if he be not already in prison, is, by the letters, required to give caution, within a certain number of days after his citation, for his appearance upon the day fixed for his trial: And if he gives none within the days of the charge he may be denounced rebel, which infers the forfeiture of his moveables.

45. That part of the indictment, or of the criminal letters, which contains the ground of the charge against the defender, and the nature or degree of the punishment he ought to suffer, is called the libel. All libels must be special, setting forth the particular facts inferring the guilt, and the particular place where these facts were done. The time of committing the crime may be libelled in more general terms, with an alternative as to the month, or day of the month: but as it is not practicable in most cases, to libel upon the precise circumstances of accession that may appear in proof, libels against accessories are sufficient, if they mentioned, in general, that the persons prosecuted are guilty art and part.

46. The defender, in a criminal trial, may raise letters of exculpation, for citing witnesses in proof of his defences against the libel, or of his objections against any of the jury or witnesses; which must be executed, to the same day of appearance, with that of the indictment or criminal letters.

47. The diets of appearance, in the court of Justiciary, are peremptory; the criminal letters must be called on the very day to which the defender is cited; and hence, if no accuser appears, their effect is lost, *instantia perit*, and new letters must be raised. If the libel or any of the executions, shall to the prosecutor appear informal, or if he be dissident of the proof, from the absconding of a necessary witness, the court will, upon a motion made by him, desert the diet *pro loco et tempore*; after which new letters become also necessary. A defender, who does not appear on the day to which he is cited, is declared fugitive; in consequence of which, his single escheat falls. The defender, after his appearance in court, is called the pannel.

48. The two things to be chiefly regarded in a criminal libel, are, 1. The relevancy of the facts *i. e.* their sufficiency to infer the conclusion; 2. Their truth. The consideration of the first belongs to the judge of the court; that of the other, to the jury or assize. If the facts libelled be found irrelevant, the pannel is dismissed from the bar; if relevant, the court remits the proof thereof to be determined by the jury; which must consist of 15 men picked out by the court from a greater number not exceeding 45, who have been all summoned, and given in list to the defender at serving him with a copy of the libel.

49. Crimes cannot, like debts, be referred to the defender's oath; for no person is compellable to swear against himself, where his life, limb, liberty, or estate is concerned, nor even in crimes which infer infamy; because one's good name is, in right estimation, as valuable as his life. There is one exception however to this rule in trying the crime of usury, which may be proved by the usurer's own

oath, notwithstanding the rule, *nemo tenetur jurare in suam turpitudinem*. Crimes therefore are in the general case proveable only by the defender's free confession, or by writing, or by witnesses. No extrajudicial confession, unless it is adhered to by the pannel in judgment, can be admitted as evidence.

50. All objections relevant against a witness in civil cases, are also relevant in criminal. No witness is admitted, who may gain or lose by the event of the trial. *Socii criminis*, or associates in the same crime, are not admitted against one another, except either in crimes against the state, as treason: in occult crimes, where other witnesses cannot be had, as forgery; or in thefts or depredations committed in the Highlands. The testimony of the private party injured may be received against the pannel, where the King's Advocate is the only prosecutor, if, from the nature of the crime, there must needs be a penury of witnesses, as in rape, robbery, &c.

51. After all the witnesses have been examined in court, the jury are shrou up in a room by themselves, where they must continue, excluded from all correspondence, till their verdict or judgment be subscribed by the foreman (or chancellor), and clerk; and according to this verdict, the court pronounces sentence, either absolving or condemning. It is necessary, by the law of Scotland, that a jury should be unanimous in finding a person guilty; the narrowest majority is as sufficient against the pannel, as for him, Juries cannot be punished on account of an erroneous verdict, either for or against the pannel.

52. Though the proper business of a jury be to inquire into the truth of the facts found relevant by the court, for which reason they are sometimes called the inquest; yet, in many cases, they judge also in matters of law or relevancy. Thus, though an objection against a witness should be repelled by the court, the jury are under no necessity to give more credit to his testimony than they think just: And in all trials of art and part, where special facts are not libelled, the jury, if they return a general verdict, are indeed judges, not only of the truth, but of the relevancy of the facts that are sworn to by the witnesses. A general verdict, is that which finds, in general terms, that the pannel is guilty or not guilty, or that the libel or defences are proved or not proved. In a special verdict, the jury finds certain facts proved, the import of which is to be afterwards considered by the court.

53. Criminal judges must now suspend for some time the execution of such sentences as affect life or limb, that so condemned criminals, whose cases deserve favour, may have access to apply to the king for mercy. No sentence of any court of judicature, south of the river Forth, importing either death or demerabration, can be executed in less than thirty days; and, if north of it, in less than forty days, after the date of the sentence. But corporal punishments, less than death or dismembering, *e. g.* whipping, pillory, &c. may be inflicted eight days after sentence on this side Forth, and twelve days after sentence beyond it.

54. Crimes are extinguished, 1. By the death of the criminal; both because a dead person can make no defence, so that his trial is truly a judging upon the hearing of



of one side; and because, though his guilt should be ever so notorious, he is after death carried beyond the reach of human penalties: Such trials therefore can have no effect, but to punish the innocent heir, contrary to that most equitable rule, *culpa tenet suos auctores*. 2. Crimes may be extinguished by a remission from the Sovereign. But a remission, though it secures the delinquent from the public resentment, the exercise of which belongs to the Crown, cannot cut off the party injured from his claim of damages, over which the Crown has no prerogative. Whoever therefore founds on a remission, is liable in damages to the private prosecutor, in the same manner, as if he had been tried and found guilty. Even general acts of indemnity passed in parliament, though they secure against such penalties as law inflicts upon the criminal, merely *per modum pæne*, yet do not against the payment of any pecuniary fine, which is given by statute to the party injured, nor against the demand of any claim competent to him in name of damages.

55. Lesser injuries, which cannot be properly said to affect the public peace, may be extinguished, either by the private party's expressly forgiving them, or by his being reconciled to the offender, after receiving the injury. Hence arises the rule, *dissimulatione tollitur injuria*. But where the offence is of a higher nature, the party injured, though he may pass from the prosecution, in so far as his private interest is concerned, cannot preclude the King's Advocate, or Procurator-fiscal, from insisting *ad vindictam publicam*.

56. Crimes are also extinguished by prescription,

which operates by the mere lapse of time, without any act, either of the Sovereign or of the private sufferer. Crimes prescribe in twenty years; but in particular crimes, the prescription is limited by statute to a shorter time. No person can be prosecuted upon the act against wrongous imprisonment, after three years. High treason, committed within his Majesty's dominions, suffers likewise a triennial prescription, if indictment be not found against the traitor within that time. All actions, brought upon any penal statute made or to be made, where the penalty is appropriated to the Crown, expire in two years after committing the offence; and where the penalty goes to the Crown or other persecutor, the prosecutor must sue within one year, and the Crown within two years after the year ended. Certain crimes are, without the aid of any statute, extinguished by a shorter prescription than twenty years. By our old law, in the cases of rape, robbery, and hame-sucken, the party injured was not heard, after a silence of twenty four hours; from a presumption, that persons could not be so grossly injured, without immediately complaining: And it is probable, that a prosecution for these crimes, if delayed for any considerable time, would be cast even at this day, or at least the punishment restricted. Lesser injuries suffer also a short prescription; law *presuming* forgiveness, from the nature of the offence, and the silence of the party. The particular space of time sufficient to establish this presumption must be determined by the judge, according to circumstances.

## L A Y

**LAWBURROWS**, in Scots Law. See **LAW**, Tit xxx. 16.

**LAWLESS COURT**, a court said to be held annually on King's hill, at Rochford, in Essex, on the Wednesday morning after Michaelmas-day, at cock-crowing, where they whisper, and have no candle nor any pen and ink, but only a coal. Persons who owe suit, or service, and do not appear, forfeit double their rent every hour they are missing.

This servile attendance, Cambden informs us, was imposed on the tenants for conspiring at the like unseasonable time to raise a commotion. The court belongs to the honour of Raleigh, and to the earl of Warwick; and is called lawless, from its being held at an unlawful hour.

**LAWN**, a spacious plain in a park, or adjoining to a noble seat.

**LAWSONIA**, in botany, a genus of the octandria monogynia class. The calix consists of four segments, and the corolla of four petals; the stamina are disposed in pairs; and there are four capsules containing a great many seeds. There are two species, both natives of India.

**LAWYER** signifies a counsellor, or one that is learned or skilled in the law.

**LAY-BROTHERS**, among the Romanists, those pious, but illiterate persons, who devote themselves, in some convent, to the service of the religious. They wear a different habit from that of the religious, but never

## L A Z

enter into the choir, nor are present at the chapters; nor do they make any other vow, except of constancy and obedience. In nunneries, there are also lay-sisters.

**LAY-MAN**, one who follows a secular employment, or has not entered into holy orders.

**LAYERS**, in gardening, are tender shoots, or twigs of trees, laid or buried in the ground; till having struck root, they are separated from the parent-tree, and become distinct plants.

**LAZAR-HOUSE**, or **LAZARETTO**, a public-building, in the nature of an hospital, to receive the poor and those afflicted with contagious distempers. In some places, lazarettos are appointed for the performance of quarantine; in which case, those are obliged to be confined in them who are suspected to have come from places infected with the plague.

**LAZARITES**, or *Fathers of St LAZARUS*, a religious congregation of regular clerks, instituted in France in the seventeenth century, by M. Vincent. They take their name from a house in the suburbs of Paris, where they have a seminary, called the seminary of good children. The vows they make are simple; and, upon occasion, may be dispensed with.

**LAZULI**, or *Lapis LAZULI*, in natural history, one of the ores of copper, the basis of which is a crystalline matter, coloured with that elegant blue which copper gives to all alkaline liquors.

The

The lapis lazuli is found in many parts of the world ; but that of Asia and Africa is much superior both in beauty and real value to the Bohemian and German kind, which is too often sold in its place.

Its great use, beside the polishing as a gem, is the making the fine blue used in painting called ultramarine, which is obtained from it by calcination.

**LEAD.** See CHEMISTRY, p. 81, 186.

**LEAF, folium,** in the natural history of plants. See BOTANY, sect. 2.

**LEAF,** in clocks and watches, an appellation given to the notches of their pinions. See WATCH.

**LEAGUE,** a measure of length, containing more or less geometrical paces, according to the different usages and customs of countries. A league at sea, where it is chiefly used by us, being a land-measure mostly peculiar to the French and Germans, contains three thousand geometrical paces, or three English miles.

**LEAGUE** also denotes an alliance or confederacy between princes and states for their mutual aid, either in attacking some common enemy, or in defending themselves.

**LEAK,** among seamen, is a hole in the ship through which the water comes in. To spring a leak, is said of a ship that begins to leak. To stop a leak, is to fill it with a plug wrapt in oakum and well tarred, or putting in a tarpawling clout to keep the water out; or nailing a-piece of sheet-lead upon the place.

**LEAKAGE,** the state of a vessel that leaks, or lets water or other liquid ouze in or out.

**LEAKAGE,** in commerce, is an allowance of 12 per cent. in the customs, allowed to importers of wines for the waste and damage it is supposed to have received in the passage: an allowance of two barrels in twenty-two is also made to the brewers of ale and beer, by the excise-office.

**LEAOTUNG,** the most northerly part of China, in Asia.

**LEAP,** in music, is when the song does not proceed by conjoint degrees, as when between each note there is an interval of a third, fourth, fifth, &c.

**LEAP-YEAR.** See ASTRONOMY, p. 489.

**LEARMOUTH,** a market-town of Northumberland, situated forty eight miles north-west of Newcastle, and twelve south-west of Berwick.

**LEASING-MAKING,** in Scots law, the uttering of words tending to excite discord between the King and his people; also called verbal sedition.

**LEATHER,** the skin of several sorts of beasts dressed and prepared for the use of the various manufacturers, whose business it is to make them up. See TANNING.

#### Colouring of LEATHER.

*To colour white leather.* Hang the skins in chalk or lime-water, till they are grown supple, that the hair or wool may be stripped off; stretch them on tenters, or by means of lines, and smooth them over: then brush them over with alum-water very warm, and colour them with the colour you would have them, and dry them in the sun, or in some warm house, and they will be useful on sundry occasions, without any further trouble.

VOL. II. Num b. 67.

2

*To colour black leather the German way.* Take of the bark of the elder two pounds, of the filings or rust of iron the same quantity; put them into two gallons of rain-water, and stop them up close in a cask or vessel, and let them stand for the space of two months: then add to that the liquid part of a pound of nut-galls, beaten to powder, and a quarter of a pound of copperas, heating them over the fire, and suffering them to stand 24 hours after; and then use the liquor with a brush till the skin has taken a fine black.

*To colour leather a fair red.* First rub the leather well in alum-water, or alum it; boil stale urine, scum it till half of it is wasted: then put in an ounce of the finest lake, the like quantity of brazil in powder, one ounce of alum, and half an ounce of sal-armoniac; mix them well, and keep them stirring over a gentle fire about two hours; and so use the liquid part, to colour or tinge the skins.

*To colour leather of a curious French yellow.* Take one part of chalk, and another of wood-ashes, and make of them a good lye; then strain out the fine liquor, and set it in a vessel over the fire, and put into it turmeric in powder, and a little saffron; and let it simmer, till it becomes pretty thick; then set it a cooling, to be used as occasion requires.

*To make white leather blue.* Take a quart of elder-berries, strain out the juice, and boil it with an ounce of powder of alum, and half an ounce of indigo, or smalt-blue, and brush over the leather with a fine brush dipped in it three times, suffering it to dry between whites, and the business will be effected.

*To colour Spanish leather, &c.* Take that which the Dutch call pommelch, warm it, and rub the leather with it; then take of Venice tot appelen; and having pounded it small, put a quantity of water to it, and let it soften over a gentle fire; then press out the water, and rub or wash out the skin in it; repeating the same several times; and after that, take the finest shoemakers black, and rub the skin over with it, having in the melting added a little vitriol or copperas; and letting it dry, take goose or hog's grease, and with a woollen cloth rub the skin over for a good while, where there is a good fire to supple it, and afterwards rub it over with your hands, till it disappear; or instead of grease, you may use linseed or train-oil, and so in case of any other colour, according to the colours you design.

#### Dying of LEATHER.

*A reddish colour.* First wash the skins in water, and wring them out well, and afterwards wet them with a solution of tartar and bay-salt in fair water, and wring them out again; then to the former dissolution add ashes of crab-shells, and rub the skins very well with this: afterwards, wash them in common water, and wring them out; then wash them with tincture of madder in the solution of tartar and alum and the crab-shell ashes: and if they prove not red enough after all, wash them with the tincture of brazil.

*A pure yellow.* Take of fine aloes two ounces, of linseed-oil four pounds; dissolve or melt them; then strain the liquor, and besmear the skins with it, and letting dry varnish them over.

10 K

†

24

*An orange.* Boil fustic-berries in alum water: but for a deep orange, use turmeric-root.

*Blue.* Boil elder-berries, or dwarf elder, in water; then smear or wash the skins with it; wring them out; then boil the berries as before in a solution of alum water, and wet the skins in the same water once or twice; dry them, and they will be very blue.

*A pure sky colour.* For each skin take indigo one ounce; put it into boiling water, let it stand one night; then warm it a little, and with a brush-pencil besmear the skin twice over.

*Purple.* Dissolve roch-alum in warm water, wet the skins with it, dry them; then boil rasped brazil well in water; let it stand to cool: do this three times, and afterwards rub the dye over the skins with your hand; and when they are dry, polish them.

*Green.* Take sap-green and alum-water, of each a sufficient quantity; mix and boil them a little; if you would have the colour darker, add a little indigo.

*Processes for dying LEATHER Red and Yellow, as practised in Turkey; with directions for preparing and tanning the skins, as communicated by Mr Philippo, a native of Armenia, who received from the Society for the Encouragement of Arts, &c. one hundred pounds, and also the gold medal of the Society, as a reward for discovering this secret.*

1. *First preparation of the Skins, both for Red and Yellow Leather, by dressing them in lime.* Let the skins, dried with the hair on, be first laid to soak in clean water for three days; let them then be broken over the flesh side, put into fresh water for two days longer, and afterwards hung up to drain half an hour. Let them now be broken again on the flesh side, limed in cold lime on the same side, and doubled together with the grain side outward. In this state they must be hung up within doors over a frame for five or six days, till the hair be loose; which must be then taken off, and the skins returned into the lime-pit, for about three weeks. Take them out, and let them be well worked flesh and grain, every sixth or seventh day during that time: after which, let them be washed ten times in clear water, changing the water at each washing. They are next to be prepared in drench, as below mentioned.

2. *Second preparation of the Skins for both the Red and Yellow Dyes by drenching.* After squeezing the water out of the skins, put them into a mixture of bran and water, warm as new milk, in the following proportions, viz. about three pounds of bran for five skins, and water sufficient to make the mixture moderately fluid, which will be about a gallon to each pound of bran. In this drench let the skins lie three days; at the end of which time they must be well worked, and afterwards returned into the drench two days longer. They must then be taken out and rubbed between the hands; the water squeezed

from them, and the bran scraped off clear from both sides of the skins. After this they must be again washed ten times in clear water, and the water squeezed out of them.

Thus far the preparatory process of all the skins, whether intended to be dyed red or yellow, is the same; but afterwards those which are to be dyed red, must be treated as follows.

3. *Preparation in honey and bran of the skins that are to be dyed red.* Mix one pound of honey with three pints of luke-warm water, and stir them together till the honey is dissolved. Then add two double handfuls of bran; and taking four skins (for which the above quantity of the mixture will be sufficient) work them well in it one after another. Afterwards fold up each skin separately into a round form, with the flesh side inwards, and lay them in an earthen pan, or other proper vessel; if in the summer, by the side of each other; but in the winter, on the top of each other. Place the vessel in a sloping position, so that such part of the fluid as may spontaneously drain from the skins, may drain from them. An acid fermentation will then rise in the liquor, and the skins will swell considerably. In this state they must continue for seven or eight days; but the moisture that drains from them, must be poured off, once or twice a day, as occasion may require. After this a further preparation in salt is necessary; and which must be performed in the following manner.

4. *Preparation in salt, of the skins to be dyed red.* After the skins have been fermented in the honey and bran, as above mentioned, let them be taken out of that mixture on the eighth or ninth day, and well rubbed with dry common sea-salt, in the proportion of about half a pound to each skin; the salt must be well rubbed and worked with them. This will make them contract again, and part with a further considerable quantity of moisture; which must be squeezed out by drawing each skin separately through the hands. They must next be scraped clean on both sides from the bran, superfluous salt, and moisture that may adhere to them. After which, dry salt must be strewed over the grain side, and well rubbed in with the hand. They are then to be doubled with the flesh side outwards, lengthways from neck to tail, and a little more dry salt must be thinly strewed over the flesh side, and rubbed in: for the two last operations about a pound and a half of salt will be sufficient for each skin. They must then be put, thus folded on each other, between two clean boards, placed sloping, breadthways; and a heavy weight laid on the upper board, in order gradually to press out what moisture they will thus part with. In this state of pressure, they must be continued two days or longer, till it is convenient to dye them, for which they will then be duly prepared.

5. *Preparation of the Red Dye, in a proper proportion for four skins.* Put eight gallons of water into a copper, with seven ounces of shenan\*, tied up in a linen bag.

Light

\* Shenan is a drug much used by dyers in the East; and may easily be procured at any of the ports of Syria and Africa, in the Levant. It is the Eastern-jointed cali, called by botanists *felicornia*; and grows in great plenty in those and other parts of the East. There is a lesser species of the *felicornia* on our coast, which, from its great affinity with the Shenan, might be presumed to have the same qualities. On some trials, however, it has not appeared to answer the intention.

Light a fire under a copper, and when the water has boiled about a quarter of an hour, take out the bag of shenan, and put into the boiling fluid or lixivium, 1st, two drams of alum; 2dly, two drams of pomegranate bark; 3dly, three quarters of an ounce of turmeric; 4thly, three ounces of cochineal; 5thly, two ounces of loaf sugar. Let the whole mixture boil about six minutes, then cover the fire, and take out a quart of liquor, putting it into a flat earthen pan; and when it is as cold as new milk, take one skin, folded lengthways, the grain side outwards, and dip it in the liquor, rubbing it gently with the hands. Then taking out the skin, hang it up to drain, and throw away the superfluous dye. Proceed in the same manner with the remaining three skins; repeating the operation on each skin separately, eight times, squeezing the skins by drawing them through the hands before each fresh dipping. Lay them now on one side of a large pan, set sloping, to drain off as much of the moisture as will run from them without pressure, for about two hours, or till they are cold; then tan them as below directed.

6. *Tanning the Red Skins.* Powder four ounces of the best white galls in a marble mortar, sifting it through a fine sieve. Mix the powder with about three quarts of water, and work the skins well in this mixture for half an hour or more, folding up the skins four fold. Let them lie in this tan twenty-four hours; when they must be worked again as before; then taken out, scraped clean on both sides from the first galls, and put into a like quantity of fresh galls and water. In this fresh mixture they must be again well worked for three quarters of an hour; then folded up as before, and left in the fresh tan for three days. On the fourth day they must be taken out, washed clean from the galls, in seven or eight fresh quantities of water, and then hung up to dry.

7. *Manner of dressing the skins after they are tanned.* When the skins have been treated as above, and are very near dry, they should be scraped with the proper instrument or scraper on the flesh side, to reduce them to a proper degree of thickness. They are then to be laid on a smooth board, and glazed by rubbing them with a smooth glass. After which they must be oiled, by rubbing them with olive oil, by means of a linen rag, in the proportion of one ounce and an half of oil for four skins; then they are to be grained on a graining board, lengthways, breadthways, and cornerways, or from corner to corner.

8. *Preparation with Galls, for the Skins to be dyed yellow.* After the four skins are taken out of the drench of bran, and clean washed as before directed in the second article, they must be very well worked, half an hour or more, in a mixture of a pound and a half of the best white galls, finely powdered, with two quarts of clean water. The skins are then to be separately doubled

lengthways; rolled up with the flesh side outwards, laid in the mixture, and close pressed down on each other, in which state they must continue two whole days. On the third day let them be again worked in the tan; and afterwards scraped clean from the galls, with an ivory or brass instrument (for no iron must touch them.) They must then be put into a fresh tan, made of two pounds of galls finely powdered, with about three quarts of water, and well worked therein fifteen times. After this they must be doubled, rolled up as before, and laid in the second tan for three days. On the third day a quarter of a pound of white sea-salt must be worked into each skin; and the skins doubled up as before, and returned into the tan, till the day following, when they are to be taken out, and well washed six times in cold water; and four times in water lukewarm. The water must be then well squeezed out, by laying the skins under pressure, for a bout half an hour, between two boards, with a weight of about two or three hundred pounds laid upon the uppermost board, when they will be ready for the dye.

9. *Preparation of the Yellow Dye, in the proper proportion for four skins.* Mix six ounces of calliari gehira\*, or dgehira, or the berries of the eastern rhamnus, with the same quantity of alum, and pound them together till they be fine, in a marble or brass mortar, with a brass pestle. Then dividing the materials, thus powdered, into three equal parts of four ounces each, put one of those three parts into about a pint and a half of water, in a china or earthen vessel; and stir the mixture together. Let the fluid stand to cool, till it will not scald the hand. Then spreading one of the skins flat on a table, in a warm room, with the grain side uppermost, pour a fourth part of the tinging liquor, prepared as above directed, over the upper or grain side, spreading it equally over the skin with the hand, and rubbing it well in. Afterwards do the like with the other three skins, for which the mixture first made will be sufficient.

This operation must be repeated twice more on each skin separately, with the remaining eight ounces of the powder of the berries, and alum, with the abovementioned due proportions of hot water, put to them as before directed.

The skins, when dyed, are to be hung up on a wooden frame, without being folded, with the grain side outwards, about three quarters of an hour to drain, when they must be carried to a river or stream of running water, and well washed therein six times or more. After this, they must be put under pressure for about an hour, till the water be well squeezed out; afterwards the skins must be hung up to dry in a warm room.

This being done, the skins are to be dressed and grained as before directed for those dyed red; except the oiling, which must be omitted.

*Gilding*

tion of the shenan; but it will be prudent to pursue the examination of this further, as some unknown circumstances in the collecting, or using the English scleromina might occasion the miscarriage. But be this as it may, the Eastern shenan may, at all events, be easily procured in any quantity, at a very trifling expence, by any of the captains of Turkey ships, at Aleppo, Smyrna, &c.

\* The calliari gehira is the berries of an Eastern rhamnus, or buckthorn tree, and may be had at Aleppo, and other parts of the Levant, at a small price. The common Avignon, or yellow berries, may be substituted, but not with so good an effect; the calliari gehira being a stronger and brighter yellow dye, both for this use, and also that of coloring paper hangings, &c.

*Gilding of LEATHER.* Take glair of the whites of eggs, or gum water, and with a brush rub over the leather with either of them; then lay on the gold or silver, and letting them dry, burnish them. See the articles **GILDING** and **BURNISHING**.

*To dress or cover leather with silver or gold.* Take brown red, grind or move it on a stone with a muller, adding water and chalk; and when the latter is dissolved, rub, or lightly dab the leather over with it, till it looks a little whitish; and then lay on the leaf, silver or gold, before the leather is quite dry, laying the leaves a little over each other, that there may not be the least part uncovered; and when they have well closed with the leather, and are sufficiently dried on, and hardened, rub them over with an ivory polisher, or the fore-tooth of a horse.

**LEAVEN**, a piece of sour dough, used to ferment and render light a much larger quantity of dough or paste.

**LECHEA**, in botany, a genus of the triandria trigynia class. The calix consists of three leaves, and the corolla of three linear petals; and the capsules are three, with three valves, and one seed. There are two species, both natives of Canada.

**LECTICA**, in Roman antiquity, a vehicle in which people were carried in a reclining posture.

**LECTISTERNIUM**, a religious feast or banquet of the ancient Romans. In times of public danger or calamity, or of thanksgiving for some happy event, the republic ordered solemn feasts to be made for the gods; and this solemnity was called *lectisternium*, because on this occasion they spread tables, and placed beds around them, on which their heavenly guests were to lie and eat.

**LECTURERS**, in England, are an order of preachers in parish-churches, distinct from the rector or vicar. They are chosen by the vestry, or chief inhabitants of the parish, and are usually the afternoon preachers.

**LEDBURY**, a market-town of Herefordshire, thirteen miles east of Hereford.

**LEDGER**, the principal book wherein merchants enter their accounts. See **BOOK-KEEPING**.

**LEDUM**, the **MARSH-CISTUS**, in botany, a genus of the decandria monogynia class. The calix consists of five segments, and the corolla of five plain petals; and the capsule has five cells, opening at the base. There is but one species, a native of the northern parts of Europe.

**LEE**, in the sea language, a word of various significations; though it is generally understood to mean the part opposite to the wind. Thus *lee shore*, is that shore against which the wind blows. *Lee-latch*, or have a care of the lee-latch, is, take care that the ship do not go to the leeward, or too near the shore. *A lee the helm*, put it to the leeward side of the ship. *To lie by the lee*, or to come up to the lee, is to bring the ship so, that all her sails may lie flat against her masts and throats, and that the wind may come right upon her broad side.

**LEE-WAY**, is the angle that the rhumbline, upon which the ship endeavours to sail, makes with the rhumb upon which she really sails. See **NAVIGATION**.

**LEECH**, in zoology. See **HIRUDO**.

**LEEDS**, a large market town, in the west riding of Yorkshire, situated on the river Aire, twenty-miles south-west of York; it has a very great woollen trade.

**LEEK**. See **ALLIUM**.

**LEERDAM**, a town in the province of Holland, seventeen miles north east of Dort: E. long. 5°, N. lat. 51° 50'.

**LEERWICK**, a town of Scotland, in Mainland, one of the islands of Shetland, in the county of Orkney: W. long. 30', N. lat. 61° 20'.

**LEES**, are the more gross and ponderous parts of liquors, which, being separated by fermentation, fall to the bottom.

**LEET**, a little court held within a manor, and called the king's court, on account that its authority to punish offences originally belonged to the Crown, from whence it is derived to inferior persons.

**LEEWARD**, at sea, the side opposite to that on which the wind blows.

**LEEWARD-ISLANDS**, in America, a name given to the Caribbees.

**LEG**, in anatomy. See **ANATOMY**, Part I. and II. &c.

**LEGACY**, in Scots law, a donation by one person to another, to be paid by the giver's executor after his death. See **LAW**, Tit. xxviii. 3.

**LEGATEE**, in Scots law, the person to whom a legacy is provided.

**LEGATE**, a cardinal or bishop, whom the pope sends as his ambassador to sovereign princes.

**LEGATUS**, in roman antiquity, a military officer who commanded as deputy of the chief general.

**LEGEND**, any idle or ridiculous story told by the Romanists concerning their saints, and other persons, in order to support the credit of their religion.

The legend was originally a book used in the old Romish churches, containing the lessons to be read at divine service; hence the lives of the saints and martyrs came to be called legends, because chapters were read out of them at matins, and in the refectories of religious houses. Among these the golden legend, which is a collection of the lives of the saints, was received by the church with great applause, which it maintained for two hundred years; though it is so full of ridiculous and romantic stories, that the Romanists themselves are now ashamed of it.

**LEGER-LINE**, in music, one added to the staff of five lines, when the ascending or descending notes run very high or low: there are sometimes many of these lines both above and below the staff, to the number of four or five.

**LEGGIARDO**, or **LEGGIARDAMENTE**, in music, signifies to play or sing in a lively, brisk, and gay manner.

**LEGHORN**, or **LIVORNO**, a port town of Italy, in the duchy of Tuscany, situated on the Tuscan sea, forty miles west of Florence: E. long. 11°, N. lat. 43° 20'.

**LEGION**, in Roman antiquity, a body of foot which consisted of ten cohorts.

The exact number contained in a legion, was fixed by Romulus at three thousand; though Plutarch as-

sets

fires us, that after the reception of the Sabines into Rome, he encreased it to six thousand. The common number afterwards, in the first times of the free state, was four thousand; but in the war with Hannibal, it arose to five thousand; and after this it is probable that it sunk again to four thousand, or four thousand two hundred, which was the number in the time of Polybius.

**LEGISLATOR**, a law giver, or person who establishes the polity and laws of a state. Such was Moïes, among the Jews; Lycurgus, among the Lacedæmonians, &c.

**LEGITIMATION**, an act whereby illegitimate children are rendered legitimate.

**LEGITIME**, in Scots law, that share of the moveable effects belonging to a husband and wife; which upon the husband's death falls to the children. See *LAW*, Tit. xxviii. §

**LEGUME**. See *BOTANY*, p. 637.

**LEGUMINOUS**, an appellation given to all plants whose fruit is a legume

**LEICESTER**, the county-town of Leicestershire. It sends two members to parliament. W. long.  $1^{\circ} 5'$ , and N. lat.  $52^{\circ} 40'$ .

**LEININGEN**, a town of Germany, seventeen miles south of Worms.

**LEINSTER**, a province of Ireland, the capital of which is Dublin.

**LEIPSIC**, a rich and populous city of Germany, in the circle of Upper Saxony and province of Misnia: E. long.  $12^{\circ} 40'$ , N. lat.  $51^{\circ} 20'$ .

**LEITH**, a port-town of Scotland, about two miles north of Edinburgh.

**LEMBURG**, *LEOPOLIS*, a city of Poland, and capital of the province of Red Russia: E. long.  $24^{\circ}$ , N. lat.  $49^{\circ}$ .

**LEMMA**, in mathematics, a proposition which serves previously to prepare the way for the more easy apprehension of the demonstration of some theorem, or construction of some problem.

**LEMNA**, in botany, a genus of the monœcia diandria class. The calix of both male and female consists of one leaf; neither of them have any corolla; the female has one stylus, and the capsule consists of one cell. There are four species, three of which are natives of Britain, *viz.* the trifolca, or ivy-leaved duck's-meal; the minor, or least duck's-meal; and the polyrhiza, or greater duck's-meal.

**LEMNOS**, an island of the Archipelago, situated forty-miles south-west of the entrance of the Hellespont; E. lon.  $26^{\circ}$ , N. lat.  $29^{\circ}$ .

**LEMON**, in botany. See *CITRUS*.

**LEMONADE**, a liquor prepared of water, sugar, and lemon or citron juice: it is very cooling and grateful.

**LEMUR**, in zoology, a genus of quadrupeds belonging to the order of primates, the characters of which are these: There are four fore teeth in the upper jaw, the intermediate ones being remote; and six long, compressed, parallel teeth in the under jaw; the dog teeth are solitary, and the grinders are somewhat labated. There are five species, *viz.*

1. The tardigradus, is a small animal, about eight inches long; and is found in Ceylon. The head is roundish, with a prominent nose; the legs are long and thick; and the feet resemble those of a monkey; the eyes are round, and near each other; the ears are long, and situate very low on the head. The hair on the top of the head, the ears, the neck, the shoulders, the back, the sides, and the outer parts of the thighs and legs, are of a reddish ash-colour; there is a white line betwixt the ears; the under jaw, the throat, the breast, and the belly, are mixed with white and an ash colour. It has no tail. This animal is of a very singular construction. It is perhaps longer in proportion to its thickness than any other quadruped: But its natural history is but imperfectly known.

2. The mongoz, is of a greyish colour above, and white below; his body is about a foot and a half in length; and the tail is as long as the body. This animal is very troublesome when kept in a domestic state. He takes every opportunity of escaping, and flies to the woods in quest of fruits, and it is very difficult to catch him. He bites in a cruel manner those with whom he is least acquainted. He has a great aversion to cold and moisture. He lives upon bread and fruits. His motions are brisk and lively. He is a native of Madagascar.

3. The macaco has a long tail, with about 30 alternate rings of black and white, and a barbed collar. He is about a foot and four inches long, and the tail is longer than the body. His general figure very much resembles that of a monkey, excepting the head, which is somewhat triangular. The macaco is a beautiful and elegant animal. Although his figure resembles the monkey, his dispositions and manners are very different. He is gentle and inoffensive in a domestic state. In a natural state, he is fond of society: In the island of Madagascar, troops of 30 or 40 of them are generally found together in the woods.

4. The catta has likewise a long tail, with black and whiterings. This is a very gentle animal; it lives upon fruits and roots; its motion is slow; and it makes a placid murmuring noise like a cat. It is likewise a native of Madagascar.

5. The volans, resembles a bat, being furnished with a strong membrane, like that animal, by which it is enabled to fly. It is a native of Asia; but its history is not sufficiently known.

**LEMURIA**, a festival of the ancient Romans, solemnized on the ninth of May, to pacify the manes of the dead, who were the lemures or phantoms that came in the night to torment the living.

**LENA**, a great river of Siberia running north from N. lat.  $55^{\circ}$  to  $72^{\circ}$ .

**LENÆA**, in antiquity, a festival of Bacchus, surnamed Lenæus from a vine-press. Besides the usual ceremonies at feasts sacred to this god, it was remarkable for poetical contentions, and tragedies acted at this time.

**LENS**, in dioptrics, properly signifies a small roundish glass, of the figure of a lentil; but is extended to any optic glass, not very thick, which either collects the rays of light into a point, in their passage through it,

- or disperses them further apart, according to the laws of refraction. See **OPTICS**.
- LENT**, a solemn time of fasting in the Christian church, observed as a time of humiliation before Easter, the great festival of our Saviour's resurrection.
- Those of the Romish church, and some of the Protestant communion, maintain, that it was always a fast of forty days, and, as such, of apostolical institution. Others think it was only of ecclesiastical institution, and that it was variously observed in different churches, and grew by degrees from a fast of forty hours, to a fast of forty days. This is the sentiment of Morton, bishop Taylor, du Maulin, Daillie, and others.
- LENTISCUS**, in botany. See **PISTACIA**.
- LEO**, in zoology. See **FELIS**.
- LEO**, in astronomy. See **ASTRONOMY**, p. 467.
- St LEO**, a town and bishop's see of Italy, twenty miles north-west of Urbino.
- LEON**, the capital of the province of Leon, in Spain, situated on the river Esia: W. long.  $6^{\circ} 5'$ , N. lat.  $43^{\circ}$ .
- LEON** is also the capital of the province of Nicaragua, in Mexico, situated at the west end of the Lake Nicaragua: W. long.  $91^{\circ}$ , N. lat.  $11^{\circ} 30'$ .
- St LEONARD**, a town of France, in the province of Guennes, and territory of Limosin: E. long.  $1^{\circ} 45'$ , N. lat.  $45^{\circ} 50'$ .
- St. LEONHART**, a town of Germany, in the circle of Austria, and duchy of Carinthia: E. long.  $15^{\circ}$ , N. lat.  $47^{\circ}$ .
- LEONTICE**, in botany, a genus of the hexandria monogynia class. The corolla consists of six petals, and the nectarium of six leaves inserted into the unguis of the corolla, and having an open limbus; and the calix has six deciduous leaves. There are four species, none of them natives of Britain.
- LEONTINI**, a town of Sicily, twenty miles north-west of Syracuse.
- LEONTODON**, in botany, a genus of the syngenesia polygamia æqualis class. The receptacle is naked; the calix is calculated; the pappus is simple; and the floiculi are in a simple series. There are nine species, three of them natives of Britain, viz. the taraxacum, or dandelion; the hispidum, or rough dandelion; and the autumnale, or yellow devil's-bit. The root of the taraxacum is esteemed a good cathartic.
- LEONURUS**, **LION'S TAIL**, in botany, a genus of the didynamia gymnosperma class. The antheræ are interspersed with shining glands. There are five species, only one of them, viz. the cardiaca, or mother-wort, is a native of Britain.
- LEOPARD**. See **FELIS**.
- LEOPARD'S BANE**, in botany. See **DORONICUM**.
- LEPANTO**, a port-town of European Turkey, eighty miles west of the isthmus of Corinth; whence the gulph of Lepanto takes its name.
- LEPASTRUM**, in natural history, a genus of selenitæ, composed of plates disposed in the form of a radiated star.
- LEPIDIDIUM**, in botany, a genus of the tetradyamia filiculosa class. The pod is emarginated, cordated, and contains many seeds. There are 17 species, three of them natives of Britain, viz. the latifolium, or dittander: the ruderale, narrow-leaved wild cress, or dittander; and the petræum, or mountain dittander.
- LEPIDOPTERA**, in zoology, an order of insects, with four wings, which are covered with imbricated squamulæ. See **NATURAL HISTORY**.
- LEPIUM**, in natural history, a genus of fossils of the harder gypsum, composed of very small particles, and of a less glittering hue.
- There is only one species of this genus, being one of the least valuable and most impure of the class of gypsums. It is of an extremely rude, irregular, coarse and unequal structure; a little soft to the touch, of a very dull appearance, and of different degrees of a greyish white. It is burnt in plaister for the coarser works; it calcines very slowly and unequally, and makes but a very coarse and ordinary plaister.
- LEPROSY**, a foul cutaneous disease, appearing in dry, white, thin, scurfy scabs, either on the whole body, or only some part of it, and usually attended with a violent itching and other pains. See **MEDICINE**.
- LEPTODECORHOMBES**, in natural history, a genus of fossils of the order of the selenitæ; consisting of ten planes, each so nearly equal to that opposite to it as very much to approach to a decahedral parallelopiped, though never truly or regularly so.
- Of this genus there are only five known species. 1. A thin, fine, pellucid, and slender streaked one, with transverse striæ, found in considerable quantities in the strata of clay in most parts of England, particularly near Heddington in Oxfordshire. 2. A thin, dull-looking opaque, and slender streaked one, more scarce than the former, and found principally in Leicestershire and Staffordshire. 3. A thin fine streaked one, with longitudinal striæ, found in the clay-pits at Richmond, and generally lying at great depths. This has often on its top and bottom a very elegant smaller rhomboide, described by four regular lines. 4. A rough kind, with thick transverse striæ, and a scabrous surface, very common in Leicestershire and Yorkshire. And, 5. a very short kind, with thick plates, common in the clay-pits of Northamptonshire and Yorkshire.
- LEPTOPOLYINGLIMI**, in Natural History, a genus of fossil shells, distinguished by a number of minute teeth at the cardo; whereof we find great numbers at Harwick cliff, and in the marle-pits of Suffex.
- LEPTURA**, in zoology, a genus of insects belonging to the order of coleoptera, the characters of which are these:—The feelers are bristly; the elytra are attenuated towards the apex; and the thorax is somewhat cylindrical. There are 25 species, principally distinguished by their colour.
- LEPUS**, in zoology, a genus of quadrupeds belonging to the order of glires. The characters are these: they have two fore teeth in each jaw; those in the upper jaw are double, the interior ones being smallest. There are four species, viz.
1. The timidus, or hare, has a short tail; the points of the ears are black; the upper-lip is divided up to the

the nostrils; the length of the body is generally about a foot and a half; and the colour of the hair is reddish, interspersed with white. The hare is naturally a timid animal. He sleeps in his form, or seat, during the day, and feeds, copulates, &c. in the night. In a moon-light evening, a number of them are sometimes seen sporting together, leaping and pursuing each other: But the least motion, the falling of a leaf, alarms them; and then they all run off separately, each taking a different route. They are extremely swift in their motion, which is a kind of gallop, or a succession of quick leaps. When pursued, they always take to the higher grounds: as their fore-feet are much shorter than the hind ones, they run with more ease up-hill than down hill. The hare is endowed with all those instincts which are necessary for his own preservation. In winter he chuses a form exposed to the south, and in summer to the north. He conceals himself among vegetables of the same colour with himself. Mr Fouilloux says, that he observed a hare, as soon as he heard the sound of the horn, or the noise of the dogs, although at a mile's distance, rise from her seat, swim across a rivulet, then lie down among the rushes, and by this means evade the scent of the dogs. After being chased for a couple of hours, a hare will sometimes push another from his form, and lie down in it himself. When hard pressed, the hare will mingle with a flock of sheep, run up an old wall and conceal himself among the grass on the top of it, or cross a river several times at small distances. He never runs against the wind, or straight forward; but constantly doubles about, in order to make the dogs lose their scent.

It is remarkable, that the hare, although ever so frequently pursued by the dogs, seldom leaves the place where he was brought forth, or even the form in which he usually sits. It is common to find them in the same place next day, after being long and keenly chased the day before. The females are more gross than the males, and have less strength and agility; they are likewise more timid, and never allow the dogs to approach so near their form before rising as the males. They likewise practise more arts, and double more frequently, than the males.

The hare is diffused almost over every climate; and, notwithstanding they are every where hunted, their species never diminishes. They are in a condition of propagating the first year of their lives; the females go with young about 30 days, and produce four or five at a time; and as soon as they have brought forth, they again admit the embraces of the male; so that they may be said to be always pregnant. The eyes of the young are open at birth; the mother suckles them about 20 days, after which they separate from her and procure their own food. The young never go far from the place where they were brought forth; but still they live solitary, and make forms about thirty paces distant from each other: Thus, if a young hare be found any where, you may almost be certain of finding several others within a very small distance. The hare is not so savage as his manners would indicate. He is gentle, and susceptible of a kind of education. He is pretty easily tamed, and will even show a kind of attachment to the people of the house: But still this attachment is not so strong or lasting as to engage

him to become altogether domestic; for although taken when very young, and brought up in the house, he no sooner arrives at a certain age, than he takes the first opportunity of recovering his liberty and flying to the fields. The hare lives about seven or eight years. He feeds upon grass, and other vegetables. His flesh is excellent food. See Plate CIII. fig. 2.

2. The cuniculus, or rabbit, has a very short tail, and naked ears. The rabbit, though it has a great resemblance to the hare, is very different in his manners; and they have such a rooted antipathy to one another, that no art can engage them to have any sexual intercourse. The fecundity of the rabbit is still greater than that of the hare; they multiply so prodigiously in some countries, that the product of the fields is hardly sufficient to maintain them. They devour herbage of all kinds, roots, grain, fruits, &c. They are in a condition for producing at the age of six months; like the hare, the female is almost constantly in season; she goes with young about 30 days, and brings forth from four to eight at a litter. A few days before littering, she digs a new hole in the earth, not in a straight line, but in a zigzag form; the bottom of the hole she enlarges every way; she then pulls off a great quantity of hair from her belly, of which she makes a kind of bed for her young. During the two first days after birth, she never leaves them, but when pressed with hunger, and then she eats quickly and returns: In this manner she suckles and attends her young for six weeks. All this time, both the hole and the young are concealed from the male; sometimes when the female goes out, in order to deceive the male, she fills up the mouth of the hole with earth mixed with her own urine. But when the young ones begin to come to the mouth of the hole, and to eat such herbs as the mother brings to them, the father seems to know them; he takes them betwixt his paws, smooths their hair, and caresses them with great fondness. The rabbit is supposed not to be a native of the northern parts of Europe, but to have been originally brought from Greece and Spain. The rabbit lives about seven years, and his flesh is good. Their colour is various, some of them being red, others white, but the most general colour is grey. See Plate CIII. fig. 3.

3. The capensis, has a tail about the length of his head and red legs. It is a native of the Cape of Good Hope.

4. The brasiliensis has no tail. It is found in South America.

LEPUS, in astronomy. See ASTRONOMY, p. 487.

LERIA, a city and bishop's see of Portugal: W. long.  $9^{\circ} 15'$ , and N. lat.  $39^{\circ} 30'$ .

LERIDA, a city and bishop's see of Catalonia in Spain: E. long.  $5'$ , N. lat.  $41^{\circ} 20'$ .

LERINS, two islands on the coast of Provence, five or six miles south of Antibes, called St. Margaret and St. Honorat.

LERNEA, the SEA-HARE, in zoology, a sea-insect of the order of the gymnarthria, the body of which is of an oblong cylindrical figure, and is perforated in the forehead; the tentacula resemble ears. See GYMNARTHRIA.

I.E.



**LE ROY LE VEUT**, the king's assent to public bills.  
See the articles **BILL**, **STATUTE**, and **PARLIAMENT**.

**LESBOS**, or **METEIN**, an island of the Archipelago, sixty miles north-west of Smyrna. Its chief town is Castro.

**LESCAR**, a city and bishop's see of France, forty miles east of Bayonne.

**LESCARD**, a borough-town of Cornwall, fifteen miles west of Launceston, which sends two members to parliament.

**LESSINES**, a town of the Austrian Netherlands, fourteen miles north of Mons.

**LESSONS**, among ecclesiastical writers, portions of the Holy Scriptures, read in Christian churches, at the time of divine service.

**LESTWITHIEL**, a borough-town of Cornwall, twenty-three miles south-west of Launceston, which sends two members to parliament.

**LETHARGY**, in medicine. See **MEDICINE**.

**LETHE**, in the ancient mythology, one of the rivers of hell, signifying oblivion or forgetfulness; its waters having, according to poetical fiction, the peculiar quality of making those who drank of them forget every thing that was past.

**LETRIM**, or **LEITRIM**, a county of Ireland, in the province of Connaught; bounded by Fermanagh on the north, by Cavan on the east, by Roscommon on the south, and by Sligo on the west.

**LETTER**, a character used to express one of the simple sounds of the voice; and as the different simple sounds are expressed by different letters, these, by being differently compounded, become the visible signs or characters of all the modulations and mixtures of sounds used to express our ideas in a regular language.

**LETTER of attorney**, in law, is a writing by which one person authorises another to do some lawful act in his stead; as, to give scisin of lands, to receive debts, sue a third person, &c.

The nature of this instrument is to transfer to the person to whom it is given, the whole power of the maker, to enable him to accomplish the act intended to be performed. It is either general or special; and sometimes it is made revocable, which is when a bare authority is only given; and sometimes it is irrevocable, as where debts, &c. are assigned from one person to another. It is generally held, that the power granted to the attorney must be strictly pursued; and that where it is made to three persons, two cannot execute it. In most cases, the power given by a letter of attorney determines upon the death of the person who gave it. No letter of attorney made by any seaman, &c. in any ship of war, or having letters of marque, or by their executors, &c. in order to empower any person to receive any share of prizes, or bounty-money, shall be valid, unless the same be made revocable, and for the use of such seamen, and be signed and executed before, and attested by, the captain and one other of the signing officers of the ship, or the mayor or chief magistrate of some corporation.

**LETTER of mart**, or **marque**, a letter granted to one

of the king's subjects, under the privy seal, empowering him to make reprisals for what was formerly taken from him by the subjects of another state contrary to the law of mart. See the article **MARQUE**.

**LETTERS-PATENT**, are writings sealed with the great seal; so called, because they are open, with the seal affixed to them. These are granted to authorise a man to do or enjoy what of himself he could not do.

**LETTUCE**, in botany. See **LACTUCA**.

**LEVANT**, a name given to the east part of the Mediterranean sea, bounded by Natolia or the lesser Asia on the north, by Syria and Palestine on the east, by Egypt and Barca on the south, and by the island of Candia and the other part of the Mediterranean on the west.

**LEVATOR**, in anatomy, a name given to several muscles. See **ANATOMY**, Part II.

**LEUCADENDRON**, in botany, a genus of the tetrandria monogynia class. The stamens have two petals, one of them being divided into segments; the receptacle is somewhat hairy; it has no proper calix; and the antheræ are joined together. There are 15 species, none of them natives of Britain.

**LEUCOBIUM**, the **GREAT SNOW-DROP**, in botany, a genus of the hexandria monogynia class. The corolla is bell-shaped, and divided into six segments; and the stigma is simple. There are three species, none of them natives of Britain.

**LEUCOMA**, in surgery, a distemper of the eye, otherwise called albugo. See **ALBUGO** and **MEDICINE**.

**LEUCOPHLEGMATIA**, in medicine, a kind of dropsy, otherwise called anasarca. See **ANASARCA** and **MEDICINE**.

**LEVEL**, an instrument wherewith to draw a line parallel to the horizon, by means of which the true level, or the difference of ascent or descent between several places, may be found for conveying water, draining fens, &c.

There are several instruments of different contrivance and matter, invented for the perfection of levelling all of which, for the practice, may be reduced to those that follow

**Air LEVEL**, that which shews the line of level by means of a bubble or air inclosed with some liquor in a glass-tube of an indeterminate length and thickness, whose two ends are hermetically sealed: When the bubble fixes itself at a certain mark, made exactly in the middle of the tube, the plane or ruler wherein it is fixed is level. When it is not level, the bubble will rise to one end. This glass-tube may be set in another of brass, having an aperture in the middle, whence the bubble of air may be observed. The liquor wherewith the tube is filled, is oil of tartar, or aqua secunda; those not being liable to freeze as common water, nor to rarefaction and condensation, as spirit of wine is. There is one of these instruments with sights, being an improvement upon that last described, which, by the addition of more apparatus, becomes more commodious and exact. It consists of an air level, (see Plate CIV. fig. 1.) n<sup>o</sup> 1. about eight inches long, and seven or eight lines in diameter, set in a brass-tube.

2. with

Fig. 1. LEVELS

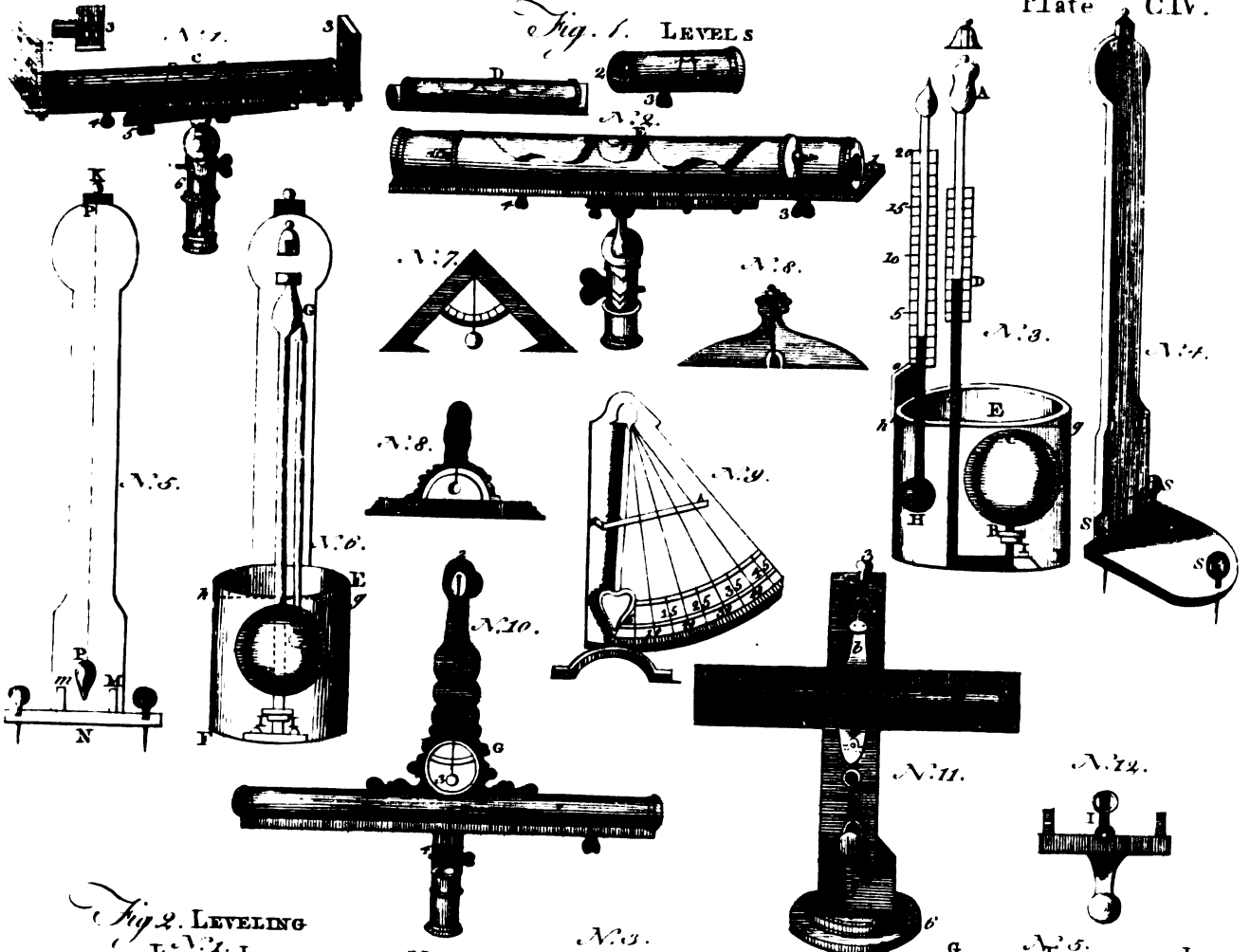


Fig. 2. LEVELING

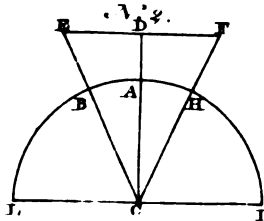
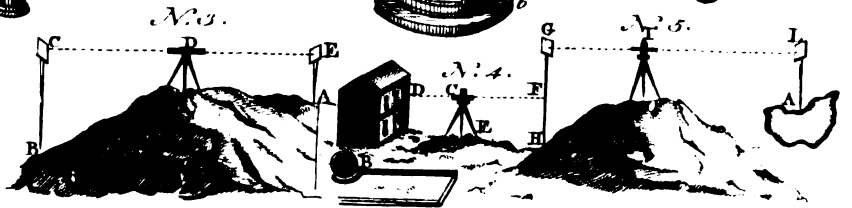
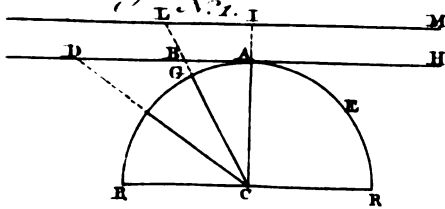


Fig. 3. LOGARITHMS

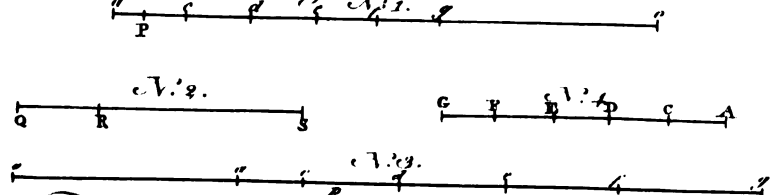
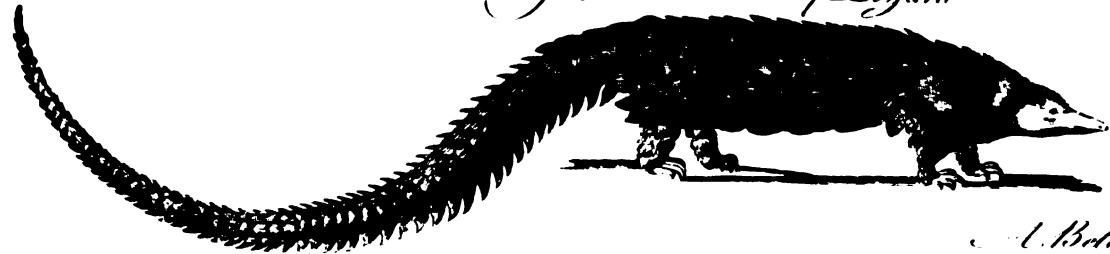


Fig. 4. MANTIS or Scaly Lizard





2, with an aperture in the middle, C. The tubes are carried in a strong straight ruler, a foot long; at whose ends are fixed two sights, 3, 3, exactly perpendicular to the tubes, and of an equal height, having a square hole, formed by two fillets of brass crossing each other at right angles; in the middle whereof is drilled a very little hole, through which a point on a level with the instrument is descried. The brass-tube is fastened on the ruler by means of two screws, one whereof, marked 4, serves to raise or depress the tube at pleasure, for bringing it towards a level. The top of the ball and socket is rivetted to a little ruler that springs, one end whereof is fastened with screws to the great ruler, and at the other end has a screw, 5, serving to raise and depress the instrument when nearly level.

This instrument, however, is yet less commodious than the following one; because though the holes be ever so small, yet they will still take in too great a space to determine the point of level precisely.

This instrument consists of an air level, with telescope sights: this level (*ibid.* n<sup>o</sup> 2.) is like the last, with this difference, that instead of plain sights, it carries a telescope to determine exactly a point of level at a good distance. The telescope is a little brass-tube, about fifteen inches long, fastened on the same ruler as the level. At the end of the tube of the telescope, marked 1, enters the little tube 1, carrying the eye-glass and an hair horizontally placed in the focus of the object-glass, 2; which little tube may be drawn out, or pushed into the great one, for adjusting the telescope to different sights: at the other end of the telescope is placed the object-glass. The screw 3, is for raising or lowering the little fork, for carrying the hair, and making it agree with the bubble of air, when the instrument is level; and the screw 4, is for making the bubble of air, D or E, agree with the telescope: the whole is fitted to a ball and socket. M. Huygens is said to be the first inventor of this level, which has this advantage, that it may be inverted by turning the ruler and telescope half round; and if then the hair cut the same point that it did before, the operation is just.

It may be observed, that one may add a telescope to any kind of level, by applying it upon or parallel to the base or ruler, when there is occasion to take the level of remote objects.

Dr Desaguliers contrived an instrument, by which the difference of level of two places, which could not be taken in less than four or five days with the best telescope-levels, may be taken in as few hours. The instrument is as follows: to the ball C (*ibid.* n<sup>o</sup> 3.) is joined a recurve tube B A, with a very fine bore, and a small bubble at top, A, whose upper part is open. It is evident from the make of this instrument, that if it be inclined in carrying, no prejudice will be done to the liquor, which will always be tight both in the ball and tube when the instrument is set upright. If the air at C, be so expanded with heat, as to drive the liquor to the top of the tube, the cavity A will receive the liquor, which will come down again and settle at D, or near it, according to the level of the place where the instrument is, as soon as the air at C returns to the same temperament as to heat and cold. To preserve the same

degree of heat, when the different observations are made, the machine is fixed in a tin vessel E F, filled with water up to *g h*, above the ball, and a very sensible thermometer has also its ball under water, than one may observe the liquor at D, in each experiment, when the thermometer stands at the same height as before. The water is poured out when the instrument is carried, which one may do conveniently by means of the wooden frame, which is set upright by the three screws S, S, S, *ibid.* n<sup>o</sup> 4, and a line and plummet P P, n<sup>o</sup> 5. At the back part of the wooden frame, from the piece at top K, hangs the plummet P, over a brass point at N; M *m* are brackets, to make the upright board K N continue at right angles with the horizontal one at N. N<sup>o</sup> 6, represents a front view of the machine, supposing the fore part of the tin-vessel transparent; and here the brass-socket of the recurve tube, into which the ball is screwed, has two wings at I I, fixed to the bottom, that the ball may not break the tube by its endeavour to emerge when the water is poured in as high as *g h*.

After the Dr had contrived this machine, he considered, that as the tube is of a very small bore, if the liquor should rise into the ball at A, n<sup>o</sup> 3 in carrying the instrument from one place to another, some of it would adhere to the sides or the ball A, and upon its descent in making the experiment, so much might be left behind, that the liquor would not be high enough at D, to shew the difference of the level: therefore, to prevent that inconveniency, he contrived a blank screw, to shut up the hole at A, as soon as one experiment is made, that in carrying the machine, the air in A may balance that in C, so that the liquor shall not run up and down the tube, whatever degree of heat and cold may act upon the instrument, in going from one place to another. Now, because one experiment may be made in the morning, the water may be so cold, that when a second experiment is made at noon the water cannot be brought to the same degree of cold it had in the morning; therefore, in making the first experiment, warm water must be mixed with the cold, and when the water has stood some time before it comes to be as cold as it is likely to be at the warmest part of that day, observe and set down the degree of the thermometer at which the spirit stands, and likewise the degree of the water in the barometer at D; then screw on the cap at A, pour out the water, and carry the instrument to the place whose level you would know; then pour in your water, and when the thermometer is come to the same degree as before, open the screw at top, and observe the liquor in the barometer.

The doctor's scale for the barometer is ten inches long, and divided into tenths; so that such an instrument will serve for any heights not exceeding ten feet, each tenth of an inch answering to a foot in height.

The Dr made no allowance for the decrease of density in the air, because he did not propose this machine for measuring mountains, (though with a proper allowance for the decreasing density of the air, it will do very well), but for heights that want to be known in gardens, plantations, and the conveyance of water, where an experiment that answers two or three feet in a distance of twenty miles, will render this a very useful instrument.

**Artillery Foot-LEVEL** is in form of a square, having its two legs or branches of an equal length; at a juncture whereof is a little hole, whence hangs a thread and plummet playing on a perpendicular line in the middle of a quadrant. It is divided into twice 45 degrees from the middle, *ibid* n<sup>o</sup> 7.

This instrument may be used on other occasions, by placing the ends of its two branches on a plane; for when the thread plays perpendicularly over the middle division of the quadrant, that plane is assuredly level. To use it in gunnery, place the two ends on the piece of artillery, which you may raise to any proposed height, by means of the plummet, whose thread will give the degree above the level.

**Carpenters and Paviour's LEVEL**, consists of a long ruler, in the middle whereof is fitted, at right angles, another somewhat bigger, at the top of which is fastened a line, which, when it hangs over a fiducial line at right angles with the base, shews that the said base is horizontal. Sometimes this level is all of one board. *Ibid*. n<sup>o</sup> 8.

**Gunner's LEVEL**, for levelling cannons and mortars, consists of a triangular brass-plate, about four inches high, *ibid*. 9. at the bottom of which is a portion of a circle, divided into 45 degrees; which number is sufficient for the highest elevation of cannons and mortars, and for giving shot the greatest range: on the center of this segment of a circle is screwed a piece of brass, by means of which it may be fixed or screwed at pleasure; the end of this piece of brass is made so as to serve for a plummet and index, in order to shew the different degrees of elevation of pieces of artillery. This instrument has also a brass-foot, to set upon cannons or mortars, so as, when those pieces are horizontal, the instrument will be perpendicular. The foot of this instrument is to be placed on the piece to be elevated, in such a manner, as that the point of the plummet may fall on the proper degree: this is what they call levelling the piece.

**Mason's LEVEL**, is composed of three rules, so joined as to form an isocetes-rectangle, somewhat like a roman A; at the vertex whereof is fastened a thread, from which hangs a plummet, that passes over a fiducial line, marked in the middle of the base, when the thing to which the level is applied is horizontal; but declines from the mark, when the thing is lower on one side than on the other.

**Plumb, or Pendulum-LEVEL**, that which shews the horizontal lines by means of another line perpendicular to that described by a plummet or pendulum. This instrument, *ibid*. n<sup>o</sup> 10. consists of two legs or branches, joined together at right angles, whereof that which carries the thread and plummet is about a foot and a half long; the thread is hung towards the top of the branch, at the point 2. The middle of the branch where the thread passes is hollow, so that it may hang free every where: but towards the bottom, where there is a little blade of silver, whereon is drawn a line perpendicular to the telescope, the said cavity is covered by two pieces of brass, making as it were a kind of case, lest the wind should agitate the thread; for which reason

the silver blade is covered with a glass *G*, to the end that it may be seen when the thread and plummet play upon the perpendicular: the telescope is fastened to the other branch of the instrument, and is about two feet long: having an hair placed horizontally across the focus of the object-glass, which determines the point of the level. The telescope must be fitted at right angles to the perpendicular. It has a ball and socket, by which it is fastened to the foot, and was invented by M. Picard.

**Reflecting LEVEL**, that made by means of a pretty long surface of water representing the same object inverted which we see erected by the eye, so that the point where these two objects appear to meet is a level with the place where the surface of the water is found. This is the invention of M. Marriotte.

There is another reflecting level consisting of a mirror of steel, or the like, well polished, and placed a little before the object-glass of a telescope, suspended perpendicularly. This mirror must make an angle of 45° with the telescope, in which case the perpendicular line of the said telescope is converted into a horizontal line, which is the same with the line of level. This is the invention of M. Cassini.

**Water LEVEL**, that which shews the horizontal line by means of a surface of water or other liquor, founded on this principle, that water always places itself level. See the article FLUID.

The most simple is made of a long wooden trough, or canal, whose sides are parallel to the base, so that being equally filled with water, its surface shews the line of level. This is the chorobates of the ancients. See CHOROBATA.

It is also made with two cups fitted to the two ends of a pipe, three or four feet long, about an inch in diameter, by means whereof the water communicates from the one to the other cup; and this pipe being moveable on its stand by means of a ball and socket, when the two cups become equally full of water, their two surfaces mark the line of level.

This instrument, instead of cups, may also be made with two short cylinders of glass three or four inches long, fastened to each extreme of the pipe with wax or mastic. Into the pipe is poured some common or coloured water, which shews itself through the cylinders, by means whereof the line of level is determined; the height of the water, with respect to the center of the earth, being always the same in both cylinders: this level, though very simple, is yet very commodious for levelling small distances.

**LEVEL of Mr Huygens's invention**, consists of a telescope *a*, *ibid*. n<sup>o</sup> 11. in form of a cylinder, going through a ferril, in which it is fastened by the middle. This ferril has two flat branches *b b*, one above, and the other below; at the ends whereof are fastened little moving pieces, which carry two rings, by one of which the telescope is suspended to a hook at the end of the screw *3*, and by the other a pretty heavy weight is suspended, in order to keep the telescope in equilibrio. This weight hangs in the box *5*, which is almost filled with linseed oil, oil of walnuts, or other matter that

that will not easily coagulate, for more aptly settling the balance of the weight and telescope. The instrument carries two telescopes close and very parallel to each other; the eye glass of the one being against the object-glass of the other, that one may see each way without turning the level. In the focus of the object-glass of each telescope mult a little hair be strained horizontally, to be raised and lowered as occasion requires by a little screw. If the tube of the telescope be not found level when suspended, a ferril or ring, 4, is put on it, and is to be slid along till it fixes to a level. The hook on which the instrument is hung, is fixed to a flat wooden cross; at the ends of each arm whereof there is a hook serving to keep the telescope from too much agitation in using or carriage. To the said flat cross is applied another hollow one, that serves as a case for the instrument; but the two ends are left open, that the telescope may be secured from the weather, and always in a condition to be used. The foot of this instrument is a round brass plate, to which are fastened three brass ferils, moveable by means of joints wherein are put staves, and on this foot is placed the box.

N<sup>o</sup> 12. marked I, is a balance-level; which being suspended by the ring, the two sights, when in equilibrio, will be horizontal, or in a level.

**LEVELLING**, the art of finding a line parallel to the horizon at one or more stations, in order to determine the height of one place with regard to another. See the preceding article.

A truly level surface is a segment of a spherical surface, which is concentric to the globe of the earth. A true line of level is an arch of a great circle, which is imagined to be described upon a truly level surface. The apparent level is a straight line drawn tangent to an arch or line of true level. Every point of the apparent level, except the point of contact, is higher than the true level: thus let EAG (Plate CIV. fig. 2. n<sup>o</sup> 1.) be an arch of a great circle drawn upon the earth; to a person who stands upon the earth at A, the line HD is the apparent level parallel to his rational horizon RR; but this line, the farther it is extended from his station A, the farther it recedes from the center; for BC is longer than AC; and DC is longer than BC, &c. The common methods of levelling are sufficient for laying pavements of walks, for conveying water to small distances, for placing horizontal dials, or astronomical instruments; but in levelling the bottoms of canals which are to convey water to the distance of many miles, the difference between the apparent and true level must be taken into the account: thus let IAL (ibid. n<sup>o</sup> 2.) be an arch of a great circle upon the earth: let it be required to cut a canal whose bottom shall be a true level from A to B, of the length of 5078 feet: the common method is to place the levelling instrument in the bottom of the canal at A, and looking through the sights placed horizontally at a stick set up perpendicular at B, to make a mark where the visual ray or point of the apparent level points at E, and then to sink the bottom of the canal at B as much below E as A is below D. But this will not

give the true level: for according to Cassini's calculation, at the distance of 5078 feet the apparent level is seven inches above the true; and therefore, to make a true level, B must be sunk seven inches lower than the apparent level directs; so that if A be four feet below D, B must be four feet seven inches below the mark E. We have here mentioned the error which will arise from placing the level at one end of the line to be levelled, and shewn how to correct it; but in most cases it is better to take a station in the middle of the line to be levelled: thus, if the points H and B are to be levelled, place the instrument in the middle at A, and setting up sticks perpendicular at H and B, make marks upon each stick where the apparent level points, as E and F; those points are level: and if you sink H as much below F, as B is below E, HAB will be a true level.

The operation of levelling is as follows: suppose the height of the point A, (ibid. n<sup>o</sup> 3.) on the top of a mountain above that of the point B, and at the foot thereof, be required. Place the level about the middle distance between the two points as in D, and staffs in A and B; and let there be persons instructed with signals for raising and lowering, on the said staffs, little marks of pasteboard or other matter, the level being placed horizontally by the bubble, &c. Look towards the staff AE, and cause the mark so raised to be lowered till the middle, upper edge, or other most conspicuous part, appear in the visual ray. Then measuring exactly the perpendicular height of the point E above the point A, which suppose six feet four inches; set that down in your book: then turn the level horizontally about, that the eye-glass of the telescope may be still next the eye when you look the other way; if you have only plain sights, the instrument need not be turned; and cause the person at the staff B, to raise or lower his mark, till some conspicuous part of it fall in the visual ray, as at C: then measure the perpendicular height of C above B, which suppose sixteen feet six inches: set this also down in the book above the other number of the first observation; subtract the one from the other, the remainder will be ten feet two inches, which is the difference of the level between A and B, or the height of the point A above the point B.

If the point D, where the instrument is fixed, be in the middle between the two points A and B, there will be no necessity for reducing the apparent level to the true level; the visual ray in that case being raised equally above the true level. If it be further required to know whether there be a sufficient descent for conveying water from the spring A (ibid. n<sup>o</sup> 4.) to the point B. Here, in regard the distance from A to B is considerable, it is required that several operations be made. Having then chosen a proper place for the first station, as at I. set up a staff in the point A, near the spring, with a proper mark to slide up and down the staff, as L, and measure the distance from A to I, which suppose two thousand yards. Then the level being adjusted in the point I. let the mark L be raised and lowered till such time as you spy some conspicuous part of it through the telescope or sights of the level, and measure the height AL, which suppose thirteen feet five inches. But in regard the distance AI is two thousand yards, you must have recourse

to.

to your table for a reduction, subtracting eleven inches, which will leave the height of AL twelve feet six inches, and this note down in your book. Now turn the level horizontally about, so that the eye-glass of the telescope may be towards A, and fixing up another staff at H, cause the mark G to be moved up and down till you spy some conspicuous part through the telescope or sights. Measure the height HG, which suppose seven yards one foot two inches. Measure likewise the distance of the points IH, which suppose one thousand three hundred yards; for which distance four inches eight lines must be subtracted from the height HG, which consequently will only leave seven yards nine inches four lines, to be taken down in your book. This done, remove the level forwards to some other eminence, as E, whence the staff H may be viewed; as also another staff at D, near the place whither the water is to be conveyed. The level being again adjusted in the point E, look back to the staff H; and managing the mark as before, the visual ray will give the point F. Measure the height HF, which suppose eleven feet six inches. Measure likewise the distance HE, which suppose a thousand yards, for which there is two inches nine lines of abatement; which being taken from the height HF, there will remain eleven feet three inches three lines; which enter in your book. Lastly, turning the level to look at the next staff D, the visual ray will give the point D. Measure the height of D from the ground, which suppose eight feet three inches. Measure also the distance from the station E to B, which suppose nine hundred yards, for which distance there are two inches three lines of abatement; which being taken from the height BD, there will remain eight feet nine lines; which enter as before.

For the manner of entering down observations in your book, observe, that when a proper place or station for the level between the two points has been pitched upon, write down the two heights observed at that station in two different columns, *viz.* under the first column, those observed in looking through the telescope when the eye was from the spring, or towards the point, which we may call back sights; and under the second column, those observed when the eye was next the spring, which we call foresights. Having summed up the heights of each column separately, subtract the lesser from the greater, the remainder will be the difference of the level between the points A and B. If the distance of the two points be required, add all the distances measured together; and dividing the difference of height by the yards of the distances, for each two hundred yards you will have a descent of about two inches nine lines.

Dr. Halley suggests a new method of levelling, performed wholly by means of the barometer, in which the mercury is found to be suspended to so much the less height, as the place is farther remote from the center of the earth; whence the different heights of the mercury in two places give the difference of level. This method has been put in practice by some of the French academy.

**LEVELLING STAVES**, instruments used in levelling, serving to carry the marks to be observed, and at the same time to measure the heights of those marks from the ground. They usually consist each of two long wooden rulers, made to slide over ope another, and divide into feet, inches, &c.

**LEVER**, or **LEAVER**, in mechanics. See **Mechanics**.

**LEVERET**, among sportsmen, denotes a hare in the first year of her age.

**LEVIGATION**, in pharmacy and chemistry, the reducing hard and ponderous bodies to an impalpable powder, by grinding them on a porphyry, or the like.

**LEVITE**, in a general sense, means all the descendants of Levi, among whom were the Jewish priests themselves, who being descended from Aaron, were likewise of the race of Levi: but it is more particularly used for an order of officers in that church, who were employed in performing the manual service of the temple, such as in fetching wood, water, and other things necessary for the sacrifices, and in singing and playing upon instruments of music.

**LEVITICUS**, a canonical book of the Old Testament, so called from its containing the laws and regulations relating to the priests, Levites, and sacrifices.

**LEVITY**, in physiology, the privation or want of weight in any body, when compared with another that is heavier than it, in which sense it stands opposed to gravity.

**LEVY**, in law, signifies to gather or collect, as to levy money: and to levy a fine of lands, is the passing a fine.

**LEWARDEN**, a city of the United Provinces, the capital of west Friesland: E. long.  $5^{\circ} 35'$ , N. lat.  $53^{\circ} 20'$ .

**LEWES**, a borough-town of Sussex, forty miles south of London, which sends two members to parliament.

**LEWIS**, the most northerly of any of the western islands of Scotland, lying in  $8^{\circ}$  odd minutes W. long. and between  $58^{\circ}$  and  $59^{\circ}$  odd minutes N. lat.

**LEXICON**, the same as dictionary, but chiefly used in speaking of Greek dictionaries. See **Dictionary**.

**LEYDEN**, a city of Holland, in which there is a famous university, situated twenty miles south of Amsterdam.

**LEYTE**, one of the Philippine islands, separated from the island Philippina by a narrow channel: E. long.  $123^{\circ}$ , N. lat.  $11^{\circ}$ .

**LIBANUS**, a range of mountains in Asiatic Turkey, between Syria and Palestine, which extend from Sidon on the Levant, eastward beyond Damascus.

**LIBATION**, a religious ceremony among the ancient pagans, which consisted in an effusion of liquors poured on the head of the victims prepared for sacrifice.

**LIBAW**, a port-town of Poland, in the duchy of Courland, situated on a bay of the Baltic: E. long.  $21^{\circ}$ , N. lat.  $56^{\circ} 40'$ .

**LIBELLULA**, in the history of insects, a genus of four-winged flies, called in English dragon-flies, or adder-flies; the characters of which are these: The mouth is furnished with jaws; the feelers are shorter than the

breast; and the tail of the male terminates in a kind of hooked forceps. There are 21 species, chiefly distinguished by their colour.

**LIBER**, among botanists, denotes the rind or inner bark of trees.

**LIBERIA**, in Roman antiquity, a festival observed on the sixteenth of the calends of April, at which time the youth laid aside their juvenile habit for the toga virilis, or habit peculiar to grown men.

**LIBERTUS**, in Roman antiquity, a person who from being a slave had obtained his freedom.

The difference between the *liberti* and *libertini* was this: the *liberti* were such as had been actually made free themselves, and the *libertini* were the children of such persons.

**LIBERTY**, in general, denotes a state of freedom, in contradistinction to slavery.

According to Cicero, liberty is the power of living as a man pleases, or without being controlled by another.

In a legal sense, liberty signifies some privilege that is held by charter or prescription.

**LIBRA**, the **BALANCE**, in astronomy. See **ASTRONOMY**, p. 487.

**LIBRA**, in Roman antiquity, a pound weight; also a coin, equal in value to twenty denarii.

**LIBRARY**, an edifice or apartment destined for holding a considerable number of books placed regularly on shelves; or, the books themselves lodged in it.

The first who erected a library at Athens was the tyrant Pisistratus, which was transported by Xerxes into Persia, and afterwards brought back by Seleucus Nicator to Athens. Plutarch says, that under Eumenes there was a library at Pergamus that contained 200,000 books. That of Ptolemy Philadelphus, according to A. Gellius, contained 700,000, which were all burnt by Cæsar's soldiers. Constantine and his successors erected a magnificent one at Constantinople, which in the eighth century contained 300,000 volumes; and among the rest, one in which the *Iliad* and *Odyssey* were written in letters of gold, on the guts of a serpent: but this library was burnt by order of Leo Isaurus. The most celebrated libraries of ancient Rome, were the Ulpian and the Palatine, and in modern Rome that of the Vatican. The foundation of the Vatican library was laid by pope Nicholas, in the year 1450; it was afterwards destroyed in the sacking of Rome by the constable of Bourbon, and restored by pope Sixtus V. and has been considerably enriched with the ruins of that of Heidelberg, plundered by count Tilly in 1682. One of the most complete libraries in Europe, is that erected by Cosmo de Medicis; though it is now exceeded by that of the French king, which was begun by Francis I. augmented by cardinal Richelieu, and completed by M. Colbert. The emperor's library at Vienna, according to Lambecius, consists of 80,000 volumes, and 15,940 curious medals. The Bodleian library at Oxford exceeds that of any university in Europe, and even those of any of the sovereigns of Europe, except the emperor's and the French king's, which are each of them older by a hundred years. It was

first opened in 1602, and has since been increased by a great number of benefactors: indeed the Medicean library, that of Bessarion at Venice, and those just mentioned, exceed it in Greek manuscripts; but it outdoes them all in Oriental manuscripts; and as to printed books, Ambrosian at Milan, and that of Wolfenbuttel, are two of the most famous, and yet both are inferior to the Bodleian. The Cotton library consists wholly of manuscripts, particularly of such as relate to the history and antiquities of Britain; which, as they are now bound, make about 1000 volumes.

In Edinburgh there is a good library belonging to the university, well furnished with books; which are kept in good order, and cloistered up with wire-doors, that none but the keeper can open, and are now lent out only upon consignment of the price; a method much more commodious than the multitude of chaigs used in other libraries. There is also a noble library of books and manuscripts belonging to the faculty of Advocates. See **ADVOCATE**.

**LIBRATION**, in astronomy, an apparent irregularity of the moon's motion, whereby she seems to librate about her axis, sometimes from the east to the west, and now and then from the west to the east. See **ASTRONOMY**.

**LIBYA**, in ancient geography, a large extent of Africa, lying south-west of Egypt.

**LICENCE**, in law, an authority given to a person to do some lawful act.

**LICENTIATE**, one who has obtained the degree of a licence.

The greatest number of the officers of justice in Spain, are distinguished by no other title but that of licentiate. In order to pass licentiate in common law, civil law, and physic, they must have studied seven years; and in divinity, ten. Among us, a licentiate usually means a physician who has a licence to practise, granted by the college of physicians.

**LICHEN**, **LIVER-WORT**, in botany, a genus of the cryptogamia algæ class. The receptacle is roundish, plain, and shining; and the farina is dispersed upon the leaves. There are 85 species, all natives of Britain.

**LICTORS**, in Roman antiquity, the serjeants or bea- dles who carried the fasces before the supreme magistrates: it was also a part of their office to be the public executioners in beheading, scourging, &c.

**LIDDESDALE**, a county of Scotland, bounded by Tiviotdale, on the north; Cumberland, on the south-east; and Annandale, on the south-west.

**LIEGE**, in law, a term sometimes used for liege lord, or one who owns no superior.

**LIEGE ROUSTIE**, in Scots law, is opposed to death bed; and signifies a person's enjoying that state of health, in which only he can dispose of his property at pleasure. See law, Tit. xxvii. 28.

**LIEGE**, in geography, the capital of the bishopric of the same name in Germany, situated on the river Maes, twelves miles south of Maestricht; E. long. 5° 36', N. lat. 50° 40'.

**LIENTERY**, is a flux of the belly, in which, whatever



is taken in is discharged by stool as it is swallowed, or very little altered either in colour or substance. See **MEDICINE**.

**LIEUTENANT**, an officer who supplies the place and discharges the office of a superior in his absence. Of these, some are civil, as the lords-lieutenants of kingdoms, and the lord-lieutenants of counties; and others are military, as the lieutenant general, lieutenant-general of the artillery, lieutenant colonel, lieutenant of the artillery of the tower, lieutenants of horse, foot, ships of war, &c.

*Lord* **LIEUTENANT of Ireland**, is properly a viceroy, and has all the state and grandeur of a king of England, except being served upon the knee. He has the power of making war and peace, of bestowing all the offices under the government, of dubbing knights, and of pardoning all crimes except high treason; he also calls and prorogues the parliament, but no bill can pass without the royal assent. He is assisted in his government by a privy-council; and, on his leaving the kingdom, he appoints the lords of the regency, who govern in his absence.

*Lords* **LIEUTENANTS of counties**, are officers, who, upon any invasion or rebellion, have power to raise the militia, and to give commissions to colonels and other officers, to arm and form them into regiments, troops and companies. Under the lords lieutenants, are deputy-lieutenants, who have the same power; these are chosen by the lords-lieutenants out of the principal gentlemen of each county, and presented to the king for his approbation.

**LIEUTENANT-GENERAL**, is an officer next in rank to the general: in battle, he commands one of the wings; in a march, a detachment, or a flying camp; also a quarter, at a siege, or one of the attacks, when it is his day of duty.

**LIFE**, is peculiarly used to denote the animated state of living creatures, or the time that the union of their soul and body lasts.

**LIFERENT**, in Scots law. When the use or enjoyment of a subject is given to a person during his life, it is said to belong to him in liferent. See **LAW**, Tit. xvi. 21.

**LIGAMENT**, in anatomy, a strong compact substance, serving to join two bones together. See **ANATOMY**.

**LIGATURE**, in surgery, is a chord, band, or string; or the binding any part of the body with a chord, band, fillet, &c. whether of leather, linnen, &c.

Ligatures are used to extend and replace bones that are broken or dislocated; to tie the patients down in lithotomy and amputations; to tie upon the veins in phlebotomy, or the arteries in amputations, or in large wounds; to secure the splints that are applied to fractures; to tie up the processes of the peritonæum, with the spermatic vessels in castration; and, lastly, in taking off warts or other excrescences by ligature.

**LIGHT**, in physiology, certain subtle particles of matter, capable of exciting in us the sensation of colours. See **OPTICS**.

**LIGHTENING**, the bursting of fire from a cloud or the earth. See **ELECTRICITY**.

**LIGHTER**, in naval architecture, a large kind of boat used in the river of Thames for carrying heavy goods, as coals, timber, &c.

**LIGNICENSIS terra**, in the materia medica, the name of a fine yellow hole, dug in many parts of Germany, particularly about Emeric in the circle of Westphalia, and used in cordial and astringent compositions.

**LIGULATED**, among botanists, an appellation given to such stamules as have a straight end turned downwards, with three indentures, but not divided into segments.

**LIGUSTICUM**, **LOVAGE**, in botany, a genus of the pentandria digynia class. The fruit is oblong, with five furrows on each side. There are six species, two of them natives of Britain, viz. the scotticum, or Scottish sea-parsley; and the cornubiense, or Cornwall saxifrage.

**LIGUSTRUM**, **PRIVET**, in botany, a genus of trees belonging to the diandria monogynia class. The corolla consists of four segments; and the berry has four seeds. There is but one species, viz. the vulgare or privet, a native of Britain.

**LILIADEOUS**, an appellation given to such flowers as resemble that of the lily.

**LILIUM**, in botany, a genus of the hexandria monogynia class. The corolla is bell-shaped, and consists of six petals, with a longitudinal nectariferous line; and the valves of the capsule are connected with a lattice-work of hair. There are nine species, none of them natives of Britain. The root of the white lily is reckoned emollient and suppurative.

**LIMA**, a province of Peru, in South America; the capital of which, called also Lima, was almost entirely destroyed by an earthquake in 1746: W. long. 76°, and S. lat. 12° 30'.

**LIMAX**, in zoology, a genus of insects belonging to the order of vermes mollusca; the characters of which are these: The body is oblong, fitted for crawling, with a kind of muscular coat on the upper part; and the belly is plain: they have a roundish hole in the side, near the neck, which serves the purposes of genitals, and for voiding their excrements: they have likewise four tentacula or horns, situate above the mouth, which they extend or retract at pleasure. There are eight species, distinguished entirely by their colour, as the black snail; the white snail; the reddish snail; the ash-coloured snail; &c. Snails are said to be hermaphrodites, and mutually impregnate each other.

**LIMB**, in a general sense, denotes the border or edge of a thing: thus, we say, the limb of a quadrant, of the sun, of a leaf, &c.

**LIMB**, in anatomy, an appellation given to the extremities of the body, as the arms and legs.

**LIMB**, *limbus*, in the church of Rome, is used in two different senses. 1. The limb of the patriarchs is said to be the place where the patriarchs waited the redemption of mankind: in this place, they suppose our Saviour's soul continued from the time of his death to his resurrection. 2. The limb of infants, dying without baptism; a place supposed to be distinct both from heaven and hell; since, say they, children dying innocent of any actual sin do not deserve hell, and by reason of their original sin cannot be admitted into heaven.

**LIMBURG**,

**LIMBURG**, the capital of a dutchy of the same name, in the Austrian Netherlands, twenty miles south-east of Liege: E. long.  $6^{\circ} 5'$ , and N. lat.  $50^{\circ} 37'$ .

**LIME**. See **CHEMISTRY**, p. 76.

**LIMERIC**, the capital of a county of the same name in Ireland, situated on the river Shannon, fifty two miles north of Cork: W. long.  $8^{\circ} 30'$ , N. lat.  $52^{\circ} 35'$ .

**LIMINGTON**, or **LEMINGTON**, a borough-town of Hampshire, twelve miles south-west of Southampton. It sends two members to parliament.

**LIMIT**, in a restrained sense, is used by mathematicians for a determinate quantity to which a variable one continually approaches; in which sense, the circle may be said to be the limit of its circumscribed and inscribed polygons. In algebra, the term limits is applied to two quantities, one of which is greater, and the other less, than another quantity and in this sense it is used, in speaking of the limits of equations, whereby their solution is much facilitated. See **ALGEBRA**.

**LIMNING**, the art of painting in water-colours, in contradistinction to painting, which is done in oil-colours. See **PAINTING**.

Limning is by far more ancient than painting in oil; this last being first invented by John Van Eyck, a Flemish painter, in 1410.

In limning, all colours are proper enough, except the white, made of lime, which is only used in fresco. The azure and ultramarine must always be mixt with size or gum: but there are always applied two lays of hot size, before the size colours are laid on: the colours are all ground in water, each by itself, and, as they are required in working, are diluted with size water.

When the piece is finished, they go over it with the white of an egg, well beaten; and then with varnish, if required.

To limn or draw a face in colours: having all the materials in readiness, lay the prepared colour on the card even and thin, free from hairs and spots, over the place where the picture is to be. The ground being laid, and the party placed in a due position, begin the work; which is to be done at three sittings. At the first, you are only to dead-colour the face, which will require about two hours. At the second sitting, go over the work more curiously, adding its particular graces or deformities. At the third sitting, finish the whole; carefully remarking whatever may conduce to render the piece perfect, as the cast of the eyes, moles, scars, gestures, and the like.

**LIMODORUM**, in botany, a genus of the gynandria diandria class. The nectarium consists of one concave, pedicellated leaf, situate with the undermost petal. There is but one species, a native of North America.

**LIMON**. See **CITRUS**.

**LIMOSELLA**, in botany, a genus of the didynamia angiospermia class. The calix consists of five segments, and the corolla of five equal divisions; the stamina are approximate in pairs; and the capsule has one cell and two valves, containing many seeds.

**LIMPET**. See **PATELLA**.

**LINARIA**, in ornithology. See **FRINGILLA**.

**LINCOLN**, the capital city of the county of Lincoln:

W. long.  $27'$ , N. lat.  $53^{\circ} 16'$ . It sends two members to parliament.

**LINE**, in geometry, a quantity extended in length only, without any breadth or thickness. It is formed by the flux or motion of a point. See **FLUXIONS**, and **GEOMETRY**.

**LINE**, in the art of war, is understood of the disposition of an army, ranged in order of battle, with the front extended as far as may be, that it may not be flanked.

**LINE of battle**, is also understood of the disposition of a fleet on the day of the engagement, on which occasion the vessels are usually drawn up as much as possible in a straight line, as well to gain and keep the advantage of the wind, as to run the same board.

**Ship of the LINE**, a vessel large enough to be drawn up in the line, and to have a place in a sea-fight.

**LINE**, in genealogy, a series or succession of relations in various degrees, all descending from the same common father.

**LINE** also denotes a French measure, containing the twelfth part of an inch, or the hundred and forty-fourth part of a foot. Geometricians conceive the line subdivided into six points. The French line answers to the English barley corn.

**LINEs**, in heraldry, the figures used in armories, to divide the shield into different parts, and to compose different figures. These lines, according to their different forms and names, give denomination to the pieces or figures which they form, except the straight or plain lines.

**LINEA ALBA**, in anatomy. See **ANATOMY**, p. 192.

**LINEAMENT**, among painters, is used for the out-lines of a face.

**LINEAR NUMBERS**, in mathematics, such as have relation to length only; such is a number which represents one side of a plane figure. If the plane figure be a square, the linear number is called a root.

**LINEAR PROBLEM**, that which may be solved geometrically by the intersection of two right lines. This is called a simple problem, and is capable but of one solution.

**LINEN**. See **LINEN**.

**LING**, in ichthyology. See **GADUS**.

**LINGEN**, a town of Germany, in the circle of Westphalia, capital of a county of the same name, situated on the river Ems, forty five miles north of Munster.

**LINGUATULA**, in ichthyology. See **PLEURONECTES**.

**LINIMENT**, in pharmacy, a composition of a consistence somewhat thinner than an unguent, and thicker than an oil, used for anointing different parts of the body in various intentions.

The materials proper for composing of a liniment, are oils, fats, balsams, and whatever enters the composition of unguents and plasters.

**LINLITHGOW**, a town of Scotland, in the county of Lothian, capital of the county of Linlithgow, situated sixteen miles west of Edinburgh.

**LINNÆA**, in botany, a genus of the didynamia angiospermia class. The calix is double; the corolla is bell-shaped; and the berry is dry, and contains two seeds.

feeds. There is but one species, a native of Sweden. LINNEN, in commerce, a well-known kind of cloth, chiefly made of flax. See FLAX.

In order to succeed in the linnen-manufacture, one set of people should be confined to the plowing and preparing the soil, sowing and covering the seed, to the weeding, pulling, rippling, taking care of the new seed, and watering and grassing the flax, till it is lodged at home: others should be concerned in the drying, breaking, scutching, and heckling the flax, to fit it for the spinners; and others in spinning and reeling it, to fit it for the weaver; others should be concerned in taking due care of the weaving, bleaching, beetling, and finishing the cloth for the market. It is reasonable to believe, that if these several branches of the manufacture were carried on by distinct dealers in Scotland and Ireland, where our home-made linnens are manufactured, the several parts would be better executed, and the whole would be afforded cheaper, and with greater profit.

LINNET, in ornithology. See FRINGILLA.

LINSEED, the seed of the plant *linum*. Linseed bruised and steeped in water, gives it very soon a thick mucilaginous nature, and communicates much of its emollient virtues to it.

LINT. See LINNEN and FLAX.

LINTEL, in architecture, a piece of stone or timber that lies horizontally over door-posts and window-jambes, as well to bear the thickness of the wall over it, as to bind the sides of the wall together.

LINTON, a market-town of Cambridgeshire, situated ten miles south-east of Cambridge.

LINTS, or LINTZ, a beautiful city, capital of Upper Austria, with a strong citadel.

LINUM, FLAX, in botany, a genus of the pentandria pentagynia class. The calix consists of five leaves, and the corolla of five petals; the capsule has five valves, and ten cells; and the seeds are solitary. There are 22 species, five of them natives of Britain, *viz.* the *usitatissimum*, or common flax; the *perenne*, or blue flax; the *tenuifolium*, or narrow-leaved wild flax; the *catharticum*, or purging flax; and the *radiola*, least rupture-wort, or all-feed. See FLAX.

LION, in zoology. See FELIS.

LIONCELLES, in heraldry, a term used for several lions borne in the same coat of arms.

LIP, in anatomy. See ANATOMY, p. 305.

*Hare-LIP*, a disorder, in which the upper lip is in a manner slit or divided, so as to resemble the upper lip of a hare, whence the name. See SURGERY.

LIPOTHYMIA, FAINTING, in medicine, may arise from several causes, as too violent exercises, suppression of the menses or other accustomed evacuations, &c. See MEDICINE.

LIPPIA, in botany, a genus of the didynamia angiospermia class. The calix consists of four roundish, erect, and membranaceous teeth; the capsule is straight, has two valves, one cell, and two seeds. There are two species, none of them natives of Britain.

LIQUIDAMBER, in botany, a genus of the monœcia polyandria class. The calix has four leaves; it has

no corolla, but numerous filaments: the calix of the male consists of four leaves in the form of a globe; it has no corolla, but a couple of styli; and the capsules, which are numerous, are round, with a double valve, and contains many seeds. There are two species, both natives of America. This tree yields a fragrant resin, called liquidamber, which resolves and opens obstructions.

LIQUOR, a name signifying any fluid substance.

LIQUORICE. See GLYCYRRHIZA.

LIRIODENDRUM, the TULIP-TREE, in botany, a genus of the polyandria polygynia class. The calix consists of three leaves, and the corolla of nine petals; and the seeds are imbricated upon a strobilus. There are two species, none of them natives of Britain.

LISBON, the capital of Portugal, situated on the north bank of the Tagus, about ten miles from its mouth, and eighty miles west of the frontiers of Spain: W. long.  $9^{\circ} 25'$ , N. lat.  $38^{\circ} 25'$ . It is about six miles long, winding with the river, from whence it rises with an easy ascent, and is computed to contain about 30,000 houses, 200,000 inhabitants, forty parish-churches, and forty convents of both sexes.

LISIEUX, a large city and bishop's see of France, in the province of Normandy: E. long.  $16'$ , and N. lat.  $40^{\circ} 14'$ .

LISLE, or RYSSEL, a large and populous city, the capital of French Flanders, situated on the river Deule, twelve miles west of Tournay: E. long.  $3^{\circ}$ , and N. lat.  $50^{\circ} 42'$ .

LIST, in commerce, the bordure of cloth, or of stuff; serving not only to shew their quality, but to preserve them from being torn in the operations of fulling, dying, &c.

List is used on various occasions; but chiefly by gardeners for securing their wall-trees.

LITANY, a solemn form of supplication to God, in which the priest utters some things fit to be prayed for, and the people join in their intercession, saying, *We beseech thee to hear us, good Lord, &c.*

LITCHFIELD, a city of Staffordshire, one hundred miles north-west of London, and twelve south-east of Stafford. This city and Coventry have one bishop between them; it sends two members to parliament.

LITERATI, in general, denotes men of learning; but is more particularly used by the Chinese for such persons as are able to read and write their language.

LITHANTHRAX, PIT-COAL, in natural history, a genus of fossils, defined to be solid, dry, opaque, inflammable substances, found in large strata, splitting horizontally more easily than in any other direction, of a glossy hue, soft and friable, not fusible, but easily inflammable, and leaving a large residuum of ashes.

Of this genus there are three species: 1. The hard, dusky, black coal, known by the name of Scotch coal. 2. The hard, glossy, black coal, known by the same name. 3. The friable, glossy, black coal, called Newcastle coal, as being chiefly dug about that town.

LITHARGE, is properly a recement of lead, or lead vitrified, either alone, or with a mixture of copper. See CHEMISTRY, p. 84.

LITHIDIA,

**LITHIDIA**, in natural history, the name of a large class of fossils, including the flint and pebble kinds.

The lithidia are defined to be stones of a debased crystalline matter, covered by, and surrounded with, an opaque crust, and frequently of great beauty, and considerable brightness within, though of but a slight degree of transparency, approaching to the nature of the semi pellucid gems, and like them found in not very large masses.

**LITHOGINFSIA**, a term used by some authors for the formation of stones. See **STONE**.

**LITHOMARGA**, *Ston-marle*, a name given by some authors to a sparry substance highly debased by earth, which is found in great plenty in the caves of the Hart's forest in Germany, and used there.

**LITHONTRIPTICS**, medicines which either break, or are supposed to have the virtue of breaking, stones in the urinary passages. See **MEDICINE**.

**LITHOPHYTA**, the name of Linnæus's third order of vermes. See **NATURAL-HISTORY**.

**LITHOSPERMUM**, **GROMWELL**, in botany, a genus of the pentandria monogynia class. The corolla is funnel-shaped, with a naked perforated faux; and the calix consists of five segments. There are six species, three of them natives of Britain; viz. the officinale, or gromwell; the purpureo-cæruleum, or lesser creeping gromwell; and the arvense, or bastard alkanet. The seeds of the officinale are accounted diuretic.

**LITHOSTROTION**, in natural history, a name of a species of fossil coral, composed of a great number of long and slender columns, sometimes round, sometimes angular, joined nicely to one another, and of a starry or radiated surface at their tops. These are found in considerable quantities in the northern and western parts of this kingdom, sometimes in single, sometimes in complex specimens.

**LITHOTOMY**, in surgery, cutting for the stone. See **SURGERY**.

**LITHOZUGIA**, in natural history, a genus of fossils, composed of a simple stony matter, making a kind of cement, and holding firmly together small pebbles &c. embodied in it.

**LITHUANIA**, a province of Poland, bounded by Samogitia, Livonia, and part of Russia, on the north; by another part of Russia, on the east; by Volhinia and Polesia, on the south; and by Prussia and Polachia, on the west.

**LITISCONTESTATION**, in Scots law. See **LAW**, Tit. xxx. 33.

**LITURGY**, a name given to those set forms of prayer which have been generally used in the Christian church. Of these there are not a few ascribed to the apostles and fathers, but they are almost universally allowed to be spurious.

**LITUUS**, in Roman antiquity, a short straight rod, only bending a little at one end, used by the augurs. See **AUGUR**.

**LIVADIA**, the capital of a province of European Turkey, the ancient Achaia, situated on the north side of the gulph of Lepanto: E. long. 23° 15', N. lat. 27° 30'.

**LIVER**, in anatomy. See **ANATOMY**, p. 264.

**LIVER-WORT**, in botany. See **LICHEN**.

**LIVERPOOL**, or **LEVERPOOL**, a port town of Lancashire, fifteen miles north of Chester, which sends two members to parliament.

**LIVERYMEN** of London are a number of men chosen from among the freemen of each company. Out of this body the common council, sheriff, and other superior officers for the government of the city are elected, and they alone have the privilege of giving their votes for members of parliament; from which the rest of the citizens are excluded.

**LIVONIA**, a province of Russia, 160 miles long, and 120 broaded; bounded by the gulph of Finland, on the north; by Ingria and great Novogorod, on the east; by Lithuania and Courland, on the south; and by the Baltic, on the west: its chief towns are Narva, Revel, and Riga.

**LIVONICA TERRA**, a kind of fine bole used in the shops of Germany and Italy. These earths are both dug out of the same pit, in the place from whence they have their name, and in some other parts of the world. They are generally brought to us made up into little cakes, and sealed with the impresson of a church and an escutcheon with two cross keys. In Spain and Portugal they are much used, sometimes singly, sometimes mixed together, and are good in fevers and in fluxes of all kinds.

**LIVRE**, a French money of account, containing twenty sols.

**LIXIVIOUS**, an appellation given to salts obtained from burnt vegetables by lotion.

**LIXIVIUM**, in pharmacy, &c. a ley, obtained by pouring some liquor upon the ashes of plants; which is more or less powerful, as it has imbibed the fixed salts contained in the ashes.

**LIZZARD**, in zoology. See **LACERTA**.

**LIZZARD**, in geography, a cape, or promontory of Cornwall, fifteen miles south of Falmouth: W. long. 5° 47', N. lat. 49° 50'.

**LOACH**, in ichthyology. See **COBITIS**.

**LOADSTONE**. See **MAGNET**.

**LOAMS**, in natural history, are defined to be earths composed of dissimilar particles, hard, stiff, dense, and hard and rough to the touch; not easily ductile while moist, readily diffusible in water, and composed of sand and a tough viscid clay. Of these loams, some are whitish, and others brown or yellow.

**LOBE**, in anatomy, any fleshy protuberant part, as the lobes of the lungs, lobes of the ears, &c.

**LOBELIA**, in botany, a genus of the syngenesia monogynia class. The calix consists of five segments, and the corolla of one irregular petal; and the capsule has two and sometimes three cells. There are 26 species, only one of them a native of Britain, viz. the dortinnanna, or water gladiale.

**LOCAL**, in law, something fixed to the freehold, or tied to a certain place: thus real actions are local, since they must be brought in the country where they lie: and local customs are those peculiar to certain countries and places.

**LOCAL MEDICINES**, those destined to act upon particular parts; such are fomentations, epithems, velicatories, &c.

**Decree of LOCALITY**, in Scots law, a decree proportioning a minister's stipend among the different persons liable in payment of it. See **LAW**, Tit. v. 13.

**LOCATELLUS's BALSAM**, in pharmacy, a celebrated balsam, the preparation whereof is directed in the Edinburgh dispensatory thus: Take of yellow-wax, one pound; oil olive, a pint and a half; Venice turpentine, a pound and a half; balsam of Peru, two ounces; dragon's blood, one ounce: melt the wax in the oil over a gentle fire; then add the turpentine; and having taken them from the fire, mix in the balsam of Peru and dragon's blood, keeping them continually stirring till grown cold.

This balsam is used in internal bruises and hæmorrhages, erosions of the intestines, ulcerations of the lungs, dysenteries, and in some coughs and asthmas.

**LOCHIA**, in medicine, a flux from the uterus, consequent to delivery. See **MIDWIFERY**.

**LOCHMABEN**, a town of Scotland, fifteen miles east of Dumfries.

**LOCK**, a well-known instrument used for fastening doors, chests, &c. generally opened by a key.

**LOCKMAN**, an officer in the isle of Man, who executes the orders of the government, much like our under sheriff.

**LOCRIDA**, a town of Turkey in Europe, seventy miles south-east of Durazzo: E. long.  $21^{\circ}$ , N. lat.  $41$ .

**LOCUS GEOMETRICUS**, denotes a line, by which a local or indeterminate problem is solved.

A locus is a line, any point of which may equally solve an indeterminate problem. Thus, if a right line suffice for the construction of the equation, it is called *locus ad rectum*; if a circle, *locus ad circumulum*; if a parabola, *locus ad parabolam*; if an ellipsis, *locus ad ellipsin*; and so of the rest of the conic sections.

**LOCULAMENT**, among botanists, denotes a cell, or partition, in a seed pod, for the seed of a plant.

**LOCUST**, in zoology. See **GRYLLUS**.

**LODGMENT**, in military affairs, is a work raised with earth, gabions, fascines, wool-packs, or mantelets, to cover the besiegers from the enemies fire, and to prevent their losing a place which they have gained, and are resolved, if possible, to keep.

**LOEFLINGIA**, in botany, a genus of the triandria monogynia class. The calix consists of five leaves, and the corolla of five small petals; and the capsule has one cell, and three valves. There is but one species, a native of Spain.

**LOESLIA**, in botany, a genus of the didynamia angiospermia class. The calix consists of four segments; and the capsule has three cells. There is but one species, a native of America.

**LOG**, in naval affairs, is a flat piece of wood, shaped somewhat like a flounder, with a piece of lead fastened to its bottom, which makes it stand or swim upright in the water. See **PLATE CIII**, fig. 4.

**LOGARITHMIC CURVE**. If on the line AN (**PLATE CIII**, fig. 5.) both ways indefinitely extended, be ta-

ken, AC, CE, EG, GI, IL, on the right hand; and also Ag, gP, &c. on the left, all equal to one another: and if at the points Pg, A, C, E, G, I, L, be erected to the right line AN, the perpendiculars PS, gd, AB, CD, EF, GH, IK, LM, which let be continually proportional, and represent numbers, viz. A B, 1; C D, 10; E F, 100, &c. then shall we have two progressions of lines, arithmetical and geometrical: for the lines AC, AE, AG, &c. are in arithmetical progression, or as 1, 2, 3, 4, 5, &c. and so represent the logarithms to which the geometrical lines AB, CD, EF, &c. do correspond. For since AG is triple of the first line AC, the number GH shall be in the third place from unity, if CD be in the first: so likewise shall LM be in the fifth place, since AL = 5 AC. If the extremities of the proportionals S, d, B, D, F, &c. be joined by right lines, the figures SBML will become a polygon, consisting of more or less sides, according as there are more or less terms in the progression.

If the parts AC, CE, EG, &c. be bisected in the points, c, e, g, i, l, and there be again raised the perpendiculars cd, ef, gb, ik, lm, which are mean proportionals between AB, CD; CD, EF, &c. then there will arise a new series of proportionals, whose terms, beginning from that which immediately follows unity, are double of those in the first series, and the difference of the terms is become less, and approach nearer to a ratio of equality than before. Likewise, in this new series, the right lines AL, Ae, express the distances of the terms LM, cd, from unity, viz. since AL is ten times greater than Ae, LM shall be the tenth term of the series from unity; and because Ae is three times greater than Ac, ef will be the third term of the series if cd be the first, and there shall be two mean proportionals between AB and ef, and between AB and LM there will be nine mean proportionals. And if the extremities of the lines Bd, Df, Fb, &c. be joined by right lines, there will be a new polygon made, consisting of more but shorter sides than the last.

If, in this manner, mean proportionals be continually placed between every two terms, the number of terms at last will be made so great, as also the number of the sides of the polygon, as to be greater than any given number, or to be infinite; and every side of the polygon so lessened, as to become less than any given right line; and consequently the polygon will be changed into a curve-lined figure; for any curve lined figure may be conceived as a polygon, whose sides are infinitely small and infinite in number. A curve described after this manner, is called logarithmical.

It is manifest from this description of the logarithmic curve, that all numbers at equal distances are continually proportional. It is also plain, that if there be four numbers, AB, CD, IK, LM, such that the distance between the first and second be equal to the distance between the third and the fourth, let the distance from the second to the third be what it will, these numbers will be proportional. For because the distances AC, IL, are equal, AB shall be to the increment Dc, as IK is to the increment MT. Wherefore,

fore, by composition,  $AB : DC :: IK : ML$ . And, contrariwise, if four numbers be proportional, the distance between the first and second shall be equal to the distance between the third and fourth.

The distance between any two numbers, is called the logarithm of the ratio of those numbers; and, indeed, doth not measure the ratio itself, but the number of terms in a given series of geometrical proportionals, proceeding from one number to another, and defines the number of equal ratios by the composition whereof the ratio of numbers is known

**LOGARITHMS**, are the indexes or exponents (mostly whole numbers and decimal fractions, consisting of seven places of figures at least) of the powers or roots (chiefly broken) of a given number; yet such indexes or exponents, that the several powers or roots they express, are the natural numbers, 1, 2, 3, 4, 5, &c. to 10 or 100000, &c. (as, if the given number be 10, and its index be assumed 1 0000000, then the 0.0000000 root of 10, which is 1, will be the logarithm of 1; the 0.301036 root of 10, which is 2, will be the logarithm of 2; the 0.477121 root of 10, which is 3, will be the logarithm of 3; the 1.612060 root of 10, the logarithm of 4; the 1.041393 power of 10 the logarithm of 11; the 1.079181 power of 10 the logarithm of 12, &c.) being chiefly contrived for ease and expedition in performing of arithmetical operations in large numbers, and in trigonometrical calculations; but they have likewise been found of extensive service in the higher geometry, particularly in the method of fluxions. They are generally founded on this consideration, that if there be any row of geometrical proportional numbers, as 1, 2, 4, 8, 16, 32, 64, 128, 256, &c. or 1, 10, 100, 1000, 10000, &c. and as many arithmetical progression numbers adapted to them, or set over them, beginning with 0,

thus,  $\left\{ \begin{array}{l} 0, 1, 2, 3, 4, 5, 6, 7, \text{ \&c.} \\ 1, 2, 4, 8, 16, 32, 64, 128, \text{ \&c.} \end{array} \right\}$   
 or,  $\left\{ \begin{array}{l} 0, 1, 2, 3, 4, \text{ \&c.} \\ 1, 10, 100, 1000, 10000, \text{ \&c.} \end{array} \right\}$

then will the sum of any two of these arithmetical progressionals, added together, be that arithmetical progression which answers to or stands over the geometrical progression, which is the product of the two geometrical progressionals over which the two assumed arithmetical progressionals stand: again, if those arithmetical progressionals be subtracted from each other, the remainder will be the arithmetical progression standing over that geometrical progression which is the quotient of the division of the two geometrical progressionals belonging to the two first assumed arithmetical progressionals; and the double, triple, &c. of any one of the arithmetical progressionals, will be the arithmetical progression standing over the square, cube, &c. of that geometrical progression which the assumed arithmetical progression stands over, as well as the  $\frac{2}{3}$ ,  $\frac{1}{4}$ , &c. of that arithmetical progression will be the geometrical progression answering to the square root, cube root, &c. of the arithmetical progression over it; and from hence arises the following common, though lame and imperfect definition of logarithms; viz.

“That they are so many arithmetical progressionals, answering to the same number of geometrical ones.” Whereas, if any one looks into the tables of logarithms, he will find, that these do not all run on in an arithmetical progression, nor the numbers they answer to in a geometrical one; these last being themselves arithmetical progressionals. Dr Wallis, in his history of algebra, calls logarithms the indexes of the ratios of numbers to one another. Dr Halley, in the philosophical transactions, n<sup>o</sup> 216, says, they are the exponents of the ratios of unity to numbers. So also Mr Cotes, in his Harmonia Mensurarum, says, they are the numerical measures of ratios. But all these definitions convey but a very confused notion of logarithms. Mr Maclaurin, in his Treatise of Fluxions, has explained the natural and genesis of logarithms agreeably to the notion of their first inventor lord Naper. Logarithms then, and the quantities to which they correspond, may be supposed to be generated by the motion of a point; and if this point moves over equal spaces in equal times, the line described by it increases equally

Again a line decreases proportionably, when the point that moves over it describes such parts in equal times as are always in the same constant ratio to the lines from which they are subducted, or to the distances of that point, at the beginning of those lines, from a given term in that line. In like manner, a line may increase proportionably, if in equal times the moving point describes spaces proportional to its distances from a certain term at the beginning of each time. Thus, in the first case, let  $ac$  (Plate CIV. fig. 3.) be to  $ao$ ,  $cd$  to  $co$ ,  $de$  to  $do$ ,  $ef$  to  $eo$ ,  $fg$  to  $fo$ , always in the same ratio of  $QR$  to  $QS$ ; and suppose the point  $P$  sets out from  $a$ , describing  $ac$ ,  $cd$ ,  $de$ ,  $ef$ ,  $fg$ , in equal parts of the time; and let the space described by  $P$  in any given time be always in the same ratio to the distance of  $P$  from  $o$  at the beginning of that time; then will the right line  $ao$  decrease proportionably.

In like manner, the line  $oa$ , (*ibid.* n<sup>o</sup> 3.) increases proportionably, if the point  $p$ , in equal times, describes the spaces  $ac$ ,  $cd$ ,  $de$ ,  $fg$ , &c. so that  $ac$  is to  $ao$ ,  $cd$  to  $co$ ,  $de$  to  $do$ , &c. in a constant ratio. If we now suppose a point  $P$  describing the line  $AG$  (*ibid.* n<sup>o</sup> 4.) with an uniform motion, while the point  $p$  describes a line increasing or decreasing proportionably, the line  $AP$ , described by  $P$ , with this uniform motion, in the same time that  $oa$ , by increasing or decreasing proportionally, becomes equal to  $op$ . is the logarithm of  $op$ . Thus  $AC$ ,  $AD$ ,  $AE$ , &c. are the logarithms of  $oc$ ,  $od$ ,  $oe$ , &c. respectively; and  $oa$  is the quantity whose logarithm is supposed equal to nothing.

We have here abstracted from numbers, that the doctrine may be the more general; but it is plain, that if  $AC$ ,  $AD$ ,  $AE$ , &c. be supposed, 1, 2, 3, &c. in an arithmetic progression;  $oc$ ,  $od$ ,  $oe$ , &c. will be in geometric progression and that the logarithm of  $oa$ , which may be taken for unity, is nothing.

Lord Naper, in his first scheme of logarithms, supposes, that while  $op$  increases or decreases proportionally, the uniform motion of the point  $P$ , by which the logarithm of  $op$  is generated, is equal to the velocity of  $p$  at  $a$ ; that is, at the term of time when the logarithms begin to be generated.



But since the way above hinted at, for finding the logarithms of the prime numbers is so intolerably laborious and troublesome, the more skilful mathematicians that came after the first inventors, employing their thoughts about abbreviating this method, had a vastly more easy and short way offered to them from the contemplation and mensuration of hyperbolic spaces contained between the portions of an asymptote, right lines perpendicular to it, and the curve of the hyperbola: for if ECN (Plate CIII. fig. 6. n° 1.) be an hyperbola, and AD, AQ the asymptotes, and AB, AP, AQ, &c. taken upon one of them, be represented by numbers, and the ordinates BC, PM, QN, &c. be drawn from the several points B, P, Q, &c. to the curve, then will the quadrilinear spaces BCMP, PMNQ, &c. viz. their numerical measures be the logarithms of the quotients of the division of AB by AP, AP by AQ, &c. since when AB, AP, AQ, &c. are continual proportionals, the said spaces are equal, as is demonstrated by several writers concerning conic sections. **SE HYPERBOLA.**

Having said that these hyperbolic spaces, numerically expressed, may be taken for logarithms, we shall next give a specimen, from the great Sir Isaac Newton, of the method how to measure these spaces, and consequently of the construction of logarithms.

Let CA (*ibid.* n° 2.) = AF be = 1, and AB = Ab = x; then will  $\frac{1}{1+x}$  be = BD, and  $\frac{1}{1-x}$  = bd; and putting these expressions into serieses, it will be  $\frac{1}{1+x} = 1 - x + x^2 - x^3 + x^4 - x^5, &c.$  and  $\frac{1}{1-x} = 1 + x + x^2 + x^3 + x^4 + x^5, &c.$

and  $\frac{x}{1+x} = x - xx + x^2x - x^3x + x^4x - x^5x, &c.$  and  $\frac{x}{1-x} = x + xx + x^2x + x^3x + x^4x + x^5x, &c.$  and taking the fluents, we shall have the area AFDB =  $x - \frac{xx}{2} + \frac{x^3}{3} - \frac{x^4}{4} + \frac{x^5}{5}, &c.$  and the area AFdb, =  $x + \frac{xx}{2} + \frac{x^3}{3} + \frac{x^4}{4} + \frac{x^5}{5}, &c.$  and the sum bdDB =  $2x + \frac{2x^2}{3} + \frac{2}{3}x^3 + \frac{2}{3}x^4 + \frac{2}{3}x^5, &c.$

Now if AB or ab be  $\frac{1}{10} = x$ , Cb being = 0.9, and CB = 1.1, by putting this value of x in the equations above, we shall have the area bdDB = 0.2006706954621511 for the terms of the series will stand as you see in this table,

0.2000000000000000	= first	} Term of the series.
6666666666666666	= second	
4000000000000000	= third	
285714286	= fourth	
2222222	= fifth	
18182	= sixth	
154	= seventh	
1	= eighth	

0.2006706954621511

If the parts Ad and AD of this area be added separately, and the lesser DA be taken from the greater dA, we shall have Ad - AD =  $x^2 + \frac{x^4}{2} + \frac{x^6}{3} + \frac{x^8}{4}, &c. =$

= 0.0100503358535014, for the terms reduced to decimals will stand thus:

0.0100000000000000	= first	} Term of the series.
5000000000000000	= second	
3333333333	= third	
25000000	= fourth	
200000	= fifth	
1667	= sixth	
14	= seventh	

0.0100503358535014.

Now if this difference of the areas be added to, and subtracted from their sum before found, half the aggregate, viz. 0.1053605156578263 will be the greater area Ad, and half the remainder, viz. 0.0953101798043249, will be the lesser area AD.

By the same tables, these areas AD and Ad, will be obtained also when AB = Ab are supposed to be  $\frac{1}{100}$  or CB = 1.01, and Cb = 0.99, if the numbers are but duly transferred to lower places, as

0.0200000000000000	= first	} Term of the series.
6666666666	= second	
400000	= third	
28	= fourth	

Sum = 0.020006667066694 = area bD.

0.0001000000000000	= first	} Term of the series.
5000000	= second	
3333	= third	

0.0001000050003333 = area Ad - AD.

Half the aggregate 0.0100503358535014 = Ad, and half the remainder, viz. 0.0099503308531681 = AD.

And so putting AB = Ab =  $\frac{1}{1000}$ , or CB = 1.001 and Cb = 0.999, there will be obtained Ad = 0.00100050003335835, and AD = 0.00099950013330835.

After the same manner, if AB = Ab, be = 0.2, or 0.02, or 0.002, these areas will arise.

Ad = 0.2231435513142097, and  
AD = 0.1823215576939546, or  
Ad = 0.0202027073175194, and  
AD = 0.1098026272961797, or  
Ad = 0.002002, and AD = 0.001.

From these areas thus found, others may be easily had

from addition and subtraction only. For since  $\frac{1.2}{0.8} \times \frac{1.2}{0.9} = 2$ , the sum of the areas belonging to the ratios  $\frac{1.2}{0.8}$  and  $\frac{1.2}{0.9}$  (that is, insisting upon the parts of the absolute 1.2, 0.8; and 1.2, 0.9) viz.

0.405465, &c. and  $\begin{cases} AD = 0.18232, & \text{&c.} \\ Ad = 0.10536, & \text{&c.} \end{cases}$

Sum = 0.28768, &c.

added thus,  $\begin{cases} 0.40546, & \text{&c.} \\ 0.28768, & \text{&c.} \end{cases}$

Total = 0.69314, &c. = the area of AFHG, when



when CG is =2. Also, since  $\frac{1.2}{0.8} \times 2 = 3$ , the sum 1.0986122, &c. of the areas belonging to  $\frac{1.2}{0.8}$ , and 2, will be the area of AFGH, when CG=3. Again, since  $\frac{2 \times 2}{0.8} = 5$ , and  $2 \times 5 = 10$ ; by adding  $Ad = 0.2231$ , &c.  $AD = 0.1823$ , &c. and  $Ad = 0.1053$ , &c. together, their sum is 0.5108, &c. and this added to 1.0986, &c. the area of AFGH, when CG=3. You will have 1.6093379124341004 = AFGH, when CG is 5; and adding that of 2 to this, gives 2.3025850929940457 = AFGH, when CG is equal to 10: and since  $10 \times 10 = 100$ ; and  $10 \times 100 = 1000$ ; and  $\sqrt{5 \times 10 \times 0.98} = 7$ , and  $10 \times 1.1 = 11$ , and  $\frac{1000 \times 1.091}{7 \times 11} = 13$ , and  $\frac{1000 \times 0.998}{2} = 499$ ; it is plain that the area AFGH may be found by the composition of the areas found before, when CG=100, 1000, or any other of the numbers above mentioned; and all these areas are the hyperbolic logarithms of those several numbers.

Having thus obtained the hyperbolic logarithms of the numbers 10, 0.98, 0.99, 1.01, 1.02; if the logarithms of the four last of them be divided by the hyperbolic logarithm 2.302585, &c. of 10, and the index 2, be added; or, which is the same thing, if it be multiplied by its reciprocal 0.4342944819032518, the value of the subtangent of the logarithmic curve, to which Briggs's logarithms are adapted, we shall have the true tabular logarithms of 98, 99, 100, 101, 102. These are to be interpolated by ten intervals, and then we shall have the logarithms of all the numbers between 980 and 1020; and all between 980 and 1000, being again interpolated by ten intervals, the table will be as it were constructed. Then from these we are to get the logarithms of all the prime numbers, and their multiples less than 100, which may be done by

addition and subtraction only: for  $\sqrt[4]{84 \times 1020} = 2$ ;

$$\sqrt[4]{8 \times 9963} = 3; \frac{10}{2} = 5; \sqrt{\frac{98}{2}} = 7; \frac{99}{9} = 11; \frac{1001}{7 \times 11} = 13;$$

$$\frac{102}{6} = 17; \frac{988}{4 \times 13} = 19; \frac{9936}{16 \times 27} = 23; \frac{986}{2 \times 17} = 29; \frac{992}{32}$$

$$= 31; \frac{999}{27} = 37; \frac{984}{24} = 41; \frac{989}{23} = 43; \frac{987}{21} = 47;$$

$$\frac{9911}{11 \times 17} = 53; \frac{9971}{13 \times 13} = 59; \frac{9882}{2 \times 81} = 61; \frac{9949}{3 \times 49} = 67;$$

$$\frac{994}{14} = 71; \frac{9928}{8 \times 17} = 73; \frac{9954}{7 \times 18} = 79; \frac{996}{12} = 83; \frac{9968}{7 \times 16}$$

$$= 89; \frac{9894}{6 \times 17} = 97; \text{ and thus having the logarithms}$$

of all the numbers less than 100, you have nothing to do but interpolate the several times, through ten intervals.

Now the void places may be filled up by the following theorem. Let  $n$  be a number, whose logarithm is wanted; let  $x$  be the difference between that and the two nearest numbers, equally distant on each side, whose logarithms are already found; and let  $d$  be half the differ-

ence of their logarithms: then the required logarithm of the number  $n$ , will be had by adding  $d + \frac{dx}{2n} + \frac{dx^2}{12n^2}$ , &c. to the logarithm of the lesser number; for if the numbers are represented by  $Cp$ ,  $CG$ ,  $CP$ , (*ibid.* n<sup>o</sup> 2.) and the ordinates  $p$ ,  $PQ$ , be raised; if  $n$  be wrote for  $CG$ , and  $x$  for  $GP$ , or  $Gp$ , the area  $pQP$ , or  $\frac{2x}{n} + \frac{x^2}{2n^2}$

+  $\frac{x^3}{3n^2}$ , &c. will be to the area  $pHG$ , as the difference between the logarithms of the extreme numbers, or  $2d$ , is to the difference between the logarithms of the lesser, and of the middle one; which, therefore, will be

$$\frac{dx}{n} + \frac{dx^2}{2n} + \frac{dx^3}{3n^2}, \text{ \&c.} = d + \frac{dx}{2n} + \frac{dx^2}{12n^2}, \text{ \&c.}$$

$$\frac{x}{n} + \frac{x^2}{3n} + \frac{x^3}{5n^2}, \text{ \&c.}$$

The two first terms  $d + \frac{dx}{2n}$  of this series, being sufficient for the construction of a canon of logarithms, even to 14 places of figures, provided the number, whose logarithm is to be found, be less than 1000; which cannot be very troublesome, because  $x$  is either 1 or 2: yet it is not necessary to interpolate all the places by help of this rule, since the logarithms of numbers, which are produced by the multiplication or division of the number last found, may be obtained by the numbers whose logarithms were had before, by the addition or subtraction of their logarithms. Moreover, by the difference of their logarithms, and by their second and third differences, if necessary, the void places may be supplied more expeditiously; the rule afore-going being to be applied only where the continuation of some full places is wanted, in order to obtain these differences.

By the same method rules may be found for the interpolation of logarithms, when of three numbers the logarithm of the lesser and of the middle number are given, or of the middle number and the greater; and this although the numbers should not be in arithmetical progression. Also by pursuing the steps of this method, rules may be easily discovered for the construction of artificial sines and tangents, without the help of the natural tables. Thus far the great Newton, who says, in one of his letters to Mr Leibnitz, that he was so much delighted with the construction of logarithms, at his first setting out in those studies, that he was ashamed to tell to how many places of figures he had carried them at that time: and this was before the year 1666; because, he says, the plague made him lay aside those studies, and think of other things.

Dr. Keil, in his Treatise of Logarithms, at the end of his Commandine's Euclid, gives a series, by means of which may be found easily and expeditiously the logarithms of large numbers. Thus, let  $z$  be an odd number, whose logarithm is sought: then shall the numbers  $z-1$  and  $z+1$  be even, and accordingly their logarithms, and the difference of the logarithms will be had, which let be called  $y$ . Therefore, also the logarithm of a number, which is a geometrical mean between  $z-1$  and  $z+1$ , will

will be given, viz. equal to half the sum of the logarithms.

$$\text{Now the series } z \times \frac{1}{4z} + \frac{1}{24z^3} + \frac{181}{15120z^5} + \frac{25200z^7}{13}$$

&c. shall be equal to the logarithm of the ratio, which the geometrical mean between the numbers  $z-1$  and  $z+1$ , has to the arithmetical mean, viz. to the number  $z$ . If the number exceeds 1000, the first term of the series, viz.

$\frac{z}{4z}$ , is sufficient for producing the logarithm to 13 or 14

places of figures, and the second term will give the logarithm to 20 places of figures. But if  $z$  be greater than

0.00000000542813; and if the logarithm of the geometrical mean, viz.

4.301051709302416 be added to the quotient, the sum will be

4.301051709845230 = the logarithm of 20001

Wherefore it is manifest that to have the logarithm to 14 places of figures, there is no necessity of continuing out the quotient beyond 6 places of figures. But if you have a mind to have the logarithm to 10 places of figures only, the two first figures are enough. And if the logarithms of the numbers above 20000 are to be found by this way, the labour of doing them will mostly consist in setting down the numbers. This series is easily deduced from the consideration of the hyperbolic spaces aforesaid. The first figure of every logarithm towards the left hand, which is separated from the rest by a point, is called the index of that logarithm; because it points out the highest or remotest place of that number from the place of unity in the infinite scale of proportionals towards the left hand: thus, if the index of the logarithm be 1, it shews that its highest place towards the left hand is the tenth place from unity; and therefore all logarithms which have 1 for their index, will be found between the tenth and hundredth place, in the order of numbers. And for the same reason all logarithms which have 2 for their index, will be found between the hundredth and thousandth place, in the order of numbers, &c. Whence universally the index or characteristic of any logarithm is always less by one than the number of figures in whole numbers, which answer to the given logarithm; and, in decimals, the index is negative.

As all systems of logarithms whatever, are composed of similar quantities, it will be easy to form, from any system of logarithms, another system in any given ratio; and consequently to reduce one table of logarithms into another of any given form. For as any one logarithm in the given form, is to its correspondent logarithm in another form; so is any other logarithm in the given form, to its correspondent logarithm in the required form; and hence we may reduce the logarithms of lord Napier into the form of Briggs's, and contrariwise. For as 2.302585092, &c. lord Napier's logarithm of 10. is to 1.000000000, Mr Briggs's logarithm of 10; so is any other logarithm in lord Napier's form, to the correspondent tabular logarithm in Mr Briggs's form; and because the two first numbers constantly remain the same; if lord Napier's logarithm of any one number be divided by 2.302585, &c. or multiplied by 4342944, &c. the ratio of 1.0000, &c. to 2.30258, &c. as is found by dividing 1.00000, &c. by 2.30258, &c. the quotient in the former, and the product in the latter, will give the correspondent logarithm

10000. the first term will exhibit the logarithm to 18 places of figures; and so this series is of great use in filling up the chiliads omitted by Mr Briggs. For example, it is required to find the logarithm of 20001; the logarithm of 20000 is the same as the logarithm of 2, with the index 4 prefixed to it; and the difference of the logarithms of 20000 and 20001, is the same as the difference of the logarithms of the numbers 10000 and 10001, viz. 0.0000434272, &c. And if this difference

be divided by  $4z$ , or 80004, the quotient  $\frac{z}{4z}$  shall be

0.00000000542813; and if the logarithm of the geometrical mean, viz.

4.301051709302416 be added to the quotient, the sum will be

in Briggs's form, and the contrary. And, after the same manner, the ratio of natural logarithms to that of Briggs's, will be found=868538963806.

*The use and application of LOGARITHMS.*

It is evident, from what has been said of the construction of logarithms, that addition of logarithms must be the same thing as multiplication in common arithmetick; and subtraction in logarithms the same as division; therefore, in multiplication by logarithms, add the logarithms of the multiplicand and multiplier together, their sum is the logarithm of the product.

	num. logarithms.
Example. Multiplicand	8.5 0.1294189
Multiplier	10 1.0000000
	-----
Product	85 1.9294189

And in division, subtract the logarithm of the divisor from the logarithm of the dividend, the remainder is the logarithm of the quotient.

	num. logarithms.
Example. Dividend	9712 8 3.9873444
Divisor	456 2.6589648
	-----
Quotient	21.3 1.3283796

*To find the complement of a LOGARITHM.*

Begin at the left hand, and write down what each figure wants of 9, only what the last significant figure wants of 10; so the complement of the logarithm of 456, viz. 2.6589648, is 7.3410352.

In the rule of three. Add the logarithms of the second and third terms together, and from the sum subtract the logarithm of the first, the remainder is the logarithm of the fourth. Or, instead of subtracting a logarithm, add its complement, and the result will be the same.

*To raise powers by LOGARITHMS.*

Multiply the logarithm of the number given, by the index of the power required, the product will be the logarithm of the power sought.

Example. Let the cube of 32 be required by logarithms. The logarithm of 32=1.5051500. which multiplied by 3, is 4.5154500, the logarithm of 32768, the cube of 32. But in raising powers, viz. squaring, cubing,

bing, &c. of any decimal fraction by logarithms, it must be observed, that the first significant figure of the power be put so many places below the place of units, as the index of its logarithm wants of 10, 100, &c. multiplied by the index of the power.

*To extract the roots of powers by LOGARITHMS.*

Divide the logarithm of the number by the index of the power, the quotient is the logarithm of the root sought.

Logarithm of 106 = 2.0253058  
 Logarithm of 100 = 2.0000000

Divide by 4) 0.0253059 (0.0063264.75

Logarithm of the least term 100 added		2.0000000
Logarithm of the first mean 101.4673846		2.0063264.75
Logarithm of the second mean 102.9563014		2.0126529.5
Logarithm of the third mean 104.4670483		2.0189794.25
Logarithm of the greatest term 106		2.0253059.

## L O G I C.

**L**OGIC, the art of thinking and reasoning justly; or, it may be defined the science or history of the human mind, inasmuch as it traces the progress of our knowledge from our first and most simple through all their different combinations, conceptions, and all those numerous deductions that result from variously comparing them one with another.

The precise business of logic, therefore, is to explain the nature of the human mind, and the proper manner of conducting its several powers, in order to the attainment of truth and knowledge. It lays open those errors and mistakes we are apt, through inattention, to run into; and teaches us how to distinguish between truth, and

*To find mean proportionals between any two numbers.*

Subtract the logarithm of the least term from the logarithm of the greatest, and divide the remainder by a number more by one than the number of means desired; then add the quotient to the logarithm of the least term (or subtract it from the logarithm of the greatest) continually, and it will give the logarithms of all the mean proportionals required.

Example. Let three mean proportionals be sought, between 106 and 100.

what only carries the appearance of it. By this means we grow acquainted with the nature and force of the understanding; see what things lie within its reach; where we may attain certainty and demonstration; and when we must be contented with probability.

This science is generally divided into four parts, *viz.* Perception, Judgment, Reasoning, and Method. This division comprehends the whole history of the sensations and operations of the human mind. But we must refer the reader for the first part, *viz.* Perception, and Ideas, to METAPHYSICS, where it will be more conveniently and fully treated, and confine ourselves in this place to the three last, *viz.* Judgment, Reasoning, and Method.

### PART I. Of JUDGMENT.

THE mind being furnished with ideas, its next step in the way to knowledge is, the comparing these ideas together, in order to judge of their agreement or disagreement. In this joint view of our ideas, if the relation is such, as to be immediately discoverable by the bare inspection of the mind; the judgments thence obtained are called *intuitive*; for in this case, a mere attention to the ideas compared, suffices to let us see, how far they are connected or disjointed. Thus, *that the whole is greater than any of its parts*, is an intuitive judgment, nothing more being required to convince us of its truth, than an attention to the ideas of *whole* and *part*. And this too is the reason, why we call the act of the mind forming these judgments, *intuition*; as it is indeed no more, than an immediate perception of the agreement or disagreement of any two ideas.

But it is to be observed, that our knowledge of this

kind respects only our ideas, and the relations between them; and therefore can serve only as a foundation to such reasonings as are employed in investigating these relations. Now many of our judgments are conversant about facts, and the real existence of things, which cannot be traced by the bare contemplation of our ideas. It does not follow, because I have the idea of a circle in my mind, that therefore a figure answering to that idea, has a real existence in nature. I can form to myself the notion of a centaur, or golden mountain, but never imagine on that account, that either of them exist. What then are the grounds of our judgment in relation to facts? *Experience* and *testimony*. By *experience* we are informed of the existence of the several objects which surround us, and operate upon our senses. *Testimony* is of a wider extent, and reaches not only to objects beyond the present sphere of our observation, but also to facts and

and transactions, which being now past, and having no longer any existence, could not without this conveyance, have fallen under our cognizance.

Here then we have three foundations of human judgment, from which the whole system of our knowledge may with ease and advantage be derived. First, *intuition*, which respects our ideas themselves, and their relations, and is the foundation of that species of reasoning, which we call *demonstration*. For whatever is deduced from our intuitive perceptions, by a clear and connective series of proofs, is said to be demonstrated, and produces absolute certainty in the mind. Hence the knowledge obtained in this manner, is what we properly term *science*; because in every step of the procedure, it carries its own evidence along with it, and leaves no room for doubt or hesitation. And, what is highly worthy of notice, as the truths of this class express the relations between our ideas, and the same relations must ever and invariably subsist between the same ideas, our deductions in the way of science, constitute what we call eternal, necessary, and immutable truths. If it be true that the whole is equal to all its parts, it must be so unchangeably; because the relation of equality being attached to the ideas themselves, must ever intervene where the same ideas are compared. Of this nature are all the truths of natural religion, morality, and mathematicks, and in general, whatever may be gathered from the bare view and consideration of our ideas.

The second ground of human judgment is *experience*; from which we infer the existence of those objects that surround us, and fall under the immediate notice of our senses. When we see the sun, or cast our eyes towards a building, we not only have ideas of these objects within ourselves, but ascribe to them a real existence out of the mind. It is also by the information of the senses, that we judge of the qualities of bodies; as when we say that snow is white, fire hot, or steel hard. For as we are wholly unacquainted with the internal structure and constitution of the bodies that produce these sensations in us, and are unable to trace any connection between that structure and the sensations themselves, it is evident, that we build our judgments altogether upon observation, ascribing to bodies such qualities, as are answerable to the perceptions they excite in us. But this is not the only advantage derived from experience; for we are likewise indebted to it for all our knowledge regarding the co-existence of sensible qualities in objects, and the operations of bodies one upon another. Ivory, for instance, is hard and elastic; this we know by experience, and indeed by that alone. For being altogether strangers to the true nature both of elasticity and hardness, we cannot by the bare contemplation of our ideas determine, how far the one necessarily implies the other, or whether there may not be a repugnance between them. But when we observe them to exist both in the same object, we are then assured from experience, that they are not incompatible; and when we also find that a stone is hard and not elastic, and that air though elastic is not hard, we also conclude upon the same foundation, that the ideas are not necessarily conjoined; but may exist separately in different objects. In like manner with regard

VOL. II. N<sup>o</sup> 68.

2

to the operations of bodies one upon another; it is evident, that our knowledge this way, is all derived from observation. *Aqua regia* dissolves gold, as has been found by frequent trial, nor is there any other way of arriving at the discovery. Naturalists may tell us if they please, that the parts of *aqua regia* are of a texture apt to insinuate between the corpuscles of gold, and thereby loosen and shake them asunder. If this is a true account of the matter, we believe it will notwithstanding be allowed, that our conjecture in regard to the conformation of these bodies is deduced from the experiment, and not the experiment from the conjecture. It was not from any previous knowledge of the intimate structure of *aqua regia* and *gold*, and the aptness of their parts to act or be acted upon, that we came by the conclusion above mentioned. The internal constitution of bodies is in a manner wholly unknown to us, and could we even surmount this difficulty, yet as the separation of the parts of gold, implies something like an active force in the *menstruum*, and we are unable to conceive how it comes to be possessed of this activity; the effect must be owned to be altogether beyond our comprehension. But when repeated trials had once confirmed it, inasmuch that it was admitted as an established truth in natural knowledge, it was then easy for men, to spin out theories of their own invention, and contrive such a structure of parts, both for *gold* and *aqua regia*, as would best serve to explain the phenomenon, upon the principles of that system of philosophy they had adopted.

From what has been said it is evident, that as intuition is the foundation of what we call *scientific* knowledge, so is experience of *natural*. For this last, being wholly taken up with objects of sense, or those bodies that constitute the natural world; and their properties, as far as we can discover them, being to be traced only by a long and painful series of observations, it is apparent, that in order to improve this branch of knowledge, we must betake ourselves to the method of trial and experiment.

But though experience is what we may term the immediate foundation of natural knowledge, yet with respect to particular persons, its influence is very narrow and confined. The bodies that surround us are numerous, many of them lie at a great distance, and some quite beyond our reach. Life too is short, and so crowded with cares, that but little time is left for any single man to employ himself in unfolding the mysteries of nature. Hence it is necessary to admit many things upon the testimony of others, which by this means becomes the foundation of a great part of our knowledge of body. No man doubts of the power of *aqua regia* to dissolve gold, though perhaps he never himself made the experiment. In these therefore and such like cases, we judge of the facts and operations of nature, upon the mere ground of testimony. However, as we can always have recourse to experience, where any doubt or scruple arises, this is justly considered as the true foundation of natural philosophy; being indeed the ultimate support upon which our assent rests, and whereto we appeal, when the highest degree of evidence is required.

But there are many facts that will not allow of an appeal to the senses, and in this case testimony is the true

†

10 Q

and

and only foundation of our judgments. All human actions of whatever kind, when considered as already past, are of the nature here described; because having now no longer any existence, both the facts themselves, and the circumstances attending them, can be known only from the relations of such as had sufficient opportunities of arriving at the truth. *Testimony* therefore is justly accounted a third ground of human judgment; and as from the other two we have deduced *scientific* and *natural* knowledge, so may we from this derive *historical*; by which we mean, not merely a knowledge of the civil transactions of states and kingdoms, but of all facts whatsoever, where testimony is the ultimate foundation of our belief.

#### *Of affirmative and negative propositions.*

WHILE the comparing of our ideas, is considered merely as an act of the mind, assembling them together, and joining or disjoining them according to the result of its preceptions, we call it *judgment*; but when our judgments are put into words, they then bear the name of *propositions*. A proposition therefore is a sentence expressing some judgment of the mind, whereby two or more ideas are affirmed to agree or disagree. Now as our judgments include at least two ideas, one of which is affirmed or denied of the other, so must a proposition have terms answering to these ideas. The idea of which we affirm or deny, and of course the term expressing that idea, is called the *subject* of the proposition. The idea affirmed or denied, as also the term answering it is called the *predicate*. Thus in the proposition, *God is omnipotent*: *God* is the subject, it being of him that we affirm omnipotence; and *omnipotent* is the predicate, because we affirm the idea expressed by that word to belong to God.

But as in propositions, ideas are either joined or disjoined; it is not enough to have terms expressing those ideas, unless we have also some words to denote their agreement or disagreement. That word in a proposition which connects two ideas together, is called the *copula*; and if a negative particle be annexed, we thereby understand that the ideas are disjoined. The *substantive verb*, is commonly made use of for the copula, as in the above-mentioned proposition, *God is omnipotent*; where *is* represents the copula, and signifies the agreement of the ideas of *God* and *omnipotence*. But if we mean to separate two ideas: then, besides the substantive verb, we must also use some particle of negation, to express this repugnance. The proposition, *Man is not perfect*; may serve as an example of this kind, where the notion of *perfection*, being removed from the idea of *man*, the negative particle *not* is inserted after the copula, to signify the disagreement between the subject and predicate.

Every proposition necessarily consists of these three parts, but then it is not alike needful that they be all severally expressed in words; because the copula is often included in the term of the predicate, as when we say, *He sits*; which imports the same as *he is sitting*. In the *Latin* language, a single word has often the force of a whole sentence. Thus, *ambulat* is the same as *ille est ambulans*; *amo*, as *ego sum amans*, and so in innumerable other instances; by which it appears, that we are not so much to regard the number of words in a sentence,

as the ideas they represent, and the manner in which they are put together. For where ever two ideas are joined or disjoined in an expression, though of but a single word it is evident that we have a subject, predicate, and copula, and of consequence a complete proposition.

When the mind joins two ideas, we call it an *affirmative* judgment; when it separates them, a *negative*; and as any two ideas compared together, must necessarily either agree or not agree, it is evident, that all our judgments fall under these two divisions. Hence likewise, the propositions expressing these judgments, are all either affirmative or negative.

Hence we see the reason of the rule commonly laid down by logicians; that in all negative propositions, the negation ought to affect the copula. For as the copula, when placed by itself, between the subject and the predicate, manifestly binds them together; it is evident, that in order to render a proposition negative, the particle of negation must enter it in such manner, as to destroy this union. In a word, then only are two ideas disjoined in a proposition, when the negative particle may be so referred to the copula, as to break the affirmation included in it, and undo that connection it would otherwise establish. When we say, for instance, *No man is perfect*; take away the negation, and the copula of itself plainly unites the ideas in the proposition. On the contrary, in this sentence; *The man who departs not from an upright behaviour, is beloved of God*; the predicate *beloved of God*, is evidently affirmed of the subject *an upright man*; so that notwithstanding the negative particle, the proposition is still affirmative. The reason is plain; the negation here affects not the copula, but making properly a part of the subject, serves with other terms in the sentence, to form one complex idea, of which the predicate *beloved of God*, is directly affirmed.

#### *Of universal and particular propositions.*

THE next considerable division of proposition, is into *universal* and *particular*. Our ideas, are all singular as they enter the mind, and represent individual objects. But as by abstraction we can render them universal, so as to comprehend a whole class of things, and sometimes several classes at once; hence the terms expressing these ideas, must be in like manner universal. (See ΜΕΤΑΦΥΣΙΣ.) If therefore we suppose any general term to become the subject of a proposition, it is evident, that whatever is affirmed of the abstract idea belonging to that term, may be affirmed of all the individuals to which that idea extends. Thus when we say, *Men are mortal*; we consider mortality, not as confined to one or any number of particular men, but as what may be affirmed without restriction of the whole species. By this means the proposition becomes as general as the idea which makes the subject of it, and indeed derives its universality entirely from that idea, being more or less so, according as this may be extended to more or fewer individuals. But these general terms sometimes enter a proposition in their full latitude, as in the example given above; and sometimes appear with a mark of limitation. In this last case we are given to understand, that the predicate agrees not to the whole universal idea, but only to a part of it; as in the proposition,

proposition, *some men are wise*: for here wisdom is not affirmed of every particular man, but restrained to a few of the human species.

Now from this different appearance of the general idea, that constitutes the subject of any judgment, arises the division of propositions into *universal* and *particular*. An *universal* proposition is that wherein the subject is some general term, taken in its full latitude, inasmuch that the predicate agrees to all the individuals comprehended under it, if it denotes a proper species; and to all the several species, and their individuals, if it marks an idea of a higher order. The words *all, every, no, none, &c.* are the proper signs of this universality; and as they seldom fail to accompany general truths, so they are the most obvious criterion whereby to distinguish them. *All animals have a power of beginning motion.* This is an universal proposition; as we know from the word *all*, prefixed to the subject *animal*, which denotes that it must be taken in its full extent. Hence the power of beginning motion, may be affirmed of all the several species of animals.

A *particular* proposition has in like manner some general term for its subject, but with a mark of limitation added, to denote, that the predicate agrees only to some of the individuals comprehended under a species, or to one or more of the species belonging to any genus, and not to the whole universal idea. Thus, *some stones are heavier than iron; some men have an uncommon share of prudence.* In the last of these propositions, the subject *some men*, implies only a certain number of individuals, comprehended under a single species. In the former, where the subject is a genus, that extends to a great variety of distinct classes, *some stones* may not only imply any number of particular stones, but also several whole species of stones; inasmuch as there may be not a few, with the property there described. Hence we see, that a proposition does not cease to be particular, by the predicate's agreeing to a whole species, unless that species singly and distinctly considered, makes also the subject of which we affirm or deny.

There is still one species of propositions that remains to be described; and which the more deserve our notice, as it is not yet agreed among logicians to which of the two classes mentioned above they ought to be referred, I mean *singular* propositions; or those where the subject is an individual. Of this nature are the following: *Sir Isaac Newton was the inventor of fluxions; This book contains many useful truths.* What occasions some difficulty, as to the proper rank of these propositions, is, that the subject being taken according to the whole of its extension, they sometimes have the same effect in reasoning, as universals. But if it be considered, that they are in truth the most limited kind of particular propositions, and that no proposition can with any propriety be called universal, but where the subject is some universal idea; we shall not be long in determining to which class they ought to be referred. When we say, *Some books contain useful truths*; the proposition is particular, because the general term appears with a mark of restriction. If therefore we say, *This book contains useful truths*; it is evident that the proposition must be still more particular, as the limi-

tation implied in the word *this* is of a more confined nature than in the former case.

We see therefore, that all propositions are either *affirmative* or *negative*; nor is it less evident, that in both cases they may be *universal* or *particular*. Hence arises that celebrated fourfold division of them, into *universal, affirmative, and universal negative; particular affirmative, and particular negative*; which comprehends indeed all their varieties. The use of this method of distinguishing them will appear more fully afterwards, when we come to treat of reasoning and syllogism.

#### *Of absolute and conditional propositions.*

THE objects about which we are chiefly conversant in this world, are all of a nature liable to change. What may be affirmed of them at one time, cannot often at another; and it makes no small part of our knowledge, to distinguish rightly these variations, and trace the reasons upon which they depend. For it is observable, that amidst all the vicissitudes of nature, some things remain constant and invariable; nor are even the changes, to which we see others liable, effected, but in consequence of uniform and steady laws, which when known, are sufficient to direct us in our judgments about them. Hence philosophers, in distinguishing the objects of our perception into various classes, have been very careful to note, that some properties belong essentially to the general idea, so as not to be separable from it, but by destroying its very nature; while others are only accidental, and may be affirmed or denied of it in different circumstances. Thus, solidity, a yellow colour, and great weight, are considered as essential qualities of gold; but whether it shall exist as an uniform conjoined mass, is not alike necessary. We see that, by a proper menstruum, it may be reduced to a fine powder; and that intense heat will bring it into a state of fusion.

From this diversity in the several qualities of things, arises a considerable difference as to the manner of our judging about them. For all such properties as are inseparable from objects, when considered as belonging to any genus or species, are affirmed absolutely and without reserve of that general idea. Thus we say, *Gold is very weighty, a stone is hard, animals have a power of self-motion.* But in the case of mutable or accidental qualities, as they depend upon some other consideration, distinct from the general idea; that also must be taken into the account, in order to form an accurate judgment. Should we affirm, for instance, of some stones, that they are very susceptible of a rolling motion; the proposition while it remains in the general form, cannot with any advantage be introduced into our reasonings. An aptness to receive that mode of motion, flows from the figure of the stone; which, as it may vary infinitely, our judgment then only becomes applicable and determinate, when the particular figure, of which volubility is a consequence, is also taken into the account. Let us then bring in this other consideration, and the proposition will run as follows: *Stones of a spherical form, are easily put into a rolling motion.* Here we see the condition upon which the predicate is affirmed, and therefore know in what particular cases the proposition may be applied.

This:

This consideration of propositions, respecting the manner in which the predicate is affirmed of the subject, gives rise to the division of them into *absolute* and *conditional*. *Absolute* propositions are those, wherein we affirm some property inseparable from the idea of the subject, and which therefore belongs to it in all possible cases; as, *God is infinitely wise*. *Virtue tends to the ultimate happiness of man*. But where the predicate is not necessarily connected with the idea of the subject, unless upon some consideration distinct from that idea, there the proposition is called *conditional*. The reason of the name is taken from the supposition annexed, which is of the nature of a condition, and may be expressed as such. Thus, *If a stone is exposed to the rays of the sun, it will contract some degree of heat*. *If a river runs in a very declining channel, its rapidity will constantly increase*.

There is not any thing of greater importance in philosophy, than a due attention to this division of propositions. If we are careful never to affirm things absolutely, but where the ideas are inseparably conjoined; and if in our other judgments, we distinctly mark the conditions which determine the predicate to belong to the subject, we shall be the less liable to mistake in applying general truths to the particular concerns of human life. It is owing to the exact observance of this rule, that mathematicians have been so happy in their discoveries, and that what they demonstrate of magnitude in general, may be applied with ease in all obvious occurrences.

The truth is, particular propositions are then known to be true, when we can trace their connection with universals; and it is accordingly the great business of science, to find out general truths, that may be applied with safety in all obvious instances. Now the great advantage arising from determining with care the conditions upon which one idea may be affirmed or denied of another, is this; that thereby particular propositions really become universal, may be introduced with certainty into our reasonings, and serve as standards to conduct and regulate our judgments. To illustrate this by a familiar instance. If we say, *Some water acts very forcibly*; the proposition is particular: And as the conditions on which this forcible action depends, are not mentioned, it is as yet uncertain in what cases it may be applied. Let us then supply these conditions, and the proposition will run thus: *Water conveyed in sufficient quantity, along a steep descent, acts very forcibly*. Here we have an universal judgment, inasmuch as the predicate *forcible action*, may be ascribed to all water under the circumstances mentioned. Nor is it less evident, that the proposition in this new form is of easy application; and in fact we find, that men do apply it, in instances where the forcible action of water is required; as in corn-mills, and many other works of art.

#### *Of simple and compound propositions.*

HITHERTO we have treated of propositions, where only two ideas are compared together. These are in the general called *simple*; because having but one subject and one predicate, they are the effect of a simple judgment, that admits of no subdivision. But if several ideas offer themselves to our thoughts at once, whereby we are led

to affirm the same thing of different objects, or different things of the same object; the propositions expressing these judgments are called *compound*: because they may be resolved into as many others as there are subjects or predicates in the whole complex determination of the mind. Thus: *God is infinitely wise, and infinitely powerful*. Here there are two predicates, *infinite wisdom, and infinite power*, both affirmed of the same subject; and accordingly, the proposition may be resolved into two others, affirming these predicates severally, in like manner in the proposition, *neither kings nor people are exempt from death*; the predicate is denied of both subjects, and may therefore be separated from them, in distinct propositions. Nor is it less evident, that if a complex judgment consists of several subjects and predicates, it may be resolved into as many simple propositions as are the number of different ideas compared together. *Riches and honours are apt to elate the mind, and increase the number of our desires*. In this judgment, there are two subjects and two predicates, and it is at the same time apparent, that it may be resolved into four distinct propositions. *Riches are apt to elate the mind*. *Honours are apt to increase the number of our desires*. And so of honours.

Logicians have divided these compound propositions into a great many different classes; but not with a due regard to their proper definition. Thus, *conditionals, causals, relatives, &c.* are mentioned as so many distinct species of this kind, though in fact they are no more than simple propositions. To give an instance of a conditional: *If a stone is exposed to the rays of the sun, it will contract some degree of heat*. Here we have but one subject and one predicate; for the complex expression, *a stone exposed to the rays of the sun*, constitutes the proper subject of this proposition, and is no more than one determinate idea. The same thing happens in causals. *Rehoboam was unhappy because he followed evil counsel*. There is here an appearance of two propositions, arising from the complexity of the expression; but when we come to consider the matter more nearly, it is evident, that we have but a single subject and predicate. *The pursuit of evil counsel brought misery upon Rehoboam*. It is not enough therefore, to render a proposition compound, that the subject and predicate are complex notions, requiring sometimes a whole sentence to express them: For in this case, the comparison is still confined to two ideas, and constitutes what we call a simple judgment. But where there are several subjects, or predicates, or both, as the affirmation or negation may be alike extended to them all, the proposition expressing such a judgment, is truly a collection of as many simple ones as there are different ideas compared. Confining ourselves therefore to this more strict and just notion of compound propositions, they are all reducible to two kinds, *viz. copulatives and disjunctives*.

A *copulative* proposition is, where the subjects and predicates are so linked together, that they may be all severally affirmed or denied one of another. Of this nature are the examples of compound propositions given above. *Riches and honours are apt to elate the mind, and increase the number of our desires*. *Neither kings nor people are exempt from death*. In the first of these, the

two predicates may be affirmed severally of each subject, whence we have four distinct propositions. The other furnishes an example of the negative kind, where the same predicate being disjoined from both subjects, may be also denied of them in separate propositions.

The other species of compound propositions are those called disjunctives; in which, comparing several predicates with the same subject, we affirm that one of them necessarily belongs to it, but leave the particular predicate undetermined. If any one, for example, says, *This world either exists of itself, or is the work of some all-wise and powerful cause*; it is evident, that one of the two predicates must belong to the world; but as the proposition determines not which, it is therefore of the kind we call *disjunctive*. Such too are the following. *The sun either moves round the earth, or is the centre about which the earth revolves. Friendship finds men equal, or makes them so.* It is the nature of all propositions of this class, supposing them to be exact in point of form, that upon determining the particular predicate, the rest are of course to be removed; or if all the predicates but one are removed, that one necessarily takes place. Thus in the example given above; if we allow the world to be the work of some wise and powerful cause, we of course deny it to be self-existent; or if we deny it to be self-existent, we must necessarily admit that it was produced by some wise and powerful cause. Now this particular manner of linking the predicates together, so that the establishing of one displaces all the rest, or the excluding all but one necessarily establishes that one, cannot otherwise be effected than by means of *disjunctive* particles. And hence it is, that propositions of this class take their name from these particles, which make so necessary a part of them, and indeed constitute their very nature considered as a distinct species.

*Of the division of propositions into self-evident and demonstrable.*

WHEN any proposition is offered to the view of the mind, if the terms in which it is expressed are understood; upon comparing the ideas together, the agreement or disagreement asserted is either immediately perceived, or found to lie beyond the present reach of the understanding. In the first case, the proposition is said to be *self-evident*, and admits not of any proof, because a bare attention to the ideas themselves produces full conviction and certainty; nor is it possible to call in any thing more evident, by way of confirmation. But where the connection or repugnance comes not so readily under the inspection of the mind, there we must have recourse to reasoning; and if by a clear series of proofs we can make out the truth proposed, inasmuch that self-evidence shall accompany every step of the procedure, we are then able to demonstrate what we assert, and the proposition itself is said to be *demonstrable*. When we affirm, for instance, *that it is impossible for the same thing to be and not to be*; whoever understands the terms made use of, perceives at first glance the truth of what is asserted; nor can he by any efforts bring himself to believe the contrary. The proposition therefore is *self-evident*, and such that it is impossible by reasoning to make it plainer; because there is no truth more obvious, or better known, from which

as a consequence it may be deduced. But if we say, *This world had a beginning*; the assertion is indeed equally true, but shines not forth with the same degree of evidence. We find a great difficulty in conceiving how the world could be made out of nothing; and are not brought to a free and full consent, until by reasoning we arrive at a clear view of the absurdity involved in the contrary supposition. Hence this proposition is of the kind we call *demonstrable*, in as much as its truth is not immediately perceived by the mind, but yet may be made appear by means of others more known and obvious, whence it follows as an unavoidable consequence.

From what has been said it appears, that reasoning is employed only about demonstrable propositions, and that our intuitive and self-evident perceptions are the ultimate foundation on which it rests.

Self-evident propositions furnish the first principles of reasoning; and it is certain, that if in our researches we employ only such principles as have this character of self-evidence, and apply them according to the rules to be afterwards explained, we shall be in no danger of error in advancing from one discovery to another. For this we may appeal to the writings of the mathematicians; which being conducted by the express model here mentioned, are an incontestable proof of the firmness and stability of human knowledge, when built upon so sure a foundation. For not only have the propositions of this science stood the test of ages; but are found attended with that invincible evidence, as forces the assent of all who duly consider the proofs upon which they are established.

First then it is to be observed, that they have been very careful in ascertaining their ideas, and fixing the signification of their terms. For this purpose they begin with *definitions*, in which the meaning of their words is so distinctly explained, that they cannot fail to excite in the mind the very same ideas as are annexed to them by the writer. And indeed the clearness and irresistible evidence of mathematical knowledge is owing to nothing so much as this care in laying the foundation. Where the relation between any two ideas is accurately and justly traced, it will not be difficult for another to comprehend that relation, if, in setting himself to discover it, he brings the very same ideas into comparison. But if, on the contrary, he affixes to his words ideas different from those that were in the mind of him who first advanced the demonstration; it is evident, that, as the same ideas are not compared, the same relation cannot subsist, inasmuch that a proposition will be rejected as false, which, had the terms been rightly understood, must have appeared unexceptionably true. A square, for instance, is a figure bounded by four equal right lines, joined together at right angles. Here the nature of the angles makes no less a part of the idea, than the equality of the sides; and many properties demonstrated of the square flow entirely from its being a rectangular figure. If therefore we suppose a man, who has formed a partial notion of a square, comprehending only the equality of its sides without regard to the angles, reading some demonstration that implies also this latter consideration; it is plain he would reject it as not universally true, in as much as it could not be applied where the sides were joined together



gether at unequal angles. For this last figure, answering still to his idea of a square, would be yet found without the property assigned to it in the proposition. But if he comes afterwards to correct his notion, and render his idea complete, he will then readily own the truth and justness of the demonstration.

We see therefore, that nothing contributes so much to the improvement and certainty of human knowledge, as the having determinate ideas, and keeping them steady and invariable in all our discourses and reasonings about them. And on this account it is, that mathematicians always begin by defining their terms, and distinctly unfolding the notions they are intended to express. Hence such as apply themselves to these studies, having exactly the same views of things, and bringing always the very same ideas into comparison, readily discern the relations between them.

When they have taken this first step, and made known the ideas whose relations they intend to investigate; their next care is, to lay down some self evident truths, which may serve as a foundation for their future reasonings. And here indeed they proceed with remarkable circumspection, admitting no principles but what flow immediately from their definitions, and necessarily force themselves upon the mind. Thus a *circle* is a figure formed by a right line, moving round some fixed point in the same plane. The fixed point round which the line is supposed to move, and where one of its extremities terminates, is called the *centre* of the circle. The other extremity, which is conceived to be carried round, until it returns to the point whence it first set out, describes a curve running into itself, and termed the *circumference*. All right lines drawn from the centre to the circumference, are called *radii*. From these definitions compared, geometers derive this self-evident truth, *That the radii of the same circle are all equal one to another.*

We now observe, that, in all propositions, we either affirm or deny some property of the idea that constitutes the subject of our judgment, or we maintain that something may be done or effected. The first sort are called *speculative* propositions, as in the example mentioned above, *the radii of the same circle are all equal one to another.* The others are called *practical*, for a reason too obvious to be mentioned; thus, *that a right line may be drawn from one point to another,* is a practical proposition, inasmuch as it expresses that something may be done.

From this twofold consideration of propositions arises the twofold division of mathematical principles into *axioms* and *postulates*. By an *axiom* they understand any self-evident *speculative* truth: as, *that the whole is greater than its parts; that things equal to one and the same things are equal to one another.* But a self-evident *practical* proposition is what they call a *postulate*. Such are those of *Euclid*; *That a finite right line may be continued directly forwards: That a circle may be described about*

*any centre with any distance.* And as, in an *axiom*, the agreement or disagreement between the subject and predicate must come under the immediate inspection of the mind; so, in a *postulate*, not only the possibility of the thing asserted must be evident at first view, but also the manner in which it may be effected. For where this manner is not of itself apparent, the proposition comes under the notion of the demonstrable kind, and is treated as such by geometrical writers. Thus, *to draw a right line from one point to another,* is assumed by *Euclid* as a *postulate*, because the manner of doing it is so obvious as to require no previous teaching. But then it is not equally evident, *how we are to construct an equilateral triangle.* For this reason he advances it as a demonstrable proposition, lays down rules for the exact performance, and at the same time proves, that if these rules are followed, the figure will be justly described.

This leads us to take notice, that as *self-evident truths* are distinguished into different kinds, according as they are speculative or practical; so is it also with *demonstrable* propositions. A demonstrable speculative proposition, is by mathematicians called a *theorem*. Such is the 47th proposition of the first book of the *Elements*, *viz. that in every right-angled triangle, the square described upon the side subtending the right-angle is equal to both the squares described upon the sides containing the right-angle.* On the other hand, a demonstrable practical proposition, is called a *problem*; as where *Euclid* teaches us *to describe a square upon a given right-line.*

It may not be amiss to add, that besides the four kinds of propositions already mentioned, mathematicians have also a fifth, known by the name of *corollaries*. These are usually subjoined to *theorems*, or *problems*, and differ from them only in this; that they flow from what is there demonstrated, in so obvious a manner, as to discover their dependence upon the proposition whence they are deduced, almost as soon as proposed. Thus *Euclid* having demonstrated, *that in every right-lined triangle all the three angles taken together are equal to two right angles;* adds by way of corollary, *that all the three angles of any one triangle taken together are equal to all the three angles of any other triangle taken together:* which is evident at first sight; because in all cases they are equal to two right ones, and things equal to one and the same thing are equal to one another.

The scholia of mathematicians are indifferently annexed to definitions, propositions, or corollaries; and answer the same purposes as annotations upon a classic author. For in them occasion is taken to explain whatever may appear intricate and obscure in a train of reasoning; to answer objections; to teach the application and uses of propositions; to lay open the original and history of the several discoveries made in the science; and in a word, to acquaint us with all such particulars as deserve to be known, whether considered as points of curiosity or profit.

## PART II. Of REASONING.

It often happens, in comparing ideas together, that their agreement or disagreement cannot be discerned at first

view, especially if they are of such a nature as not to admit of an exact application one to another. When, for instance,

instance, we compare two figures of a different make, in order to judge of their equality or inequality, it is plain, that by barely considering the figures themselves we cannot arrive at an exact determination; because, by reason of their disagreeing forms, it is impossible so to put them together, as that their several parts shall mutually coincide. Here then it becomes necessary to look out for some third idea, that will admit of such an application as the present case requires; wherein if we succeed, all difficulties vanish, and the relation we are in quest of may be traced with ease. Thus right-lined figures are all reducible to squares, by means of which we can measure their areas, and determine exactly their agreement or disagreement in point of magnitude.

But how can any third idea serve to discover a relation between two others, by being compared severally with these others? for such a comparison enables us to see how far the ideas with which this third is compared are connected or disjointed between themselves. In the example mentioned above, of two right-lined figures, if we compare each of them with some square whose area is known, and find the one exactly equal to it, and the other less by a square-inch, we immediately conclude, that the area of the first figure is a square inch greater than that of the second. This manner of determining the relation between any two ideas, by the intervention of some third with which they may be compared, is that which we call *reasoning*. The great art lies, in finding out such intermediate ideas, as, when compared with the others in the question, will furnish evident and known truths, because it is only by means of them that we arrive at the knowledge of what is hidden and remote.

Hence it appears, that every act of reasoning necessarily includes three distinct judgments; two wherein the ideas whose relation we want to discover are severally compared with the middle idea, and a third wherein they are themselves connected or disjointed according to the result of that comparison. Now, as, in the first part of logic, our judgments, when put into words, were called propositions; so here, in the second part, the expressions of our reasonings are termed *sylogisms*. And hence it follows, that as every act of reasoning implies three several judgments, so every syllogism must include three distinct propositions. When a reasoning is thus put into words, and appears in form of a syllogism, the intermediate idea made use of to discover the agreement or disagreement we search for is called the *middle term*; and the two ideas themselves, with which this third is compared, go by the name of the *extremes*.

But as these things are best illustrated by examples; let us, for instance, set ourselves to inquire, *whether men are accountable for their actions*. As the relation between the ideas of *man* and *accountableness*, comes not within the immediate view of the mind, our first care must be, to find out some third idea, that will enable us the more easily to discover and trace it. A very small measure of reflection is sufficient to inform us, that no creature can be accountable for his actions, unless we suppose him capable of distinguishing the good from the bad. Nor is this alone sufficient. For what would it avail him to know good from bad actions, if he had no freedom of choice, nor could avoid the one and pursue

the other? hence it becomes necessary to take in both considerations in the present case. It is at the same time equally apparent, that where-ever there is this ability of distinguishing good from bad actions, and of pursuing the one and avoiding the other, there also a creature is accountable. We have then got a third idea, with which *accountableness* is inseparably connected, *viz. reason and liberty*; which are here to be considered as making up one complex conception. Let us now take this middle idea, and compare it with the other term in the question, *viz. man*; and we all know by experience, that it may be affirmed of him. Having thus, by means of the intermediate idea, formed two several judgments, *viz. that man is possessed of reason and liberty*; and *that reason and liberty imply accountableness*; a third obviously and necessarily follows, *viz. that man is accountable for his actions*. Here then we have a complete act of reasoning, in which there are three distinct judgments; two that may be styled previous, in as much as they lead to the other, and arise from comparing the middle idea with the two ideas in the question: the third is a consequence of these previous acts, and flows from combining the extreme ideas between themselves. If now we put this reasoning into words, it exhibits what logicians term a syllogism, and runs this:

*Every creature possessed of reason and liberty is accountable for his actions.*

*Man is a creature possessed of reason and liberty.*

*Therefore man is accountable for his actions.*

In this syllogism there are three several propositions, expressing the three judgments implied in the act of reasoning, and so disposed as to represent distinctly what passes within the mind in tracing the more distant relations of its ideas. The two first propositions answer the two previous judgments in reasoning, and are called the *premises*, because they are placed before the other. The third is termed the *conclusion*, as being gained in consequence of what was asserted in the premises. The terms expressing the two ideas whose relation we inquire after, as here *man* and *accountableness*, are in general called the *extremes*; and the intermediate idea, by means of which the relation is traced, *viz. a creature possessed of reason and liberty*, takes the name of the *middle term*. Hence it follows, that by the *premises* of a syllogism we are always to understand the two propositions where the middle term is severally compared with the *extremes*; for these constitute the previous judgments, whence the truth we are in quest of is by reasoning deduced. The *conclusion* is that other proposition, in which the *extremes* themselves are joined or separated, agreeably to what appears upon the above comparison.

The conclusion is made up of the extreme terms of the syllogism; and the extreme, which serves as the predicate of the conclusion, goes by the name of the *major term*; the other extreme, which makes the subject in the same proposition, is called the *minor term*. From this distinction of the extremes, arises also a distinction between the premises, where these extremes are severally compared with the middle term. That proposition which compares the greater extreme, or the predicate of the conclusion, with the middle term, is called the *major proposition*.

*proposition*; the other, wherein the same middle term is compared with the subject of the conclusion, or lesser extreme, is called the *minor proposition*. All this is obvious from the syllogism already given, where the conclusion is, *Man is accountable for his actions*. For here the predicate, *accountable for his actions*, being connected with the middle term in the first of the two premisses, *every creature possessed of reason and liberty is accountable for his actions*, gives what we call the *major proposition*. In the second of the premisses, *Man is a creature possessed of reason and liberty*, we find the lesser extreme, or subject of the conclusion, *viz. man*, connected with the same middle term, whence it is known to be the *minor proposition*. When a syllogism is proposed in due form, the major proposition is always placed first, the minor next, and the conclusion last.

These things premised, we may in the general define reasoning to be an act or operation of the mind, deducing some unknown proposition from other previous ones that are evident and known. These previous propositions, in a simple act of reasoning, are only two in number; and it is always required that they be of themselves apparent to the understanding, inasmuch that we assent to and perceive the truth of them as soon as proposed. In the syllogism given above, the premisses are supposed to be self-evident truths, otherwise the conclusion could not be inferred by a single act of reasoning. If, for instance, in the major, *every creature possessed of reason and liberty is accountable for his actions*, the connection between the subject and predicate could not be perceived by a bare attention to the ideas themselves; it is evident, that this proposition would no less require a proof than the conclusion deduced from it. In this case a new middle term must be sought for, to trace the connection here supposed; and this of course furnishes another syllogism, by which having established the proposition in question, we are then, and not before, at liberty to use it in any succeeding train of reasoning. And should it so happen, that in this second essay there was still some previous proposition whose truth did not appear at first sight, we must then have recourse to a third syllogism in order to lay open that truth to the mind; because, so long as the premisses remain uncertain, the conclusion built upon them must be so too. When by conducting our thoughts in this manner, we at last arrive at some syllogism, where the previous propositions are intuitive truths; the mind then rests in full security, as perceiving that the several conclusions it has passed through stand upon the immovable foundation of self-evidence, and when traced to their source terminate in it.

We see therefore, that in order to infer a conclusion by a single act of reasoning, the premisses must be intuitive propositions. Where they are not, previous syllogisms are required; in which case reasoning becomes a complicated act, taking in a variety of successive steps. This frequently happens in tracing the more remote relations of our ideas, where many middle terms being called in, the conclusion cannot be made out, but in consequence of a series of syllogisms following one another in a train. But although in this concatenation of propositions, those that form the premisses of the last syllogism are often

considerably removed from self-evidence; yet if we trace the reasoning backwards, we shall find them the conclusions of previous syllogisms, whose premisses approach nearer and nearer to intuition, in proportion as we advance, and are found at last to terminate in it. And if, after having thus unravelled a demonstration, we take it the contrary way; and observe how the mind, setting out with intuitive perceptions, couples them together to form a conclusion; how, by introducing this conclusion into another syllogism, it still advances one step farther; and so proceeds, making every new discovery subservient to its future progress; we shall then perceive clearly, that reasoning, in the highest exercise of that faculty, is no more than an orderly combination of those simple acts which we have already so full explained.

Thus we see, that reasoning, beginning with first principles, rises gradually from one judgment to another, and connects them in such a manner, that every stage of the progression brings intuitive certainty along with it. And now at length we may clearly understand the definition given above of this distinguishing faculty of the human mind. Reason is the ability of deducing unknown truths from principles or propositions that are already known. This evidently appears by the foregoing account, where we see, that no proposition is admitted into a syllogism, to serve as one of the previous judgments on which the conclusion rests, unless it is itself a known and established truth, whose connection with self-evident principles has been already traced.

*Of the several kinds of reasoning; and first of that by which we determine the genera and species of things.*

ALL the aims of human reason may be reduced to these two: 1. To rank things under those universal ideas to which they truly belong; and, 2. To ascribe to them their several attributes and properties in consequence of that distribution.

One great aim of human reason is, to determine the genera and species of things. Now, as in universal propositions we affirm some property of a genus or species, it is plain, that we cannot apply this property to particular objects, till we have first determined whether they are comprehended under that general idea of which the property is affirmed. Thus there are certain properties belonging to all *even* numbers, which nevertheless cannot be applied to any particular number, until we have first discovered it to be of the species expressed by that general name. Hence reasoning begins with referring things to their several divisions and classes in the scale of our ideas; and as these divisions are all distinguished by peculiar names, we hereby learn to apply the terms expressing general conceptions to such particular objects as come under our immediate observation.

Now, in order to arrive at these conclusions by which the several objects of perception are brought under general names, two things are manifestly necessary. First, that we take a view of the idea itself denoted by that general name, and carefully attend to the distinguishing marks which serve to characterize it. Secondly, that we compare this idea with the object under consideration, observing diligently wherein they agree or differ. If

the

the idea is found to correspond with the particular object, we then without hesitation apply the general name; but if no such correspondence intervenes, the conclusion must necessarily take a contrary turn. Let us, for instance, take the number *eight*, and consider by what steps we are led to pronounce it an *even* number. First then we call to mind the idea signified by the expression *an even number*, viz. that it is a number divisible into two equal parts. We then compare this idea with the number *eight*, and, finding them manifestly to agree, see at once the necessity of admitting the conclusion. These several judgments therefore, transferred into language, and reduced to the form of a syllogism, appear thus:

*Every number that may be divided into two equal parts is an EVEN number.*

*The number EIGHT may be divided into two equal parts.*

*Therefore the number EIGHT is an EVEN number.*

Here it may be observed, that where the general idea to which particular objects are referred is very familiar to the mind, this reference, and the application of the general name, seem to be made without any apparatus of reasoning. When we see a horse in the fields, or a dog in the street, we readily apply the name of the species; habit, and a familiar acquaintance with the general idea, suggesting it instantaneously to the mind. We are not however to imagine on this account, that the understanding departs from the usual rules of just thinking. A frequent repetition of acts begets a habit; and habits are attended with a certain promptness of execution that prevents our observing the several steps and gradations by which any course of action is accomplished. But in other instances, where we judge not by pre-contracted habits, as when the general idea is very complex, or less familiar to the mind; we always proceed according to the form of reasoning established above. A goldsmith, for instance, who is in doubt as to any piece of metal, whether it be of the species called *gold*; first examines its properties, and then comparing them with the general idea signified by that name, if he finds a perfect correspondence, no longer hesitates under what class of metals to rank it.

But the great importance of this branch of reasoning, and the necessity of care and circumspection in referring particular objects to general ideas, is still farther evident from the practice of the mathematicians. Every one who has read *Euclid* knows, that he frequently requires us to draw lines through certain points, and according to such and such directions. The figures thence resulting are often squares, parallelograms, or rectangles. Yet *Euclid* never supposes this from their bare appearance, but always demonstrates it upon the strictest principles of geometry. Nor is the method he takes in any thing different from that described above. Thus, for instance, having defined a square to be a figure bounded by four equal sides, joined together at right angles; when such a figure arises in any construction previous to the demonstration of a proposition, he yet never calls it by that name, until he has shewn that its sides are equal, and all its angles right ones. Now this is apparently the same form of reasoning we have before exhibited, in proving *eight* to be an even number.

VOL. II. N<sup>o</sup> 69.

†

Having thus explained the rules by which we are to conduct ourselves in ranking particular objects under general ideas, and shewn their conformity to the practice and manner of the mathematicians; it remains only to observe, that the true way of rendering this part of knowledge both easy and certain, is, by habituating ourselves to clear and determinate ideas, and keeping them steadily annexed to their respective names. For as all our aim is, to apply general words aright; if these words stand for invariable ideas, that are perfectly known to the mind, and can be readily distinguished upon occasion, there will be little danger of mistake or error in our reasonings. Let us suppose, that by examining any object, and carrying our attention successively from one part to another, we have acquainted ourselves with the several particulars observable in it. If among these we find such as constitute some general idea, framed and settled beforehand by the understanding, and distinguished by a particular name; the resemblance, thus known and perceived, necessarily determines the species of the object, and thereby gives it a right to the name by which that species is called. Thus four equal sides, joined together at right angles, made up the notion of a square. As this is a fixed and invariable idea, without which the general name cannot be applied we never call any particular figure a *square*, until it appears to have these several conditions; and contrarily, where ever a figure is found with these conditions, it necessarily takes the name of a *square*. The same will be found to hold in all our other reasonings of this kind; where nothing can create any difficulty but the want of settled ideas. If, for instance, we have not determined within ourselves the precise notion denoted by the word *manslaughter*; it will be impossible for us to decide, whether any particular action ought to bear that name: because however nicely we examine the action itself, yet being strangers to the general idea with which it is to be compared, we are utterly unable to judge of their agreement or disagreement. But if we take care to remove this obstacle, and distinctly trace the two ideas under consideration, all difficulties vanish, and the resolution becomes both easy and certain.

Thus we see, of what importance it is, towards the improvement and certainty of human knowledge, that we accustom ourselves to clear and determinate ideas, and a steady application of words.

*Of Reasoning, as it regards the powers and properties of things, and the relations of our general ideas.*

WE come now to the second great end which men have in view in their reasonings, namely, The discovering and ascribing to things their several attributes and properties. And here it will be necessary to distinguish between reasoning as it regards the sciences, and as it concerns common life. In the sciences, our reason is employed chiefly about universal truths, it being by them alone that the bounds of human knowledge are enlarged. Hence the division of things into various classes, called otherwise genera and species. For these universal ideas, being set up as the representatives of many particular things, whatever is affirmed of them may be also affirmed of all the individuals to which they belong. *Murder*, for instance,

10 S 2.

is.

is a general idea, representing a certain species of human actions. Reason tells us that the punishment due to it is *death*. Hence every particular action coming under the notion of *murder*, has the punishment of *death* allotted to it. Here then we apply the general truth to some obvious instance, and this is what properly constitutes the reasoning of common life. For men, in their ordinary transactions and intercourse one with another, have for the most part to do only with particular objects. Our friends and relations, their characters and behaviour, the constitution of the several bodies that surround us, and the uses to which they may be applied, are what chiefly engage our attention. In all these we reason about particular things; and the whole result of our reasoning is, the applying the general truths of the sciences to the ordinary transactions of human life. When we see a viper, we avoid it. Where-ever we have occasion for the forcible action of water, to move a body that makes considerable resistance, we take care to convey it in such a manner that it shall fall upon the object with impetuosity. Now all this happens in consequence of our familiar and ready application of these two general truths. *The bite of a viper is mortal. Water falling upon a body with impetuosity, acts very forcibly towards setting it in motion.* In like manner, if we set ourselves to consider any particular character, in order to determine the share of praise or dispraise that belongs to it, our great concern is, to ascertain exactly the proportion of virtue and vice. The reason is obvious. A just determination in all cases of this kind depends entirely upon an application of these general maxims of morality: *Virtuous actions deserve praise. Vicious actions deserve blame.*

Hence it appears, that reasoning, as it regards common life, is no more than the ascribing the general properties of things to those several objects with which we are more immediately concerned, according as they are found to be that particular division or class to which the properties belong. The steps then by which we proceed are manifestly these. First, we refer the object under consideration to some general idea or class of things. We then recollect the several attributes of that general idea. And lastly, ascribe all those attributes to the present object. Thus, in considering the character of *Sempronius*, if we find it to be of the kind called *virtuous*; when we at the same time reflect, that a *virtuous* character is deserving of esteem, it naturally and obviously follows that *Sempronius* is so too. These thoughts put into a *sylogism*, in order to exhibit the form of reasoning here required, run thus.

*Every virtuous man is worthy of esteem.*

*SEMPRONIUS is a virtuous man.*

*Therefore SEMPRONIUS is worthy of esteem.*

By this *sylogism* it appears, that before we affirm any thing of a particular object, that object must be referred to some general idea. *Sempronius* is pronounced worthy of esteem, only in consequence of his being a virtuous man. Hence we see the necessary connection of the various parts of reasoning, and the dependence they have one upon another. The determining the genera and species of things is, as we have said, one exercise of human reason; and here we find, that this exercise is the first in order, and previous to the other, which consists in ascribing to

them their powers, properties, and relations. But when we have taken this previous step, and brought particular objects under general names; as the properties we ascribe to them are no other than those of the general idea, it is plain, that in order to a successful progress in this part of knowledge, we must thoroughly acquaint ourselves with the several relations and attributes of these our general ideas. When this is done, the other part will be easy, and require scarce any labour of thought, as being no more than an application of the general form of reasoning represented in the foregoing *sylogism*. Now as we have already sufficiently shown how we are to proceed in determining the genera and species of things, all that is farther wanting towards a due explanation of it is, to offer some considerations as to the manner of investigating the general relations of our ideas. This is the highest exercise of the powers of the understanding, and that by means whereof we arrive at the discovery of universal truths, inasmuch that our deductions in this way constitute that particular species of reasoning which we have before said regards principally the sciences.

But that we may conduct our thoughts with some order and method, we shall begin with observing, that the relations of our general ideas are of two kinds. Either such as immediately discover themselves, upon comparing the ideas one with another; or such as, being more remote and distant, require art and contrivance to bring them into view. The relations of the first kind furnish us with intuitive and self-evident truths; those of the second are traced by reasoning and a due application of intermediate ideas. It is of this last kind that we are to speak here, having dispatched what was necessary with regard to the other in the former part. As therefore, in tracing the more distant relations of things, we must always have recourse to intervening ideas, and are more or less successful in our researches, according to our acquaintance with these ideas, and ability of applying them it is evident, that to make a good reasoner, two things are principally required. *First*, an extensive knowledge of those intermediate ideas, by means of which things may be compared one with another. *Secondly*, the skill and talent of applying them happily, in all particular instances that come under consideration.

In order to our successful progress in reasoning, we must have an extensive knowledge of those intermediate ideas by means of which things may be compared one with another. For as it is not every idea that will answer the purpose of our inquiries, but such only as are peculiarly related to the objects about which we reason, so as, by a comparison with them, to furnish evident and known truths; nothing is more apparent, than that the greater variety of conceptions we can call into view, the more likely we are to find some among them that will help us to the truths here required. And indeed it is found to hold in experience, that in proportion as we enlarge our views of things, and grow acquainted with a multitude of different objects, the reasoning faculty gathers strength. For by extending our sphere of knowledge, the mind acquires a certain force and penetration, as being accustomed to examine the several appearances of its ideas, and observe what light they cast one upon another.

This

This is the reason, why, in order to excel remarkably in any one branch of learning, it is necessary to have at least a general acquaintance with the whole circle of arts and sciences. The truth is, all the various divisions of human knowledge are very nearly related among themselves, and in innumerable instances serve to illustrate and set off each other. And altho' it is not to be denied, that, by an obstinate application to one branch of study, a man may make considerable progress and acquire some degree of eminence in it; yet his views will be always narrow and contracted, and he will want that masterly discernment, which not only enables us to pursue our discoveries with ease, but also, in laying them open to others, to spread a certain brightness around them. But when our reasoning regards a particular science, it is farther necessary, that we more nearly acquaint ourselves with whatever relates to that science. A general knowledge is a good preparation, and enables us to proceed with ease and expedition, in whatever branch of learning we apply to. But then in the minute and intricate questions of any science we are by no means qualified to reason with advantage, until we have perfectly mastered the science to which they belong.

We come now to the second thing required, in order to a successful progress in reasoning, namely, the skill and talent of applying intermediate ideas happily in all particular instances that come under consideration. Use and exercise are the best instructors in the present case. And therefore the true way to acquire this talent is, by being much conversant in those sciences where the art of reasoning is allowed to reign in the greatest perfection. Hence it was that the ancients, who so well understood the manner of forming the mind, always began with *mathematicks*, as the foundation of their philosophical studies. Here the understanding is by degrees habituated to truth, contracts insensibly a certain fondness for it, and learns never to yield its assent to any proposition, but where the evidence is sufficient to produce full conviction. For this reason *Plato* has called mathematical demonstrations the *catharticks* or purgatives of the soul, as being the proper means to cleanse it from error, and restore that natural exercise of its faculties, in which just thinking consists.

If therefore we would form our minds to a habit of reasoning closely and in train, we cannot take any more certain method, than the exercising ourselves in mathematical demonstrations, so as to contract a kind of familiarity with them. Not that we look upon it as necessary that all men should be deep mathematicians, but that, having got the way of reasoning which that study necessarily brings the mind to, they may be able to transfer it to other parts of knowledge, as they shall have occasion.

But although the study of *mathematicks* be of all others the most useful to form the mind, and give it an early relish of truth, yet ought not other parts of philosophy to be neglected. For there also we meet with many opportunities of exercising the powers of the understanding: and the variety of subjects naturally leads us to observe all those different turns of thinking that are peculiarly adapted to the several ideas we examine and

the truths we search after. For this purpose, besides the study of *mathematicks*, we ought to apply ourselves diligently to the reading of such authors as have distinguished themselves for strength of reasoning, and a just and accurate manner of thinking. For it is observable, that a mind exercised and seasoned to truth, seldom rests satisfied in a bare contemplation of the arguments offered by others, but will be frequently essaying its own strength, and pursuing its discoveries upon the plan it is most accustomed to. Thus we insensibly contract a habit of tracing truth from one stage to another, and of investigating those general relations and properties, which we afterwards ascribe to particular things, according as we find them comprehended under the abstract ideas to which the properties belong.

#### *Of the forms of Syllogisms.*

HITHERTO we have contented ourselves with a general notion of syllogisms, and of the parts of which they consist. It is now time to enter a little more particularly into the subject, to examine their various forms, and lay open the rules of argumentation proper to each. In the syllogisms mentioned in, we may observe, that the *middle term* is the subject of the *major* proposition, and the predicate of the *minor*. This disposition, though the most natural and obvious, is not however necessary; it frequently happening, that the *middle term* is the subject in both the premisses, or the predicate in both; and sometimes directly contrary, the predicate in the *major*, and the subject in the *minor*. Hence the distinction of syllogisms into various kinds, called *figures* by logicians. For *figure*, according to their use of the word, is nothing else but the order and disposition of the *middle term* in any syllogism. And as this disposition is fourfold, so the figures of syllogisms thence arising are four in number. When the *middle term* is the subject of the *major* proposition, and the predicate of the *minor*, we have what is called the *first figure*. If, on the other hand, it is the predicate of both the premisses, the syllogism is said to be in the *second figure*. Again, in the *third figure*, the *middle term* is the subject of the two premisses. And lastly, by making it the predicate of the *major*, and subject of the *minor*, we obtain syllogisms in the *fourth figure*.

But besides this fourfold distinction of syllogisms, there is also a farther subdivision of them in every figure, arising from the *quantity* and *quality*, as they are called, of the propositions. By *quantity* we mean the consideration of propositions as universal or particular; by *quality*, as affirmative or negative. Now as, in all the several dispositions of the *middle term*, the proposition of which a syllogism consists may be either universal or particular, affirmative or negative; the due determination of these, and so putting them together as the laws of argumentation require, constitute what logicians call the *moods* of syllogisms. Of these *moods* there are a determinate number to every figure, including all the possible ways in which propositions differing in *quantity* or *quality* can be combined, according to any disposition of the *middle term*, in order to arrive at a just conclusion.

The division of syllogisms according to mood and figure,

gure, respects those especially which are known by the name of plain simple syllogisms; that is, which are bounded to three propositions, all simple, and where the extremes and middle term are connected according to the rules laid down above. But as the mind is not tied down to any one precise form of reasoning, but sometimes makes use of more, sometimes of fewer premisses, and often takes in compound and conditional propositions, it may not be amiss to take notice of the different forms derived from this source, and explain the rule by which the mind conducts itself in the use of them.

When, in any syllogism, the *major* is a conditional proposition, the syllogism itself is termed *conditional*. Thus:

*If there is a God, he ought to be worshipped.*

*But there is a God:*

*Therefore he ought to be worshipped.*

In this example, the *major* is conditional, and therefore the syllogism itself is also of the kind called by that name. All conditional propositions are made up of two distinct parts: one expressing the condition upon which the predicate agrees or disagrees with the subject, as in this now before us, *if there is a God*; the other joining or disjoining the said predicate and subject, as here, *he ought to be worshipped*. The first of these parts, or that which implies the condition, is called the *antecedent*; the second, where we join or disjoin the predicate and subject, has the name of the *consequent*.

In all propositions of this kind, supposing them to be exact in point of form, the relation between the antecedent and consequent must ever be true and real; that is, the antecedent must always contain some certain and genuine condition, which necessarily implies the consequent; for otherwise the proposition itself will be false, and therefore ought not to be admitted into our reasonings. Hence it follows, that when any conditional proposition is assumed, if we admit the antecedent of that proposition, we must at the same time necessarily admit the consequent; but if we reject the consequent, we are in like manner bound to reject also the antecedent. For as the antecedent always expresses some condition, which necessarily implies the truth of the consequent; by admitting the antecedent we allow of that condition, and therefore ought also to admit the consequent. In like manner if it appears that the consequent ought to be rejected, the antecedent evidently must be so too; because the admitting of the antecedent would necessarily imply the admission also of the consequent.

There are two ways of arguing in *hypothetical* syllogisms, which lead to a certain and unavoidable conclusion. For as the *major* is always a conditional proposition, consisting of an antecedent and a consequent; if the *minor* admits the antecedent, it is plain that the conclusion must admit the consequent. This is called arguing from the admission of the antecedent to the admission of the consequent, and constitutes that mood or species of *hypothetical* syllogisms which is distinguished in the schools by the name of the *modus ponens*, in as much as by it the whole conditional proposition both antecedent and consequent is established. Thus:

*If God is infinitely wise, and acts with perfect freedom, he does nothing but what is best.*

*But God is infinitely wise, and acts with perfect freedom:*

*Therefore he does nothing but what is best.*

Here the antecedent or first part of the conditional proposition is established in the *minor*, and the consequent or second part in the conclusion; whence the syllogism itself is an example of the *modus ponens*. But if we, on the contrary, suppose, that the *minor* rejects the consequent; then it is apparent, that the conclusion must also reject the antecedent. In this case we are said to argue from the removal of the consequent to the removal of the antecedent, and the particular mood or species of syllogisms thence arising is called by logicians the *modus tollens*; because in it both antecedent and consequent are rejected or taken away, as appears by the following example.

*If God were not a being of infinite goodness, neither would he consult the happiness of his creatures.*

*But God does consult the happiness of his creatures; Therefore he is a being of infinite goodness.*

These two species take in the whole class of *conditional* syllogisms, and include all the possible ways of arguing that lead to a legitimate conclusion; because we cannot here proceed by a contrary process of reasoning, that is, from the removal of the antecedent to the removal of the consequent, or from the establishing of the consequent to the establishing of the antecedent. For although the antecedent always expresses some real condition, which once admitted necessarily implies the consequent, yet it does not follow that there is therefore no other condition; and if so, then, after removing the antecedent, the consequent may still hold, because of some other determination that infers it. When we say: *If a stone is exposed some time to the rays of the sun, it will contract a certain degree of heat*; the proposition is certainly true; and admitting the antecedent, we must also admit the consequent. But as there are other ways by which a stone may gather heat, it will not follow, from the ceasing of the before-mentioned condition, that therefore the consequent cannot take place. In other words, we cannot argue: *But the stone has not been exposed to the rays of the sun; therefore neither has it any degree of heat*: in as much as there a great many other ways by which heat might have been communicated to it. And if we cannot argue from the removal of the antecedent to the removal of the consequent, no more can we from the admission of the consequent to the admission of the antecedent; because as the consequent may flow from a great variety of different suppositions, the allowing of it does not determine the precise supposition, but only that some one of them must take place. Thus, in the foregoing proposition, *If a stone is exposed some time to the rays of the sun, it will contract a certain degree of heat*; admitting the consequent, viz. *that it has contracted a certain degree of heat*, we are not therefore bound to admit the antecedent, *that it has been some time exposed to the rays of the sun*, because there are many other causes whence that heat may have proceeded. These two ways of arguing, therefore, hold not in conditional syllogisms.

As from the *major's* being a conditional proposition, we obtain the species of conditional syllogisms; so where it

is a disjunctive proposition, the syllogism to which it belongs is also called *disjunctive*, as in the following example :

*The world is either self-existent, or the work of some finite, or of some infinite being.*

*But it is not self-existent, nor the work of a finite being.*

*Therefore it is the work of an infinite being.*

Now a disjunctive proposition is that where, of several predicates, we affirm one necessarily to belong to the subject, to the exclusion of all the rest, but leave that particular one undetermined. Hence it follows, that as soon as we determine the particular predicate, all the rest are of course to be rejected; or if we reject all the predicates but one, that one necessarily takes place. When therefore, in a *disjunctive* syllogism, the several predicates are enumerated in the *major*; if the *minor* establishes any one of these predicates, the conclusion ought to remove all the rest; or if, in the *minor*, all the predicates but one are removed, the conclusion must necessarily establish that one. Thus, in the *disjunctive* syllogism given above, the *major* affirms one of three predicates to belong to the earth, viz. *self-existence*, or that it is *the work of a finite* or that it is *the work of an infinite being*. Two of these predicates are removed in the *minor*, viz. *self-existence*, and *the work of a finite being*. Hence the conclusion necessarily ascribes to it the third predicate, and affirms that it is *the work of an infinite being*. If now we give the syllogism another turn, inasmuch that the *minor* may establish one of the predicates, by affirming the earth to be *the production of an infinite being*; then the conclusion must remove the other two, asserting it to be neither *self-existent*, nor *the work of a finite being*. These are the forms of reasoning in this species of syllogisms, the justness of which appears at first sight; and that there can be no other, is evident from the very nature of a disjunctive proposition.

In the several kinds of syllogisms hitherto mentioned, the parts are complete, that is, the three propositions of which they consist are represented in form. But it often happens, that some one of the premises is not only an evident truth, but also familiar and in the minds of all men; in which case it is usually omitted, whereby we have an imperfect syllogism, that seems to be made up of only two propositions. Should we, for instance, argue in this manner;

*Every man is mortal;*

*Therefore every king is mortal:*

the syllogism appears to be imperfect, as consisting but of two propositions. Yet it is really complete, only the *minor* [*Every king is a man*] is omitted, and left to the reader to supply, as being a proposition so familiar and evident, that it cannot escape him.

These seemingly imperfect syllogisms are called *enthymemes*, and occur very frequently in reasoning, especially where it makes a part of common conversation. Nay, there is a particular elegance in them; because, not displaying the argument in all its parts, they leave somewhat to the exercise and invention of the mind. By this means we are put upon exerting ourselves, and seem to share in the discovery of what is proposed to us. Now this is the great secret of fine writing, so to frame and put together our thoughts, as to give full play to the reader's imagina-

tion, and draw him insensibly into our very views and course of reasoning. This gives a pleasure not unlike to that which the author himself feels in composing. It besides shortens discourse, and adds a certain force and liveliness to our arguments, when the words in which they are conveyed favour the natural quickness of the mind in its operations, and a single expression is left to exhibit a whole train of thoughts.

But there is another species of reasoning with two propositions, which seems to be complete in itself, and where we admit the conclusion without supposing any tacit or suppressed judgment in the mind from which it follows syllogistically. This happens between propositions where the connection is such that the admission of the one necessarily and at the first sight implies the admission also of the other. For if it so falls out, that the proposition on which the other depends is self-evident, we content ourselves with barely affirming it, and infer that other by a direct conclusion. Thus, by admitting an universal proposition, we are forced also to admit of all the particular propositions comprehended under it, this being the very condition that constitutes a proposition universal. If then that universal proposition chances to be self-evident, the particular ones follow of course, without any farther train of reasoning. Whoever allows, for instance, *that things equal to one and the same things are equal to one another*, must at the same time allow, *that two triangles, each equal to a square whose side is three inches, are also equal between themselves*. This argument therefore,

*Things equal to one and the same thing are equal to one another;*

*Therefore these two triangles, each equal to the square of a line of three inches, are equal between themselves,*

is complete in its kind, and contains all that is necessary towards a just and legitimate conclusion. For the first or universal proposition is self-evident; and therefore requires no farther proof. And as the truth of the particular is inseparably connected with that of the universal, it follows from it by an obvious and unavoidable consequence.

Now in all cases of this kind, where propositions are deduced one from another, on account of a known and evident connection, we are said to reason by *immediate consequence*. Such a coherence of propositions, manifest at first sight, and forcing itself upon the mind, frequently occurs in reasoning. Logicians have explained at some length the several suppositions upon which it takes place, and allow of all *immediate consequences* that follow in conformity to them. It is however observable, that these arguments, though seemingly complete, because the conclusion follows necessarily from the single proposition that goes before, may yet be considered as real *enthymemes*, whose *major*, which is a conditional proposition, is wanting. The syllogism but just mentioned, when represented according to this view, will run as follows:

*If things equal to one and the same thing are equal to one another; these two triangles, each equal to a square whose side is three inches, are also equal between themselves.*



*But things equal to one and the same thing, are equal to one another;*

*Therefore also these triangles, &c. are equal between themselves.*

This observation will be found to hold in all *immediate consequences* whatsoever, inasmuch that they are in fact no more than *enthymemes* of hypothetical syllogisms. But then it is particular to them, that the ground on which the conclusion rests, namely, its coherence with the *minor*, is of itself apparent, and seen immediately to flow from the rules and reasons of logic.

The next species of reasoning we shall take notice of is what is known by the name of a *sorites*. This is a way of arguing, in which a great number of propositions are so linked together, that the predicate of one becomes continually the subject of the next following until at last a conclusion is formed, by bringing together the subject of the first proposition, and the predicate of the last. Of this kind is the following argument.

*God is omnipotent.*

*An omnipotent being can do every thing possible.*

*He that can do every thing possible, can do whatever involves not a contradiction.*

*Therefore God can do whatever involves not a contradiction.*

This particular combination of propositions, may be continued to any length we please, without in the least weakening the ground upon which the conclusion rests. The reason is, because the *sorites* itself may be resolved into as many simple syllogisms as there are middle terms in it; where this is found universally to hold, that when such a resolution is made, and the syllogisms are placed in train, the conclusion of the last in the series is also the conclusion of the *sorites*. This kind of argument therefore, as it serves to unite several syllogisms into one, must stand upon the same foundation with the syllogisms of which it consists, and is indeed, properly speaking, no other than a compendious way of reasoning syllogistically.

What is here said of plain simple propositions, may be as well applied to those that are conditional; that is, any number of them may be so joined together in a series, that the consequent of one shall become continually the antecedent of the next following; in which case, by establishing the antecedent of the first proposition, we establish the consequent of the last, or, by removing the last consequent, remove also the first antecedent. This way of reasoning is exemplified in the following argument.

*If we love any person, all emotions of hatred towards him cease.*

*If all emotions of hatred towards a person cease, we cannot rejoice in his misfortunes.*

*If we rejoice not in his misfortunes, we certainly wish him no injury.*

*Therefore if we love a person, we wish him no injury.*

It is evident that this *sorites*, as well as the last, may be resolved into a series of distinct syllogisms; with this only difference, that here the syllogisms are all conditional.

We come now to that kind of argument which logicians called *induction*; in order to the right understand-

ing of which, it will be necessary to observe, that our general ideas are for the most part capable of various subdivisions. Thus the idea of the lowest species may be subdivided into its several individuals, the idea of any genus into the different species it comprehends, and so of the rest. If then we suppose this distribution to be duly made, and so as to take in the whole extent of the idea to which it belongs; then it is plain, that all the subdivisions or parts of any idea together constitute that whole idea. Thus the several individuals of any species taken together constitute the whole species, and all the various species comprehended under any genus make up the whole genus. This being allowed, whatever may be affirmed of all the several subdivisions and classes of any idea, ought to be affirmed of the whole general idea to which these subdivisions belong. What may be affirmed of all the individuals of any species, may be affirmed of the whole species, and what may be affirmed of all the species of any genus may be also affirmed of the whole genus; because all the individuals taken together are the same with the species, and all the species taken together the same with the genus.

This way of arguing, where we infer universally concerning any idea what we had before affirmed or denied separately of all its several subdivisions and parts, is called reasoning *by induction*. Thus if we suppose the whole tribe of animals, subdivided into men, beasts, birds, insects, and fishes, and then reason concerning them after this manner: *All men have a power of beginning motion; all beasts, birds, and insects, have a power of beginning motion; all fishes have a power of beginning motion; therefore all animals have a power of beginning motion*: the argument is an *induction*. When the subdivisions are just, so as to take in the whole general idea, and the enumeration is perfect, that is, extends to all and every of the inferior classes or parts; there the *induction* is complete, and the manner of reasoning by *induction* is apparently conclusive.

The last species of syllogisms we shall take notice of, is that commonly distinguished by the name of a *dilemma*. A *dilemma* is an arguement, by which we endeavour to prove the absurdity or falsehood of some assertion. In order to this we assume a conditional proposition, the antecedent of which is the assertion to be disproved, and the consequent a disjunctive proposition, enumerating all the possible suppositions upon which that assertion can take place. If then it appears, that all the several suppositions ought to be rejected, it is plain that the antecedent or assertion itself must be so too. When therefore such a proposition as that before-mentioned is made the *major* of any syllogism; if the *minor* rejects all the suppositions contained in the consequent, it follows necessarily, that the conclusion ought to reject the antecedent, which, as we have said, is the very assertion to be disproved. This particular way of arguing is that which logicians call a *dilemma*; and from the account here given of it, it appears, that we may in the general define it to be a *hypothetical syllogism, where the consequent of the major is a disjunctive proposition, which is wholly taken away or removed in the minor*. Of this kind is the following:

*If God did not create the world perfect in its kind: it*

*will be*

*must either proceed from want of inclination, or from want of power.*

*But it could not proceed either from want of inclination, or from want of power :*

*Therefore he created the world perfect in its kind ; or, which is the same thing, It is absurd to say that he did not create the world perfect in its kind.*

The nature then of a *dilemma* is universally this. The *major* is a conditional proposition, whose consequent contains all the several suppositions upon which the antecedent can take place. As therefore these suppositions are wholly removed in the *minor*, it is evident that the antecedent must be so too ; inasmuch that we here always argue from the removal of the consequent to the removal of the antecedent. That is, a *dilemma* is an argument in the *modus tollens* of hypothetical syllogisms, as logicians speak. Hence it is plain, that if the antecedent of the *major* is an affirmative proposition, the conclusion of the *dilemma* will be negative ; but if it is a negative proposition, the conclusion will be affirmative.

#### *Of Demonstration.*

HAVING dispatched what seemed necessary with regard to the forms of syllogisms, we shall now explain their use and application in reasoning. We have seen, that in all the different appearances they put on, we still arrive at a just and legitimate conclusion : now it often happens, that the conclusion of one syllogism becomes a previous proposition in another, by which means great numbers of them are sometimes linked together in a series, and truths are made to follow one another in train. And as in such a concatenation of syllogisms, all the various ways of reasoning that are truly conclusive may be with safety introduced ; hence it is plain, that in deducing any truth from its first principles, especially where it lies at a considerable distance from them, we are at liberty to combine all the several kinds of arguments above explained, according as they are found best to suit the end and purpose of our inquiries. When a proposition is thus, by means of syllogisms, collected from others more evident and known, it is said to be *proved* ; so that we may in the general define *the proof of the proposition* to be a syllogism, or series of syllogisms, collecting that proposition from known and evident truths. But more particularly, if the syllogisms of which the proof consists admit of no premisses but definitions, self-evident truths, and propositions already established, then is the argument so constituted called a *demonstration* ; whereby it appears, that demonstrations are ultimately founded on definitions and self-evident propositions.

All syllogisms whatsoever, whether compound, multi-form, or defective, are reducible to plain simple syllogisms in some one of the four figures. But this is not all. Syllogisms of the first figure in particular, admit of all possible conclusions : that is, any proposition whatsoever, whether an universal affirmative, or universal negative, a particular affirmative, or particular negative, which fourfold division embraces all their varieties ; any one of these may be inferred, by virtue of some syllogism in the first figure. By this means the syllogisms of all the other figures are reducible also to syllogisms of the first

figure, and may be considered as standing on the same foundation with them. We cannot here demonstrate and explain the manner of this reduction. It is enough to take notice, that the thing is universally known and allowed among logicians, to whose writings we refer such as desire farther satisfaction in this matter. This then being laid down, it is plain, that any demonstration whatsoever may be considered as composed of a series of syllogisms, all in the first figure. For since all the syllogisms that enter the demonstration are reducible to syllogisms of some one of the four figures, and since the syllogisms of all the other figures are farther reducible to syllogisms of the first figure, it is evident, that the whole demonstration may be resolved into a series of these last syllogisms. Let us now, if possible, discover the ground upon which the conclusion rests, in syllogisms of the first figure ; because, by so doing, we shall come at an universal principle of certainty, whence the evidence of all demonstrations in all their parts may be ultimately derived.

The rules then of the first figure are these. The *middle term* is the subject of the *major* proposition, and the predicate of the *minor*. The *major* is always an universal proposition, and the *minor* always affirmative. Let us now see what effect these rules will have in reasoning. The *major* is an universal proposition, of which the *middle term* is the subject, and the *predicate of the conclusion* the predicate. Hence it appears, that in the *major*, the *predicate of the conclusion* is always affirmed or denied universally of the *middle term*. Again, the *minor* is an affirmative proposition, whereof the *subject of the conclusion* is the subject, and the *middle term* the predicate. Here then the *middle term* is affirmed of the *subject of the conclusion* ; that is, the *subject of the conclusion* is affirmed to be comprehended under, or to make a part of the *middle term*. Thus then we see what is done in the *premisses* of a syllogism of the first figure. The *predicate of the conclusion* is universally affirmed or denied of some idea. The *subject of the conclusion* is affirmed to be or to make a part of that idea. Hence it naturally and unavoidably follows, that the *predicate of the conclusion* ought to be affirmed or denied of the subject. To illustrate this by an example, we shall resume one of the former syllogisms.

*Every creature possessed of reason and liberty is accountable for his actions.*

*Man is a creature possessed of reason and liberty.*

*Therefore man is accountable for his actions.*

Here, in the first proposition, the predicate of the conclusion, *accountableness*, is affirmed of all creatures that have *reason and liberty*. Again, in the second proposition, *man*, the subject of the conclusion, is affirmed to be or to make a part of the class of creatures. Hence the conclusion necessarily and unavoidably follows, *viz. that man is accountable for his actions* ; because if reason and liberty be that which constitutes a creature *accountable*, and *man* has reason and liberty, it is plain he has that which constitutes him *accountable*. In like manner, where the *major* is a negative proposition, or denies the *predicate of the conclusion* universally of the *middle term*, as the *minor* always asserts the *subject of the conclusion*, to be or make a part of that *middle term*, it is no less evident, that the *predicate of*

*the*

the conclusion ought in this case to be denied of the subject. So that the ground of reasoning in all syllogisms of the first figure is manifestly this. *Whatever may be affirmed universally of any idea, may be affirmed of every or any number of particulars comprehended under that idea.* And again: *Whatever may be denied universally of any idea, may be in like manner denied of every or any number of its individuals.* These two propositions are called by logicians the *dictum de omni*, and *dictum de nullo*, and are indeed the great principles of syllogistic reasoning, inasmuch as all conclusions whatsoever either rest immediately upon them, or upon propositions deduced from them. But what adds greatly to their value is, that they are really self-evident truths, and such as we cannot gainsay without running into an express contradiction. To affirm, for instance, that *no man is perfect*, and yet argue that *some men are perfect*; or to say that *all men are mortal*, and yet that *some men are not mortal*, is to assert a thing to be and not to be at the same time.

And now we may affirm, that in all syllogisms of the first figure, if the *premisses* are true, the *conclusion* must needs be true. If it be true that the *predicate of the conclusion*, whether affirmative or negative, agrees universally to some idea, and if it be also true that the *subject of the conclusion* is a part of or comprehended under that idea, then it necessarily follows, that the *predicate of the conclusion* agrees also to the *subject*. For to assert the contrary, would be to run counter to some one of the two principles before established; that is, it would be to maintain an evident contradiction. And thus we are come at last to the point we have been all along endeavouring to establish, namely, That every proposition which can be demonstrated is necessarily true. For as every demonstration may be resolved into a series of syllogisms all in the first figure, and as, in any one of these syllogisms, if the *premisses* are true, the *conclusion* must be so too; it evidently follows, that if all the several *premisses* are true, all the several *conclusions* are so, and consequently the *conclusion* also of the last syllogism, which is always the proposition to be demonstrated. Now that all the *premisses* of a demonstration are true, will easily appear from the very nature and definition of that form of reasoning. A demonstration is a series of syllogisms, all whose *premisses* are either definitions, self-evident truths, or propositions already established. Definitions are identical propositions, wherein we connect the description of an idea with the name by which we chuse to have that idea called; and therefore as to their truth there can be no dispute. Self-evident propositions appear true of themselves, and leave no doubt or uncertainty in the mind. Propositions before established are no other than conclusions gained by one or more steps from definitions and self-evident principles, that is, from true *premisses*, and therefore must needs be true. Whence all the previous propositions of a demonstration being manifestly true, the last *conclusion* or proposition to be demonstrated must be so too. So that demonstration not only leads to certain truth, but we have here also a clear view of the ground and foundation of that certainty. For as, in demonstrating, we may be said to do nothing more than combine a series of syllogisms together, all

resting on the same bottom; it is plain, that one uniform ground of certainty runs through the whole, and that the conclusions are every where built upon some one of the two principles before established as the foundation of all our reasoning. These two principles are easily reduced into one, and may be expressed thus. *Whatever predicate, whether affirmative or negative, agrees universally to any idea, the same must needs agree to every or any number of individuals comprehended under that idea.* And thus we have reduced the certainty of demonstration to one simple and universal principle, which carries its own evidence along with it, and which is indeed the ultimate foundation of all syllogistic reasoning.

Demonstration therefore serving as an infallible guide to truth, and standing on so sure and unalterable a basis, we may now venture to assert, that the rules of logic furnish a sufficient *critereon* for the distinguishing between truth and falsehood. For since every proposition that can be demonstrated is necessarily true, he is able to distinguish truth from falsehood, who can with certainty judge when a proposition is truly demonstrated. Now a demonstration is nothing more than a concatenation of syllogisms, all whose *premisses* are definitions, self-evident truths, or propositions previously established. To judge therefore of the validity of a demonstration, we must be able to distinguish, whether the definitions that enter it are genuine; and truly descriptive of the ideas they are meant to exhibit; whether the propositions assumed without proof as intuitive truths have really that self-evidence to which they lay claim; whether the syllogisms are drawn up in due form, and agreeable to the laws of argumentation; in fine, whether they are combined together in a just and orderly manner, so that no demonstrable propositions serve any where as *premisses*, unless they are conclusions of previous syllogisms. Now it is the business of logic, in explaining the several operations of the mind, fully to instruct us in all these points. It teaches the nature and end of definitions, and lays down the rules by which they ought to be framed. It unfolds the several species of propositions, and distinguishes the self-evident from the demonstrable. It delineates also the different forms of syllogisms, and explains the laws of argumentation proper to each. In fine, it describes the manner of combining syllogisms, so as that they may form a train of reasoning, and lead to the successive discovery of truth. The precepts of logic therefore, as they enable us to judge with certainty when a proposition is duly demonstrated, furnish a sure *critereon* for the distinguishing between truth and falsehood.

But perhaps it may be objected, that demonstration is a thing very rare and uncommon, as being the prerogative of but a few sciences, and therefore the *critereon* here given can be of no great use. But where ever, by the bare contemplation of our ideas, truth is discoverable, there also demonstration may be attained. Now that is an abundantly sufficient *critereon*, which enables us to judge with certainty in all cases where the knowledge of truth comes within our reach; for with discoveries, that lie beyond the limits of the human mind, we have properly no business. When a proposition is demonstrated, we are certain of its truth. When, on the contrary, our

ideas

ideas are such as have no visible connection nor repugnance, and therefore furnish not the proper means of tracing their agreement or disagreement, there we are sure that scientific knowledge is not attainable. But where there is some foundation of reasoning, which yet amounts not to the full evidence of demonstration, there the precepts of logic, by teaching us to determine aright of the degree of proof, and of what is still wanting to render it full and complete, enable us to make a due estimate of the measures of probability, and to proportion our assent to the grounds on which the proposition stands. And this is all we can possibly arrive at, or even so much as hope for, in the exercise of faculties so imperfect and limited as ours.

We conclude it may not be improper to take notice of the distinction of demonstration into *direct* and *indirect*. A *direct demonstration* is, when beginning with definitions, self-evident propositions, or known and allowed truths, we form a train of syllogisms, and combine them in an orderly manner, continuing the series through a variety of successive steps, until at last we arrive at a syllogism, whose conclusion is the proposition to be demonstrated. Proofs of this kind leave no doubt or uncertainty behind them, because all the several premisses being true, the conclusions must be so too, and of course the very last conclusion or proposition to be proved. The other species of demonstration is the *indirect*, or, as it is sometimes called, the *apagogical*. The manner of proceeding here is, by assuming a proposition which directly contradicts that we mean to demonstrate, and thence by a continued train of reasoning, in the way of a direct demonstration, deducing some absurdity or manifest untruth. For hereupon we conclude that the proposition assumed was false, and thence again, by an immediate consequence, that the proposition to be demonstrated is true. Thus *Euclid*, in his third book, being to demonstrate, *that circles which touch one another inwardly have not the same centre*; assumes the direct contrary to this, *viz. that they have the same centre*, and thence by an evident train of reasoning proves *that a part is equal to the whole*. That supposition therefore, leading to this absurdity, he concludes to be false, *viz. that circles touching one another inwardly have the same centre*, and thence again immediately infers *that they have not the same centre*.

Now because this manner of demonstration is accounted by some not altogether so clear and satisfactory, we shall therefore endeavour here to shew, that it equally with the other leads to truth and certainty. Two propositions are said to be *contradictory* one of another, when that which is asserted to be in the one is asserted not to be in the other. Thus the propositions, *circles that touch one another inwardly have the same centre*, and *circles that touch one another inwardly have not the same centre*, are *contradictories*; because the second asserts the direct contrary of what is asserted in the first. Now in all contradictory propositions this holds universally, that one of them is necessarily true, and the other necessarily false. For if it be true, that circles which touch one another inwardly have not the same centre, it is unavoidably false: that they have the same centre. On the other hand, if it be false that they have the same centre,

it is necessarily true that they have not the same centre. Since therefore it is impossible for them to be both true or both false at the same time, it unavoidably follows, that one is necessarily true, and the other necessarily false. This then being allowed, if any two contradictory propositions are assumed, and one of them can by a clear train of reasoning be demonstrated to be false, it necessarily follows that the other is true. For as the one is necessarily true, and the other necessarily false, when we come to discover which is the false proposition, we thereby also know the other to be true.

Now this is precisely the manner of an indirect demonstration. For there we assume a proposition, which directly contradicts that we mean to demonstrate, and having by a continued series of proofs shewn it to be false, thence infer that its contradictory, or the proposition to be demonstrated, is true. As therefore this last conclusion is certain and unavoidable, let us next inquire, after what manner we come to be satisfied of the falsehood of the assumed proposition, that so no possible doubt may remain as to the force and validity of demonstrations of this kind. The manner then is plainly this. Beginning with the assumed proposition, we, by the help of definitions, self-evident truths, or propositions already established, continue a series of reasoning in the way of a direct demonstration, until at length we arrive at some absurdity or known falsehood. Thus *Euclid*, from the supposition that circles touching one another inwardly have the same centre, deduces *that a part is equal to the whole*. Since therefore, by a due and orderly process of reasoning, we come at last to a false conclusion, it is manifest that all the premisses cannot be true. For were all the premisses true, the last conclusion must be so too. Now as to all the other premisses made use of in the course of reasoning, they are manifest and known truths by supposition, as being either definitions, self-evident propositions, or truths previously established. The assumed proposition is that only as to which any doubt or uncertainty remains. That alone therefore can be false, and indeed, from what has been already shewn, must unavoidably be so. And thus we see, that, in indirect demonstrations, two contradictory propositions being laid down, one of which is demonstrated to be false, the other, which is always the proposition to be proved, must necessarily be true; so that here, as well as in the direct way of proof, we arrive at a clear and satisfactory knowledge of truth.

This is universally the method of reasoning in all apagogical or indirect demonstrations; but if any proposition is assumed, from which in a direct train of reasoning we can deduce its contradictory, the proposition so assumed is false, and the contradictory one true. For if we suppose the assumed proposition to be true, then, since all the other premisses that enter the demonstration are also true, we shall have a series of reasoning, consisting wholly of true premisses; whence the last conclusion or contradictory of the assumed proposition must be true likewise. So that by this means we should have two contradictory propositions both true at the same time, which is manifestly impossible. The assumed proposition therefore, whence this absurdity flows, must necessarily be false, and consequently its contradictory, which is

here the proposition deduced from it, must be true. If then any proposition is proposed to be demonstrated, and we assume the contradictory of that proposition, and thence directly infer the proposition to be demonstrated, by this very means we know that the proposition so inferred is true. For since from an assumed proposition we have deduced its contradictory, we are thereby certain that the assumed proposition is false; and if so, then its contradictory, or that deduced from it, which in this case is the same with the proposition to be demonstrated, must be true.

We have a curious instance of this in the twelfth proposition of the ninth book of the elements. Euclid there proposes to demonstrate, that in any series of numbers, rising from unity in geometrical progression, all the prime numbers that measure the last term in the series will also measure the next after unity. In order to this, he assumes the contradictory of the proposition to be demonstrated, namely; that some prime number measuring the last term in the series, does not measure the next after unity; and thence, by a continued train of reasoning, proves, that it actually does measure it. Hereupon he concludes the assumed proposition to be false, and that which is deduced from it, or its contradictory, which is the very proposition he proposed to demonstrate, to be true. Now

that this is a just and conclusive way of reasoning, is abundantly manifest from what we have so clearly illustrated above.

Having thus sufficiently evinced the certainty of demonstration in all its branches, and shewn the rules by which we ought to proceed, in order to arrive at a just conclusion, according to the various ways of arguing made use of; it is needless to enter upon a particular consideration of those several species of false reasoning, which logicians distinguish by the name of *sophisms*. He that thoroughly understands the form and structure of a good argument, will of himself readily discern every deviation from it. And although *sophisms* have been divided into many classes, which are all called by sounding names, that therefore carry in them much appearance of learning; yet are the errors themselves so very palpable and obvious, that it is lost labour to write for a man capable of being misled by them. Here therefore we chuse to conclude this second part of logic, and shall in the next part give some account of *method*, which though inseparable from reasoning, is nevertheless always considered by logicians as a distinct operation of the mind; because its influence is not confined to the mere exercise of the reasoning faculty, but extends in some degree to all the transactions of the understanding.

### PART III. Of METHOD.

#### *Of method in general, and the division of it into analytic and synthetic.*

WE have now done with the two first operations of the mind, whose office it is to search after truth, and enlarge the bounds of human knowledge. There is yet a third, which regards the disposal and arrangement of our thoughts, when we endeavour so to put them together that their mutual connection and dependence may be clearly seen. This is what logicians call *method*, and place always the last in order in explaining the powers of the understanding; because it necessarily supposes a previous exercise of our other faculties, and some progress made in knowledge, before we can exert it in any extensive degree.

In this view it is plain, that we must be before-hand well acquainted with the truths we are to combine together; otherwise how could we discern their several connections and relations, or so dispose of them as their mutual dependence may require? But it often happens, that the understanding is employed, not in the arrangement and composition of known truths, but in the search and discovery of such as are unknown. And here the manner of proceeding is very different. We assemble at once our whole stock of knowledge relating to any subject; and, after a general survey of things, begin with examining them separately and by parts. Hence it comes to pass, that whereas, at our first setting out, we were acquainted only with some of the grand strokes and outlines of truth, by thus pursuing her through her several windings and recesses we gradually discover those more inward and finer touches whence she derives all her strength, symmetry, and beauty. And here it is, that when, by a narrow scrutiny into things, we have unravelled any part of know-

ledge, and traced it to its first and original principles, in so much that the whole frame and contexture of it lies open to the view of the mind; here it is, that taking it the contrary way, and beginning with these principles, we can so adjust and put together the parts, as the order and method of science requires.

But as these things are best understood when illustrated by examples: let us suppose any machine, for instance a watch, presented to us, whose structure and composition we are as yet unacquainted with, but want if possible to discover. The manner of proceeding in this case is, by taking the whole to pieces, and examining the parts separately one after another. When by such a scrutiny we have thoroughly informed ourselves of the frame and contexture of each, we then compare them together, in order to judge of their mutual action and influence. By this means we gradually trace out the inward make and composition of the whole, and come at length to discern, how parts of such a form, and so put together, as we found in unravelling and taking them asunder, constitute that particular machine called a watch, and contribute to all the several motions and phenomena observable in it. This discovery being made, we can take things the contrary way, and, beginning with the parts, so dispose and connect them, as their several uses and structures require, until at length we arrive at the whole itself, from the unravelling of which these parts related.

And as it is in tracing and examining the works of art, so is it in a great measure in unfolding any part of human knowledge. For the relations and mutual habitudes of things do not always immediately appear upon comparing them one with another. Hence we have recourse to intermediate ideas, and by means of them are furnished

with

with those previous propositions, that lead to the conclusion we are in quest of. And if it so happen, that the previous propositions themselves are not sufficiently evident, we endeavour by new middle terms to ascertain their truth, still tracing things backward in a continued series, until at length we arrive at some syllogism where the premises are first and self-evident principles. This done, we become perfectly satisfied as to the truth of all the conclusions we have passed through, in as much as they are now seen to stand upon the firm and immovable foundation of our intuitive perceptions. And as we arrived at this certainty by tracing things backward to the original principles whence they flow, so may we at any time renew it by a direct contrary process, if, beginning with these principles, we carry the train of our thoughts forward, until they lead us by a connected chain of proofs to the very last conclusion of the series.

Hence it appears, that in disposing and putting together our thoughts, either for our own use, that the discoveries we have made may at all times lie open to the review of the mind, or where we mean to communicate and unfold these discoveries to others, there are two ways of proceeding equally within our choice. For we may so propose the truths relating to any part of knowledge, as they presented themselves to the mind in the manner of investigation, carrying on the series of proofs in a reverse order, until they at last terminate in first principles: or, beginning with these principles, we may take the contrary way, and from them deduce, by a direct train of reasoning, all the several propositions we want to establish. This diversity in the manner of arranging our thoughts gives rise to the twofold division of method established among logicians. For method, according to their use of the word, is nothing else but the order and disposition of our thoughts relating to any subject. When truths are so proposed and put together, as they were or might have been discovered, this is called the *analytick method*, or the *method of resolution*; in as much as it traces things backward to their source, and *resolves* knowledge into its first and original principles. When, on the other hand, they are deduced from these principles, and connected according to their mutual dependence, inasmuch that the truths first in order tend always to the demonstration of those that follow,

this constitutes what we call the *synthetick method*, or *method of composition*; for here we proceed by gathering together the several scattered parts of knowledge, and combining them into one whole system, in such manner, that the understanding is enabled distinctly to follow truth through all her different stages and gradations.

There is this farther to be taken notice of, in relation to these two species of method; that the first has also obtained the name of the *method of invention*, because it observes the order in which our thoughts succeed one another in the *invention* or discovery of truth. The other again is often denominated the *method of doctrine* or *instruction*; in as much as, in laying our thoughts before others, we generally chuse to proceed in the *synthetick* manner, deducing them from their first principles. For we are to observe, that although there is great pleasure in pursuing truth in the method of investigation, because it places us in the condition of the inventor, and shews the particular train and process of thinking by which he arrived at his discoveries; yet is it not so well accommodated to the purposes of evidence and conviction. For at our first setting out, we are commonly unable to divine where the analysis will lead us, inasmuch that our researches are for some time little better than a mere groping the dark. And even after light begins to break in upon us, we are still obliged to many reviews, and a frequent comparison of the several steps of the investigation among themselves. Nay, when we have unravelled the whole, and reached the very foundation on which our discoveries stand, all our certainty in regard to their truth will be found in a great measure to arise from that connection we are now able to discern between them and first principles taken in the order of composition. But in the synthetick manner of disposing our thoughts, the case is quite different. For as we here begin with intuitive truths, and advance by regular deductions from them, every step of the procedure brings evidence and conviction along with it; so that in our progress from one part of knowledge to another, we have always a clear perception of the ground on which our assent rests. In communicating therefore our discoveries to others, this method is apparently to be chosen, as it wonderfully improves and enlightens the understanding, and leads to an immediate perception of truth.

## L O L

**LOHOCH**, or **ЛОСН**, in pharmacy, a composition of a middle consistence between a soft electuary and a syrup, principally used in disorders of the lungs.

There are several kinds of lohochs, denominated from the principal ingredient that enters into their composition. The common lohoch is made thus: take of fresh-drawn oil of sweet almonds, and of pectoral or balsamic syrup, one ounce; white-sugar, two drams: mix, and make them into a lohoch.

**LOINS**, in anatomy, the two lateral parts of the umbilical region of the abdomen. See **ANATOMY**.

**LOIRE**, the largest river in France, rises in the mountains of the Cevennes, and, after running a course of about five hundred miles, falls into the bay of Biscay.

**LOLIUM**, **DARNEL**, in botany, a genus of the triandria.

## L O N

digynia class. The involucre consists of one leaf; it has no calix; and the stipula consists of many flowers. There are three species, two of them natives of Britain, viz. the perenne, or perennial darnel-grass; and the temulentum, or annual darnel-grass.

**LOMBARDY**, a kingdom which comprehended almost all Italy. It was erected by the Longobards, or Lombards, a German nation, about the year 598, and lasted till Charlemain put an end to it about the year 760.

**LOMOND**, a lake in the county of Lenox, in Scotland, which runs almost the whole length of the county.

**LONCHITIS**, **SPLEEN-WORT**, in botany, a genus of the cryptogamia filicum class of plants, the fructifications of which are arranged into lunulated series, and disposed separately under the sinuses of the leaves.

There.

There are four species, none of them natives of Britain.

**LONDON**, the metropolis of Great Britain, where the first meridian is fixed on the British maps, lies in  $51^{\circ} 32'$  N. lat. on the river Thames, and the greatest part on the north-side of that river. The form of London, including Westminster and Southwark, comes pretty near an oblong square, five miles in length, if measured in a direct line from Hyde-Park to the end of Limehouse, and six miles if we follow the windings of the streets; the greatest breadth is two miles and a half, and the circumference of the whole sixteen or seventeen miles, but it is not easy to measure it exactly, on account of its irregular form. The principal streets are generally level, exceeding well built, and extended to a very great length; these are inhabited by tradesmen, whose houses and shops make a much better figure than those of any tradesmen in Europe. People of distinction usually reside in elegant squares, of which there are great numbers at the west end of the town near the court. What mostly contributes to the riches and glory of this city, is the port, whither several thousand ships of burden annually resort from all countries, and where the greatest fleets never fail to meet with wealthy merchants ready to take off the richest cargoes. The number of persons in the whole place are computed to be about eight hundred thousand.

**LONDONDERRY**, a city of Ireland, in the province of Ulster, and county of Londonderry, situated on the river Mourne, near its mouth, in W. long.  $7^{\circ} 40'$ , N. lat.  $54^{\circ} 52'$ .

**LONG**, an epithet given to whatever exceeds the usual standard of length; thus, we say a long-boat, long accent, &c.

**LONGÆVITY**, length of life.

Lord Bacon observes, that the succession of ages, and of the generation of men, seems no way to shorten the length of human life, since the age of man, down from Moses's time to the present, has stood at about eighty years, without gradually declining, as one might have expected. The greatest instances of longævity in these our islands, are that of old Parr, who lived almost 153 years; of Jenkyns, of Yorkshire, who lived 169 years; or of the countess Desmond, or Mr Eccleston, both of Ireland, who each exceeded 140 years.

**LONGFORD**, a county of Ireland, in the province of Leinster, bounded by the county of Leitrim and Cavan on the north, by Meath on the east and south, and by Roscommon on the west.

**LONG-ISLAND**, an island belonging to New-York in North America, lying between  $71^{\circ}$  and  $74^{\circ}$  W. long. and in  $41^{\circ} 30'$  N. lat.

**LONGIMETRY**, the art of measuring lengths, both accessible and inaccessible. See **GEOMETRY**.

**LONGINICO**, a town of the Morea, in Europe, situated on the river Alpheus, fifty miles south of Lepanto: being the ancient Olympia, where Hercules instituted the Olympic games.

**LONGISSIMUS DORSI**, in anatomy. See **ANATOMY**, p. 218.

**LONGITUDE of a star**, in astronomy, an arch of the ecliptic, intercepted between the beginning of aries, and the point of the ecliptic cut by the star's circle of longitude.

**LONGITUDE of a place**. See **GEOGRAPHY**.

In the philosophical transactions, n<sup>o</sup> 1, we have an account of a successful experiment in finding the longitude at sea, made with two pendulum-watches by major Holmes, in a voyage from the coast of Guinea homewards. This and some other successes encouraged Monsieur Huygens so far, that, after he had improved the structure of these watches, he published an account at large for the shewing how and in what manner these watches are to be used in finding the longitude at sea, with directions for adjusting of them and keeping a journal by them; which account the curious reader may see at large in the Philosophical transactions, n<sup>o</sup> 47.

The chief objection against pendulum-clocks and watches, is the effects that heat and cold have upon the spring and pendulum, which make the spring in watches draw stronger at some times than at other times, and causes the pendulum to lengthen and shorten, according as the weather is hotter or colder; but these effects are so regular, that without doubt they may be accounted for.

But the most ingenious and successful machines for this purpose have been invented by Mr. John Harrison, who, at different times, contrived three different time-pieces for determining the longitude at sea.

The first of Mr. Harrison's machines was tried in May 1736, when it was put on board a man of war; and by its exact measure of time, in its return from Lisbon, corrected an error of almost a degree and an half in the computations of the reckoning of a ship. In 1739, Mr. Harrison finished his second machine, which, from various experiments made upon it, was sufficiently regular and exact for finding the longitude of a ship within the nearest limits proposed by parliament. Upon the success of this, Mr. Harrison, in 1741, undertook still a more advantageous machine, which he finished in 1758, when he applied to the commissioners of longitude for orders to make a trial of that instrument to some part in the West Indies, as directed by the statutes for the discovery of the longitude at sea. In consequence of this application, Mr. Harrison received orders for his son to proceed from Portsmouth to Jamaica, in one of his majesty's ships of war, with his third instrument, in November 1761; and the commissioners having directed that every requisite step and precaution should be taken, for making, with care, the proper experiments, and ascertaining their accuracy, not only going to Jamaica, but in the return, it appears, from the calculations made from the experiments in going to Jamaica, that the difference between the longitude, as found by the time-piece, and calculated by the observations of the transit of mercury in 1743 at Jamaica and London, is five seconds of time, which at Jamaica is little more than a geographical mile.

During the voyage, Mr. Harrison's time-piece corrected the ship's reckoning, which sometimes erred about a degree and a half: and in going from Madeira

to Jamaica, it also corrected the errors of the log, and shewed the longitude so exactly, that the ship made the island of Descada, and all the other islands, until they arrived at Jamaica, as foretold by the time-piece. At the arrival at Jamaica, the observations for finding the time were made by equal altitudes; and the longitude shewn by the time-piece, being within 5" of time of the longitude shewn by the most accurate observations of mercury in its transit over the sun in the year 1743, and with which all the observations at London and Paris agreeing within 23", amounts to a demonstration, that Mr. Harrison has performed all that is required by the statute of the 12th of queen Anne, to entitle him to the greatest reward mentioned in that act. In returning from Jamaica, the weather was very tempestuous, so that the time piece was forced to be placed on the counter, to avoid being perpetually exposed to the sea water; there it suffered continual violent agitations, which, though they necessarily retarded its motion, yet d'd not occasion any such considerable error, as would have made Mr. Harrison's right to the greatest reward questionable, had it depended on this voyage only; for the time-keeper, in its going and return, lost only 1' 54" and  $\frac{1}{2}$ ; which, in the latitude of Portsmouth, amounts to about eighteen geographical miles or minutes of a great circle, whereas the act required only that it should come within the distance of thirty geographical miles or minutes of a great circle.

**LONGITUDINAL**, in general, denotes something placed lengthwise; thus some of the fibres of the vessels in the human body are placed longitudinally, others transversely or across.

**LONGUEVILLE**, a town of Normandy in France, twenty miles north of Rouen: E. long. 1° 10'. N. lat. 49° 50'

**LONICERA**, in botany, a genus of the pentandria monogynia class. The corolla consists of one irregular petal: and the berry of two cells containing many seeds. There are 13 species, only one of which, viz. the periclymenum, or common honey-suckle, is a native of Britain.

**LOOF**, in the sea language, is a term used in various senses: thus, the loof of a ship is that part of her aloft, which lies just before the chest tree; hence the guns which lie there are called loof-pieces: keep your loof, signifies, keep the ship near to the wind; to loof into a harbour, is to sail into it close by the wind; loof up, is to keep nearer the wind; to spring the loof, is when a ship that was going large before the wind, is brought close by the wind.

**LOOKING-GLASSES**, are nothing but plain mirrors of glass; which being impervious to the light, reflect the images of things placed before them; for the theory whereof, see **OPTICS**.

**LOOM**, a frame composed of a variety of parts, used in all the branches of weaving. See **WEAVING**.

**LOOSING** of arrestment, in Scots law. See **LAW**, Tit. xxv. 6.

**LOPIIUS**, in zoology, a genus of the branchiostegious order of fishes, whose head is in size equal to all the rest of the body: the head and body are both of a de-

pressed form: there are a number of fleshy pinnules or appendages surrounding the whole body of the fish. There are three species.

**LORANTHUS**, in botany, a genus of the hexandria monogynia class. The margin of the calix is entire; the corolla consists of six segments folded backwards; and the berry contains one seed. There are five species, none of them natives of Britain.

**LORD**, a title of honour, given to those who are noble, either by birth or creation; in this sense it amounts to much the same as peer of the realm, or lord of Parliament. This title is, by courtesy, also given to all the sons of dukes and marquises, and to the eldest sons of earls; and it is also a title of honour bestowed on those who are honourable by their employments, as lord advocate, lord chamberlain, lord chancellor, &c.

**LORETTO**, a city of Italy, in the marquisate of Ancona, in the pope's territories, 145 miles east of Rome. This place is famous for the chamber of the blessed Virgin, which, according to the Roman catholic tradition, was brought by angels from Palestine to Dalmatia, and from thence transported over into Italy, and fixed at Loretto.

**LORN**, the north part of Argyleshire in Scotland, bounded by Lochabar on the north, by Broadalbin on the east, by the rest of Argyleshire on the south, and by the sea on the west.

**LORRAIN**, a duchy formerly belonging to the circle of the Upper Rhine in Germany, but now united to the crown of France. It is bounded by the duchy of Luxemburg on the north; by Alsatia, the duchy of Deux ponts, and the palatinate of the Rhine, on the east; by the county of Burgundy, on the south; and by Champaign, on the west.

**LOTHIAN**, a county of Scotland, bounded by the frith of Forth on the north; by the German sea, on the east; by Clydesdale, Tweedale, and Merse, on the south; and by Stirling, on the west. The capital of this county is Edinburgh.

**LOTION** is, strictly speaking, such washing as concerns beautifying the skin, by cleansing it of those deformities which a distempered blood sometimes throws upon it, or rather are made by a preternatural secretion: for according to Quincy, generally those distempers of the skin, commonly accounted signs of a foul blood, are, from those salts which are natural in the best constitution, thrown off by the cutaneous glands, which ought to be washed away through the kidney; so that instead of those insignificant and ridiculous tribes of sweeteners, which in this case are frequently used, promoting the urinary discharge, or rectifying that of the skin by proper washes, frictions, or ointments, or both together, is the only way to get rid of such disorders.

**LOTTERY**, a kind of public game at hazard, frequent in Britain, France, and Holland, in order to raise money for the service of the state; being appointed with us by the authority of parliament, and managed by commissioners appointed by the lords of the treasury for that purpose. It consists of several numbers of blanks and prizes, which are drawn out of wheels, one



- of which contains the numbers, and the other the corresponding blanks or prizes.
- LOTUS**, in botany, a genus of the diadelphia decandria class. The legumen is cylindrical; the wings are connivent above; and the calix is tubular. There are 17 species, only one of which, *viz.* the *corniculata*, or birds-foot trefoil, is a native of Britain.
- LOVAGE**, in botany. See **LIGUSTICUM**.
- LOVE APPLE**. See **SOLANUM**.
- LOUIS**, or *Knights of St. Louis*, the name of a military order in France, instituted by Louis XIV. in 1693. Their collars are of a flame colour, and pass from left to right; the king is their grand master. There are in it eight great crosses, and twenty four commanders; the number of knights is not limited. At the time of their institution, the king charged his revenue with a fund of three hundred thousand livres for the pensions of the commanders and knights.
- LOUISIANA**, or *New France*, a country of north America, bounded by the river and lake of Illinois on the north, North Carolina on the east, and the gulph of Mexico on the south.
- LOUSE**, in zoology. See **PEDICULUS**.
- LOUTH**, a county of Ireland, in the province of Leinster, bounded by Monaghan and Armagh on the north, by the Irish Channel on the east, by East Meath on the south; and by Cavan on the west.
- LOUVAIN**, a city of the Austrian Netherlands, in the province of Brabant, situated on the river Dyle, fifteen miles north-east of Brussels.
- LOWERING**, among distillers, a term used to express the debasing the strength of any spiritous liquors, by mixing water with it.
- LOXIA**, in zoology, the name of a genus of birds of the order of the passerines; the distinguishing characters of which are, that the tongue is plain, equal and whole; the beak large, thick, and short, and crooked and convex both ways. There are 48 species, principally distinguished by their colour.
- LOZENGE**, in heraldry, a rhombus, or figure of equal sides, but unequal angles, resembling a quarry of glass in our old windows, placed erect, point ways. It is in this figure that all unmarried gentlewomen and widows bear their coats of arms, because, as some say, it was the figure of the Amazonian shield; or, as others, because it is the ancient figure of the spindle. Plate CIII. fig. 8. represents an ordinary of lozenges.
- The lozenge differs from the fusil, in that the latter is narrower in the middle, and not so sharp at the ends.
- LUBEC**, a city and port-town of Germany, in the circle of Lower Saxony, and duchy of Holstein, situated ten miles south-west of the Baltic sea: E. long. 10° 35', N. lat. 54° 20'.
- LUBEN**, a town of Germany, in the circle of Upper Saxony, and marquisate of Lusatia: E. long. 14° 25', N. lat. 52°.
- LUBLIN**, a city of Poland, in the palatinate of the same name: E. long. 22° 15', N. lat. 51° 30'.
- LUBOW**, a town of Poland, in the palatinate of Cracow: E. long. 20° 30', N. lat. 49° 30'.
- LUC**, a town of Provence, in France, twenty-three miles north-east of Toulon.
- LUCAR**, or *St. Lucar*, a port-town of Spain, in the province of Andalusia: W. long. 6° 38', N. lat. 36° 42'. *St. Lucar* is also a town of Andalusia, in Spain: W. long. 8° 12', N. lat. 37° 20'. *St. Lucar* is also the name of another town of Spain, fifteen miles west of Seville.
- LUCARNO**, a town of the duchy of Milan, situated on the lake of Maggiore, but subject to Switzerland.
- LUCCA**, the capital of the republic of the same name in Italy, situated twelve miles east of the Tuscan sea: E. long. 11° 20', N. lat. 43° 45'.
- LUCERN**, the capital of the canton of the same name in Switzerland, situated on the lake Lucern, to which it gives its name: E. long. 8° 12', N. lat. 47°.
- LUCERNE**, in botany. See **MEDICAGO**. For the culture of lucerne, see **AGRICULTURE**. p. 65.
- LUCIA ISLANDS**, one of the Caribbee islands in America, situated seventy miles north-west of Barbadoes, being twenty-two miles long, and eleven broad.
- St. Lucia*, one of the Cape Verd islands in Africa, lying in W. long. 25°, N. lat. 16° 30'.
- LUCIOPERCA**, in ichthyology. See **PERCA**.
- LUCIUS**, in ichthyology. See **ESOX**.
- LUCONIA**, or *Manilla*, the chief of the Philippine islands, situated between 117° and 123° E. long. and between 12° and 19° of N. lat.
- LUDLOW**, a borough of Shropshire, situated on the river Corve; eighteen miles south of Shrewsbury. It sends two members to parliament.
- LUDWIGIA**, in botany, a genus of the tetrandria monogynia class. The corolla consists of four petals, and the calix of four segments; the capsule has four sides and four cells, with many seeds. There are two species, none of them natives of Britain.
- LUES**, among physicians, is, in general, used for a disease of any kind; but, in a more particular sense, is restrained to contagious and pestilential diseases: thus, the *lues gallica*, or *venerea*, signifies the venereal disease. See **MEDICINE**.
- LUGGERSHAL**, a borough-town, ten miles north of Salisbury. It sends two members to parliament.
- LUGO**, a city and bishop's see of Spain, sixty miles east of Compostella: W. long. 7° 50', and N. lat. 43° 5'.
- LUKE**, or *gospel of St. Luke*, a canonical book of the New Testament.
- Some think it was properly St. Paul's gospel, and that when that apostle speaks of his gospel, he means what is called St. Luke's. Irenaeus says, that St. Luke digested into writing what St. Paul preached to the Gentiles; and Gregory Nazianzen tells us, that St. Luke wrote with the assistance of St. Paul.
- St. Luke the evangelist's day*, a festival in the Christian church, observed on the 18th of October.
- LULA LAPMARK**, a province of Sweden, bounded on the north by that of Torne; on the east, by the Bothnic gulph; on the south, by Pithia-lapmark; and on the west, by Norway.

LUMBAGO,

- LUMBAGO**, in medicine, denotes a pain about the loins, as that preceding fevers, agues, and the rheumatism.
- LUMBARIS**, a name given to the arteries and veins which spread over the loins. See **ANATOMY**.
- LUMBRICAL**, a name given to four muscles of the fingers, and to as many of the toes. See **ANATOMY**, part II.
- LUMBRICUS**, the **EARTH-WORM**, in zoology, a genus of insects belonging to the order of vermes intestinalia. The body is cylindrical, annulated, with an elevated belt near the middle. There is but one species of this animal. It lives under ground, and feeds upon the seeds and roots of plants. It comes above ground in the night, or during rain, for the purpose of copulation. For the effects of these animals in the human body, and the method of expelling them, see **MEDICINE**.
- LUMME**, in ornithology. See **COLYMBUS**.
- LUMP-FISH**. See **CYCLOPTERUS**.
- LUNA**, in astronomy, the moon. See **ASTRONOMY**.
- LUNAR**, something belonging to the moon; thus we say, lunar month, lunar year, &c.
- LUNARIA**, **HONESTY**, in botany, a genus of the tetradynamia siliculosa class. The silicula, or pod, is entire, elliptical, and compressed; with plain, equal, parallel valves. There are two species, none of them natives of Britain.
- LUNATIC**, a person affected with lunacy. See **MEDICINE**.
- LUND**, or **LUNDEW**, a city of Sweden, in the province of Gothland, the capital of the territory of Schonon, situated thirty miles east of Copenhagen.
- LUNDY**, a little island in the mouth of the Bristol-channel: W. long.  $4^{\circ} 50'$ , N. lat.  $51^{\circ} 25'$ .
- LUNENBURG**, the capital of the duchy of the same name, thirty miles south-east of Hamburg: E. long.  $10^{\circ} 20'$ , N. lat.  $53^{\circ} 35'$ .
- LUNGS**. See **ANATOMY**, p. 280.
- LUNG-WORT**, in botany. See **PULMONARIA**.
- LUNISOLAR YEAR**, in chronology, the space of 532 common years; found by multiplying the cycle of the sun by that of the moon.
- LUNULA**, in geometry, a plane figure like a crescent or half moon.
- LUPERCALIA**, a festival of the ancient Romans in honour of the god Pan, observed on the 15th of February, and so called from luperci, the priests of that fabulous deity.
- LUPINUS**, in botany a genus of the diadelphia decandria class. The calix consists of two lips; five of the antheræ are oblong, and the other five round; and the pod is coreaceous. There are seven species, none of them natives of Britain.
- LUPULUS**, in botany, &c. See **HUMULUS**.
- LUPUS**, in zoology. See **CANIS**.
- LUPUS MARINUS**. See **ANARRICHAS**.
- LUPUS**, in astronomy. See **ASTRONOMY**, p. 487.
- LURE**, in falconry, a device of leather, in the form of a bird, with two wings stuck with feathers, and baited with a piece of fish; wherewith to reclaim or call back a hawk, when at a considerable distance.
- LUSATIA**, a marquisate of Upper Saxony, bounded by Brandenburg, on the north; by Silesia, on the east; by Bohemia, on the south; and by the duchy of Saxony, on the west: it is subject to the king of Poland.
- LUSTRATION**, in antiquity, sacrifices or ceremonies by which the ancients purified their cities, fields, armies, or people, defiled by any crime or impurity.
- Some of these lustrations were public, others private. There were three species or manners of performing lustration, viz. by fire and sulphur, by water, and by air; which last was done by fanning and agitating the air round the thing to be purified. Some of these lustrations were necessary, that is, could not be dispensed with, as lustrations of houses in time of a plague, or upon the death of any person; others again were done out of choice, and at pleasure. The public lustrations at Rome were celebrated every fifth year, in which they led a victim thrice round the place to be purified, and in the mean time burnt a great quantity of perfumes.
- LUSTRE**, the gloss or brightness appearing on any thing, particularly on manufactures of silk, wool, or stuff. It is likewise used to denote the composition or manner of giving that gloss.
- The lustre of silks is given them by washing in soap, then clear water, and dipping them in alum water cold. To give stuffs a beautiful lustre, for every eight pounds of stuff allow a quarter of a pound of linseed; boil it half an hour, and then strain it through a cloth, and let it stand till it is turned almost to a jelly: afterwards put an ounce and a half of gum to dissolve twenty four hours; then mix the liquor, and put the cloth into this mixture; take it out, dry it in the shade, and press it. If once doing is not sufficient, repeat the operation. Curriers give a lustre to black leather first with juice of bar-berries, then with gum arabic, ale, vinegar, and flanders-glue, boiled together. For coloured leather, they use the white of an egg beaten in water. Moroccoes have their lustre from juice of bar-berries and lemon or orange. For hats, the lustre is frequently given with common water, sometimes a little black dye is added: the same lustre serves for furs, except that for very black furs they sometimes prepare a lustre of galls, copperas, Roman alum, ox's marrow, and other ingredients.
- LUSTRUM**, in Roman antiquity, a general muster and review of all the citizens and their goods, which was performed by the censors every fifth year, who afterwards made a solemn lustration. See **LUSTRATION**.
- LUTE**, or **LUTING**, among chemists. See **CHEMISTRY**, p. 116.
- LUTE**, is also a musical instrument with strings.
- The lute consists of four parts, viz. the table; the body or belly, which has nine or ten sides; the neck, which has nine or ten stops or divisions, marked with strings; and the head, or cross, where the screw for raising and lowering the strings to a proper pitch of tone are fixed. In the middle of the table there is a rose or passage for the sound; there is also a bridge that the strings are fastened to, and a piece of ivory between

between the head and the neck to which the other extremities of the strings are fitted. In playing, the strings are struck with the right hand, and with the left the stops are pressed. The lutes of Bologna are esteemed the best, on account of the wood, which is said to have an uncommon disposition for producing a sweet sound.

**LUTHERANS**, the Christians who follow the opinions of Martin Luther, one of the principal reformers of the church in the sixteenth century.

This sect took its rise from the distaste taken at the indulgences which were granted in 1517, by pope Leo X. to those who contributed towards finishing St. Peter's church at Rome. John Stupitze, vicar general of the Augustines in Germany, was the first who took occasion to declare against these abuses, for which purpose he made use of Martin Luther, the most learned of all the Augustines. Luther was a native of Eisleben, in the county of Mansfield in Saxony, and taught divinity at the university of Wirtemberg; he mounted the pulpit, and declaimed vehemently against the abuse of indulgences, and even fixed ninety-five propositions upon the church doors of Wirtemberg, in order to their being considered and examined in a public conference: against these John Tetzel, a Dominican, published a hundred and six positions at Francfort upon the Oder; and by virtue of his office of inquisitor, ordered those of Luther to be burnt; when his adherents, to revenge the affront, publicly burnt at Wirtemberg those of Tetzel. Thus war was declared between the Dominicans and Augustines, and soon after between the Roman catholic and the Lutheran party. In 1520, Luther sent his book *De Libertate Christiana*, to the pope; in which he grounds justification upon faith alone, without the assistance of good works; and asserts, that Christian liberty rescues us from the bondage of human traditions, and particularly the slavery of papal impositions; and afterwards, in a remonstrance written in high Dutch, he proceeded to deny the authority of the church of Rome. He was the same year excommunicated by the pope; upon which Luther causing a large fire to be made without the walls of Wirtemberg, threw the pope's bull into it with his own hands, together with the decretals, extravagants, and clementines; and this example was followed by his disciples in other towns. The next year the emperor Charles V. ordered his books to be burnt, and put him under the ban of the empire as a heretic and schismatic; and about this time king Henry VIII. of England wrote against him in defence of the seven sacraments, to which Luther wrote a reply.

The elector of Saxony, who had for some time kept him concealed in his castle of Wesburg, now gave him leave to reform the churches of Wirtemberg as he thought fit; when this reformer proposed, that the bishops, abbots, and monks, should be expelled; that all the lands and revenues of the bishoprics, abbeyes, and monasteries, should escheat to the respective princes; and that all the convents of mendicant friars should be turned into public schools and hospitals: this year, Luther had the satisfaction to see a league contracted

between Gustavus king of Sweden, and Frederick king of Denmark, who both agreed to establish Lutheranism in their dominions: and now Luther's persuasion, which from the Upper Saxony had spread into the northern provinces, began to be perfectly settled in the duchies of Lunenburgh, Brunswick, Mecklenburgh, and Pomerania, and in the archbishoprics of Magdeburgh and Bremen; in the towns of Hamburg, Wismar, Rostock, and along the Baltic as far as Livonia and Prussia. Luther maintained the doctrine of consubstantiation; and at a general diet at Ratibon for reconciling both parties, the divines could agree to no more than five or six articles concerning justification, free-will, original sin, baptism, good works, and episcopacy.

**LUTHERN**, in architecture, a kind of window over the cornice, in the roof of a building; standing perpendicularly over the naked of a wall, and serving to illuminate the upper story.

Lutherns are of various forms, as square, semi-circular, round, called bulls-eyes, flat arches, &c.

**LUTON**, a market town, fourteen miles south of Bedford.

**LUTRA**, in zoology. See **MUSTELA**.

**LUXATION**, in surgery, is when any bone is moved out of its place, or articulation, so as to impede or destroy its proper motion or office. See **SURGERY**.

**LUXEMBURG**, the capital of the duchy of the same name, situated an hundred miles south east of Brussels, is a small but strong fortress: E. long. 6° 8', N. lat. 49° 45'.

**LYBIA**, a name anciently given to all the coast of Barbary, especially that part lying westward of Egypt.

**LYCEUM**, in Grecian antiquity, an academy situated upon the banks of the Ilissus at Athens. It was composed of porticoes and walks, where Aristotle taught philosophy; walking there constantly every day till the hour of anointing, whence he and his followers were called peripatetics.

**LYCHNIS**, in botany, a genus of the decandria pentagynia class. The calix consists of one oblong smooth leaf, and the corolla of five unguiculated petals, with a bifid limb; and the capsule has three cells. There are seven species, three of them natives of Britain, viz. the flos cuculi, meadow-pinks, or cuckow-flower; the viscaria, or red German catchfly; and the dioica, or white campion.

**LYCIUM**, in botany, a genus of the pentandria monogynia class. The corolla is tubular, the faux being shut up by the beard of the filaments; and the berry has two cells. There are three species, none of them natives of Britain.

**LYCODONTES**, in natural history, the petrified teeth of the lupus-piscis, or wolf-fish, frequently found fossil. They are of different shapes; but the most common kind rise into a semiorbicular form, and are hollow within, somewhat resembling an acorn-cup: this hollow is found sometimes empty, and sometimes filled with the stratum in which it is immersed. Many of them have an outer circle, of a different colour from the rest.

**LYCO-**

**LYCOPERDON**, in botany, a genus of the cryptogamia fungi class: It is roundish, and replete with farinaceous seeds. There are ten species, six of them natives of Britain, *viz.* the tuber, or solid puff-ball; the certinum, or branny puff-ball; the bovista, or common puff-ball; the stellatum, or star puff-ball; the fornicatum, or turret puff-ball; and the pedunculatum, or stalked puff-ball.

**LYCOPodium**, in botany, a genus of the cryptogamia musci class. The anthera is double-valved, and sessile; the calyptra is wanting. There are 24 species, of which six are natives of Britain, *viz.* the clavatum, or common club moss; the inundatum, or marsh club-moss; the annotinum, or Welsh club-moss; the alpinum, or mountain club-moss; the selago, or firr club-moss; and the selaginoides, or prickly club-moss.

**LYCOPSIS**, in botany, a genus of the pentandria monogynia class. The tube of the corolla is incurved. There are seven species, only one of which, *viz.* the arvensis, or small wild buglass, is a native of Britain.

**LYCOPUS**, in botany, a genus of the diandria monogynia class. The corolla consists of four segments, one of them emarginated; the stamina are distant; and there are four seeds. There are two species; only one of them, *viz.* the europæus, or water-horehound, is a native of Britain.

**LYDIA**, an ancient province of lesser Asia, in which was the city of Philadelphia.

**LYGEUM**, in botany, a genus of the triandria monogynia class. The spatha consists of one leaf; there are two corollæ above the same germen; and the nut has two cells. There is but one species, a native of Spain.

**LYING-IN WOMEN.** See MIDWIFERY.

**LYME**, a borough and port-town of Dorsetshire, E. long.  $3^{\circ} 5'$ , and N. lat.  $50^{\circ} 44'$ .

It sends two members to parliament.

**LYMPH**, a fine fluid, separated in the body from the mass of blood, and contained in peculiar vessels.

Dr Keil says, that the lymph being chemically examined, will be found to contain a great deal of volatile, but no fixed salt, some phlegm, some sulphur, and a little earth. The use of the lymph, he observes, may be gathered from the consideration of the parts into which it discharges itself: that which comes from the head, neck and arms, is thrown into the jugular and subclavian veins; all the lymphatics which the parts

in the cavity of the thorax send out, empty themselves into the thoracic duct; and the lymph from all the rest of the body, flows to the receptacle of the chyle; so that there can be no doubt but its chief use is to dilute and perfect the chyle before it mixes with the blood. See ANATOMY, Part III.

**LYMPHATIUS**, in anatomy. See ANATOMY, p. 308.

**LYNN-REGIS**, a port-town of Norfolk, situated at the mouth of the river Ouse, on a bay of the German sea, thirty-two miles west of Norwich.

It sends two members to parliament.

**LYNX**, in zoology. See FELIS.

**LYONS**, the capital of the Lyonois, a province of France, bounded by Orleanois and Burgundy on the north, by la Bresse and Dauphine on the east, by Languedoc and Guienne on the south, and by another part of Guienne and Orleanois on the west. This city lies upon the confluence of the rivers Rhone and Soan, in E. lon.  $4^{\circ} 55'$ , and N. lat.  $5^{\circ} 50'$ . Next to Paris, it is esteemed the place of greatest trade in France.

**LYRA**, in ichthyology. See CALLYONIMUS.

**LYRE**, a musical instrument of the string-kind, much used by the ancients.

**LYRE**, in astronomy. See ASTRONOMY, p. 486.

**LYRIC**, in general, signifies something sung or played on the lyre: but it is more particularly applied to the ancient odes and stanzas, answering to our airs and songs, and may be played on instruments. This species of poetry was originally employed in celebrating the praises of gods and heroes, though it was afterwards introduced into feasts and public diversions.

**LYSIMACHIA**, in botany, a genus of the pentandria monogynia class. The calix is rotated; and the capsule is roundish, with a sharp point, and contains ten valves. There are eleven species, five of them natives of Britain, *viz.* the vulgaris, or yellow willow-herb; the thirsiflora, or tufted loose-strife; the nemorum, or yellow pimpermell of the woods; the nummularia, or money-wort; and the tenella, or purple money-wort.

**LYTHRUM**, in botany, a genus of the dodecandria monogynia class. The calix consists of twelve segments, and the corolla of six petals inserted into the calix; and the capsule has two cells, and many seeds. There are ten species, two of them natives of Britain, *viz.* the salicaria, or purple spiked loose-strife; and the hyssopifolia, or small hedge-hyssop.

# E R R A T A.

- End of the article CATASTROPHE. For *See* EPIC and DRAMATIC compositions, read, *See* COMPOSITION.
- CHEVRON. Read Plate LXV.
- CIRCUMDUCTION. For *addigamus*, read *alledge-ances*;—and for *Pobation*, read *Probation*.
- DECLINATURE of judges. For *legal obligation*, read *legal objection*.
- Page 424. column 2. line 39. For *fig. 31.* read *fig. 3.*
- P. 425. col. 1. In paragr. 4. there should have been a reference to *fig. 6.*—N. B. In any Treatise, or long article, illustrated by plates, when a figure is referred to without repeating the N<sup>o</sup> of the plate, let it be understood that the plate last mentioned is meant.
- P. 426. col. 1. l. 35. For *fig. 9.* read *fig. 3.*—N. B. Fol. 425 & 426 are, by oversight, twice repeated.
- P. 429. col. 1. l. 41. For *Fig. 5.* read *Fig. 3.*
- P. 437. col. 2. l. 12. For *gait*, read *gate*.
- DIODON. Omitted the reference to the figure, *viz.* Plate LXVIII. *fig. 4.*
- DIPONDIUS. For *two sparrows*, read *five sparrows*.
- DRACO. Omitted to refer to Plate LXVIII. *fig. 5.*
- ECHENEIS. Omitted to refer to Plate LXXIV. *fig. 4.*
- P. 477. col. 1. l. 43. For *Plate LXXV.* read *Plate LXXIV.*
- P. 616 col. 1. l. *ult.* Read *Plate LXXX. fig. 3.*
- P. 684 col. 1. By mistake Florida is placed under the Spanish empire, and Canada under that of France; whereas they were both ceded to Britain by the late treaty of peace.
- GIRONNE. For *fig. 5.* read *fig. 4.*
- GORE. For *fig. 4.* read *fig. 5.*
- P. 729. col. 2. l. 28. For *as to language*, read *as essential to language.*
- P. 731. col. 2. l. penult. For *remain changed*, read *remain unchanged.*
- P. 735. col. 1. l. 43. For *to write*, read *to unite.*
- P. 742. col. 1. l. 26. For *was it not.* read *it was not.*
- GRYLLUS. For *fig. 3, 4, 5* read *fig. 4, 5, 6.*
- GULES. For *Plate CI. fig. 6* read *Plate XCVII. fig. 7.*
- P. 805. col. 2. l. 29. For *fig. 4* read *fig. 5.*
- INTERLOCUTOR. For *extacted*, read *extracted.*
- P. 863. col. 1. l. 40. For “*increase. However, the voice,*” &c. read “*increase; and the voice,*” &c.
- P. 864. col. 1. Instead of l. 17, 18, 19. read thus: “*But although it may be considered as a general rule,*”
- “*that the language of any nation is a very exact index of the state of their mind, yet it admits of some particular exceptions; for as man,*” &c.
- Ibid.* l. 9. *Delete the words in time.*
- Ibid.* col. 2. Instead of l. 11, 12. read thus:—“*little advantage from it, as the antiquity of a language does not necessarily imply any degree of excellence, seeing we all know that some nations,*” &c.
- P. 865. col. 2. l. 34. For *word*, read *words.*
- P. 866. col. 1. l. 6. For *one*, read *on*;—and in l. 24. *delete the word all.*
- Ibid.* col. 2. l. 22. For “*and the pluperfect in ISSEM*” “*and ERO,*” read “*the pluperfect in ISSEM, and the future in ERO.*”
- Ibid.* col. 1. and 2. Delete *Loqueo, Odio, Loque-bam, Odie-bam,* with the English words accompanying them;—and for *Faceo, Pona-bam, Obie-bam, Gaudie-bam, and Abstine-bam*, read *Facio, Pone-bam, Obi-bam, Gaude-bam, and Abstine-bam.*
- P. 868. For “*Tu, Tytere, lentis in umbra,*” &c. read “*Tu, Tityre, lentus in umbra,*” &c.
- Ibid.* col. 1. l. 28. For *contrast*, read *contrast*;—l. 37. for *posson*, read *passion*;—and delete the syllable *con* at the beginning of l. 45.
- P. 869. col. 2. l. 7. from the bottom. For *as they ought to have*, read *as they might have.*
- P. 870 col. 2. lines 22, 23, 24, 25, and 26. read thus: “*For all their nouns in UM of the second declension, in E of the third, and in U of the fourth, have each their nominative and accusative singular alike. Nor in the plural number is there any distinction between these two cases,*” &c.
- Ibid.* col. 2. l. 19. from the bottom. For *language*, read *languages.*
- P. 872. col. 1. l. 13. For *by accumulated*, read *by the accumulated*;—and l. 25. for *any grammatical errors*, read *any considerable grammatical errors.*
- P. 873. col. 1. l. 10. from the bottom: for *commutacion*, read *communication*;—col. 2. l. 5. for *more naturally adapted to the genius of the language*, read *more agreeable to the genius of the language in which Es wrote*;—and col. 2. l. 38. for *that*, read *their.*
- P. 874 col. 2. l. 23. For *languages far less capable*, read *languages, far less capable.*—*Ibid.* l. penult. for *quite*, read *too.*
- P. 875. col. 2. l. 24. For *into*, read *in.*

## E R R A T A.

- P. 875. col. 2. l. 31. For *new-moulded* should at this juncture partake, read *new-moulded at this juncture should partake*.
- P. 876. col. 1. l. 15. For *stanzas*, read *scenes*;—col. 2 l. 7. for *is it possible*, read, *is it as we imagine, possible*;—and l. 16. for *is it*, read *it is*.
- P. 877. col. 1. l. 10. Read *Malam Deshouliers*.
- P. 883. col. 2. l. 7. from the bottom, read thus: "Hence, as one statute may be explained or repealed "by another," &c.—and in l. 6. delete the words *or repealed*.
- P. 885. col. 1. l. 13. from the bottom. For *enexed*, read *annexed*.
- P. 887. col. 1. l. 11. from the bottom. For 1972, read 1672.
- P. 889. col. 1. l. 16. For *give*, read *given*.
- P. 890. col. 1. l. 43. For *confirmed*, read *conferred*.
- P. 895. col. 1. l. 31. For "of the tocher and the wife," &c. read, "of the tocher; and the wife," &c.
- P. 904. col. 2. l. 8, 9. For "ward-holding was in dubio," read "ward-holding was in dubio presumed"
- P. 905. col. 2. l. 32. For *commission*, read *commissioners*.
- P. 908. col. 1. l. 5. For *establish as the full right*, read *establishes the full right*.
- P. 909. col. 2. l. 8. For *again*, read *against*;—l. 9, 10. for *hypothec payment*, read *hypothec for payment*;—and in l. 41. for 1755, read 1756.
- P. 914. col. 1. l. 2. For *brought*, read *bought*;—l. 10. for *of general terms*, read *in general terms*;—and l. 11. for *in the servitude*, read *of the servitude*.
- P. 916. col. 2. l. 17. For p. 159, read p. 259.
- P. 920. col. 1. l. 18. Delete the word *be*;—and in col. 2. l. 6. from the bottom, for *of division*, read *or division*.
- P. 921. col. 2. l. 26. For *statem*, read *statim*;—and in l. 31. for *may exist*, read *may never exist*.
- P. 931. col. 2. l. 18. For *seisin has actually followed*, read *seisin has not actually followed*.
- P. 947. col. 2. l. 11. from the bottom. For *action*, read *actions*.
- P. 951. col. 2. l. 13. For *or law*, read *of law*.
- P. 953. col. 2. For *Tit. 26*, read *Tit. 33*;—and in l. 5. from the bottom, for *bin*, read *kin*.
- P. 958. col. 2. l. 12. from the bottom. For *forms of law*, read *forms of trial*.
- The page following 958 is numbered 949 instead of 959. In col. 2. l. 25. of said page, for *It is necessary*, read *It is not necessary*.
- LOGIC. Read lines 3d. 4th. and 5th. of the first paragraph thus: "Inasmuch as it traces the progress of our knowledge from our first and most simple conceptions through all their different combinations, and all those numerous deductions," &c.